

OMRON

Smart Sensor

Multi-Dimensional Sensor

ZG Series

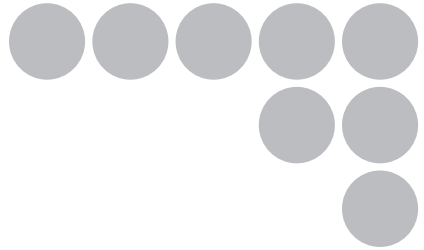

User's Manual



Cat. No. Z250-E1-01

Introduction

Thank you for purchasing the ZG series.

This manual provides information regarding functions, performance and operating methods that are required for using the ZG.

When using the ZG, be sure to observe the following:

- The ZG must be operated by personnel knowledgeable in electrical engineering.
- To ensure correct use, please read this manual thoroughly to deepen your understanding of the product.
- Please keep this manual in a safe place so that it can be referred to whenever necessary.

■ How to Switch the Display Language to English

Turn the power ON with the MENU key held down. This displays the display language selection screen.

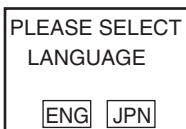

The Controller will start up with the messages displayed in English when it is next started up.

User's Manual

APPLICATION CONSIDERATIONS
(Please Read)

BEFORE USE

BASIC OPERATIONS

FUNCTION SETTINGS

CONNECTION WITH EXTERNAL DEVICE

APPENDICES

1

2

3

4

5

Smart Sensor

Multi-Dimensional Sensor
ZG Series

READ AND UNDERSTAND THIS DOCUMENT

Please read and understand this document before using the products. Please consult your OMRON representative if you have any questions or comments.

WARRANTY

OMRON's exclusive warranty is that the products are free from defects in materials and workmanship for a period of one year (or other period if specified) from date of sale by OMRON.

OMRON MAKES NO WARRANTY OR REPRESENTATION, EXPRESS OR IMPLIED, REGARDING NON-INFRINGEMENT, MERCHANTABILITY, OR FITNESS FOR PARTICULAR PURPOSE OF THE PRODUCTS. ANY BUYER OR USER ACKNOWLEDGES THAT THE BUYER OR USER ALONE HAS DETERMINED THAT THE PRODUCTS WILL SUITABLY MEET THE REQUIREMENTS OF THEIR INTENDED USE. OMRON DISCLAIMS ALL OTHER WARRANTIES, EXPRESS OR IMPLIED.

LIMITATIONS OF LIABILITY

OMRON SHALL NOT BE RESPONSIBLE FOR SPECIAL, INDIRECT, OR CONSEQUENTIAL DAMAGES, LOSS OF PROFITS OR COMMERCIAL LOSS IN ANY WAY CONNECTED WITH THE PRODUCTS, WHETHER SUCH CLAIM IS BASED ON CONTRACT, WARRANTY, NEGLIGENCE, OR STRICT LIABILITY.

In no event shall responsibility of OMRON for any act exceed the individual price of the product on which liability is asserted.

IN NO EVENT SHALL OMRON BE RESPONSIBLE FOR WARRANTY, REPAIR, OR OTHER CLAIMS REGARDING THE PRODUCTS UNLESS OMRON'S ANALYSIS CONFIRMS THAT THE PRODUCTS WERE PROPERLY HANDLED, STORED, INSTALLED, AND MAINTAINED AND NOT SUBJECT TO CONTAMINATION, ABUSE, MISUSE, OR INAPPROPRIATE MODIFICATION OR REPAIR.

SUITABILITY FOR USE

THE PRODUCTS CONTAINED IN THIS DOCUMENT ARE NOT SAFETY RATED. THEY ARE NOT DESIGNED OR RATED FOR ENSURING SAFETY OF PERSONS, AND SHOULD NOT BE RELIED UPON AS A SAFETY COMPONENT OR PROTECTIVE DEVICE FOR SUCH PURPOSES.

Please refer to separate catalogs for OMRON's safety rated products.

OMRON shall not be responsible for conformity with any standards, codes, or regulations that apply to the combination of products in the customer's application or use of the product.

At the customer's request, OMRON will provide applicable third party certification documents identifying ratings and limitations of use that apply to the products. This information by itself is not sufficient for a complete determination of the suitability of the products in combination with the end product, machine, system, or other application or use.

The following are some examples of applications for which particular attention must be given. This is not intended to be an exhaustive list of all possible uses of the products, nor is it intended to imply that the uses listed may be suitable for the products:

- Outdoor use, uses involving potential chemical contamination or electrical interference, or conditions or uses not described in this document.
- Nuclear energy control systems, combustion systems, railroad systems, aviation systems, medical equipment, amusement machines, vehicles, safety equipment, and installations subject to separate industry or government regulations.
- Systems, machines, and equipment that could present a risk to life or property.

Please know and observe all prohibitions of use applicable to the products.

NEVER USE THE PRODUCTS FOR AN APPLICATION INVOLVING SERIOUS RISK TO LIFE OR PROPERTY WITHOUT ENSURING THAT THE SYSTEM AS A WHOLE HAS BEEN DESIGNED TO ADDRESS THE RISKS, AND THAT THE OMRON PRODUCT IS PROPERLY RATED AND INSTALLED FOR THE INTENDED USE WITHIN THE OVERALL EQUIPMENT OR SYSTEM.

PERFORMANCE DATA

Performance data given in this document is provided as a guide for the user in determining suitability and does not constitute a warranty. It may represent the result of OMRON's test conditions, and the users must correlate it to actual application requirements. Actual performance is subject to the OMRON Warranty and Limitations of Liability.

CHANGE IN SPECIFICATIONS

Product specifications and accessories may be changed at any time based on improvements and other reasons.

It is our practice to change model numbers when published ratings or features are changed, or when significant construction changes are made. However, some specifications of the product may be changed without any notice. When in doubt, special model numbers may be assigned to fix or establish key specifications for your application on your request. Please consult with your OMRON representative at any time to confirm actual specifications of purchased products.

DIMENSIONS AND WEIGHTS

Dimensions and weights are nominal and are not to be used for manufacturing purposes, even when tolerances are shown.

ERRORS AND OMISSIONS

The information in this document has been carefully checked and is believed to be accurate; however, no responsibility is assumed for clerical, typographical, or proofreading errors, or omissions.

PROGRAMMABLE PRODUCTS

OMRON shall not be responsible for the user's programming of a programmable product, or any consequence thereof.

COPYRIGHT AND COPY PERMISSION

This document shall not be copied for sales or promotions without permission.

This document is protected by copyright and is intended solely for use in conjunction with the product. Please notify us before copying or reproducing this document in any manner, for any other purpose. If copying or transmitting this document to another, please copy or transmit it in its entirety.

Meanings of Signal Words

The following signal words are used in this manual.



Indicates a potentially hazardous situation which, if not avoided, will result in minor or moderate injury, or may result in serious injury or death. Additionally there may be significant property damage.

Meanings of Alert Symbols

The following alert symbols are used in this manual

	<p>Indicates general prohibitions for which there is no specific symbol.</p>
	<p>Indicates the possibility of laser radiation.</p>
	<p>Indicates prohibition when there is a risk of minor injury from electrical shock or other source if the product is disassembled.</p>



This product is not designed or rated for ensuring safety of persons.
Do not use it for such purposes.



Never look into the laser beam. Doing so continuously will result in
visual impairment.



Do not attempt to dismantle, pressurize, or incinerate the product. Doing
so may cause the laser beam to leak, resulting in the danger of visual
impairment.



Precautions for Safe Use

The following points are important to ensure safety, so make sure that they are strictly observed.

1. Installation Environment

- Do not use the product in environments where it can be exposed to inflammable/explosive gas.
- To secure the safety of operation and maintenance, do not install the product close to high-voltage devices and power devices.
- Install the product in such a way that its ventilation holes are not blocked.

2. Power Supply and Wiring

- The voltage and AC power supply must be within the rated range (DC 24 V \pm 10%).
- Reverse connection of the power supply is not allowed.
- Open-collector outputs should not be short-circuited.
- Use the power supply within the rated load.
- High-voltage lines and power lines must be wired separately from this product. Wiring them together or placing in the same duct may cause induction, resulting in malfunction or damage.
- Use the product within the power supply voltage specified by this manual.
- Use a DC power supply with safety measures against high-voltage spikes (safety extra low-voltage circuits on the secondary side).

3. Other

- Do not disassemble, repair, or modify the product.
- Dispose of this product as industrial waste.
- Connect the exclusive device (Sensor). The product might break down or malfunction if you use a part not included in the exclusive products.
- Should you notice any abnormalities, immediately stop use, turn OFF the power supply, and contact your OMRON representative.

Precautions for Correct Use

Observe the following precautions to prevent failure to operate, malfunctions, or undesirable effects on product performance.

1. Installation Site

Do not install this product in locations subjected to the following conditions:

- Ambient temperature outside the rating
- Rapid temperature fluctuations (causing condensation)
- Relative humidity outside the range of 35 to 85%
- Presence of corrosive or flammable gases
- Presence of dust, salt, or iron particles
- Direct vibration or shock
- Reflection of intense light (such as other laser beams or electric arc-welding machines)
- Direct sunlight or near heaters
- Water, oil, or chemical fumes or spray
- Strong magnetic or electric field

2. Power Supply and Wiring

- When using a commercially available switching regulator, make sure that the FG terminal is grounded.
- If surge currents are present in the power lines, connect surge absorbers that suit the operating environment.
- Before turning ON the power after the product is connected, make sure that the power supply voltage is correct, there are no incorrect connections (e.g. load short-circuit), and the load current is appropriate. Incorrect wiring may result in breakdown of the product.
- Before connecting/disconnecting devices, make sure that the Sensor/Controller is turned OFF. The Sensor or Controller may break down if it is connected/disconnected while the power is ON.
- Use the extension cable sold separately for extending the cable between the Sensor and the Controller.

 p.17

- Use only combinations of the Sensor and Controller specified in this manual.
- Before turning the Controller ON, connect the Sensor. If the Controller is turned ON without the Sensor connected, the Controller's screen will remain dark and messages cannot be read.

3.Warming Up

After turning the power supply ON, allow the product to stand for at least 30 minutes before use. The circuits are still unstable just after the power supply is turned ON, so measurement values may fluctuate gradually.

4.Maintenance and Inspection

Do not use thinner, benzene, acetone or kerosene to clean the Sensor and Controller. If large dust particles adhere to the filter on the front of the Sensor, use a blower brush (used to clean camera lenses) to blow them off. Do not use breath from your mouth to blow the dust off. To remove dust particles from the Sensor, wipe gently with a soft cloth (for cleaning lenses) moistened with a small amount of alcohol. Do not use excessive force to wipe off dust particles. Scratches to the filter might cause error.

5.Measurement Target

The measurement target is a non-transparent object. The sensor cannot detect the following types of objects accurately: materials with extremely small reflectances, objects smaller than the beam diameter, objects with large curvatures, or objects tilted to a large degree.

6.Effect of Peripheral Lighting

Do not install the Sensor in a place where strong light hits the laser emitter/receiver section of the Sensor.

Also, if a measurement target has a shiny surface, the light from the lighting will be reflected and a malfunction may occur. In such a case, prevent reflection by, for example, covering the light to stop reflection.

 p.21

Editor's Note

■ Meaning of Symbols

Menu items that are displayed on the Controller's LCD screen, and windows, dialog boxes and other GUI elements displayed on the PC are indicated enclosed by brackets "[]".

■ Visual Aids

Important

Indicates points that are important to achieve the full product performance, such as operational precautions.

Note

Indicates application procedures.



Indicates pages where related information can be found.

MEMO

CONTENTS

1. BEFORE USE

ZG Series	16
System Configuration	16
Part Names and Functions	18
Mounting and Connecting Devices	21
Mounting the Sensor	21
Mounting the Controller	30
Connecting Devices	33
Overview of Settings and Measurement	36
Operation Modes	36
Tasks and Bank Data	38
Setup Modes	40
Initializing Controller Settings	41

2. BASIC OPERATIONS

Setting Measurement Conditions - FUN Mode	44
Checking/Adjusting the Measurement Status	
- ADJ Mode	49
Checking Measurement Status	49
Setting the Judgment Value	51
Adjusting the Output Conditions of the Measurement Result ..	52
Setting Processing during Non-measurement	53
Functions/Operations Used during Operation	
- RUN Mode	54
Monitoring the Measurement Status	54
Executing Reference Zero Reset	56
Magnifying the Profile Display	57

3.FUNCTION SETTINGS



Measurement Settings	60
Setting Measurement Items	60
Customizing Measurement Conditions	66
Setting Scaling (Correction Processing)	71
Image Adjustment	74
Position Correction	82



Bank Settings	85
Bank Switching (change of device setup)	85
Copying Bank Data	85
Clearing Bank Data	86



I/O Settings	87
Setting Analog Output Conditions	87
Setting Conditions When a Parallel Output Unit is Used ..	92
Setting I/O Conditions	93
Setting Serial Output Conditions	95



System Settings	97
Setting the Sensor Installation Status	97
Setting the CCD Mode	97
Setting the RS-232C Communication Specifications	98
Setting the Node No.	98
Setting the Sensor Data Loading Method	99
Setting the Number of Digits Past the Decimal Point	99
Setting/Changing the ECO Display	100
Displaying the Controller Information	100
Setting/Changing the Display Language	100
Setting the Icon Color	101
Saving the Setup Data	101

4.CONNECTION WITH EXTERNAL DEVICE

Output Data List	104
Communication Using I/O Signals	105
Using the Controller I/O Cable	105
Using the Parallel Output Unit (sold separately)	110
I/O Timing Charts	114
Serial Communication	118
Using the Serial Interface	118
Connecting Peripheral and External Devices	121
About Communication Commands	124
Bank Control Commands	127
Measurement Control/Measurement Value Acquisition Commands	129
Setting Acquisition/Change Commands	132
Backup/Restore Commands	134
Utility Commands	138
Parameter List	141
Command Processing Time	146

5.APPENDICES

Basic Knowledge for Operation	148
CCD Mode	148
Sensitivity Adjustment and Measurement Operations ...	150
Specifications and External Dimensions	153
Sensor	153
Controller	161
Accessories	164
Error Messages and Corrective Actions	171
Menu List	172
List of Key Operations	174
Laser Safety	175
Requirements from Regulations and Standards ..	176
Summary of Requirements to Manufactures	176
Summary of Requirements to User	180
Definitions of Laser Classification	183

Updating the Firmware	185
INDEX	191
Revision History	196

BEFORE USE

ZG Series	16
Mounting and Connecting Devices	21
Overview of Settings and Measurement	36

ZG Series

Measurement by the ZG series can be started immediately merely by connecting the model of Sensor suited to the application to the Controller. Also, the ZG series can support various measurement applications by using it in combination with peripheral devices.

System Configuration

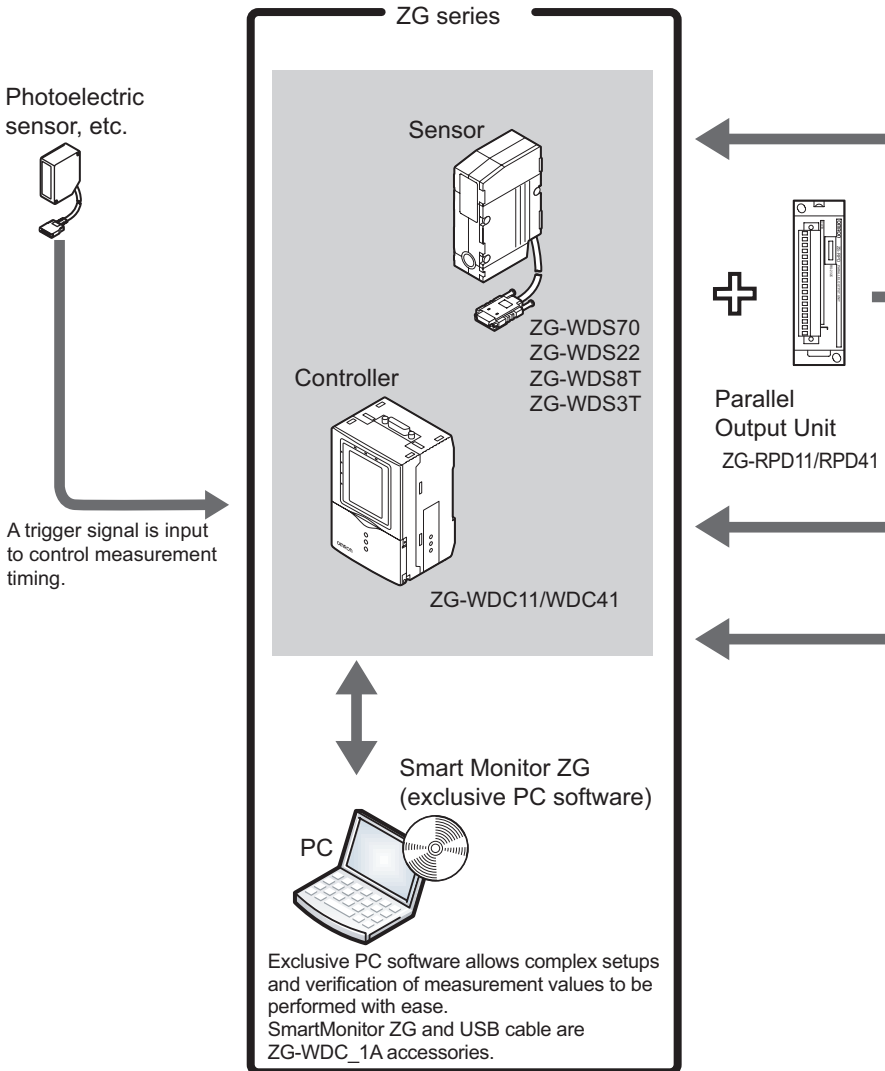

A USB connection allows measurement data to be captured easily on a PC. Also, the Controller can be controlled from a PC (e.g. switching/changing of setup data and input of measurement trigger).



Measurement values and judgment results can be output at high speed on the parallel interface.

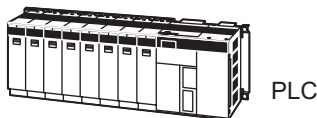

Measurement values and judgment results can be acquired, and the controller can be controlled (e.g. setup data can be switched/changed and measurement triggers can be input).

• RS-232C connector cable (option)

Exclusive cables are available to match the connected device.

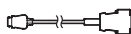

For PC: ZS-XRS2
For PLC/PT: ZS-XTPT2

The analog signals of measurement values can be displayed as a waveform, and judgment results can be displayed in color.

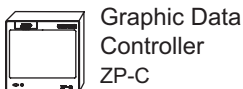

• Sensor-Controller extension cable (option)

Exclusive extension cables and digital equalizer (repeater) are available for extending the installation distance between the Sensor and the Controller.

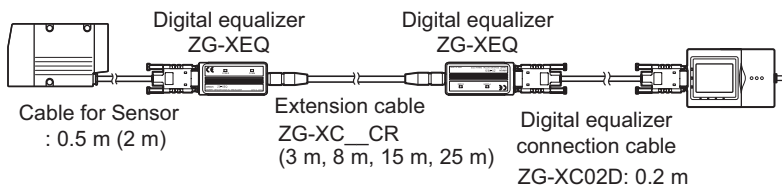

Part Names and Functions

Sensor

ZG-WDS70

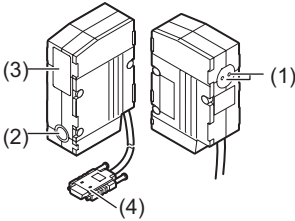

ZG-WDS8T/WDS22

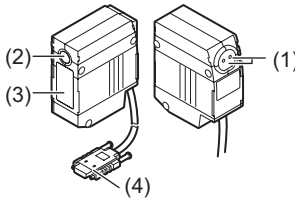

ZG-WDS3T

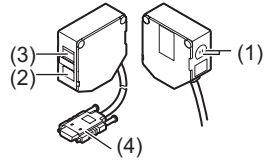

Name	Function														
(1) Laser indicator	<p>These are laser beam warning indicators. The “standby indicator (STANDBY)” indicates that the laser beam is ready for emission, and the “laser energized indicator (LD ON)” indicates that the laser is energized.</p> <p>Both indicators are OFF until Controller startup is completed after the power is turned ON.</p> <div style="text-align: center;"> <p>LASER STANDBY LD ON</p> </div> <table border="1" style="width: 100%; border-collapse: collapse;"> <thead> <tr> <th rowspan="2">Indicator</th> <th rowspan="2">At startup</th> <th colspan="2">RUN/ADJ/FUN mode</th> </tr> <tr> <th>LD OFF in progress</th> <th>LD ON in progress</th> </tr> </thead> <tbody> <tr> <td>Standby indicator (STANDBY)</td> <td>OFF</td> <td>ON</td> <td>ON</td> </tr> <tr> <td>Laser indicator (LD ON)</td> <td>OFF</td> <td>OFF</td> <td>ON</td> </tr> </tbody> </table>	Indicator	At startup	RUN/ADJ/FUN mode		LD OFF in progress	LD ON in progress	Standby indicator (STANDBY)	OFF	ON	ON	Laser indicator (LD ON)	OFF	OFF	ON
Indicator	At startup			RUN/ADJ/FUN mode											
		LD OFF in progress	LD ON in progress												
Standby indicator (STANDBY)	OFF	ON	ON												
Laser indicator (LD ON)	OFF	OFF	ON												
(2) Laser emitter	This emits the laser for measurement.														
(3) Laser receiver	This receives the laser light reflected from the measurement target.														
(4) Connector	This is the connector for connecting to the Controller.														

Controller

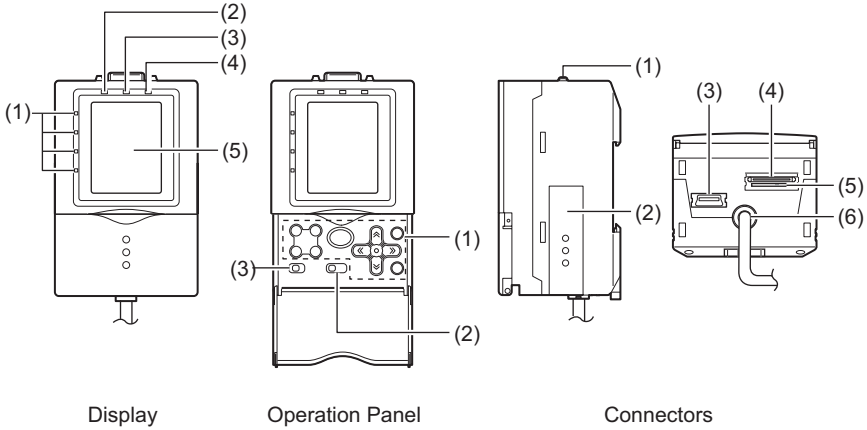

Display

Operation Panel

Connectors

Display

Name	Function
(1) Judgment indicator	The indicator turns ON when the result of task judgment is OK, and turns OFF when a setting is not made, measurement is OFF, the result of a judgment is NG, or an error occurs.
(2) Laser indicator	The laser indicator turns ON while the Sensor is emitting a laser beam.
(3) Zero Reset indicator	The Zero Reset indicator turns ON when the zero reset function is enabled.
(4) Trigger indicator	The Trigger indicator turns ON when a trigger signal is input.
(5) LCD monitor	The LCD monitor displays setup menus and images captured from the Sensor.

Operation Panel



Name	Function
(1) Control keys	<p>These keys are used for setting measurement conditions or switching the display.</p> <p> List of Key Operations p.174</p>
(2) Mode switch	<p>This switch selects the operation mode.</p> <p>FUN : Select this mode when setting measurement conditions.</p> <p>ADJ : Select this mode when adjusting the judgment threshold value.</p> <p>RUN : Select this mode when performing measurement. Measurement results and judgment results are output only when the RUN mode is currently selected.</p>
(3) Menu switch	<p>This switch selects the setup menu.</p> <p>STD : Standard menu. Select this when setting the minimum required items for measurement.</p> <p>EXP : Expert menu. Select this item when making a more detailed setup.</p>

Connectors

Name	Function
(1) Sensor connector	This connector connects the Sensor.
(2) Function extension connector	Not used. Leave the cover (supplied) attached to this connector.
(3) USB port	Connect the USB cable (MINI-B) to the USB port to connect to a personal computer.
(4) RS-232C connector	<p>Connect the RS-232C cable (exclusive product) when you are connecting the Controller to a PLC, programmable terminal or personal computer.</p> <p> RS-232C cable p.17</p>
(5) Voltage/Current switch	<p>This switch is for selecting voltage output or current output as the analog output. (default value: voltage output)</p> <p>Important</p> <p>Before operating this switch, make sure that the Controller is turned OFF.</p>
(6) I/O cable	The I/O cable connects the Controller to the power supply and external devices, such as timing sensors or programmable controllers.

Mounting and Connecting Devices

Mounting the Sensor

⚠ WARNING	
Never look into the laser beam. Doing so continuously will result in visual impairment.	
Do not attempt to dismantle, pressurize, or incinerate the product. Doing so may cause the laser beam to leak, resulting in the danger of visual impairment.	

Installations to Suit Measurement Target and Environment

Pay attention to the following points when mounting the Sensor to prevent measurement precision from dropping.

Color/shiny surface boundary

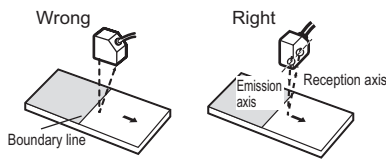

Mounting near walls

Measurement errors can be reduced by installing the Sensor with the line formed by the emission and reception axes parallel to the wall, and painting the wall with non-reflective black paint.

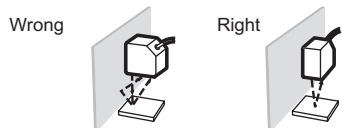

Narrow grooves or indentations



Rotating objects

You can minimize the influence caused by vibration of the rotating object and positional shifts by installing the Sensor with the line formed by the emission and reception axes parallel to the axis of rotation.

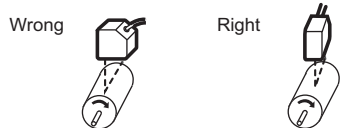

Measuring stepped objects

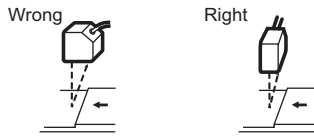

Effect of peripheral lighting

Do not install the Sensor in a place where strong light hits the laser emitter/receiver section of the Sensor. Also, if a measurement target has a shiny surface, the light from the lighting will be reflected and a malfunction may occur. In such as case, prevent reflection, for example, covering the light to stop reflection.

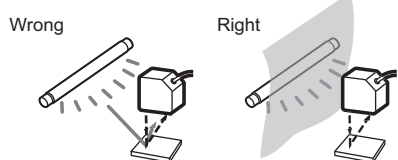

Mounting the ZG-WDS70

Fix by mounting screws making sure that the distance between the Sensor and measurement target is matched.

Mounting method

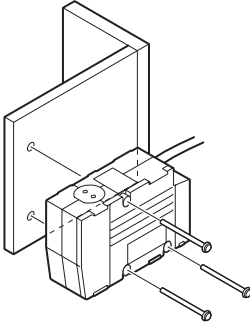

Fasten the Sensor onto the mounting base with M4 screws.

Tightening torque: 1.2 N•m

Important

For details on the positions of screw holes, check the external dimensions in “Chapter 5 APPENDICES.”

 External dimensions p.155

Mounting position

Mount the Sensor according to the following distances and angle.

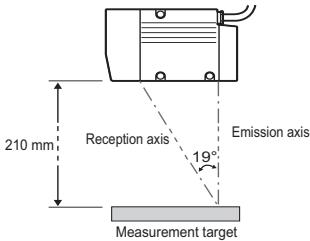

Mounting for diffuse reflection measurement

Measurement range

< Mounting for diffuse reflection measurement >

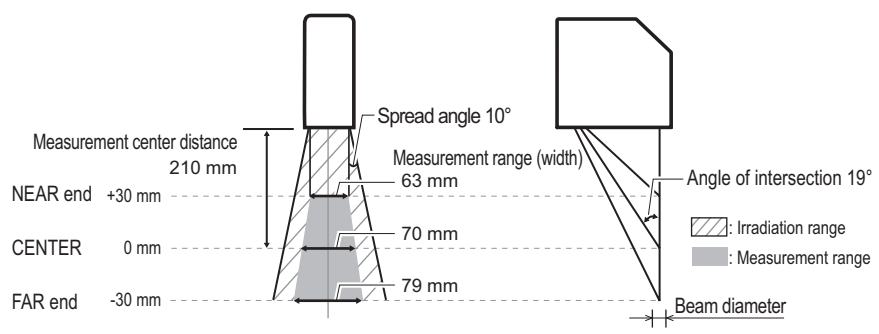

Measurement center distance	Measurement range (height)	Measurement range (width)	Beam diameter
210 mm	±30 mm	NEAR end: 63 mm	300 μm
		CENTER: 70 mm	120 μm
		FAR end: 79 mm	300 μm

Important

The beam diameter and measurement range (width) between the NEAR/FAR ends are nominal values, and are not to be used as guaranteed values.

Mounting the ZG-WDS22

Fix by mounting screws making sure that the distance between the Sensor and measurement target is matched.

Mounting method

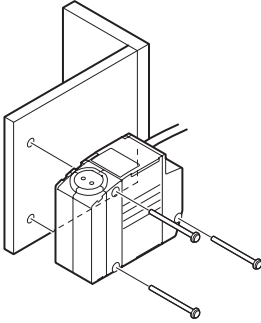

Fasten the Sensor onto the mounting base with M4 screws.

Tightening torque: 1.2 N•m

Important

For details on the positions of screw holes, check the external dimensions in “Chapter 5 APPENDICES.”

 External dimensions p.156

Mounting position

Mount the Sensor according to the following distances and angle.

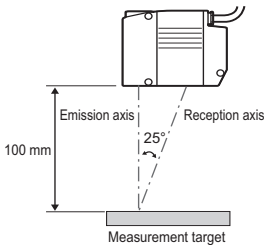

Mounting for diffuse reflection measurement

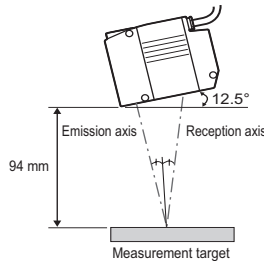

Mounting for regular reflection measurement

Note

The default mounting state of the Sensor is for diffuse reflection measurement. To set the Sensor for regular reflection measurement, change the Sensor mounting setting.

 Setting the Sensor Installation Status p.97

Measurement range

< Mounting for diffuse reflection measurement >

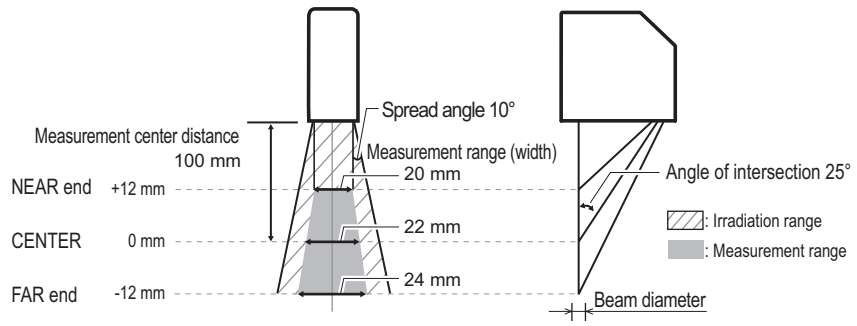

Measurement center distance	Measurement range (height)	Measurement range (width)	Beam diameter
100 mm	±12 mm	NEAR end: 20 mm	220 μm
		CENTER: 22 mm	60 μm
		FAR end: 24 mm	220 μm

< Mounting for regular reflection measurement >

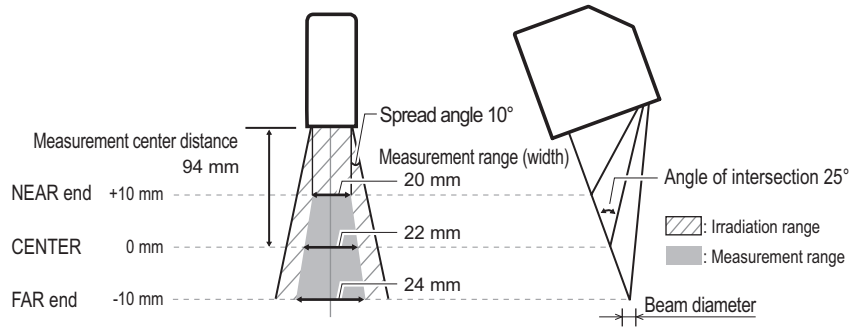

Measurement center distance	Measurement range (height)	Measurement range (width)	Beam diameter
94 mm	±10 mm	NEAR end: 20 mm	220 μm
		CENTER: 22 mm	60 μm
		FAR end: 24 mm	220 μm

Important

The beam diameter and measurement range (width) between the NEAR/FAR ends are nominal values, and are not to be used as guaranteed values.

Mounting the ZG-WDS8T

Fix by mounting screws making sure that the distance between the Sensor and measurement target is matched.

Mounting method

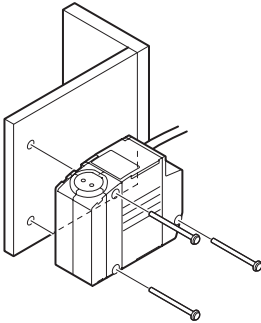

Fasten the Sensor onto the mounting base with M4 screws.

Tightening torque: 1.2 N•m

Important

For details on the positions of screw holes, check the external dimensions in “Chapter 5 APPENDICES.”

 External dimensions p.156

Mounting position

Mount the Sensor according to the following distances and angle.

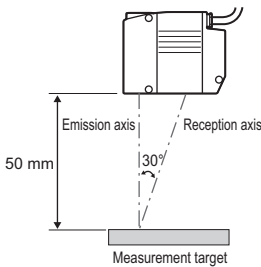

Mounting for diffuse reflection measurement

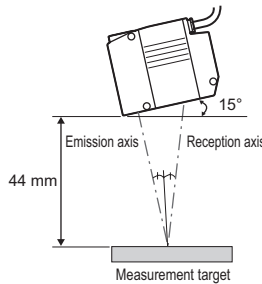

Mounting for regular reflection measurement

Note

The default mounting state of the Sensor is for diffuse reflection measurement. To set the Sensor for regular reflection measurement, change the Sensor mounting setting.

 Setting the Sensor Installation Status p.97

Measurement range

< Mounting for diffuse reflection measurement >

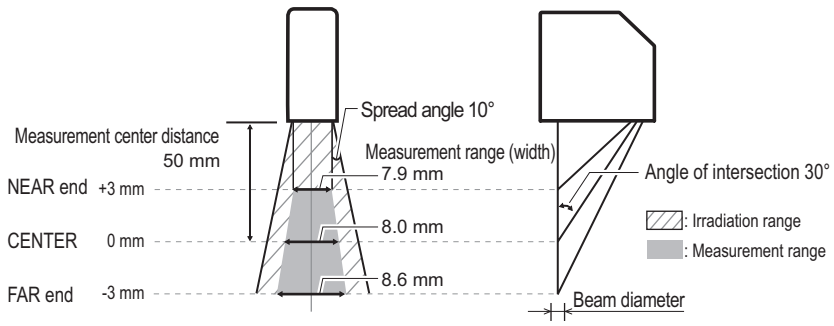

Measurement center distance	Measurement range (height)	Measurement range (width)	Beam diameter
50 mm	±3 mm	NEAR end: 7.9 mm	120 μm
		CENTER: 8.0 mm	30 μm
		FAR end: 8.6 mm	120 μm

< Mounting for regular reflection measurement >

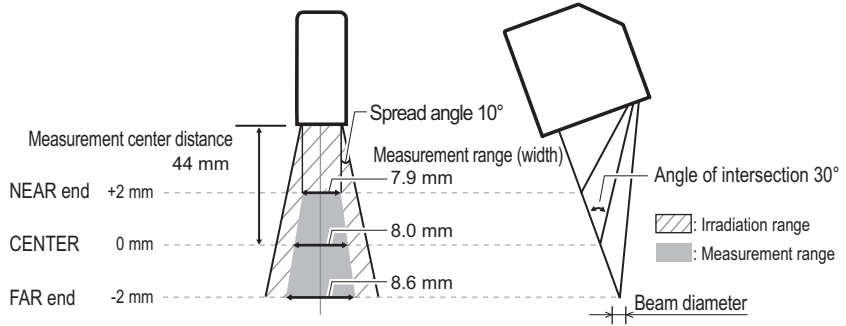

Measurement center distance	Measurement range (height)	Measurement range (width)	Beam diameter
44 mm	±2 mm	NEAR end: 7.9 mm	120 μm
		CENTER: 8.0 mm	30 μm
		FAR end: 8.6 mm	120 μm

Important

The beam diameter and measurement range (width) between the NEAR/FAR ends are nominal values, and are not to be used as guaranteed values.

Mounting the ZG-WDS3T

Fix by mounting screws making sure that the distance between the Sensor and measurement target is matched.

Mounting method

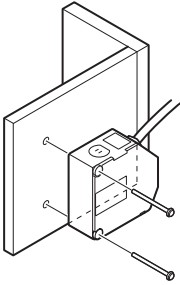

Fasten the Sensor onto the mounting base with M4 screws.

Tightening torque: 1.2 N•m

Important

For details on the positions of screw holes, check the external dimensions in “Chapter 5 APPENDICES.”

 External dimensions p.158

Mounting position

Mount the Sensor according to the following distances and angle.

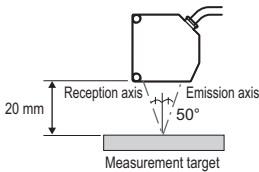

Mounting for regular reflection measurement

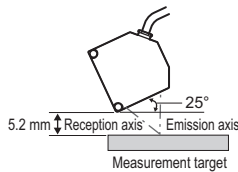

Mounting for diffuse reflection measurement

Note

The default mounting state of the Sensor is for diffuse reflection measurement. To set the Sensor for diffuse reflection measurement, change the Sensor mounting setting.

 Setting the Sensor Installation Status p.97

Measurement range

< Mounting for regular reflection measurement >

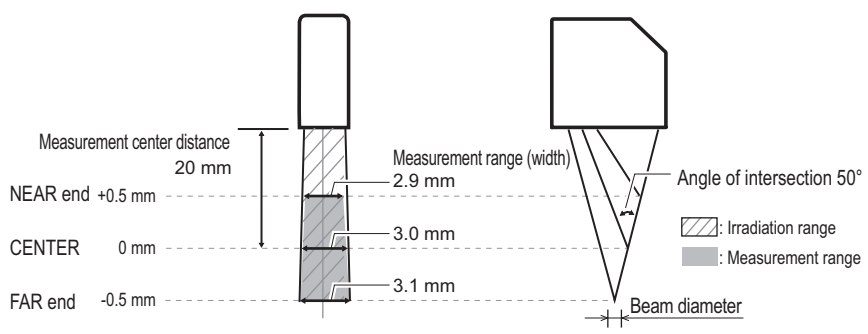

Measurement center distance	Measurement range (height)	Measurement range (width)	Beam diameter
20 mm	±0.5 mm	NEAR end: 2.9 mm	40 μm
		CENTER: 3.0 mm	25 μm
		FAR end: 3.1 mm	40 μm

< Mounting for diffuse reflection measurement >

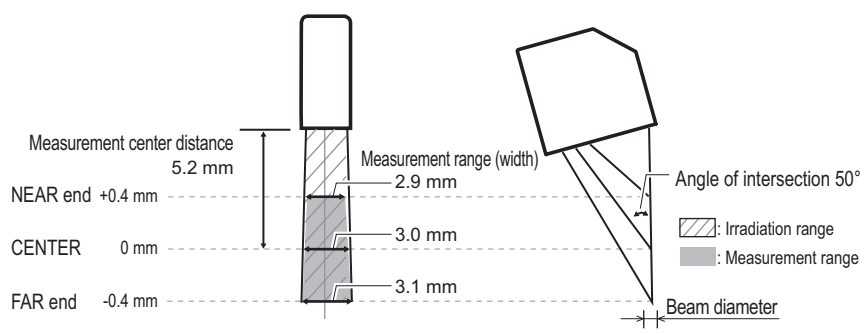

Measurement center distance	Measurement range (height)	Measurement range (width)	Beam diameter
5.2 mm	±0.4 mm	NEAR end: 2.9 mm	40 μm
		CENTER: 3.0 mm	25 μm
		FAR end: 3.1 mm	40 μm

Important

The beam diameter and measurement range (width) between the NEAR/FAR ends are nominal values, and are not to be used as guaranteed values.

Mounting the Controller

Cautions Regarding the Mounting Orientation

To improve heat radiation, install the Controller only in the orientation shown below.

Right

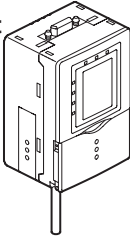

Do not install the Controller in the following orientations:

Wrong

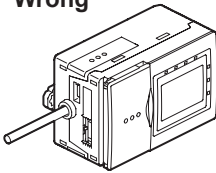

Wrong

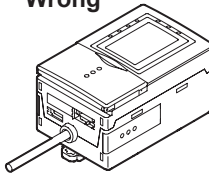

Important

- Do not block the ventilation holes at the top and bottom of the Controller body. Doing so will cause heat to build inside and result in a malfunction.
- When the temperature inside the control panel exceeds the ambient temperature of 50°C, provide forced-air cooling or more space at surrounding areas, or improve air circulation to lower the ambient temperature to 50°C or less.

Mounting on a DIN Track

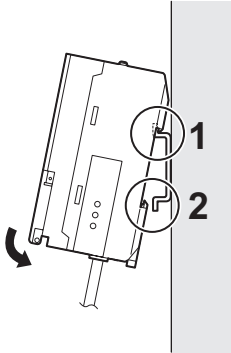

- 1** Hook the connector end of the Controller onto the DIN track.
- 2** Push the Controller down onto the DIN track until the hook on the I/O cable side is locked.

Important

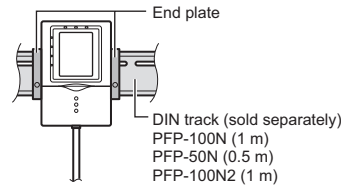

After mounting the Controller on the DIN track, attach the end plates on both sides of the Controller.

Removing the Controller from the DIN track

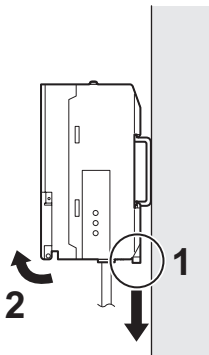

- 1** Pull the hook on the I/O cable end of the Controller downwards.
- 2** Lift up the Controller from the I/O cable end, and remove it from the DIN track.

Mounting on a Panel

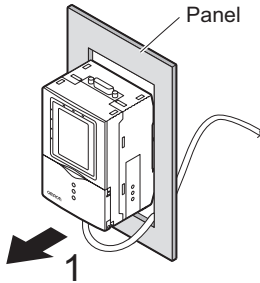

- 1** Push out the Controller from the rear of the panel towards the front.

 When mounting on a panel p.164

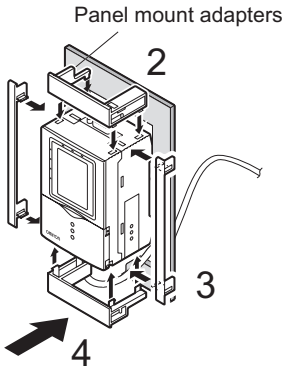

- 2** Install the short Panel Mount Adapters on the four holes on the Controller.
- 3** Install the long Panel Mount Adapters on the two holes on the Controller.
- 4** Install the Controller with Mount Adapters attached onto the panel from the front.

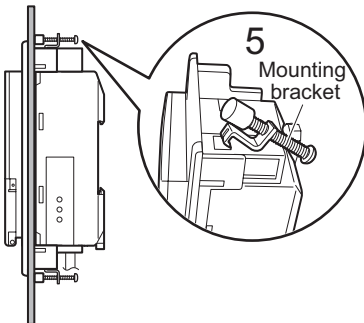

- 5** Hook the hooks of the mounting fixture onto the two holes of the short Mount Adapters and tighten the screws.
- 6** Make sure that the Controller is firmly fixed on the panel.

Important

When mounting multiple Controllers on a panel, be sure to install the DIN track on the rear side of the Controllers for support. (Note, however, that the Controllers cannot be gang-mounted.)

Connecting Devices

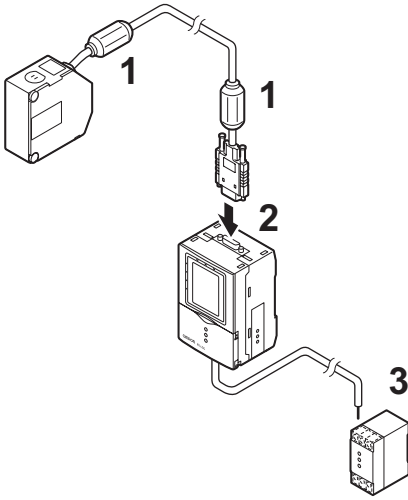

Important

Before connecting/disconnecting the Sensor, make sure that the Controller is turned OFF. The Controller may break down if the Sensor is connected or disconnected while the power is ON.

- 1 Attach the ferrite cores (supplied) to both ends of the Sensor cable.**
- 2 Insert the Sensor connector into the Controller until it locks in place.**
- 3 Connect the Controller's I/O cable and power supply.**

Important

If the Controller is turned ON without the Sensor connected, the Controller's screen will remain dark and messages cannot be read. Before turning the Controller ON, connect the Sensor.

Attaching the Ferrite Cores

Attach the ferrite cores (supplied) to both ends of the Sensor cable and to the Controller's I/O cable.

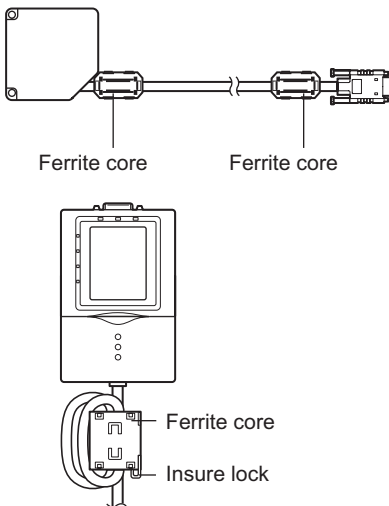

Important

When attaching the ferrite core to the Controller's I/O cable, pass the I/O cable twice through the ferrite core.

Connecting Cables

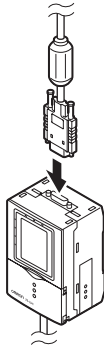

1 Insert the Sensor's connector straight into the Sensor connector on the Controller.

Make sure that you hear the connector snap firmly into place when it is connected.

2 Fasten firmly with the fastening screws (two screws, one each on the left and right).

Tightening torque: 0.15 N•m

Important

- Do not touch the terminals inside the connector.
- All settings on the Controller will be cleared if the Sensor is replaced with a different type.
- Fasten the connector while making sure that it is not subjected to vibration or shock.
- Do not mount the Controller in such a way that a load is steadily applied on the connector, for example, with tension applied to the cables.

< Removing the cable >

Loosen the fastening screws (two locations) to unlock the cable, and then draw out the connector straight from the Sensor side.

Note

To extend the connection between the Sensor and the Controller

The cable connection between the Sensor and the Controller can be extended by using the extension cable (sold separately), Digital equalizer and Digital equalizer connection cable. Attach the ferrite cores (supplied) to both ends of the extension cable and Digital equalizer connection cable.

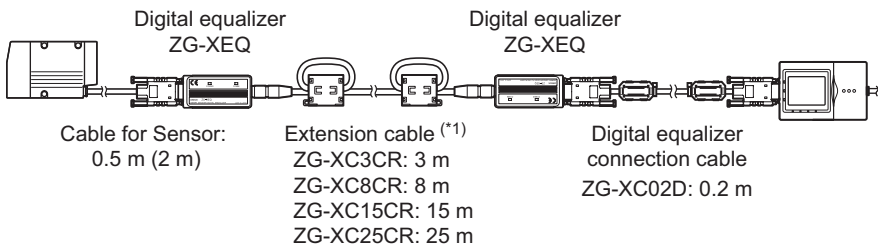

(*1) When attaching the ferrite core to both ends of the extension cable, pass the cable once through the ferrite core.

Connecting the Power Supply

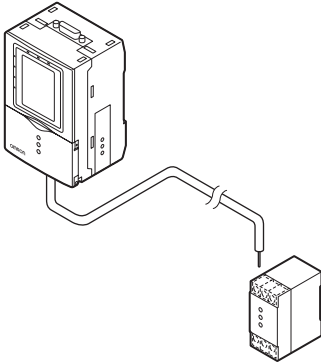

- 1** Connect the power wire (brown) and GND wire (blue) of the Controller's I/O cable to the DC24V ($\pm 10\%$) power supply.

Note

The following power supply is recommended:

- S8VS-03024 (DC 24 V, 1.3 A)

Be sure to connect the Controller to the power supply in a 1:1 connection.

Important

After turning the power supply ON, allow the product to stand for at least 30 minutes before use. The circuits are still unstable just after the power supply is turned ON, so measurement values may fluctuate gradually.

Overview of Settings and Measurement

Operation Modes

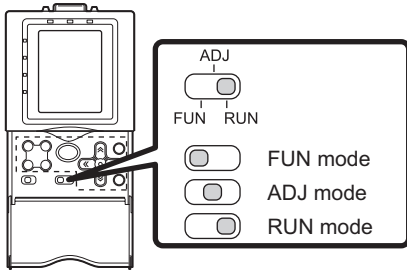

The ZG-WDC__ has the following three operation modes. Switch to the desired mode before you start operation.

To switch the operation mode, use the mode switch.

Mode	Description	
FUN mode	This mode is for setting the measurement conditions. The easy-to-follow icon-based display allows operations to be performed intuitively.	<p>Top Screen</p> <p>The screenshot shows a screen with the word 'FUN' at the top and 'MEAS' at the bottom. In the center, there are four circular icons: a home icon, a menu icon, a gear icon, and a signal icon.</p>
ADJ mode	This mode is for checking the measurement state, and setting threshold values and output conditions.	<p>Top Screen</p> <p>The screenshot shows a screen with 'HEIGHT1' and 'BIT1' at the top. Below is a graph showing a step-like measurement profile. At the bottom, the values '109.05210mm' and 'LV: 1-320' are displayed.</p>
RUN mode	This mode is used for performing actual measurement. The measurement information is displayed on the LCD screen.	<p>Top Screen</p> <p>The screenshot shows a screen with 'HEIGHT1' and 'BIT1' at the top. Below is a graph showing a step-like measurement profile. At the bottom, the values '109.05210mm' and 'LV: 1-320' are displayed.</p>

Profile Screen

A cross-section shape of the measurement object displayed on screen is called a "profile." Profiles are displayed on screen as a yellow line.

In the RUN/ADJ modes, the measurement state can be visually checked by these profiles. Also, in the FUN mode, profiles can be used to set the measurement conditions. Height measurement items are already set as the default, so it is possible to know immediately the detection status of the Sensor by setting the operation mode to the RUN mode.

On the ZG series, measurement points in the height and width directions are measured on the vertical (Z-axis) and horizontal (X-axis) axes, respectively. Measurement values are displayed as numerical values prefixed with a + (plus) or - (minus) sign depending on the coordinate position.

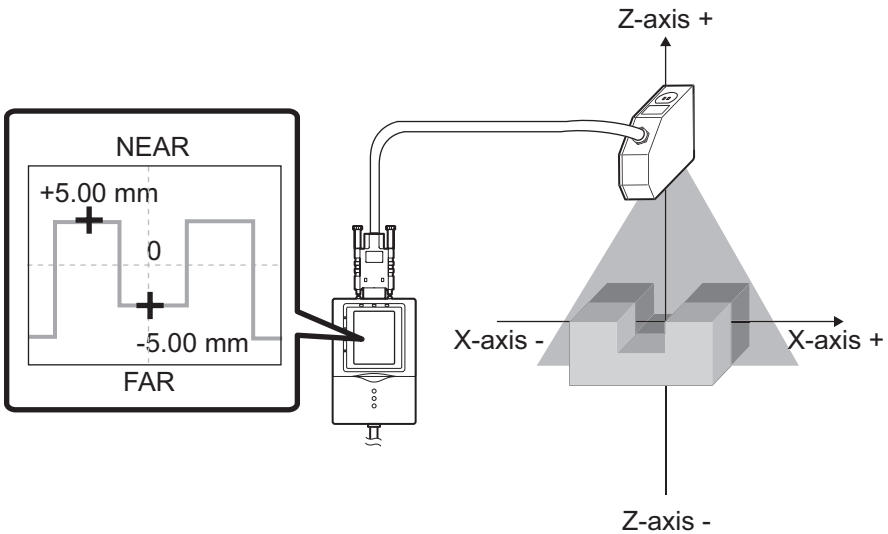

Tasks and Bank Data

Multi-task Measurement

On the ZG series, up to four measurements for a single profile can be processed simultaneously. This function is called “multi-task measurement.”

Example:

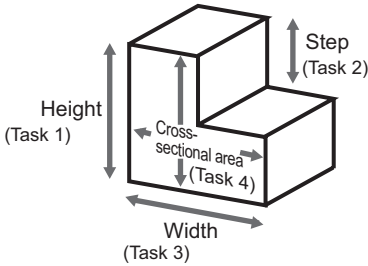

Measurement is performed with “height,” “width,” “step” and “cross-sectional area” set to tasks 1 to 4, respectively. In other words, this means that the total of tasks 1 to 4 allow you to judge the shape.

Data for Change of Device Setup

If you register bank data for each individual model, you can reduce the time required for changing the device setup as all you need to do is to select different bank data to change the measurement conditions.

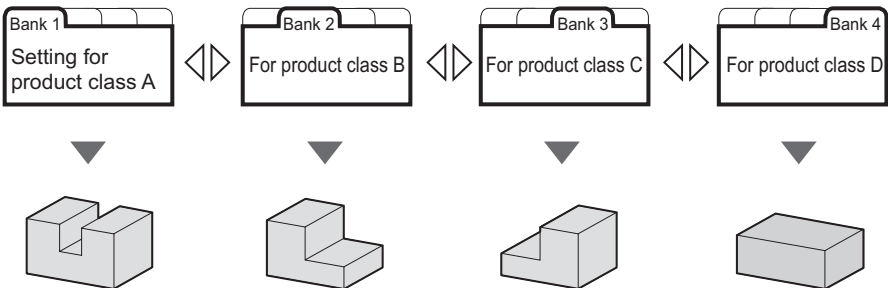

Relationship between Tasks and Bank Data

You can register up to four tasks to a single set of bank data. Up to four sets of bank data can be set and saved on the ZG series, so you can prepare up to 16 measurement patterns by combining bank data with task settings. Combinations of bank data and tasks become the measurement and judgment condition settings.

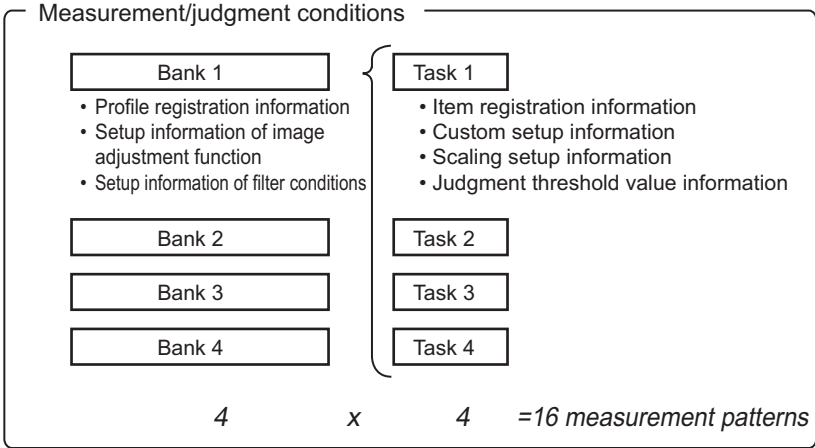

Setup Modes

STD Mode and EXP Mode

The Controller has two setup modes, the “STD mode” and the “EXP mode.” The features of each of these modes are as follows.

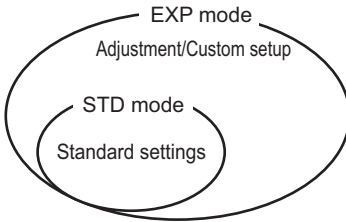

< STD mode >

This mode is designed for ease of operation, so its setting and adjustment ranges are limited. Setting in this mode comprises only three steps, so you can start measurement immediately.

< EXP mode >

This mode allows you to set all adjustment functions. You can use this mode to execute advanced measurement processing, such as measurement of image angle, calculation of processing items and selection of characteristic points.

Switching the mode

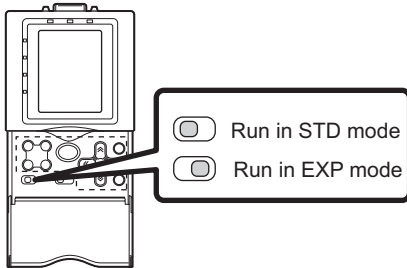

The STD and EXP modes are switched by the “mode switch” on the front of the controller. Two modes cannot be selected simultaneously during menu operation as the mode is fixed by the mode switch.

Initializing Controller Settings

Important

The settings of all banks and system settings are initialized regardless of the currently selected bank No. To save the settings, back them up to a personal computer before performing initialization.

-  • Receive System Data < SYSSAVE command > p.137
- Receive Bank Data < BANKSAVE command > p.135

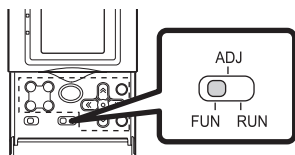

- 1** Switch to the **FUN** mode.
The top screen is displayed.

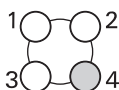

- 2** Select **[System]**.

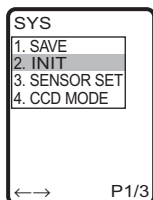
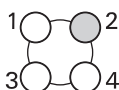

- 3** Select **[INIT]**.

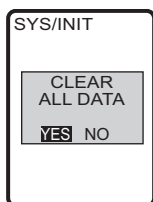
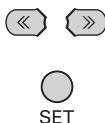

- 4** Move to **[YES]** and press the **SET** key.

BASIC OPERATIONS

Setting Measurement Conditions - FUN Mode	44
Checking/Adjusting the Measurement Status - ADJ Mode	49
Functions/Operations Used during Operation - RUN Mode	54

Setting Measurement Conditions - FUN Mode

The following describes the flow of basic setup using, as an example, “2-pt step”.

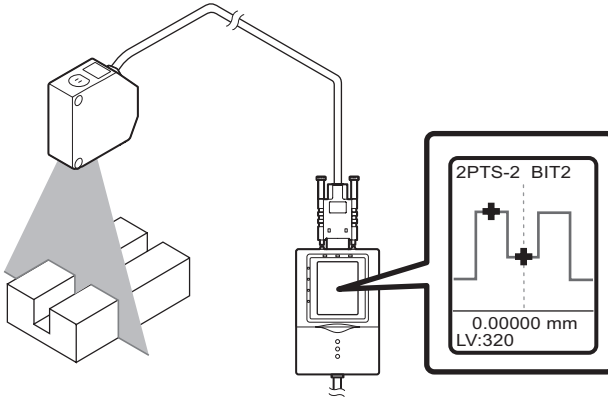

step 1 Registering profiles

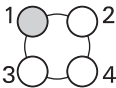
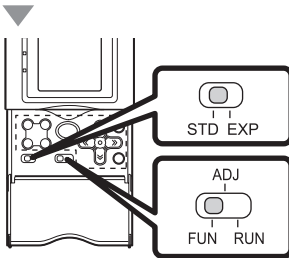

1 Switch to the STD mode.

2 Switch to the FUN mode.

The top screen of the FUN mode is displayed.

3 Select [MEAS].

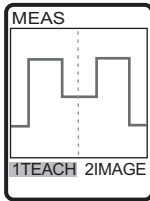
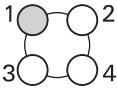

4 Select [TEACH].

Before executing teaching, set the measurement target in place.

Note

If the profile is not displayed correctly, adjust by [IMAGE].

p.74

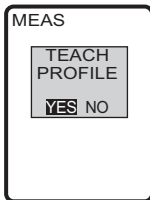
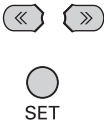

5 Move to [YES] and press the SET key.

This registers the profile. Registered profiles are saved until either teaching is executed again or the Smart Sensor is turned OFF.

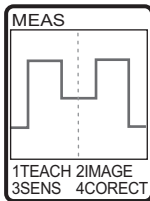

Note **Sensor mounting conditions**

If necessary, change the Sensor mounting orientation (for diffuse reflection measurement or for regular reflection measurement), or change the receiving status of the Sensor CCD before setting the measurement conditions.

Setting the Sensor Installation Status p.97
Setting the CCD Mode p.97

step 2 Selecting measurement items

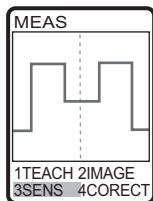
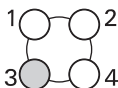

1 Select [SENS].

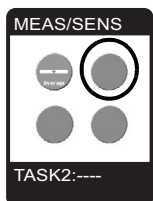
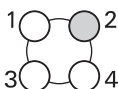

2 Select [TASK2].

Important

The default setting for [TASK1] is [HEIGHT1]. To set a measurement item other than [HEIGHT1] to [TASK1], change the measurement item to the desired item.

 Setting Measurement Items p.60

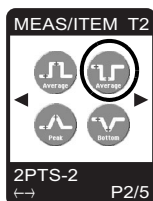
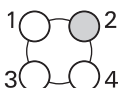

3 Select [2PTS-2] from the measurement items.

Scroll pages by the ←LEFT/→RIGHT key, and select the measurement item.

Note To measure multiple items

Simultaneous measurement of up to four items can be performed. To do this, repeat steps 2 and 3.

step 3 Setting regions

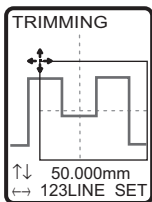
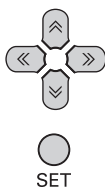

1 Adjust the top left of the desired measurement area, and press the SET key.

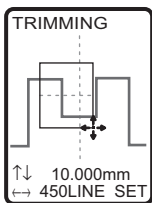
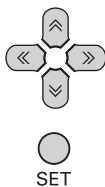

2 Adjust the bottom right of the desired measurement area, and press the SET key.

Important

Adjust the region so that the center line overlaps the area that divides the top and bottom of the step.

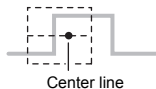

When the desired measurement area is enclosed, the region in which measurement points are extracted is automatically set.

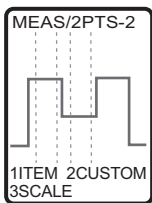

Note

If the target region is not displayed by automatic setting, select [CUSTOM], and adjust the region for each individual measurement point.

step 4 Checking and making adjustments (ADJ)

Check whether or not measurement can be performed correctly by the preset measurement conditions.

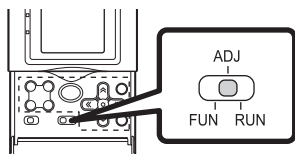

1 Switch to the ADJ mode.

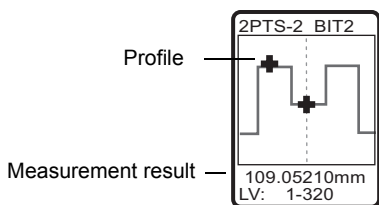

The profile is continuously measured, and the current profile is displayed in the Through mode. Check that measurement is being performed correctly.

Note

To switch the task display, use the ↑UP key/↓DOWN key.

Important

When the RUN mode is switched to, you will be prompted to save the settings. Save the setting data before turning the Smart Sensor OFF. The setting data will be cleared if you turn the power OFF without saving it.

Checking Measurement Status

Display the profile on the LCD screen while performing continuous measurement.

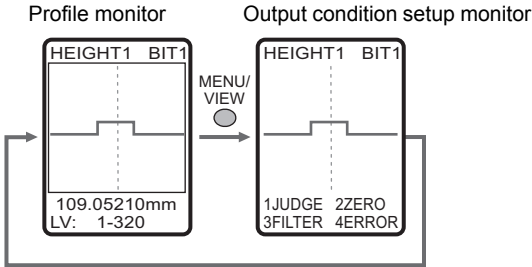

Profile monitor

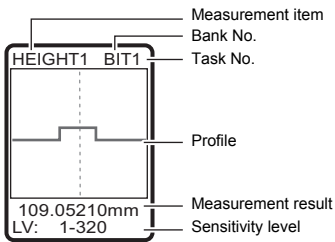

The current profile is displayed in the Through mode. When multiple tasks are registered, switch the profile and display it for each individual task.

Note

To switch the task display, use the ↑UP key/ ↓DOWN key.

Output condition setup monitor

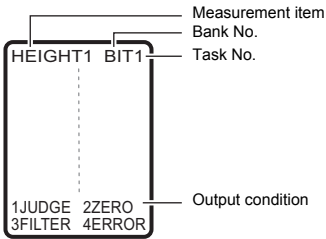

Adjust the output conditions for the measurement results.

■ Setting the Judgment Threshold Value

 p.51

■ Setting the Offset (Zero Value)

 p.51

■ Setting the Average Number of Times

 p.52

■ Setting Smoothing

 p.53

■ Setting Processing during Non-measurement

 p.53

Setting the Judgment Value

Setting the Judgment Threshold Value

Set the range of measurement values to be judged as OK.

► ADJ mode-MENU/VIEW key-[JUDGE]

Setting value	Description
HIGH	Sets the HIGH threshold value. Range: -999.99999 to +999.99999
LOW	Sets the LOW threshold value. Range: -999.99999 to +999.99999

Note

To change numerical values, use the ↑UP key/↓DOWN key, and to change the number of digits use the ←LEFT key/→RIGHT key.

Important

The default judgment threshold value is the “rated measurement range of the currently connected Sensor ÷ 4”.

Example: As the measurement range of the ZG-WDS70 (diffuse reflection type) is “60 mm” (±30 mm), the default judgment threshold value becomes “60 ÷ 4=15”. So, the default threshold judgment value is ±15 mm.

Setting the Zero Reset Offset Value

To set a reference value for zero reset to a value other than 0 (zero), set the offset amount using this function. After setting any target value, execute a zero reset in the RUN mode.

 Setting Zero Reset p.56

► ADJ mode-MENU/VIEW key-[ZERO]

Setting value	Description
Zero	Sets the offset amount. Range: -999.99999 to +999.99999 (default value: 0)

Note

To change numerical values, use the ↑UP key/↓DOWN key, and to change the number of digits use the ←LEFT key/→RIGHT key.

Adjusting the Output Conditions of the Measurement Result

Here, set the filter for each individual measurement cycle.

Setting the Average Number of Times

The average of the set number of measurements can be output as the measurement result. Set this function to disregard sudden changes in the waveform.

► ADJ mode-MENU/VIEW key-[FILTER]-[AVE]

Setting value	Description
1,2,4,8,16,32,64,128,256	Sets the average number of measurements. (default value: 1)

Note

- To change numerical values, use the ↑UP key/↓DOWN key.
- The calculation method for the average values differs according to the measurement trigger and sensitivity adjustment settings.

	MULTI sensitivity	AUTO sensitivity	FIXED sensitivity
Trigger disable	Moving average	Moving average	Moving average
Trigger enable	Simple average	Moving average	Simple average

Moving average: The average value is output from the past N number of results.

Simple average: Measurement is performed for N number of times, and the average value of these measurements is output.

Setting Smoothing

The intermediate value of past measurement results can be output as the measurement value. This function removes any abnormal values, such as spiking, that occur when the shape of the measurement target suddenly changes during measurement.

► ADJ mode-MENU/VIEW key-[FILTER]-[SMOOTH]

Setting value	Description
OFF, LOW, MID, HIGH	Sets the smoothing strength. (default value: LOW) The intermediate value of the past measurement values for the preset filter value at each individual measurement cycle is set as the measurement result. LOW: 3 times, MID: 9 times, HIGH: 15 times

Important

Smoothing is invalid when the measurement trigger and sensitivity adjustment settings are combined as follows. (Smoothing is not executed even if it is set.)

- Trigger enabled + multiple sensitivity
- Trigger enabled + fixed sensitivity

Setting Processing during Non-measurement

Set the output methods for when a non-measurement state occurs temporarily, for example, due to insufficient received light amount or the reset input status.

► ADJ mode-MENU/VIEW key-[ERROR]-[ERROR]

Setting value	Description
KEEP	The status immediately before measurement is stopped is held and output.
CLAMP	The preset clamp value (abnormal value) is output. (default value)

Note

When [CLAMP] is selected, set the clamp value to be output.

 Analog output p.91

Monitoring the Measurement Status

The measurement information is displayed on the LCD screen. You can switch the screen to display different measurement information according to your specific application.

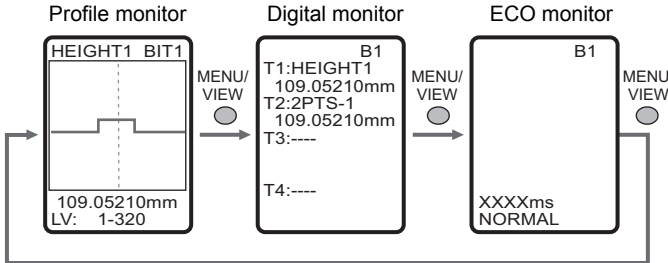

Profile monitor

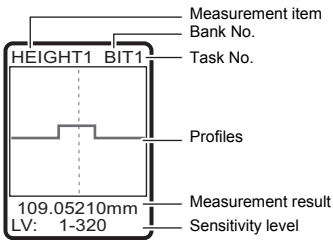

The currently measured profile is displayed. When multiple tasks are registered, switch the profile and display it for each individual task.

Note

To switch the task display, use the ↑UP key/ ↓DOWN key.

Digital monitor

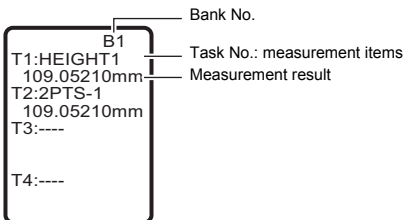

Measurement results for each individual task are displayed as a list as numerical values.

ECO monitor

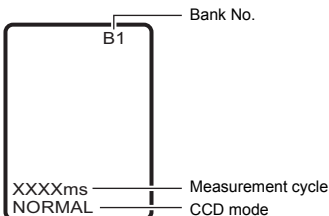

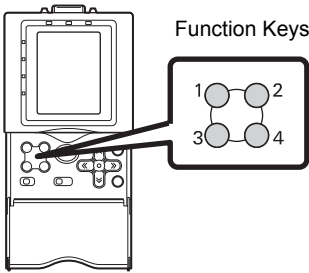

The measurement cycle and CCD mode are displayed.

Shortcut Keys

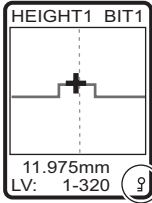

In the RUN mode, the following functions are assigned to shortcut keys F1 to F4.

Function keys	Function
F1	If the F1 key is pressed when [I/O]-[I/O LINE]-[TRIGGER]-[ENABLE] is set, the trigger is input.
F2	The image is displayed. To return the display to the normal display, press the F2 key again. Measurement is stopped while the image is displayed.
F3	 <p>Lock status</p> <p>When the F3 key is pressed and held down for 3 seconds or longer, the key lock confirmation message is displayed. When the key lock function is ON, the FUN/ADJ/RUN modes cannot be switched. To cancel the key lock, press and hold down the F3 key for 3 seconds or longer.</p>
F4	Magnifies the profile display.  Magnifying the Profile Display p.57

Executing Reference Zero Reset

Setting Zero Reset

When the zero reset function is used, the reference value "0" is registered as the height, and the measured value can be displayed and output as a positive or negative deviation (tolerance) from the reference value. In the RUN mode, the measured value can be reset to "0" at any time during measurement.

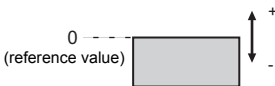
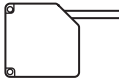

Zero Reset indicator

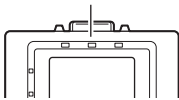

1 Set the object to be used as the reference in place.

2 Press the SET key.

The Zero Reset indicator lights, and the current measured value is registered as 0 (zero).

Note

- To cancel a zero reset, press and hold the ESC key for 2 seconds or longer.
- Zero reset can also be executed and canceled by an external input.
- A value other than zero also can be set as the zero reset reference value.



Setting the Zero Reset Offset Value p.51

Magnifying the Profile Display

A specified area of the profile display can be magnified.

► RUN mode-F4 key-[MGNIFY]

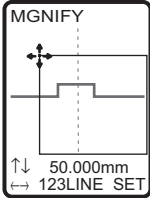

When the desired region of the profile is enclosed, it is displayed magnified.

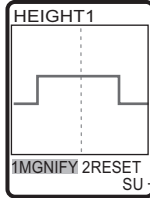

While the profile display is magnified, "SU" is displayed at the bottom right of the screen.

FUNCTION SETTINGS

Measurement Settings	60
Bank Settings	85
I/O Settings	87
System Settings	97



Setting Measurement Items

► FUN mode-[MEAS]-[SENS]-[TASK1 to 4]-[ITEM]

There are eight measurement items. Measurement items can be set to each individual task so that up to 4 measurements can be performed simultaneously.

Height direction	Width direction	Other
<ul style="list-style-type: none"> • Height • 2-pt step • 3-pt step 	<ul style="list-style-type: none"> • Edge position • Edge width 	<ul style="list-style-type: none"> • Angle • Cross-sectional area • Calculation

Height direction

Height

This item measures the height.







Icon	Description
	 <p>Measures the average value inside an area.</p>
	 <p>Measures the maximum value (peak) inside an area.</p>
	 <p>Measures the minimum value (bottom) inside an area.</p>

Illustration of automatic setting

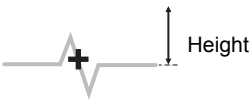

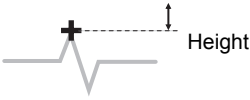
 How to adjust the region p.66

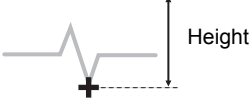
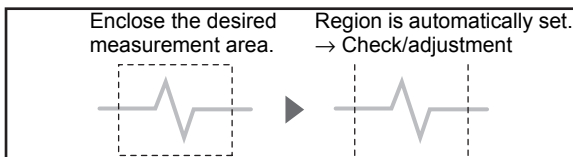
Step

Measures the step from the reference plane.

- When there is one reference plane, select “2-pt step”.
- When there are two reference planes, select “3-pt step”.

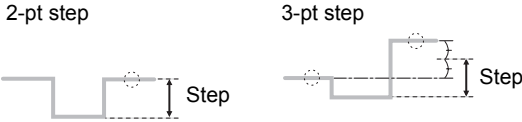

< 2-pt step >

To measure a protrusion (+ direction) taking the base as the reference plane:

Icon	Description	
 Average		Measures the step between the average values of P1 and P2.
 Peak		Measures the step between the average value of P1 and the maximum value of P2.

To measure an indentation (- direction) taking the top surface as the reference plane:

Icon	Description	
 Average		Measures the step between the average values of P1 and P2.
 Bottom		Measures the step between the average value of P1 and the minimum value of P2.

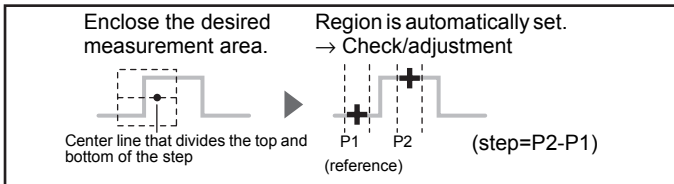
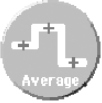
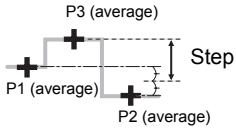

Illustration of automatic setting



How to adjust the region p.66

< 3-pt step >

To measure a protrusion (+ direction) taking the base as the reference plane:

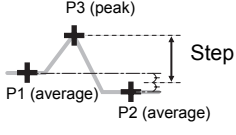
Icon	Description
 <p>Average</p>	 <p>Measures the step between the average value of P3 taking the average values of both sides (P1, P2) as the reference plane.</p>
 <p>Peak</p>	 <p>Measures the step between the maximum value of P3 taking the average values of both sides (P1, P2) as the reference plane.</p>

To measure an indentation (- direction) taking the top surface as the reference plane:





Icon	Description
 <p>Average</p>	 <p>Measures the step between the average value of P3 taking the average values of both sides (P1, P2) as the reference plane.</p>
 <p>Bottom</p>	 <p>Measures the step between the minimum value of P3 taking the average values of both sides (P1, P2) as the reference plane.</p>

Illustration of automatic setting



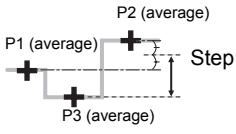

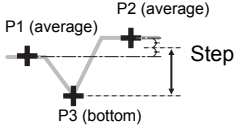
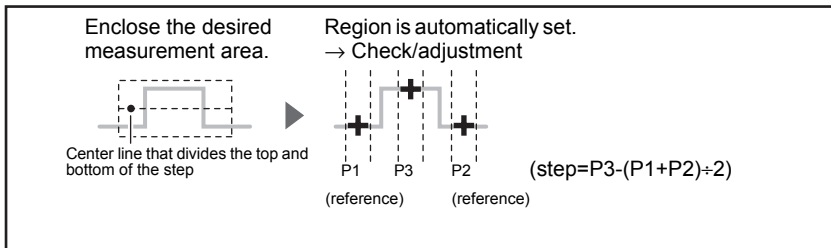

 How to adjust the region p.66

Width direction

Performs measurement taking the point of intersection of the profile and the edge level as an edge.

< Edge position >

Icon	Description
	<p>Edge position</p>  <p>Measures the edge that is positioned on the left side inside an area.</p>
	<p>Edge position</p>  <p>Measures the edge that is positioned on the right side inside an area.</p>

< Edge width >



Icon	Description
	<p>Width</p>  <p>Measures the width of the protrusions between edges that are extracted inside an area.</p>
	<p>Width</p>  <p>Measures the width of the indentations between edges that are extracted inside an area.</p>

Illustration of automatic setting

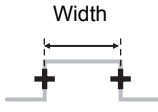

How to adjust the region p.66

Note

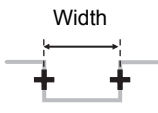
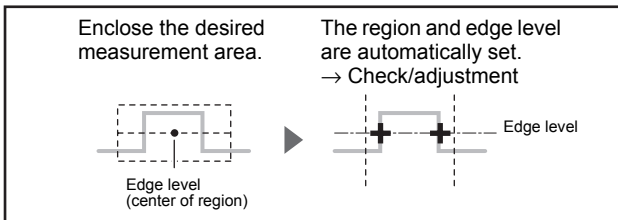
The edge level can be changed in the EXP mode.



How to change the edge level p.70

Other

< Angle >

The angle of the profile inside the region is measured.
Measurement of the angle is enabled only in the EXP mode.



Icon	Description
 <p data-bbox="229 443 288 467">Angle</p>	 <p data-bbox="684 352 986 711">The average values inside the region are each extracted as points. A straight line is drawn between the two extracted points, and the angle formed by the intersection between that straight line and the X-axis is measured as the angle. The angle between the two points is measured taking the average inside the specified region as the measurement points.</p>

Illustration of setting

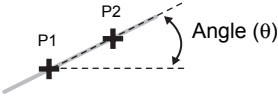
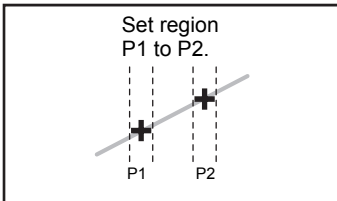

 How to adjust the region p.66

< Cross-sectional area >

The cross-sectional area of the profile inside the region is measured.
Measurement of the cross-sectional area is enabled only in the EXP mode.



Icon	Description
 <p>Area</p>	 <p>Cross-sectional area (mm²)</p> <p>The cross-sectional area of the object can be measured. Specify the bottom face. The cross-sectional area is calculated by integrating the distances between each of the measurement points and the bottom face.</p>

Illustration of setting

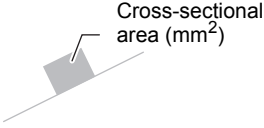
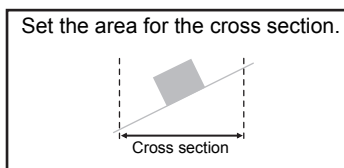

 How to adjust the region p.66

< Calculation >

The measurement results of other tasks can be used for calculation.
The calculation setting is enabled only in the EXP mode.

Icon	Description
 <p>Calc</p>	<p>Set any equation to perform addition/subtraction on the measurement result. The equation can be substituted with measurement results obtained by other tasks.</p> <p>Allowable equation: $K+mX+nY$</p> <ul style="list-style-type: none"> • K range: -999.99999 to 999.99999 (default value: 0.00000) • m/n range: -10.0 to 10.0 (default value: 1.0) • X/Y range: OFF (default value: OFF), TASK1 to TASK3 (Only task Nos. smaller than the task No. to which a calculation is set can be set.)

< Deleting measurement items >

Icon	Description
 <p>Delete</p>	<p>Delete the measurement items that are set to the currently selected task.</p>

Customizing Measurement Conditions

Adjusting Regions

The target region can be adjusted by this function when it is not set by the automatic setting. Set the region by using this function when measurement items “angle” and “cross-sectional area” for which automatic setting cannot be performed are selected.

► FUN mode-[MEAS]-[SENS]-[TASK1 to 4]-[CUSTOM]-[REGION]

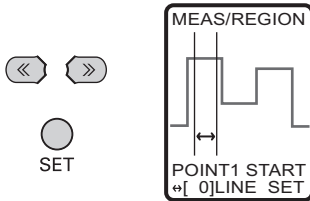

1 Specify the start and end lines of the region P1.

Left/Right key: Moves the cursor.

SET key: Applies the setting.

ESC key: Cancels the setting.

2 Specify the start and end lines for the number of regions.

Automatic Setting of Regions

The region is automatically set merely by enclosing the desired measurement area.

Note

Automatic setting can be executed by the same procedure regardless of the mode, EXP mode or STD mode.

► **FUN mode-[MEAS]-[SENS]-[TASK1 to 4]-[AUTO]**

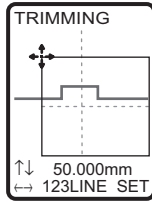
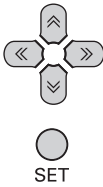

1 Adjust the top left of the desired measurement area, and press the SET key.

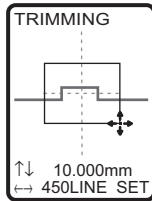
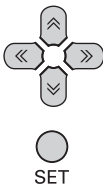

2 Adjust the bottom right of the desired measurement area, and press the SET key.

When the desired measurement area is enclosed, the region in which measurement points are extracted is automatically set.

Important

When there is a step, set so that the center line of the region matches the “area that divides the top and bottom of the step.” When there is an edge, set so that the center line of the region matches the “edge to be detected.”

When there is a step

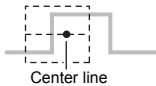

When there is an edge

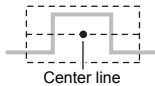

Magnifying the Image Display

A specified area of the profile display can be magnified.

► FUN mode-[MEAS]-[SENS]-[TASK1 to 4]-[CUSTOM]-[MGNIFY]

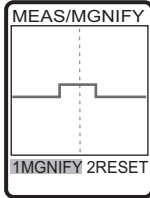
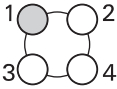

1 Select [MGNIFY].

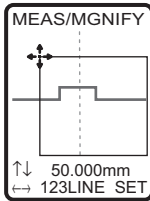
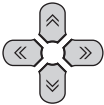

2 Adjust the top left of the desired display area by the ↑, ↓, ← and → keys, and press the SET key.

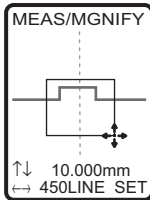
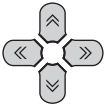

3 Adjust the bottom right of the desired display area by the ↑, ↓, ← and → keys, and press the SET key.

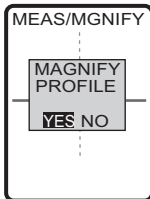

4 Move to [YES] and press the SET key.

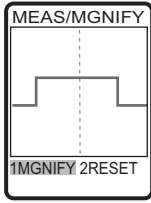

The profile in the specified area is displayed magnified.

Selecting Measurement Points

Any measurement point inside the received light area can be measured. Set this menu item when measuring small unevenness. The measurement point setting is enabled only in the EXP mode.

► **FUN mode-[MEAS]-[SENS]-[TASK1 to 4]-[CUSTOM]-[POINT]-[POINT1 to 2]**

Setting value	Description
AVE (average)	Measures the average value inside the line beam.
PEAK	Measures the peak position of the line beam.
BTM	Measures the bottom position of the line beam.

Changing the Edge Level and Edge Direction

Set the edge level and edge direction when selecting edge-related measurement items. This setting is enabled only in the EXP mode.

► FUN mode-[MEAS]-[SENS]-[TASK1 to 4]-[CUSTOM]-[EDGELV]

Changing the edge level

Setting value	Description
Edge level	Align the line of the edge level with the edge to be detected. The range differs according to the CCD mode. Standard and high-resolution mode: 0 to 399 High-speed mode: 0 to 199

Selecting the edge direction

Set the edge search direction.

Setting value	Description
→ Forward direction	The "1st edge from the left" in the area is searched for.
← Reverse direction	The "1st edge from the right" in the area is searched for.

Setting Scaling (Correction Processing)

If scaling is set, differences between measurement values and actual sizes, that occur due to the color, material or other factors of the measurement target, can be corrected. There are two scaling setup modes, “automatic setting” and “manual setting.” In the automatic setting mode, actual measurement is performed, and in the manual setting mode, the correction values are set manually.

(default value: OFF)

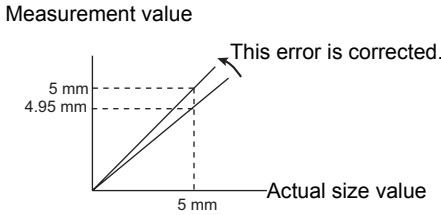

Important

The settings below return to the default settings when scaling is set. Set these items after scaling settings have been completed.

- Zero reset

Measurement items	Setup Method	Reference
2-pt step, 3-pt step, edge width	Automatic setting: one-point scaling Measurement is performed once, and the correction value for the measurement value is set.	p.72
Height, edge position	Automatic setting: two-point scaling Measurement is performed at two positions, and correction values are set for those measurement values.	p.72
Angle, cross-sectional area	Manual setting Input and set coefficients and offset values directly as numerical values.	p.73

Automatic Setting Method

Measurement is actually performed, and correction values are set for those measurement values.

► FUN mode-[MEAS]-[SENS]-[TASK1 to 4]-[SCALE]-[AUTO]

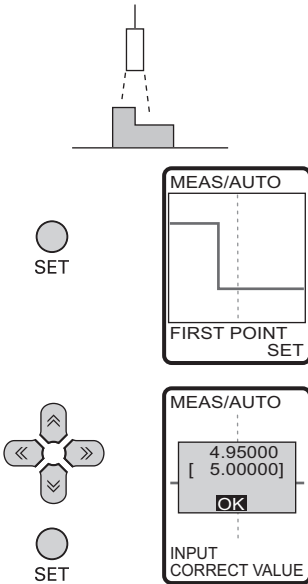

1 Set the measurement target in place, and press the SET key.

2 Input the correction value for the measurement value on the upper section.

Note

To change numerical values, use the ↑UP key/↓DOWN key, and to change the number of digits use the ←LEFT key/→RIGHT key.

3 In the case of two-point scaling (height, edge position), move the measurement target, and repeat steps 1 and 2, to set the 2nd point.

Manual Setting Method

Span and offset can be set by inputting numerical values manually to fine-tune the measurement values. These can be set for each individual task. Span and offset are automatically set after scaling is executed. So, modify these settings as necessary. Manual setting is enabled only in the EXP mode.

► FUN mode-[MEAS]-[SENS]-[TASK1 to 4]-[SCALE]-[MANUAL]

Setting value	Description
SPAN	<p>Sets the inclination of the sensor characteristics as a coefficient. Range: -4.0000 to 4.0000</p> 
OFFSET	<p>Adds/subtracts a fixed value to or from the measured value. Range: -999.99999 to 999.99999</p> 

Image Adjustment

Adjusting Sensitivity

The sensitivity of the Sensor can be adjusted so that shapes are accurately captured even if the shape, color, material, etc. of the measurement target is influenced.

The default setting is [MULTI].

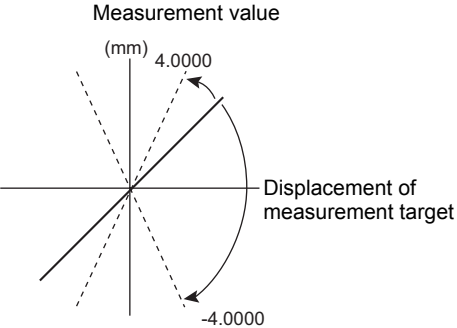
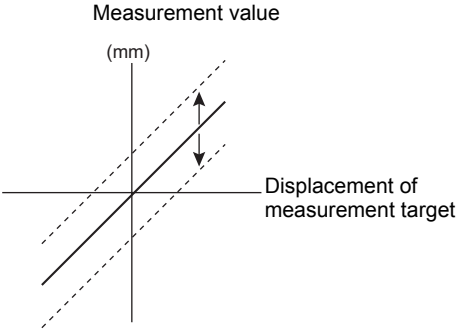

Sensitivity Adjustment Functions of the ZG Series p.151

► FUN mode-[MEAS]-[IMAGE]-[LD-POWER]

Setting value	Description
MULTI	Measurement is performed with the sensitivity adjusted for each individual line in the measurement region. This method is suitable when the brightness of the measurement target surface fluctuates to a large degree.
AUTO	Measurement is performed with the sensitivity adjusted automatically based on the sensitivity information in the measurement region. This method is suitable when the brightness of the measurement target surface is uniform.
FIXED	Measurement is performed with the sensitivity fixed. This method is suitable when accurate measurements cannot be made at the [AUTO] setting, for example, for lines on which measurement targets of various colors are fed alternately.

Important

[MULTI] is effective as a sensitivity adjustment function only when measuring stationary measurement targets. When the measurement target cannot be made stationary, use [AUTO] or [FIXED].

Note

Measurement cycle

The measurement cycle differs according to the preset CCD mode. The measurement cycle can be checked by the ECO monitor in the RUN mode.



Monitoring the Measurement Status p.54

Detailed setting of sensitivity adjustment

The sensitivity adjustment upper/lower limits and interval can be adjusted in the EXP mode.

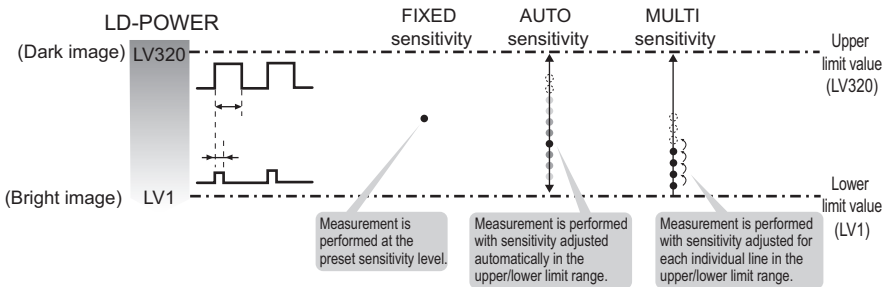

Detailed setting of MULTI sensitivity

► FUN mode-[MEAS]-[IMAGE]-[LD-POWER]-[MULTI]

Setting value		Description
CUSTOM	HIGH	Sets the sensitivity adjustment upper limit. Range: LV1 to LV320 (default value: LV320)
	LOW	Sets the sensitivity adjustment lower limit. Range: LV1 to LV320 (default value: LV1)
	STEP (interval)	Sets the sensitivity adjustment interval. <ul style="list-style-type: none"> • Fine adjustment: LV5 increments • Standard: LV10 increments (default value) • Rough adjustment: LV20 increments
SEARCH		The upper and lower limits are set automatically matched to the measurement target.

Note

Examples of Effective Sensitivity Adjustment

- To shorten the processing time:
To narrow the distance between the upper and lower limits and set a large interval (fine adjustment → standard → rough adjustment).
- To measure the shape of the measurement target in detail:
Set a small interval (rough adjustment → standard → fine adjustment).

Detailed setting of AUTO sensitivity

► FUN mode-[MEAS]-[IMAGE]-[LD-POWER]-[AUTO]

Setting value		Description
CUSTOM	HIGH	Sets the sensitivity adjustment upper limit. Range: LV1 to LV320 (default value: LV320)
	LOW	Sets the sensitivity adjustment lower limit. Range: LV1 to LV320 (default value: LV1)

Setting of FIXED sensitivity level

► FUN mode-[MEAS]-[IMAGE]-[LD-POWER]-[FIXED]

Setting value	Description
LV 0 to 320	Sets the fixed sensitivity level to be used. Range: LV0 to LV320 (default value: LV160) When LV0 is set, laser emission is turned OFF.

Setting the Measurement Region

Extremely bright parts or areas other than the measurement target sometimes cause the sensitivity adjustment to become unstable.

If this happens, measurement can be made stable by adjusting the region to restrict the area to be adjusted for sensitivity.

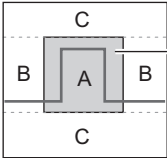

Measurement region

- A: This region is targeted for both sensitivity adjustment and measurement.
- B: This region is outside the sensitivity adjustment target area, and is targeted for measurement only.
- C: This region is outside the measurement target area, and the measurement image is deleted.

► FUN mode-[MEAS]-[IMAGE]-[REGION]

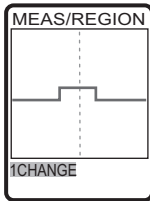
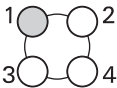

1 Select [CHANGE].

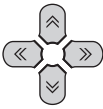

SET

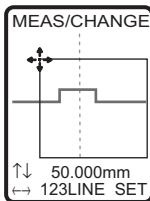

2 Adjust the top left of the desired measurement area by the \uparrow , \downarrow , \leftarrow and \rightarrow keys, and press the SET key.

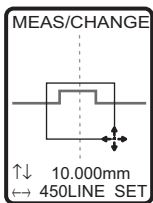
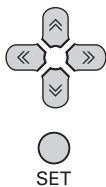

- 3** Adjust the bottom right of the desired measurement area by the ↑, ↓, ← and → keys, and press the SET key.

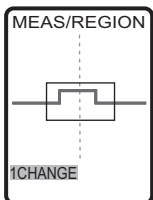

The measurement region is set to the specified area.

Profile

Noise filtering, output at measurement failure, and other options can be set in more detail. Adjust the conditions when the measurement cannot be performed properly. Setting of profiles is enabled only in the EXP mode.

Setting the Average Number of Times

Changes in data are smoothed out using the average values of adjacent data. Smoothing is performed in the “width direction (X-axis direction).”

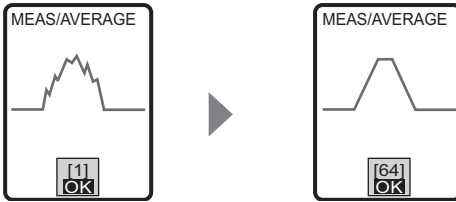

► FUN mode-[MEAS]-[IMAGE]-[PROFILE]-[AVERAGE]

Setting value	Description
1, 2, 4, 8, 16, 32, 64	Sets the number of data to average. (default value: 4 when the CCD mode is NORMAL or HI-RESO, and 1 when the CCD mode is HI-SPEED)

Setting the Smoothing Function

Changes in data are smoothed out using the intermediate values of adjacent data. Smoothing is performed in the “width direction (X-axis direction).” This setting is effective in filtering noise such as spikes.

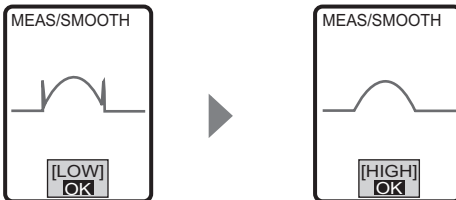

► FUN mode-[MEAS]-[IMAGE]-[PROFILE]-[SMOOTH]

Setting value	Description
OFF, LOW, MID, HIGH	Sets the smoothing strength. (default value: LOW)

Setting the Interpolation Method

This is used for interpolating between data in areas where profile data is missing (areas where measurement is not possible). If there are lines where the measurement target cannot be measured due to different degrees of reflectance or other causes, the data of such lines can be obtained by interpolating between the data acquired for the lines that allow measurement as desired.

Example: Profile output result when there are areas where measurement data cannot be obtained

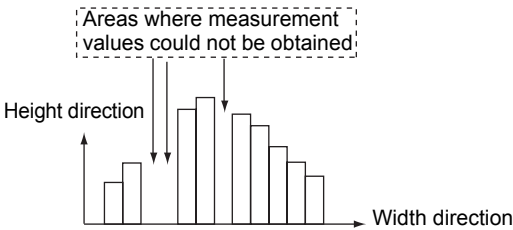

OFF (interpolation is not performed)

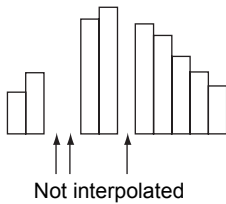

ON (linear interpolation is performed)

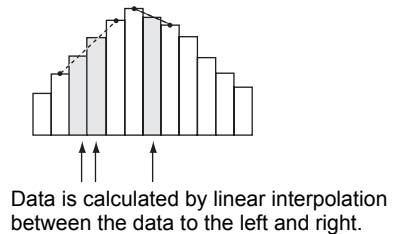

► FUN mode-[MEAS]-[IMAGE]-[PROFILE]-[FILLUP]

Setting value	Description
OFF	A measurement error signal is output for each area where measurements could not be obtained.
ON	Data for areas where measurements could not be obtained is calculated by linear interpolation between the data to the left and right. Up to 64 missing data values can be obtained by this method. (default value)

Setting the Number of Interpolated Pixels

Set the number of pixels to be interpolated when interpolating profile data. Profile data is interpolated only if missing areas (areas where measurement data cannot be obtained) contain less than the specified number of pixels. Interpolation is not performed if a number of pixels greater than the specified number cannot be measured continuously. This feature can be applied, for example, to the measurement of measurement targets with holes in them.

Example: When the number of interpolated pixels is set to 2

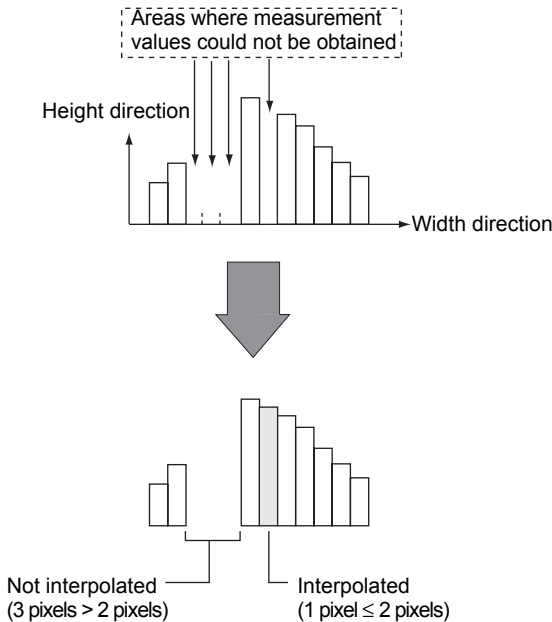

► FUN mode-[MEAS]-[IMAGE]-[PROFILE]-[SUPnum]

Setting value	Description
1, 2, 4, 8, 16, ALL (unit: pixels)	Interpolation is performed when missing areas contain less than the specified number of pixels. When [ALL] is selected, interpolation is performed on the entire profile regardless of the number of pixels. (default value: 4)

Position Correction

Set the reference position and correction direction to correct position shift of the measurement target. The measurement value when these are set is registered as the reference position. So, place the measurement target at the correct position before you start settings.

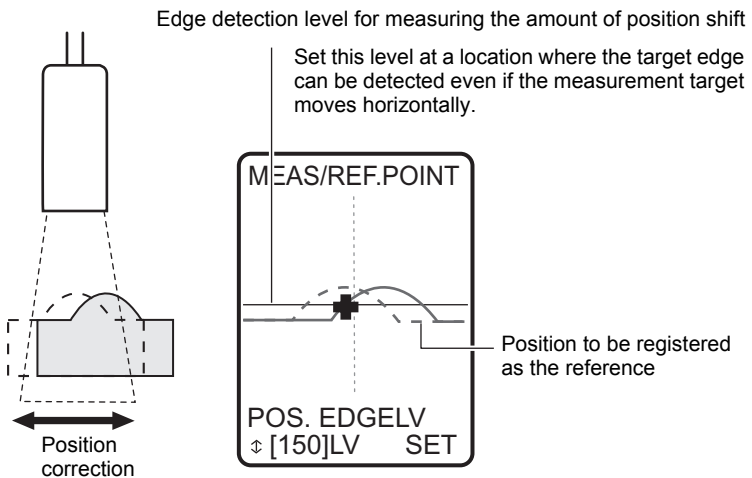
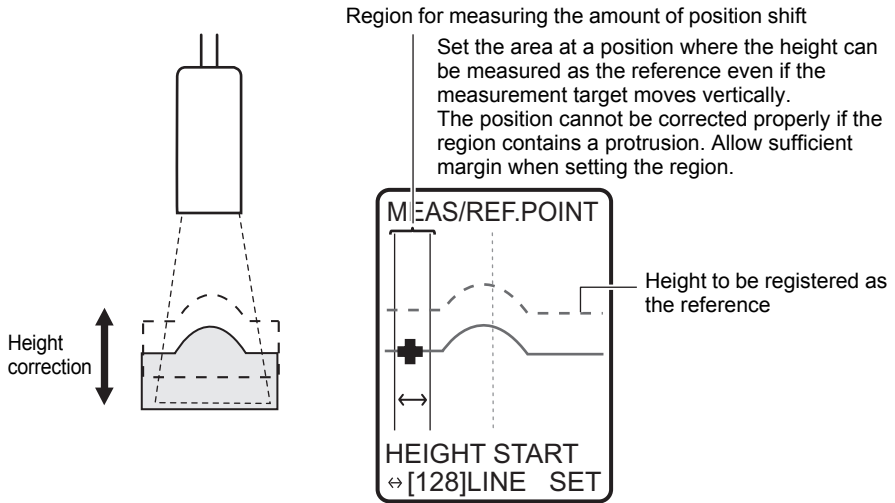

Registering the Reference Position

Register the reference position.

► FUN mode-[MEAS]-[CORECT]-[REF.POINT]

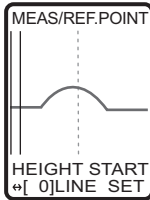

- 1** Set the measurement target in place, and press the SET key.

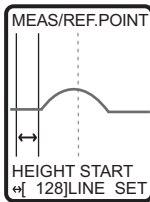

- 2** To correct shift in the height direction, specify the start and end lines.

Left/Right key: Moves the cursor.

SET: Applies the setting.

ESC key: Cancels the setting.

Important

Leave the default setting as it is if correction in the height direction is not necessary.

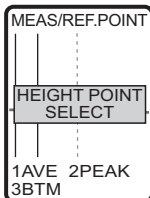
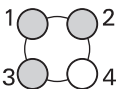

- 3** Select the measurement point to be used as the reference.

Select which position (average, peak or bottom) within the specified region is to be taken as the measurement point.

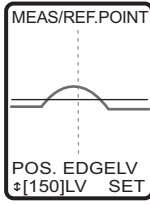

- 4** To correct shift in the position direction, align the line of the edge level to be detected.
 Up/Down key: Moves the cursor.
 SET: Applies the setting.
 ESC key: Cancels the setting.

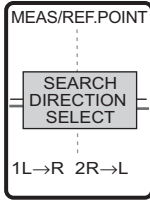
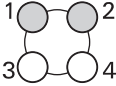

- 5** Select the direction in which edges are searched.
 Select [L→R] (forward direction) or [R→L] (reverse direction).

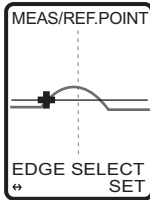

- 6** A cross cursor is displayed at the reference position. Press the ←/→ key to select the edge, and press the SET key.

Setting the Correction Method

Set the method to be used for correction.

► FUN mode-[MEAS]-[CORECT]-[METHOD]

Setting value	Description
NONE (no correction)	The position is not corrected. (default value)
HEIGHT (height correction)	Correction is performed in the height direction.
POSITION (position correction)	Correction is performed in the position direction.
HEIGHT&POS (height/position correction)	Correction is performed in both the height and position directions.



Bank Settings

The ZG can hold up to four sets of settings, which are called a “bank”. Bank 1 is displayed as the default bank when the Smart Sensor is turned ON. Banks 2 to 4 are also provided in addition to this.

Tasks and Bank Data p.38

Bank Switching (change of device setup)

The currently selected bank can be switched to other banks. Switching of banks is instructed by operating Controller keys, external signals or communication commands.

► FUN mode-[BANK]-[SWITCH]

Setting value	Description
BANK1, BANK2, BANK3, BANK4	Selects the target bank. (default value: BANK1)

Note

Switching banks by external signals p.106
Switching banks by communication commands p.127

Copying Bank Data

Settings of other banks can be copied to the current bank.

► FUN mode-[BANK]-[COPY]

Setting value	Description
BANK1, BANK2, BANK3, BANK4	Selects the copy source bank. (default value: BANK1)

Important

After executing a bank copy, switch to the RUN mode once to save the settings. Settings are cleared when the Smart Sensor is turned OFF after you just copy the settings.

Clearing Bank Data

The content of banks can be cleared.

Important

Settings in [System] and [I/O] are not cleared.

► FUN mode-[BANK]-[CLEAR]

Setting value	Description
YES	The content of the currently selected bank is cleared.
NO	The content of the currently selected bank is not cleared.



Setting Analog Output Conditions

This section describes the settings required for analog output of the current measurement result.

Assignment of Analog Output

Set the assignment to the analog output wire. Only one task can be assigned for analog output when multiple tasks are set.

► FUN mode-[I/O]-[ANALOG]-[TASK]

Setting value	Description
OFF	Analog output is not performed.
TASK1, TASK2, TASK3, TASK4	The measurement value of the task selected here is analog-output from the Controller. (default value: TASK1)

Setting Scaling

With analog output, the relationship between the displayed measured value and output value can be freely set as the measurement value is converted to a current of 4 to 20 mA or a voltage of -10 to +10 V, and is then output. Match the settings to suit the connected external device.

Enter the output values for any two current values or voltage values to set the output range. (default value: OFF)

Example: Set 0 mm to 4 mA, and 5 mm to 20 mA. (for current output)

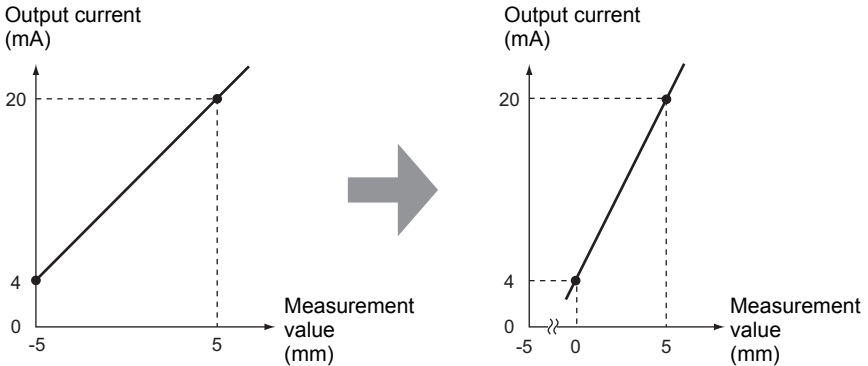

► FUN mode-[I/O]-[ANALOG]-[SCALE]-[ON]

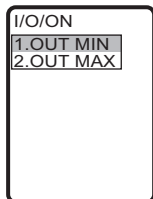
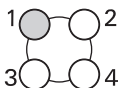

1 Select [OUT MIN].



SET

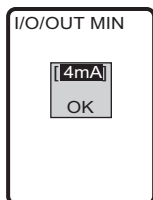

2 Move the cursor to the numerical value by the \uparrow/\downarrow key, and press the SET key.



SET

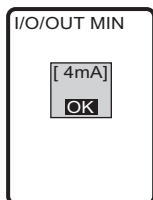

3 Select the output value of MIN by the \uparrow/\downarrow key, and press the SET key twice.

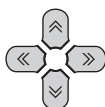

SET

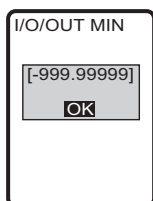

4 Input the measurement value corresponding to output MIN, and press the SET key.

Range: -999.99999 to 999.99999

Note

To change numerical values, use the \uparrow UP key/ \downarrow DOWN key, and to change the number of digits use the \leftarrow LEFT key/ \rightarrow RIGHT key.

5 Repeat steps 1 to 4 to set output MAX.

Correcting Analog Output Values

Discrepancies may occur between the analog output current (or voltage) values set on the Controller and the actual current (or voltage) values measured due to the conditions for the connected external device or other factors. The analog output correction function can be used to correct this discrepancy.

The output values are corrected by entering the correction value for the current (or voltage) values for any two points. (default value: OFF)

Range: -999 to 999

Important

Set scaling beforehand, and select current output or voltage output. Also, connect the analog output wire to an external ammeter or voltmeter.

► FUN mode-[I/O]-[ANALOG]-[ADJUST]-[ON]

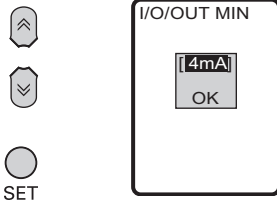

1 Move the cursor to the numerical value by the \uparrow/\downarrow key, and press the SET key.

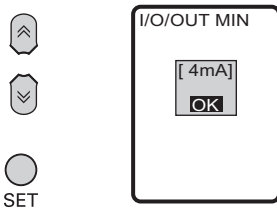

2 Select the output value of MIN by the \uparrow/\downarrow key, and press the SET key twice.

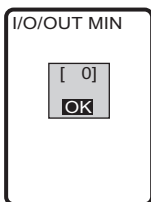
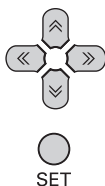

- 3** Input the correction value corresponding to output MIN, and press the SET key.

Note

To change numerical values, use the ↑UP key/↓DOWN key, and to change the number of digits use the ←LEFT key/→RIGHT key.

- 4** Repeat steps 1 to 3 to set output MAX.

Setting the Clamp Level

A preset clamp value (abnormal value) can be output in cases where the light density is temporarily excessive or insufficient (i.e. measurement is not possible) due to defects or holes, for example, in the measurement target.

► FUN mode-[I/O]-[ANALOG]-[CLAMP]

Setting value

At current output: MIN (approx.2 mA), MAX (approx.25 mA, default value), 4 to 20 mA (in 1 mA increments)

At voltage output: MIN (approx.-11 V), MAX (approx.11 V, default value), -10 to 10 V (in 1 V increments)

Setting Conditions When a Parallel Output Unit is Used

This section describes the methods for connecting a Real-time Parallel Output Unit (ZG-RPD_1) and outputting the measurement value or judgment result at high speed. The measurement value is converted to 16-bit binary data before it is output.

Assignment of Terminal Block Output

Set the output content for the Real-time Parallel Output Unit.

► FUN mode-[I/O]-[RPD]-[OUTPUT]

Setting value	Description
OFF	Does not output to the Real-time Parallel Output Unit.
MEAS (measurement value)	Outputs the measured value to the Real-time Parallel Output Unit. (default value)
JUDGE (judgment value)	Outputs the judgment result to the Real-time Parallel Output Unit. When multiple tasks are set, the respective judgment result for all tasks is output.

Assignment of Tasks

Set the tasks to be output to the Real-time Parallel Output Unit. This setting is enabled when measurement values are output.

► FUN mode-[I/O]-[RPD]-[TASK]

Setting value	Description
TASK1, TASK2, TASK3, TASK4	The measurement value of the task selected here is output to the Real-time Parallel Output Unit. (default value: TASK1)

Setting the Number of Digits Past the Decimal Point

Set the number of digits past the decimal point of the measurement value to output to the Real-time Parallel Output Unit.

► FUN mode-[I/O]-[RPD]-[DIGIT]

Setting value	Description
5, 4, 3, 2, 1	Sets the number of output digits past the decimal point. (default value: 3)

Setting I/O Conditions

Switching Bank Data

Set from where switching of banks is to be instructed.

► FUN mode-[I/O]-[I/O LINE]-[BANK]

Setting value	Description
MENU	Bank switching is performed by operating the control keys. (default value)
EXT IN	Bank switching is performed from the external input wire.

Setting the Measurement Trigger

Set the measurement timing method. The default setting is [DISABLE] (continuous measurement).

► FUN mode-[I/O]-[I/O LINE]-[TRIGGER]

Setting value	Description
ENABLE	The trigger is used as the measurement timing.
DISABLE	The trigger is not used and measurement is performed continuously. (default value)

Setting the GATE Signal

Setting the GATE interval

Set the period that the GATE signal remains ON. Set a value that allows the external device to capture the measurement result. Output on the ZG-RPD_1 conforms to the timing set here.

► FUN mode-[I/O]-[I/O LINE]-[GATE PERIOD]

Setting value	Description
1 to 500 (ms)	Sets the period that the GATE signal remains ON. (default value: 3 ms)

Setting the GATE delay

Set the time delay from when the result is output to the terminal block to when the GATE signal is turned ON. Output on the ZG-RPD_1 conforms to the timing set here.

► FUN mode-[I/O]-[I/O LINE]-[GATE DELAY]

Setting value	Description
1 to 50 (ms)	Sets the time delay from when the result is output to the terminal block to when the GATE signal is turned ON. (default value: 1 ms)

Setting Serial Output Conditions

This section explains the settings required at serial output.

Serial Output at Trigger Measurement

Set whether or not to perform serial output at trigger measurement.



Communication Method p.120

► FUN mode-[I/O]-[SERIAL]-[AUTO]

Setting value	Description
OFF	Sets the command response method for serial output. Measurement data is output only when a data acquisition command is input from an external device. (default value)
ON	Sets the auto output method for serial output. The measurement data is output when measurement ends. (MEASURE or other commands are not required.)



Important

With auto output, output on the USB interface only is enabled.

Setting Automatic Output

This function is enabled only when the auto output method is set for serial output. When [OFF] is set, specify the desired task to output as the parameter when the MEASURE command is input.

► FUN mode-[I/O]-[SERIAL]-[OUTPUT]

Setting value	Description
TASK1, TASK2, TASK3, TASK4	<p>The measurement value of the task selected here is serial-output. (default value: TASK1)</p> <p>The output format is the same as that of the MEASURE command.</p> <p> p.129</p>
TASK ALL	<p>All tasks 1 to 4 are output. The output format is the same as that of the MEASURE command.</p> <p> p.129</p>
PROFILE (A) PROFILE (B)	<p>The profile is output. The output format is the same as that of the PROFILE command.</p> <p>When profile (A) is selected, the profile is output in PROFILE 0 (ASCII) format.</p> <p>When profile (B) is selected, the profile is output in PROFILE 1 (binary) format.</p> <p>Auto output of profiles is not possible in the case of AUTO sensitivity.</p> <p> p.139</p>



Setting the Sensor Installation Status

Set how the Sensor is installed.

This setting is automatically specified according to the type of the connected Sensor. However, if the Sensor is installed at an angle and the default value and reflection angle are changed, change the settings according to the status of the Sensor installation.

► FUN mode-[SYSTEM]-[Sensor SET]

Setting value	Description
DIFFUSE (diffuse reflection)	Select this item when the Sensor is installed for diffuse reflection measurement.
REGULAR (regular reflection)	Select this item when the Sensor is installed for regular reflection measurement.

Setting the CCD Mode

Set the resolution of the Sensor's CCD. The profile can be set to high-resolution or the response time can be speeded up by changing the CCD mode.

 CCD Mode p.148

Important

When the CCD mode is changed, the bank data is initialized. So, be sure to start with teaching again.

► FUN mode-[SYSTEM]-[CCD MODE]

Setting value	Description
NORMAL (standard mode)	Standard measurement is performed. (default value)
HI-RESO (high-resolution mode)	Measurement is performed at a resolution of about four times that of the standard mode.
HI-SPEED (high-speed mode)	Measurement is performed with the number of pixels halved in the height direction. This mode is suited to measurement of shapes in fast line speed processes as the measurement cycle is fast. Note, however, that the possible measurement distance becomes roughly 1/2 of the rated distance.

Setting the RS-232C Communication Specifications

Set the communication specifications for the Controller matched to the communication specifications of external devices.

► FUN mode-[SYSTEM]-[RS-232C]

Setting value	Description
LENGTH	8BIT, 7BIT (default value: 8 BIT)
PARITY	NONE, ODD, EVEN (default value: NONE)
STOP (stop bit)	1BIT, 2BIT (default value: 1BIT)
BAUDRATE	9600, 19200, 38400, 57600, 115200 (default value:38400)
DELIMITER	CR, LF, CR+LF (default: CR)

Setting the Node No.

This node No. sets the connection group No. as seen from the host device (PLC). Not only the ZG series but also two or more devices can be connected to the PLC. The No. assigned to devices connected to a PLC in this instance is referred to as a node No.

► FUN mode-[SYSTEM]-[NODE]

Setting value	Description
0 to 16	This node No. sets the connection group No. as seen from the PLC. (default value: 0)

Setting the Sensor Data Loading Method

Various data is saved in the Sensor. Set at which timing this information is to be loaded to the Controller.

► FUN mode-[SYSTEM]-[Sensor DATA]

Setting value	Description
Sensor	Reads the data currently saved on the Sensor each time that the Controller is started up. (default value)
CONTROLLER	Data is not read from the Sensor when the Controller is started up if the same Sensor at the previous startup is connected. <div style="border: 1px solid black; padding: 2px; width: fit-content; margin: 5px 0;">Important</div> When the combination of Controller and Sensor is fixed, selecting "CONTROLLER" sometimes results in the Controller starting up more stably depending on the operating environment.

Setting the Number of Digits Past the Decimal Point

Set the number of display digits past the decimal point that are displayed in the measurement result on the monitor. When five or less digits are set, the digits are disabled from the rightmost digit first.

► FUN mode-[SYSTEM]-[DIGIT]

Setting value	Description
5, 4, 3, 2, 1	Sets the number of display digits past the decimal point. (default value: 3)

Note

The number of digits past the decimal point in serial output follows the setting made here.

Setting/Changing the ECO Display

Darkens the LCD screen to suppress current consumption when control keys or selection switches are not operated for three minutes or longer.

► FUN mode-[SYSTEM]-[ECO MODE]

Setting value	Description
ON	The ECO mode setting is enabled. (default value)
OFF	The ECO mode setting is disabled.

Displaying the Controller Information

You can display the system version of the Sensor and Controller. This information allows you to check the Sensor type, serial No., Controller type and version information.

► FUN mode-[SYSTEM]-[INFO]

Setting/Changing the Display Language

Set the display language of the LCD screen.

► FUN mode-[SYSTEM]-[LANGUAGE]

Setting value	Description
JAPANESE	Displays menus in Japanese.
ENGLISH	Displays menus in English.

Setting the Icon Color

You can set the color of icons.

► FUN mode-[SYSTEM]-[ICON]

Setting value	Description
DEFAULT	The icon color is set to orange. (default value)
BLUE	The icon color is set to blue.
GREEN	The icon color is set to green.
MONOTONE	The icon color is set to monotone.

Saving the Setup Data

Bank settings and system settings are saved internally on the Controller.

Important

- The settings of all banks are saved regardless of the currently selected bank No.
- After you have made or changed settings, be sure to save the setup data. All settings will be deleted if you turn the power OFF without saving the data. A message prompting you to save data will be displayed if you change to the RUN mode without saving data after you have changed settings.

► FUN mode-[SYSTEM]-[SAVE]

Setting value	Description
YES	Saves the setup data.
NO	Does not save the setup data.

CONNECTION WITH EXTERNAL DEVICE

Output Data List	104
Communication Using I/O Signals	105
I/O Timing Charts	114
Serial Communication	118

Output Data List

The ZG series can output three types of data (measurement values, judgment values and profile data) to external devices. All output data on the ZG series can be obtained by serial communication.

Measurement value (result for each individual task)

Output path	Description
Controller analog output	The task is output as an analog value.
Parallel Output Unit	The task is output in 16-bit binary format.
Serial communication	The results of all tasks or each individual task are output as ASCII code.

Profile

Output path	Description
Controller I/O cable	(No output)
Parallel Output Unit	(No output)
Serial communication	Profile data of 631 points is output as either ASCII code or in binary format.

Judgment value (result for each individual task)

Output path	Description
Controller I/O cable	The overall judgment of all tasks is output. The following output is performed on registered tasks: ALL PASS: This output is turned ON when all judgment results are OK. NG: This output turns ON when even one measurement result is NG. ERROR: This error turns ON when there is even one measurement error. (ERROR has higher priority over NG.)
Parallel Output Unit	Judgment values are output for each individual task. TASK1: HIGH/PASS/LOW/ERROR TASK2: HIGH/PASS/LOW/ERROR TASK3: HIGH/PASS/LOW/ERROR TASK4: HIGH/PASS/LOW/ERROR
Serial communication	Results are output for each individual task.

Note

Either of the following methods can be selected for acquiring output data by serial communication:

- Command response method
- Auto output method (Data is output automatically when trigger measurement ends.)



Communication Method p.120

Communication Using I/O Signals

Using the Controller I/O Cable

By using the Controller's I/O cable, you can output the measurement value or judgment result to external devices, or input a control signal such as zero reset or LD-OFF from external devices. A predetermined I/O signal is assigned to each signal wire of the I/O cable.

Wiring the Controller I/O Cable

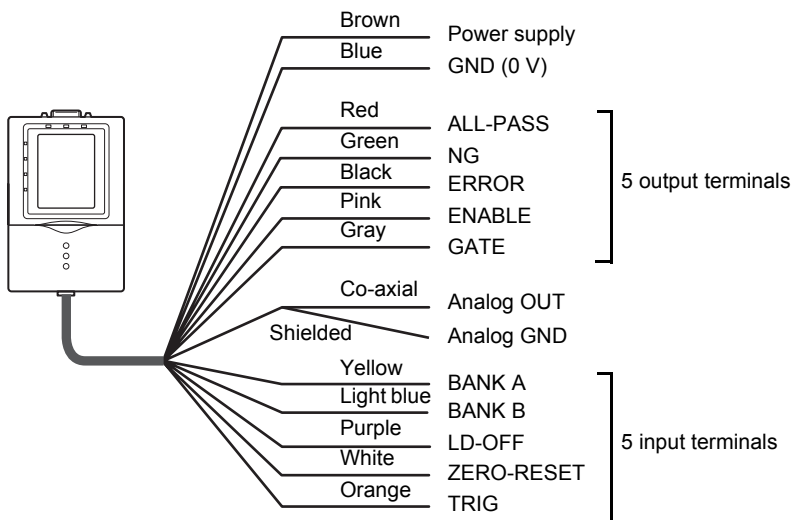

Assignments and Functions of I/O Signal Wires

Assignment of output signal wires

Function	Signal	Description												
Judgment output	ALL-PASS	Turns ON when the judgment result of all tasks is OK (or all tasks are not registered).												
	NG	Turns ON when there is even one task whose judgment result is NG.												
	ERROR	Turns ON when there is even one task for which a measurement error occurred.												
Trigger auxiliary	ENABLE	Turns ON when trigger input is enabled during trigger measurement. Turns OFF during bank switching. <table border="1" style="margin-left: 40px;"> <thead> <tr> <th></th> <th>Regular</th> <th>During trigger measurement</th> <th>Bank switching in progress</th> </tr> </thead> <tbody> <tr> <td>Trigger</td> <td>ON</td> <td>OFF</td> <td>OFF</td> </tr> <tr> <td>Continuous</td> <td>ON</td> <td>-</td> <td>OFF</td> </tr> </tbody> </table>		Regular	During trigger measurement	Bank switching in progress	Trigger	ON	OFF	OFF	Continuous	ON	-	OFF
		Regular	During trigger measurement	Bank switching in progress										
Trigger	ON	OFF	OFF											
Continuous	ON	-	OFF											
	GATE	Turns ON when the measurement result is being fixed. (The startup and output times can also be set.)												

Assignment of input signal wires

Function	Signal	Description															
Bank switching	BANK A/ BANK B	This is used for switching banks. Specify the bank No. in combinations of A and B. <table border="1" style="margin-left: 40px;"> <thead> <tr> <th>Selected bank</th> <th>BANK A</th> <th>BANK B</th> </tr> </thead> <tbody> <tr> <td>Bank 1</td> <td>OFF</td> <td>OFF</td> </tr> <tr> <td>Bank 2</td> <td>OFF</td> <td>ON</td> </tr> <tr> <td>Bank 3</td> <td>ON</td> <td>OFF</td> </tr> <tr> <td>Bank 4</td> <td>ON</td> <td>ON</td> </tr> </tbody> </table> ENABLE output becomes OFF during bank switching. (when a trigger is enabled) Bank switching time p.117	Selected bank	BANK A	BANK B	Bank 1	OFF	OFF	Bank 2	OFF	ON	Bank 3	ON	OFF	Bank 4	ON	ON
Selected bank	BANK A	BANK B															
Bank 1	OFF	OFF															
Bank 2	OFF	ON															
Bank 3	ON	OFF															
Bank 4	ON	ON															
Stop laser	LD-OFF	Stops laser lighting (emission). While LD-OFF is being input, linear output and judgment output conform to the non-measurement setting.															
Execute zero reset	ZERO-RESET	Sets the measurement values of all tasks to zero. <ul style="list-style-type: none"> • At zero reset execution Input the zero reset signal for 50 to 800 ms. After the zero reset execution signal turns OFF, the zero reset is executed within one measurement cycle. • At zero reset cancellation Input the zero reset signal for 1 s or longer. The zero reset is cancelled within one measurement cycle after 1 s elapses. 															
Measurement trigger	TRIG	Inputs the measurement start/stop timing from an external device.															

Analog Output

Connect the analog output wire to an external ammeter or voltmeter, and convert the measurement value for output as 4 to 20 mA analog current or -10 to +10 V analog voltage. With analog output, output values can be scaled or corrected to suit the conditions of the connected external device.



Setting Analog Output Conditions p.87

Note

The maximum response in analog output is 500 μ s.

I/O Circuit Diagrams

Important

Make sure that the load connected to “analog output wire (co-axial) - analog GND wire” satisfies the rating of the set state (voltage or current output) before turning the Controller ON. Otherwise, the Controller may be damaged.

NPN type (ZG-WDC11)

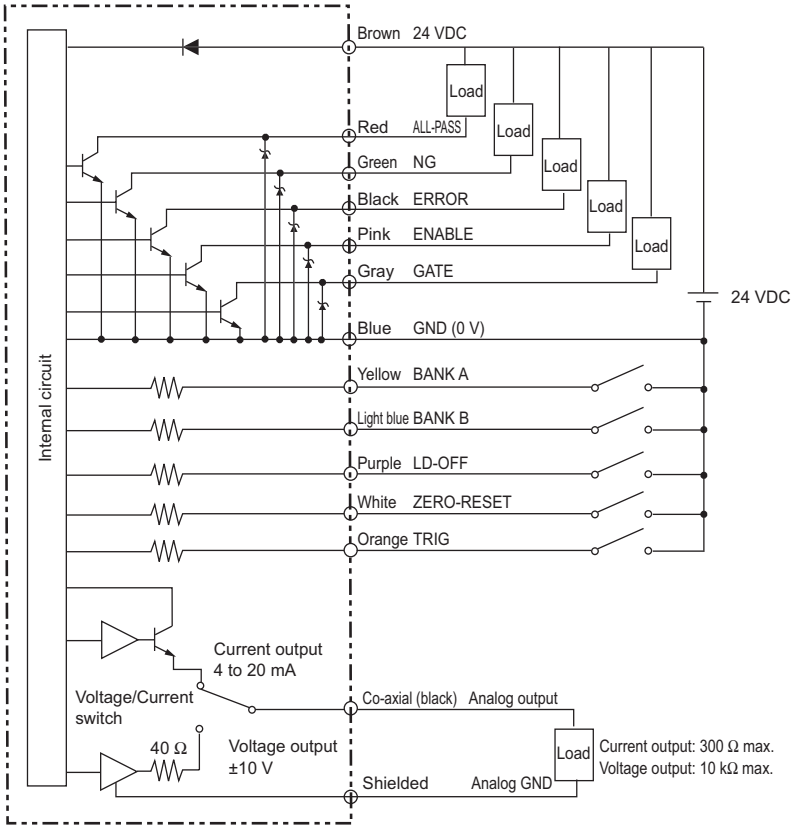

PNP type (ZG-WDC41)

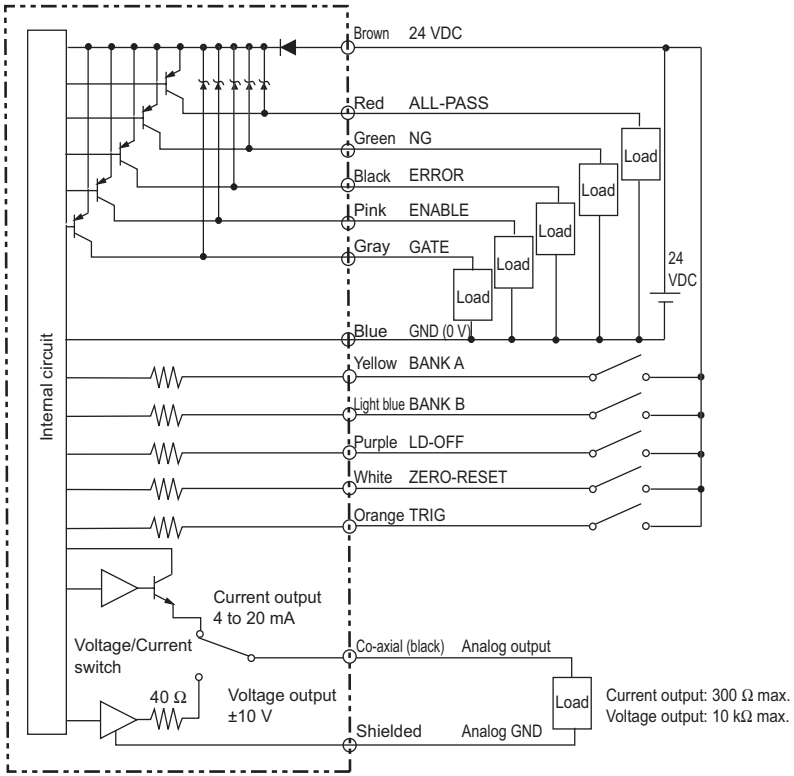

4 CONNECTION WITH EXTERNAL DEVICE

Using the Parallel Output Unit (sold separately)

The Parallel Output Unit (ZG-RPD_1) (sold separately) can be used to output measurement values or judgment results to external devices at high speed.

Measurement values are converted to 16-bit binary data before they are output.

Connecting the Parallel Output Unit

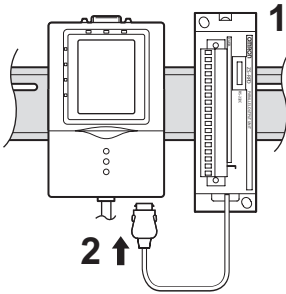

- 1** Mount the Parallel Output Unit on a DIN track.
- 2** Connect the connector to the RS-232C connector on the ZG-WDC.

Layout of Output Terminals

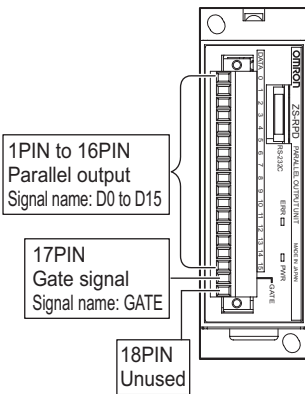

Pin No.	Signal name	Bit assignment	Description
1	D0	b0	Binary data output pin
2	D1	b1	
3	D2	b2	
4	D3	b3	
5	D4	b4	
6	D5	b5	
7	D6	b6	
8	D7	b7	
9	D8	b8	
10	D9	b9	
11	D10	b10	
12	D11	b11	
13	D12	b12	
14	D13	b13	
15	D14	b14	
16	D15	b15	
17	GATE	-	GATE si
18	-	-	Unused

Output Circuit

The following circuit configuration is employed for the total of 17 outputs (data outputs (D0 to D15) and GATE signal).

NPN output type (ZG-RPD11)

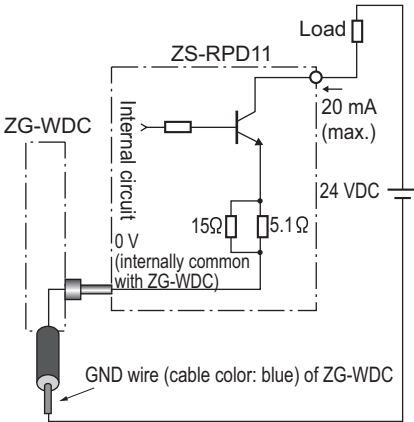

PNP output type (ZG-RPD41)

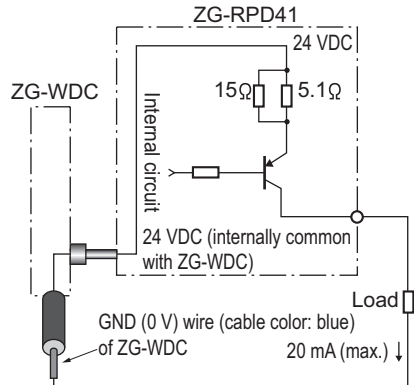

Output data assignments

The data type to be output to the Parallel Output Unit is set and switched on the Controller.

 Setting Conditions When a Parallel Output Unit is Used p.92

Note

When outputting measurement values, the number of output digits, that is, up to which digit of the measurement value, must be set.

 Setting the Number of Digits Past the Decimal Point p.93

Output of Measurement Values

Measurement values are handled as integers matched to the number of digits past the decimal point setting, and are converted to a 16-bit binary number (2's complement) before they are output. Bit expressions are output using minus logic ("1" when open output is ON).

< Output Format >

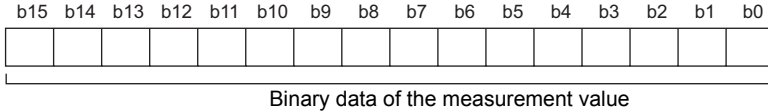

< Output of Measurement Values (example) >

The following shows an example where the number of digits past the decimal point is set to "3".

Output of measurement standby status

b15	b14	b13	b12	b11	b10	b9	b8	b7	b6	b5	b4	b3	b2	b1	b0
0	0	0	0	0	0	0	0	0	0	0	0	0	0	0	0

Output at "no measurement target present" error

b15	b14	b13	b12	b11	b10	b9	b8	b7	b6	b5	b4	b3	b2	b1	b0
1	1	1	1	1	1	1	1	1	1	1	1	1	1	1	1

When measurement value is "+1.234"

b15	b14	b13	b12	b11	b10	b9	b8	b7	b6	b5	b4	b3	b2	b1	b0
0	0	0	0	0	1	0	0	1	1	0	1	0	0	1	0

When measurement value is "-1.234"

b15	b14	b13	b12	b11	b10	b9	b8	b7	b6	b5	b4	b3	b2	b1	b0
1	1	1	1	1	0	1	1	0	0	1	0	1	1	1	0

Output of Judgment Results

The measurement result and measurement status of each task are output as binary data.

< Output Format >

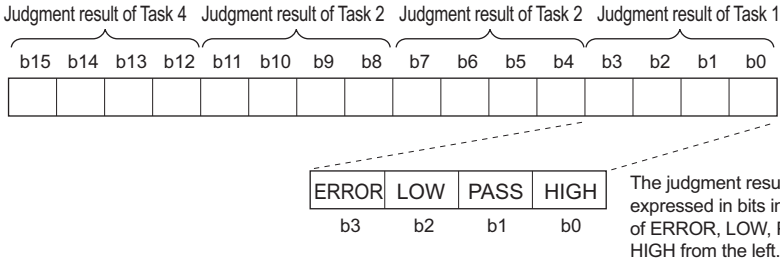



Signal name	Bit	Function	Item	Description
D0	b0	Task 1 judgment output	HIGH	Turns ON when the judgment result of task 1 is HIGH.
D1	b1		PASS	Turns ON when the judgment result of task 1 is PASS.
D2	b2		LOW	Turns ON when the judgment result of task 1 is LOW.
D3	b3		ERROR	Turns ON when the judgment result of task 1 is an error.
D4	b4	Task 2 judgment output	HIGH	Turns ON when the judgment result of task 2 is HIGH.
D5	b5		PASS	Turns ON when the judgment result of task 2 is PASS.
D6	b6		LOW	Turns ON when the judgment result of task 2 is LOW.
D7	b7		ERROR	Turns ON when the judgment result of task 2 is an error.
D8	b8	Task 3 judgment output	HIGH	Turns ON when the judgment result of task 3 is HIGH.
D9	b9		PASS	Turns ON when the judgment result of task 3 is PASS.
D10	b10		LOW	Turns ON when the judgment result of task 3 is LOW.
D11	b11		ERROR	Turns ON when the judgment result of task 3 is an error.
D12	b12	Task 4 judgment output	HIGH	Turns ON when the judgment result of task 4 is HIGH.
D13	b13		PASS	Turns ON when the judgment result of task 4 is PASS.
D14	b14		LOW	Turns ON when the judgment result of task 4 is LOW.
D15	b15		ERROR	Turns ON when the judgment result of task 4 is an error.

I/O Timing Charts

This section explains the I/O signals that are exchanged between the Controller and external devices, and the timing charts for data output.

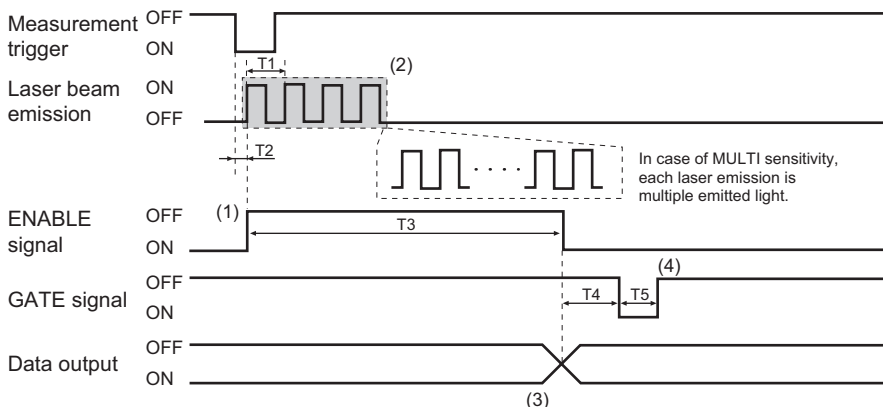
External output at trigger measurement (MULTI sensitivity/FIXED sensitivity)



T1: Measurement cycle	The measurement cycle can be checked by the ECO monitor in the RUN mode.  p.54
T2: Trigger input response time	This is the time from input of the measurement trigger up to when input is recognized as the trigger. 500 μ s or less
T3: Output response time	When the trigger is detected after it is input, data output changes status from ON to OFF, and this status is held for the following preset time. At FIXED sensitivity: $T_3 = T_1 \times (\text{average number of times} + 2)$ At MULTI sensitivity: $T_3 = T_1 \times \text{average number of times}$
T4: GATE output delay time	This is the time from start of output up to when the GATE signal turns ON. This time can be changed. This is the time to wait until stable output data can be obtained.
T5: GATE ON time	This is the time that the GATE signal is ON. This time can be changed. This is the time that is required to capture data output (measurement values/judgment results) on external devices.

Important

When the auto output for serial output is ON, input the next trigger after all measurement data is received. At this time, the ENABLE signal turns ON after all measurement data has finished being sent.

Explanation of Operation

- (1) When the measurement trigger signal is input, the ENABLE signal turns OFF after the trigger input response time elapses.
- (2) Measurement is executed for the preset average number of times. (In the example, the average number of times is set to 4.)
- (3) When measurement ends, the applied measurement data is output after the output response time elapses. When the ENABLE signal changes status to ON, the next trigger can be accepted.
- (4) When the GATE output delay time elapses after start of output, the GATE signal turns ON for the specified time, and measurement data is captured on the external device.

External output at trigger measurement (AUTO sensitivity)

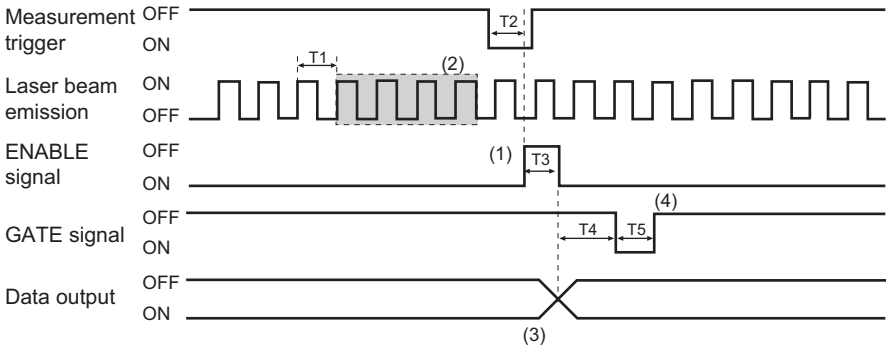

T1: Measurement cycle	The measurement cycle can be checked by the ECO monitor in the RUN mode.  p.54
T2: Trigger input response time	This is the time from input of the measurement trigger up to when input is recognized as the trigger. 500 μs or less
T3: Output response time	When the trigger is detected after it is input, data output changes status from ON to OFF, and this status is held for the "measurement cycle (T1) x 2 or less."
T4: GATE output delay time	This is the time from start of output up to when the GATE signal turns ON. This time can be changed. This is the time to wait until stable output data can be obtained.
T5: GATE ON time	This is the time that the GATE signal is ON. This time can be changed. This is the time that is required to capture data output (measurement values/judgment results) on external devices.

Important

When the auto output for serial output is ON, input the next trigger after all measurement data is received. At this time, the ENABLE signal turns ON after all measurement data has finished being sent.

Explanation of Operation

- (1) When the measurement trigger signal is input, the ENABLE signal turns OFF after the trigger input response time elapses.
- (2) The average value is output from the past N number of results (preset average number of times). (In the example, the average number of times is set to 4.)
- (3) After the output response time elapses, the applied measurement data is output. When the ENABLE signal changes status to ON, the next trigger can be accepted.
- (4) When the GATE output delay time elapses after start of output, the GATE signal turns ON for the specified time, and measurement data is captured on the external device.

External output during continuous measurement (trigger disabled)

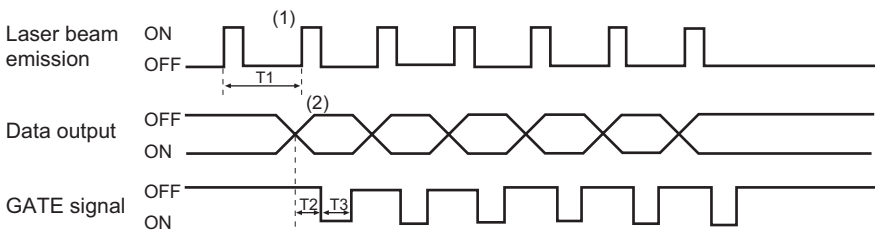

Note

- Serial output is not possible even if AUTO is set to ON.
- The ENABLE signal is ON at all times.
- During output of the GATE signal, the next GATE signal is not output and is ignored.

T1: Measurement cycle	The measurement cycle differs according to the set content. The measurement cycle can be checked by the ECO monitor.  p.54
T2: GATE output delay time	This is the time from start of output up to when the GATE signal turns ON. This time can be changed. This is the time to wait until stable output data can be obtained.
T3: GATE ON time	This is the time that the GATE signal is ON. This time can be changed. This is the time that is required to capture data output (measurement values/judgment results/profiles) on external devices.

Explanation of Operation

- (1) Measurement is executed at each individual measurement cycle.
- (2) Measurement data is output when the measurement values are applied after measurement is started.

External input of bank switching signal

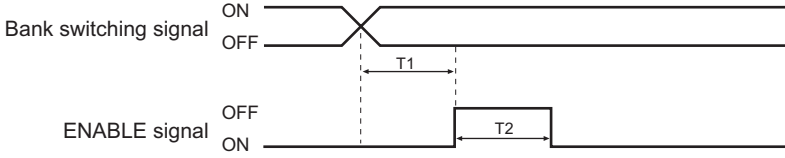

T1: ENABLE signal OFF response time	This is the time after input of the back switching signal until the ENABLE signal turns OFF. When the ECO monitor (display OFF) is operating: 20 ms or less When the digital monitor is operating: 300 ms or less When the profile monitor is operating: 200 ms or less
T2: Bank switching time	This is the time in which bank switching is executed. When the ECO monitor (display OFF) is operating: 200 ms or less When the digital monitor is operating: 500 ms or less When the profile monitor is operating: 400 ms or less

External input of laser stop signal

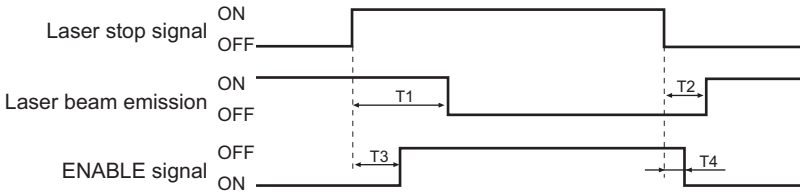

T1: Laser stop response time	This is the time after the laser stop signal is input until laser emission is stopped. 30 ms or less
T2: Laser restore response time	This is the time after the laser stop signal is canceled until laser emission is started. 20 ms or less
T3: ENABLE signal OFF response time	This is the time after input of the laser stop signal until the ENABLE signal turns ON. 10 ms or less
T4: ENABLE signal ON response time	This is the time after cancellation of the laser stop signal until the ENABLE signal turns ON. 5 ms or less

Serial Communication

Using the Serial Interface

You can use the USB port or RS-232C connector of the Controller to perform serial communication with external devices such as a personal computer or programmable controller. By serial communication, you can obtain higher resolution and more stable measurement data than with analog output.

Serial communication functions in the RUN mode. Communication cannot be performed in the FUN or ADJ modes. Also, when a system error occurs, the Controller accepts external commands, but does not execute the preset command.

Important

During RS-232C communication, measurement operations are stopped.

Communication Interface Specifications

< USB >

This interface allows full-speed (12 Mbps) communications compliant with USB 2.0 with a PC equipped with the same USB interface as standard.

Communication method	Full duplex
Synchronization method	Start-stop
Transmission code	ASCII (Binary format can be selected only for profile output.)
Data length	-
Parity	-
Stop bit	-
Baud rate	-
Delimiter	CR, LF, CR+LF

< RS-232C >

This interface allows data communications compliant with the EIA RS-232C standard up to a maximum speed of 115200 bps.

Communication method	Full duplex
Synchronization method	Start-stop
Transmission code	ASCII (Binary format can be selected only for profile output.)
Data length	8 bits, 7 bits
Parity	None, odd, even
Stop bit	1 bit, 2 bits
Baud rate	9600, 19200, 38400, 57600, 115200
Delimiter	CR, LF, CR+LF



For details on communication specification settings, see “Setting the RS-232C Communication Specifications (p.98).”

Communication Method

For serial interface-based communications, two communication methods are used; “command response method” and “auto output method.” The communication method can be set and switched on the Controller.

 Setting Serial Output Conditions p.95

Command response method

By this method, command processing is executed when a command is sent to the Controller from an external device, and a response is returned to the external device from the Controller, when command processing ends. An error response is returned when the command sent from the external device is in error or when an error occurs during command processing on the Controller.

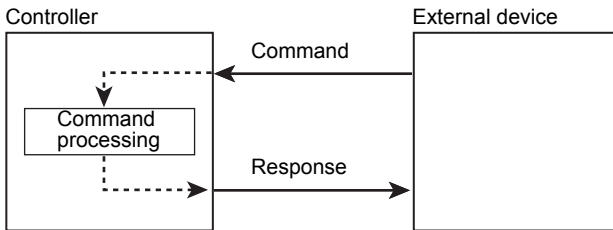

Auto output method

By this method, measurement value data is automatically output to the connected external device when the measurement values are applied after the input trigger is detected. An error response is returned when error detection is erroneous or when an error occurs during command processing on the Controller. Auto output is supported only on the USB interface.

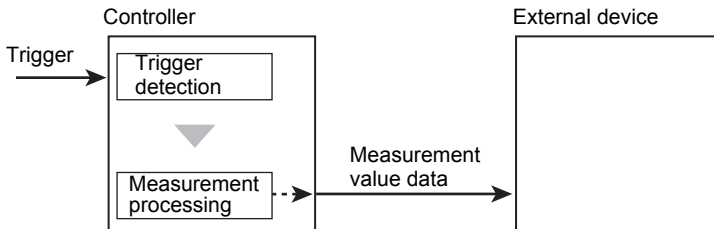

Note

Automatic output on the serial interface is not available in continuous measurement. (Commands only are supported.)

Connecting Peripheral and External Devices

Connecting a PC

Use the USB/RS-232C cable to connect the PC to the Controller.

Important

When connecting devices, refer to the Instruction Manual for the PC.

Connecting by a USB cable

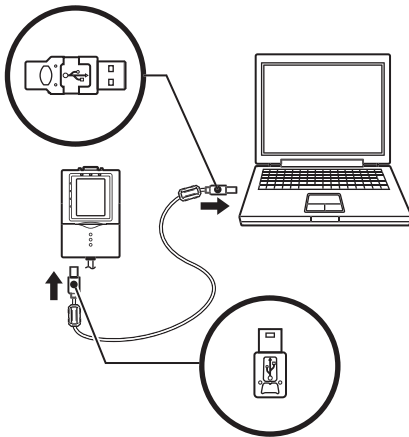

Use the USB cable provided with the ZG-WDC_1A Controller to connect the Controller to the PC.

Important

Attach the ferrite cores (supplied) to both ends of the USB cable.

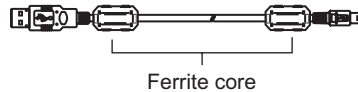

Note

Installation of the USB driver is necessary only when connecting an external device to the USB interface for the first time. For the USB driver, use the exclusive USB driver packaged with the ZG-WDC_1A controller. Smart Monitor ZG is an accessory of the ZG-WDC_1A.

Connecting by an RS-232C cable

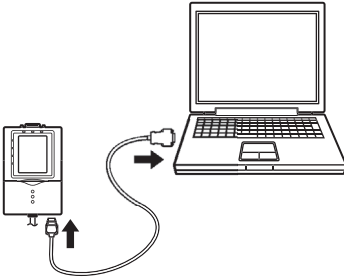

Use the exclusive cable to connect the Controller to the PC.

RS-232C cable for connecting a personal computer

Use a cable with the following pin layout,

ZS-XRS2 (cable length: 2 m)

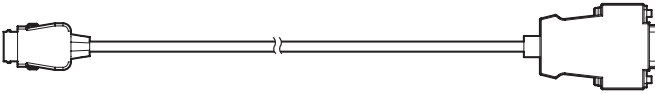

Controller side

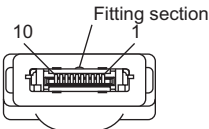

Personal computer side (PC/AT compatible)

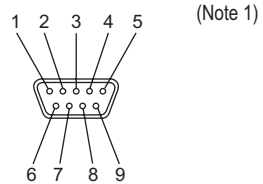

Signal name	Pin No.
NC	1
SD (TXD)	2
RD (RXD)	3
RS (RTS)	4
CS (CTS)	5
NC	6
NC	7
NC	8
SG (GND)	9
NC	10
FG	Shell

Pin No.	Signal name
1	NC
2	RD (RXD)
3	SD (TXD)
4	NC
5	SG (GND)
6	NC
7	RS (RTS)
8	CS (CTS)
9	NC
Shell	FG

Note 1: Socket type connector

Connecting to a PLC

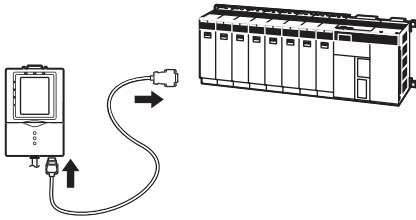

Use the RS-232C cable to connect the PC to a PLC.

Important

When connecting to a PLC, refer to the Instruction Manual for the PLC.

RS-232C cable for connecting a PLC

Use a cable with the following pin layout,

ZS-XPT2 (cable length: 2 m)

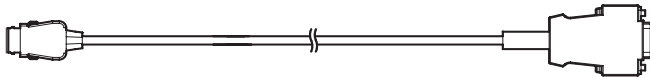

Controller side

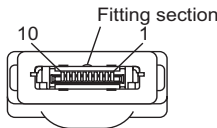

PT/PLC side (Note 1)

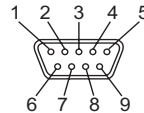

Signal name	Pin No.
NC	1
SD (TXD)	2
RD (RXD)	3
RS (RTS)	4
CS (CTS)	5
NC	6
NC	7
NC	8
SG (GND)	9
NC	10
FG	Shell

Pin No.	Signal name
1	NC
2	SD (TXD)
3	RD (RXD)
4	RS (RTS)
5	CS (CTS)
6	NC
7	NC
8	NC
9	SG (GND)
Shell	FG

Note 1: Plug type connector

About Communication Commands

Command/Response Format

< Command >

Command data	Delimiter
--------------	-----------

< Response >

When processing ends successfully

Response data	Delimiter
---------------	-----------

O	K	Delimiter
---	---	-----------

When processing fails

E	R	Delimiter
---	---	-----------

Command data	Specifies the command and parameters.
Response data	Stores the acquired data.
Delimiter	This control code indicates the end of the data.

Configuration of measurement value data

Acquired measurement values are output as data structure of variable length of up to 12 characters (when the number of digits past the decimal point is set to 5) including delimiters and sign.

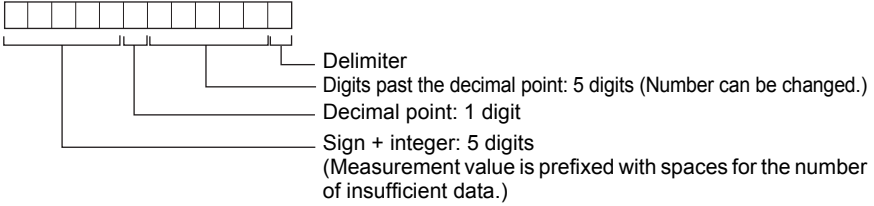

Sign	The sign (+, -) of the measurement value is stored.																																												
Integer	When the integer section of the measurement value is less than three characters, it is prefixed with spaces for the number of insufficient data. When the number of digits past the decimal point is reduced, the length of the text string decreases proportionately.																																												
Decimal point	 Setting the Number of Digits Past the Decimal Point p.99																																												
Digits past the decimal point	<p>< Measurement value > <Data configuration ></p> <p>+12.34567 <table border="1" style="display: inline-table; vertical-align: middle;"><tr><td> </td><td> </td><td> </td><td>+</td><td>1</td><td>2</td><td>.</td><td>3</td><td>4</td><td>5</td><td>6</td><td>7</td><td>C_R</td></tr></table> Number of digits past the decimal point: 5</p> <p>+12.34567 <table border="1" style="display: inline-table; vertical-align: middle;"><tr><td> </td><td> </td><td> </td><td>+</td><td>1</td><td>2</td><td>.</td><td>3</td><td>C_R</td></tr></table> Number of digits past the decimal point: 1</p> <p>-0.00123 <table border="1" style="display: inline-table; vertical-align: middle;"><tr><td> </td><td> </td><td> </td><td>-</td><td>0</td><td>.</td><td>0</td><td>0</td><td>1</td><td>C_R</td></tr></table> Number of digits past the decimal point: 3</p> <p>At measurement error <table border="1" style="display: inline-table; vertical-align: middle;"><tr><td> </td><td> </td><td> </td><td>-</td><td>9</td><td>9</td><td>.</td><td>9</td><td>9</td><td>9</td><td>9</td><td>C_R</td></tr></table></p>				+	1	2	.	3	4	5	6	7	C _R				+	1	2	.	3	C _R				-	0	.	0	0	1	C _R				-	9	9	.	9	9	9	9	C _R
			+	1	2	.	3	4	5	6	7	C _R																																	
			+	1	2	.	3	C _R																																					
			-	0	.	0	0	1	C _R																																				
			-	9	9	.	9	9	9	9	C _R																																		

Available Commands

Bank Control Commands

Command name	Description	Reference
BANKSET	Switches the current bank.	p.127
BANKGET	Acquires the current bank No.	p.128

Measurement control/measurement value acquisition commands

Command name	Description	Reference
MEASURE (or M)	Acquires the current measurement value. In the trigger measurement mode: Measurement is executed and the measurement value is acquired.	p.129
TRIG (or T)	Issues the measurement trigger.	p.130
ZERORST	Executes a zero reset.	p.131
ZEROCLR	Cancel a zero reset.	p.131

Setting acquisition/change commands

Command name	Description	Reference
DATAGET	Acquires the Controller's bank data. The latest judgment result also can be acquired by this command.	p.132
DATASET	Sets the bank data.	p.132
DATASAVE	Saves all bank data to the Controller's flash memory.	p.133
DATAINIT	Returns all Controller setup data (bank data and system data) to their defaults.	p.133

Backup/restore commands

Command name	Description	Reference
BANKLOAD	Sends the bank data to the Controller by XMODEM protocol.	p.134
BANKSAVE	Receives the bank data from the Controller by XMODEM protocol.	p.135
SYSLOAD	Sends the system data to the Controller by XMODEM protocol.	p.136
SYSSAVE	Receives the system data from the Controller by XMODEM protocol.	p.137

Utility commands

Command name	Description	Reference
CHGDISP	Switches the measurement status monitor	p.138
PROFILE (or P)	Acquires the profile.	p.139
VERGET	Acquires the version information of the Controller.	p.140

Bank Control Commands

Switch Bank < BANKSET command >

This command switches the current bank.

< Command format >

BANKSET CR
└──┬──┘ Bank No.

< Response format >

When processing ends successfully

OK CR

When processing fails

ER CR

< Explanation of parameters >

Bank No.	Specifies the bank No. after the bank is switched. (1 to 4)
----------	---

Acquire Bank No. < BANKGET command >

This command acquires the current bank No.

< Command format >

```
BANKGETCR
```

< Response format >

When processing ends successfully

```
CR
```

└── Bank No.

When processing fails

```
ERR
```

< Explanation of parameters >

Bank No.	The acquired bank No. is returned. (1 to 4)
----------	---

Measurement Control/Measurement Value Acquisition Commands

Acquire Measurement Value <MEASURE command >

This command acquires the current measurement value.

< Command format >

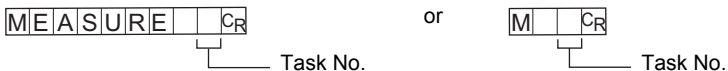

< Response format >

When processing ends successfully

- When tasks 1 to 4 are specified individually

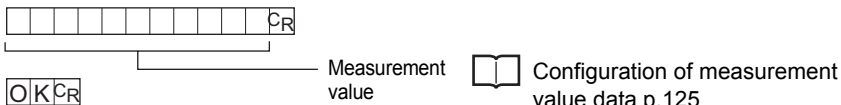

- When all tasks are specified

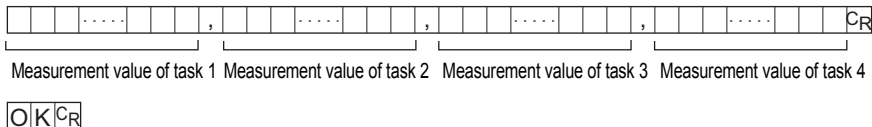

When a measurement error occurs

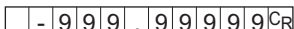

When processing fails



< Explanation of parameters >

Task No.	Specifies the task No. (0 to 4) "0" specifies all tasks. The default value is task 1.
Measurement value	The acquired measurement value is returned.

Issue Measurement Trigger < TRIG command >

This command issues the measurement trigger.
No parameters are provided for this command.

< Command format >

TRIG^{CR} or TP^R

< Response format >

When processing ends successfully (measurement is completed)

OK^{CR}

When processing fails

ER^{CR}

Note

After measurement is completed, acquire measurement values by the MEASURE command.

Important

This command functions only when trigger measurement is enabled. It cannot be used in the case of AUTO sensitivity. (If it is executed, ER is returned.)

Execute a Zero Reset < ZERORST command >

This command executes a zero reset on all tasks.

< Command format >

```
ZERORST CR
```

< Response format >

When processing ends successfully

```
OK CR
```

When processing fails

```
ER CR
```

Cancel a Zero Reset < ZEROCLR command >

This command cancels the zero reset on all tasks.

< Command format >

```
ZEROCLR CR
```

< Response format >

When processing ends successfully

```
OK CR
```

When processing fails

```
ER CR
```

Setting Acquisition/Change Commands

Acquire Bank Data < DATAGET command >

This command acquires the Controller's bank data.

< Command format >

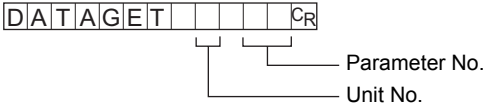

< Response format >

When processing ends successfully

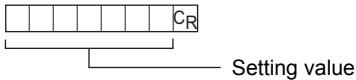

When processing fails



For details on parameters, see "Parameter List (p.141)."

Set Bank Data < DATASET command >

This command sets the bank data.

< Command format >

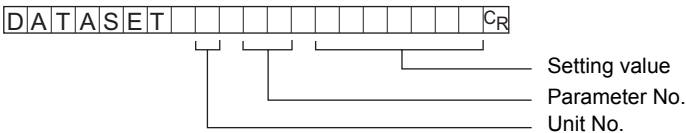

< Response format >

When processing ends successfully



When processing fails



For details on parameters, see "Parameter List (p.141)."

Save All Bank Data < DATASAVE command >

This command saves all bank data to the Controller's flash memory.
No parameters are provided for this command.

< Command format >

```
DATASAVECR
```

< Response format >

When processing ends successfully

```
OKCR
```

When processing fails

```
ERCR
```

Initialize Controller < DATAINIT command >

This command returns all Controller setup data (bank data and system data) to their defaults.

No parameters are provided for this command.

< Command format >

```
DATAINITCR
```

< Response format >

When processing ends successfully

```
OKCR
```

When processing fails

```
ERCR
```

Backup/Restore Commands

Send Bank Data < BANKLOAD command >

This command sends the bank data to the Controller by XMODEM protocol. The data is loaded to the currently displayed bank.

No parameters are provided for this command.

< Command format >

```
BANKLOADCR
```

< File transfer >

The file is transferred by XMODEM (-CRC or -SUM) after READY is received. XMODEM (-K) is not supported.

< Response format >

```
READYCR
```

When processing ends successfully

```
OKCR
```

When processing fails

```
ERCR
```

Receive Bank Data < BANKSAVE command >

This command receives the bank data from the Controller by XMODEM protocol.

< Command format >

BANKSAVE CR

Bank No.

< File transfer >

The file is transferred by XMODEM (-CRC or -SUM) after READY is received. XMODEM (-K) is not supported.

< Response format >

READYCR

When processing ends successfully

OKCR

When processing fails

ERRCR

< Explanation of parameters >

Bank No.	Specifies the bank No. to receive (acquire) data at. (1 to 4)
----------	---

Send System Data < SYSLOAD command >

This command sends the system data to the Controller by XMODEM protocol.
No parameters are provided for this command.

< Command format >

```
S|Y|S|L|O|A|D|C|R
```

< File transfer >

The file is transferred by XMODEM (-CRC or -SUM) after READY is received.
XMODEM (-K) is not supported.

< Response format >

```
R|E|A|D|Y|C|R
```

When processing ends successfully

```
O|K|C|R
```

When processing fails

```
E|R|C|R
```

Receive System Data < SYSSAVE command >

This command receives the system data from the Controller by XMODEM protocol.
No parameters are provided for this command.

< Command format >

```
S|Y|S|S|A|V|E|C|R
```

< File transfer >

The file is transferred by XMODEM (-CRC or -SUM) after READY is received.
XMODEM (-K) is not supported.

< Response format >

```
R|E|A|D|Y|C|R
```

When processing ends successfully

```
O|K|C|R
```

When processing fails

```
E|R|C|R
```

Utility Commands

Switch the Measurement Status Monitor <CHGDISP command>

This command switches the measurement status monitor in the RUN mode.

< Command format >

CHGDISP CR
└──┬──┘
Monitor type

< Response format >

When processing ends successfully

OK CR

When processing fails

ER CR

< Explanation of parameters >

Monitor type	Specifies the monitor to display. (1 to 3) 1: Profile monitor 2: Digital monitor 3: ECO monitor
--------------	--

Acquire Profile < PROFILE command >

This command acquires the profile.

< Command format >

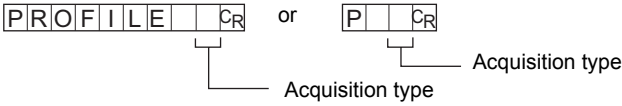

< Response format >

When processing ends successfully

- Acquisition type: when ASCII is specified

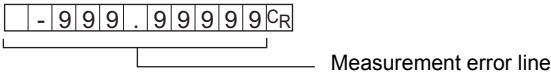
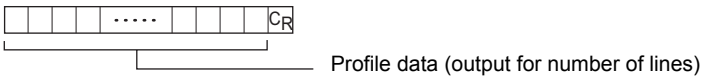
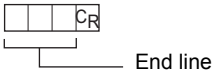
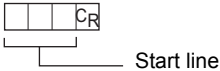
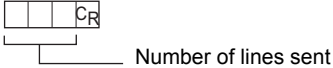

OK CR

- Acquisition type: when Binary is specified

Binary data of 4 bytes per 1 data item x 631 points ... binary data of total 2524 bytes

CRC16 ... 2-byte binary data

OK CR

When processing fails

ER CR

< Explanation of parameters >

Acquisition type	Specifies the acquisition type. 0: ASCII 1: Binary
Number of lines sent	This is the number of lines in the profile that is sent. (0 to 631)
Start line	This is the start line No. of the profile.
End line	This is the end line No. of the profile.
Profile data	Profile data is output for the number of lines. Number of digits of integer section: 3 (fill with spaces when less than three digits) Number of digits past the decimal point: max. 5 (The specified number of digits past the decimal point is reflected.)

Acquire Version No. < VERGET command >

This command acquires the version information of the Controller.

< Command format >

`VERGET``CR`

< Response format >

When processing ends successfully

`ZG- VERX.XXX``CR`

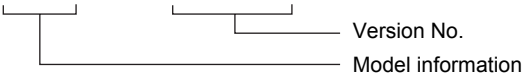

When processing fails

`ER``CR`

< Explanation of parameters >

Model information	The model No. of the Controller is returned.
Version information	The version No. of the Controller's firmware is returned.

Parameter List

DATAGET Command

Judgment value parameters

Parameter	Unit No.	Parameter No.	Output Range
Judgment value	47+20 * (task-1)	40	0: Error, 1: LOW, 2: PASS, 3: HIGH

DATASET command

Parameters at image adjustment

Sensitivity adjustment

Parameter	Unit No.	Parameter No.	Setting range
Mode selection	1	2	0: MULTI, 1: AUTO, 2: FIXED
MULTI HIGH	1	5	1 to 320
MULTI LOW	1	6	1 to 320
MULTI STEP	1	4	0: Fine adjusting, 1: Normal, 2: Rough adjustment
AUTO HIGH	1	7	1 to 320
AUTO LOW	1	8	1 to 320
FIXED	1	9	0 to 320 (0: laser out)

Measurement region setting

Parameter	Unit No.	Parameter No.	Setting range
Measurement start X coordinate	0	14	0 to 630
Measurement start Y coordinate	0	15	High-speed mode: 0 to 199 Standard, high-resolution mode: 0 to 399
Measurement end X coordinate	0	16	0 to 630
Measurement end Y coordinate	0	17	High-speed mode: 0 to 199 Standard, high-resolution mode: 0 to 399

Profile

Parameter	Unit No.	Parameter No.	Setting range
Average	0	7	0: 1, 1: 2, 2: 4, 3: 8, 4: 16, 5: 32, 6: 64 measurements
Smooth	0	8	1: OFF, 1: LOW, 2: MID, 3: HIGH
Interpolation	0	9	0: OFF, 1: ON
Number of interpolated pixels	0	11	0: 1, 1: 2, 2: 4, 3: 8, 4: 16, 5: ALL

Parameters during setting of measurement conditions

Region P

Parameter	Unit No.	Parameter No.	Setting range
P1 start	40+20 * (task-1)	4	0 to 630
P1 end	40+20 * (task-1)	5	0 to 630
P2 start	40+20 * (task-1)	11	0 to 630
P2 end	40+20 * (task-1)	12	0 to 630
P3 start	40+20 * (task-1)	18	0 to 630
P3 end	40+20 * (task-1)	19	0 to 630

Measurement point selection

Parameter	Unit No.	Parameter No.	Setting range
P1	40+20 * (task-1)	6	0: Average, 1: Peak, 2: Bottom
P2	40+20 * (task-1)	13	0: Average, 1: Peak, 2: Bottom
P3	40+20 * (task-1)	20	0: Average, 1: Peak, 2: Bottom

Edge selection

Parameter	Unit No.	Parameter No.	Setting range
P1 edge level	40+20 * (task-1)	7	High-speed mode: 0 to 199 Standard, high-resolution mode: 0 to 399
P2 edge level	40+20 * (task-1)	14	High-speed mode: 0 to 199 Standard, high-resolution mode: 0 to 399
P1 edge direction	40+20 * (task-1)	10	0: left → right (forward direction) 1: right → left (reverse direction)
P2 edge direction	40+20 * (task-1)	17	0: left → right (forward direction) 1: right → left (reverse direction)

Calculation

Parameter	Unit No.	Parameter No.	Setting range
Calculation task X	40+20 * (task-1)	4	0:OFF, 1: TASK1, 2: TASK2, 3: TASK3
Calculation task Y	40+20 * (task-1)	5	0:OFF, 1: TASK1, 2: TASK2, 3: TASK3
Calculation parameter m	40+20 * (task-1)	6	-10.0 to 10.0 ^(*1)
Calculation parameter n	40+20 * (task-1)	7	-10.0 to 10.0 ^(*1)
Calculation parameter K	40+20 * (task-1)	8	-999.999999 to 999.999999 ^(*1)

*1: Number of digits past the decimal point cannot be handled by the DATASET command. Input as follows:
 Example: -10.0 to 10.0 → -100 to 100
 -999.99999 to 999.99999 → -99999999 to 99999999

Note

The region that can set (P1 to P3, etc.) differs according to the measurement item.

Region	Height	2-pt step	3-pt step	Edge position	Edge width	Angle	Cross-sectional area
P1	Yes	Yes	Yes	Yes	Yes	Yes	Yes
P2		Yes	Yes		Yes	Yes	
P3			Yes				

Parameters during Scaling

Parameter	Unit No.	Parameter No.	Setting range
Span	41+20 * (task-1)	14	-4.0000 to 4.0000 ^(*1)
Offset	41+20 * (task-1)	15	-999.999999 to 999.999999 ^(*1)

*1: Number of digits past the decimal point cannot be handled by the DATASET command. Input as follows:
 Example: -4.0000 to 4.0000 → -40000 to 40000
 -999.999999 to 999.999999 → -999999999 to 999999999

Parameters in the ADJ mode

Judgment value

Parameter	Unit No.	Parameter No.	Setting range
Upper limit	47+20 * (task-1)	15	-999.999999 to 999.999999 (*1)
Lower limit	47+20 * (task-1)	14	-999.999999 to 999.999999 (*1)

Filter

Parameter	Unit No.	Parameter No.	Setting range
Average	43	3	0: 1, 1: 2, 2: 4, 3: 8, 4: 16, 5: 32, 6: 64, 7: 128, 8: 256 measurements
Smooth	42	3	0: OFF, 1: 3 (LOW), 2: 9 (MID), 3: 15 (HIGH) measurements

Zero reset

Parameter	Unit No.	Parameter No.	Setting range
Zero	45+20 * (task-1)	16	-999.999999 to 999.999999 (*1)

*1: Number of digits past the decimal point cannot be handled by the DATASET command. Input as follows:
Example: -999.99999 to 999.99999 → -99999999 to 99999999

Command Processing Time

The command processing time differs according to the command.

The following shows typical command processing times for the TRIG, MEASURE and PROFILE commands.

Command	Setting	Processing time	
		RS-232C (115200 bps)	USB
TRIG	Sensitivity: MULTI, CCD mode: NORMAL	280 ms	280 ms
	Sensitivity: MULTI, CCD mode: HI-RESO	550 ms	550 ms
	Sensitivity: MULTI, CCD mode: HI-SPEED	170 ms	170 ms
	Sensitivity: FIXED, CCD mode: NORMAL	20 ms	20 ms
	Sensitivity: FIXED, CCD mode: HI-RESO	30 ms	30 ms
	Sensitivity: FIXED, CCD mode: HI-SPEED	10 ms	10 ms
MEASURE	-	10 ms	10 ms
PROFILE 0 (profile output format: ASCII)	-	1500 ms	1000 ms
PROFILE 1 (profile output format: binary)	-	250 ms	30 ms

The command processing time above shows measurement values for the ECO monitor.

APPENDICES

Basic Knowledge for Operation	148
Specifications and External Dimensions	153
Error Messages and Corrective Actions	171
Menu List	172
List of Key Operations	174
Laser Safety	175
Requirements from Regulations and Standards	176
Updating the Firmware	185
INDEX	191

Basic Knowledge for Operation

CCD Mode

Expression of Images on the ZG Series

The ZG series uses a CCD (Charge Coupled Device) as the receiver element. CCDs are widely used in digital cameras and image scanners, for example. These semiconductor devices are highly accurate and highly reliable, and can achieve a high resolution as a sensor.

Pixel array and coordinate axes

Profiles acquired by the ZG series are expressed in the form of an array comprising small squares called “pixels” arranged in the horizontal and vertical directions. In the standard mode (631 x 100 pixels), acquired images are expressed by 631 pixels arranged in the horizontal direction and 100 pixels arranged in the vertical direction. With this array, the horizontal and vertical directions are called the “coordinate axes”, with the vertical (Z-axis) indicating the measurement result in the height direction, and the horizontal axis (X-axis) indicating the measurement result in the width direction.

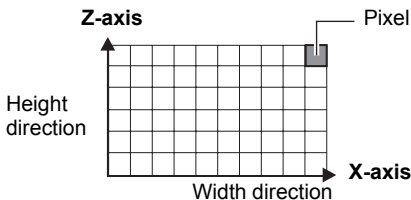

Number of pixels and resolution

To express the clarity on a digital camera or image scanner, the term “resolution” is used. The same approach is used on the ZG series, too. A “high resolution” expresses a sharp image, while a “low resolution” expresses a grainy image. Resolution is determined by the number of pixels per unit area. Though a sharper or higher resolution image is obtained, the more pixels there are per unit area, processing takes that much longer proportionate to the amount of information for that image.

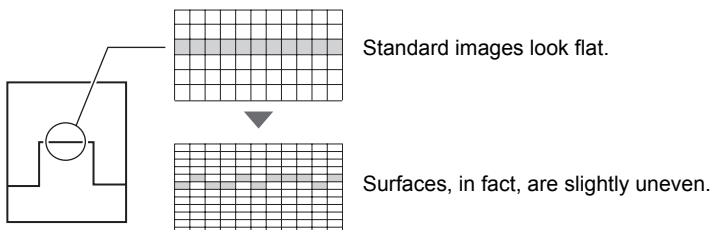

Three CCD Modes and Their Characteristics

The ZG series is provided with three CCD modes, “high-resolution mode,” “standard mode” and “high-speed mode.”

High-resolution mode: min. 16 ms
400 pixels

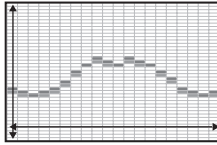

631 pixels

Standard mode: min. 8 ms
100 pixels

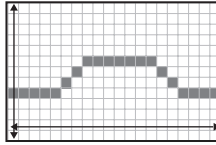

631 pixels

High-speed mode: min. 5 ms
50 pixels

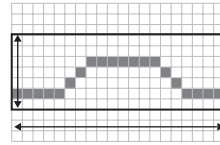

631 pixels

By quadrupling the number of pixels in the height direction

High-resolution measurement of the shape of measurement targets

By halving the number of pixels in the height direction

Shape measurement in fast line speed processes

Note

The measurement center distance does not change even if the mode is changed.

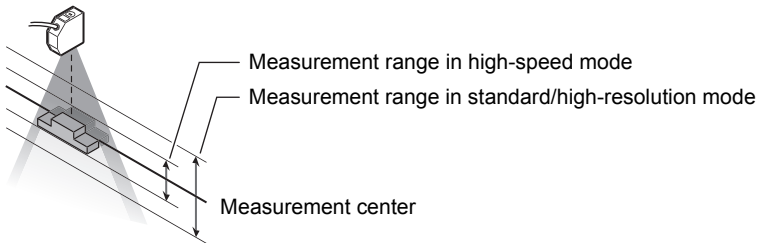

Hint When Setting the CCD Mode

The resolution in the width direction is common

The number of pixels in the X-axis is the same in all three modes. Accordingly, the resolution in the width direction does not change even if a different mode is selected. When measuring edge position or width, select the CCD mode based on the response time as the resolution will not change whichever mode is selected.

Sensitivity Adjustment and Measurement Operations

What is “Sensitivity Adjustment?”

It is relatively easy to measure the shape of a measurement target that receives a sufficient and uniform amount of light. However, in the case of measurement targets having a complex shape, inclined surfaces cause reflected light to decrease and areas of insufficient received light to occur. There are also cases where the amount of received light is insufficient or, alternatively, saturated caused by the color or material of the measurement target.

In this way, the sensitivity of the Sensor must be adjusted so that shapes are accurately captured even if the shape, color, material, etc. of the measurement target is influenced.

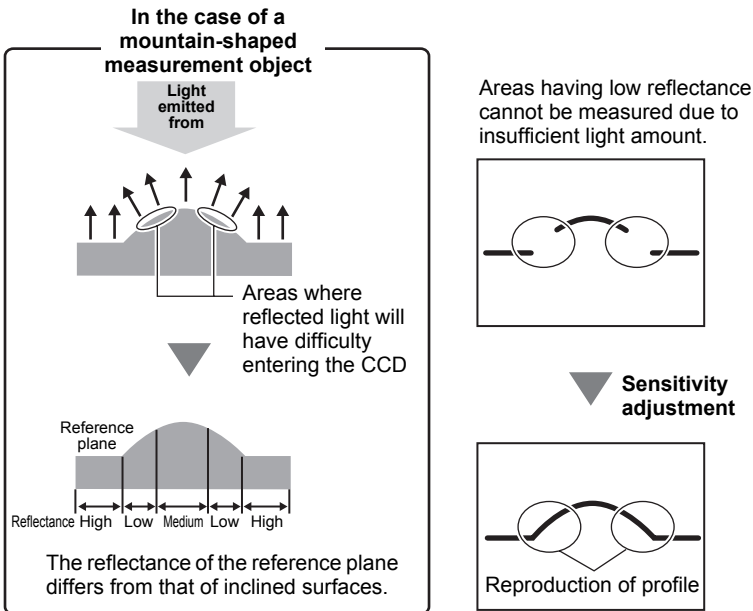

Sensitivity Adjustment Functions of the ZG Series

The ZG series is provided with three sensitivity adjustment functions.

MULTI sensitivity

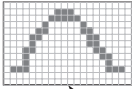

The optimum sensitivity is adjusted for individual line and combined to form the image.

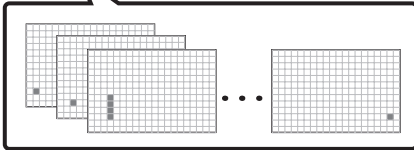

The amount of received light per individual line is judged and the appropriate sensitivity for each individual line is adjusted to accommodate for all kinds of shape, color and material.

The measurement target must be made stationary as time is required to capture multiple image frames while changing the sensitivity.

AUTO sensitivity

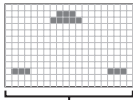

The optimum sensitivity common to all lines is adjusted.

The amount of received light for all lines is judged to adjust to the appropriate sensitivity for the entire area.

As sensitivity is batch-adjusted for all lines, the response is not as slow as that for MULTI sensitivity, so this mode is a generally applicable mode.

FIXED sensitivity

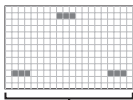

Sensitivity is fixed for all lines.

In this mode, a predetermined sensitivity is used. As sensitivity is not adjusted during measurement, response is fast, making it ideal for when a trigger is input at short intervals to perform measurement.

Guidelines for Selecting Sensitivity Adjustment and Measurement Triggers

The ZG series is provided with two measurement modes, “input of an external trigger to start measurement” and “continuous measurement without the need for input of a trigger.” Note, however, that the combinations of sensitivity and measurement trigger are restricted. Select which combination to use to suit your specific application.

To measure a shape at high precision

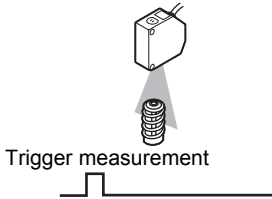

Use the combination “MULTI sensitivity + trigger input enabled.”

With MULTI sensitivity, the measurement target must be made stationary as time is required to adjust the sensitivity for each individual line.

To perform continuous measurement

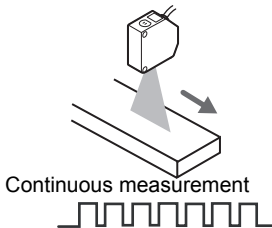

To perform measurement continuously or when the measurement target cannot be made stationary, use the combination “AUTO sensitivity + trigger disabled (continuous measurement).”

To judge shapes at high speed

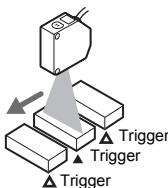

To measure by a trigger at short intervals



Use the combination “FIXED sensitivity + trigger enabled.” This combination has a short response time. Measurement can be performed with triggers input at short intervals.

Specifications and External Dimensions

Sensor

Specifications

ZG-WDS70/WDS22

Item		ZG-WDS70	ZG-WDS22
Optical system		Diffuse reflection	Diffuse reflection Regular reflection
Measurement center distance (height direction)		210 mm	100 mm 94 mm
Measurement range	Height direction (in standard mode)	±30 mm	±12 mm ±10 mm
	Width direction	70 mm typ.	22 mm typ.
Resolution	Height direction ⁽¹⁾	10 μm	3 μm
	Width direction ⁽⁵⁾	111 μm (70 mm x 631 pix)	35 μm (22 mm x 631 pix)
Linearity (height direction) ⁽²⁾		±0.5% F.S.	
Temperature characteristics ⁽³⁾		0.1% F.S./°C	
Light source	Type	Visible semiconductor laser	
	Wavelength	658 nm	
	Output	Max. output 5 mW, max. exposure (without use of optical equipment) 1 mW	
	Laser class	Class 2M	
Beam shape (at measurement center distance) ⁽⁴⁾		120 μm x 75 mm typ.	60 μm x 45 mm typ.
LED indicator		STAND BY: Turns ON when laser emission is ready (green) LD_ON: Turns ON when laser is emitted (green)	
Measurement target		Non-transparent object	
Environmental performance	Ambient operating illumination	Illumination on received light surface 1000 lx max. (incandescent light)	
	Ambient temperature	Operating: 0 to +50°C Storage: -15 to +60°C (with no icing or condensation)	
	Ambient humidity	Operating and storage: 35% to 85%RH (with no condensation)	
	Degree of protection	IP66 (IEC60529)	
	Vibration resistance (durability)	10 to 150 Hz (at a single-amplitude of 0.35 mm) for 80 minutes each in the X, Y, and Z directions	
	Shock resistance (destructive)	150 m/s ² 3 times each in six directions (up/down, left/right, forward/backward)	
Material		Case: aluminum die-cast, Front cover: glass Cable sheath: heat-resistant PVC, Connector: Zinc alloy and brass	
Cable length		0.5 m, 2 m	
Minimum bending radius		68 mm	
Weight		Approx. 650 g	Approx. 500 g
Accessories		Laser warning labels (IEC60825-1 2 sheets), ferrite core (1 p'ce), Instruction Sheet	

ZG-WDS8T/WDS3T

Item		ZG-WDS8T		ZG-WDS3T	
Optical system		Diffuse reflection	Regular reflection	Regular reflection	Diffuse reflection
Measurement center distance (height direction)		50 mm	44 mm	20 mm	5.2 mm
Measurement range	Height direction (in standard mode)	±3 mm	±2 mm	±0.5 mm	±0.4 mm
	Width direction	8 mm typ.		3 mm typ.	
Resolution	Height direction ^(*1)	1 μm		0.25 μm	
	Width direction ^(*5)	13 μm (8 mm x 631 pix)		5 μm (3 mm x 631 pix)	
Linearity (height direction) ^(*2)		±0.5% F.S.			
Temperature characteristics ^(*3)		0.1% F.S./°C			
Light source	Type	Visible semiconductor laser			
	Wavelength	658 nm		650 nm	
	Output	Max. output 5 mW, max. exposure (without use of optical equipment) 1 mW		1 mW max.	
	Laser class	Class 2M		Class 2	
Beam shape (at measurement center distance) ^(*4)		30 μ x 24 mm typ.		25 μ x 4 mm typ.	
LED indicator		STAND BY: Turns ON when laser emission is ready (green) LD_ON: Turns ON when laser is emitted (green)			
Measurement target		Non-transparent object			
Environmental performance	Ambient operating illumination	Illumination on received light surface 1000 lx max. (incandescent light)			
	Ambient temperature	Operating: 0 to +50°C Storage: -15 to +60°C (with no icing or condensation)			
	Ambient humidity	Operating and storage: 35% to 85%RH (with no condensation)			
	Degree of protection	IP66 (IEC60529)		IP64 (IEC60529)	
	Vibration resistance (durability)	10 to 150 Hz (at a single-amplitude of 0.35 mm) for 80 minutes each in the X, Y, and Z directions			
	Shock resistance (destructive)	150 m/s ² 3 times each in six directions (up/down, left/right, forward/backward)			
Material		Case: aluminum die-cast, Front cover: glass Cable sheath: heat-resistant PVC, Connector: Zinc alloy and brass			
Cable length		0.5 m, 2 m			
Minimum bending radius		68 mm			
Weight		Approx. 500 g		Approx. 300 g	
Accessories		Laser warning labels (IEC60825-1 2 sheets), ferrite core (1 p'ce), Instruction Sheet			

*1: When an OMRON-standard measurement target is placed at the measurement center distance, and its average height of all lines is measured. Conditions are as follows. Note that the resolution performance may not be satisfied in the presence of strong magnetic fields.

Model	CCD mode	Average number of times	Measurement target	
			Regular reflection	Diffuse reflection
ZG-WDS70/WDS22/WDS8T	Standard mode	16 times	OMRON-standard white alumina ceramic	
ZG-WDS3T	Standard mode	32 times	OMRON-standard specular object	OMRON-standard diffuse reflecting object

*2: This is the error in relationship to an ideal straight line when an OMRON-standard measurement object was measured to calculate the average height of all lines. The CCD mode is the standard mode. Linearity sometimes changes according to the measurement target.

Model	Measurement target	
	Regular reflection	Diffuse reflection
ZG-WDS70/WDS22/WDS8T	OMRON-standard white alumina ceramic	
ZG-WDS3T	OMRON-standard specular object	OMRON-standard diffuse reflecting object

- *3: Value obtained when the Sensor and measurement target are fixed with an aluminum jig. The CCD mode is the standard mode.
- *4: Defined as $1/e^2$ (13.5%) of the central light intensity. Leakage of light is also present in areas other than those defined. So, the beam diameter is sometimes influenced where the reflectance of the area surrounding the measurement target is higher than that of the measurement target itself.
- *5: This is the calculated resolution when measuring the edge position and edge width.

External Dimensions

ZG-WDS70

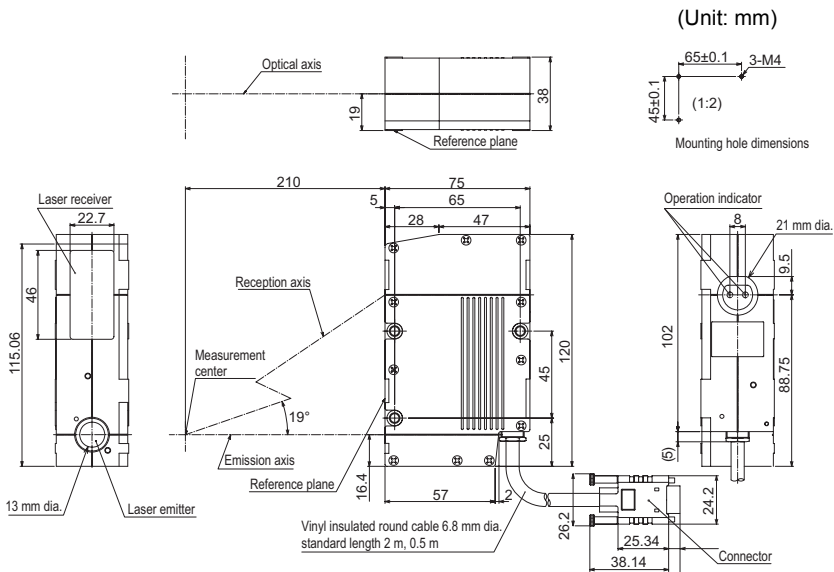

ZG-WDS8T/WDS22

- When used for diffuse reflection

(Unit: mm)

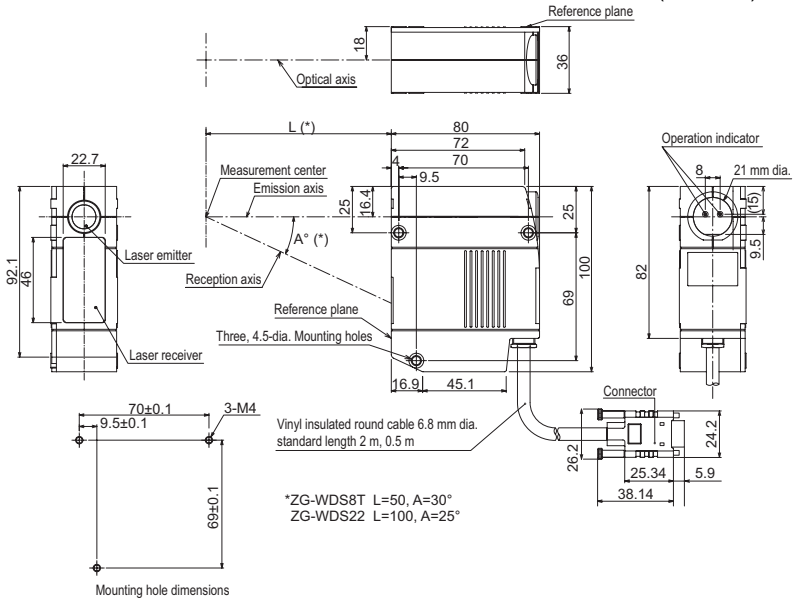

- When used for regular reflection (ZG-WDS8T)

(Unit: mm)

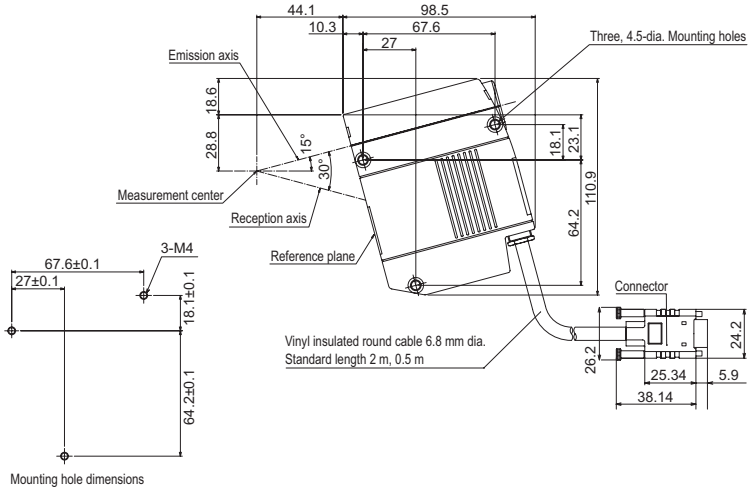

- When used for regular reflection (ZG-WDS22)

(Unit: mm)

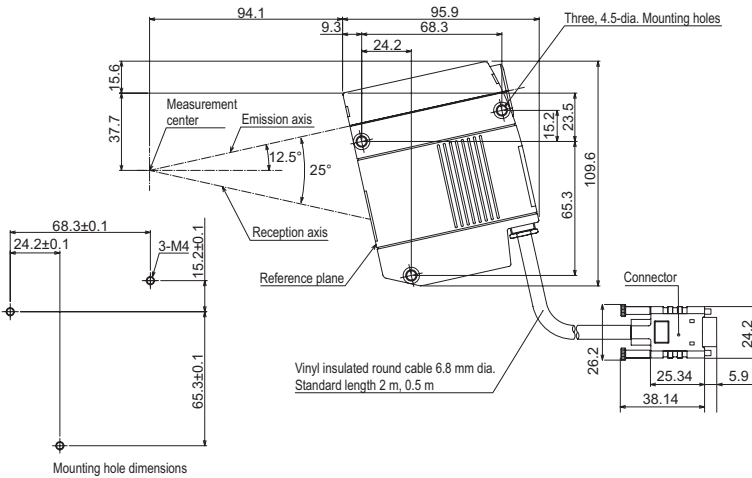

ZG-WDS3T

- When used for regular reflection

(Unit: mm)

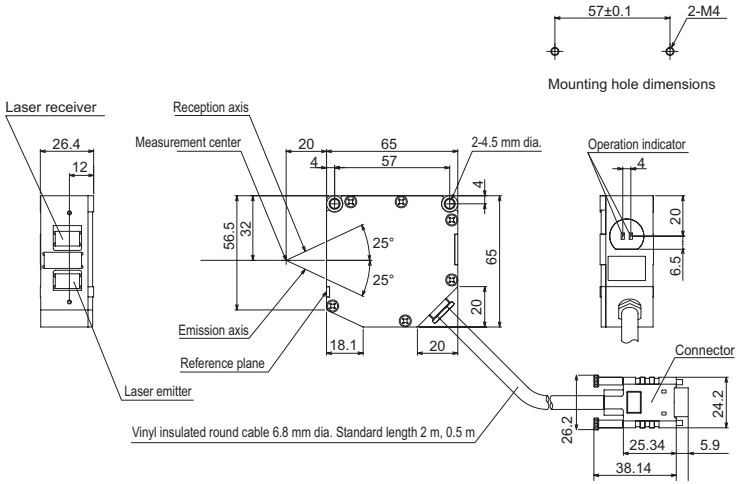

- When used for diffuse reflection

(Unit: mm)

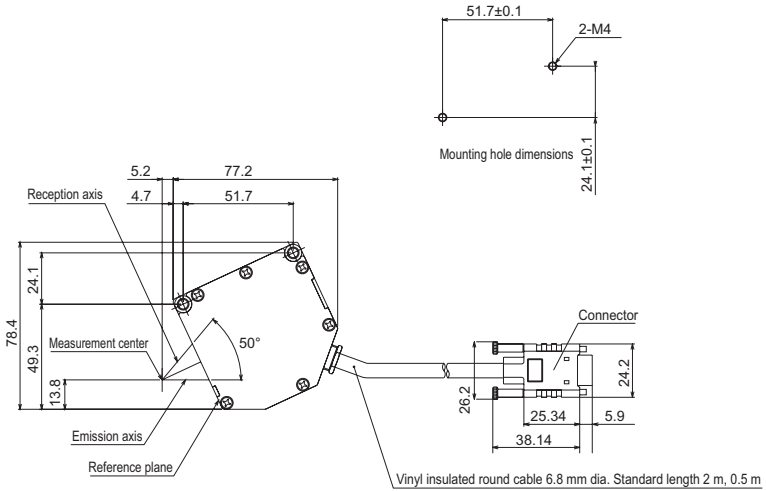

Adjusting Mutual Interference

When using two or more Sensors next to each other, mutual interference will not occur if other Sensor beams are outside the shaded areas in the following diagrams.

ZG-WDS70

(Unit: mm)

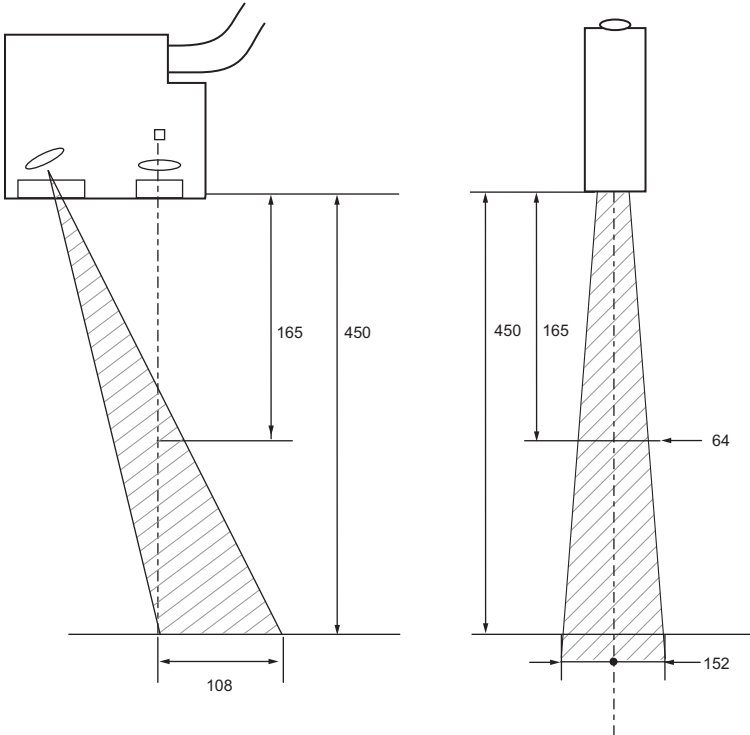

ZG-WDS3T

(Unit: mm)

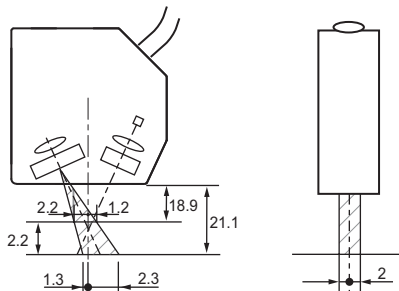

ZG-WDS22

(Unit: mm)

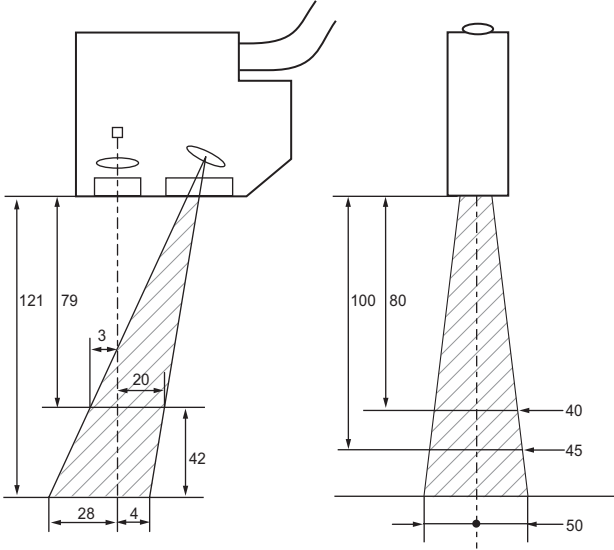

ZG-WDS8T

(Unit: mm)

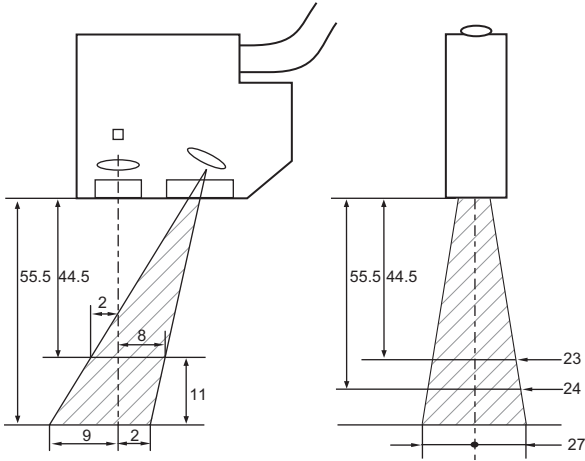

Controller

Specifications

Item		ZG-WDC11/WDC11A	ZG-WDC41/WDC41A
I/O type		NPN type	PNP type
Number of connected Sensors		1 Sensor/Controller	
Measurement cycle ^(*)		16 ms (high-resolution mode), 8 ms (standard mode), 5 ms (high-speed mode)	
Minimum display unit		10 nm	
Display range		-999.99999 to 999.99999	
Display	LCD monitor	1.8" TFT color LCD (557 x 234 pix)	
	Indicator	<ul style="list-style-type: none"> Individual task judgment indicator (orange): T1, T2, T3, T4 Laser indicator (green): LD ON Zero Reset indicator (green): ZERO Trigger indicator (green): TRIG 	
External I/F	I/O signal wire	Analog output	Selectable from voltage/current (selected by slide switch on base) <ul style="list-style-type: none"> At voltage output: -10 to +10V Output impedance: 40Ω At current output: 4 to 20 mA Max. load resistance: 300Ω
		Judgment (ALL-PASS/NG/ERROR)	NPN open-collector 30 VDC, 50 mA max. Residual voltage 1.2 V max.
		Trigger auxiliary output (ENABLE/GATE)	PNP open-collector, 50 mA max. Residual voltage 1.2 V max.
		Laser stop input (LD OFF)	ON: Short-circuited with 0 V terminal or 1.5 V max. OFF: Open (leakage current: 0.1 mA max.)
		Zero reset input (ZERO)	ON: Supply voltage short-circuited or within supply voltage -1.5 V max. OFF: Open (leakage current: 0.1 mA max.)
		Measurement trigger input (TRIG)	
	Bank switching input (BANK A, B)		
Serial I/O	USB2.0	1 port, FULL SPEED [12 Mbps], MINI-B	
	RS-232C output	1 port, max. 115,200 bps	
Main functions	Number of registered setups	4 banks	
	Sensitivity adjustment function	MULTI/AUTO/FIXED	
	Measurement items (ITEM)	Height/2-point step/3-point step Edge position/Edge width Angle/Cross-sectional area/Calculation (max. 4 items simultaneously selectable)	
	Trigger mode	External trigger/continuous	
Ratings	Power supply voltage	21.6 V to 26.4 VDC (including ripple)	
	Current consumption	0.8 A max.	
	Insulation resistance	Across all lead wires and controller case: 20 MΩ (by 250 V megger)	
	Dielectric strength	Across all lead wires and controller case, 1000 VAC, 50/60 Hz, 1 min	

Item		ZG-WDC11/WDC11A	ZG-WDC41/WDC41A
Operation environment robustness	Ambient temperature	Operating: 0 to +50 °C Storage: -15 to +60 °C (with no icing or condensation)	
	Ambient humidity	Operating and storage: 35% to 85%	
	Degree of protection	IP20 (IEC60529)	
	Vibration resistance (durability)	Vibration frequency: 10 to 150 Hz Single-amplitude: 0.35 mm Acceleration: 50 m/s ² 10 times for 8 minutes	
	Shock resistance (destructive)	150 m/s ² 3 times each in 6 directions (up/down, left/right, forward/backward)	
Material	Case: Polycarbonate (PC), Cable sheath: heat-resistant PVC		
Cable length	2 m		
Weight	Approx. 300 g (including cable) (when packaged: approx. 450 g)		
Accessories	ZG-WDC_1: ferrite core (large) (1 p'ce), Insure Lock (1 p'ce), Instruction Sheet ZG-WDC_1A: ferrite core (large) (1 p'ce), ferrite core (small) (2 p'ces), Insure Lock (1 p'ce), Instruction Sheet, setup software (CD-ROM), USB cable (1 m)		

*1: The measurement cycle stated here is for when the FIXED/AUTO sensitivity modes are selected. The measurement cycle increases when the MULTI sensitivity mode is selected and according to other settings. Check the actual measurement cycle by the ECO monitor in the RUN mode.

Controller signal statuses

Input specifications

	FUN mode	ADJ mode	RUN mode	
			Continuous (trigger disabled)	Trigger
LD-OFF	Enabled	Enabled	Enabled	Enabled
ZERO-RESET	Disabled	Disabled	Enabled	Enabled
TRIG	Disabled	Disabled	Disabled	Enabled

Output specifications

	FUN mode	ADJ mode	RUN mode	
			Continuous (trigger disabled)	Trigger
ALL-PASS	OFF	OFF	ON/OFF	ON/OFF
NG	OFF	OFF	ON/OFF	ON/OFF
ERROR	OFF	OFF	ON/OFF	ON/OFF
GATE	OFF	OFF	ON/OFF	ON/OFF
ENABLE	OFF	OFF	ON	ON/OFF
Analog	Clamp value	Clamp value	Measurement value/clamp value	
Parallel Output Unit	OFF	OFF	Measurement value/status output (*1)	

*1: For details, see "Chapter 4 CONNECTION WITH EXTERNAL DEVICE" p.103.

Export and Trade Control Ordinances

The programs incorporated into ZG-WDC11/WDC41 Controllers are considered technology under the Foreign Exchange and Foreign Trade Laws in Japan and therefore require a license for export from Japan.

Note, however, that permission for service transactions is not required in accordance with the stipulations of Trade Ministry Directive, Clause No.9, Item No.1, Sub-item 10(b).

External Dimensions

ZG-WDC11/WDC41

(Unit: mm)

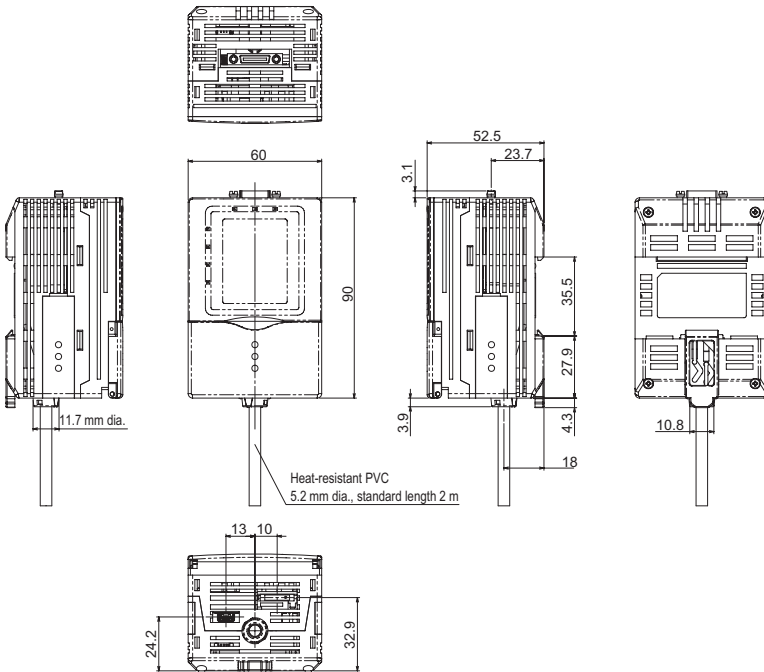

Accessories

Panel Mount Adapters

ZS-XPM1/XPM2

When mounting on a panel

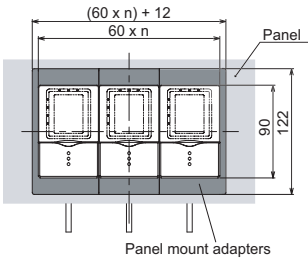

* When multiple units are used in a line

Panel cutout dimensions

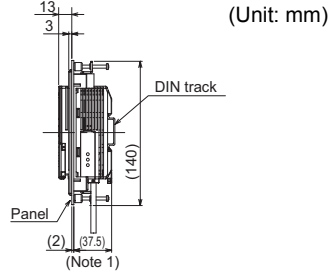
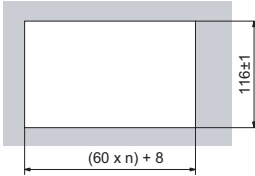

Note 1: Dimensions when the panel thickness is 2.0 mm

Important

When mounting multiple Controllers on a panel, be sure to install the DIN track on the rear side of the Controllers for support. (Note, however, that the Controllers cannot be ganged-mounted.)

Item	ZS-XPM1 (for 1st unit)	ZS-XPM2 (for 2nd unit onwards)
Appearance		
Applicable Controller	ZG-WDC series	
Vibration resistance (durability)	10 to 150 Hz (0.7 mm double amplitude), 80 min each in X, Y, and Z directions	
Shock resistance (destructive)	300 m/s ² 3 times each in six directions (up/down, left/right, forward/backward)	
Material	Polycarbonate (PC), etc.	
Weight	Approx. 50 g	
Accessories	Instruction Sheet	

Extension Cable

Extension cable

ZG-XC__CR

(Unit: mm)

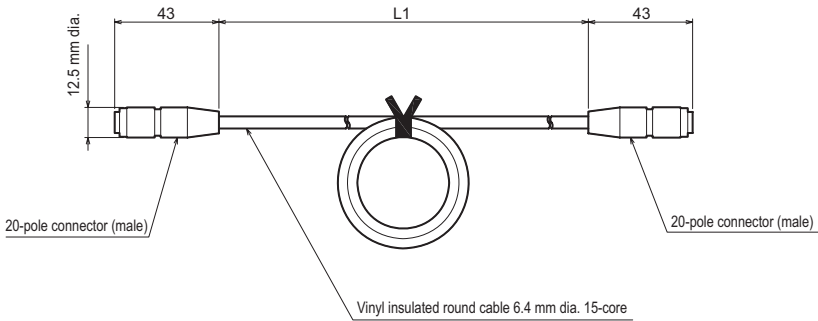

L1: ZG-XC25CR: 25 m
 ZG-XC15CR: 15 m
 ZG-XC8CR: 8 m
 ZG-XC3CR: 3 m

Item	ZG-XC25CR	ZG-XC15CR	ZG-XC8CR	ZG-XC3CR
Cable length	25 m	15 m	8 m	3 m
Applicable Sensor/Controller	ZG series			
Ambient temperature	Operating: 0 to +50°C, Storage: -15 to +60°C (with no icing or condensation)			
Ambient humidity	Operating and storage: 35% to 85% (with no condensation)			
Vibration resistance (durability)	10 to 150 Hz (0.7 mm double amplitude), 80 min each in X, Y, and Z directions			
Shock resistance (destructive)	300 m/s ² 3 times each in six directions (up/down, left/right, forward/backward)			
Material	Cable sheath: Heat-resistant vinyl chloride (PVC)			
Weight	Approx. 1.4 kg	Approx. 1.0 kg	Approx. 0.5 kg	Approx. 0.2 kg
Accessories	Ferrite cores (2 p'ces), Insure Lock (2 p'ces), Instruction Sheet			

Digital equalizer connection cable

ZG-XC02D

(Unit: mm)

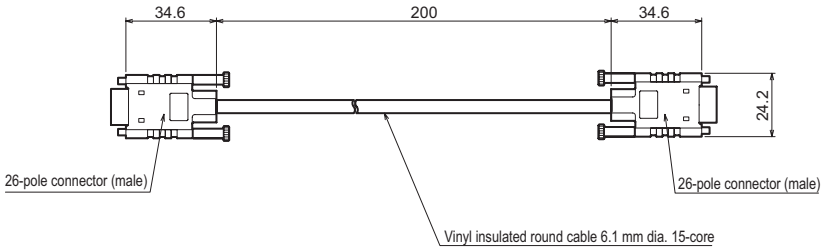

Item	ZG-XC02D
Applicable Sensor/Controller	ZG series
Ambient temperature	Operating: 0 to +50°C, Storage: -15 to +60°C (with no icing or condensation)
Ambient humidity	Operating and storage: 35% to 85% (with no condensation)
Vibration resistance (durability)	10 to 150 Hz (0.7 mm double amplitude), 80 min each in X, Y, and Z directions
Shock resistance (destructive)	300 m/s ² 3 times each in six directions (up/down, left/right, forward/backward)
Material	Cable sheath: Heat-resistant vinyl chloride (PVC)
Weight	Approx. 50 g
Accessories	Ferrite core (2 p'ces), Instruction Sheet

ZG-XEQ

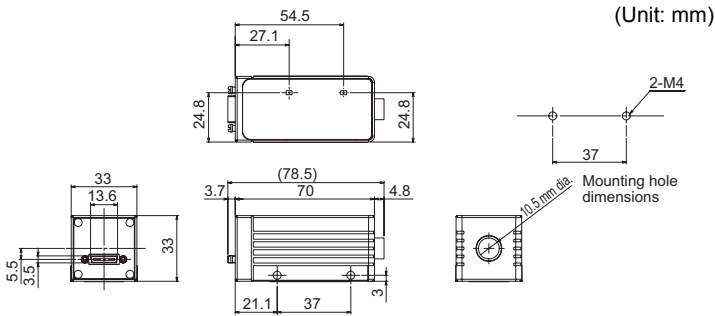

Item	ZG-XEQ
Applicable Sensor/Controller	ZG series
Ambient temperature	Operating: 0 to +50°C, Storage: -15 to +60°C (with no icing or condensation)
Ambient humidity	Operating and storage: 35% to 85% (with no condensation)
Vibration resistance (durability)	10 to 150 Hz (0.7 mm double amplitude), 80 min each in X, Y, and Z directions
Shock resistance (destructive)	300 m/s ² 3 times each in six directions (up/down, left/right, forward/backward)
Material	Case: Aluminum die-cast
Degree of protection	IP20 (IEC60529)
Weight	Approx. 120 g
Accessories	Instruction Sheet

RS-232C Cable

ZS-XPT2 (for connecting to programmable controller/programmable terminal)

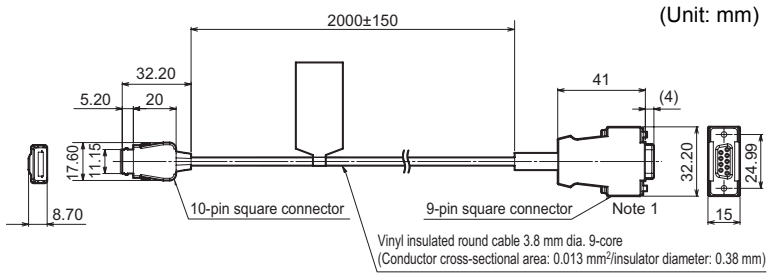

Note 1: Plug type connector

ZS-XRS2 (for connecting to a personal computer)

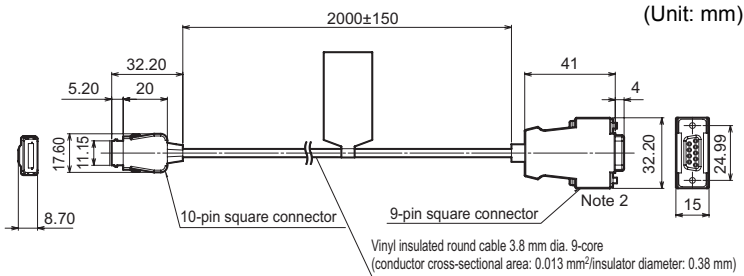

Note 2: Socket type connector

Item	ZS-XRS2	ZS-XPT2
Applicable Controller	ZG series, ZS series	
Ambient temperature	Operating: 0 to +50°C, Storage: -15 to +60°C (with no icing or condensation)	
Ambient humidity	Operating and storage: 35% to 85% (with no condensation)	
Dielectric strength	1,000 VAC, 50/60 Hz for 1 min	
Insulation resistance	100 MΩ (by 500 VDC megger)	
Vibration resistance (durability)	10 to 150 Hz (0.7 mm double amplitude), 80 min each in X, Y, and Z directions	
Shock resistance (destructive)	300 m/s ² 3 times each in six directions (up/down, left/right, forward/backward)	
Material	Cable sheath: Heat-resistant vinyl chloride (PVC)	
Weight	Approx. 50 g	
Accessories	Instruction Sheet	

Real-Time Parallel Output Unit

ZG-RPD11/RPD41

(Unit: mm)

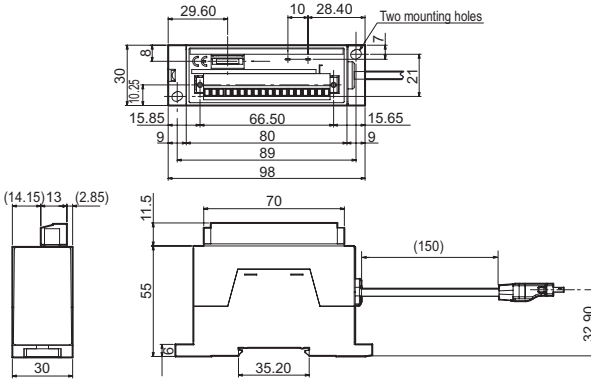

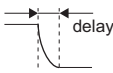
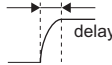
Item		ZG-RPD11	ZG-RPD41
I/O type		NPN type	PNP type
Data output system		16-bit parallel open collector output	
Data format		The measurement value is converted to 16-bit binary data (2's complement) before it is output (signal names: D0 to D15).	
Synchronization signal		Synchronization signal for notifying data determination timing (signal name: GATE). 1-bit open collector output	
Parallel output	Judgment output	NPN open collector, 30 VDC max., 50 mA max., residual voltage 1.2 or less	PNP open collector, 50 mA max., residual voltage 1.2 or less
	Measurement output		
RS-232C output		1 port, max. 115,200 bps	
Status indicators		<ul style="list-style-type: none"> • PWR indicator (green) → Lights when ZG-RPD is energized. • ERR indicator (red) → Lights up when an energizing current of 20 mA or more flows to 1 bit or more of the open collector output (data output: 16 bits, GATE: 1 bit) 	
Circuit internal power supply voltage		24 VDC and 3.3 VDC. Power is supplied from ZG-WDC_1 via exclusive connector.	
Current consumption		0.5 A max.	
Insulation resistance		Connected to ZG-WDC_1, across all lead wires and controller case of the ZG-WDC_1: 20 MΩ (by 250 V megger)	
Dielectric strength		Connected to ZG-WDC_1, across all lead wires and controller case of the ZG-WDC_1: 1000 VAC, 50/60 Hz 1 min	
Vibration resistance (durability)		10 to 150 Hz (0.7 mm double amplitude), 80 min each in X, Y, and Z directions	

Item	ZG-RPD11	ZG-RPD41
Shock resistance (destructive)	300 m/s ² 3 times each in six directions (up/down, left/right, forward/backward)	
Ambient temperature	Operating: 0 to +50°C, Storage: -15 to +60°C (with no icing or condensation)	
Ambient humidity	Operating and storage: 35% to 85% (with no condensation)	
Material	Case: ABS	
Weight	Approx. 130 g (excluding packing materials and accessories)	
Accessories	Instruction Sheet	

Error Messages and Corrective Actions

The following shows error messages that are displayed on the LCD screen and their corrective actions.

Error message	Probable cause	Reference
AUTO SETTING FAILED	Automatic setting cannot be executed on the current region. Set the region again referring to the manual.	p.60
AUTO SCALING DO NOT OPERATE AB. THIS ITEM	The auto-scaling function does not operate with cross-sectional area and angle.	p.71
REFERENCE REGISTRTION FAILED	Failed to register the reference for position correction. 1. Check whether or not teaching of the profile has been successful. 2. Check whether or not the edge level has been set correctly.	p.83
NO MEASUREMENT POINT	There is no measurement target. Place the measurement target inside the measurement range.	p.72
SYSTEM ERROR VDIN END ERR	Communication with the Sensor is not possible. 1. Check the cable connection with the Sensor. 2. Check the cable for breaks. If there is no problem with the above, a probable cause is a Sensor or Controller malfunction.	p.33
SCALING FAILED	The scaling correction range was exceeded. Check the input values.	p.71
SET VALUE ERROR HIGH, LOW	Review the setting values so that HIGH>LOW.	p.51
SET VALUE ERROR MAX, MIN	Review the setting values so that MAX>MIN.	p.88 p.90
CLEAR BANK DATA	When the CCD mode is changed, all bank data is initialized.	p.97 p.149
Sensor IS NOT CONNECTED (*1)	Communication with the Sensor is not possible. 1. Check the cable connection with the Sensor. 2. Check the cable for breaks. If there is no problem with the above, a probable cause is a Sensor or Controller malfunction.	p.33

*1: When the Sensor is not connected, the Controller screen darkens, making the error message no longer visible.

Menu List

Enabled only in the expert menu

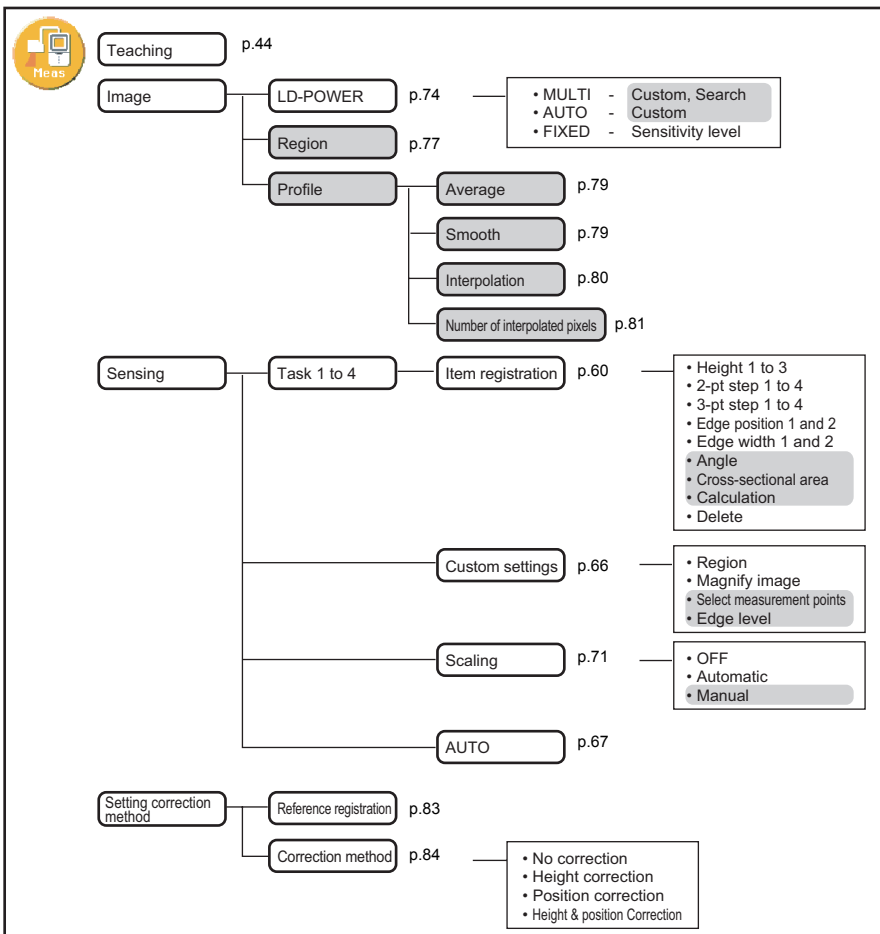







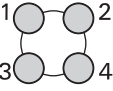

	Analog	Task	p.87	I/O line	Bank	p.93
		Scaling	p.88		Trigger	p.93
		Clamp	p.91		GATE period	p.94
		Correction	p.90		GATE delay	p.94
	RPD output	Output	p.92	Serial communication	AUTO	p.95
		Task	p.92		Output assignments	p.96
		Display number of digits past the decimal point	p.93			

	Save	p.101	Sensor data	p.99
	Initialization	p.41	Number of digits past the decimal point	p.99
	Sensor installation	p.97	ECO mode	p.100
	CCD mode	p.97	Information	p.100
	RS-232C	p.98	Language	p.100
	Node	p.98	Icon color	p.101

List of Key Operations

The functions of keys differ according to the currently selected mode.

Key		Description		
		FUN mode	ADJ mode	RUN mode
Function keys		These keys directly set the icon and No. preceding the items displayed on the LCD screen.		These keys can be used as shortcut keys.  p.55
←LEFT key →RIGHT key	 	Function changes depending on the settings. • Scrolls the page. • Selects the digit of numerical values. • Moves the cursor. • Specifies the region.		-
↑UP key ↓DOWN key	 	Moves the cursor and changes the numerical value.	Switches the displayed task.	
MENU/VIEW key		Displays the top menu.	Switches the display content.	
SET key		Applies the item you are setting up.	Executes a zero reset.	
ESC key		Returns to the previous menu.	Hold down for at least two seconds to cancel a zero reset.	

Laser Safety

Various safety standards regarding laser products are stipulated depending on the country of use.

Take safety measures according to each standard.

Classification

Standards and classification (*1)		Maximum Output of Laser Beam
JIS C 6802 2005 (Japan), EN60825/IEC60825-1 (Europe)	FDA (the United States)	
ZG-WDS70/WDS22/WDS8T: Class 2M	(scheduled for notification)	Max. output 5 mW Max. exposure (when optical device is not used) 1 mW
ZG-WDS3T: Class 2		Max. output 1 mW

*1 For products exported to the countries other than Japan and Europe, different safety standards are applied according to the countries. Check the LED safety regulations and standards of the relevant country.

Label Replacement

The warning label written in Japanese is affixed to the Sensor unit. For countries other than Japan, warning labels must be replaced by English ones (supplied with the Sensor unit)

EN60825/IEC60825-1 (Europe)

- Class 2



- Class 2M

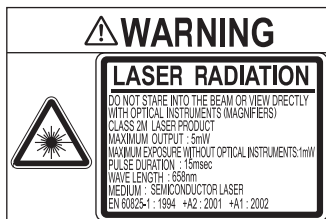

Requirements from Regulations and Standards

Summary of Requirements to Manufactures

For Europe

EN 60825-1 “Safety of Laser Products, Equipment Classification, Requirements and User’s Guide”

Summary of Manufacturer’s Requirements

Requirements subclause	Classification						
	Class 1	Class 1M	Class 2	Class 2M	Class 3R	Class 3B	Class 4
Description of hazard class	Safe under reasonably foreseeable conditions	As for Class 1 except may be hazardous if user employs optics	Low power; eye protection normally afforded by aversion responses	As for Class 2 except may be more hazardous if user employs optics	Direct intrabeam viewing may be hazardous	Direct intrabeam viewing normally hazardous	High power; diffuse reflections may be hazardous
Protective housing	Required for each laser product; limits access necessary for performance of functions of the products						
Safety interlock in protective housing	Designed to prevent removal of the panel until accessible emission values are below that for Class 3R			Designed to prevent removal of the panel until accessible emission values are below that for Class 3B			
Remote control	Not required					Permits easy addition of external interlock in laser installation	
Key control	Not required					Laser inoperative when key is removed	
Emission warning device	Not required				Give audible or visible warning when laser is switched on or if capacitor bank of pulsed laser is being charged. For Class 3R only, applies invisible radiation is emitted		
Attenuator	Not required					Give means beside the On/Off switch to temporarily to block beam	
Location controls	Not required				Controls so located that there is no danger of exposure to AEL above Classes 1 or 2 when adjustments are made		
Viewing optics	Not required	Emission from all viewing systems must be below Class 1M AEL					
Scanning	Scan failure shall not cause product to exceed its classification						
Class label	Required wording		Figures A required wording				

Requirements subclause	Classification						
	Class 1	Class 1M	Class 2	Class 2M	Class 3R	Class 3B	Class 4
Aperture label	Not required				Specified wording required		
Service entry label	Required as appropriate to the class of accessible radiation						
Override interlock label	Required under certain conditions as appropriate to the class of laser used						
Wavelength range label	Required for certain wavelength ranges						
LED label	Make required word substitutions for LED products						
User information	Operation manuals must contain instructions for safe use. Additional requirement apply for Class 1M and Class 2M						
Purchasing and service information	Promotion brochures must specify product classification; service manuals must contain safety information						

- Note:**
1. This table is intended to provide a convenient summary of requirements. See text of this standard for complete requirements.
 2. For the safety medical laser products, IEC 60601-2-22 applies
 3. AEL: Accessible Emission Limit
The maximum accessible emission level permitted within a particular class. For your reference, see ANSI Z136.1-1993, Section 2.

Symbol and border: black
Background: yellow

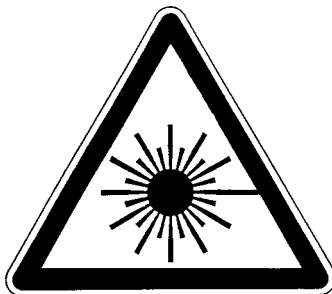

Figure A Warning label - Hazard symbol

Legend and border: black
Background: yellow

For U.S.A

FDA (Compliance Guide for Laser Products, 1985, according to 21 CFR1040.10)

Requirements	Class (see note 1)					
	I	IIa	II	IIIa	IIIb	IV
Performance (all laser products)						
Protective housing	R (see note 2)	R (see note 2)	R (see note 2)	R (see note 2)	R (see note 2)	R (see note 2)
Safety interlock	R (see notes 3,4)	R (see notes 3,4)	R (see notes 3,4)	R (see notes 3,4)	R (see notes 3,4)	R (see notes 3,4)
Location of controls	N/A	R	R		R	R
Viewing optics	R	R	R	R	R	R
Scanning safeguard	R	R	R	R	R	R
Performance (laser systems)						
Remote control connector	N/A	N/A	N/A	N/A	R	R
Key control	N/A	N/A	N/A	N/A	R	R
Emission indicator	N/A	N/A	R	R	R (see note 10)	R (see note 10)
Beam attenuator	N/A	N/A	R	R	R	R
Reset	N/A	N/A	N/A	N/A	N/A	R (see note 13)
Performance (specific purpose products)						
Medical	S	S	S	S (see note 8)	S (see note 8)	S (see note 8)
Surveying, leveling, alignment	S	S	S	S	NP	NP
Demonstration	S	S	S	S	S (see note 11)	(see note 11)
Labeling (all laser products)						
Certification & identification	R	R	R	R	R	R
Protective housing	D (see note 5)	D (see note 5)	D (see note 5)	D (see note 5)	D (see note 5)	D (see note 5)
Aperture	N/A	N/A	R	R	R	R
Class warning	N/A	R (see note 6)	R (see note 7)	R (see note 9)	R (see note 12)	R (see note 12)
Information (all laser products)						
User information	R	R	R	R	R	R
Product literature	N/A	R	R	R	R	R
Service information	R	R	R	R	R	R

Abbreviations:

- R:** Required.
N/A: Not applicable.
S: Requirements: Same as for other products of that Class. Also see footnotes.
NP: Not permitted.
D: Depends on level of interior radiation.

Footnotes:

- Note 1:** Based on highest level accessible during operation.
Note 2: Required wherever & whenever human access to laser radiation above Class I limits is not needed for product to perform its function.
Note 3: Required for protective housings opened during operation or maintenance, if human access thus gained is not always necessary when housing is open.
Note 4: Interlock requirements vary according to Class of internal radiation.
Note 5: Wording depends on level & wavelength of laser radiation within protective housing.
Note 6: Warning statement label.
Note 7: CAUTION logotype.
Note 8: Requires means to measure level of laser radiation intended to irradiate the body.
Note 9: CAUTION if 2.5 mW cm^2 or less, DANGER if greater than 2.5 mW cm^{-2} .
Note 10: Delay required between indication & emission.
Note 11: Variance required for Class IIb or IV demonstration laser products and light shows.
Note 12: DANGER logotype.
Note 13: Required after August 20, 1986.

Summary of Requirements to User

For Europe

EN 60825-1

Requirements subclause	Classification						
	Class 1	Class 1M	Class 2	Class 2M	Class 3R	Class 3B	Class 4
Laser safety officer	Not required but recommended for applications that involve direct viewing of the laser beam				Not required for visible emission Required for non-visible emission	Required	
Remote interlock	Not required					Connect to room or door circuits	
Key control	Not required					Remove key when not in use	
Beam attenuator	Not required					When in use prevents inadvertent exposure	
Emission indicator device	Not required				Indicates laser is energized for non-visible wavelengths	Indicates laser is energized	
Warning signs	Not required					Follow precautions on warning signs	
Beam path	Not required	Class 1M as for Class 3B (see note 2)	Not required	Class 2M as for Class3B (see note 3)	Terminate beam at end of useful length		
Specular reflection	No requirements	Class 1M as for Class 3B (see note 2)	No requirements	Class 2M as for Class3B (see note 3)	Prevent unintentional reflections		
Eye protection	No requirements				Not required for visible emission Required for non-visible emission	Required if engineering and administrative procedures not practicable and MPE exceeded	
Protective clothing	No requirements					Sometimes required	Specific requirements
Training	No requirements	Class 1M as for Class 3R (see note 2)	No requirements	Class 2M as for Class3R (see note 3)	Required for all operator and maintenance personnel		

- Note:**
1. This table is intended to provide a convenient summary of requirements. See text of this standard for complete precautions.
 2. Class 1M laser products that failed condition 1 of table10 of the standard. Not required for Class 1M laser products that failed condition 2 of table10 of the standard. See the text for details.
 3. Class 2M laser products that failed condition 1 of table10 of the standard. Not required for Class 2M laser products that failed condition 2 of table10 of the standard. See the text for details.

For U.S.A

ANSI Z136.1:1993 “American National Standard for the Safe Use of Lasers” Control Measures for the Four Laser Classes

Control measures	Classification					
	1	2a	2	3a	3b	4
Engineering Controls	1	2a	2	3a	3b	4
Protective Housing (4.3.1)	X	X	X	X	X	X
Without Protective Housing (4.3.1.1)	LSO (see note 2) shall establish Alternate Controls					
Interlocks on Protective Housing (4.3.2)	☆	☆	☆	☆	X	X
Service Access Panel (4.3.3)	☆	☆	☆	☆	X	X
Key Control (4.3.4)	---	---	---	---	•	X
Viewing Portals (4.3.5.1)	---	---	MPE	MPE	MPE	MPE
Collecting Optics (4.3.5.2)	MPE	MPE	MPE	MPE	MPE	MPE
Totally Open Beam Path (4.3.6.1)	---	---	---	---	X NHZ	X NHZ
Limited Open Beam Path (4.3.6.2)	---	---	---	---	X NHZ	X NHZ
Enclosed Beam Path (4.3.6.3)	None is required if 4.3.1 and 4.3.2 fulfilled					
Remote Interlock Connector (4.3.7)	---	---	---	---	•	X
Beam Stop or Attenuator (4.3.8)	---	---	---	---	•	X
Activation Warning Systems (4.3.9)	---	---	---	---	•	X
Emission Delay (4.3.9.1)	---	---	---	---	---	X
Indoor Laser Controlled Area (4.3.10)	---	---	---	---	X NHZ	X NHZ
Class 3b Laser Controlled Area (4.3.10.1)	---	---	---	---	X	---
Class 4 Laser Controlled Area (4.3.10.2)	---	---	---	---	---	X
Laser Outdoor Controls (4.3.11)	---	---	---	---	X NHZ	X NHZ
Laser in Navigable Airspace (4.3.11.2)	---	---	---	•	•	•
Temporary Laser Controlled Area (4.3.12)	☆ MPE	☆ MPE	☆ MPE	☆ MPE	---	---
Remote Firing & Monitoring (4.3.13)	---	---	---	---	---	•
Labels (4.3.14 and 4.7)	X	X	X	X	X	X
Area Posting (4.3.15)	---	---	---	•	X NHZ	X NHZ
Administrative & Procedural Controls	1	2a	2	3a	3b	4

Control measures	Classification					
Standard Operating Procedures (4.4.1)	---	---	---	---	•	X
Output Emission Limitations (4.4.2)	---	---	---	LSO Determination		
Education and Training (4.4.3)	---	---	•	•	X	X
Authorized Personnel (4.4.4)	---	---	---	---	X	X
Alignment Procedures (4.4.5)	---	---	X	X	X	X
Protective Equipment (4.4.6)	---	---	---	---	•	X
Spectator (4.4.7)	---	---	---	---	•	X
Service Personnel (4.4.8)	☆ MPE	☆ MPE	☆ MPE	☆ MPE	X	X
Demonstration with General Public (4.5.1)	MPE+	---	X	X	X	X
Laser Optical Fiber Systems (4.5.2)	MPE	MPE	MPE	MPE	X	X
Laser Robotic Installations (4.5.3)	---	---	---	---	X NHZ	X NHZ
Eye Protection (4.6.2)	---	---	---	---	• MPE	X MPE
Protective Windows (4.6.3)	---	---	---	---	X NHZ	X NHZ
Protective Barriers and Curtains (4.6.4)	---	---	---	---	•	•
Skin Protection (4.6.5)	---	---	---	---	X MPE	X MPE
Other Protective Equipment (4.6.5)	Use may be required					
Warning Signs and Labels (4.7) (Design Requirements)	---	---	•	•	X NHZ	X NHZ
Service and Repairs (4.8)	LSO Determination					
Modification of Laser Systems (4.9)	LSO Determination					

Note: 1. LEGEND

- X: Shall
- : Should
- : No requirement
- ☆: Shall if enclosed Class 3b or Class 4
- MPE: Shall if MPE is exceeded
- NHZ: Nominal Hazard Zone analysis required
- +: Applicable only to UV and IR Lasers (4.5.1.2)

2. LSO: Laser Safety Officer

An individual shall be designated the Laser Safety Officer with the authority and responsibility to monitor and enforce the control of laser hazards, and to effect the knowledgeable evaluation and control of laser hazards.

For your reference, see ANSI Z136.1993, Section 1.3.

Definitions of Laser Classification

For Europe

Laser Product Classifications

EN

Class	Description
Class 1	Lasers which are safe under reasonably foreseeable conditions of operation.
Class 2	Lasers emitting visible radiation in the wavelength range from 400 nm to 700 nm. Eye protection is normally afforded by aversion responses including the blink reflex.
Class 3A	Lasers which are safe for viewing with the unaided eye. For laser emitting in the wavelength range from 400 nm to 700 nm, protection is afforded by aversion responses including the blink reflex. For other wavelengths the hazard to the unaided eye is no greater than for Class 1. Direct intrabeam viewing of Class 3A lasers with optical aides (e.g., binoculars, telescopes, microscopes) may be hazardous.
Class 3B	Direct intrabeam viewing of these lasers is always hazardous. Viewing diffuse reflections is normally safe (see note).
Class 4	Lasers which are also capable of producing hazardous diffuse reflections. They may cause skin injuries and could also constitute a fire hazard. Their use requires extreme caution.

Note: Conditions for safe viewing of diffuse reflections for Class 3B visible lasers are: minimum viewing distance of 13 cm between screen and cornea and a maximum viewing time of 10 s. Other viewing conditions require a comparison of the diffuse reflection exposure with the MPE.

For U.S.A

Comparison of Classifications between FDA and ANSI

Class	FDA definition	ANSI description
Class I/1	Limits applicable to devices that have emissions in the ultraviolet, visible, and infrared spectra, and limits below which biological hazards have not been established.	A Class 1 laser is considered to be incapable of producing damaging radiation levels during operation and maintenance and is, therefore, exempt from any control measures or other forms of surveillance.
Class IIa/2a	Limits applicable to products whose visible emission does not exceed Class I limits for emission durations of 1,000 seconds or less and are not intended for viewing.	Class 2 lasers are divided into two subclasses, 2 and 2a. A Class 2 laser emits in the visible portion of the spectrum (0.4 to 0.7 μm) and eye protection is normally afforded by the aversion response including the blink reflex.
Class II/2	Limits applicable to products that have emissions in the visible spectrum (400 to 710 nm) for emission durations in excess of 0.25 second, providing that emissions for other durations and/or wavelengths do not exceed the Class I limits. Class II products are considered hazardous for direct long-term ocular exposure.	

Class	FDA definition	ANSI description
Class IIIa/3a	Limits to products that have emissions in the visible spectrum and that have beams where the total collectable radiant power does not exceed 5 milliwatts.	Class 3 lasers are divided into two subclasses, 3a and 3b. A Class 3 laser may be hazardous under direct and specular reflection viewing conditions, but the diffuse reflection is usually not a hazard.
Class IIIb/3b	Limits applicable to devices that emit in the ultraviolet, visible, and infrared spectra. Class IIIb products include laser systems ranging from 5 to 500 milliwatts in the visible spectrum. Class IIIb emission levels are ocular hazards for direct exposure throughout the range of the Class, and skin hazards at the higher levels of the Class.	
Class IV/4	Exceeding the limits of Class IIIb and are a hazard for scattered reflection as well as for direct exposure.	A Class 4 laser is a hazard to the eye or skin from the direct beam and sometimes from a diffuse reflection and also can be a fire hazard. Class 4 lasers may also produce laser-generated air contaminants and hazardous plasma radiation.

Updating the Firmware

This section describes how to update the firmware of ZG series Controllers (such as ZG-WDC). Use Warp Engine ZS to update the firmware.

For the file for the firmware update, please contact your OMRON representative.

Important

- During a firmware update, do not turn the Controller OFF. Doing so will prevent the Controller from functioning normally.
- When installing Smart Monitor and the USB driver, log in as an administrator or a user having the same privileges as a computer administrator for changing system settings.

Connecting the Controller to the PC

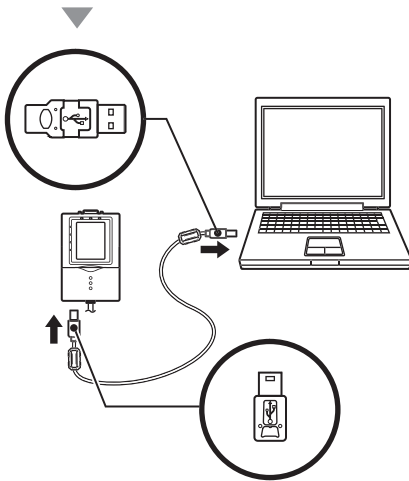

1 Connect the Controller to the PC with a USB cable.

When connecting the Controller to a PC for the first time, the USB driver must be installed in advance.

2 Turn the Controller ON.

Important

Make sure that the Controller's power supply is connected securely. When the power is turned OFF during a firmware update, the Controller breaks down and can no longer start up normally.

3 Set the Controller's mode switch to FUN.

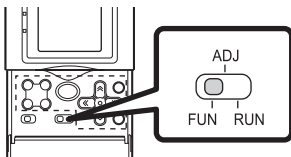

4 Install SmartMonitor ZG on the PC.

Warp Engine ZS that is used for updating the firmware will be simultaneously installed.

Starting Up Warp Engine ZS

Important

Start Warp Engine ZS only when the PC recognizes the Controller normally.

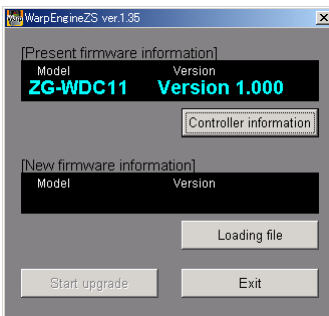

5 Select [Programs]-[OMRON]-[SmartMonitorZG]-[WarpEngineZS] from the Windows [Start] menu.

The [WarpEngineZS] window is displayed.

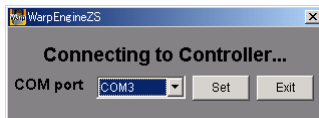

If startup of Warp Engine ZS fails, a message is displayed, followed by the dialog box shown on the left. Skip to "Setting the Connection Port" (p.189).

Setting the firmware information

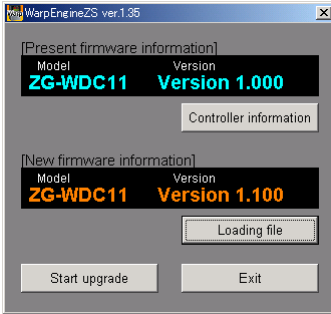

- 6** Click the [Controller information] button if necessary.

The model and version of the currently connected Controller are displayed.

- 7** Click the [Loading file] button to select the file to be written.

The model and version of the Controller that is held in the file are displayed.

Updating the firmware

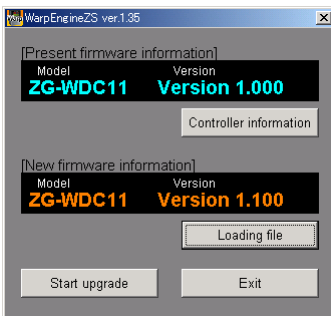

- 8** Click the [Start upgrade] button.

A message indicating the start of the update is displayed.

Important

If the message “the model is not the same” is displayed when you click the [Start upgrade] button, this means that the model of the connected Controller and the model information in the specified file do not match. In this case, do not update the firmware. The Controller will break down and can no longer start up normally.

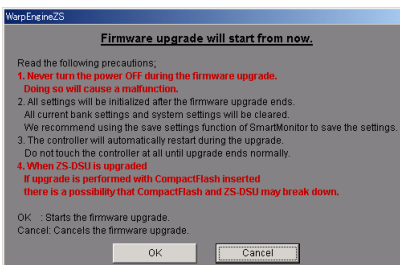

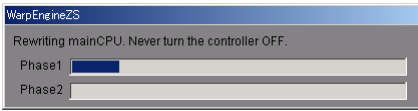

9 Check the message and click the [OK] button.

The firmware update will start.

During the update, the progress status will be displayed. Wait until a message informing completion of the update is displayed. (The update takes several minutes to complete).

Important

- During a firmware update, an error may occur on the Controller. Please wait.
- If the update progress bar stops or the update is not completed within 10 minutes, there is a possibility that the update has failed.
- In this case, notify an OMRON sales representative of the firmware version before the update and the firmware version in the write file.

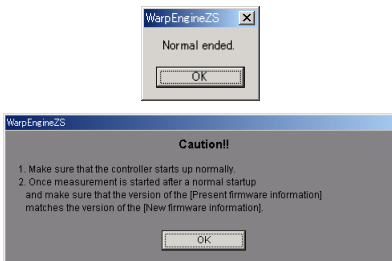

10 When the update is completed, the completion message is displayed. Follow the on-screen instructions.

11 Check the message and click the [OK] button.

Important

After the firmware update is completed, initialize the Controller.

 p.41

Setting the Connection Port



If startup of Warp Engine ZS fails, a message is displayed, followed by the dialog box shown below.

- 1** Select [Settings]-[Control Panel] from the [Start] menu in the PC and double-click [System].

The [System Properties] dialog box is displayed.

- 2** Open the [Hardware] tab and click [Device Manager].

The [Device Manager] dialog box is displayed.

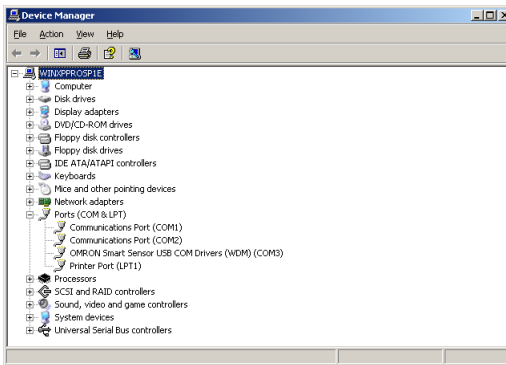

- 3** Open [Ports (COM&LPT)] and check the COM number in “OMRON Smart Sensor USB COM Drivers (WDM) (COMxx)”.

“(COMxx)” indicates the Controller's connection port.

- 4** Select the Controller's connection port from [COM Port], and click the [Set] button.

Warp Engine ZS starts up.

INDEX

Numerics

2-pt step	61
3-pt step	62

A

ADJ mode	36, 49
Adjusting Sensitivity	74
Analog output	87
Angle	64
Auto output method	120
AUTO sensitivity	151
Automatic setting	67
AVE	
FILTER	52
MEAS	69
AVERAGE	
PROFILE	79

B

BANK	
CLEAR	86
COPY	85
Bank	
Switching	85
BANKGET command	128
BANKLOAD command	134
BANKSAVE command	135
BANKSET command	127
Bottom	69

C

Cables	
Connecting	34
Extending	34
Calculation	65
CCD Mode	148
Setting	97
CHGDISP command	138
CLAMP	91
Command format	124
Command response method	120
Communication specifications	98
Connecting Devices	33
Connecting the Power Supply	35
Control keys	20

Controller	
External dimensions	163
Mounting	30
Part Names and Functions	19
Specifications	161
Controller information	100
Correcting analog output values	90
Cross-sectional area	65

D

DATAGET command	132
DATAINIT command	133
DATASAVE command	133
DATASET command	132
Digital monitor	54

E

ECO MODE	100
Eco monitor	54
Edge level	70
Edge position	63
Edge width	63
ERROR	53
EXP mode	20, 40

F

Ferrite core	33
FILTER	52
FIXED sensitivity	151
FUN Mode	44
FUN mode	36
Function extension connector	20

G

GATE signal	94
-------------	----

H

HEIGHT	60
High-resolution mode	97
High-speed mode	97

I

I/O cable	20
I/O circuit diagrams	108
I/O timing charts	114

Initialization	41
ITEM	60

J

JUDGE	51
Judgment indicator	19

L

LANGUAGE	100
Laser emitter	18
Laser indicator	18, 19
Laser receiver	18
List of commands	126

M

MEAS	69
MEASURE command	129
Measurement Items	
Setting	60
Measurement items	
Deleting	65
Setting	46
Measurement range	
ZG-WDS22	25
ZG-WDS3T	29
ZG-WDS70	23
ZG-WDS8T	27
Measurement trigger	93
Menu switch	20
MGNIFY	68
Mode switch	20
Mounting position	
ZG-WDS22	24
ZG-WDS3T	28
ZG-WDS70	22
ZG-WDS8T	26
MULTI sensitivity	151
Multi-task measurement	38
Mutual interference	159

N

Node No.	98
Number of digits past the decimal point	
Display digits	99
Parallel Output Unit	93

O

Output condition setup monitor	50
--------------------------------	----

P

Panel cutout dimensions	164
Parallel Output Unit	92, 110
Parameter list	141
Peak	69
Position correction	82
PROFILE	
AVERAGE	79
FILLUP	80
SMOOTH	79
SUPnum	81
Profile	
Screen	37
PROFILE command	139
Profile display	
Magnifying	57, 68
Profiles	
Monitoring	49, 54
Registering	44

R

REGION	66, 77
Response format	124
RS-232C communication	
specifications	98
RS-232C connector	20
RUN mode	36

S

SAVE	101
Scaling	71
Analog output	88
Sensitivity adjustment	150
Sensor	
External dimensions	155
Mounting	21
Mutual interference	159
Part Names and Functions	18
Specifications	153
Sensor connector	20
SENSOR SET	97
Setting regions	47
Setting the icon color	101
Setting the Sensor Data	
Loading Method	99
Shortcut keys	55
SMOOTH	53
Standard mode	97
STD mode	20, 40

Step	61
Switching bank data	93
SYSLOAD command	136
SYSSAVE command	137
System Configuration	16

T

TASK	
Analog output	87
Parallel Output Unit	92
Serial output	96
Tasks and bank data	38
TEACH	45
TRIG command	130
Trigger indicator	19

U

Updating the firmware	185
USB port	20

V

VERGET command	140
Voltage/Current switch	20

W

Wiring the I/O cable	105
----------------------	-----

Z

ZERO	51
Zero reset	56
Zero Reset indicator	19
ZEROCLR command	131
ZERORST command	131

Revision History

A manual revision code appears as a suffix to the catalog number at the bottom of the front and back covers of this manual.

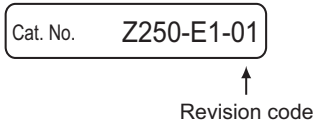

Revision code	Date	Revised content
01	October 2006	Original production

OMRON Corporation
Industrial Automation Company

Sensing Devices Division H.Q.
Application Sensors Division
Shiokoji Horikawa, Shimogyo-ku,
Kyoto, 600-8530 Japan
Tel: (81)75-344-7068/Fax: (81)75-344-7107

Regional Headquarters
OMRON EUROPE B.V.
Sensor Business Unit,
Carl-Benz-Str. 4, D-71154 Nufringen,
Germany
Tel: (49)7032-811-0/Fax: (49)7032-811-199

OMRON ELECTRONICS LLC
1 East Commerce Drive, Schaumburg, IL 60173
U.S.A.
Tel: (1)847-843-7900/Fax: (1)847-843-8568

OMRON ASIA PACIFIC PTE. LTD.
83 Clemenceau Avenue,
#11-01, UE Square,
239920 Singapore
Tel: (65)6835-3011/Fax: (65)6835-2711

OMRON (CHINA) CO., LTD.
Room 2211, Bank of China Tower,
200 Yin Cheng Road (M)
Shanghai, 200120 China
Tel: (86)21-5037-2222/Fax: (86)21-5037-2200

Authorized Distributor:

Cat. No. Z250-E1-01

OMRON Corporation 2006 All Rights Reserved.
Note: Specifications subject to change without notice.

Printed in Japan.
xxxx-xx (xxxx) (x)