

Standard (thin shape) Inductive Proximity Sensor

# TL-T

- Thin shape for space saving surface mounting
- Direct side wall mounting for bracket-less installation



## Ordering Information

### DC 3-wire Models

Installation	Sensing distance	Connection	Output configuration	Operation mode NO	Operation mode NC
Shielded	2.0 mm	Pre-wired	NPN	TL-T2E1-E	TL-T2E2-E
			PNP	TL-T2F1-E	TL-T2F2-E
		M8 Connector (3-pin)	NPN	TL-T2E1-M5-E	TL-T2E2-M5-E
			PNP	TL-T2F1-M5-E	TL-T2F2-M5-E
Non-Shielded	4.0 mm	Pre-wired	NPN	TL-T4ME1-E	TL-T4ME2-E
			PNP	TL-T4MF1-E	TL-T4MF2-E
		M8 Connector (3-pin)	NPN	TL-T4ME1-M5-E	TL-T4ME2-M5-E
			PNP	TL-T4MF1-M5-E	TL-T4MF2-M5-E

### DC 4-wire Models (NO + NC)

Installation	Sensing distance	Connection	Output configuration	Operation mode antivalent (NO + NC)
Shielded	2.0 mm	Pre-wired	NPN	TL-T2E3-E
			PNP	TL-T2F3-E
Non-Shielded	4.0 mm	Pre-wired	NPN	TL-T4ME3-E
			PNP	TL-T4MF3-E

### Model Number Legend

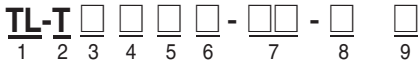

- Basic name**  
TL
- Housing & shape material**  
Square plastic 40 x 12 x 26 mm
- Sensing distance**  
2: 2mm  
4: 4mm
- Shield**  
Blank: Shielded  
M: Non-shielded
- Power source & output**  
E: NPN voltage output  
F: PNP voltage output
- Operation mode**  
1: Normally open (NO)  
2: Normally closed (NC)  
3: Antivalent (NO + NC)

**Example:** TL-T2F1-E 2M Square housing (40x12x26 mm), Sn=2 mm, shielded, PNP-NO, made by OMG, pre-wired PVC cable (3x0,25 mm<sup>2</sup>) 2 m  
 TL-T4MF1-M5-E Square housing (40x12x26 mm), Sn=4 mm, not shielded, PNP-NO, M8 (3-pole) connector, made by OMG

- Kind of connection**  
Blank: Pre-wired, PVC dia 4mm  
WA: Pre-wired, PUR/PVC dia 4mm  
WR: Robot cable, PVC dia 4mm  
M5: M8 connector (3-pole)  
M1J: M12 connector (4-pole) with pig-tail cable (PVC)  
M3J: M8 connector (4-pole) with pig-tail cable (PVC)  
M5J: M8 connector (3-pole) with pig-tail cable (PVC)
- Production site**  
E: European Union
- Cable length**  
Blank: Connector type  
Numeral: Cable type

TL-T

Specifications

DC 3-wire and DC 4-wire Models

Type	Shielded		Non-shielded	
Item	TL-T2E1-□□-E TL-T2F1-□□-E TL-T2E2-□□-E TL-T2F2-□□-E TL-T2E3-E TL-T2F3-E		TL-T4ME1-□□-E TL-T4MF1-□□-E TL-T4ME2-□□-E TL-T4MF2-□□-E TL-T4ME3-E TL-T4MF3-E	
Sensing distance	2 mm ±10%		4 mm ±10%	
Setting distance	0 to 1.6 mm		0 to 3.2 mm	
Differential travel	15% max. of sensing distance			
Target	Ferrous metal (The sensing distance decreases with non-ferrous metal)			
Standard target	12 x 12 x 1 mm		12 x 12 x 1 mm	
Response frequency (See note 1.)	3000 Hz		1500 Hz	
Rated power supply voltage (operating voltage range)	24 VDC. Ripple (p-p): 10% max. (10 to 35 VDC)			
Current consumption	DC 3-wire: ≤5 mA at 24 VDC DC 4-wire: ≤5 mA at 24 VDC			
Output type	TL-T□□E models: NPN voltage output TL-T□□F models: NPN voltage output			
Control output	Load current	300 mA max. each output		
	Residual voltage	±0.0 VDC		
	Leakage current	DC 3-wire: <0,5 mA DC 4-wire: <1 mA each output		
Indicator	Output indicator (Yellow LED)			
Operation mode (with sensing object approaching)	TL-T□□E1/F1 models: NO TL-T□□E2/F2 models: NC TL-T□□E3/F3 models: NO + NC For details, refer to <i>Timing Charts</i> .			
Protection circuits	Output reverse polarity protection, Power source circuit reverse polarity protection, Surge suppressor, Short-circuit protection			
Ambient air temperature	Operating/Storage: -25° C to 70° C			
Temperature influence	≤10% max. of Sn at 23° C in temperature range of -25° C to 70° C			
Humidity	35% to 95% RH			
Voltage influence	±1% max. of sensing distance in the rated voltage range ±15%			
Insulation resistance	>10 MΩ between current-carrying parts and case			
Dielectric strength	1000 VAC at 50/60 Hz between current-carrying parts and case			
Vibration resistance	0 to 55 Hz with 30 min. dwell time at resonance frequency or 55 Hz each in X, Y, and Z directions 55 to 2000 Hz, 150 m/s <sup>2</sup> , double amplitude for 2 hours each in X, Y, and Z directions			
Shock resistance	300 m/s <sup>2</sup> 6 times each in X, Y, and Z directions			
Degree of protection	in accordance with IEC 60529: Pre-wired models: IP67 M8 connector models: IP65			
Product standard	EN60947-5-2			
Connection method	Pre-wired (See note 2)	2m cable, 3x 0,25 mm <sup>2</sup> for DC 3-wire models 4x 0,25 mm <sup>2</sup> for DC 4-wire models		
	Connector	M8 connector		
Weight (packaged)	Pre-wired model	Approx. 70 g		
	M8 connector models	Approx. 20 g		
Material	Case	PBT		
	Cable	PVC		

Note: 1. The response frequency is an average value. Measurement conditions are as follows: standard target, a distance of twice the standard target distance between targets, and a setting distance of half the sensing distance  
2. PUR Cable and other length request

## Engineering Data

### Operating Range (Typical)

#### Shielded and non-shielded models

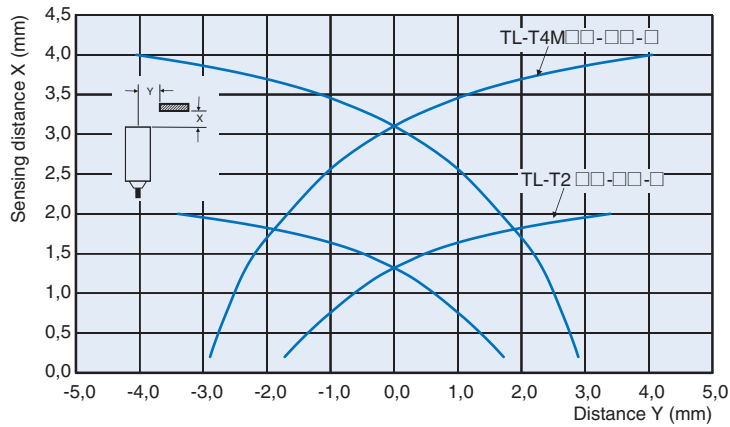

### Influence of Sensing Object Size and Material

#### Shielded models

##### TL-T2 □□-□□-□

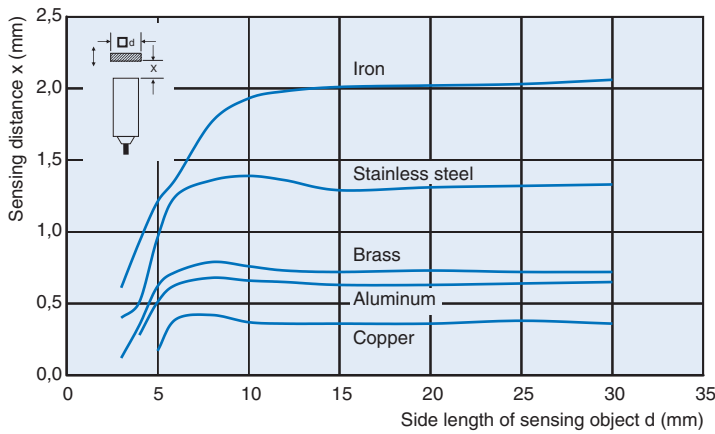

#### Non-shielded models

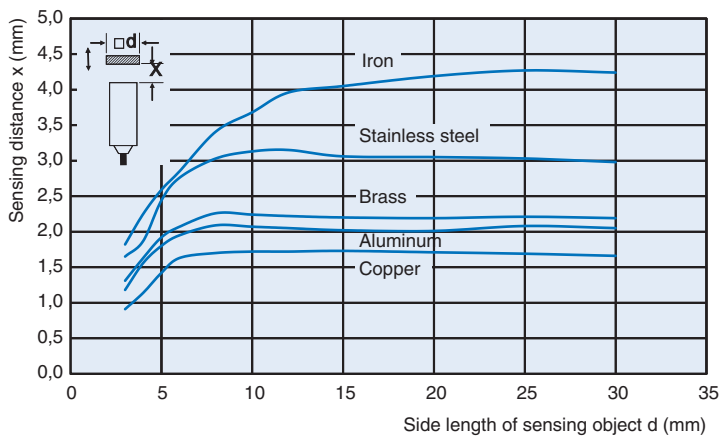

TL-T

Operation

PNP Output

Operation mode	Model	Timing chart	Output circuit
NO	TL-T□-F1-□-□		<p>M8 connector (3 pin) Pin Arrangement</p>
NC	TL-T□-F2-□-□		<p>M8 connector (3 pin) Pin Arrangement</p>
NO+NC	TL-T□-F3-□-□		<p>M8 connector (3 pin) Pin Arrangement</p>

NPN Output

Operation mode	Model	Timing chart	Output circuit
NO	TL-T□-E1-□-□		
NC	TL-T□-E2-□-□		
NO+NC	TL-T□-E3-□-□		

TL-T

## Dimensions

Note: All units are in millimeters unless otherwise stated

### Pre-wired Models (shielded and non-shielded)

#### TL-T2□□-E 2M and TL-T4M□□-E 2M

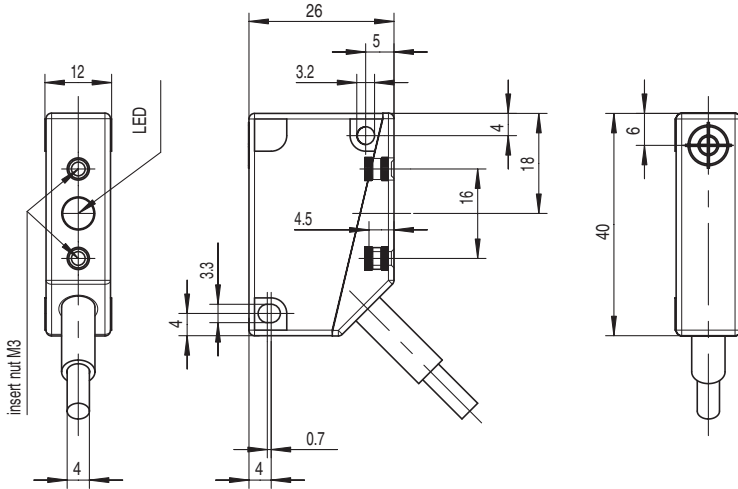

### M8 Connector Models (shielded and non-shielded)

#### TL-T2□□-M5-E and TL-T4M□□-M5-E

Technical drawing showing three views of the M8 connector models (TL-T2□□-M5-E and TL-T4M□□-M5-E). The drawing includes the following dimensions and labels:

- Front View:** Shows a rectangular component with a width of 12 mm and a height of 4 mm. It features two circular LEDs and an "insert nut M3" on the left side.
- Side View:** Shows the component's profile with a total length of 26 mm. Key dimensions include 5 mm, 3.2 mm, 4 mm, 16 mm, 18 mm, 4.5 mm, 3.3 mm, 4 mm, 0.7 mm, and an "M8" connector. It shows the internal wiring and the "insert nut M3" location.
- Top View:** Shows a rectangular component with a width of 40 mm and a height of 6 mm. It features a circular LED and a central mounting point.

## Precautions

### Safety Precautions

#### Power Supply

Do not impose an excessive voltage on the TL-T, otherwise it may be damaged. Do not impose AC current (100 to 240 VAC) on any DC model, otherwise it may be damaged.

#### Load Short-circuit

Do not short-circuit the load, or the TL-T may be damaged.

The TL-T's short-circuit protection function will be valid if the polarity of the supply voltage imposed is correct and within the rated voltage range.

### Correct Use

#### Designing

##### Power Reset Time

The Proximity Sensor is ready to operate within 100 ms after power is supplied. If power supplies are connected to the Proximity Sensor and load respectively, be sure to supply power to the Proximity Sensor before supplying power to the load.

##### Effects of Surrounding Metal

When mounting the TL-T within a metal panel, ensure that the clearances given in the following table are maintained.

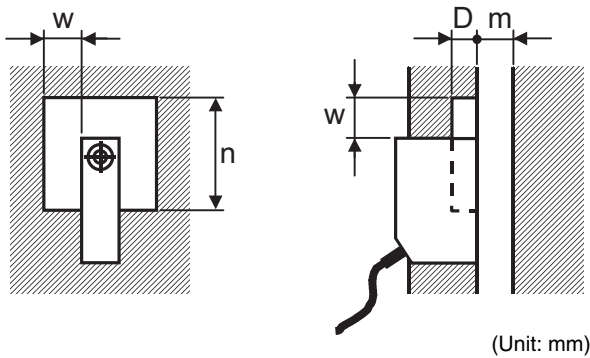

Type	Dimension	Minimum value
Shielded	w	0
	n	-
	D	0
	m	6
Non-shielded	w	12
	n	36
	D	8
	m	12

### Wiring

Be sure to wire the TL-T and load correctly, otherwise it may be damaged.

**Do not expose the product to flammable or explosive gases.**

**Do not disassemble, repair, or modify the product.**

#### Power OFF

The Proximity Sensor may output a pulse signal when it is turned OFF. Therefore, it is recommended that the load be turned OFF before turning OFF the Proximity Sensor.

#### Power Supply Transformer

When using a DC power supply, make sure that the DC power supply has an insulated transformer. Do not use a DC power supply with an auto-transformer.

#### Mutual Interference

When installing two or more Sensors face-to-face or side-by-side, ensure that the minimum distances given in the following table are maintained.

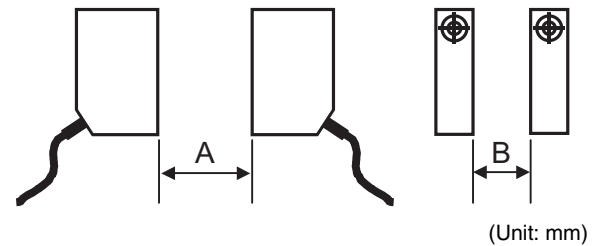

Type	Dimension	Minimum value
Shielded	A	30
	B	10
Non-shielded	A	40
	B	20

## Wiring

### High-tension Lines

Wiring through Metal Conduit:

If there is a power or high-tension line near the cable of the Proximity Sensor, wire the cable through an independent metal conduit to prevent against Proximity Sensor damage or malfunctioning.

### Cable Extension

Standard cable length is less than 200 m.

The tractive force is 50 N.

## Mounting

The Proximity Sensor must not be subjected to excessive shock with a hammer when it is installed, otherwise the Proximity Sensor may be damaged or lose its water-resistivity.

Do not tighten the screw with excessive force. A washer must be used with the screw.

## Maintenance and Inspection

Periodically perform the following checks to ensure stable operation of the Proximity Sensor over a long period of time.

1. Check for mounting position, dislocation, looseness, or distortion of the Proximity Sensor and sensing objects.
2. Check for loose wiring and connections, improper contacts, and line breakage.
3. Check for attachment or accumulation of metal powder or dust.
4. Check for abnormal temperature conditions and other environmental conditions.
5. Check for proper lighting of indicators (for models with a set indicator.)

**Never disassemble or repair the Sensor.**

## Environment

### Water Resistivity

The Proximity Sensors are tested intensively on water resistance, but in order to ensure maximum performance and life expectancy avoid immersion in water and provide protection from rain or snow.

### Operating Environment

Ensure storage and operation of the Proximity Sensor within the given specifications.

### Inrush Current

A load that has a large inrush current (e.g., a lamp or motor) will damage the Proximity Sensor, in which case connect the load to the Proximity Sensor through a relay.

## <SUITABILITY FOR USE>

OMRON shall not be responsible for conformity with any standards, codes, or regulations that apply to the combination of the products in the customer's application or use of the products.

Take all necessary steps to determine the suitability of the product for the systems, machines, and equipment with which it will be used.

## <CHANGE IN SPECIFICATIONS>

Product specifications and accessories may be changed at any time based on improvements and other reasons. Consult with your OMRON representative at any time to confirm actual specifications of purchased product.

ALL DIMENSIONS SHOWN ARE IN MILLIMETERS.

To convert millimeters into inches, multiply by 0.03937. To convert grams into ounces, multiply by 0.03527.