

Switch Mode Power Supply S8VS (15/30/60/90/120/180/240-W Models)

15/30-W Models

Compact, Thin Power Supplies That Mount Just About Anywhere to Contribute to Control Panel Downsizing

- Compact, thin size: 22.5 × 85 × 96.5 mm (W × H × D).
- Three mounting directions (standard, horizontal, facing horizontal).
- Mounting directly to the panel is possible.
- Safety standards:
UL508/60950-1/1604, CSA C22.2 No. 14/60950-1/213, EN50178 (= VDE0160), EN60950-1 (= VDE0805).



60/90/120/180/240-W Models

New Models with Total Run Time Monitor in Addition to Models with Maintenance Forecast Monitor

- Compact size: 40 × 95 mm (W × H) (60-W Models).
- Status displayed on 3-digit, 7-segment display.
- Safety standards:
UL508/60950, CSA C22.2 No. 14/60950, EN50178 (= VDE0160), EN60950 (= VDE0805).



Features Common to All Models

- Mount to DIN Rail.
- Lead-free solder.

Model Number Structure

Model Number Legend

S8VS-

--	--	--	--	--	--

1 2 3

1. Power Ratings

- 015: 15 W
- 030: 30 W
- 060: 60 W
- 090: 90 W
- 120: 120 W
- 180: 180 W
- 240: 240 W

2. Output voltage

- 05: 5 V
- 12: 12 V
- 24: 24 V

3. Configuration

15-W, 30-W Models

None: Standard

60-W Models

None: Standard

- A: With maintenance forecast monitor
- B: With total run time monitor

90-W, 120-W, 180-W, 240-W Models

None: Standard

- A: With maintenance forecast monitor and undervoltage alarm (transistor (sinking))
- B: With total run time monitor and undervoltage alarm (transistor (sinking))
- AP: With maintenance forecast monitor and undervoltage alarm (transistor (sourcing))
- BP: With total run time monitor and undervoltage alarm (transistor (sourcing))

Ordering Information

Power ratings	Input Voltage	Output voltage	Output current	Alarm output	Model number	
15 W	100 to 240 VAC	5 V	2.0 A	---	S8VS-01505 (See note 1.)	
		12 V	1.2 A	---	S8VS-01512	
		24 V	0.65 A	---	S8VS-01524	
30 W		5 V	4.0 A	---	S8VS-03005 (See note 2.)	
		12 V	2.5 A	---	S8VS-03012	
		24 V	1.3 A	---	S8VS-03024	
60 W		24 V	2.5 A	---	S8VS-06024	
					S8VS-06024A	
					S8VS-06024B	
90 W		24 V	3.75 A	---	S8VS-09024	
					Sinking	S8VS-09024A
					Sourcing	S8VS-09024AP
	Sinking				S8VS-09024B	
	Sourcing				S8VS-09024BP	
120 W	5 A		---	S8VS-12024		
				Sinking	S8VS-12024A	
				Sourcing	S8VS-12024AP	
				Sinking	S8VS-12024B	
180 W	7.5 A		---	S8VS-18024		
				Sinking	S8VS-18024A	
				Sourcing	S8VS-18024AP	
		Sinking		S8VS-18024B		
240 W	10 A	---	S8VS-24024			
			Sinking	S8VS-24024A		
			Sourcing	S8VS-24024AP		
			Sinking	S8VS-24024B		
240 W	10 A	---	S8VS-24024BP			
			Sinking	S8VS-24024BA		
			Sourcing	S8VS-24024BAP		
			Sinking	S8VS-24024BB		

Note: 1. The output capacity of the S8VS-01505 is 10 W.
 2. The output capacity of the S8VS-03005 is 20 W.

Specifications

■ Ratings/Characteristics

Item	Power ratings		15 W		30 W		
	Type		Standard		Standard		
Efficiency (typical)	5-V models		72% min. (76% typ.)		70% min. (76% typ.)		
	12-V models		74% min. (79% typ.)		76% min. (83% typ.)		
	24-V models		77% min. (81% typ.)		80% min. (85% typ.)		
Input	Voltage		100 to 240 VAC (85 to 264 VAC)				
	Frequency		50/60 Hz (47 to 450 Hz)				
	Current	100 V input		0.45 A max.		0.9 A max.	
		200 V input		0.25 A max.		0.6 A max.	
		230 V input		5 V: (0.14 A typ.), 12 V/24 V (0.19 A typ.)			
	Power factor		---				
	Harmonic current emissions		Conforms to EN61000-3-2				
	Leakage current	100 V input		0.5 mA max.			
		200 V input		1.0 mA max.			
		230 V input		5 V/12 V/24 V: (0.30 mA typ.)		5 V/12 V/24 V:(0.32 mA typ.)	
	Inrush current (See note 1.)	100 V input		25 A max. (20 A typ.) (for a cold start at 25°C)			
200 V input			50 A max. (40 A typ.) (for a cold start at 25°C)				
230 V input			5 V/12 V/24 V: (29 A typ.) (See note 6.)		5 V/12 V/24 V: (40 A typ.) (See note 6.)		
Output	Voltage adjustment range (See note 2.)		-10% to 15% (with V.ADJ) (guaranteed)				
	Ripple		2.0% (p-p) max. (at rated input/output voltage)				
		f=20MHz measuring		5 V: (0.70%(p-p) typ.), 12 V:(0.48%(p-p) typ.), 24 V:(0.25%(p-p) typ.)		5 V: (0.70%(p-p) typ.), 12 V:(0.52%(p-p) typ.), 24 V:(0.19%(p-p) typ.)	
		f=100MHz measuring		5 V: (0.86%(p-p) typ.), 12 V:(0.56%(p-p) typ.), 24 V:(0.32%(p-p) typ.)		5 V: (0.80%(p-p) typ.), 12 V:(0.58%(p-p) typ.), 24 V:(0.21%(p-p) typ.)	
	Input variation influence		0.5% max. (at 85 to 264 VAC input, 100% load)				
	Load variation influence (rated input voltage)		2.0% max. (5 V), 1.5% max. (12 V, 24 V), (with rated input, 0 to 100% load)				
	Temperature variation influence		0.05%/°C max.				
	Start up time (See note 1 and 7.)			100 ms max. (at rated input/output voltage)		1,000 ms max. (at rated input/output voltage)	
				5 V: (6 ms typ.), 12 V: (12 ms typ.), 24 V: (18 ms typ.)		5 V/12 V/24 V: (240 ms typ.)	
	Hold time (See note 1.)			20 ms min. (at rated input/output voltage)			
		at 100% load		5 V: (328 ms typ.), 12V: (251 ms typ.), 24 V: (243 ms typ.)		5 V: (299 ms typ.), 12 V: (217 ms typ.), 24 V: (210 ms typ.)	
Additional functions	Overload protection (See note 1.)		105% to 160% of rated load current, voltage drop, automatic reset		105% to 160% of rated load current, voltage drop, intermittent operation, automatic reset		
	Overvoltage protection (See note 1.)		Yes (a zener diode clamp) (See note 3.)		Yes (See note 4.)		
	Output voltage indication		No				
	Output current indication		No				
	Peak-hold current indication		No				
	Maintenance forecast monitor indication		No				
	Maintenance forecast monitor output		No				
	Total run time monitor indication		No				
	Total run time monitor output		No				
	Undervoltage alarm indication		Yes (color: red)				
	Undervoltage alarm output		No				
	Parallel operation		No				
	Series operation		Models with 24-V output: Possible for up to 2 Power Supplies (with external diode) Models with 5- or 12-V output: Not possible				
Other	Operating ambient temperature		Refer to the derating curve in <i>Engineering Data</i> . (with no icing or condensation)				
	Storage temperature		-25 to 65°C				
	Operating ambient humidity		25% to 85% (Storage humidity: 25% to 90%)				
	Dielectric strength			3.0 kVAC for 1 min. (between all inputs and outputs; detection current: 20 mA)			
				2.0 kVAC for 1 min. (between all inputs and PE terminals; detection current: 20 mA)			
	Insulation resistance			1.0 kVAC for 1 min. (between all outputs and PE terminals; detection current: 20 mA)			
				100 MΩ min. (between all outputs and all inputs/ PE terminals) at 500 VDC			
	Vibration resistance		10 to 55 Hz, 0.375-mm single amplitude for 2 h each in X, Y, and Z directions				
	Shock resistance		10 to 150 Hz, 0.35-mm single amplitude (5 G max.) for 80 min. each in X, Y, and Z directions				
	Shock resistance		150 m/s ² , 3 times each in ±X, ±Y, and ±Z directions				
	Output indicator		Yes (color: green)				
	EMI	Conducted Emissions		Conforms to EN61204-3 EN55011 Class B and based on FCC Class A			
		Radiated Emissions		Conforms to EN61204-3 EN55011 Class B			
	EMS		Conforms to EN61204-3 high severity levels				
	Approved standards		UL: UL508 (Listing, Class 2: Per UL1310), UL60950-1, UL1604 (Class I/Division2) cUL: CSA C22.2 No.14 (Class 2), No.60950-1, No.213 (Class I/Division2) EN/VDE: EN50178 (=VDE0160), EN60950-1 (=VDE0805) SELV (EN60950/EN50178/UL60950-1) According to VDE0106/P100, IP20				
Weight		160 g max.		180 g max.			

- Note:**
1. Refer to the *Engineering Data* section on page 17 for details.
 2. If the V.ADJ adjuster is turned, the voltage will increase by more than +15% of the voltage adjustment range. When adjusting the output voltage, confirm the actual output voltage from the Power Supply and be sure that the load is not damaged.
 3. The overvoltage protection of the S8VS-015□□ uses a zener diode clamp. If the internal feedback circuit is destroyed by any chance, the load may be destroyed by the clamped output voltage (approx. 140% to 190% of the rated output voltage).
 4. To reset the protection, turn OFF the power supply for three minutes or longer and then turn the power supply back ON.
 5. The typical values indicate the values for an input condition of 230 VAC. All items are measured at a frequency of 50 Hz.
 6. The inrush current circuits do not differ for voltage specifications. Therefore, the typical values are the data values for 24-V models.
 7. The circuit forms are different, so the start up time is shorter only when using a 15-W power rating.

Specifications

■ Ratings/Characteristics

Item	Power ratings Type	60 W			90 W			
		Standard	Maintenance forecast monitor	Total run time monitor	Standard	Maintenance forecast monitor	Total run time monitor	
Efficiency (typical)		78% min. (86% typ.)			80% min. (87% typ.)			
Input	Voltage	100 to 240 VAC (85 to 264 VAC)						
	Frequency	50/60 Hz (47 to 450 Hz)						
	Current	100 V input	1.7 A max.				2.3 A max.	
		200 V input	1.0 A max.				1.4 A max.	
		230 V input	(0.7 A typ.)				(0.9 A typ.)	
	Power factor	---						
	Harmonic current emissions	Conforms to EN61000-3-2						
	Leakage current	100 V input	0.5 mA max.					
		200 V input	1.0 mA max.					
		230 V input	(0.40 mA typ.)				(0.35 mA typ.)	
Inrush current (See note 1.)	100 V input	25 A max. (for a cold start at 25°C)						
	200 V input	50 A max. (for a cold start at 25°C)						
	230 V input	(47 A typ.)				(38 A typ.)		
Output	Voltage adjustment range (See note 2.)	-10% to 15% (with V.ADJ) (guaranteed)						
	Ripple	2.0% (p-p) max. (at rated input/output voltage)						
		f=20MHz measuring	(0.29% (p-p) typ.)				(0.38% (p-p) typ.)	
	f=100MHz measuring	(0.32% (p-p) typ.)				(0.42% (p-p) typ.)		
	Input variation influence	0.5% max. (at 85 to 264 VAC input, 100% load)						
	Load variation influence (rated input voltage)	1.5% max. (with rated input, 0 to 100% load)						
	Temperature variation influence	0.05%/°C max.						
	Start up time (See note 1.)	1,000 ms max. (at rated input/output voltage)						
		(270 ms typ.)				(260 ms typ.)		
	Hold time (See note 1.)	20 ms min. (at rated input/output voltage)						
		at 100% load	(220 ms typ.)				(190 ms typ.)	
	Additional functions	Overload protection (See note 1.)	105% to 160% of rated load current, voltage drop, intermittent, automatic reset					
		Overvoltage protection (See notes 1 and 3.)	Yes					
Output voltage indication (See note 4.)		No	Yes (selectable) (See note 5.)		No	Yes (selectable) (See note 5.)		
Output current indication (See note 4.)		No	Yes (selectable) (See note 6.)		No	Yes (selectable) (See note 6.)		
Peak-hold current indication (See note 4.)		No	Yes (selectable) (See note 7.)		No	Yes (selectable) (See note 7.)		
Maintenance forecast monitor indication (See note 4.)		No	Yes (selectable)	No	No	Yes (selectable)	No	
Maintenance forecast monitor output		No				Yes (open collector output), 30 VDC max., 50 mA max. (See note 8.)		
Total run time monitor indication (See note 4.)		No	Yes (selectable)		No	Yes (selectable)		
Total run time monitor output		No				Yes (open collector output), 30 VDC max., 50 mA max. (See note 8.)		
Undervoltage alarm indication (See note 4.)		No	Yes (selectable)		No	Yes (selectable)		
Undervoltage alarm output terminals		No				Yes (open collector output), 30 VDC max., 50 mA max. (See note 8.)		
Parallel operation		No						
Series operation		Yes for up to 2 Power Supplies (with external diode)						
Other	Operating ambient temperature	Refer to the derating curve in <i>Engineering Data</i> . (with no icing or condensation)						
	Storage temperature	-25 to 65°C						
	Operating ambient humidity	25% to 85% (Storage humidity: 25% to 90%)						
	Dielectric strength	3.0 kVAC for 1 min. (between all inputs and outputs/ alarm outputs; detection current: 20 mA)						
		2.0 kVAC for 1 min. (between all inputs and PE terminals; detection current: 20 mA)						
		1.0 kVAC for 1 min. (between all outputs/ alarm outputs and PE terminals; detection current: 20 mA)						
		500 VAC for 1 min. (between all outputs and alarm outputs; detection current: 20 mA)						
	Insulation resistance	100 MΩ min. (between all outputs/ alarm outputs and all inputs/ PE terminals) at 500 VDC						
	Vibration resistance	10 to 55 Hz, 0.375-mm single amplitude for 2 h each in X, Y, and Z directions						
		10 to 150Hz, 0.35-mm single amplitude (5 G max.) for 80 min each in-X, Y, and Z directions						
	Shock resistance	150 m/s ² , 3 times each in ±X, ±Y, and ±Z directions						
	Output indicator	Yes (color: green)						
	EMI	Conducted Emissions	Conforms to EN61204-3 EN55011 Class A and based on FCC Class A					
Radiated Emissions		Conforms to EN61204-3 EN55011 Class A Conforms to EN61204-3 EN55011 Class B (See note 9.)						
EMS	Conforms to EN61204-3 high severity levels							
Approved standards	UL: UL508 (Listing, Class 2: Per UL1310), UL60950 cUL: CSA C22.2 No.14 (Class 2), No.60950 EN/VDE: EN50178 (=VDE0160), EN60950 (=VDE0805) SELV (EN60950/EN50178/UL60950-1) According to VDE0106/P100, IP20			UL: UL508 (Listing), UL60950 cUL: CSA C22.2 No.14, No.60950 EN/VDE: EN50178 (=VDE0160), EN60950 (=VDE0805) SELV (EN60950/EN50178/UL60950-1) According to VDE0106/P100, IP20				
Weight	330 g max.			490 g max.				

- Note:
1. Refer to the *Engineering Data* section on page 17 for details.
 2. If the V.ADJ adjuster is turned, the voltage will increase by more than +15% of the voltage adjustment range (by more than +10% for 240-W models). When adjusting the output voltage, confirm the actual output voltage from the Power Supply and be sure that the load is not damaged.
 3. To reset the protection, turn OFF the power supply for three minutes or longer and then turn the power supply back ON.
 4. Displayed on 7-segment LED. (character height: 8 mm)
 5. Resolution of output voltage indication: 0.1 V, Precision of output voltage indication: ±2% (percentage of output voltage value, ±1 digit)
 6. Resolution of output current indication: 0.1 A; Precision of output current indication: ±5% F.S. ±1 digit max. (specified by rated output voltage)
 7. Resolution of peak-hold current indication: 0.1 A; Precision of peak-hold current indication: ±5% F.S. ±1 digit max. (specified by rated output voltage); Signal width required for peak-hold current: 20 ms
 8. A Type and B Type: Sinking, AP Type and P Type: Sourcing
 9. To ensure the emission rating, a ferrite ring core should be used in all cabling (TDK HF60T, HF70RH or equivalent model).
 10. The typical values indicate the values for an input condition of 230 VAC. All items are measured at a frequency of 50 Hz.

Item	Power ratings Type	120 W			180 W			240 W				
		Standard	Maintenance forecast monitor	Total run time monitor	Standard	Maintenance forecast monitor	Total run time monitor	Standard	Maintenance forecast monitor	Total run time monitor		
Efficiency (typical)		80% min. (87% typ.)			80% min. (88% typ.)			80% min. (86% typ.)				
Input	Voltage	100 to 240 VAC (85 to 264 VAC)										
	Frequency	50/60 Hz (47 to 63 Hz)										
	Current	100 V input	1.9 A max.			2.9 A max.			3.8 A max.			
		200 V input	1.1 A max.			1.6 A max.			2.0 A max.			
		230 V input	(0.6 A typ.)			(0.9 A typ.)			(1.2 A typ.)			
	Power factor	0.95 min.										
	Harmonic current emissions	Conforms to EN61000-3-2										
	Leakage current	100 V input	0.5 mA max.									
		200 V input	1.0 mA max.									
		230 V input	(0.43 mA typ.)			(0.45 mA typ.)			(0.45 mA typ.)			
Inrush current (See note 1.)	100 V input	25 A max. (for a cold start at 25°C)										
	200 V input	50 A max. (for a cold start at 25°C)										
	230 V input	(41 mA typ.)			(34 mA typ.)			(39 mA typ.)				
Output	Voltage adjustment range (See note 2.)	-10% to 15% (with V.ADJ) (guaranteed)						±10% (with V.ADJ) (guaranteed)				
	Ripple	2.0% (p-p) max. (at rated input/output voltage)										
		f=20MHz measuring	(0.66%(p-p) typ.)			(0.45%(p-p) typ.)			(0.13%(p-p) typ.)			
		f=100MHz measuring	(0.67%(p-p) typ.)			(0.52%(p-p) typ.)			(0.21%(p-p) typ.)			
	Input variation influence	0.5% max. (at 85 to 264 VAC input, 100% load)										
	Load variation influence (rated input voltage)	1.5% max. (with rated input, 0 to 100% load)										
	Temperature variation influence	0.05%/°C max.										
	Start up time (See note 1.)	1,000 ms max. (at rated input/output voltage)										
		(380 ms typ.)			(530 ms typ.)			(780 ms typ.)				
	Hold time (See note 1.)	20 ms min. (at rated input/output voltage)										
		at 100% load			(60 ms typ.)			(60 ms typ.)			(30 ms typ.)	
	Additional functions	Overload protection (See note 1.)	105% to 160% of rated load current, voltage drop, intermittent, automatic reset						105% to 160% of rated load current, voltage drop, automatic reset			
		Overvoltage protection (See notes 1 and 3.)	Yes									
Output voltage indication (See note 4.)		No	Yes (selectable) (See note 5.)		No	Yes (selectable) (See note 5.)		No	Yes (selectable) (See note 5.)			
Output current indication (See note 4.)		No	Yes (selectable) (See note 6.)		No	Yes (selectable) (See note 6.)		No	Yes (selectable) (See note 6.)			
Peak-hold current indication (See note 4.)		No	Yes (selectable) (See note 7.)		No	Yes (selectable) (See note 7.)		No	Yes (selectable) (See note 7.)			
Maintenance forecast monitor indication (See note 4.)		No	Yes (selectable)	No	No	Yes (selectable)	No	No	Yes (selectable)	No		
Maintenance forecast monitor output		No	Yes (open collector output), 30 VDC max., 50 mA max. (See note 8.)	No	No	Yes (open collector output), 30 VDC max., 50 mA max. (See note 8.)	No	No	Yes (open collector output), 30 VDC max., 50 mA max. (See note 8.)	No		
Total run time monitor indication (See note 4.)		No	Yes (selectable)	No	Yes (selectable)	No	Yes (selectable)	No	Yes (selectable)	Yes (selectable)		
Total run time monitor output		No	Yes (open collector output), 30 VDC max., 50 mA max. (See note 8.)	No	Yes (open collector output), 30 VDC max., 50 mA max. (See note 8.)	No	Yes (open collector output), 30 VDC max., 50 mA max. (See note 8.)	No	Yes (open collector output), 30 VDC max., 50 mA max. (See note 8.)	Yes (open collector output), 30 VDC max., 50 mA max. (See note 8.)		
Undervoltage alarm indication (See note 4.)		No	Yes (selectable)		No	Yes (selectable)		No	Yes (selectable)			
Undervoltage alarm output terminals		No	Yes (open collector output), 30 VDC max., 50 mA max. (See note 8.)		No	Yes (open collector output), 30 VDC max., 50 mA max. (See note 8.)		No	Yes (open collector output), 30 VDC max., 50 mA max. (See note 8.)			
Parallel operation		No										
Series operation		Yes for up to 2 Power Supplies (with external diode)										
Other		Operating ambient temperature	Refer to the derating curve in <i>Engineering Data</i> . (with no icing or condensation)									
	Storage temperature	-25 to 65°C										
	Operating ambient humidity	25% to 85% (Storage humidity: 25% to 90%)										
	Dielectric strength	3.0 kVAC for 1 min. (between all inputs and outputs/ alarm outputs; detection current: 20 mA)										
		2.0 kVAC for 1 min. (between all inputs and PE terminals; detection current: 20 mA)										
		1.0 kVAC for 1 min. (between all outputs/ alarm outputs and PE terminals; detection current: 20 mA)										
	Insulation resistance	100 MΩ min. (between all outputs/ alarm outputs and all inputs/ PE terminals) at 500 VDC										
	Vibration resistance	10 to 55 Hz, 0.375-mm single amplitude for 2 h each in X, Y, and Z directions										
		10 to 150Hz, 0.35-mm single amplitude (5 G max.) for 80 min each in-X, Y, and Z directions										
	Shock resistance	150 m/s ² , 3 times each in ±X, ±Y, and ±Z directions										
	Output indicator	Yes (color: green)										
	EMI	Conducted Emissions	Conforms to EN61204-3 EN55011 Class A and based on FCC Class A Conforms to EN61204-3 EN55011 Class B (See note 9.)									
		Radiated Emissions	Conforms to EN61204-3 EN55011 Class A Conforms to EN61204-3 EN55011 Class B (See note 9.)									
EMS	Conforms to EN61204-3 high severity levels											
Approved standards	UL: UL508 (Listing), UL60950 cUL: CSA C22.2 No.14, No.60950 EN/VDE: EN50178 (=VDE0160), EN60950 (=VDE0805) SELV (EN60950/UL50178/UL60950-1) According to VDE0106/P100, IP20											
Weight	550 g max.			850 g max.			1,150 g max.					

Connections

Block Diagrams

S8VS-015 (15-W)

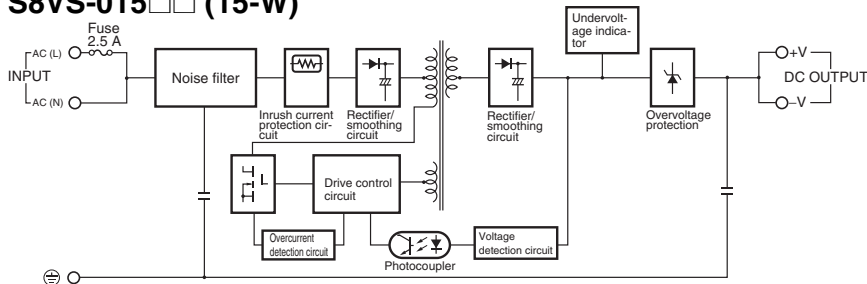

S8VS-030 (30-W)

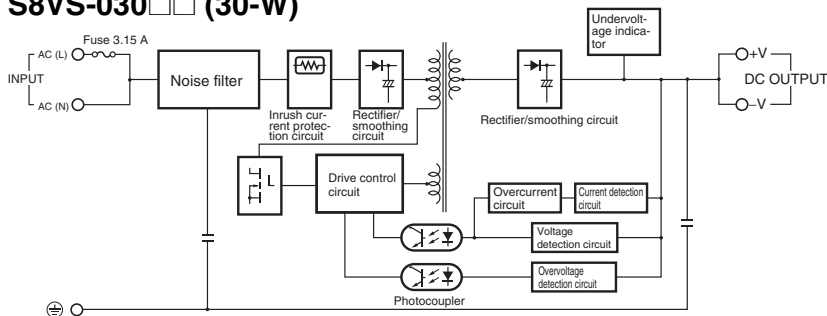

S8VS-06024 (60-W)
S8VS-06024 (60-W)

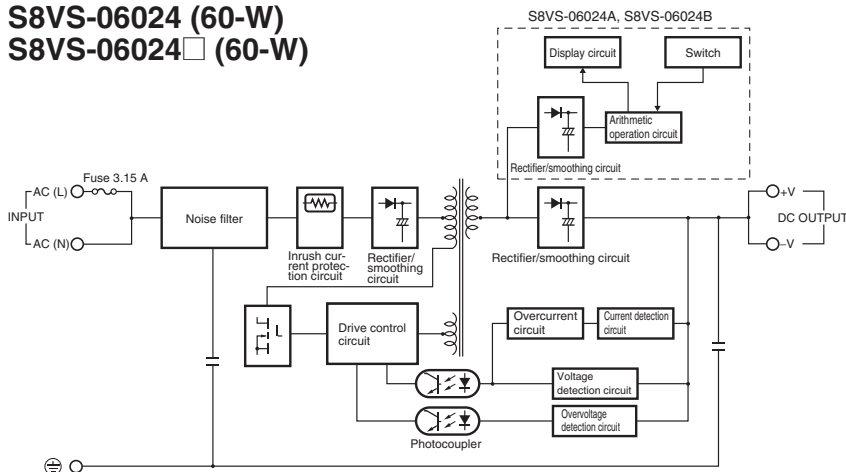

S8VS-09024 (90-W)
S8VS-09024 (90-W)

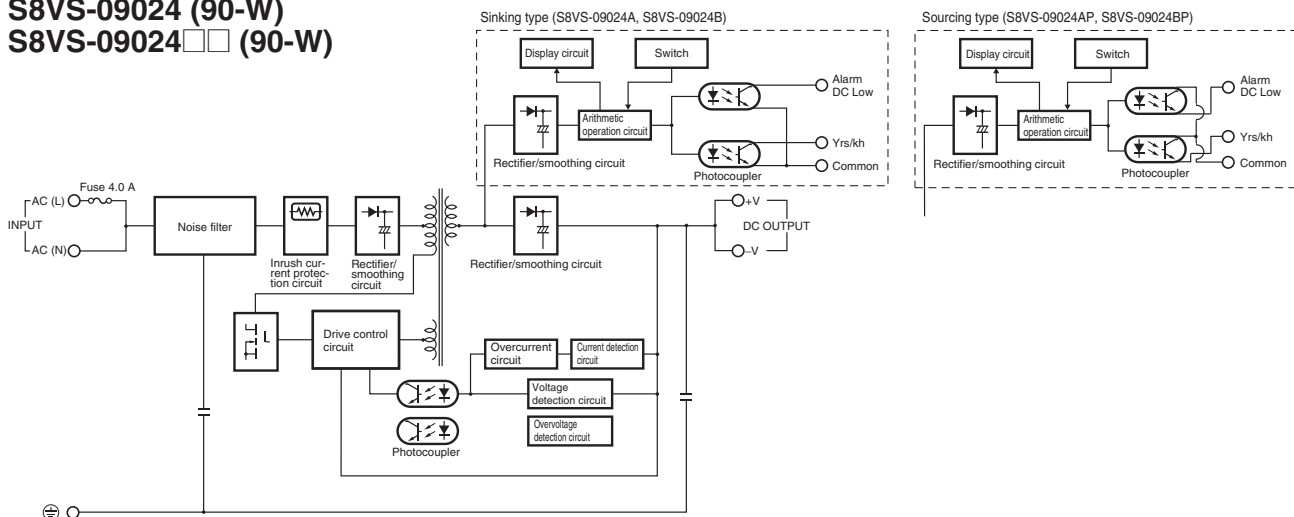

S8VS-12024 (120-W)
S8VS-12024□□ (120-W)

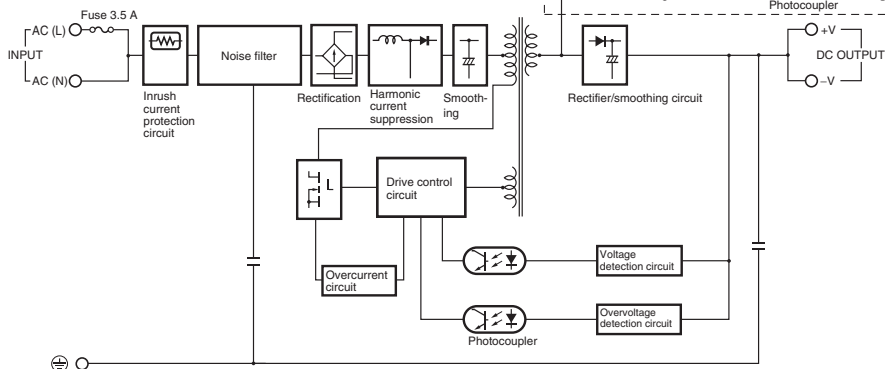

Sinking type (S8VS-12024A, S8VS-12024B)

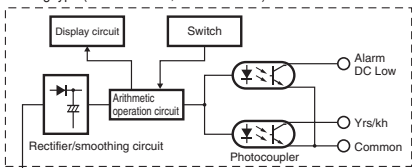

Sourcing type (S8VS-12024AP, S8VS-12024BP)

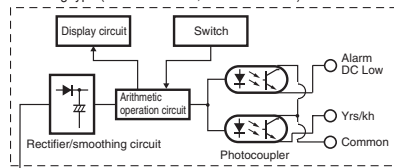

S8VS-18024 (180-W)
S8VS-18024□□ (180-W)

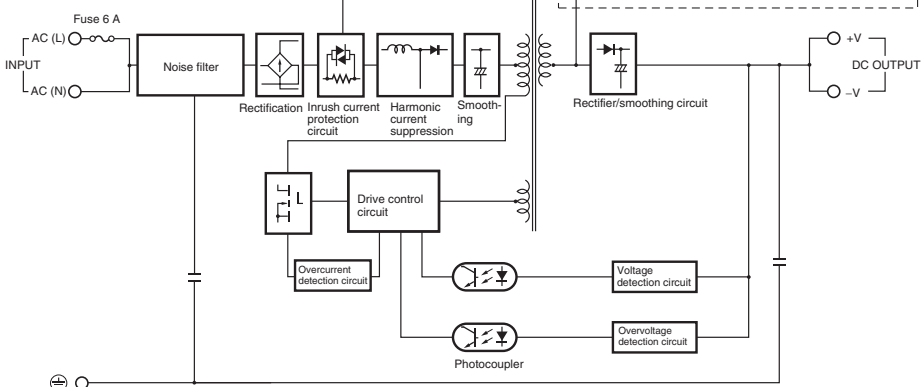

Sinking type (S8VS-18024A, S8VS-18024B)

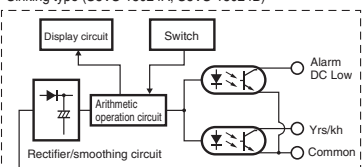

Sourcing type (S8VS-18024AP, S8VS-18024BP)

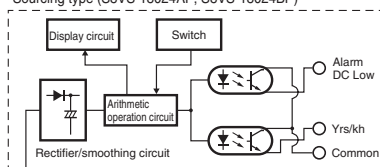

S8VS-24024 (240-W)
S8VS-24024□□ (240-W)

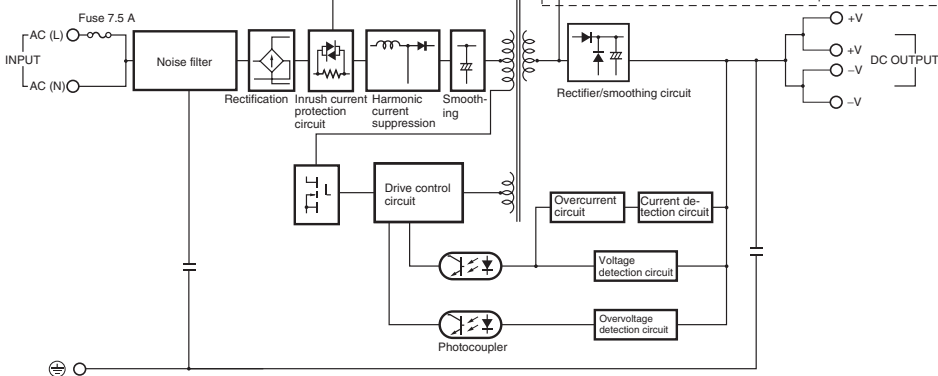

Sinking type (S8VS-24024A, S8VS-24024B)

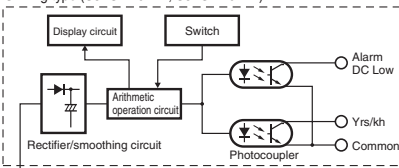

Sourcing type (S8VS-24024AP, S8VS-24024BP)

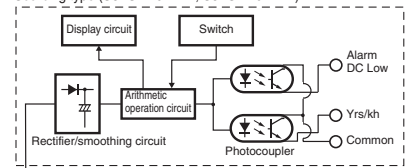

Construction and Nomenclature (15-W, 30-W Models)

■ Nomenclature

15-W, 30-W Models

S8VS-015□□/S8VS-030□□

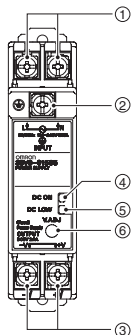

No.	Name	Function
1	AC Input terminals (L), (N)	Connect the input lines to these terminals. (See note 1.)
2	Protective Earth terminal (PE)	Connect the ground line to this terminal. (See note 2.)
3	DC Output terminals (-V), (+V)	Connect the load lines to these terminals.
4	Output indicator (DC ON: Green)	Lights while a direct current (DC) output is ON.
5	Undervoltage indicator (DC LOW: Red)	Lights when a drop is detected in the output voltage.
6	Output voltage adjuster (V.ADJ)	Use to adjust the voltage.

- Note:** 1. The fuse is located on the (L) side. It is NOT user-replaceable.
 2. This is the protective earth terminal specified in the safety standards. Always ground this terminal.

Note: The S8VS-01505 is shown above.

Engineering Data (15-W, 30-W Models)

■ Derating Curve

S8VS-015□□

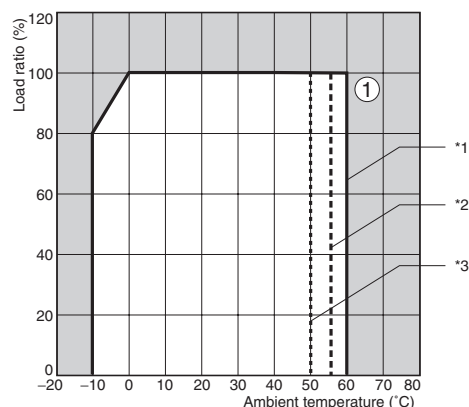

- 1* Standard mounting
- 2* Horizontal mounting
- 3* Mounting facing horizontally

S8VS-03024

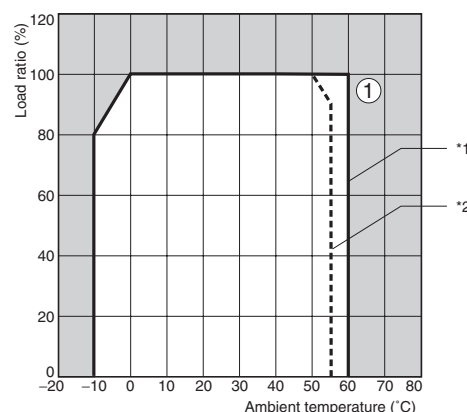

- 1* Standard mounting
- 2* Horizontal mounting/mounting facing horizontally

Note: 1. Internal parts may occasionally deteriorate or be damaged. Do not use the Power Supply in areas outside the derating curve (i.e., the area shown by shading ① in the above graph).

- 2. If there is a derating problem, use forced air-cooling.
- 3. Provide a space of at least 20 mm when using standard mounting and horizontal mounting. If 20 mm is not available, make sure that the space is at least 10 mm. In this case, reduce the corresponding derating curve by 5°C.
- 4. When mounting Power Supplies facing horizontally in a vertical stack, provide a space of at least 75 mm in between the Power Supplies. If 75 mm is not available, reduce the corresponding derating curve by 1°C for every 5-mm reduction in space. A space of at least 25 mm, however, must be provided. In this case, reduce the corresponding derating curve by 10°C.

S8VS-03005/S8VS-03012

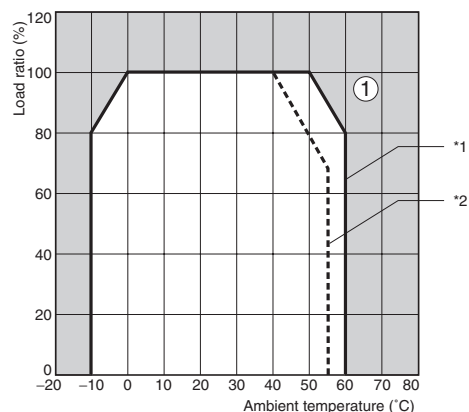

- 1* Standard mounting
- 2* Horizontal mounting/mounting facing horizontally

■ Mounting

Standard mounting with DIN rail

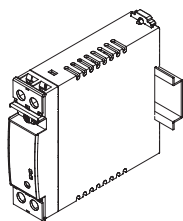

Horizontal mounting with DIN rail

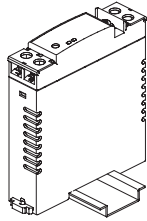

Standard mounting with S82Y-VS30P

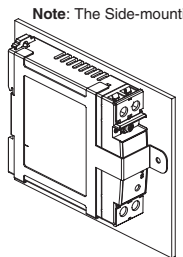

Horizontal mounting with S82Y-VS30P

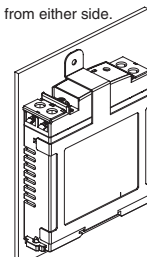

Note: The Side-mounting Bracket can be mounted from either side.

Mounting facing horizontally with S82Y-VS30P

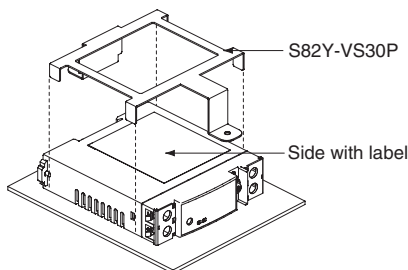

- Note:**
1. Improper mounting will interfere with heat dissipation and may occasionally result in deterioration or damage of internal parts. Use the product within the derating curve for the mounting direction that is used. Do not use the Power Supply mounted in any way not shown above.
 2. Use a mounting bracket (S82Y-VS30P, sold separately) when the Product is mounted facing horizontally.
 3. Heat dissipation will be adversely affected. When the Product is mounted facing horizontally, always place the side with the label facing upward.
 4. Use PFP-M End Plates on the top and bottom of the Power Supply when mounting facing horizontally on a DIN rail.

■ Overload Protection

The Power Supply is provided with an overload protection function that protects the power supply from possible damage by overcurrent. When the output current rises above 105% min. of the rated current, the protection function is triggered, decreasing the output voltage. When the output current falls within the rated range, the overload protection function is automatically cleared.

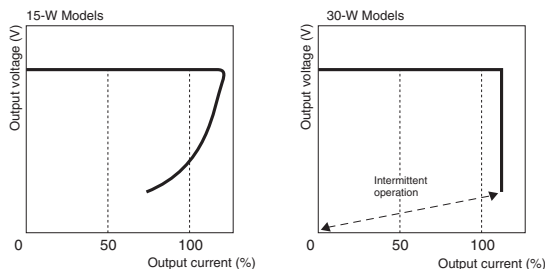

The values shown in the above diagrams are for reference only.

- Note:**
1. Internal parts may occasionally deteriorate or be damaged if a short-circuited or overcurrent state continues during operation.
 2. Internal parts may possibly deteriorate or be damaged if the Power Supply is used for applications with frequent inrush current or overloading at the load end. Do not use the Power Supply for such applications.

■ Overvoltage Protection

Consider the possibility of an overvoltage and design the system so that the load will not be subjected to an excessive voltage even if the feedback circuit in the Power Supply fails. When an excessive voltage that is approximately 130% of the rated voltage or more is output, the output voltage is shut OFF. Reset the Power Supply by turning it OFF for at least three minutes and then turning it back ON again.

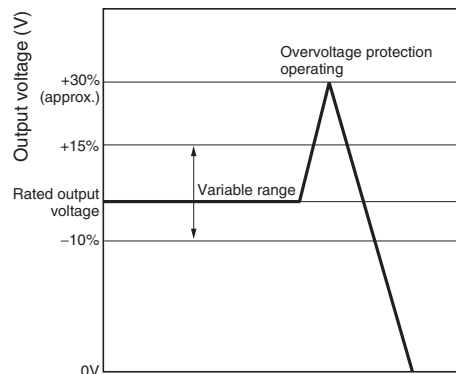

The values shown in the above diagram is for reference only.

- Note:**
1. Do not turn ON the power again until the cause of the overvoltage has been removed.
 2. The overvoltage protection of the S8VS-015□□ uses a zener diode clamp. The output voltage will be clamped at approx. 140% or higher of the rated output voltage (approx. 140% to 190%). If the internal feedback circuit is destroyed by any chance, the load may be destroyed by the clamped output voltage (approx. 140% to 190% of the rated output voltage). The power Supply will not restart if the output is turned OFF by the overvoltage protection operation. If this occurs, replace the Power Supply.

■ Inrush Current, Start Up Time, Output Hold Time

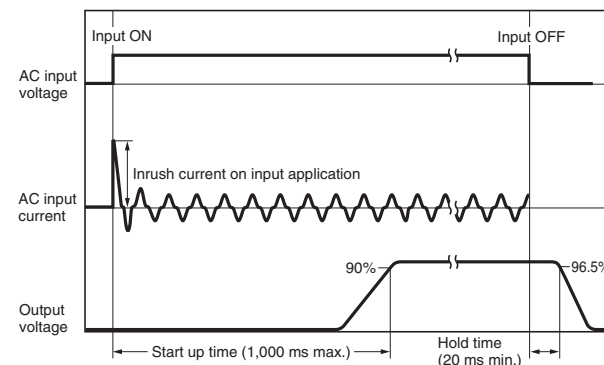

■ Undervoltage Alarm Indication

LED (DC LOW red) lights to warn of output voltage drop. Detection voltage is set to approx. 80% (75 to 90%) of the rated output voltage.

Note: This function monitors the voltage at the power supply output terminals. To check actual voltage, measure voltage on the load side.

■ Reference Values

Item	Value
Reliability (MTBF)	15 W: 610,800 hrs, 30 W: 656,400 hrs
Life expectancy	10 yrs. min.

Note: Refer to page 15 for definitions of MTBF and life expectancy.

Construction and Nomenclature (60-W, 90-W, 120-W, 180-W, and 240-W Models)

Nomenclature

60-W Models

Standard Model

S8VS-06024

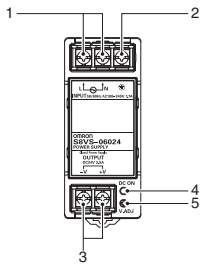

Models with Display Monitor

S8VS-06024□

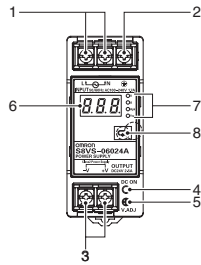

Note: The S8VS-06024A is shown above.

90-W/120-W Models

Standard Models

S8VS-09024/S8VS-12024

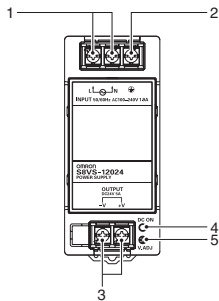

Models with Display Monitor

S8VS-09024□□/S8VS-12024□□

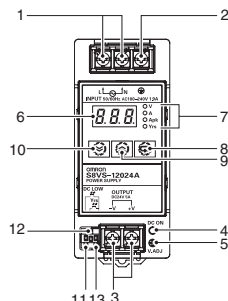

Note: The S8VS-12024A is shown above.

180-W Models

Standard Model

S8VS-18024

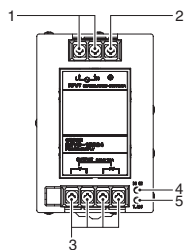

Models with Display Monitor

S8VS-18024□□

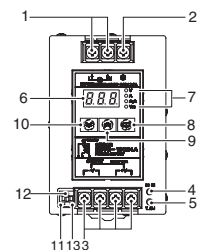

Note: The S8VS-18024A is shown above.

240-W Models

Standard Model

S8VS-24024

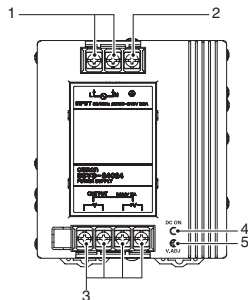

Models with Display Monitor

S8VS-24024□□

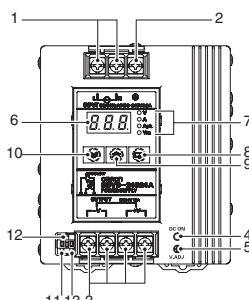

Note: The S8VS-24024A is shown above.

No.	Name	Function	
1	AC Input terminals (L), (N)	Connect the input lines to these terminals. (See note 1.)	
2	Protective Earth terminal (PE)	Connect the ground line to this terminal. (See note 2.)	
3	DC Output terminals (-V), (+V)	Connect the load lines to these terminals.	
4	Output indicator (DC ON: Green)	Lights while a direct current (DC) output is ON.	
5	Output voltage adjuster (V.ADJ)	Use to adjust the voltage.	
6	Main display (Red) (See note 3.)	Indicates the measurement or set value.	
7	Operation indicator (Orange) (See note 3.)	V	Lights up when the output voltage is indicated. Blinks during setup of undervoltage alarm value.
		A	Lights up during indication of output current.
		Apk	Lights up during indication of peak hold current.
		Yrs	Lights up during indication of maintenance forecast monitor. Blinks during setup of maintenance forecast monitor setting. (S8VS-□□□24A□)
7	Operation indicator (Orange) (See note 3.)	kh	Lights up during indication of total run time monitor. Blinks during setup of total run time monitor. (S8VS-□□□24B□)
8	Mode Key (See note 3.)	Use the Mode Key to change the indicated parameter or reset the peak hold current value.	
9	Up Key (See note 4.)	Use the Up Key to change to the setting mode or to increase the set value.	
10	Down Key (See note 4.)	Use the Down Key to change to the setting mode or to decrease the set value.	
11	Alarm outputs (See notes 4 and 5.)	Undervoltage output terminal (DC Low)	Output when a drop is detected in the output voltage (voltage drop = transistor OFF).
12		Maintenance Forecast output terminal (Yrs) (See note 6.)	Output when the set value for maintenance is reached (transistor OFF).
12	Total run time output terminal (kh) (See note 7.)		Output when the set value for total run time is reached (transistor OFF).
13	Common terminal	Common terminal (emitter) for terminals 11 and 12.	

Note: 1. The fuse is located on the (L) side. It is NOT user-replaceable.

2. This is the protective earth terminal specified in the safety standards. Always ground this terminal.

3. S8VS-□□□24□□ only.

4. S8VS-□□□24□□ only (excluding S8VS-06024□).

5. Both sinking and sourcing outputs are available.

6. S8VS-□□□24A□ only (excluding S8VS-06024A).

7. S8VS-□□□24B□ only (excluding S8VS-06024B).

Engineering Data (S8VS-□□□24□□ Only)

Mode Change

S8VS-□□□24A□ Models (with display monitor) can display the output voltage, output current, peak hold current, or maintenance forecast monitor time. S8VS-□□□24B□ Models (with display monitor) can display the output voltage, output current, peak hold current, or total run time.

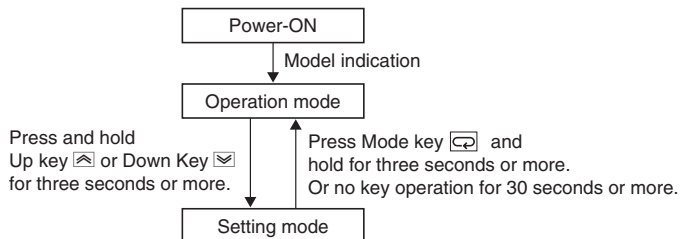

Note: No setting mode is provided for the S8VS-06024□.

Operation Mode

Various states of the Power Supply are indicated.

Models with Maintenance Forecast Monitor (S8VS-□□□24A□)

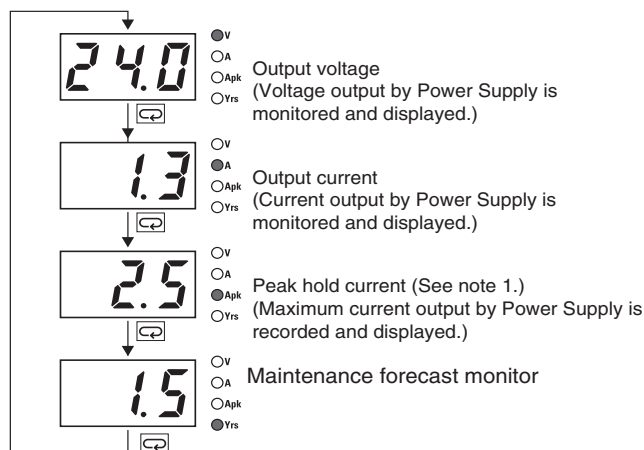

Models with Total Run Time Monitor (S8VS-□□□24B□)

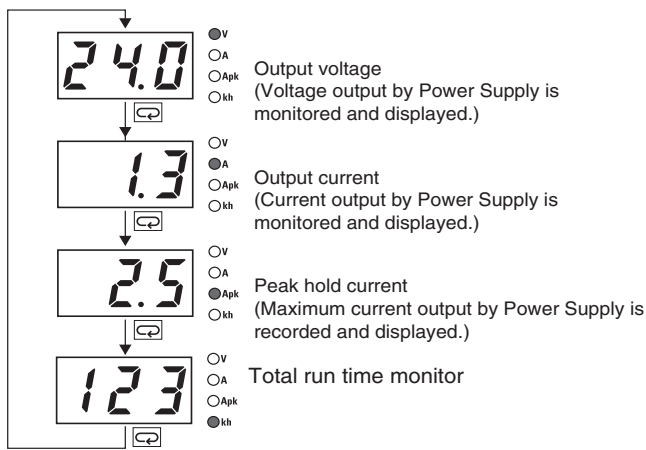

- Note:**
- The peak hold current starts measuring the current 3 seconds after the Power Supply is started. Inrush current is thus not measured.
 - For the factory setting, the output voltage will be displayed when the power supply is first turned ON. Thereafter, the output voltage will be indicated in the same display when shutting down.

Setting Mode (Except for S8VS-06024□)

Set various parameters of the Power Supply.

Models with Maintenance Forecast Monitor (S8VS-□□□24A□)

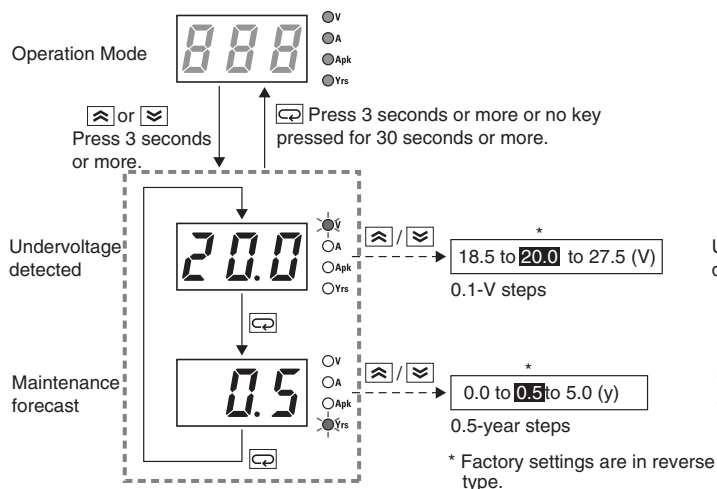

Models with Total Run Time Monitor (S8VS-□□□24B□)

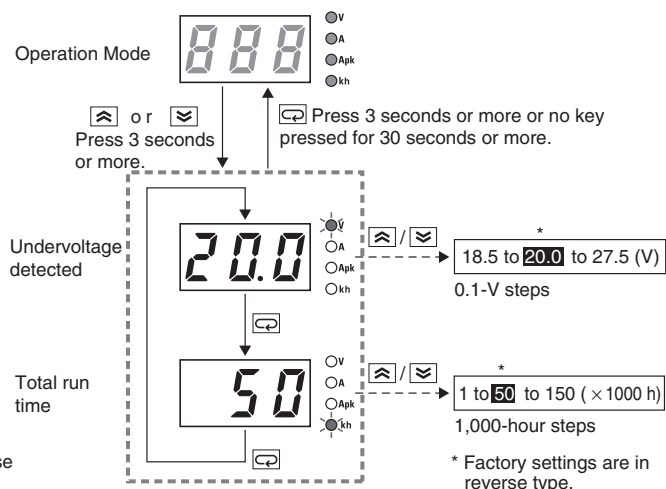

- Note:**
- Press and hold the (9) Up Key (▲) or (10) Down Key (▼) for two seconds or more to increase or decrease the value rapidly.
 - The S8VS-06024□ is not provided with the setting mode and its parameters are fixed at the shipment setting.

■ Peak Hold Current Reset

The peak value of the output current (i.e., the peak hold current) can be reset on the display.

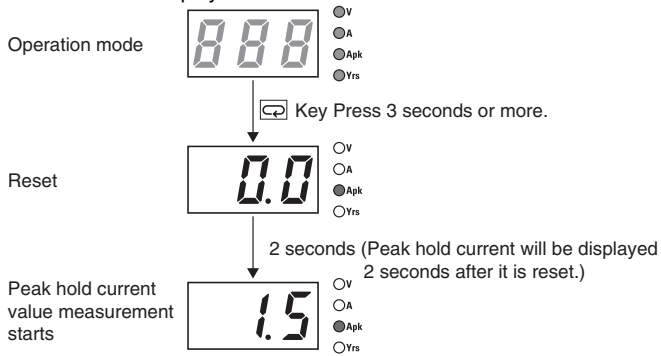

Note: The peak hold current value is not reset in the setting mode.

■ Undervoltage Alarm Indication

This indicator lights when the output voltage is insufficient.

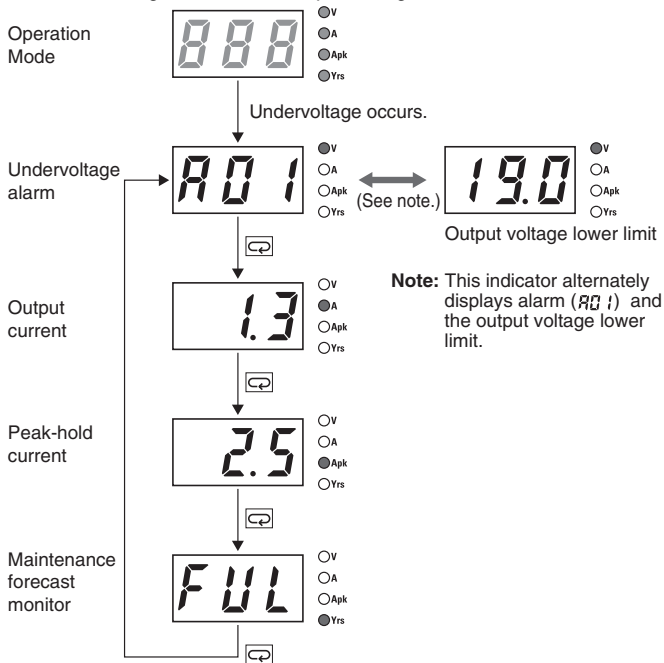

Note: 1. The display changes to the output voltage display when the voltage is restored to the set value or higher.

2. The above displays are for models with a maintenance forecast monitor (S8VS-□□□24A□).

■ Multiple Alarms

When two or more different alarms occur at the same time

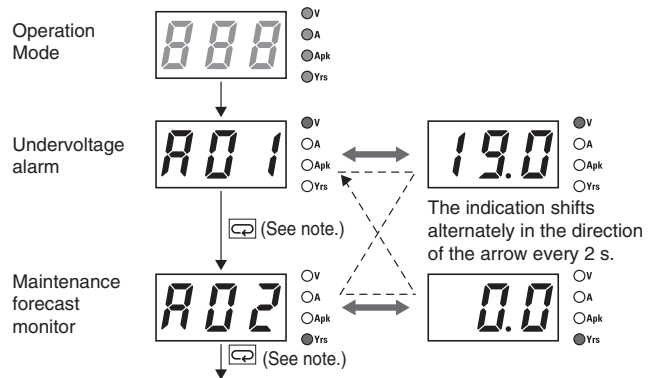



Note: 1. When undervoltage alarm is indicated: Press → output load indication When the maintenance forecast monitor or overheat alarm is indicated: Press → undervoltage alarm indication

2. The above displays are for models with a maintenance forecast monitor (S8VS-□□□24A□).

■ Self-Diagnostics Function

Numbers in the following table indicate the number used in *Nomenclature* on pages 8 and 10.

(6) Main display	Description	Output status	Restoration method	Setting after restoration
- - -	Noise detected in voltage or current	No change	Automatic restoration	No change
Hot	Overheated	(12) Maintenance forecast output terminal (Yrs) turns OFF.	Automatic restoration	No change
E01	Undervoltage alarm set value memory error	(11) Undervoltage output terminal (DC LOW) turns OFF.	Press and hold the (9) Up Key  or (10) Down Key  for three seconds and check the set value of the corresponding point. The set value must return to the shipment setting	Shipment setting or value set in the setting mode again
E02	Memory error of alarm set value of maintenance forecast monitor or total run time monitor	(12) Maintenance forecast output terminal (Yrs) turns OFF or total run time output terminal (kh) turns OFF.		
E03	Other memory error	(11) Undervoltage output terminal (DC LOW) turns OFF. (12) Maintenance forecast output terminal (Yrs) turns OFF or total run time output terminal (kh) turns OFF.	Turn the AC input OFF then ON again. If the product is not reset, contact the dealer.	No change

- Note:**
- External noise is probable as a cause of “- - -”, “E01”, “E02” and “E03” errors.
 - Operation out of the derating curve area, ventilation error, and incorrect mounting direction are probable as a cause of “Hot” error.
 - If the “Hot” error state continues for more than three hours, the maintenance forecast monitor function becomes invalid. The Yrs output ((12) Maintenance forecast output terminal (Yrs)) will remain OFF (no continuity between (12) Maintenance forecast output terminal (Yrs) and (13) Alarm output common terminal).
Replace the power supply if this condition occurs even if the output is correct, as internal parts may be deteriorated.
 - The “Hot” error detection function is only for the S8VS-□□□24A□.

■ Maintenance Forecast (S8VS-□□□24A□)

Displays when the maintenance forecast has reached the set value.

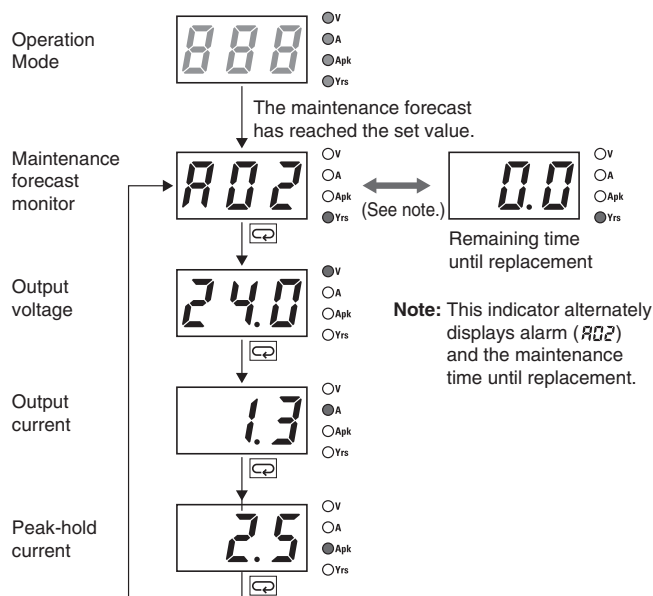

■ Indication and Output

When the product is purchased, "FUL" will be indicated. As electrolytic capacitors deteriorate, indication changes to "HLF". "FUL" will be indicated for the maintenance forecast display for approximately one month after the Power Supply is first turned ON. The accumulated value will then be displayed depending on the ambient conditions thereafter. (However, the "HLF" indication may not appear, depending on the usage environment and the set value for maintenance forecast.)

S8VS-06024A:

After the remaining time to maintenance is reduced to less than two years, indication automatically changes to a value, which decreases from "1.5" to "1.0" to "0.5" to "0.0" (year) as the running hours increase. If the remaining time becomes less than 0.5 year, an alarm (A02) and "0.0" are indicated alternately.

S8VS-09024A□/S8VS-12024A□, S8VS-18024A□/S8VS-24024A□:

If the maintenance forecast setting L (which can be set arbitrarily from 0.0 to 5.0 years in 0.5-year steps) is set to a value larger than two years, the indication automatically changes to a value (L - 0.5) after the remaining time to maintenance is reduced to the set years, and an alarm (A02) and the remaining time are indicated alternately.

If the setting is less than 2.0 years, the indication changes to a value (1.5) after the remaining time becomes less than two years, and after the remaining time becomes less than the set time, an alarm (A02) and the remaining time (L - 0.5) are indicated alternately.

If the alarm (A02) and a numeric value are indicated alternately, a transistor ((12) maintenance forecast output terminal (Yrs)) will turn OFF to indicate the need for maintenance. (The transistor turns OFF when the maintenance forecast time is reached, i.e., there will be no continuity between (12) maintenance forecast output terminal (Yrs) and (13) alarm output common terminal.)



- Note:**
1. The remaining time to maintenance is based on continuous operation, not including the time when the power supply is turned OFF.
 2. "FUL" will be indicated until approximately one month of time is accumulated to estimate the speed of deterioration and the output will remain ON (continuity between (12) maintenance forecast output terminal (Yrs) and (13) alarm output common terminal).
 3. For details on the display, refer to *Relationship between Indication Value and Outputs of Set Value under Maintenance Forecast Monitor Function*.

Maintenance Forecast Monitor Function

The Power Supply is equipped with electrolytic capacitors.

The electrolyte inside the electrolytic capacitor penetrates the sealing rubber and evaporates as time passes since it is manufactured, which causes deterioration of characteristics such as decreasing the capacitance, etc.

Due to this deterioration of the characteristics of the electrolytic capacitor, the Power Supply decreases its performance as time passes.

The maintenance forecast monitor function shows an approximate period left for maintenance of the Power Supply due to deterioration of electrolytic capacitors. When the period left for maintenance that the power supply forecasts reaches the set value, an alarm is indicated and an output signal is triggered.

Use this function to know the approximate replacement timing of the Power Supply.

Note: The maintenance forecast monitor function indicates an approximate period left for maintenance, based on deterioration of the electrolytic capacitor. It does not predict failures caused by other reasons.

Relationship between Indicated Values and Output of Set Values

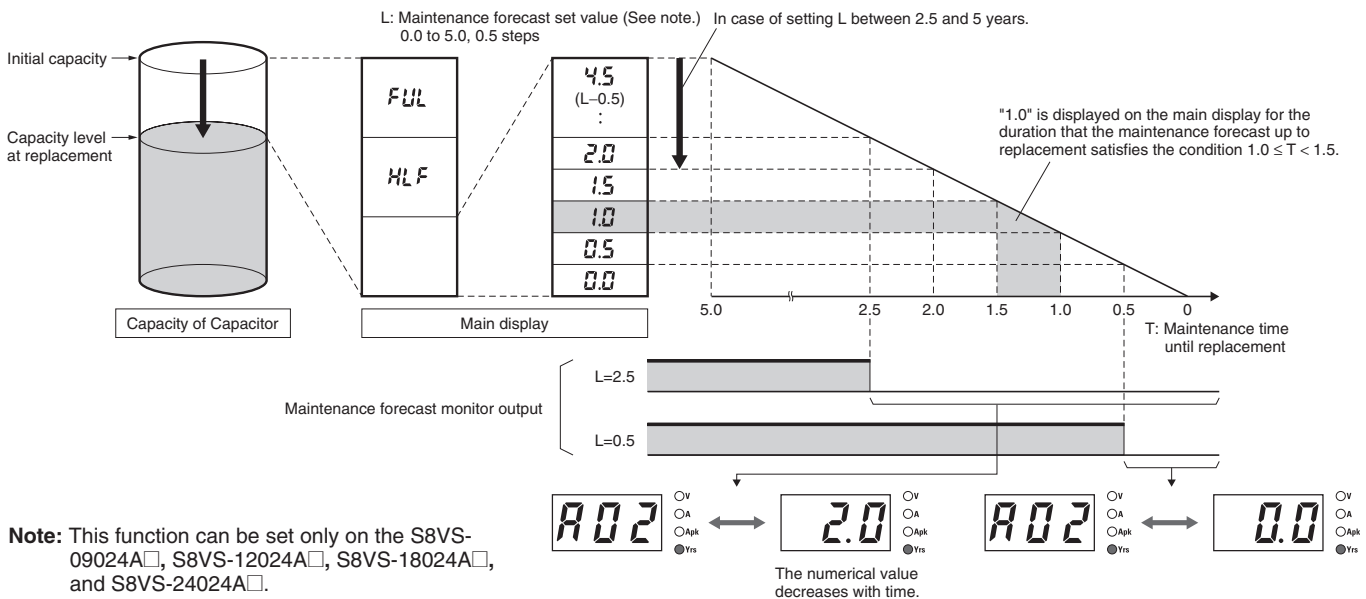

Principle of Operation

The deterioration speed of the electrolytic capacitor varies considerably according to the ambient temperature. (Generally the speed follows "Rule of Two for every 10°C"; for every 10°C increase in temperature the rate of degradation doubles according to Arrhenius's equation.) The S8VS-□□□24A□ monitors the temperature inside the power supply, and calculates the amount of deterioration according to the running hours and inside temperature. Judging by this amount of deterioration, the power supply will give the alarm indication and output when the period left for maintenance reaches the set value.

- Note:**
- Due to degradation of internal electronic parts, replace the power supply approximately 15 years after purchase even if indication and output of maintenance forecast monitor are not issued.
 - The maintenance forecast is accelerated or decelerated according to operating conditions. Periodically check indication.
 - Acceleration or deceleration of the maintenance forecast may cause the output to repeatedly go ON/OFF. Only the S8VS-09024A□, S8VS-12024A□, S8VS-18024A□, and S8VS-24024A□ are equipped with output.
 - The accuracy of the maintenance forecast function may be adversely affected by applications in which the AC input is frequently turned ON/OFF.

Reference Values

Reliability (MTBF)	Value
	Standard types
	<ul style="list-style-type: none"> • With Maintenance Forecast Monitor types • With Total Run Time Monitor types
60 W:	400,000 hrs, 230,000 hrs,
90 W:	390,000 hrs, 200,000 hrs,
120 W:	280,000 hrs, 190,000 hrs,
180 W:	260,000 hrs, 180,000 hrs,
240 W:	220,000 hrs, 160,000 hrs,
Definition	MTBF stands for Mean Time Between Failures, which is calculated according to the probability of accidental device failures, and indicates reliability of devices. Therefore, it does not necessarily represent a life of the product.
Life expectancy	10 yrs. min.
Definition	The life expectancy indicates average operating hours under the ambient temperature of 40°C and a load rate of 50%. Normally this is determined by the life expectancy of the built-in aluminum electrolytic capacitor.

Note: The maintenance forecast is the service life (the power supply's internal temperature is monitored at all times) of the internal electrolytic capacitor in actual operating conditions, and varies according to the customer's operating conditions. 15 years is taken as the maximum period of the maintenance forecast.

■ Models with Total Run Time Monitor (S8VS-□□□24B□)

S8VS-06024B

The accumulated value of the operating time of the Power Supply is displayed as the total run time. 0 (kh) will be displayed initially after purchase and then the display will advance in 1-kh steps as the operating time accumulates. The S8VS-06024B, however, does not have an alarm function (setting, display, or output).

S8VS-09024B□/S8VS-12024B□/

S8VS-18024B□/S8VS-24024B□

The display will appear when the set value for the total run time has been reached.

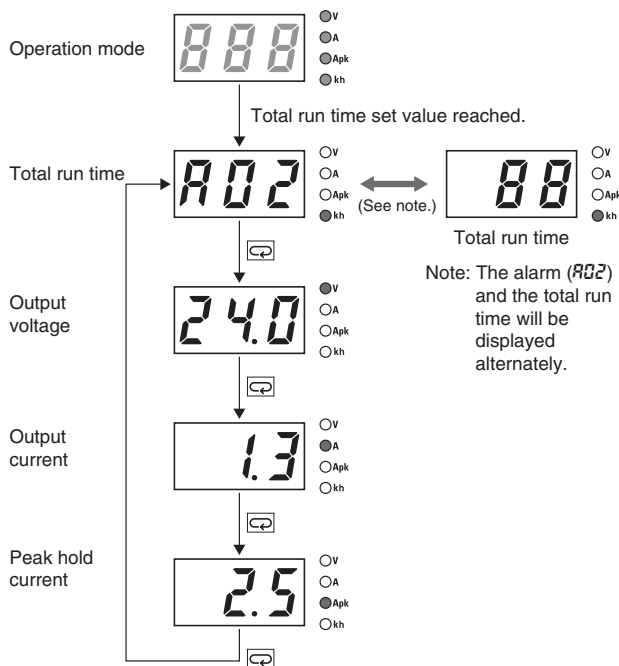

The accumulated value of the operating time of the Power Supply is displayed as the total run time. 0 (kh) will be displayed initially after purchase and then the display will advance in 1-kh steps as the operating time accumulates. When the total run time reaches the preset alarm set value, the alarm (R02) and the total run time will be displayed alternately and a transistor ((12) total run time output terminal (kh)) will output the status externally.

(Alarm set value reached = OFF, i.e., no continuity between (12) total run time output terminal (kh) and (13) alarm output common terminal)

The alarm set value can be changed in the setting mode.

Example: Alarm Displays When a Total Run Time Set Value of 88 kh Is Reached



Note: The total run time cannot be reset. To clear the alarm, change the alarm set value to a value higher than the value displayed for the total run time.

Time Chart

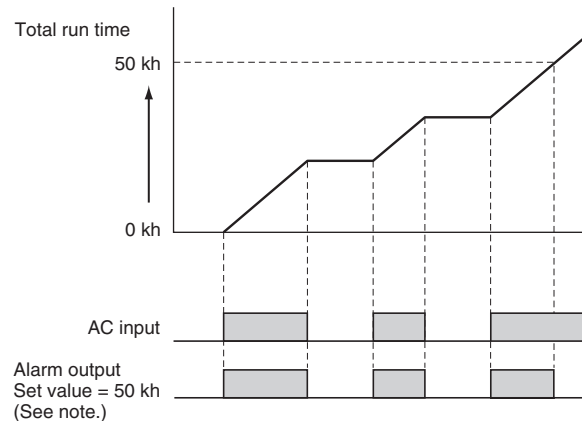

Note: Setting is possible for the following models only: S8VS-09024B□, S8VS-12024B□, S8VS-18024B□, S8VS-24024B□

- Note: 1.** The total run time does not include the time that the Power Supply is OFF.
- Note: 2.** The total run time measures the total time that power is being supplied and is not related in any way to deterioration in the electrolytic capacitor built into the Power Supply or to the effects of the ambient temperature.

Engineering Data (60-W, 90-W, 120-W, 180-W, 240-W Models)

Derating Curve

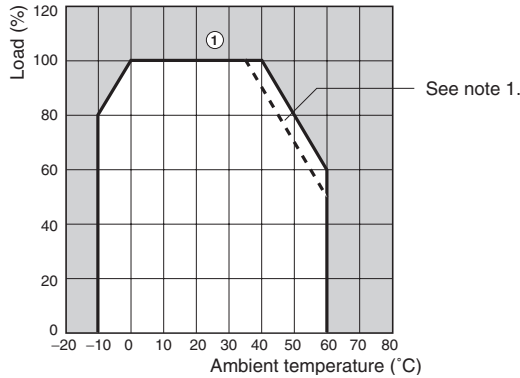

Note: 1. Using side mounting bracket for right-side mounting (excluding 240-W Models).

2. Internal parts may occasionally deteriorate or be damaged. Do not use the Power Supply in areas outside the derating curve (i.e., the area shown by shading ① in the above graph),

3. If there is a derating problem, use forced air-cooling.

Mounting

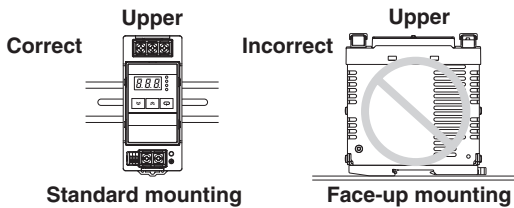

Note: Improper mounting will interfere with heat dissipation and may occasionally result in deterioration or damage of internal parts. It may also result in failure of the maintenance forecast monitor function. Use the standard mounting method only.

Overload Protection

The Power Supply is provided with an overload protection function that protects the power supply from possible damage by overcurrent. When the output current rises above 105% min. of the rated current, the protection function is triggered, decreasing the output voltage. When the output current falls within the rated range, the overload protection function is automatically cleared.

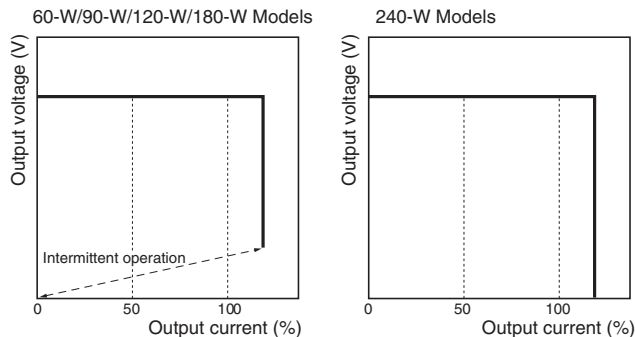

The values shown in the above diagrams are for reference only.

Note: 1. Internal parts may occasionally deteriorate or be damaged if a short-circuited or overcurrent state continues during operation.
2. Internal parts may possibly deteriorate or be damaged if the Power Supply is used for applications with frequent inrush current or overloading at the load end. Do not use the Power Supply for such applications.

Overvoltage Protection

Consider the possibility of an overvoltage and design the system so that the load will not be subjected to an excessive voltage even if the feedback circuit in the Power Supply fails. When an excessive voltage that is approximately 130% of the rated voltage or more is output, the output voltage is shut OFF. Reset the Power Supply by turning it OFF for at least three minutes and then turning it back ON again.

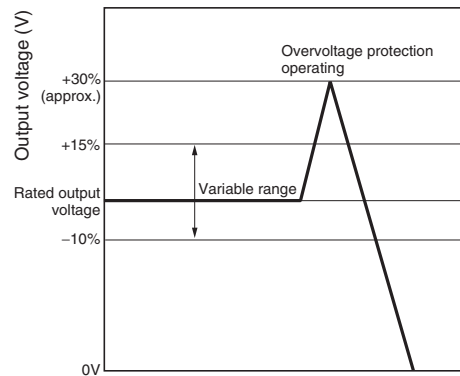

The values shown in the above diagram is for reference only.

Note: Do not turn ON the power again until the cause of the overvoltage has been removed.

Inrush Current, Start Up Time, Output Hold Time

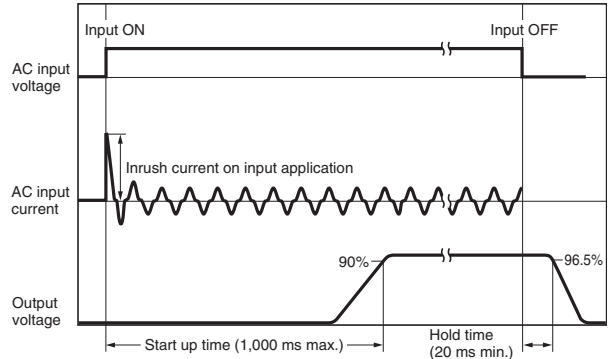

■ Undervoltage Alarm Function (Indication and Output) (S8VS-□□□24□□ Only)

When output voltage drop is detected, an alarm (*RD*) and lowest output voltage value are indicated alternately. The preset value of detection voltage can be changed in the setting mode.

(From 18.5 to 27.5 V (18.5 to 26.3 V for the S8VS-24024□□), in 0.1-V steps. The value is fixed at 20.0 V for the S8VS-06024□.)

Further, an output ((11) undervoltage output terminal (DC LOW)) to an external device is given from the transistor to notify of the error (excluding S8VS-06024□). (Output voltage drop = OFF, i.e., no continuity between (11) undervoltage output terminal (DC LOW) and (13) alarm output common terminal.)

Example: Outputting an Alarm When the Voltage Output by the S8VS-09024□□ Drops to the Set Value (19.0 V) or Lower



- Note:**
1. Operation begins after about three seconds since the AC power is supplied.
 2. The alarm is not indicated in the setting mode.
 3. Press the ((8) Mode Key) after the output voltage is restored, to reset alarm indication.
 4. The undervoltage alarm function monitors the output terminal voltage of the Power Supply. To check the voltage accurately, measure the voltage at the load end.

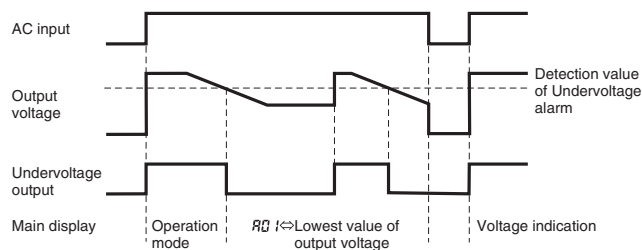

- Note:**
1. Operation begins after about three seconds since the AC power is supplied.
 2. The undervoltage alarm function may also operate when an interruption in AC input is not restored within 20 ms.

Dimensions

Note: All units are in millimeters unless otherwise indicated.

S8VS-015□□ (15-W)
S8VS-030□□ (30-W)

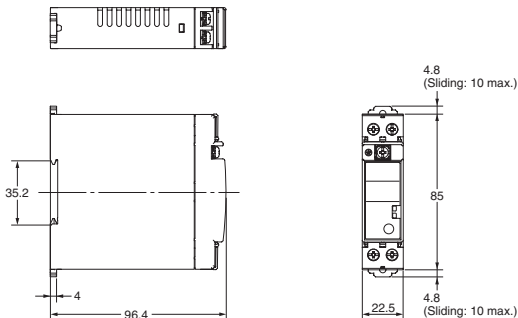
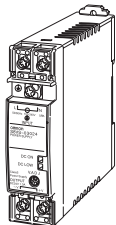

Note: The illustration is the S8VS-03024 Model.

S8VS-06024 (60-W)
S8VS-06024□ (60-W)

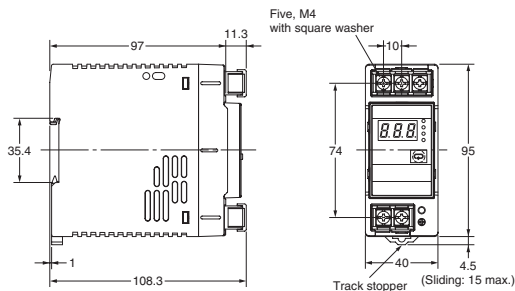
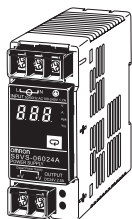

Note: The illustration is the S8VS-06024A Model.

S8VS-09024 (90-W)/S8VS-12024 (120-W)
S8VS-09024□□ (90-W)/**S8VS-12024**□□ (120-W)

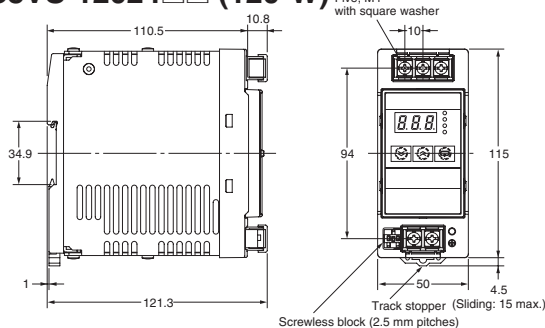
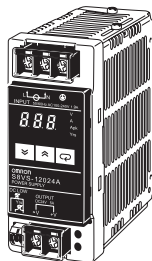

Note: The illustration is the S8VS-12024A Model.

S8VS-18024 (180-W)
S8VS-18024□□ (180-W)

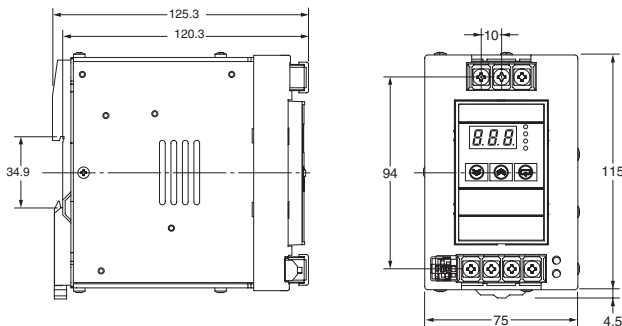
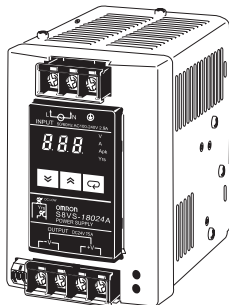

Note: The illustration is the S8VS-18024A Model.

S8VS-24024 (240-W)
S8VS-24024□□ (240-W)

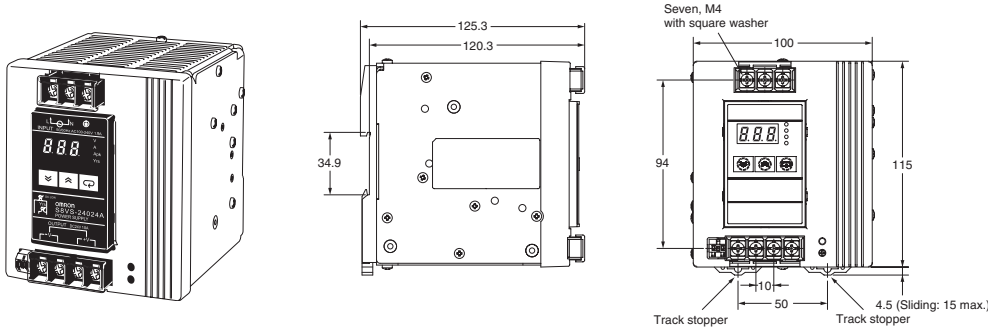

Note: The illustration is the S8VS-24024A Model.

■ DIN Rail (Order Separately)

Note: All units are in millimeters unless otherwise indicated.

Mounting Rail (Material: Aluminum)

PFP-100N
PFP-50N

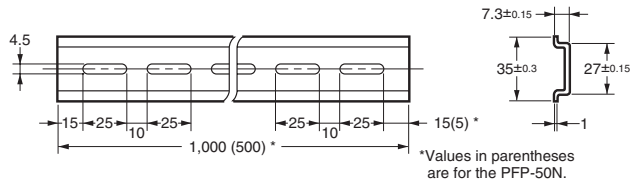
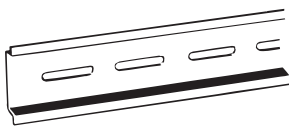

Mounting Rail (Material: Aluminum)

PFP-100N2

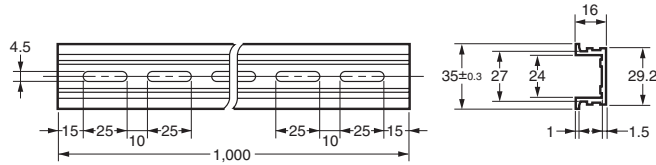

End Plate

PFP-M

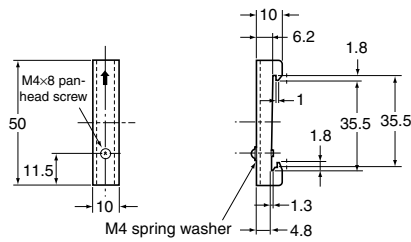
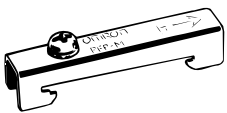

■ Mounting Brackets

Name	Model
Side-mounting Bracket (for 15- and 30-W models)	S82Y-VS30P
Side-mounting Bracket (for 60-, 90-, and 120-W models)	S82Y-VS10S
Side-mounting Bracket (for 180-W models)	S82Y-VS15S
Side-mounting Bracket (for 240-W models)	S82Y-VS20S
Front-mounting Bracket (for 60-, 90-, 120-, 180-, and 240-W models) (See note.)	S82Y-VS10F

Note: Two required to mount a 240-W model.

Type	Model	Dimensions	Appearance
Side-mounting Bracket (For 15-, 30-W models)	S82Y-VS30P	<p>Note: 1. Direction of the return section: Inside of the bend 2. Height of the return section: 0.1 max. 3. Radius of the inside of the bend: R2 4. Angle of the bend: 90°±1°</p>	
Side-mounting Bracket (For 60-, 90-, 120-W models)	S82Y-VS10S		<p>Left-side mounting Right-side mounting</p>
Side-mounting Bracket (For 180-W models)	S82Y-VS15S		<p>Left-side mounting</p> <p>*Right-side mounting also possible.</p>
Side-mounting Bracket (For 240-W models)	S82Y-VS20S		<p>Left-side mounting</p> <p>*Right-side mounting also possible.</p>
Front-mounting Bracket (For 60-, 90-, 120-, 180-, and 240-W models)	S82Y-VS10F		<p>(For 60-, 90-, 120-, 180-W types) (For 240-W type)</p> <p>*Use two S82Y-VS10F brackets for the 240-W type.</p>

Safety Precautions

CAUTION

Minor electric shock, fire, or Product failure may occasionally occur. Do not disassemble, modify, or repair the Product or touch the interior of the Product.



Minor burns may occasionally occur. Do not touch the Product while power is being supplied or immediately after power is turned OFF.



Fire may occasionally occur. Tighten terminal screws to the specified torque (15 and 30 W Models: 0.8 to 1.0 N·m, 60, 90, 120, 180, and 240 W Models: 1.08 N·m).



Minor injury due to electric shock may occasionally occur. Do not touch the terminals while power is being supplied. Always close the terminal cover after wiring.



Minor electric shock, fire, or Product failure may occasionally occur. Do not allow any pieces of metal or conductors or any clippings or cuttings resulting from installation work to enter the Product.



Precautions for Safe Use

Mounting

Take adequate measures to ensure proper heat dissipation to increase the long-term reliability of the product. Be sure to allow convection in the atmosphere around devices when mounting. Do not use in locations where the ambient temperature exceeds the range of the derating curve.

When cutting out holes for mounting, make sure that cuttings do not enter the interior of the products.

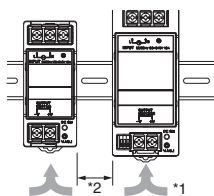

- *1. Convection of air
- *2. 20 mm min.
If 20 mm is not available, however, at least 10 mm must be provided.

(15-W and 30-W Models)

Improper mounting will interfere with heat dissipation and may occasionally result in deterioration or damage of internal parts. Use the product within the derating curve for the mounting direction that is used.

Use a mounting bracket when the product is mounted facing horizontally.

Heat dissipation will be adversely affected. When the product is mounted facing horizontally, always place the side with the label facing upward.

Always provide a space of 20 mm even when mounting horizontally or facing horizontally. If a space of 20 mm is not available, at least 10 mm must be provided. When mounting Power Supplies facing horizontally in a vertical stack, provide a space of at least 75 mm in between the Power Supplies. For details, refer to *Derating Curve* on page 8.

(60-W, 90-W, 120-W, 180-W and 240-W Models)

Improper mounting will interfere with heat dissipation and may occasionally result in deterioration or damage of internal parts. Use the standard mounting method only.

Wiring

Connect the ground completely. A protective earthing terminal stipulated in safety standards is used. Electric shock or malfunction may occur if the ground is not connected completely.

Minor fire may possibly occur. Ensure that input and output terminals are wired correctly.

Do not apply more than 100 N force to the terminal block when tightening it.

Be sure to remove the sheet covering the product for machining before power-ON so that it does not interfere with heat dissipation.

Use the following material for the wires to be connected to the S8VS to prevent smoking or ignition caused by abnormal loads.

Recommended Wire Type

15-W and 30-W Models

Model	Stranded wire	Solid wire
S8VS-03005	AWG18 to 14 (0.9 to 2.0 mm ²)	AWG18 to 16 (0.9 to 1.1 mm ²)
Other models	AWG20 to 14 (0.5 to 2.0 mm ²)	AWG20 to 16 (0.5 to 1.1 mm ²)

60-W, 90-W, 120-W, 180-W and 240-W Models

Model	Recommended wire size	
	For screw terminal	For alarm output terminal
S8VS-06024□	AWG14 to 20 (Cross section 0.517 to 2.081mm ²)	---
S8VS-09024□□ S8VS-12024□□ S8VS-18024□□ S8VS-24024□□	AWG14 to 18 (Cross section 0.823 to 2.081mm ²)	AWG18 to 28 (Cross section 0.081 to 0.823mm ²)

Installation Environment

Do not use the Power Supply in locations subject to shocks or vibrations. In particular, install the Power Supply as far away as possible from contactors or other devices that are a vibration source.

Install the Power Supply well away from any sources of strong, high-frequency noise and surge.

Operating Life

The life of a Power Supply is determined by the life of the electrolytic capacitors used inside. Here, Arrhenius's Law applies, i.e., the life will be cut in half for each rise of 10°C or the life will be doubled for each drop of 10°C. The life of the Power Supply can thus be increased by reducing its internal temperature.

Ambient Operating and Storage Environments

Store the Power Supply at a temperature of -25 to 65°C and a humidity of -25% to 90%.

Do not use the Power Supply in areas outside the derating curve otherwise, internal parts may occasionally deteriorate or be damaged.

Use the Power Supply at a humidity of 25% to 85%.

Do not use the Power Supply in locations subject to direct sunlight.
Do not use locations where liquids, foreign matter, or corrosive gases may enter the interior of products.



S8VS-□□□24A□ Models only

Satisfy the following conditions when storing the Power Supply for long periods of time to maintain its remaining service life function.

- When storing for more than three months, store within an ambient temperature range of -25 to +30°C and the humidity range of 25% to 70%.

Periodic Check (S8VS-09024□□, S8VS-12024□□, S8VS-18024□□ and S8VS-24024□□ only)

It may take from several years to more than 10 years under general operating conditions for the power supply to output the maintenance forecast monitor alarm (S8VS-□□□24A□). The total run time monitor (S8VS-□□□24B□) may be a similar number of years as the maintenance forecast monitor according to some settings. During operation over an extended period of time, periodically check if the maintenance forecast monitor output ((12)Yrs) or total run time monitor output ((12)kh) is correctly functioning by the following procedure.

1. Select the operation mode.
2. Check that the output ((12)Yrs/kh) is turned ON (with continuity between (12) and (13)).
3. In the operation mode, press and hold the Down Key  (10) and the Mode Key  (8) simultaneously for at least three seconds. The main display (6) changes to "RD2". An inactive output ((12)Yrs/kh) (no continuity between (12) and (13)) in the "RD2" indication indicates the correct function.
4. Release keys to return to the regular state.

Note: DC output stays ON during the periodical check.

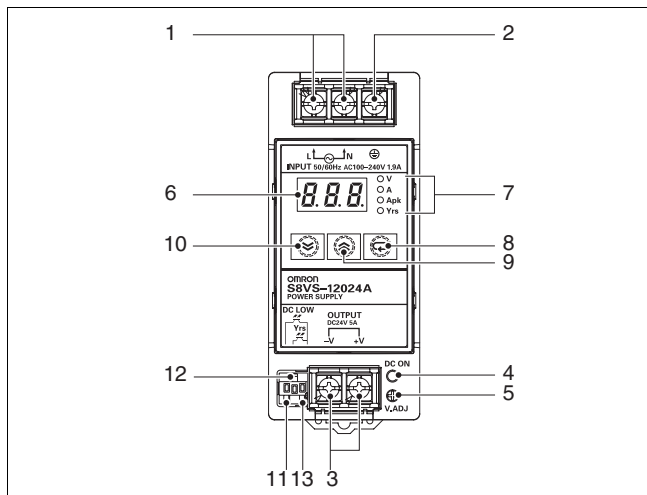

Overcurrent Protection

Internal parts may possibly deteriorate or be damaged if a short-circuited or overcurrent state continues during operation.
Internal parts may possibly deteriorate or be damaged if the Power Supply is used for applications with frequent inrush current or overloading at the load end. Do not use the Power Supply for such applications.

Alarm Output (S8VS-09024□□, S8VS-12024□□, S8VS-18024□□, S8VS-24024□□ Only)

When using the alarm output, sufficiently consider the maximum ratings, residual voltage, and leakage current.

Transistor output: Sinking for S8VS-□□□24□ Models
Sourcing for S8VS-□□□24□P Models

30 VDC max., 50 mA max.

ON residually voltage: 2 V max.
OFF leakage current: 0.1 mA max.

Charging the Battery

If a battery is to be connected as the load, mount an overcurrent limiting circuit and an overvoltage protection circuit.

Dielectric Strength Test

If a high voltage is applied between an input and the case (FG), it will pass through the LC of the built-in noise filter and energy will be stored. If the high voltages used for dielectric strength testing are turned ON and OFF with a switch, timer, or similar device, impulse voltage will be generated when the voltage is turned OFF and internal parts may possibly be damaged. To prevent the generation of impulse voltages, reduce the applied voltage slowly with a variable resistor on the test device or turn the voltage ON and OFF at the zero-cross point.

Inrush Current

When two or more Power Supplies are connected to the same input, the total current is the sum of the currents for each Supply. Select fuses and circuit breakers giving sufficient consideration to the fusing or operating characteristics so that fuses will not burn and breakers will not break due to inrush current.

Output Voltage Adjuster (V.ADJ)

The output voltage adjuster (V.ADJ) may possibly be damaged if it is turned with unnecessary force. Do not turn the adjuster with excessive force.

After completing output voltage adjustment, be sure that the output capacity or output current does not exceed the rated output capacity or rated output current.

15-W, 30-W Models

If the output voltage is set to a value less than -10%, the undervoltage alarm function may operate.

60-W, 90-W, 120-W, 180-W, and 240-W Models

If the output voltage is set to a value less than 20 V (the factory setting), the undervoltage alarm function may operate.

DIN Rail Mounting

To mount the Block on a DIN rail, hook portion (A) of the Block onto the rail and press the Block in direction (B).

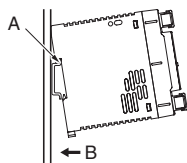

To dismount the Block, pull down portion (C) with a flat-blade screwdriver and pull out the Block.

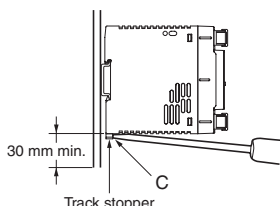

Series Operation

(24-V Model)

Two power supplies can be connected in series.

The (±) voltage output can be accomplished with two power supplies.

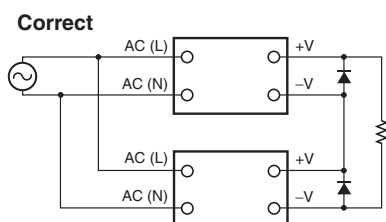

Note: 1. The diode is connected as shown in the figure. If the load is short-circuited, a reverse voltage will be generated inside the Power Supply. If this occurs the Power Supply may possibly deteriorate or be damaged. Always connect a diode as shown in the figure.

Select a diode having the following ratings.

Type	Schottky Barrier diode
Dielectric strength (VRRM)	Twice the rated output voltage or above
Forward current (IF)	Twice the rated output current or above

- Although products having different specifications can be connected in series, the current flowing through the load must not exceed the smaller rated output current.
- Serial operation is not possible with 5-V and 12-V Models.

Parallel Operation

The product is not designed for parallel operation.

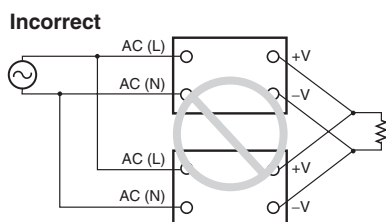

In Case There Is No Output Voltage

The possible cause for no output voltage may be that the overcurrent or overvoltage protection has operated. The internal protection may operate if a large amount of surge voltage such as a lightning surge occurs while turning ON the power supply.

In case there is no output voltage, please check the following points before contacting us:

- Checking overload protected status:
Check whether the load is in overload status or is short-circuited. Remove wires to load when checking.
- Checking overvoltage or internal protection (except for 15-W Models):
Turn the power supply OFF once, and leave it OFF for at least 3 minutes. Then turn it ON again to see if this clears the condition.

Harmonic Current Suppression Circuits

(120-W, 180-W and 240-W Models)

A harmonic current suppression circuit is built into the Power Supply. This circuit can create noise when the input is turned ON, but it will last only until the internal circuits stabilize and does not indicate any problem in the product.

Warranty and Application Considerations

Read and Understand this Catalog

Please read and understand this catalog before purchasing the products. Please consult your OMRON representative if you have any questions or comments.

Warranty and Limitations of Liability

WARRANTY

OMRON's exclusive warranty is that the products are free from defects in materials and workmanship for a period of one year (or other period if specified) from date of sale by OMRON.

OMRON MAKES NO WARRANTY OR REPRESENTATION, EXPRESS OR IMPLIED, REGARDING NON-INFRINGEMENT, MERCHANTABILITY, OR FITNESS FOR PARTICULAR PURPOSE OF THE PRODUCTS. ANY BUYER OR USER ACKNOWLEDGES THAT THE BUYER OR USER ALONE HAS DETERMINED THAT THE PRODUCTS WILL SUITABLY MEET THE REQUIREMENTS OF THEIR INTENDED USE. OMRON DISCLAIMS ALL OTHER WARRANTIES, EXPRESS OR IMPLIED.

LIMITATIONS OF LIABILITY

OMRON SHALL NOT BE RESPONSIBLE FOR SPECIAL, INDIRECT, OR CONSEQUENTIAL DAMAGES, LOSS OF PROFITS, OR COMMERCIAL LOSS IN ANY WAY CONNECTED WITH THE PRODUCTS, WHETHER SUCH CLAIM IS BASED ON CONTRACT, WARRANTY, NEGLIGENCE, OR STRICT LIABILITY.

In no event shall the responsibility of OMRON for any act exceed the individual price of the product on which liability is asserted.

IN NO EVENT SHALL OMRON BE RESPONSIBLE FOR WARRANTY, REPAIR, OR OTHER CLAIMS REGARDING THE PRODUCTS UNLESS OMRON'S ANALYSIS CONFIRMS THAT THE PRODUCTS WERE PROPERLY HANDLED, STORED, INSTALLED, AND MAINTAINED AND NOT SUBJECT TO CONTAMINATION, ABUSE, MISUSE, OR INAPPROPRIATE MODIFICATION OR REPAIR.

Application Considerations

SUITABILITY FOR USE

OMRON shall not be responsible for conformity with any standards, codes, or regulations that apply to the combination of products in the customer's application or use of the products.

Take all necessary steps to determine the suitability of the product for the systems, machines, and equipment with which it will be used.

Know and observe all prohibitions of use applicable to this product.

NEVER USE THE PRODUCTS FOR AN APPLICATION INVOLVING SERIOUS RISK TO LIFE OR PROPERTY WITHOUT ENSURING THAT THE SYSTEM AS A WHOLE HAS BEEN DESIGNED TO ADDRESS THE RISKS, AND THAT THE OMRON PRODUCTS ARE PROPERLY RATED AND INSTALLED FOR THE INTENDED USE WITHIN THE OVERALL EQUIPMENT OR SYSTEM.

Disclaimers

PERFORMANCE DATA

Performance data given in this catalog is provided as a guide for the user in determining suitability and does not constitute a warranty. It may represent the result of OMRON's test conditions, and the users must correlate it to actual application requirements. Actual performance is subject to the OMRON *Warranty and Limitations of Liability*.

CHANGE IN SPECIFICATIONS

Product specifications and accessories may be changed at any time based on improvements and other reasons. Consult with your OMRON representative at any time to confirm actual specifications of purchased product.

DIMENSIONS AND WEIGHTS

Dimensions and weights are nominal and are not to be used for manufacturing purposes, even when tolerances are shown.

ALL DIMENSIONS SHOWN ARE IN MILLIMETERS.

To convert millimeters into inches, multiply by 0.03937. To convert grams into ounces, multiply by 0.03527.

Cat. No. T030-E1-02 **In the interest of product improvement, specifications are subject to change without notice.**

OMRON Corporation

Industrial Automation Company

Industrial Devices and Components Division H.Q.

Power Electronics Department

Shiokoji Horikawa, Shimogyo-ku,

Kyoto, 600-8530 Japan

Tel: (81)75-344-7108/Fax: (81)75-344-7189