

OMRON

DeviceNet Safety System

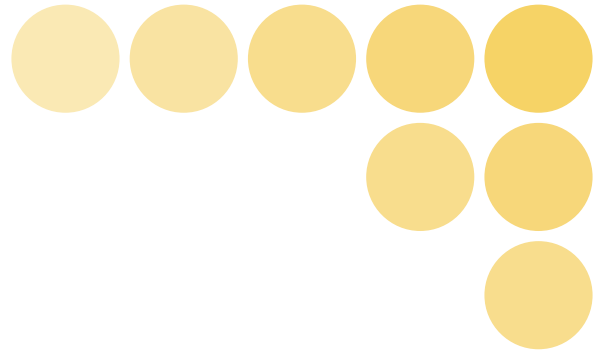

**More Flexible Safety Programming.
New Safety I/O Expansion Capability.**

DeviceNet Safety System

Complies with the Highest Safety Standards in the World

**Safety Network Controller
Version Upgrade**



realizing



Simple and Flexible Safety System Design

Safety circuits are programmable, providing greater operating efficiency for design and modifications. Safety distributed control using the DeviceNet Safety Network System enables more safety I/O for distributed control. And coordination with standard control via DeviceNet has been made easier.

Safety Network System functions have been upgraded, with a new concept of safety design. Safety connections have been doubled (from 16 to 32), program capacity has been doubled (number of usable function blocks increased from 128 to 254), and function blocks, such as muting and flip-flops, have been added to provide greater programming freedom and application compatibility. And a multi-point Safety Controller with 40 safety inputs and 8 safety outputs has been added, enabling a wide range of safety applications.

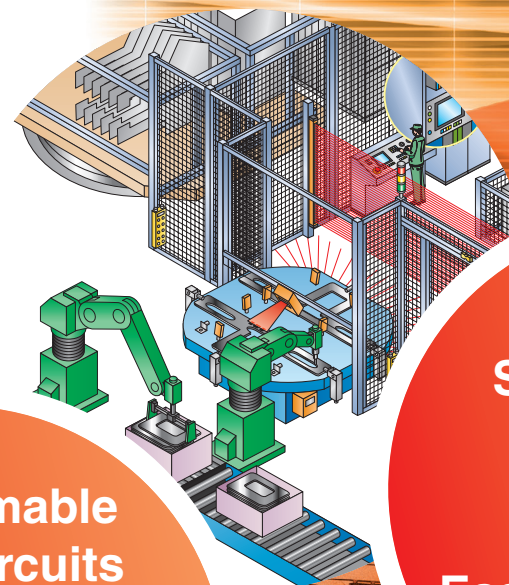

DeviceNet Open Network Compliant
 ↓
 Use DeviceNet to implement safety controls without increasing wiring.

Programmable Safety Circuits
 ↓
 Improved efficiency for design and modifications.

Distributed Safety Control
 ↓
 Easy expansion of safety I/O.

DeviceNet Safety System

Complies with the Highest Safety Standards in the World

The DeviceNet Safety System conforms to IEC 61508 SIL3 for functional safety, and EN 954-1 Safety Category 4 for machine safety, complying with the world's highest level of safety standards.

IEC 61508 SIL 3

Safety circuits must be able to function to provide safety at anytime. Conversely, the degree of lack of safety is used as the indicator. In IEC 61508, safety is defined as the Probability of Failure per Hour, or PFH. Based on this, the SIL (Safety Integrity Level) is classified into four levels. SIL 3 indicates a probability of dangerous failure of once in 1,000 years, which is the highest level in machine safety.

EN 954-1 Safety Category 4

EN standards evaluate the level of machine risk and require the incorporation of risk minimization measures. In EN 954-1, five safety categories have been established, with Safety Category 4 indicating designs that require the highest safety design level. This category is demanded for machines with the highest level of danger, wherein "serious injury (severed limbs, death, etc.) will occur frequently, with little chance of escaping danger." This category demands that a single fault (failure) in any part of the machine, or a series of faults, will not lead to loss of the machine's safety functions.

More Safety I/O and Double the Program Capacity. Along with the New Function Blocks, It All Adds Up to Expanded Safety Control Coverage.

Safety Controllers with Built-in Safety I/O

Two new Controllers for I/O Scalability to achieve a stand-alone system at a Reasonable Cost.

Safety Network Controller



Safety Network Configurator

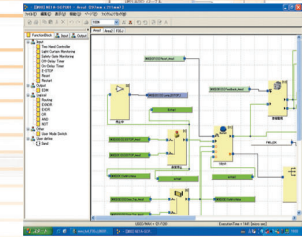

System Startup and Error Recovery Support

Use online monitoring for effective debugging and to minimize installation time. Check error information for easier maintenance.

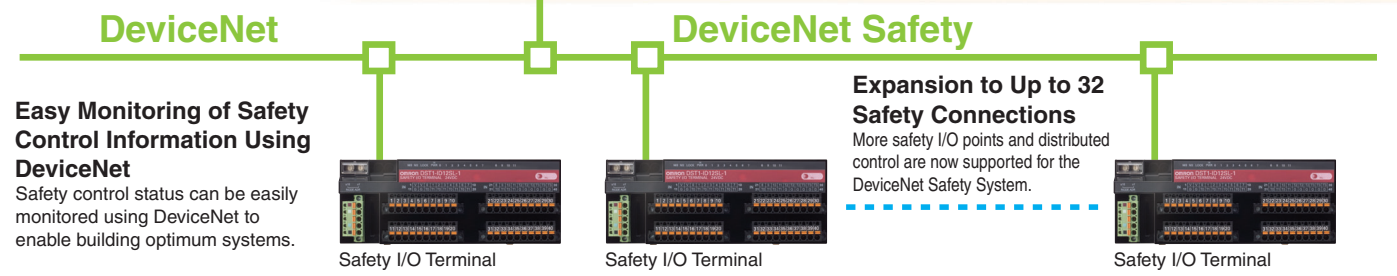

Easy Monitoring of Safety Control Information Using DeviceNet

Safety control status can be easily monitored using DeviceNet to enable building optimum systems.

Expansion to Up to 32 Safety Connections

More safety I/O points and distributed control are now supported for the DeviceNet Safety System.

Reduce the Total Cost of Ownership

In the past, safety circuits were based on hard wiring, requiring a vast amount of wiring. The resulting safety circuits were extremely difficult to change or expand. The DeviceNet Safety solves these problems.

- Reduce the Design Costs
- Reduce Wiring
- Reduce Debugging Time
- Reduce the Maintenance Costs

Reduce the Design Costs

- Using software to create safety circuits increases design efficiency and improves the ease of making modifications.
- Control panels can be downsized.

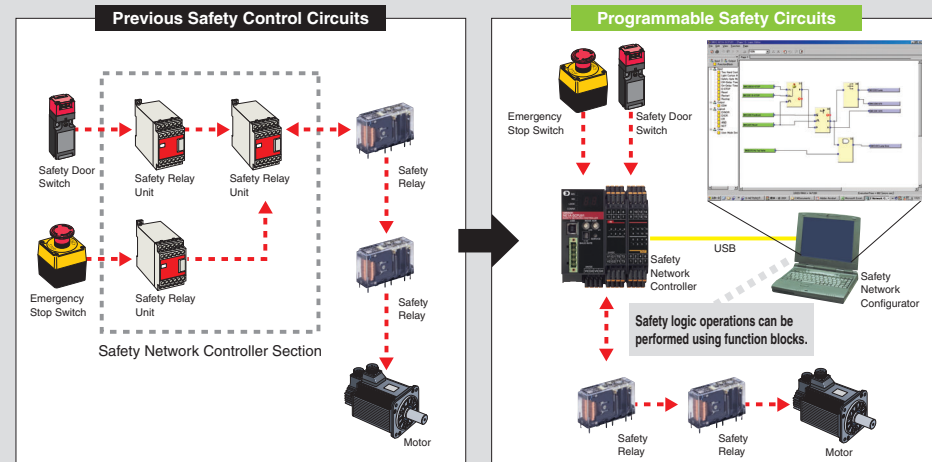

Reduce Debugging Time

- Online monitoring is enabled using the Safety Network Configurator.
- Designing can be easily modularized using user-defined function blocks.
- New design functions such as checking for incomplete wiring have been added.

User-defined function blocks make it possible to standardize safety circuits through modularizing designs.

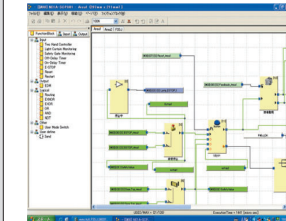

Various error messages make it easy to check setting error locations.

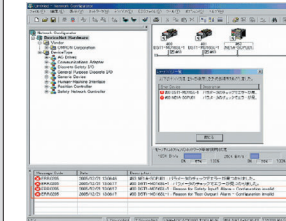

Online monitoring is enabled, and safety circuits can be made easy to understand by adding comments and setting colors for I/O tags.

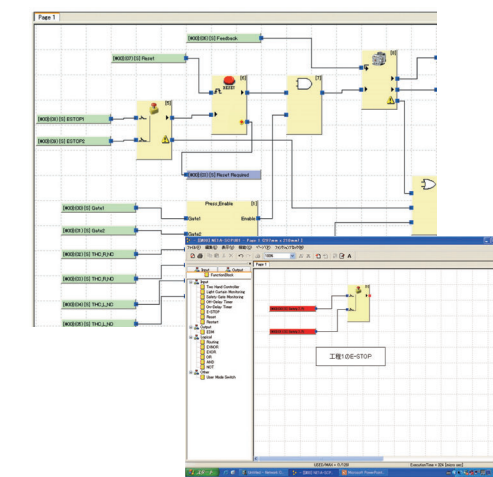

Reduce Wiring

- The mess of wiring for distributed safety devices and the mess around the control panel are eliminated.
- Data sharing with standard control is made easy with DeviceNet, eliminating the need for special wiring for monitoring safety control status.

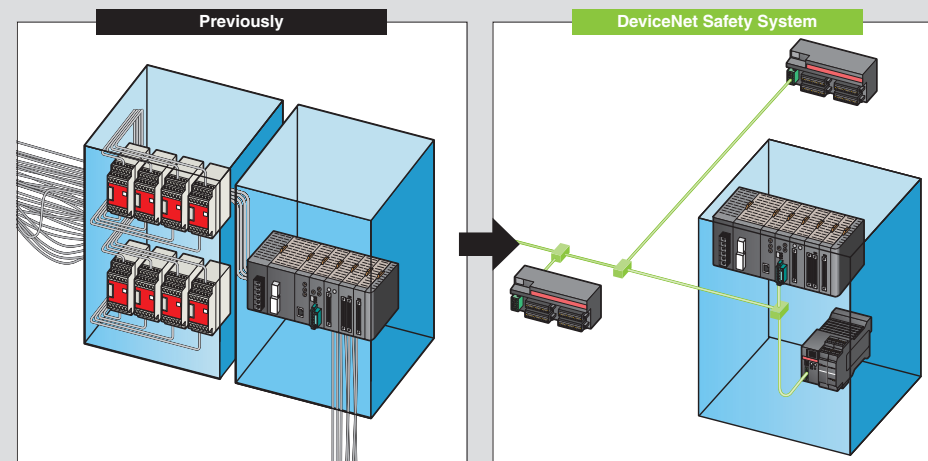

Reduce the Maintenance Costs

- Maintainability has been improved by providing smart functions, such as monitoring of the number of contact operations.
- Device errors can be monitored using the Network Configurator, and the causes of errors can be speedily found.

Error code display when errors occur

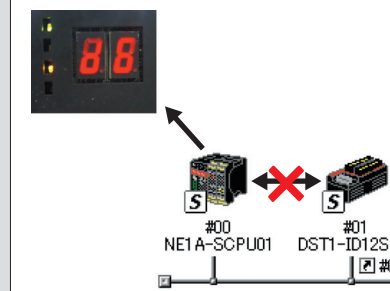

Safety connections, status monitoring, and error log monitoring are enabled.

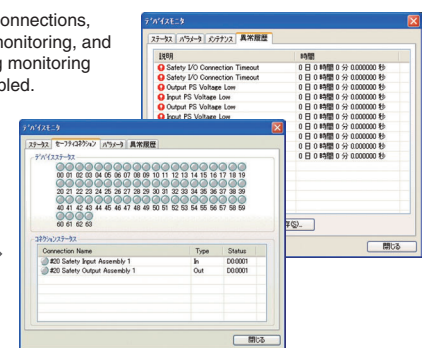

Programmable Safety Circuits and Network Compatibility Provide Flexibility in Safety Control Design.

Automobile manufacturing lines use many large-scale mechanical devices. Safety circuit design using this type of equipment required a vast amount of wiring for connections between circuits and sensors. Previously, relays were combined to configure safety circuits, but separate wiring was required for safety control as well as I/O wiring for machine control. Safety circuits using relays, however, required increasingly complicated wiring according to the level of equipment machinery sophistication, making safety circuit changes or additions difficult. This has created the need to be able to monitor distributed safety devices and change the production line to adjust to shorter product life cycles to improve maintenance efficiency. The DeviceNet Safety System responds to this need with network compatibility and programmable safety circuits.

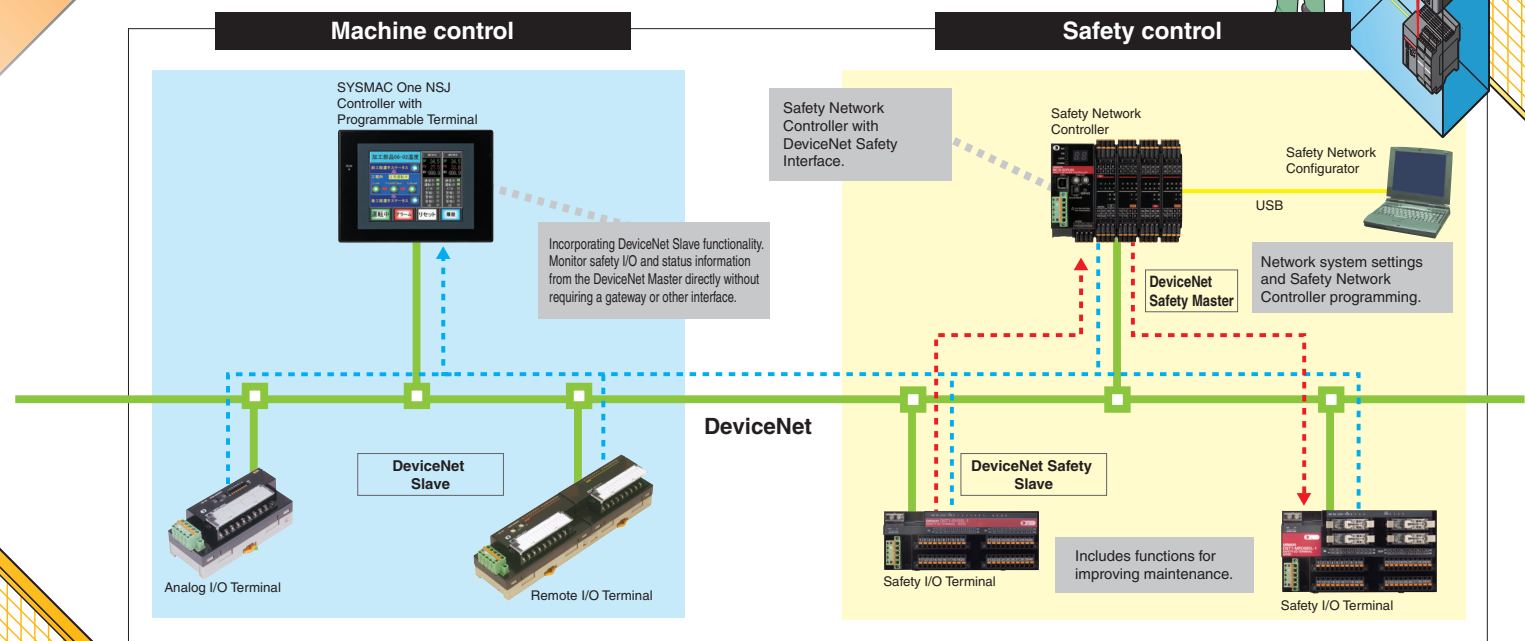
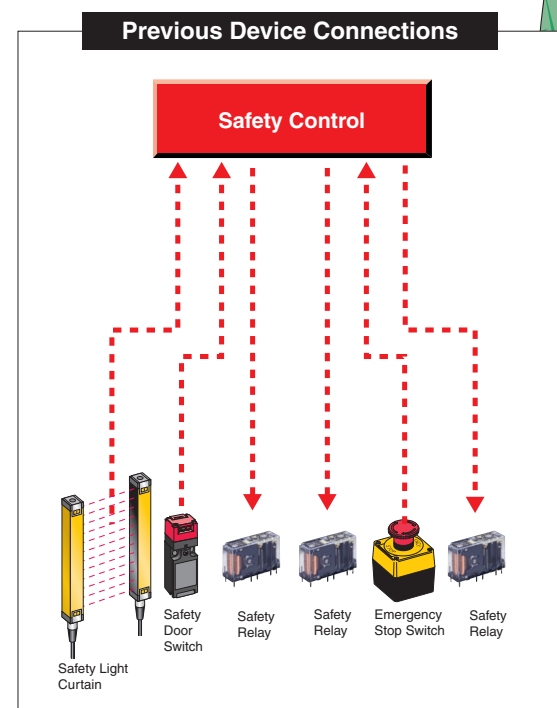
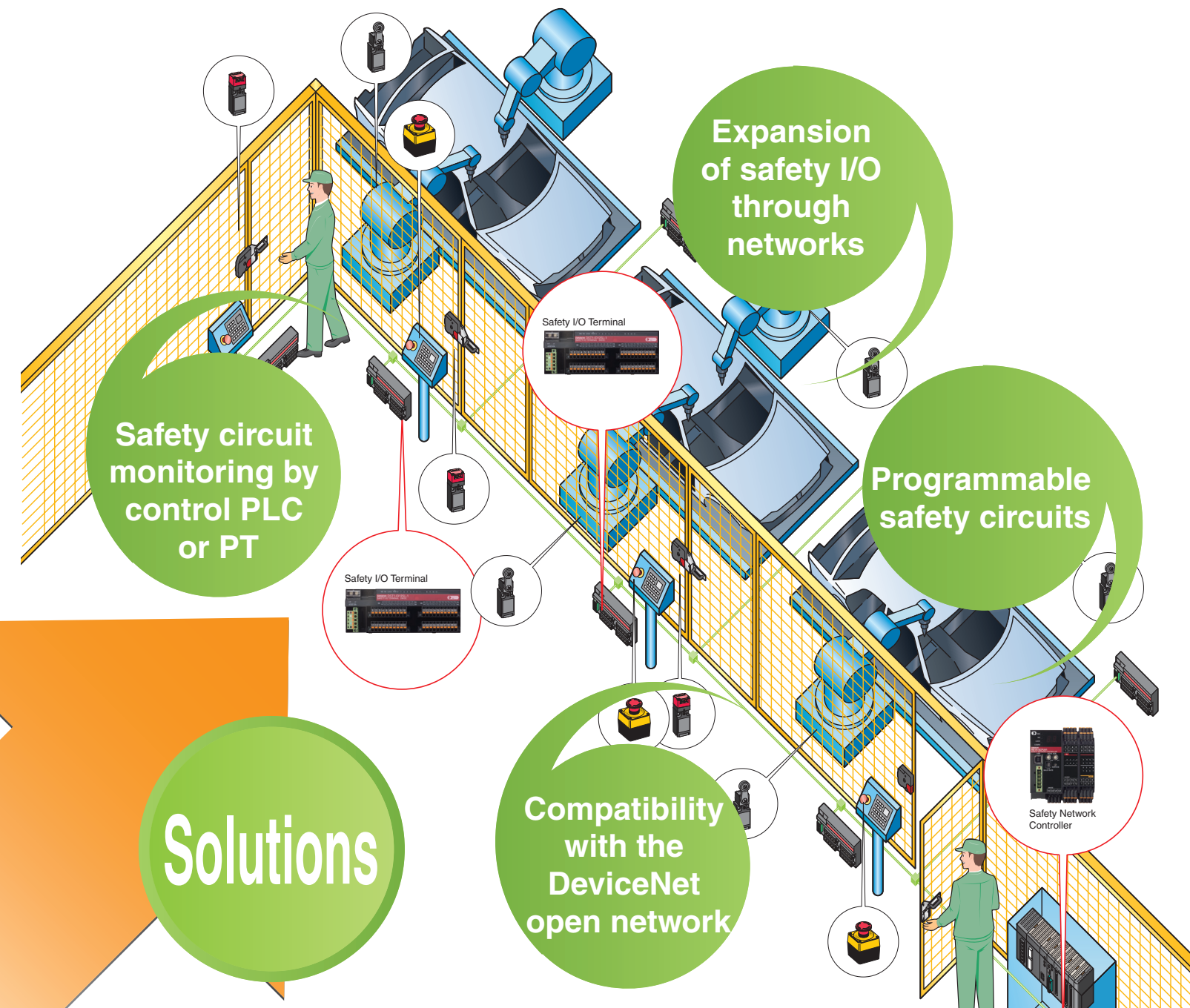
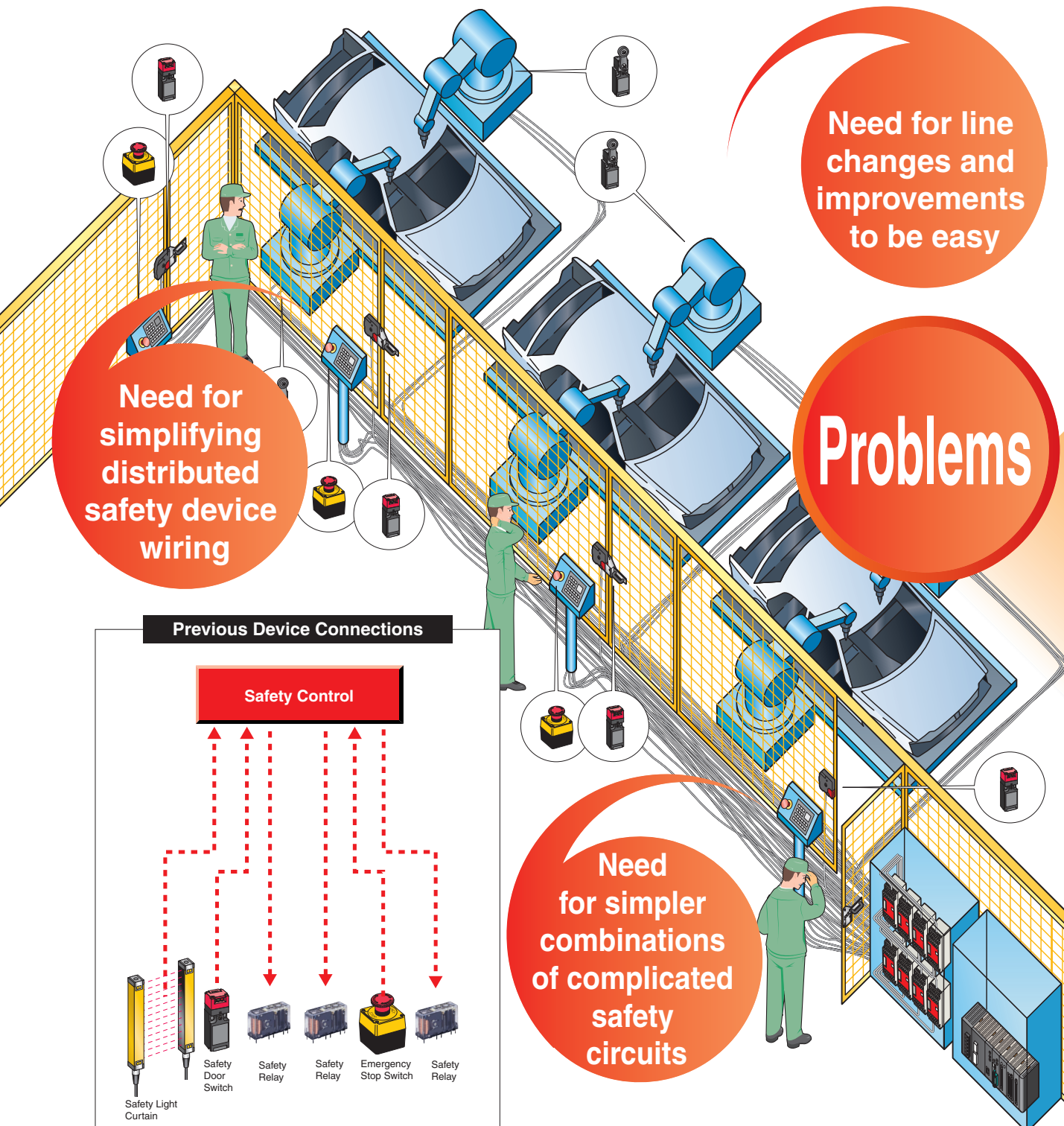

DeviceNet Safety System

NE1A-series Safety Network Controllers



NE1A-SCPU02



NE1A-SCPU01 (-V1)

Programmable Safety Control

- A multi-point Safety Network Controller (NE1A-SCPU02) with 40 safety inputs and 8 safety outputs has been added. Along with the earlier NE1A-SCPU01 (-V1), with 16 safety inputs and 8 safety outputs, it can operate as a compact safety PLC without using a network.
- Construct safety circuits easily with special Function Blocks. Up to 254 function blocks can be used with the NE1A-SCPU01-V1 or NE1A-SCPU02, and up to 128 can be used with the NE1A-SCPU01.

DeviceNet Safety Communications Functions

- Provides DeviceNet Safety Master functionality. Up to 32 NE1A-SCPU01-V1 or NE1A-SCPU02 Safety Network Controllers can be connected as Safety Slaves. Up to 32 can be connected as 12-point Input Slaves (384 points), and up to 16 can be connected as 16-point I/O Slaves (256 points). (A maximum of 16 NE1A-SCPU01 Safety Network Controllers can be connected.)
- Safety Slave functionality is also included. Interlock control can be incorporated between Safety Network Controllers.

DeviceNet Slave Functionality

- Monitor safety I/O and status information from the DeviceNet Master.

DST1-series Safety I/O Terminals

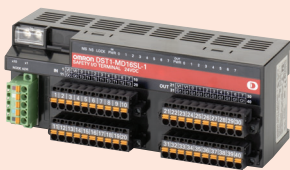

DST1-MD16SL-1



DST1-MRD08SL-1

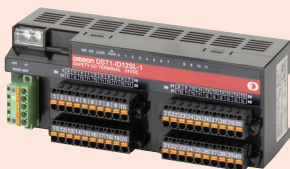

DST1-ID12SL-1

Safety Input and Safety I/O Models Available

- Safety inputs: 12-input model (DST1-ID12SL-1)
- Safety I/O: 8-input/8-output model (DST1-MD16SL-1)
- Safety I/O: 4-input/4-output (relay outputs) model (DST1-MRD08SL-1)

DeviceNet Slave Functionality

- Safety input and status information can be allocated as a DeviceNet Slave.
- Maintenance functions are provided for measuring the number of operations or the operating time for safety devices.

Easy Wiring

- Superior construction and maintainability using spring-cage connectors. A screw terminal block is also available as an option.

WS02-CFSC1-E Safety Network Configurator

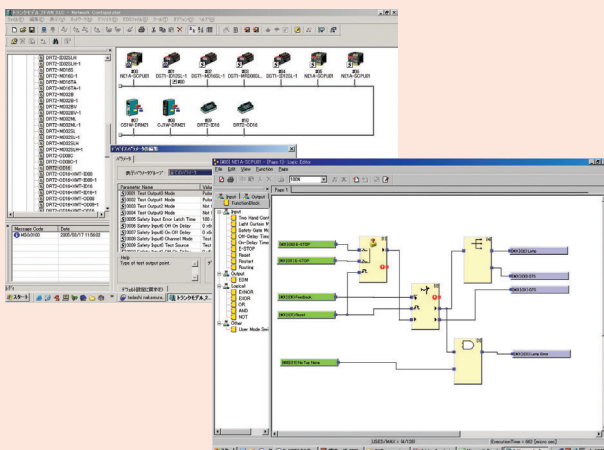

Network Configurator Functions

- Includes previous DeviceNet Configurator functions.
- Performs setup for the DeviceNet Safety network configuration.

Programming Functions

- I/O configuration functions for Safety Network Controllers and Safety I/O Terminals.
- Programming functions for safety circuits.
- Monitor programs.

Safety Control Applications

System Configuration 1 Standalone Safety Control

Configuration Example for High-speed Safety I/O Response Using Small Number of Points

- NE1A-series Controller
- WS02-CFSC1-E

Delivers high-speed I/O response in a single Unit with up to 40 safety inputs and 8 safety outputs.

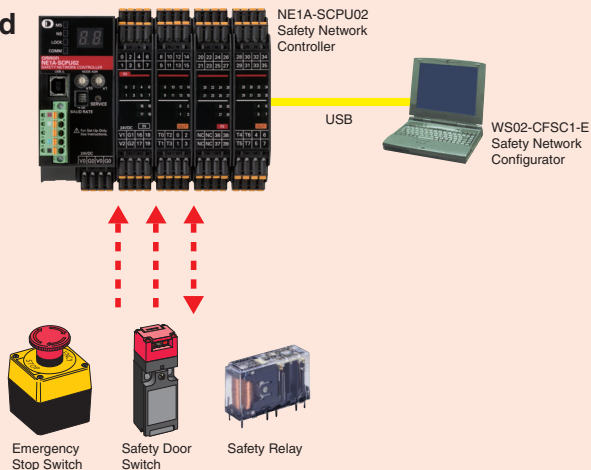

System Configuration 2 Distributed Control and Expanded Safety I/O

Example of Safety I/O Configuration for Distributed Hazard Sources

- NE1A-series Controller
- DST1 Series
- WS02-CFSC1-E

Distributed allocation of safety I/O devices can be achieved easily using Safety I/O Terminals and the DeviceNet Safety Network.

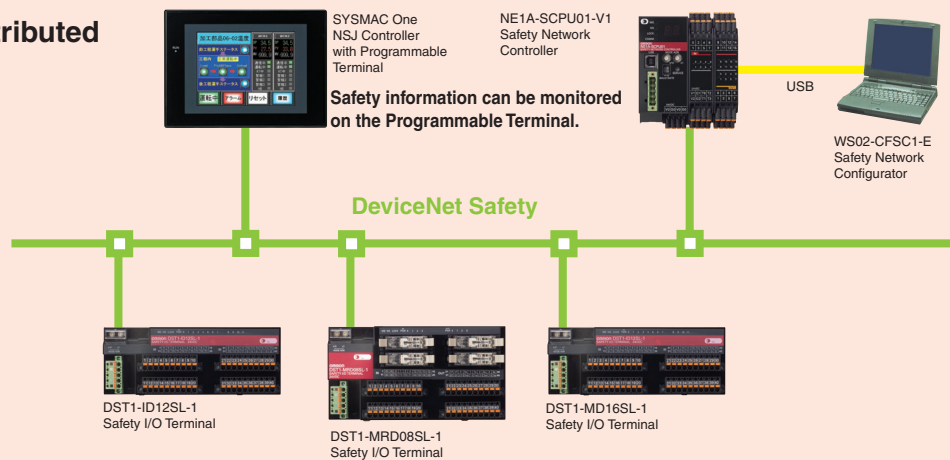

System Configuration 3 Total Control System

System Configuration Example for Total Control of Machine Control and Safety Control

- SYSMAC CJ Series
- NE1A-series Controller
- DST1 Series
- WS02-CFSC1-E

The DeviceNet Network can be used to monitor the status of safety I/O and safety circuits on the DeviceNet Safety Network from existing DeviceNet Masters or other PLCs.

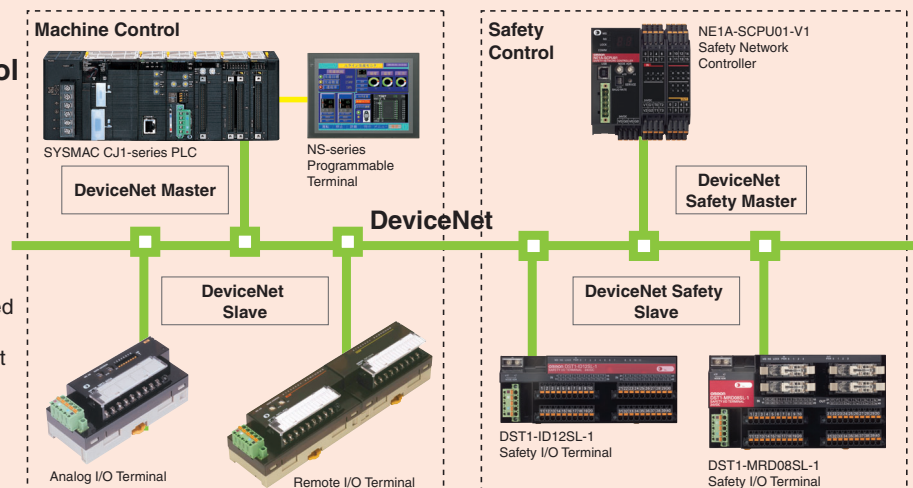

Safety Network Controller NE1A-SCPU Series

**Achieves Programmable Safety Control.
Features DeviceNet Safety Master and Slave
Functionality.**

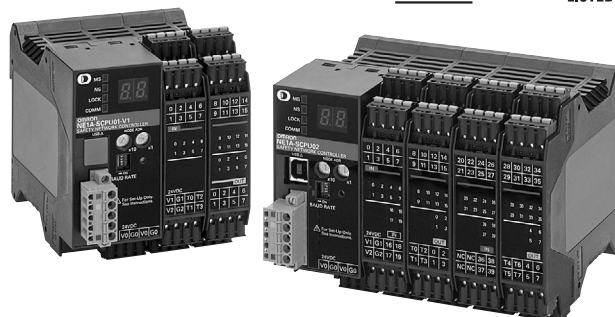

NEW

- Operates as a compact programmable safety circuit controller.
- NE1A-SCPU02: 40 safety inputs and 8 safety outputs.
NE1A-SCPU01(-V1): 16 safety inputs and 8 safety outputs.
- A maximum of 254 function blocks enables easily building safety circuits.
- DeviceNet Safety Master function connects to up to 32 DeviceNet Safety Slaves.
- Equipped with DeviceNet Slave function. Monitoring can be done from a DeviceNet Master.
- IEC61508 (SIL3) and EN954-1/ISO13849-1 (Cat. 4) certification.

Ordering Information

■ List of Models

Name	No. of I/O points			Model	Unit version
	Safety inputs	Test outputs	Safety outputs		
Safety Network Controllers	16	4	8	NE1A-SCPU01	---
	16	4	8	NE1A-SCPU01-V1	1.0
	40	8	8	NE1A-SCPU02	1.0

Note: The standard NE1A Controllers are equipped with spring-cage terminal blocks, but other screw terminal blocks are available if desired, e.g., to replace previous terminals. Refer to *Accessories* on page 22.

Specifications

■ Certified Standards

Certification body	Standard
TÜV Rheinland	EN954-1:1996, ISO13849-1:1999, EN ISO13849-2:2003, ISO13849-2:2003, prEN954-2:1999, IEC60204-1:2005, EN60204-1:2006, EN61000-6-2:2001, EN61000-6-4:2001, EN418:1992, IEC61508 part1-7/12.98-05.00, IEC61131-2/02.03, NFPA 79-2002, ANSI RIA15.06-1999, ANSI B11.19-2003
UL	UL1998, NFPA79, UL508, CSA22.2 No. 142, CSA22.2 No. 213, UL1604

■ Specifications

Model		NE1A-SCPU01 (-V1)	NE1A-SCPU02
Item			
Communications power supply voltage		11 to 25 VDC supplied via communications connector	
Unit power supply voltage (V0)*		20.4 to 26.4 VDC (24 VDC -15%/+10%)	
I/O power supply voltage (V1, V2)*			
Current consumption	Communications power supply	24 VDC, 15 mA	
	Internal circuit power supply	24 VDC, 230 mA	24 VDC, 280 mA
Overvoltage category		II	
Noise immunity		Conforms to IEC61131-2.	
Vibration resistance		10 to 57 Hz: 0.35 mm, 57 to 150 Hz: 50 m/s ²	
Shock resistance		150 m/s ² : 11 ms	
Mounting method		35-mm DIN Track (IEC 60715 TH35-7.5/TH35-15)	
Ambient operating temperature		-10 to 55°C	
Ambient operating humidity		10% to 95% (with no condensation)	
Ambient storage temperature		-40 to 70°C	
Degree of protection		IEC60529 standard IP20	
Serial interface		USB version 1.1	
Weight		460 g max.	690 g max.

* V0-G0: Internal control circuit
 V1-G1 (G): For external input device, test output
 V2-G2 (G): For external output device
 The two ground terminals on the NE1A-SCPU02 are internally connected.

■ Safety Input Specifications

Input type	Sinking inputs (PNP)
ON voltage	11 VDC min. between each terminal and ground
OFF voltage	5 VDC min. between each terminal and ground
OFF current	1 mA max.
Input current	4.5 mA

■ Safety Output Specifications

Output type	Sourcing outputs (PNP)
Rated output current	0.5 A max./output
ON residual voltage	1.2 V max. between each output terminal and V2
Leakage current	0.1 mA max.

■ Test Output Specifications

Output type	Sourcing outputs (PNP)
Rated output current	0.7 A max./output (See note.)
ON residual voltage	1.2 V max. between each output terminal and V1
Leakage current	0.1 mA max.

Note: The maximum current for simultaneously ON outputs is 1.4 A. (T0 to T3: NE1A-SCPU01(-V1), T0 to T7: NE1A-SCPU02) A 15 to 400-mA, 24-VDC external indicator can be connected to T3 and T7.

■ DeviceNet Communications Specifications

Communications protocol	DeviceNet compliant			
Connection form	Multi-drop system and T-branch system can be combined (for trunk line and branch lines)			
Communications speed	500/250/125 kbps			
Communications media	Special cable, 5 conductors (2 for communications, 2 for power supply, 1 for shielding)			
Communications distance	Communications speed	Max. network length	Branch length	Total branch length
	500 kbps	100 m max. (100 m max.)	6 m max.	39 m max.
	250 kbps	250 m max. (100 m max.)		78 m max.
	125 kbps	500 m max. (100 m max.)		156 m max.
	Note: Figures in parentheses () indicate values when a thin cable is used.			
Communications power supply	11 to 25 VDC			
No. of connectable nodes	63			
Safety I/O communications (Pre-Ver. 1.0)	Safety Master function <ul style="list-style-type: none"> • Max. no. of connections: 16 • Max. data size: Input 16 bytes or output 16 bytes (per connection) • Connection type: Single-cast, multi-cast Safety Slave function <ul style="list-style-type: none"> • Max. no. of connections: 4 • Max. data size: Input 16 bytes or output 16 bytes (per connection) • Connection type: Single-cast, multi-cast 			
Safety I/O communications (unit version 1.0 or later)	Safety Master function <ul style="list-style-type: none"> • Max. no. of connections: 32 • Max. data size: Input 16 bytes or output 16 bytes (per connection) • Connection type: Single-cast, multi-cast Safety Slave function <ul style="list-style-type: none"> • Max. no. of connections: 4 • Max. data size: Input 16 bytes or output 16 bytes (per connection) • Connection type: Single-cast, multi-cast 			
Standard I/O communications (all unit versions)	Standard Slave function <ul style="list-style-type: none"> • Max. no. of connections: 2 • Max. data size: Input 16 bytes or output 16 bytes (per connection) • Connection type: Poll, bit-strobe, COS, cyclic 			
Message communications	Max. message length: 552 bytes			

Functions

■ Function Blocks

NE1A-SCPU-series Controller support the following logic functions and function blocks. Support depends on the unit version.

Logic Functions

Name	Supporting unit versions
NOT	All
AND	
OR	
Exclusive OR	
Exclusive NOR	
RS Flip-flop	1.0 or later
Comparator	

Function Blocks

Name	Supporting unit versions	
Reset	All	
Restart		
Emergency Stop Monitoring		
Light Curtain Monitoring		
Safety Gate Monitoring		
Two-hand Controller		
Off-Delay Timer		
On-Delay Timer		
User Mode Switch Monitoring		
External Device Monitoring		
Routing		
Muting		1.0 or later
Enable Switch Monitoring		
Pulse Generator		
Counter		
Multiconnector		

Connections

Internal Circuit Diagram

NE1A-SCPU01 (-V1)

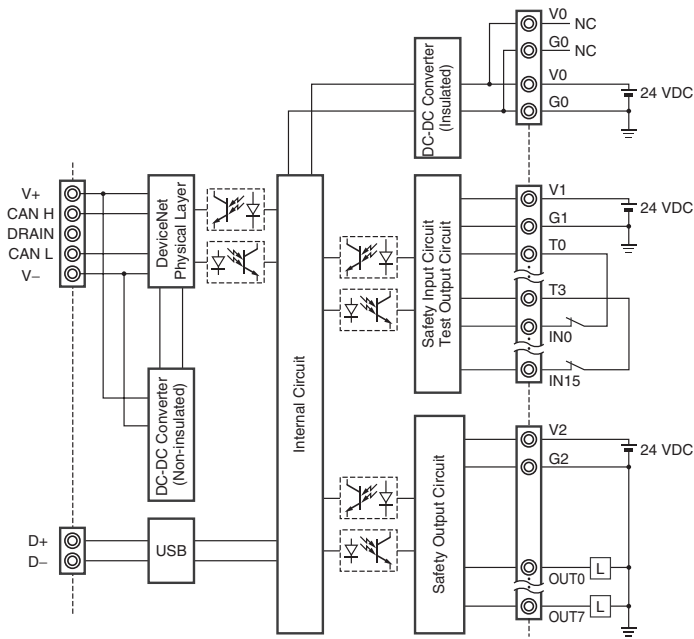

Terminal name	Description
V0	Power supply terminal for internal circuit The two V0 terminals are internally connected.
G0	Power supply terminal for internal circuit The two G0 terminals are internally connected.
V1	Power supply terminal for external input device and test output
G1	Power supply terminal for external input device and test output
V2	Power supply terminal for external output device
G2	Power supply terminal for external output device
IN0 to IN15	Safety input terminal
T0 to T3	Test output terminal Connected to IN0 to IN15 safety inputs. Each test output terminal outputs a different test pulse pattern. Terminal T3 also supports a current monitoring function for the output signal. Example: Muting lamp
OUT0 to OUT7	Safety output terminals

NE1A-SCPU02

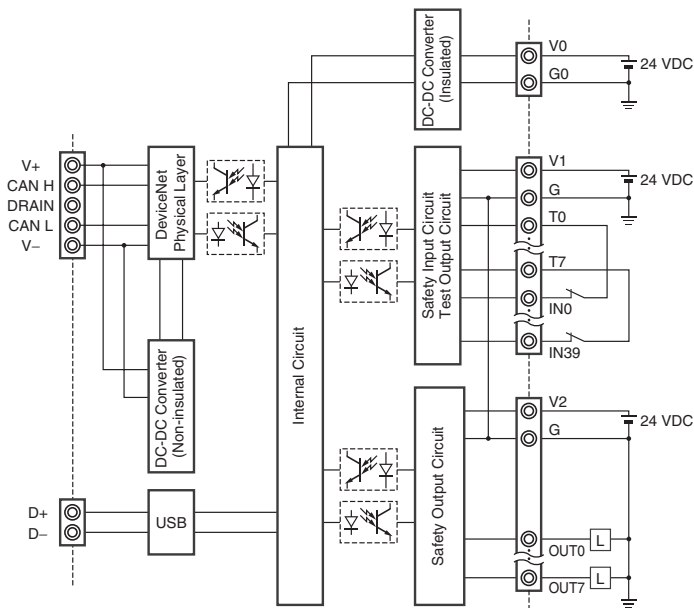

Terminal name	Description
V0	Power supply terminal for internal circuit The two V0 terminals are internally connected.
G0	Power supply terminal for internal circuit The two G0 terminals are internally connected.
V1	Power supply terminal for external input device and test output
G	Power supply terminal for external input device and test output
V2	Power supply terminal for external output device
G	Power supply terminal for external output device
IN0 to IN39	Safety input terminal
T0 to T3	Test output terminal Connected to IN0 to IN19 safety inputs. Each test output terminal outputs a different test pulse pattern. Terminal T3 also supports a current monitoring function for the output signal. Example: Muting lamp
T4 to T7	Test output terminal Connected to IN20 to IN39 safety inputs. Each test output terminal outputs a different test pulse pattern. Terminal T7 also supports a current monitoring function for the output signal. Example: Muting lamp
OUT0 to OUT7	Safety output terminals

Refer to the *DeviceNet Safety Safety Network Controllers Operation Manual* (Cat. No. Z906) for wiring examples.

Dimensions

Note: All units are in millimeters unless otherwise indicated.

NE1A-SCPU01 (-V1)

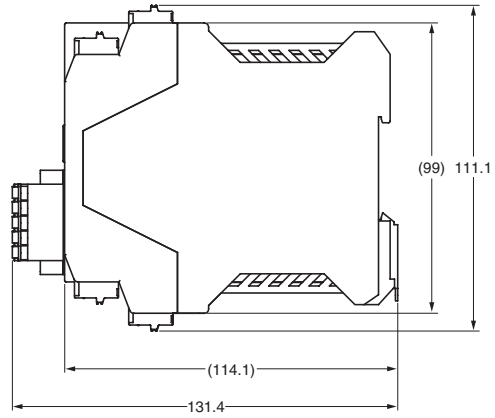
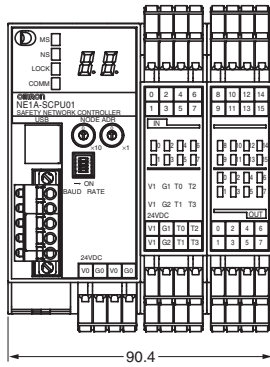

NE1A-SCPU02

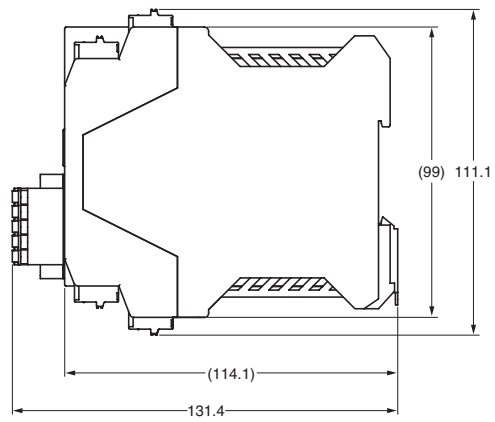
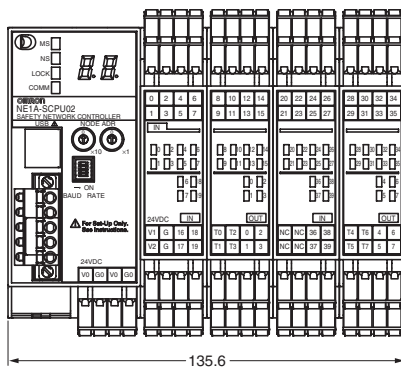

Safety Precautions

Be sure to read the following operation manual for precautions and other details required for correct use of the Safety Network Controller.
DeviceNet Safety Safety Network Controller Operation Manual (Cat. No. Z906)

■ Functions Supported According to Unit Version

○: Supported, ---: Not supported

Function	Model	NE1A-SCPU01	NE1A-SCPU01-V1	NE1A-SCPU02
	Unit version	Pre-Ver. 1.0	Unit version 1.0	Unit version 1.0
Logic processing functions	Maximum program size (total number of function blocks)	128	254	254
	New Function Blocks • RS flip-flop • Multiconnector • Muting • Enable Switch Monitoring • Pulse Generator • Counter • Comparator	---	○	○
	Selecting a rising edge as the reset condition for Reset and Restart function blocks	---	○	○
	Using local I/O status in logic programming	---	○	○
	Using overall Unit status in logic programming	---	○	○
I/O control functions	Monitoring contact operation counter	---	○	○
	Mounting total ON time monitor	---	○	○
DeviceNet communications functions	Number of safety I/O connections for Safety Master	16	32	32
	Selecting operating mode for safety I/O communications when communications errors occur	---	○	○
	Attaching local output data to send data during slave operation	---	○	○
	Attaching local I/O monitor data to send data during slave operation	---	○	○
System startup and error recovery functions	Storing log of nonfatal errors in nonvolatile memory	---	○	○
	Adding function block errors to error log	---	○	○

Unit Versions and Network Configurator Versions

Network Configurator version 1.6□ or higher is required for the NE1A-SCPU01-V1 and NE1A-SCPU02. The relationship between unit versions and the version of the Network Configurator is shown in the following table.

○: Applicable, ×: Not applicable

Model	Version	Network Configurator		
		Ver. 1.32	Ver. 1.51	Ver. 1.6□
NE1A-SCPU01 Pre-Ver. 1.0		○	○	○
NE1A-SCPU01-V1 Unit version 1.0		×	×	○
NE1A-SCPU02 Unit version 1.0		×	×	○

ALL DIMENSIONS SHOWN ARE IN MILLIMETERS.
 To convert millimeters into inches, multiply by 0.03937. To convert grams into ounces, multiply by 0.03527.

Safety I/O Terminals

DST1-ID12SL-1/MD16SL-1/MRD08SL-1

Safety I/O Terminals equipped with DeviceNet Safety protocol and various functions for use in safety systems.



- Series includes three models to accommodate various I/O types and number of I/O points.
- Equipped with DeviceNet Slave function. Monitoring can be done from a DeviceNet Master.
- Smart Slave (DRT2 Series) functions improve preventive maintenance capabilities.
- IEC61508 (SIL3) and EN954-1/ISO13849-1 (Cat. 4) certification.

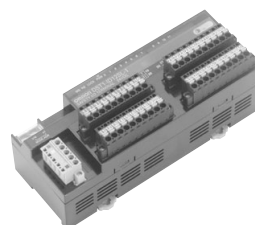

DST1-ID12SL-1
DST1-MD16SL-1

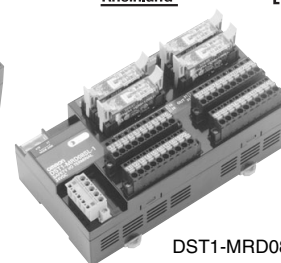

DST1-MRD08SL-1

Ordering Information

List of Models

Name	No. of I/O points	Model
Safety I/O Terminals	Safety inputs: 12	DST1-ID12SL-1
	Safety inputs: 8, safety outputs: 8	DST1-MD16SL-1
	Safety inputs: 4, safety outputs (relay): 4	DST1-MRD08SL-1

Note: The standard DS1T Safety I/O Terminals are equipped with spring-cage terminal blocks, but screw terminal blocks are available if desired, e.g., to replace previous terminals. Refer to "Accessories" on page 22.

Specifications

Certified Standards

Certification body	Standard
TÜV Rheinland	EN954-1/12.96, ISO13849-1:1999, EN ISO13849-2:2003, ISO13849-2:2003, prEN954-2:1999, IEC60204-1:2005, EN60204-1:2006, EN61000-6-2/10.01, EN61000-6-4/10.01, EN418/1992, IEC61508 part1-7/12.98-05.00, IEC61131-2/02.03, NFPA 79-2002, ANSI RIA15.06-1999, ANSI B11.19-2003
UL	UL1998, NFPA79, UL508, CSA22.2 No. 142, UL1604 (DST1-ID12SL-1 and DST1-MD16SL-1 only) CSA22.2 No. 213 (DST1-ID12SL-1 and DST1-MD16SL-1 only)

Specifications

Communications power supply voltage	11 to 25 VDC supplied via communications connector
I/O power supply voltage	20.4 to 26.4 VDC (24 VDC -15%/+10%)
Current consumption	Communications power supply DST1-ID12SL-1/MRD08SL-1: 100 mA DST1-MD16SL-1: 110 mA
Overvoltage category	II
Noise immunity	Conforms to IEC61131-2.
Vibration resistance	10 to 57 Hz: 0.35 mm, 57 to 150 Hz: 50 m/s ²
Shock resistance	DST1-ID12SL-1/MD16SL-1: 150 m/s ² , 11 ms DST1-MRD08SL-1: 100 m/s ² , 11 ms
Mounting method	35-mm DIN Track
Ambient operating temperature	-10 to 55°C
Ambient operating humidity	10% to 95% (with no condensation) DST1-MRD08SL-1: 10% to 85% (with no condensation)
Ambient storage temperature	-40 to 70°C
Degree of protection	IEC60529 standard IP20
Weight	DST1-ID12SL-1/MD16SL-1: 420 g DST1-MRD08SL-1: 600 g

■ Safety Input Specifications

Input type	Sinking inputs (PNP)
ON voltage	11 VDC min.
OFF voltage	5 VDC max.
OFF current	1 mA max.
Input current	6 mA

■ Safety Output Specifications (Semiconductor output) (DST1-MD16SL-1)

Output type	Sourcing outputs (PNP)
Rated output current	0.5 A max./output
ON residual voltage	1.2 V max.
Leakage current	0.1 mA max.

■ Test Output Specifications

Output type	Sourcing outputs (PNP)
Rated output current	0.7 A max./output
ON residual voltage	1.2 V max.
Leakage current	0.1 mA max.

■ Safety Output Specifications (Relay Output) (DST1-MRD08SL-1)

Applicable relays	G7SA-2A2B, EN50205 Class A	
Failure rate P level (See note.) (Reference value)	5 VDC, 1 mA	
Rated load (resistive)	2 A at 240 VAC, 2 A at 30 VDC	
Durability	Mechanical	5,000,000 operations min. (at 7,200 operations/h)
	Electrical	100,000 operations min. (at 1,800 operations/h with a resistive load)

Note: This value is equivalent to 300 operations/minute.

■ DeviceNet Safety Communications

Safety Slave communications	Max. 4 connections (16 bytes per connection)
-----------------------------	---

■ DeviceNet Slave Communications

Standard Slave communications	Max. 2 connections (16 bytes per connection)
-------------------------------	---

Connections

■ Internal Circuit Configuration

DST1-ID12SL-1

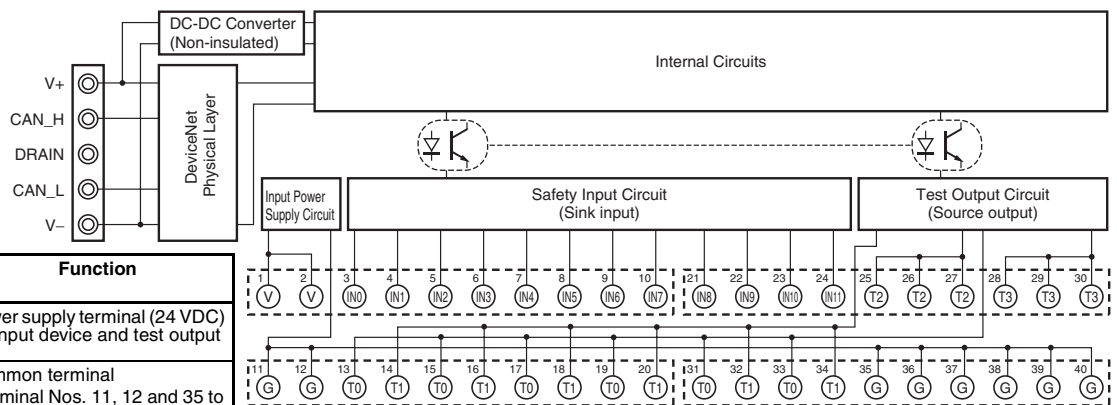

Terminal No.	Name	Function
1, 2	V	Power supply terminal (24 VDC) for input device and test output
11, 12	G	Common terminal (Terminal Nos. 11, 12 and 35 to 40 are internally connected.)
35 to 40	G	
3 to 10 21 to 24	IN0 to IN11	Safety input terminal
13 to 20 25 to 30 31 to 34	T0 to T3	Test output terminal

DST1-MD16SL-1

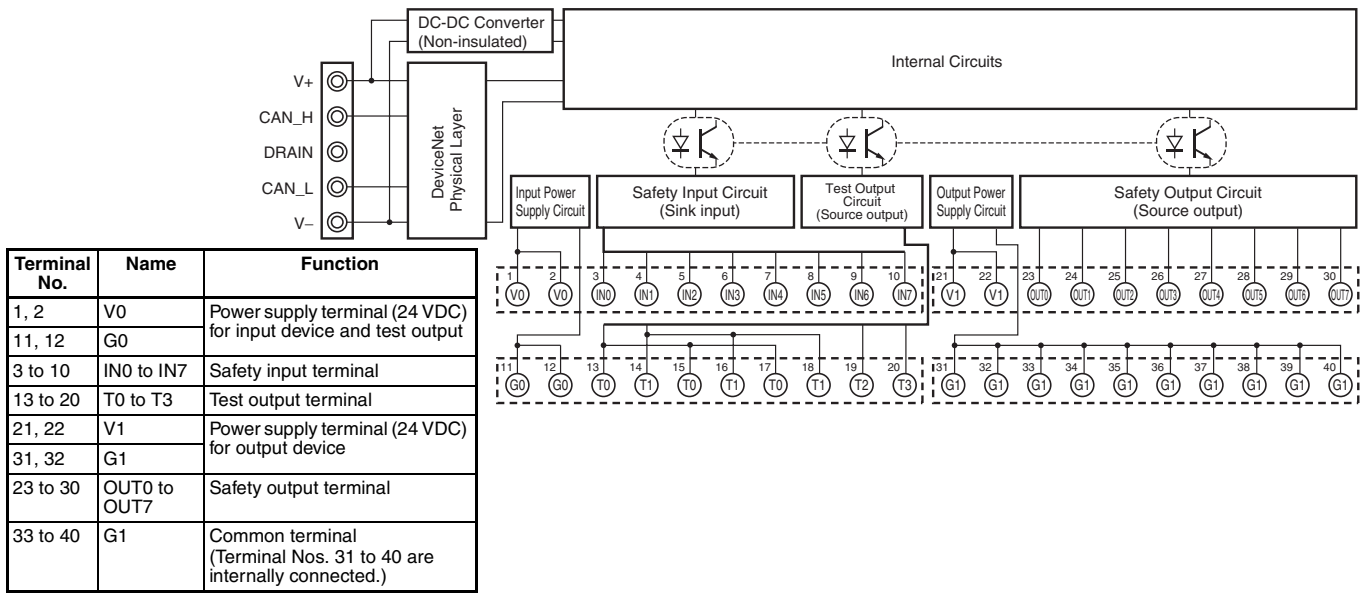

DST1-MRD08SL-1

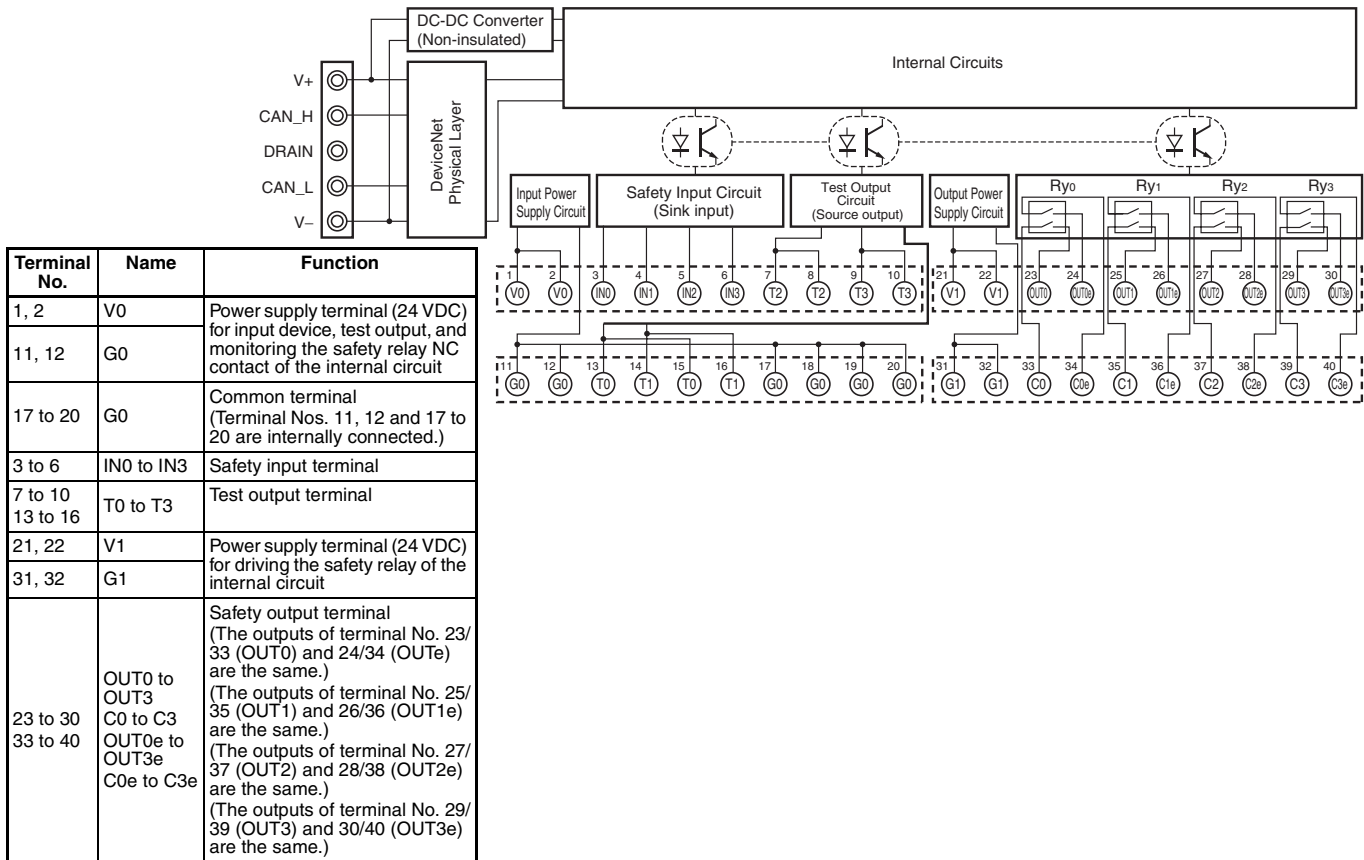

Refer to the *DeviceNet Safety DST1-series Safety I/O Terminals Operation Manual* (Cat. No. Z904) for wiring examples.

Dimensions

Note: All units are in millimeters unless otherwise indicated.

DST1-ID12SL-1
DST1-MD16SL-1

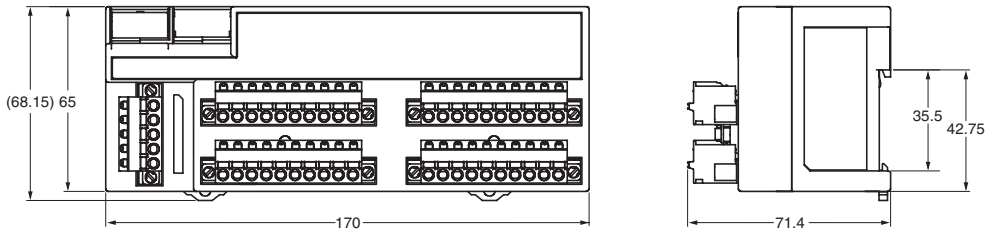

DST1-MRD08SL-1

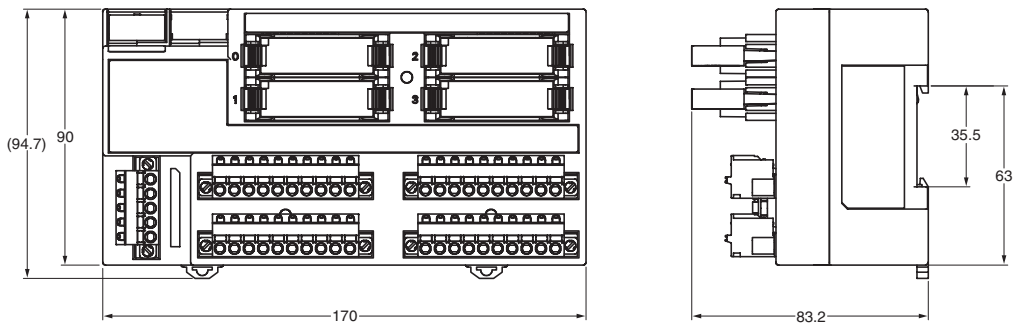

Safety Precautions

Be sure to read the following operation manual for precautions and other details required for correct use of the Safety Network Controller.
DeviceNet Safety DST1-series Safety I/O Terminals Operation Manual (Cat. No. Z904)

ALL DIMENSIONS SHOWN ARE IN MILLIMETERS.
To convert millimeters into inches, multiply by 0.03937. To convert grams into ounces, multiply by 0.03527.

Cat. No. J158-E1-02

In the interest of product improvement, specifications are subject to change without notice.

Safety Network Configurator WS02-CFSC1-E

Enables Programming Safety Circuits for DeviceNet Safety Systems on a Personal Computer.

- Performs settings for the Safety Network Controllers and Safety I/O Terminals.
- Built-in safety circuit programming functions.
- Enables easily monitoring safety circuit status.
- Includes DeviceNet Configurator functions.

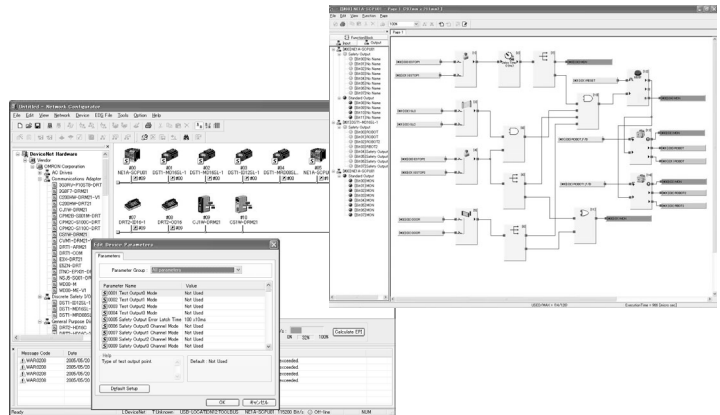

Ordering Information

List of Models

Name	Components	Applicable computer	Applicable OS	Model
Safety Network Configurator	Install disk (CD-ROM)	IBM PC/AT or compatible	Windows 2000 Windows XP	WS02-CFSC1-E

System Configuration

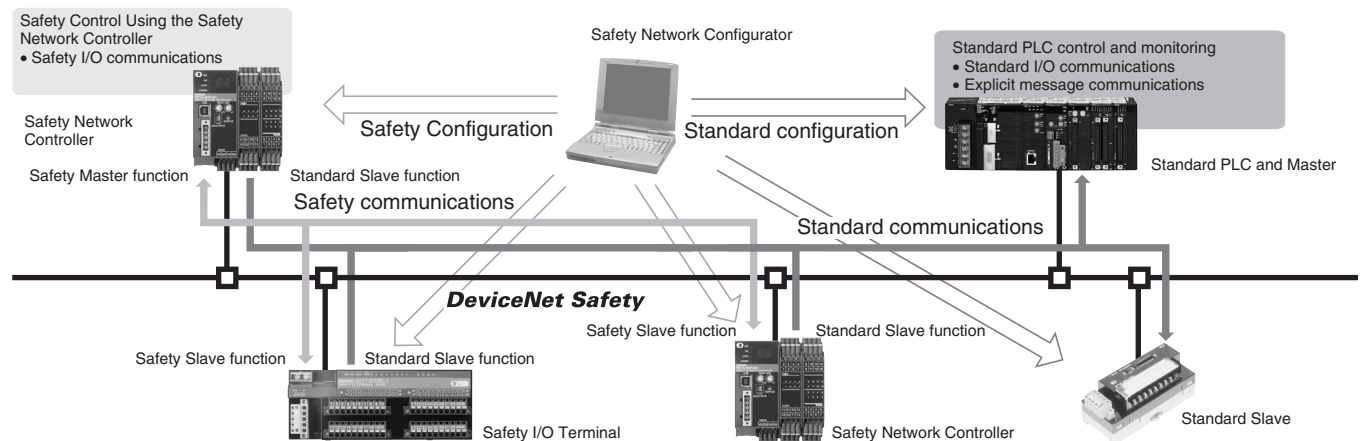

Specifications

■ Specifications

Applicable computer	IBM PC/AT or compatible
CPU	Intel Pentium PC, 300 MHz or higher
OS	Microsoft Windows 2000 Microsoft Windows XP
Supported languages	English
RAM	256 MB or higher
Hard disk	At least 40 MB of available hard disk space
Monitor	S-VGA or better display capability
CD-ROM	One CD-ROM drive min.
Communications ports	One of the following communications ports is required. <ul style="list-style-type: none"> • USB port Connecting online via the USB port (USB 1.1) of the NE1A-SCPU-series Controllers • DeviceNet Interface Card 3G8F7-DRM21 or 3G8E2-DRM21-V1: Connecting online via DeviceNet

Note: Windows is a registered trademark of Microsoft. IBM is a registered trademark of International Business Machines Corp.

Safety Precautions

Be sure to read the following operation manual for precautions and other details required for correct use of the Safety Network Controller.
DeviceNet Safety Safety Network Configurator Operation Manual (Cat. No. Z905)

Unit Versions and Network Configurator Versions

Network Configurator version 1.6□ or higher is required for the NE1A-SCPU01-V1 and NE1A-SCPU02. The relationship between unit versions and the version of the Network Configurator is shown in the following table.

○: Applicable, ×: Not applicable

Model	Version	Network Configurator		
		Ver. 1.32	Ver. 1.51	Ver. 1.6□
NE1A-SCPU01 Pre-Ver. 1.0		○	○	○
NE1A-SCPU01-V1 Unit version 1.0		×	×	○
NE1A-SCPU02 Unit version 1.0		×	×	○

ALL DIMENSIONS SHOWN ARE IN MILLIMETERS.
To convert millimeters into inches, multiply by 0.03937. To convert grams into ounces, multiply by 0.03527.

Accessories

Terminal Blocks for the NE1A

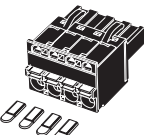
Appearance	Specification	Applicable Controllers	Model	Remarks
	Screw terminal blocks (4 pins)	NE1A-SCPU01 NE1A-SCPU01-V1 NE1A-SCPU02	Y9S-04T1B-02A	A set including two screw terminal blocks (black) and six code marks to prevent incorrect insertion
	Spring-cage terminal blocks (4 pins)		Y9S-04C1B-02A	A set including two spring-cage terminal blocks (black) and six code marks to prevent incorrect insertion



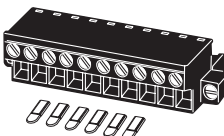
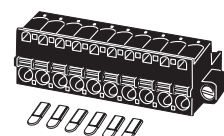

Note: The standard NE1A Controllers are equipped with spring-cage terminal blocks. Screw terminal blocks can be ordered if desired, e.g., to replace previous terminals.



Terminal Blocks for the DST1

Appearance	Specification	Applicable Safety I/O Terminals	Model	Remarks
	Screw terminal blocks (10 pins)	DST1-ID12SL-1 DST1-MD16SL-1 DST1-MRD08SL-1	Y9S-10T1B-04B	A set including four screw terminal blocks (black), six code marks to prevent incorrect insertion, one set of terminal labels (See note 1.), and code mark instructions
	Spring-cage terminal blocks (10 pins)		Y9S-10C1B-04B	A set including four spring-cage terminal blocks (black), six code marks to prevent incorrect insertion, one set of terminal labels (See note 1.), and code mark instructions

- Note:**
- The set of terminal labels is one sheet containing four sets of labels required for one Terminal Block, i.e., [1, 2 ... 10], [11, 12 ... 20], [21, 22 ... 30] and [31, 32 ... 40].
 - The standard DS1T Safety I/O Terminals are equipped with spring-cage terminal blocks. Screw terminal blocks can be ordered if desired, e.g., to replace previous terminals.

Peripheral Devices for DeviceNet Communications

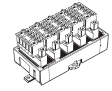
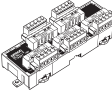
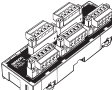
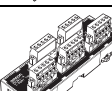
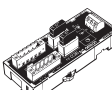
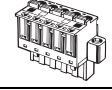
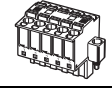
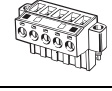
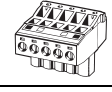
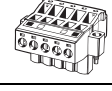
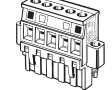
Product	Appearance	Model	Specification
T-branch Tap for 1 branch line		DCN1-1NC	Cable wiring direction: Toward top Cable lock direction: From top Connector screw direction: From top Provided with 3 parallel connectors with clamps (XW4G-05C1-H1-D), standard terminating resistor
		DCN1-1C	Cable wiring direction: Toward side Cable screw direction: From top Connector screw direction: From side Provided with 3 parallel connectors with screws (XW4B-05C1-H1-D), standard terminating resistor
		DCN1-2C	Cable wiring direction: Toward top Cable screw direction: From side Connector screw direction: From top
		DCN1-2R	Cable wiring direction: Toward side Cable screw direction: From top Connector screw direction: From top Provided with 3 orthogonal connectors with screws (XW4B-05C1-VIR-D), standard terminating resistor

Product	Appearance	Model	Specification	
T-branch Tap for 3 branch lines		DCN1-3NC	Cable wiring direction: Toward top Cable lock direction: From top Connector screw direction: From top	Provided with 5 parallel clamp connectors with screws (XW4G-05C1-H1-D), standard terminating resistor
		DCN1-3C	Cable wiring direction: Toward side Cable screw direction: From top Connector screw direction: From side	Provided with 5 parallel connectors with screws (XW4B-05C1-H1-D), standard terminating resistor
		DCN1-4C	Cable wiring direction: Toward top Cable screw direction: From side Connector screw direction: From top	
		DCN1-4R	Cable wiring direction: Toward side Cable screw direction: From top Connector screw direction: From top	Provided with 5 orthogonal clamp connectors with screws (XW4B-05C1-VIR-D), standard terminating resistor
Power Supply Tap		DCN1-1P	One-branch tap provided with 2 connectors, standard terminating resistor, and fuse	
Connectors		XW4G-05C1-H1-D	Parallel clamp connector with screws Connector insertion and wiring both performed horizontally.	
		XW4G-05C4-TF-D	Parallel multi-branching clamp connector with screws Connector insertion and wiring performed in same direction.	
		XW4B-05C1-H1-D	Parallel connector with screws Connector insertion and wiring performed in same direction.	
		XW4B-05C4-T-D	Parallel, screw-less, multi-branching connector Connector insertion and wiring performed in same direction.	
		XW4B-05C4-TF-D	Parallel, multi-branching connector with screws Connector insertion and wiring performed in same direction.	
		XW4B-05C1-VIR-D	Orthogonal connector with screws Connector insertion and wiring performed at a right angle.	
DeviceNet Cables		DCA1-5C10 (-B)	Thin cable length: 100 m DCA1-5C10-B:Cable color: Blue DCA1-5C10:Cable color: Gray	
		DCA2-5C10 (-B)	Thick cable length: 100 m DCA2-5C10-B:Cable color: Blue DCA2-5C10:Cable color: Gray	
Terminal-block Terminator		DRS1-T	Resistance of 121 Ω	

DeviceNet, CIP Safety, and DeviceNet Safety are registered trademarks of ODVA (Open DeviceNet Vendor Association, Inc.).

Warranty and Limitations of Liability

WARRANTY

OMRON's exclusive warranty is that the products are free from defects in materials and workmanship for a period of one year (or other period if specified) from date of sale by OMRON. OMRON MAKES NO WARRANTY OR REPRESENTATION, EXPRESS OR IMPLIED, REGARDING NON-INFRINGEMENT, MERCHANTABILITY, OR FITNESS FOR PARTICULAR PURPOSE OF THE PRODUCTS. ANY BUYER OR USER ACKNOWLEDGES THAT THE BUYER OR USER ALONE HAS DETERMINED THAT THE PRODUCTS WILL SUITABLY MEET THE REQUIREMENTS OF THEIR INTENDED USE. OMRON DISCLAIMS ALL OTHER WARRANTIES, EXPRESS OR IMPLIED.

LIMITATIONS OF LIABILITY

OMRON SHALL NOT BE RESPONSIBLE FOR SPECIAL, INDIRECT, OR CONSEQUENTIAL DAMAGES, LOSS OF PROFITS, OR COMMERCIAL LOSS IN ANY WAY CONNECTED WITH THE PRODUCTS, WHETHER SUCH CLAIM IS BASED ON CONTRACT, WARRANTY, NEGLIGENCE, OR STRICT LIABILITY.
In no event shall the responsibility of OMRON for any act exceed the individual price of the product on which liability is asserted.
IN NO EVENT SHALL OMRON BE RESPONSIBLE FOR WARRANTY, REPAIR, OR OTHER CLAIMS REGARDING THE PRODUCTS UNLESS OMRON'S ANALYSIS CONFIRMS THAT THE PRODUCTS WERE PROPERLY HANDLED, STORED, INSTALLED, AND MAINTAINED AND NOT SUBJECT TO CONTAMINATION, ABUSE, MISUSE, OR INAPPROPRIATE MODIFICATION OR REPAIR.

This catalog mainly provides information that is necessary for selecting suitable models, and does not contain precautions for correct use. Always read the precautions and other required information provided in product operation manuals before using the product.

- The application examples provided in this catalog are for reference only. Check functions and safety of the equipment before use.
- Never use the products for any application requiring special safety requirements, such as nuclear energy control systems, railroad systems, aviation systems, medical equipment, amusement machines, vehicles, safety equipment, or other application involving serious risk to life or property, without ensuring that the system as a whole has been designed to address the risks, and that the OMRON products are properly rated and installed for the intended use within the overall equipment or system.

Note: Do not use this document to operate the Unit.

OMRON Corporation Industrial Automation Company

Technology Development Center H.Q.
**Integration Strategy &
Business Development Center**
Shiokoji Horikawa, Shimogyo-ku,
Kyoto, 600-8530 Japan
Tel: (81)75-344-7123/Fax: (81)75-344-7172

Regional Headquarters

OMRON EUROPE B.V.
Wegalaan 67-69, NL-2132 JD Hoofddorp
The Netherlands
Tel: (31)2356-81-300/Fax: (31)2356-81-388

OMRON ELECTRONICS LLC
1 East Commerce Drive, Schaumburg, IL 60173
U.S.A.
Tel: (1)847-843-7900/Fax: (1)847-843-8568

OMRON ASIA PACIFIC PTE. LTD.
83 Clemenceau Avenue,
#11-01, UE Square,
Singapore 239920
Tel: (65)6835-3011/Fax: (65)6835-2711

OMRON (CHINA) CO., LTD.
Room 2211, Bank of China Tower,
200 Yin Cheng Zhong Road,
PuDong New Area, Shanghai, 200120 China
Tel: (86)21-5037-2222/Fax: (86)21-5037-2200

Authorized Distributor:

Note: Specifications subject to change without notice.

Cat. No. Z907-E1-04
Printed in Japan
1106-1M (0605) (C)