

# Mini Motor Contactor J7KNA

## Main contactor

- AC & DC operated
- Integrated auxiliary contacts
- Screw fixing and snap fitting (35 mm DIN-rail)
- Range from 4 to 5.5 kW (AC 3, 380/415V)
- 4 -main pole version (4 kW AC and DC coil)
- Auxiliary contacts suitable for electronic devices (DIN 19240)
- Finger proof (BGV A2)

## Accessories

- 2 and 4 pole additional auxiliary contacts in different configurations
- Mechanical interlock (in reversing contactor combination only)
- RC Suppressors
- Link modules for fuseless Load Feeders
- Insulated wiring systems (parallel, Star-delta combinations)



## Approved Standards

Standard	Standard	Guide No (US,C)
UL	VDE 0660	NLDX, NLDX7
ICE 947-5-1	EN 60947-5-1	

## Ordering Information

### Model Number Legend

#### 1. Mini Motor Contactors

J7KNA-□□-□□ □□□□

1    2    3    4

- 1) Mini Contactor
- 2) Rated Motor Current (AC3 400V)  
09: 9A  
12: 12A
- 3) Integrated auxiliary contact  
10: 1 NC 0 NC  
01: 0 NO 1NC  
4: 4 main pole type (no aux contact)
- 4) R: Reversing Contactor
- 5) Coil voltage (AC operated)<sup>1)</sup>  
24: AC24V 50/60Hz  
48: AC48V 50Hz  
60: AC60V 50Hz  
110: AC110-115V 50Hz, AC120-125V 60Hz  
180: AC180-210V 50Hz, AC200-240V 60Hz  
230: AC220-230V 50Hz, AC240V 60Hz  
240: AC230V-240V 50Hz  
400: AC380-400V 50Hz, AC440V 60Hz  
415: AC400-415V 50Hz

Coil voltage (DC operated)  
24D: DC24V  
48D: DC48V  
60D: DC60V  
110D: DC110V  
24VS: DC24V with diode

48VS: DC48V with diode  
110VS: DC110V with diode  
125VS: DC125V with diode

#### 2. Aux. Contact Modules for Mini Motor Contactors

J73KN-□□-□□

1    2    3

- 1) Auxiliary Contact Modules
- 2) A: for mini motor contactor (DIN EN 50005)  
AM: for mini motor contactor (DIN EN 50012)
- 3) Combination of NO/NC contacts  
11: 1 NO 1 NC  
02: 0 NO 2 NC  
04: 0 NO 4 NC  
22: 2 NO 2 NC  
40: 4 NO 0 NC
- 4) for Reversing Contactors  
v: left side  
x: right side

#### 3. Insulated wiring systems for motor contactors

J74-WKR-A

1    2    3

- 1) Additional reference for LVSG
- 2) WKR: Wiring Kit Reverser
- 3) Version

#### 4. Accessories for mini motor contactors/contactor relays (RC suppressor units)

J74KN-D-RC□□

1    2    3    4

- 1) Additional reference for LVSG
- 2) D: J7KNA(-AR)
- 3) RC = RC suppressor unit
- 4) Voltage

<sup>1)</sup> See datasheet J7KN Motor Contactor for RC-suppressor units.

## ■ System overview

### Mini Motor Contactors

AC Operated

	Ratings			Rated Current		Aux. Contacts		Type	Pack	Weight	
	AC2, AC3			AC3	AC1						
	380V 400V 415V kW	500V kW	660V 690V kW	400V A	690V A	NO	NC	Suitable Overload Relay <sup>*1</sup>	Coil Voltage <sup>*2</sup> 24V 50/60Hz 220-230V 50Hz	pcs.	kg/pc.
	<b>3-pole, With Screw Terminals</b>										
	4	4	4	9	20	1	-	J7TKN-A	J7KNA-09-10-□□□□□	10	0.16
	5.5	5.5	5.5	12	20	1	-	J7TKN-A	J7KNA-12-10-□□□□□	10	0.16
	4	4	4	9	20	-	1	J7TKN-A	J7KNA-09-01-□□□□□	10	0.16
	5.5	5.5	5.5	12	20	-	1	J7TKN-A	J7KNA-12-01-□□□□□	10	0.16
<b>4-pole, With Screw Terminals</b>											
4	4	4	9	20	-	-	J7TKN-A	J7KNA-09-4-□□□□□	10	0.19	

\*1) For details see datasheet J7TKN Thermal Overload Relay

\*2) Other coil voltages see page 6

### DC Solenoid Operated

	Ratings			Rated Current		Aux. Contacts		Type	Pack	Weight	
	AC2, AC3			AC3	AC1						
	380V 400V 415V kW	500V kW	660V 690V kW	400V A	690V A	NO	NC	Suitable Overload Relay <sup>*1</sup>	Coil voltage 24V DC 2,5W	pcs.	kg/pc.
	<b>3-pole, With Screw Terminals</b>										
	4	4	4	9	20	1	-	J7TKN-A	J7KNA-09-10-□□□□D(-VS) <sup>*2</sup>	10	0.19
	5.5	5.5	5.5	12	20	1	-	J7TKN-A	J7KNA-12-10-□□□□D(-VS) <sup>*2</sup>	10	0.19
	4	4	4	9	20	-	1	J7TKN-A	J7KNA-09-01-□□□□D(-VS) <sup>*2</sup>	10	0.19
	5.5	5.5	5.5	12	20	-	1	J7TKN-A	J7KNA-12-01-□□□□D(-VS) <sup>*2</sup>	10	0.19

\*1) For details see datasheet J7TKN Thermal Overload Relay

\*2) with built-in coil suppressor (diode + zener diode)



### Auxiliary contact blocks with screw terminals for contactors J7KNA-09... and J7KNA-12...

	Contacts		Rated Current		Thermal Rated Current	Type	Pack	Weight
	NO	NC	AC15 230V A	400V A				
	1	1	3	2	10	J73KN-AM-11	10	0.04
	-	2	3	2	10	J73KN-AM-02	10	0.04
	2	2	3	2	10	J73KN-AM-22	10	0.04

### Link modules for electric connection between MPCB and contactors

	Description	Version for contactors	For MPCB	Type	Pack pcs	Weight approx. kg/pc
	link module (electrical and mechanical connection) See datasheet J7MN Motor Protection Circuit Breaker	J7KNA 09-...12	J7MN 12 / J7MN 25	J74MN-VK1 12-25	1	0.015

Suppressor units

	Function	For Contactors	Voltages		Partnumber Type
	RC-Unit snap on 	J7KNA(-AR)	12 - 48 V 48 - 127 V 110 - 250 V	AC/DC AC/DC AC/DC	<b>J74KN-D-RC24</b> <b>J74KN-D-RC110</b> <b>J74KN-D-RC230</b>

## ■ System overview

### Mini Motor Contactors

#### AC Operated

Wiring Diagrams	Distinc. Number according to DIN EN 50012	Auxiliary Contact Blocks		Contactor with Auxiliary Contact Block			Contacts suitable for Electronic Circuits according to DIN 19240 for rated voltage 24V DC (test ratings 17V DC, 5mA) Mirror contacts	
		Type	NO	NC	Distinc. Number according to DIN EN 50012	NO		NC
<b>3-pole, With Screw Terminals</b>								
	10	J73KN-AM-11	1	1	21	2	1	Prefered combinations according to DIN EN 50012
		J73KN-AM-02	0	2	12	1	2	
		J73KN-AM-22	2	2	32	3	2	
	01	J73KN-A-11	1	1	-	1	2	Contacts according to DIN EN 50005
		J73KN-A-02	0	2	-	0	3	
		J73KN-A-40	4	0	-	4	1	
		J73KN-A-22	2	2	-	2	3	
J73KN-A-04	0	4	-	0	5			
<b>4-pole, With Screw Terminals</b>								
	00	J73KN-A-11	1	1	-	1	1	Contacts according to DIN EN 50005
		J73KN-A-02	0	2	-	0	2	
		J73KN-A-40	4	0	-	4	0	
		J73KN-A-22	2	2	-	2	2	
		J73KN-A-04	0	4	-	0	4	

#### DC Solenoid Operated

Wiring Diagrams	Distinc. Number according to DIN EN 50012	Auxiliary Contact Blocks		Contactor with Auxiliary Contact Block			Contacts suitable for Electronic Circuits according to DIN 19240 for rated voltage 24V DC (test ratings 17V DC, 5mA) Mirror contacts	
		Type	NO	NC	Distinc. Number according to DIN EN 50012	NO		NC
<b>3-pole, With Screw Terminals</b>								
	10	J73KN-AM-11	1	1	21	2	1	Prefered combinations according to DIN EN 50012
		J73KN-AM-02	0	2	12	1	2	
		J73KN-AM-22	2	2	32	3	2	
	01	J73KN-A-11	1	1	-	1	2	Contacts according to DIN EN 50005
		J73KN-A-02	0	2	-	0	3	
		J73KN-A-40	4	0	-	4	1	
		J73KN-A-22	2	2	-	2	3	
J73KN-A-04	0	4	-	0	5			



( ) = VS-Version

#### Auxiliary contact blocks with screw terminals for contactors J7KNA-09... and J7KNA-12...

Wiring Diagrams								Contacts suitable for Electronic Circuits according to DIN 19240 for rated voltage 24V DC (test ratings 17V DC, 5mA) Mirror contacts
J73KN-AM-11	J73KN-AM-02	J73KN-AM-22	J73KN-A-11	J73KN-A-02	J73KN-A-40	J73KN-A-22	J73KN-A-04	

■ System overview

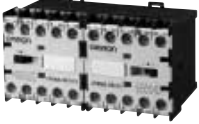

Mini Reversing Contactors, Mechanical Interlocked  
AC Operated

	Ratings			Rated Current		Aux. Contacts		Type	Pack	Weight	
	AC2, AC3	AC3	AC1	NO	NC	Suitable Overload Relay <sup>*1</sup>	Coil Voltage <sup>*2</sup>				
	380V 400V 415V kW	500V kW	660V 690V kW	400V A	690V A			24 230	pcs.	kg/pc.	
	<b>3-pole, With Screw Terminals</b>										
	4	4	4	9	20	-	1	J7TKN-A	J7KNA-09-01-R-□□□□□	1	0.32
	5.5	5.5	5.5	12	20	-	1	J7TKN-A	J7KNA-12-01-R-□□□□□	1	0.32

\*1) For details see datasheet J7TKN Thermal Overload Relay

\*2) Other coil voltages see page 6

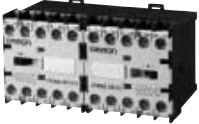

DC Solenoid Operated

	Ratings			Rated Current		Aux. Contacts		Type	Pack	Weight	
	AC2, AC3	AC3	AC1	NO	NC	Suitable Overload Relay <sup>*1</sup>	Coil voltage 24V DC 2,5W				
	380V 400V 415V kW	500V kW	660V 690V kW	400V A	690V A				pcs.	kg/pc.	
	<b>3-pole, With Screw Terminals</b>										
	4	4	4	9	20	-	1	J7TKN-A	J7KNA-09-01-R-□□□□D(-VS) <sup>*2</sup>	1	0.38
	5.5	5.5	5.5	12	20	-	1	J7TKN-A	J7KNA-12-01-R-□□□□D(-VS) <sup>*2</sup>	1	0.38

\*1) For details see datasheet J7TKN Thermal Overload Relay

\*2) with built-in coil suppressor (diode + zener diode)

Auxiliary contact blocks with screw terminals for contactors J7KNA-09-01-R...(D) and J7KNA-12-01-R...(D)

	Contacts		Rated Current		Thermal Rated Current	Type	Pack	Weight
			AC15 230V A	400V A				
	NO	NC					pcs.	kg/pc.
	1	1	3	2	10	J73KN-AM-11V	10	0.04
	1	1	3	2	10	J73KN-AM-11X	10	0.04





Insulated wiring systems for contactors J7KNA-09-01-R...(D) and J7KNA-12-01-R...(D)

	Description	Version (A)	For contactors	Type	Pack pcs
	Reversing Starter Connector with Coil Connector for Mini Reversing Contactors, mechanical interlocked	16	J7KNA-09-01-R...(D) & J7KNA-12-01-R...(D)	J74-WKR-A	1



## ■ System overview

### Mini Motor Contactors

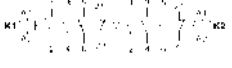
AC/DC solenoid operated

Wiring Diagrams	Distinc. Number according to DIN EN 50012	Auxiliary Contact Blocks suitable for				Contacts suitable for Electronic Circuits according to DIN 19240 for rated voltage 24V DC (test ratings 17V DC, 5mA) Mirror contacts		
		left hand side Contactor K1			right hand side Contactor K2			
		Type	NO	NC	Type	NO	NC	
<b>3-pole, With Screw Terminals</b>								
	01	<b>J73KN-AM-11V</b>	1	1	<b>J73KN-AM-11X</b>	1	1	

### Auxiliary contact blocks with screw terminals for contactors J7KNA-09-01-R...(D) and J7KNA-12-01-R...(D)

Wiring Diagrams							Contacts suitable for Electronic Circuits according to DIN 19240 for rated voltage 24V DC (test ratings 17V DC, 5mA) Mirror contacts
J73KN-AM-11V	J73KN-AM-11X						
							

## Specifications

### ■ Coil Voltages

Suffix to contactor type e.g. <b>J7KNA-09-10-24</b>	Voltage Marking at the coil		Rated Control Voltage $U_s$ range for			
	for 50Hz V	for 60Hz V	50Hz		60Hz	
			min V.	max V.	min V.	max V.
<b>24</b>	<b>24</b>	<b>24</b>	<b>22</b>	<b>24</b>	<b>24</b>	<b>24</b>
48	48	48	48	50	48	52
100	100	110-115	100	105	110	115
110	110-115	120-125	110	115	120	125
200	200	210-220	195	205	210	220
<b>230</b>	<b>220-230</b>	<b>240</b>	<b>220</b>	<b>230</b>	<b>240</b>	<b>250</b>
400	380-400	440	380	400	415	440
550	525-550	600	525	550	570	600

Standard voltages in bold type letters. Coil not exchangeable

Please see datasheet J7KN Motor Contactor for RC-suppressor units.

## Engineering data and Characteristics

### Mini Motor Contactors

Data according to IEC 947-4-1, VDE 0660, EN 60947-4-1

Main Contacts		Type	J7KNA-09-...	J7KNA-12-...
Rated insulation voltage $U_i$		V AC	690 <sup>(*)</sup>	690 <sup>(*)</sup>
Making capacity $I_{eff}$	at $U_e = 690V$ AC	A	165	165
Breaking capacity $I_{eff}$ $\cos\varphi = 0,65$	400V AC	A	100	100
	500V AC	A	90	90
	690V AC	A	80	80
<b>Utilization category AC1</b>				
<b>Switching of resistive load</b>				
Rated operational current $I_e (=I_{th})$ at 40°C, open		A	20	20
Rated operational power of three-phase resistive loads 50-60Hz, $\cos\varphi = 1$	230V	kW	7.9	7.9
	240V	kW	8.3	8.3
	400V	kW	13.8	13.8
	415V	kW	14.3	14.3
Rated operational current $I_e (=I_{the})$ at 60°C, enclosed		A	16	16
Rated operational power of three-phase resistive loads 50-60Hz, $\cos\varphi = 1$	230V	kW	6.3	6.3
	240V	kW	6.7	6.7
	400V	kW	11	11
	415V	kW	11.5	11.5
Minimum cross-section of conductor at load with $I_e (=I_{th})$		mm <sup>2</sup>	2.5	2.5
<b>Utilization category AC2 and AC3</b>				
<b>Switching of three-phase motors</b>				
Rated operational current $I_e$ open and enclosed	220V	A	12	15
	230V	A	11.5	14.5
	240V	A	11	14
	380-400V	A	9	12
	415-440V	A	8	11
	500V	A	7	9
	660-690V	A	5	6.5
Rated operational power of three-phase motors 50-60Hz	220-240V	kW	3	4
	380-440V	kW	4	5.5
	500-690V	kW	4	5.5
<b>Utilization category AC4</b>				
<b>Switching of squirrel cage motors, inching</b>				
Rated operational current $I_e$ open and enclosed	220V	A	12	15
	230V	A	11.5	14.5
	240V	A	11	14
	380-400V	A	9	12
	415-440V	A	8	11
	500V	A	7	9
	660-690V	A	5	6.5
Rated operational power of three-phase motors 50-60Hz	220-240V	kW	3	4
	380-440V	kW	4	5.5
	500-690V	kW	4	5.5

## Mini Motor Contactors

Data according to IEC 947-4-1, VDE 0660, EN 60947-4-1

Main Contacts		Type	J7KNA-09-...	J7KNA-12-...
<b>Utilization category DC1</b>				
<b>Switching of resistive load</b>	1 pole 24V	A	20	20
Time constant L/R 1ms	60V	A	20	20
Rated operational current I <sub>e</sub>	110V	A	5	5
	220V	A	0.6	0.6
3 poles in series	24V	A	20	20
	60V	A	20	20
	110V	A	20	20
	220V	A	16	16
<b>Utilization category DC3 and DC5</b>				
<b>Switching of shunt motors and series motors</b>	1 pole 24V	A	20	20
	60V	A	5	5
Time constant L/R 15ms	110V	A	1	1
Rated operational current I <sub>e</sub>	220V	A	0.15	0.15
	3 poles in series 24V	A	20	20
	60V	A	20	20
	110V	A	20	20
	220V	A	2	2
<b>Maximum ambient temperature</b>				
Operation	open	°C	-40 to +60 (+90) <sup>2</sup>	
	enclosed	°C		
with thermal overload relay	open	°C	-25 to +60	
	enclosed	°C		
Storage		°C	-50 to +90	
<b>Short circuit protection</b>				
for contactors without thermal overload relay				
Coordination-type "1" according to IEC 947-4-1				
Contact welding without hazard of persons max. fuse size	gL (gG)	A	40	40
Coordination-type "2" according to IEC 947-4-1				
Light contact welding accepted max. fuse size	gL (gG)	A	25	25
Contact welding not accepted max. fuse size	gL (gG)	A	10	10
For contactors with thermal overload relay the device with the smaller admissible backup fuse (contactor or thermal overload relay) determines the fuse size.				
<b>Cable cross-sections</b>				
for contactors without thermal overload relay				
main connector	solid or stranded	mm <sup>2</sup>	0.5 - 2.5	0.5 - 2.5
	flexible	mm <sup>2</sup>	0.5 - 2.5	0.5 - 2.5
	flexible with multicore cable end	mm <sup>2</sup>	0.5 - 1.5	0.5 - 1.5
Cables per clamp			2	2
	solid or stranded	AWG	18 - 14	18 - 14



**Mini Motor Contactors**

Data according to IEC 947-4-1, VDE 0660, EN 60947-4-1

Main Contacts		Type	J7KNA-09-...	J7KNA-12-...
<b>Frequency of operations z</b>	without load	1/h	10000	10000
Contactors without thermal overload relay	AC3, I <sub>e</sub>	1/h	600	700
	AC4, I <sub>e</sub>	1/h	120	150
	DC3, I <sub>e</sub>	1/h	600	700
<b>Mechanical life</b> AC operated	S x	10 <sup>6</sup>	5	5
	DC operated	S x	15	15
<b>Short time current</b>	10s-current	A	96	120
<b>Power loss</b> per pole	at I <sub>e</sub> /AC3 400V	W	0.15	0.25
<b>Resistance to shock according to IEC 68-2-27</b>				
Shock time 20ms sine-wave				
AC operated	NO	g	5	5
	NC	g	5	5
DC operated	NO	g	8	8
	NC	g	6	6

\*1) Suitable at 690V for: earthed-neutral systems, overvoltage category I to IV, pollution degree 3 (standard-industry): U<sub>imp</sub> = 8kV.  
Data for other conditions on request.

\*2) With reduced control voltage range 0.9 up to 1.0 x U<sub>s</sub> and with reduced rated current I<sub>e</sub>/AC1 according to I<sub>e</sub>/AC3

## Mini Motor Contactors

Data according to IEC 947-5-1, VDE 0660, EN 60947-5-1

Auxiliary Contacts		Type	J7KNA-09... J7KNA-12...	J7KNA-09...D(VS) <sup>1</sup> J7KNA-12...D(VS)	J73KN-A...
<b>Rated insulation voltage U<sub>i</sub></b>		V AC	690 <sup>2</sup>	690 <sup>1</sup>	690 <sup>1</sup>
<b>Thermal rated current I<sub>th</sub> to 690V</b>					
Ambient temperature	40°C	A	10	10	10
	60°C	A	6	6	6
<b>Power loss</b> per pole	at I <sub>th</sub>	W	0.5	0.5	0.5
<b>Utilization category AC15</b>					
Rated operational current I <sub>e</sub>	220-240V	A	3	3	3
	380-415V	A	2	2	2
	440V	A	1.6	1.6	1.6
	500V	A	1.2	1.2	1.2
	660-690V	A	0.6	0.6	0.6
<b>Utilization category DC13</b>					
Rated operational current I <sub>e</sub>	60V	A	2	2	2
	110V	A	0.4	0.4	0.4
	220V	A	0.1	0.1	0.1
<b>Maximum ambient temperature</b>					
Operation	open	°C	-40 to +60 (+90) <sup>3</sup>		
	enclosed	°C			
Storage		°C	-40 to +90		
<b>Short circuit protection</b> short-circuit current 1kA, contact welding not accepted					
max. fuse size	gL (gG)	A	20	20	20
For contactors with thermal overload relay the device with the smaller admissible control fuse (contactor or thermal overload relay) determines the fuse size.					
<b>Power consumption of coils</b>					
AC operated	inrush	VA	25	-	-
	sealed	VA	4 - 5	-	-
		W	1.2	-	-
DC operated	inrush	W	-	2.5	-
	sealed	W	-	2.5	-
<b>Operation range of coils</b> in multiples of control voltage U <sub>s</sub>			0.85 - 1.1	0.8 - 1.1	-
<b>Switching time</b> at control voltage U <sub>i</sub> ±10% <sup>4,5</sup>					
AC operated	make time	ms	15 - 25	-	-
	release time	ms	8 - 25	-	-
	arc duration	ms	10 - 15	-	-
DC operated	make time	ms	-	15 - 19	-
	release time	ms	-	8 - 25 (35) <sup>1</sup>	-
	arc duration	ms	-	10 - 15	-

## Mini Motor Contactors

Data according to IEC 947-5-1, VDE 0660, EN 60947-5-1

Auxiliary Contacts		Type	J7KNA-09... J7KNA-12...	J7KNA-09...D(VS) <sup>1</sup> J7KNA-12...D(VS)	J73KN-A...
<b>Cable cross-section</b>					
all connectors	solid	mm <sup>2</sup>	0.75 - 2.5	0.75 - 2.5	0.75 - 2.5
	flexible	mm <sup>2</sup>	0.75 - 2.5	0.75 - 2.5	0.75 - 2.5
	flexible with multicore cable end	mm <sup>2</sup>	0.5 - 1.5	0.5 - 1.5	0.5 - 2.5
Clamps per pole			2	2	2
	solid or stranded	AWG	18 - 14	18 - 14	18 - 14

\*1) version „VS“

\*2) Suitable at 690V for: earthed-neutral systems, overvoltage category I to IV, pollution degree 3 (standard-industry):  $U_{imp} = 8kV$ .  
Data for other conditions on request.

\*3) With reduced control voltage range 0.9 up to 1.0 x  $U_s$  and with reduced thermal rated current  $I_{th}$  to  $I_e/AC15$

\*4) Summary switching time = release time + arc duration

\*5) Release time of NC make time of NO increase when suppressor units for voltage peak protection are used (Varistor, RC-units, Diode units).

## Mini Contactors for North America

Data according to UL508

Main Contacts (cULus)		Type	J7KNA-09...	J7KNA-12...	J73KN-A...
Rated operational current "General Use"		A	15	20	10
Rated operational power of three-phase motors at 60Hz (3ph)	115V	hp	1½	2	-
	200V	hp	3	3	-
	230V	hp	3	3	-
	460V	hp	5	7½	-
	575V	hp	7½	10	-
Rated operational power of of AC motors at 60Hz (1ph)	115V	hp	½	¾	-
	200V	hp	1	1½	-
	230V	hp	1½	2	-
Fuses		A	30	30	-
Suitable for use on a capability of delivering not more than rms (SCCR)		A	5000	5000	-
		V	600	600	-
Rated voltage		V AC	600	600	600
<b>Auxiliary Contacts (cULus)</b>					
	heavy pilot duty	AC	A600	A600	A600
	standard pilot duty	DC	Q600	Q600	Q600

## ■ Dimensions

AC and DC operated  
with screw terminals

### Auxiliary Contact Blocks

J7KNA-09...  
J7KNA-12...

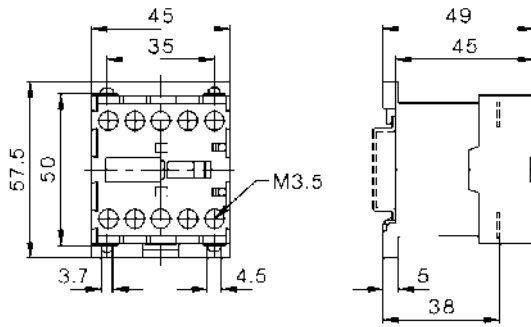

J73KN-A...

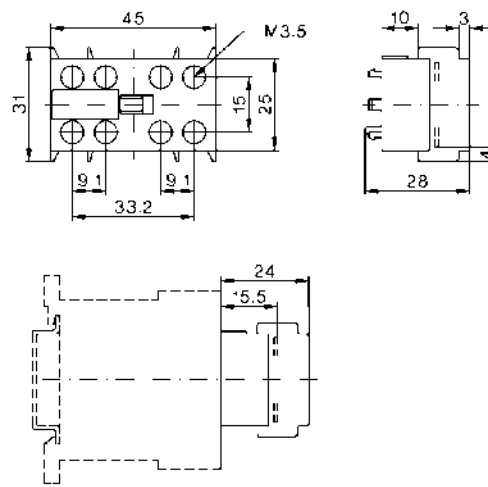

### Reversing Contactors

J7KNA-09-01-R...  
J7KNA-12-01-R...

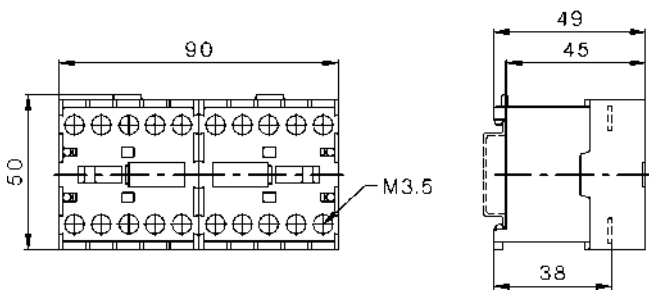

J7KNA-09-01-R... + J7TKN-A  
J7KNA-12-01-R... + J7TKN-A

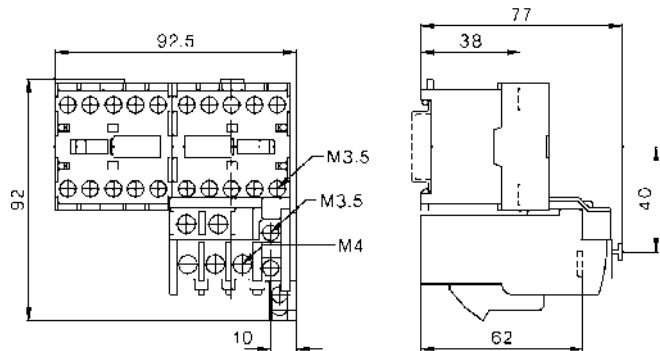

### Suppressor units

J74KN-D-RC...

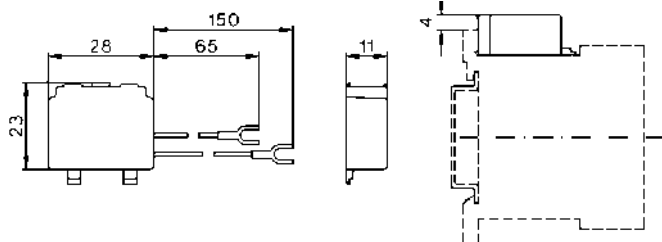

ALL DIMENSIONS SHOWN ARE IN MILLIMETERS.

To convert millimeters into inches, multiply by 0.03937. To convert grams into ounces, multiply by 0.03527.