

### Easy Programming with Large LCD Display and Interactive Functions

- Programming for 24 hrs x 7 days using just five switches.
- Sixteen program steps available.
- Power supply freely selectable from 100 to 240 VAC.
- 15 A control outputs from first and second circuits.
- Manual ON/OFF switching for control output without changing the program.
- Memory protection during power failure for up to 10 years.
- Cycle operation possible.
- Surface, flush, or track mounting.

RC+

### Ordering Information

Wiring	Backup power supply function for memory protection	No. of program steps	Model
Screw terminals	Provided (approx. 10 years at 25°C)	16 in total of first and second circuits (Each ON or OFF is considered to be one step.)	H5L-A

### Specifications

#### ■ Time Ranges

Rated time	Time setting range	Time division
24 hrs x 7 days	00:00 to 23:59	1 min

#### ■ Ratings

Rated supply voltage	100 to 240 VAC (50/60 Hz)
Operating voltage range	85% to 110% of rated supply voltage
Power consumption	7 VA
Control outputs	15 A at 250 VAC, resistive load at 50°C 12 A at 250 VAC, resistive load at 55°C

## ■ Characteristics

Accuracy of operating time	±0.01% ±0.05 s max. (see note 1)
Setting error	
Influence of voltage	
Influence of temperature	
Cyclic error	±15 s (at 25°C)
Insulation resistance	100 MΩ min. (at 500 VDC)
Dielectric strength	2,000 VAC, 50/60 Hz for 1 min (between current-carrying terminals and exposed non-current-carrying metal parts) 1,000 VAC, 50/60 Hz for 1 min (between control power supply circuit and contact control output circuits, between non-continuous contacts)
Vibration resistance	Destruction: 10 to 55 Hz with 0.75-mm double amplitude Malfunction: 10 to 55 Hz with 0.5-mm double amplitude
Shock resistance	Destruction: 300 m/s <sup>2</sup> (approx. 30G) Malfunction: 100 m/s <sup>2</sup> (approx. 10G)
Ambient temperature	Operating: -10°C to 55°C
Ambient humidity	Operating: 35% to 85%
Life expectancy	100,000 operations min. (15 A at 250 VAC, resistive load)
Approved standards	UL (File No. E52800), CSA (File No. LR22310), SEV
Weight	Approx. 350 g

**Note:** The overall error, which includes repeat accuracy, setting error, and variations due to changes in voltage and temperature, is ±0.01% or ±0.05 s max..

## Engineering Data

### Ambient Operating Temperature and Carry Current

Note that the upper limit of the ambient operating temperature lowers when a large carry current is being applied as shown below.

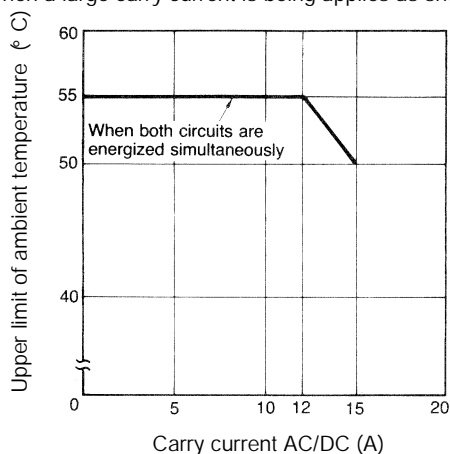

# Nomenclature

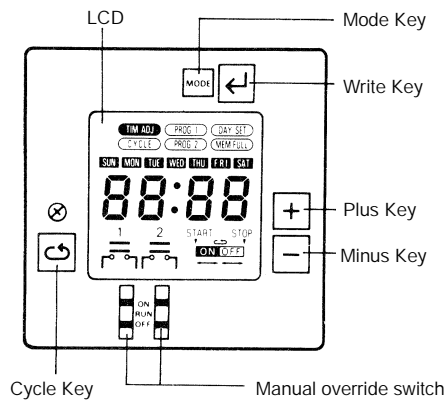

**Note:** This figure shows the LCD section with all display items being displayed on the screen.

## Key Operation

Key	Name	Function
	Mode Key	Changes program mode <div style="display: flex; justify-content: space-around; align-items: center; margin-top: 10px;"> <div style="border: 1px solid black; padding: 2px;">RUN mode</div> <div style="border: 1px solid black; padding: 2px;">Current time setting mode</div> <div style="border: 1px solid black; padding: 2px;">First circuit operation setting mode</div> </div> <div style="display: flex; justify-content: space-around; align-items: center; margin-top: 5px;"> <div style="border: 1px solid black; padding: 2px;">Second circuit weekday setting mode</div> <div style="border: 1px solid black; padding: 2px;">Second circuit operation setting mode</div> <div style="border: 1px solid black; padding: 2px;">First weekday setting mode</div> </div>
	Write Key	To write the set data using the Plus and/or Minus Key. Reads out the set program.
	Plus Key	Changes "day of week" while setting day of week. Changes "hours" or "minutes" while setting current time. When the Plus Key is held down, the displayed digit increments continuously; when the Minus Key is held down, it decrements continuously.
	Minus Key	When specifying output. The Plus Key specifies output ON while the Minus Key specifies output OFF. Note that if the same key is pressed twice, the output specification becomes invalid; neither ON nor OFF is set.
	Cycle Key	Specifies the cycle program. Pressing this key twice causes the set cycle program to be cleared.
	Manual override switch	ON: Turns ON output regardless of program RUN: Executes program OFF: Turns OFF output regardless of program First and second circuit can be operated independently.

# Operation

## ■ Programming

The H5L Weekly Timer has the following six program modes. Use the Mode Key to change the modes. Use the Write Key, Plus Key, Minus Key, and Cycle Key for programming in each mode.

### Mode Change Sequence

### Programming Details

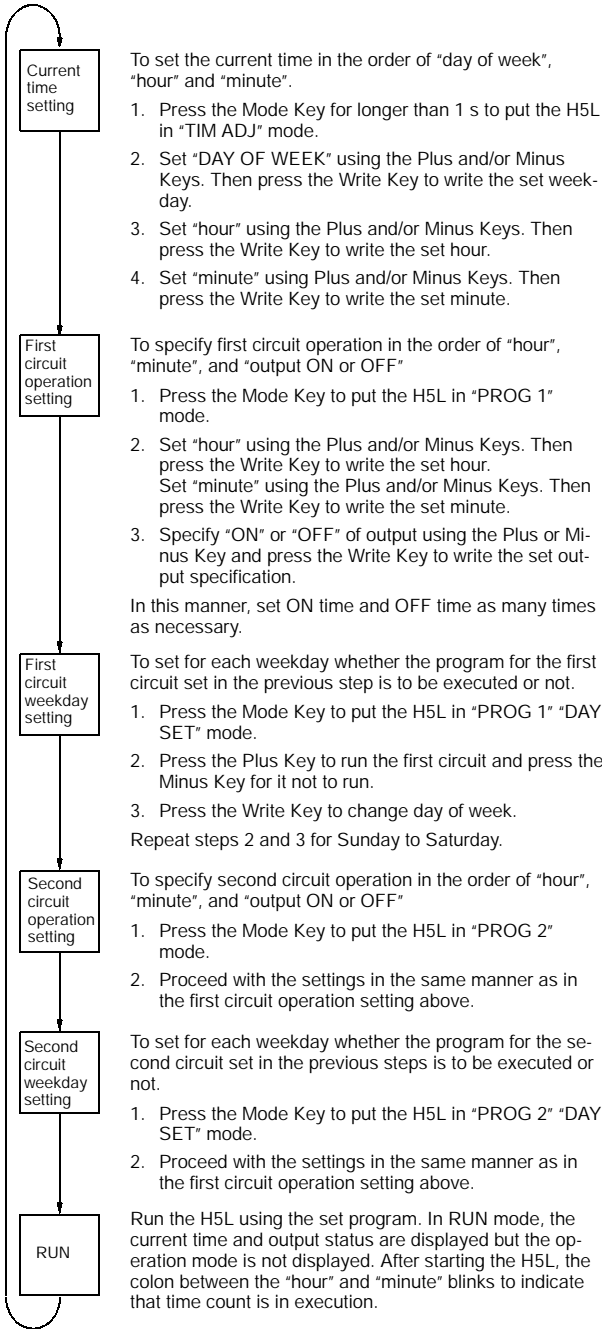

**Note:** The H5L operates in accordance with the program already set even while another program is being set. The output status display ( etc.) during programming displays the setting being programmed. Therefore, note that the output status displayed on the LCD may not agree with the actual output status.

## Cycle Program

In the H5L, the cycle program can be used to repeat ON and OFF of output for a certain period in a predetermined cycle. A cycle program consists of the following four steps: Start time, ON time, OFF time, Stop time

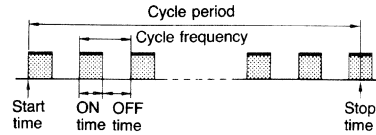

## Setting A Cycle Program

Set the four steps of the cycle program in the following procedure.

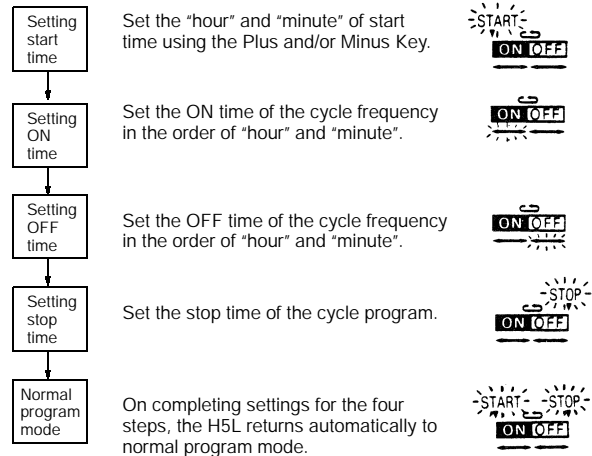

## Cautions on Using Cycle Programs

1. When the current time is included within the set cycle period, the cycle operation starts (output turns ON) on completing the cycle program setting (when stop time is written).
2. When any of the following occurs during a cycle period, the cycle operation restarts from output ON.

Recovery after power failure  
Current time adjustment

Change of start or stop time of the cycle program during operation. For this reason, if the cycle programs for the first and second circuits are set in such a manner that outputs 1 and 2 have a phase difference, note that the phase difference is changed when any of the abovementioned conditions occur as shown in the example below. (Therefore, it is recommended that cycle programs are used sequentially.)

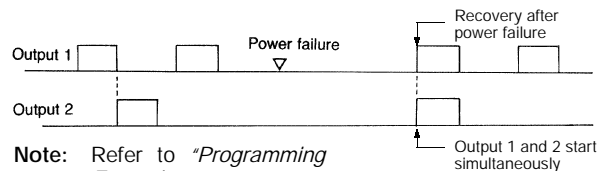

3. The cycle period (from start time to stop time) must not be a multiple of the cycle frequency (ON time plus OFF time). The cycle period can be set within a range of 1 min to 24 hrs.
4. ON time as well as OFF time can be set within a range of 1 min to 23 hrs 59 min.

### Deleting Programming

#### 1. Deleting from Normal Operation Programs (ON Time/OFF Time)

Call up the output display for the program to be deleted by pressing the Write Key. The minus sign (-) for the output point will flash.

Next, change the display to disable the output using the Plus and Minus Keys. For NC contacts, press the Plus Key and for NO contacts, press the Minus Key. The connecting bar above the contacts will disappear and the display will flash to indicate that the output has been displayed. If the Write Key is pressed at this time, the step will be deleted.

#### 2. Deleting from Cyclic Programs

Four steps will be simultaneously deleted from the cyclic program if the program is called up and then the Cycle and Write Keys are pressed in order. The start time display will remain, but the program will be deleted.

## ■ LCD Display

### LCD Display (Display Example in Each Mode)

Since the H5L employs interactive programming, the program mode and setting data are displayed on the LCD.

Display	Mode	Display data	Display	Mode	Display data
	RUN	Current day of week: Monday Current time: 10:11 First circuit: OFF Second circuit: ON		Second operation time setting	The second circuit turns ON Sunday to Thursday (operation by the set program is executed). It turns OFF on Friday and Saturday (operation by the set program stops).
	Current time setting	Current day of week: Tuesday Current time: 9:31		Second Weekday setting	The second circuit turns ON Sunday to Thursday (operation by the set program is executed). It turns OFF on Friday and Saturday (operation by the set program stops).
	First operation time setting	The first circuit turns on at 8:15		Cycle Program setting	The first circuit starts cycle operation at 1:10 (for details, refer to Cycle Program).
	First weekday setting	The first circuit turns OFF on Sunday and Saturday (operation by the set program stops). It turns ON Monday to Friday (operation by the set program is executed).		Memory over	Indicates that all 16 program steps have been written (on writing the 16th step, the data set for the first step is displayed on the LCD).

Note: Meaning of output status indications

:Output ON, ; Output OFF, ; Invalid (if an invalid instruction is written to a step, that step will be cleared.)

## ■ Programming Example

Be sure to create a timing chart before programming.

### Operating Timing Chart

#### First Circuit

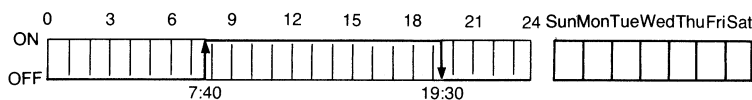

#### Second Circuit

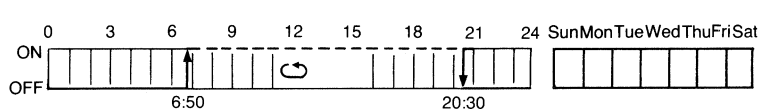

## Example

### ON and OFF Programs Cyclic Programs

In this example, the first circuit is programmed to turn ON at 7:40 and OFF at 19:30. This circuit is operated from Monday through Friday and stopped on Saturday and Sunday.

The second circuit is cyclically operated with each parameter set as follows:

Start time: 6:50

ON time: 5 min

OFF time: 20 min

Stop time: 20:30

The second circuit is stopped from operating on Sunday and operated from Monday through Saturday. The current time is assumed to be 11:15 a.m. on Tuesday.

### Writing Program

Even while being programmed, the timer generates output according to the previous program. If you don't want an unexpected operation of output relay, turn on (or off) the manual switch.

In the figure, the indicators and digits shown in are blinking.

#### 1. Setting Current Time



To set the current time, "day of the week", "hour", and "minute" must be specified.

First, turn on the power to the H5L.

The contents of the memory are cleared on power-up and the TIM ADJ indicator is displayed as shown on the left.

As an example, set the time to 11:15 on Tuesday.



Start by setting the day of the week. The blinking indicator indicates the parameter that can be set.

Set the current day of the week to Tuesday by pressing the Plus or Minus Key.



When "TUE" is displayed, press the Write Key to store the current day of the week in memory. The "hour" indicator will begin to flash and the "day of the week" indicator will stop flashing.



Set the current hour to 11 by pressing the Plus or Minus Key, followed by the Write Key.



At this time, the "minute" indicator will blink. Set the current minute to 15 by pressing the Plus or Minus Key, followed by the Write Key.

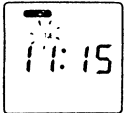

This completes the current time setting.

2. First Circuit Operation Setting

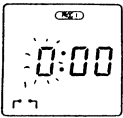

To program the operation of the first circuit, "hour", "minute", and "output" must be specified. Press the Mode Key to place the H5L into PROG 1 mode. The display will be as shown on the left.

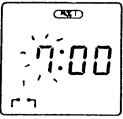

Since the first circuit is to be turned ON at 7:40, set the "hour" to 7 by pressing the Plus or Minus Key and then store it in memory by using the Write Key.



The "minute" will start blinking. Set it to 40 by using the Plus or Minus Key and store it in memory by pressing the Write Key.



Now, the output status indicator will blink. Set the output to the ON state with the Plus Key followed by the Write Key. (If the Plus Key is pressed twice at this time, the display will give an invalid indication, and if the Write Key is pressed, this program will be deleted.)

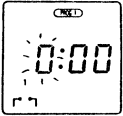

The display returns to the initial state as shown on the left and waits for the next program command to be input.

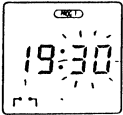

Since the first circuit should be turned OFF at 19:30, set the hour to 19 and the minute to 30 by using the Plus or Minus Key and then the Write Key.



The output status indicator starts blinking. Set the output to the OFF state using the Minus Key and store it in memory by pressing the Write Key.

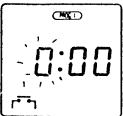

The display returns to the initial state and waits for the next program command to be input. Now let us turn to the setting of the "day of the week".

3. First Circuit Day-of-the-week Setting

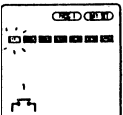

By pressing the Mode Key, place the H5L into DAY SET mode. The display will be as shown on the left. Press the Plus Key to operate the first circuit on a particular day of the week and press the Minus Key to stop it. The reverse video (i.e., white characters on a black background) of the day-of-the-week indicators means that the first circuit is operated on that day. The day on which circuit operation is stopped is indicated by bold indicators. Initially, the circuit is set to operate on all the days of the week and the SUN indicator blinks.

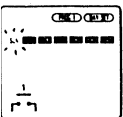

In this example, since circuit operation is to be stopped on Sunday, select SUN and press the Minus Key, then store the setting in memory by pressing the Write Key.

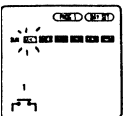

The MON indicator will start blinking. Press the Write Key, until the SAT indicator blinks.

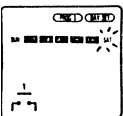

Since the first circuit is not to be operated on Saturday, press the Minus Key followed by the Write Key.



The SUN indicator will start blinking again. This completes the setting of all the days of the week for the first circuit.

#### 4. Second Circuit Operation Setting

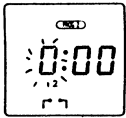

Press the Mode Key to place the H5L into PROG 2 mode. The display appears as shown on the left.

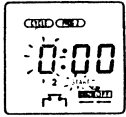

In this example, as the second circuit is to be cyclically operated, specify the cycle program by pressing the Cycle Key.

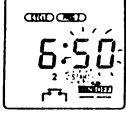

Select the start time by setting the hour to 6 and the minute to 50 using pressing the Plus or Minus Key. Write each set value by pressing the Write Key.

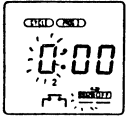

The timer will now wait for you to set the ON time (5 min in this example).



Press the Write Key to select 0 hrs, then use the Plus or Minus Keys followed by the Write Key to select 5 min.

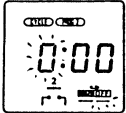

The timer will now wait for the OFF time to be set (20 min in this example).

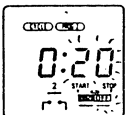

Press the Write Key to select 0 hrs, then use the Plus or Minus Keys followed by the Write Key to select 20 min.

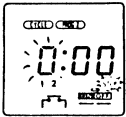

The timer will now wait for the cyclic circuit operation stop time to be set (20:30 in this example).



Set the hour to 20 using the Plus or Minus Keys, then press the Write Key. Set the minutes to 30 and press the Write Key again.

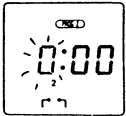

The programming of the cyclic operation is now complete. The timer will wait for input of a new program as shown. We will now have to set the day of the week for the second circuit.

#### 5. Second Circuit Day-of-the-Week Setting

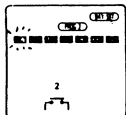

Press the Mode Key to place the H5L into PROG 2, DAY WET mode. Initially, all days of the week are selected (shown by reverse video) and the SUN indicator will be flashing.

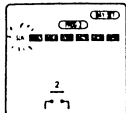

In our example, the second circuit is to be operated on all days except Sunday. To inhibit Sunday operation, press the Minus Key while the SUN indicator is flashing. The circuit will now be operated only from Monday to Saturday.

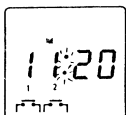

All of the parameters have now been programmed for this example. Press the Mode Key to place the timer into RUN mode. The display will be as shown (assuming five minutes have elapsed while programming). The output status indicators indicate the status of each of the circuit.

**Note:** Set manual override switches 1 and 2 to RUN.



# Dimensions

Note: All units are in millimeters unless otherwise indicated.

## H5L-A

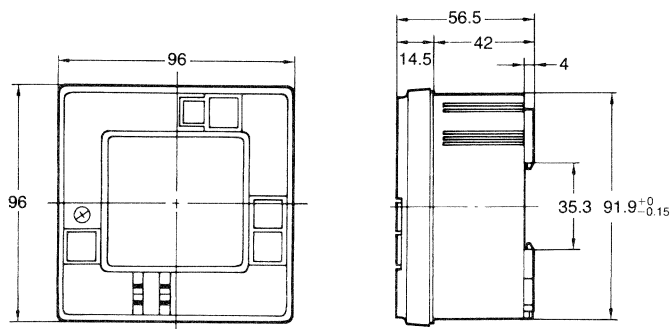

### Mounting Dimensions

#### Flush Mounting

Use a U-shaped mounting bracket to flush mount the unit.

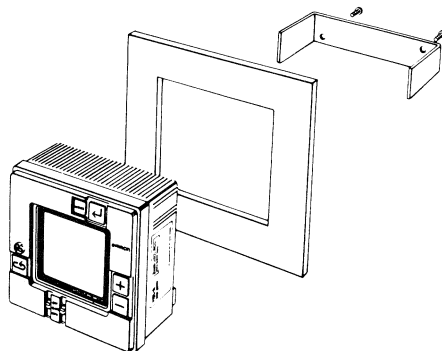

Dimensions

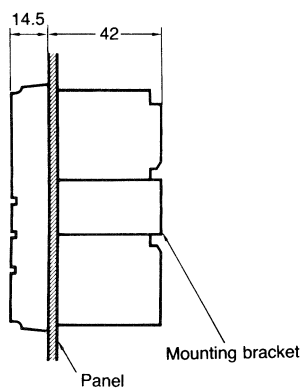

Panel Cutout

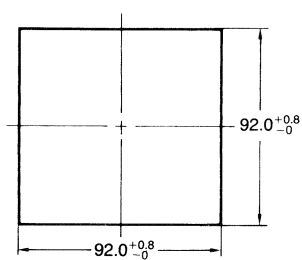

Mounting Bracket (Included)



### Surface Mounting

Use a straight mounting bracket to surface mount the unit.

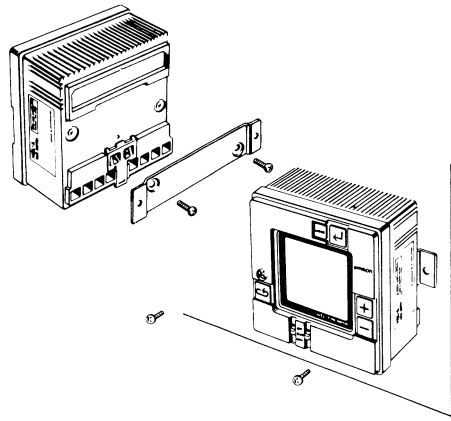

Dimensions

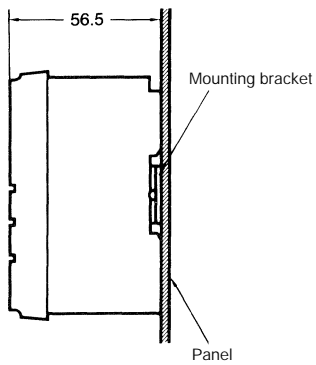

Panel Cutout

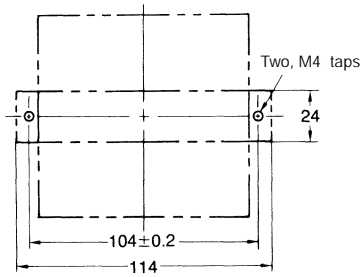

Mounting Bracket (Included)



### Track Mounting

Hook the upper part on the rear surface to the upper edge of the mounting track and press the unit down.

(1)

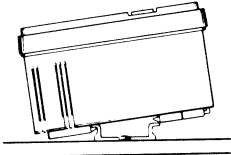

(2)

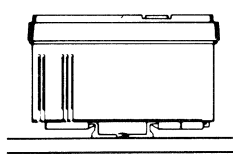

Dimensions

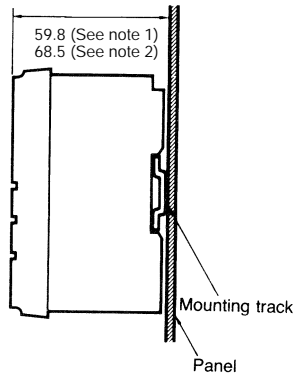

**Note:** 1. When using mounting track PFP-100N or PFP-50N.  
 2. When using mounting track PFP-100N2.

■ Accessories (Order Separately)

Front Cover

Y92A-96A

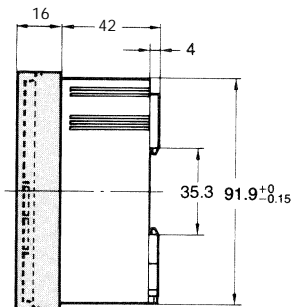
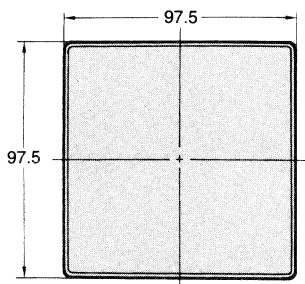
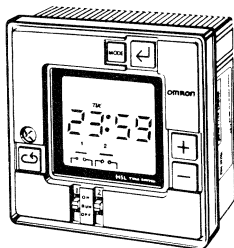

Mounting Track (Meets DIN EN 50022)

PFP-100N/PFP-50N

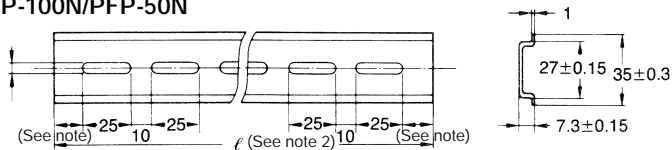

PFP-100N2

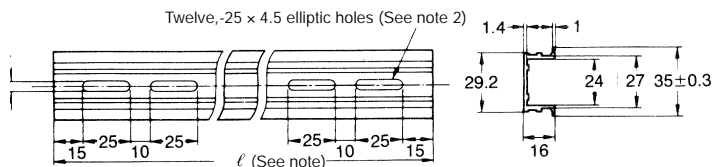

- Note:**
1. This dimension is 15 mm on both ends in the case of the PFP-100N but on one end in the case of the PFP-50N.
  2. The length *l* of each mounting track is shown in this table.
  3. A total of twelve 25 x 4.5 elliptical holes are provided, with six holes cut from each end of the track at a pitch of 10 mm between holes.

PFP-100N	1 m
PFP-50N	50 cm
PFP-100N2	1 m

## Installation

### ■ Wiring

#### Wiring From the Rear

Perform wiring from the rear of the unit when the unit is flush mounted.

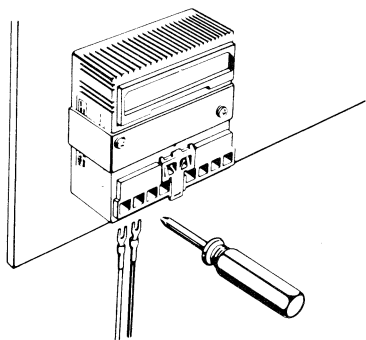

#### Wiring From the Front

Perform wiring from the front of the unit when the unit is track or surface mounted.

1. Loosen the screw on the left side of the front.
2. Slide the upper part of the unit approx. 15 mm upward.
3. After the terminals appear, perform wiring.
4. Return the upper part of the unit to the original position and tighten the screw.

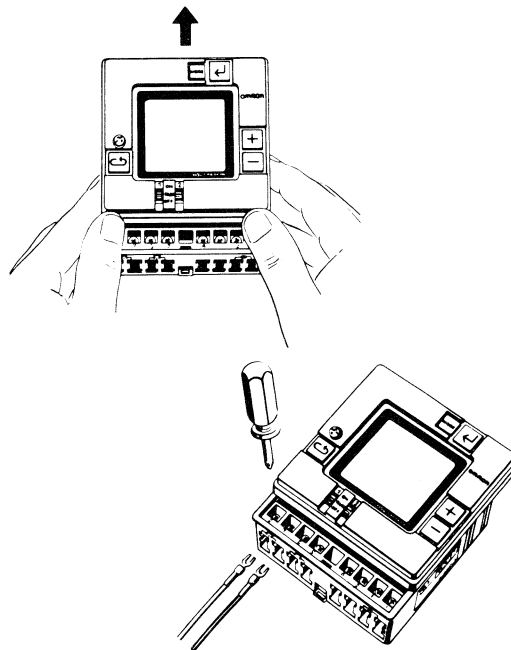

### ■ Connections

Connect the power supply between terminals A and B, the load for the first circuit between terminals G and H, and the load for the second circuit between terminals E and F. Terminals C and D are no connects.

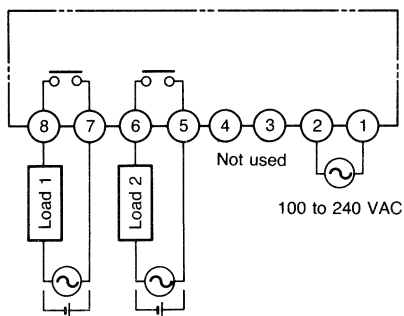

**Note:** To each load, connect the power supply for load.

## Precautions

### Backup Power Supply for Memory Protection during Power Failure

The Model H5L Time Switch has a built-in battery. This backup power supply allows continuous operation of the internal timer circuit during a power failure. If the duration of a power failure or service interruption is within the life-time of the backup battery, no time adjustment is required for the timer. Note that during a power failure, the output contacts are in the OFF state and the display is dark. The backup battery has a life-time of 10 years assuming normal usage.

Please do not burn or puncture the lithium battery included with this product, since it poses a health hazard.

### Others

The load current of the control output should be within the ratings specified in the connection diagram. If these ratings are exceeded, the contact service life will be reduced significantly.

When doing impulse voltage or insulation resistance tests with the time switch mounted on a board, remove the time switch body to isolate the time switch circuit. This will prevent degradation or damage to the internal circuitry of the time switch.

When using the timer switch under noisy condition, isolate the time switch from any noise sources or high power lines.

Avoid the following conditions:

- Corrosive gases.
- Constant vibrations or large shocks.
- Water or oil spray.
- Dust.
- Direct sunlight.
- Organic solvents (thinner or benzine), strong acids or bases.

If operating conditions exceed the above values, be sure to connect a surge absorber. When switching inductive loads, counterelectromotive force is generated. When using the H5L as a switch contactor or for similar functions, connect a surge absorber to prevent malfunctions or damage to the timer.

Perform wiring so that the potential across the output contacts is the same. This prevents short circuiting of the contacts as shown below.

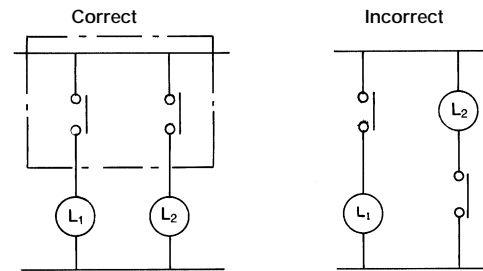

The optional cover (Y92A-96A) is recommended for dusty conditions.

Do not take the case off the body.

When using the time switch in conditions subject to static electricity, (caused by transportation of molding materials and liquid materials with pipes), isolate the time switch from the source of the static electricity.

The storage temperature range for the time switch is  $-25^{\circ}\text{C}$  to  $65^{\circ}\text{C}$ . If the time switch is stored at temperatures below  $-10^{\circ}\text{C}$  leave it more than 3 hours at the room temperature and then apply the power.

### WARNING

#### Fire, Explosion, and Severe Burn Hazard

The H5L has a built-in lithium battery. Be sure to dispose of the old H5L properly, as lithium batteries are likely to explode if incinerated.

**ALL DIMENSIONS SHOWN ARE IN MILLIMETERS.**

To convert millimeters into inches, multiply by 0.03937. To convert grams into ounces, multiply by 0.03527.