

## Digital Timer

## H5CL

### Easy-to-see and Easy-to-operate DIN 48 x 48 mm Digital Timer with IP66/NEMA 4 Protection

- Water- and dust-protected for severe environments.
- Large, high-visibility LED displays with a height of 12 mm.
- Simple setting with Increment and Decrement Keys.
- Conforms to EMC standards.
- Six-language instruction manual provided.



## Ordering Information

Outputs	Supply voltage	Model	
		Without Finger Safe Terminal Cover	With Finger Safe Terminal Cover
Contact output	100 to 240 VAC	H5CL-A	---
	12 to 24 VDC	H5CL-AD	H5CL-AD-500
Transistor output (Photocoupler)	100 to 240 VAC	H5CL-AS	---
	12 to 24 VDC	H5CL-ADS	---

### Model Number Legend:

H5CL-A    
1 2 3

1. Fixed
2. D: DC Supply Voltage
3. S: Transistor output

### ■ Accessories (Order Separately)

Name	Model
Hard cover	Y92A-48
Soft cover	Y92A-48F1
Track Mounting/Front Connecting Socket (for AC models only)	---
	Finger safe type
Back Connecting Socket (for AC models only)	---
	Finger safe type
Finger Safe Terminal Cover for DC models	Y92A-48T
Flush Mounting Adapter (see note 2)	Y92F-30

- Note:**
1. Y92A-48G is a finger safe terminal cover which is attached to the P3GA-11 Socket.
  2. Supplied with each Unit.

# Specifications

Item	H5CL-A□ (AC models)	H5CL-AD□ (DC models)
<b>Classification</b>	Digital timer	
<b>Mounting</b>	DIN track, surface, and flush mounting (common)	Flush mounting
<b>External connections</b>	Socket	Screw terminals
<b>Enclosure ratings</b>	Panel surface: IEC IP66 and NEMA Type 4 (indoors) when Y92S-29 rubber packing is used.	
<b>Digits</b>	4 digits (zero suppress method)	
<b>Max. time settings</b>	9.999 s (0.001-s unit), 99.99 s (0.01-s unit), 999.9 s (0.1-s unit), 9999 s (1-s unit), 99 min 59 s (1-s unit), 999.9 min (0.1-min unit), 99 h 59 min (1-min unit), 999.9 h (0.1-h unit)	
<b>Display modes</b>	Up (increment) and Down (decrement) (selectable)	
<b>Input signals</b>	Start, gate, reset, and key protection	
<b>Input method</b>	No-voltage input: via NPN transistor or switching of contact	
<b>Operating modes</b>	A (signal ON-delay), F (accumulative operation) (selectable)	
<b>Reset system</b>	Power reset (A (signal ON-delay) mode only), external, manual resets	
<b>Sensor waiting time</b>	216 ms typ., 250 ms max. (Control output is turned OFF and no input is accepted during sensor waiting time.)	
<b>External power supply</b>	50 mA at 12 VDC (±10%)	---
<b>Display</b>	7-segment LEDs (12 mm high, red LEDs for the present value, and 8 mm high, green LEDs for the set value)	
<b>Memory backup</b>	EEP-ROM (overwritten 200,000 times min.), which can store data for 20 years min.	
<b>Mounting method</b>	DIN track mounting, surface mounting, and flush mounting	Flush mounting
<b>Approved standards</b>	UL 508, CSA C22.2 No.14 Conforms to EN61010-1	

## ■ Ratings

Item	H5CL-A□ (AC models)	H5CL-AD□ (DC models)
<b>Rated supply voltage</b>	100 to 240 VAC, 50/60 Hz	12 to 24 VDC (permissible ripple: 20% (p-p) max.)
<b>Operating voltage range</b>	85 to 264 VAC, 50/60 Hz	10.8 to 26.4 VDC
<b>Power consumption</b>	Approx. 10 VA	Approx. 3 W
<b>Start, reset, gate inputs</b>	Min. pulse width: 1 ms/20 ms (selectable, same for all three inputs)	
<b>Key protection input</b>	Response time: 1 s max.	
<b>Power reset</b>	Min. power opening time: 0.5 s (excluding F (accumulative operation) mode)	
<b>Control output</b>	Contact output: SPDT, 3 A at 250 VAC, resistive load ( $\cos\phi = 1$ ) Min. applicable load: 10 mA at 5/24 VDC (P level, for reference value) Transistor output: NPN open collector, 100 mA max. at 30 VDC max., residual voltage 1.5 VDC max.	

## ■ Characteristics

Item	H5CL-A□ (AC models)	H5CL-AD□ (DC models)
<b>Deviation of operating time and setting error (including temperature and voltage influences)</b>	Power start: $\pm 0.01\% \pm 0.05$ s max. (see note 1) Signal start: $\pm 0.005\% \pm 0.03$ s max. (see note 1) Signal start, at transistor output model: $\pm 0.005\% \pm 3$ ms max. (see note 1 and 2) If the set value is within the sensor waiting time (250 ms max.) in the case of power start, the control output of the H5CL will not be turned ON until the sensor waiting time passes.	
<b>Insulation resistance</b>	100 M $\Omega$ min. (at 500 VDC) (between current-carrying terminal and exposed non-current-carrying metal parts, and between non-continuous contacts)	
<b>Dielectric strength</b>	2,000 VAC, 50/60 Hz for 1 min (between current-carrying terminal and exposed non-current-carrying metal parts) 1,000 VAC, 50/60 Hz for 1 min (between non-continuous contacts)	1,000 VAC, 50/60 Hz for 1 min (between current-carrying terminal and exposed non-current-carrying metal parts, and between non-continuous contacts)
<b>Impulse withstand voltage</b>	3.0 kV (between power terminals) 4.5 kV (between current-carrying terminal and exposed non-current-carrying metal parts)	1.0 kV (between power terminals) 1.5 kV (between current-carrying terminal and exposed non-current-carrying metal parts)
<b>Noise immunity</b>	$\pm 1.5$ kV (between power terminals) $\pm 600$ V (between input terminals), square-wave noise by noise simulator (pulse width: 100 ns/1 $\mu$ s, 1-ns rise)	$\pm 480$ kV (between power terminals) $\pm 600$ V (between input terminals), square-wave noise by noise simulator (pulse width: 100 ns/1 $\mu$ s, 1-ns rise)
<b>Static immunity</b>	Destruction: 15 kV Malfunction: 8 kV	
<b>Vibration resistance</b>	Destruction: 10 to 55 Hz, 0.75-mm single amplitude each in three directions Malfunction: 10 to 55 Hz, 0.5-mm single amplitude each in three directions	
<b>Shock resistance</b>	Destruction: 294 m/s <sup>2</sup> (30G) each in three directions Malfunction: 98 m/s <sup>2</sup> (10G) each in three directions	
<b>Ambient temperature</b>	Operating: -10 to 55 °C (-10 to 50 °C if timers are mounted side by side) (with no icing) Storage: -25 to 65 °C (with no icing)	
<b>Ambient humidity</b>	Operating: 35% to 85%	
<b>Life expectancy</b>	Mechanical: 10,000,000 operations min. Electrical: 100,000 operations min. (3 A at 250 VAC, resistive load)	
<b>EMC</b>	(EMI): EN50081-2 Emission Enclosure: EN55011 Group 1 class A Emission AC Mains: EN55011 Group 1 class A (EMS): EN50082-2 Immunity ESD: EN61000-4-2: 4 kV contact discharge (level 2) 8 kV air discharge (level 3) Immunity RF-interference: ENV50140: 10 V/m (80 MHz to 1 GHz) (level 3) Immunity Conducted Disturbance: ENV50141: 10 V (0.15 to 80 MHz) (level 3) Immunity Burst: EN61000-4-4: 2 kV power-line (level 3) 2 kV I/O signal-line (level 4)	
<b>Case color</b>	Light gray (Munsell 5Y7/1)	
<b>Weight</b>	Approx. 130 g	Approx. 110 g

**Note:** 1. The values are based on the set value.  
2. The value is applied for a minimum pulse width of 1 ms.

# Nomenclature

## Indicator

1. **Present Value**  
Red LEDs with a character height of 12 mm  
**Note:** The decimal point will flash on the present value during the timing operation in the following ranges:  
0.1 to 999.9 min, 0 h 01 min to 99 h 59 min, and 0.1 to 999.9 h.
2. **Preset Value**  
Green LEDs with a character height of 8 mm
3. **Reset Indicator** (orange)
4. **Key Protection Indicator** (orange)
5. **Time Unit Display** (orange)
6. **Control Output Indicator** (orange)

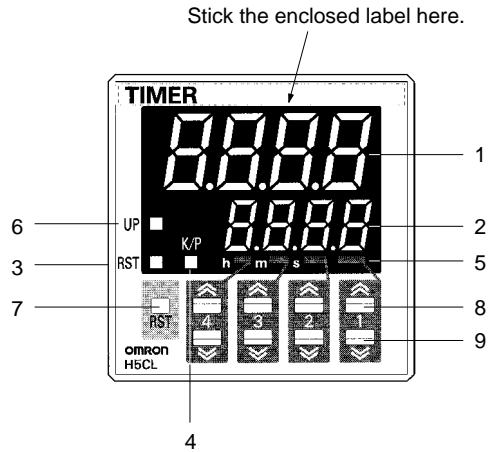

## Operation Key

7. **Reset (RST) Key**  
The RST Key initializes the present value and control output.
8. **Increment Keys (1 to 4)**  
Up Keys 1 to 4 increment the preset value.
9. **Decrement Keys (1 to 4)**  
Down Keys 1 to 4 decrement the preset value.

# Operation

## ■ DIP Switch Setting

Pin no.	Item	OFF	ON
1, 2, 3	Time ranges	See table below.	
4	Display modes	Up (Increment)	Down (Decrement)
5	Min. pulse width of inputs	20 ms	1 ms
6	Operating modes	A (signal ON-delay)	F (accumulative operation)

**Note:** Set the DIP switch before installation and operation of the Unit. DIP switch setting changes are not effective while the power is on.

## Time Ranges

1	2	3	Time range
ON	ON	ON	0.001 to 9.999 s
OFF	OFF	OFF	0.01 to 99.99 s
ON	OFF	OFF	0.1 to 999.9 s
OFF	ON	OFF	1 to 9999 s
ON	ON	OFF	0 min 01 s to 99 min 59 s
OFF	OFF	ON	0.1 to 999.9 min
ON	OFF	ON	0 h 01 min to 99 h 59 min
OFF	ON	ON	0.1 to 999.9 h

**Note:** Switches 1 to 6 are all set to OFF before shipping.

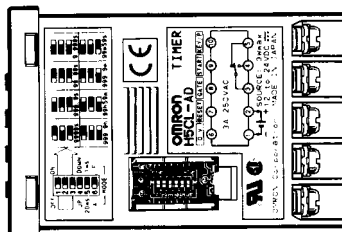

(The same switch settings apply to AC and DC models)

## Timer Control with Power Start

When using the H5CL with power start, short-circuit the start input and input 0-V terminals.

■ Operating Modes

**A Mode**  
Signal ON-delay

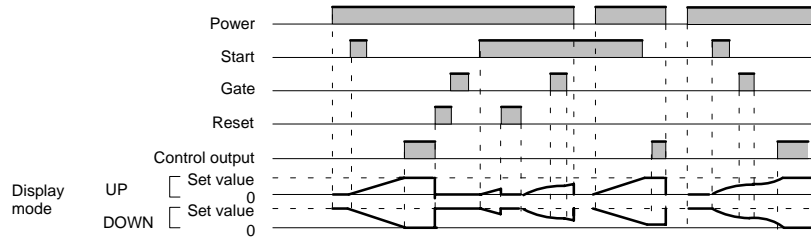

**F Mode**  
Accumulative Operation

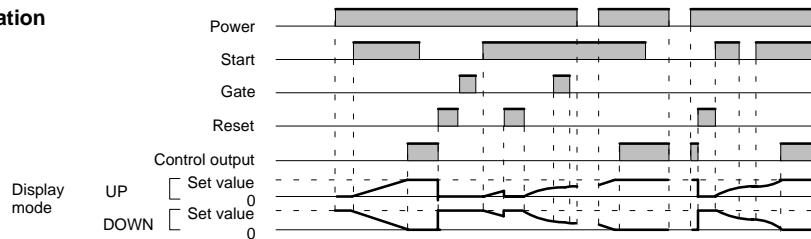

Dimensions

Note: All units are in millimeters unless otherwise indicated.

**H5CL-A**

DIN Track/Surface/Flush Mounting

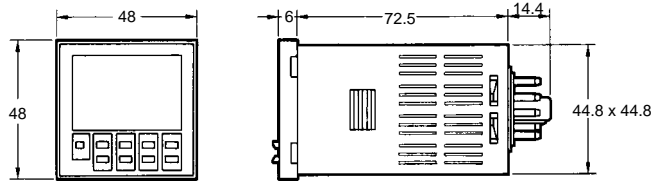
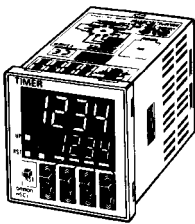

**H5CL-AD**

Flush Mounting

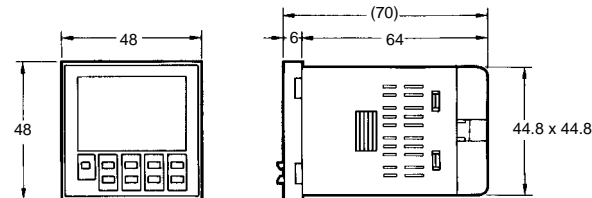
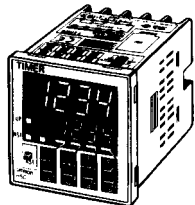

**H5CL-A□**

With Flush Mounting Adapter

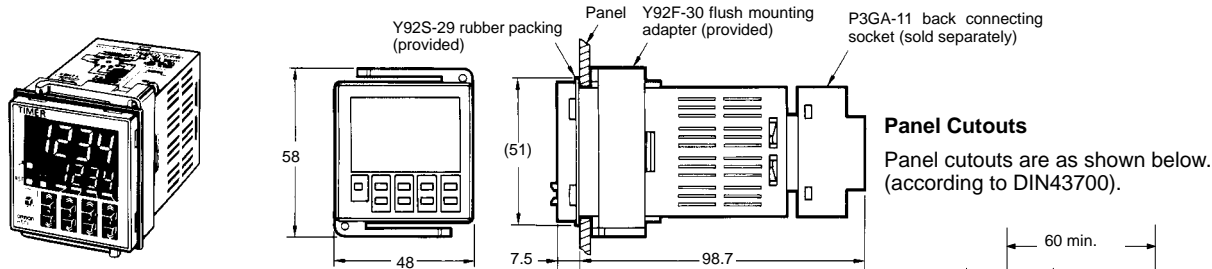

**H5CL-AD□**

With Flush Mounting Adapter

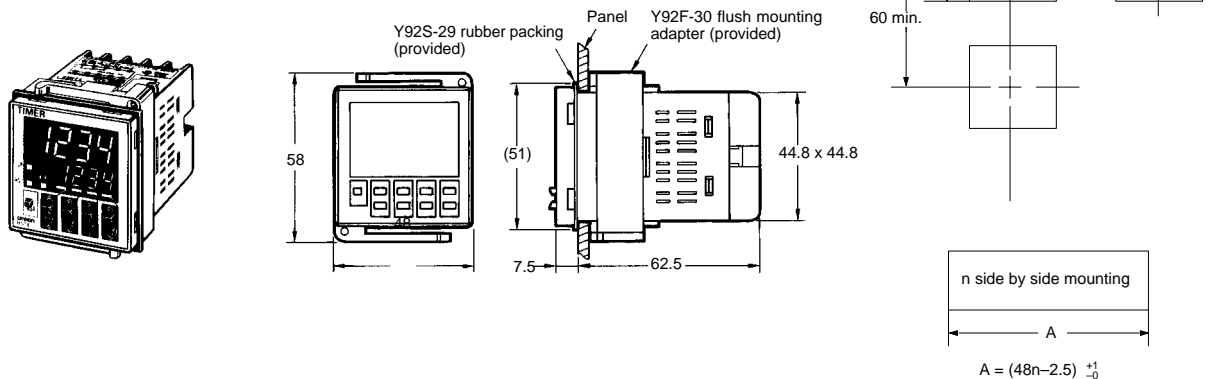

- Note:**
1. The mounting panel thickness should be 1 to 4 mm.
  2. It is possible to mount timers side by side, but only in one direction.
  3. When the Timers are mounted closely side by side, the Timers will not be water-resistive.

**DIN Track Mounting**

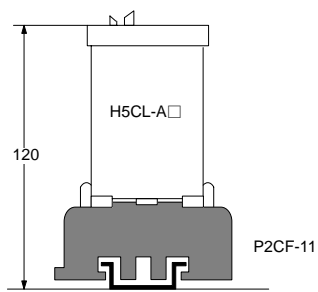

**H5CL-AD□-500**

The cover conforms to finger protection standard against electric shock. (VDE 0106/P100)

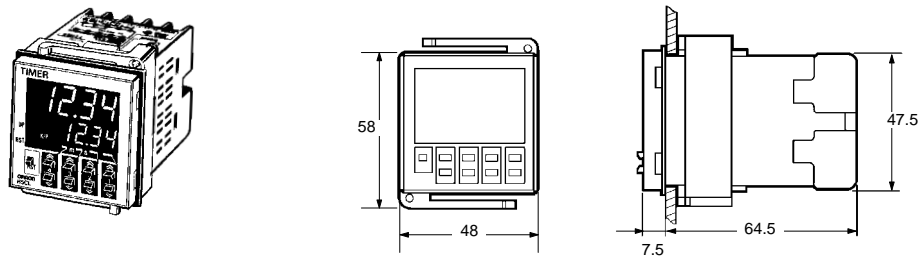

■ Accessories (Order Separately)

**Track Mounting/  
Front Connecting Socket  
P2CF-11**

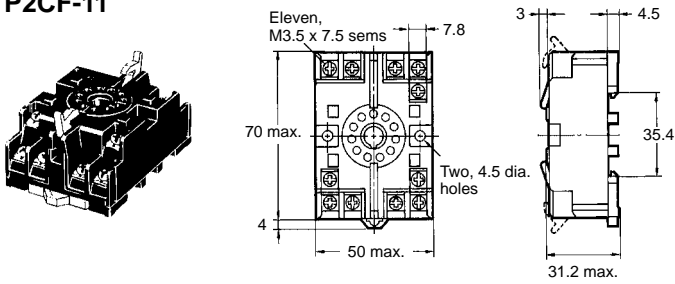

**Terminal Arrangement/  
Internal Connections  
(Top View)**

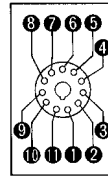

**Surface Mounting Holes**

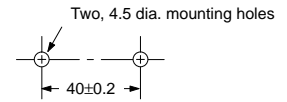

**P2CF-11-E (Finger Safe Terminal Type)  
Conforming to VDE0106/P100**

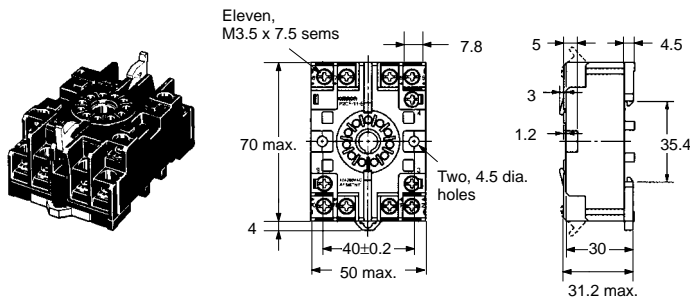

**Back Connecting Socket  
P3GA-11**

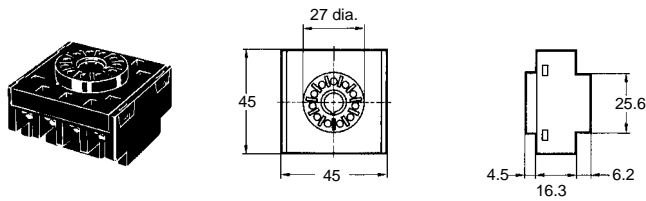

**Terminal Arrangement/  
Internal Connections  
(Bottom View)**

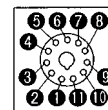

**Finger Safe Terminal Cover**

Conforming to VDE0106/P100

**Y92A-48G**

(Attachment for P3GA-11 Socket)

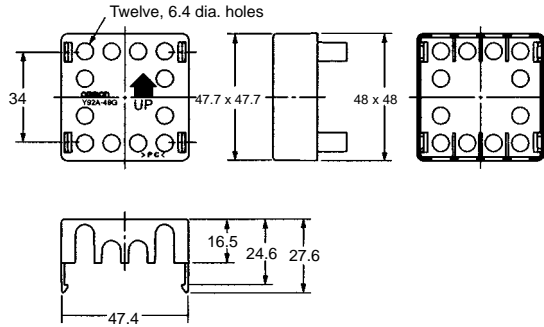
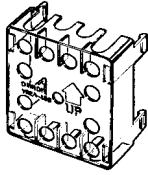

**Y92A-48T**

(Attachment for H5CL DC models)

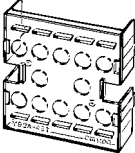

**Hard Cover**

**Y92A-48**

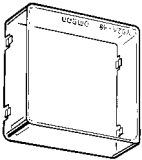

**Soft Cover**

**Y92A-48F1**

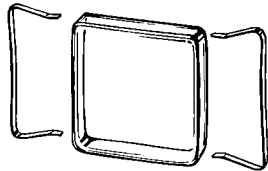

**Installation**

■ **Terminal Arrangement**

**AC Models**

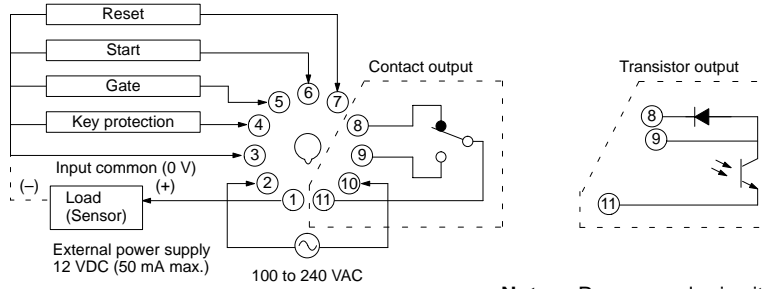

**Note:** Power supply circuit is insulated from the internal circuit (or I/O).

**DC Models**

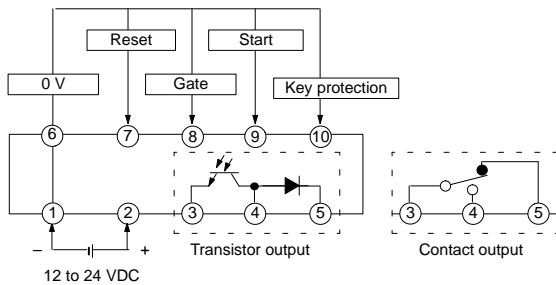

**Note:** 1 and 6 are connected to each other internally.



## Input Circuits

### Start, Reset, and Gate Input

H5CL-A□ (AC Models)

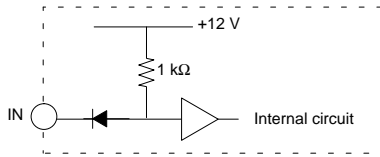

H5CL-AD□ (DC Models)

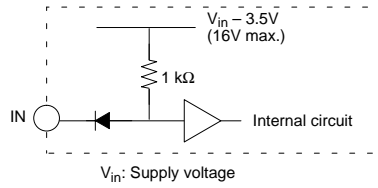

### Key Protection Input

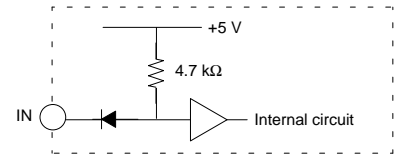

**Note:** No key input is effective while key protection input is ON.

## Input Connections

### Open Collector Output

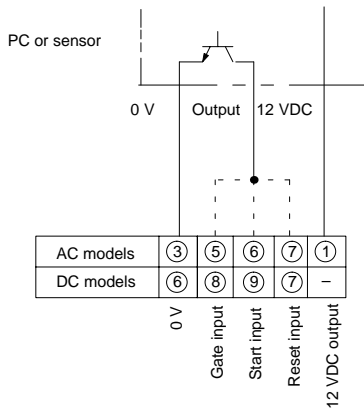

### Voltage Output

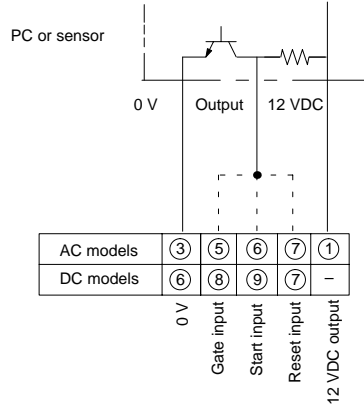

### Contact input

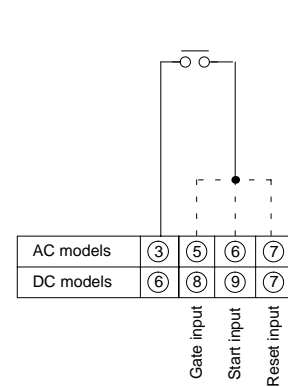

### Start, Reset, and Gate Input Specification

ON impedance: 500 Ω max. (the leakage current is 5 to 20 mA when the impedance is 0 Ω.)  
 ON residual voltage: 2 V max.  
 OFF impedance: 100 kΩ min.  
 Maximum applicable voltage: 30 VDC max.

### Two-wire Sensor

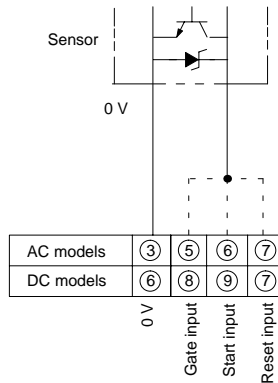

### Applicable Two-wire Sensor

Leakage current: 1.5 mA max.  
 Switching capacity: 5 mA min.  
 Residual voltage: 3 V max.  
 Operating voltage: 10 VDC

**Note:** When connecting a two-wire sensor to a DC models, supply 24 VDC (21.6 to 26.4 VDC) to the timer.

### Key Protection Input

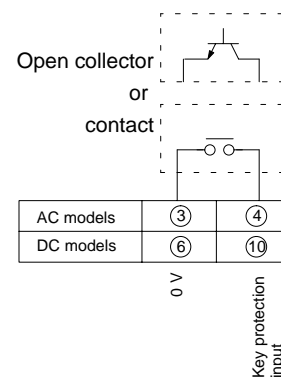

### Key Protection Input

ON impedance: 1 kΩ max.  
 (the leakage current is approx. 1 mA when the impedance is 0 Ω.)  
 ON residual voltage: 0.5 V max.  
 OFF impedance: 100 kΩ min.  
 Maximum applicable voltage: 30 VDC max.

**Note:** The used contact should switch 1 mA at 5 V.

# Precautions

## Power Supplies

When turning the power ON and OFF, input signal reception is possible, unstable, or impossible as shown in the diagram below.

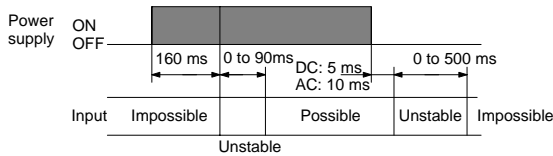

Apply the power supply voltage through a relay or switch in such a way that the voltage reaches a fixed value immediately.

Turn the power ON and OFF with relay with a rated capacity of 10 A minimum to prevent contact deterioration due to inrush current caused by turning the power ON and OFF.

## Timer Control with Power Start

The timer cannot take measurements until 160 to 250 ms have elapsed after the power is turned ON (refer to the above chart). The control output will be delayed for any set value less than 250 ms.

When the H5CL is used with power start in F mode (i.e., accumulative operation with output on hold), there will be a timer error (approximately 100 ms each time the H5CL is turned on) due to the characteristics of the internal circuitry.

Use the H5CL with signal start if timer accuracy is required.

## Transistor Output

The transistor output of the H5CL is insulated from the internal circuitry by a photocoupler, so the transistor output can be used as both NPN and PNP output.

The diode connected to the collector of the output transistor is used to absorb inverted voltage that is generated when an inductive load is connected to the H5CL.

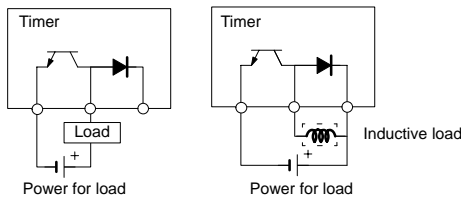

## Self-diagnostic Function

The following displays will appear if an error occurs.

Display	Error	Output status	Correction	Set value after correction
E1	CPU	OFF	Press RST Key or turn power off and then ON	No change
E2	Memory (see note)			0

**Note:** This includes times when the life of the EEPROM has expired.

## Operating Environment

When using the Timer in an area with excess electronic noise, separate the Timer, wiring, and the equipment which generates the input signals as far as possible from the noise sources. It is also recommended to shield the input signal wiring to prevent electronic interference.

Organic solvents (such as paint thinner), as well as very acidic or basic solutions can damage the outer casing of the Timer.

## Preset Value Change

When changing the preset value during a timing operation, output will turn ON if the preset value is changed as follows, since the constant read-in system is in use:

Display mode UP: Present value  $\geq$  preset value  
 Display mode DOWN: Elapse time  $\geq$  preset value (Present value = 0)

**Note:** When in down mode, the changed amount of preset value is added to or subtracted from the present value.

## Reset with a Preset Value of 0

The output will go ON when the start signal is input. The output will be OFF while the reset key is pressed or the reset input is ON.

## Power Failure Backup

All data is stored in the EEPROM when there is power failure. The EEPROM can be overwritten more than 200,000 times.

Operating mode	Overwriting timing
A mode	When the H5CL is turned off after changing the set value.
F mode	When the H5CL is turned off after changing the set value, turning the start input, or the reset input ON.

## Flush Mounting

The H5CL's panel surface is water-resistive (conforming to NEMA 4 (indoors) and IP66). In order to prevent the internal circuit from water penetration through the space between the timer and operating panel, attach a rubber packing (provided with the H5CL) between the timer and operating panel and secure the rubber packing with the Y92F-30 flush-mounting adapter.

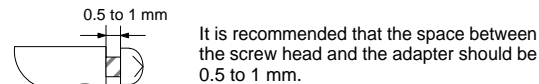

It is recommended that the space between the screw head and the adapter should be 0.5 to 1 mm.

## Other

In case of performing a dielectric strength test, etc., on the H5CL mounted to a control panel, disconnect the H5CL from the connecting circuit, or short-circuit all the terminals of the H5CL. Otherwise the H5CL may be damaged.

Terminal 1 (power supply terminal) and terminal 6 (input common: 0 V for input) of DC model H5CL are internally connected to each other.

## DIP Switch Selection

DIP switch setting while the H5CL is turned on will not be valid until the H5CL is turned off and on.



**ALL DIMENSIONS SHOWN ARE IN MILLIMETERS.**

To convert millimeters into inches, multiply by 0.03937. To convert grams into ounces, multiply by 0.03527.

Cat. No. L085-E1-3 **In the interest of product improvement, specifications are subject to change without notice.**

## **OMRON Corporation**

Industrial Automation Company

Measuring and Supervisory Controls Division  
28th Fl., Crystal Tower Bldg.,  
1-2-27, Shiromi, Chuo-ku,  
Osaka 540-6028 Japan  
Tel: (81)6-6949-6035 Fax: (81)6-6949-6069

Printed in Japan  
1099-0.1M (0696)