

Flexible Safety Unit G9SX

Logical AND Function Adds Flexibility to I/O Expansion



- Facilitates partial or complete control system setup.
- Solid-state outputs (excluding Expansion Units).
- Detailed LED indications enable easy diagnosis.
- TÜV Product Service certification for compliance with IEC/EN61508 (SIL3) and EN954-1 (Cat. 4).
- Approved by UL and CSA.
- New unit joins the Series with the following two additional features:
 - OFF-delay time of up to 150 seconds (The OFF-delay output also complies with Cat. 4.)
 - Two logical AND connection inputs

NEW



Note: Refer to *Precautions* on pages 17 and 18.

Features

● Productivity

“Partial stop” and “Complete stop” enhance productivity without sacrificing safety.

● Maintenance

LED indicators and detachable terminals for better maintenance.

● Expandability

“Logical connection” enables easier modification and expansion of machines.

Ex) Machining Center

- When the Emergency Stop Switch is pressed, the entire machine will stop.
- When a door is open, the corresponding part will not activate.

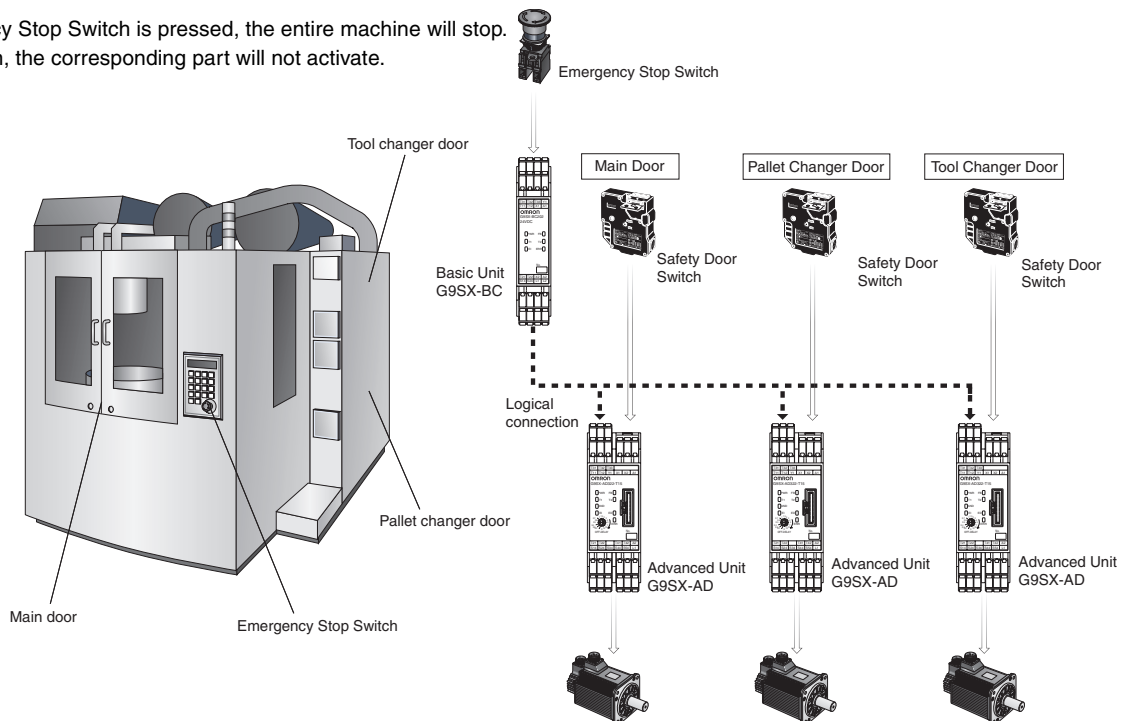

Model Number Structure

Model Number Legend

G9SX-□□□□□□-□□□□-□□
 1 2 3 4 5 6

1. Functions

- AD/ADA: Advanced Unit
- BC: Basic Unit
- EX: Expansion Unit

2. Output Configuration (Instantaneous Safety Outputs)

- 0: None
- 2: 2 outputs
- 3: 3 outputs
- 4: 4 outputs

3. Output Configuration (OFF-delayed Safety Outputs)

- 0: None
- 2: 2 outputs
- 4: 4 outputs

4. Output Configuration (Auxiliary Outputs)

- 1: 1 output
- 2: 2 outputs

5. Max. OFF-delay Time

- Advanced Unit
 - T15: 15 s
 - T150: 150 s
- Basic Unit
 - No indicator: No OFF delay
- Expansion Unit
 - No indicator: No OFF delay
 - T: OFF delay





6. Terminal Block Type

- RT: Screw terminals
- RC: Spring-cage terminals

Ordering Information

List of Models

Advanced Unit

| Safety outputs (solid state) (See note 3.) | | Auxiliary outputs (solid state) (See note 4.) | Logical AND connection | | No. of input channels | Max. OFF-delay time (See note 1.) | Rated voltage | Terminal block type | Model |
|--|---------------------------|---|------------------------|-----------------------|-----------------------|---|---------------|-----------------------|--|
| Instantaneous | OFF-delayed (See note 2.) | | Inputs | Outputs | | | | | |
| 3 | 2 | 2 | 1 | 1 | 1 or 2 channels | 15 s | 24 VDC | Screw terminals | G9SX-AD322-T15-RT |
| | | | | | | | | Spring-cage terminals | G9SX-AD322-T15-RC |
| | | | 150 s | Screw terminals | | G9SX-AD322-T150-RT | | | |
| | | | | Spring-cage terminals | | G9SX-AD322-T150-RC | | | |
| 2 | | | 2 | 2 | | 15 s | | Screw terminals | G9SX-ADA222-T15-RT  |
| | | | | | | | | Spring-cage terminals | G9SX-ADA222-T15-RC  |
| | | | 150 s | Screw terminals | | G9SX-ADA222-T150-RT  | | | |
| | | | | Spring-cage terminals | | G9SX-ADA222-T150-RC  | | | |

- Note: 1.** The OFF-delay time can be set in 16 steps as follows:
 T15: 0/0.2/0.3/0.4/0.5/0.6/0.7/1/1.5/2/3/4/5/7/10/15 s
 T150: 0/10/20/30/40/50/60/70/80/90/100/110/120/130/140/150 s
- 2.** The OFF-delayed output becomes an instantaneous output by setting the OFF-delay time to 0 s.
- 3.** P channel MOS FET transistor output
- 4.** PNP transistor output

Basic Unit

| Safety outputs (solid state) (See note 1.) | | Auxiliary outputs (solid state) (See note 2.) | Logical AND connection | | No. of input channels | Rated voltage | Terminal block type | Model |
|--|-------------|---|------------------------|---------|-----------------------|---------------|--|--------------------------------|
| Instantaneous | OFF-delayed | | Inputs | Outputs | | | | |
| 2 | --- | 2 | 0 | 2 | 1 or 2 channels | 24 VDC | Screw terminals Spring-cage terminals | G9SX-BC202-RT G9SX-BC202-RC |

Note: 1. P channel MOS FET transistor output
 2. PNP transistor output

Expansion Unit

| Safety outputs (contact) | | Auxiliary outputs (solid state) (See note 1.) | OFF-delay time | Rated voltage | Terminal block type | Model |
|--------------------------|-------------|---|----------------|---------------|-----------------------|-----------------|
| Instantaneous | OFF-delayed | | | | | |
| 4 PST-NO | --- | 1 | --- | 24 VDC | Screw terminals | G9SX-EX401-RT |
| | | | (See note 2.) | | Spring-cage terminals | G9SX-EX401-RC |
| --- | 4 PST-NO | | | | Screw terminals | G9SX-EX041-T-RT |
| | | | | | Spring-cage terminals | G9SX-EX041-T-RC |

Note: 1. PNP transistor output
 2. The OFF-delay time is synchronized to the OFF-delay time setting in the connected Advanced Unit (G9SX-AD-□/G9SX-ADA-□).

Specifications

■ Ratings

Power input

| Item | G9SX-AD322-□/ADA222-□ | G9SX-BC202-□ | G9SX-EX-□ |
|-------------------------------------|-------------------------------------|--------------|-----------|
| Rated supply voltage | 24 VDC | | |
| Operating voltage range | -15% to 10% of rated supply voltage | | |
| Rated power consumption (See note.) | 4 W max. | 3 W max. | 2 W max. |

Note: Power consumption of loads not included.

Inputs

| Item | G9SX-AD322-□/ADA222-□ | G9SX-BC202-□ |
|----------------------|---|--------------|
| Safety input | Operating voltage: 20.4 VDC to 26.4 VDC, internal impedance: approx. 2.8 kΩ | |
| Feedback/reset input | | |

Outputs

| Item | G9SX-AD322-□/ADA222-□ | G9SX-BC202-□ |
|---|---|--|
| Instantaneous safety output | P channel MOS FET transistor output | P channel MOS FET transistor output |
| OFF-delayed safety output (See note 1.) | Load current: Using 2 outputs or less: 1 A DC max. (See note 2.) Using 3 outputs or more: 0.8 A DC max. | Load current: Using 1 output: 1 A DC max. (See note 2.) Using 2 outputs: 0.8 A DC max. |
| Auxiliary output | PNP transistor output Load current: 100 mA max. | |

Note: 1. While safety outputs are in the ON state, the following signal sequence is output continuously for diagnosis. When using the safety outputs as input signals to control devices (i.e. Programmable Controllers), consider the OFF pulse shown below.

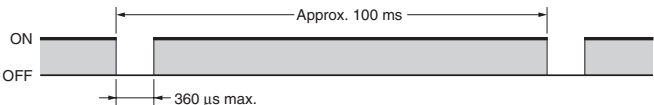

2. The following derating is required when Units are mounted side-by-side.
 G9SX-AD322-□/G9SX-ADA222-□/G9SX-BC202-□: 0.4 A max. load current

Expansion Unit

| Item | G9SX-EX-□ |
|---------------------------|---|
| Rated load | 250 VAC, 3A/30 VDC, 3A (resistive load) |
| Rated carry current | 3 A |
| Maximum switching voltage | 250 VAC, 125 VDC |

■ Characteristics

| Item | | G9SX-AD322-□/ADA222-□ | G9SX-BC202-□ | G9SX-EX-□ |
|--|--|--|-------------------------------|--|
| Over-voltage category (IEC/EN 60664-1) | | II | | II (Safety relay outputs 13 to 43 and 14 to 44: III) |
| Operating time (OFF to ON state) (See note 1.) | | 50 ms max. (Safety input: ON) (See note 2.) 100 ms max. (Logical AND connection input: ON) (See note 3.) | 50 ms max. (Safety input: ON) | 30 ms max. (See note 4.) |
| Response time (ON to OFF state) (See note 1.) | | 15 ms max. | | 10 ms max. (See note 4.) |
| ON-state residual voltage | | 3.0 V max. (safety output, auxiliary output) | | |
| OFF-state leakage current | | 0.1 mA max. (safety output, auxiliary output) | | |
| Maximum wiring length of safety input and logic AND input | | 100 m max. (External connection impedance: 100 Ω max. and 10 nF max.) | | |
| Reset input time (Reset button pressing time) | | 100 ms min. | | |
| Accuracy of OFF-delay time (See note 5.) | | Within ± 5% of the set value | --- | Within ± 5% of the set value |
| Insulation resistance | Between logical AND connection terminals, and power supply input terminals and other input and output terminals connected together | 20 MΩ min. (by 100 VDC megger) | --- | --- |
| | Between all terminals connected together and DIN rail | | 20 MΩ min. (at 100 VDC) | 100 MΩ min. (at 500 VDC) |
| Dielectric strength | Between logical AND connection terminals, and power supply input terminals and other input and output terminals connected together | 500 VAC for 1 min | --- | --- |
| | Between all terminals connected together and DIN rail | | 500 VAC for 1 min | 1,200 VAC for 1 min |
| | Between different poles of outputs | --- | --- | 2,200 VAC for 1 min |
| | Between safety relay outputs connected together and other terminals connected together | --- | --- | |
| Vibration resistance | | Frequency: 10 to 55 to 10 Hz, 0.375-mm single amplitude (0.75-mm double amplitude) | | |
| Mechanical shock resistance | Destruction | 300 m/s ² | | |
| | Malfunction | 100 m/s ² | | |
| Durability | Electrical | --- | | 100,000 cycles min. (rated load, switching frequency: 1,800 cycles/hour) |
| | Mechanical | --- | | 5,000,000 cycles min. (switching frequency: 7,200 cycles/hour) |
| Ambient temperature | | -10 to 55°C (no icing or condensation) | | |
| Ambient humidity | | 25% to 85% | | |
| Terminal tightening torque (See note 6.) | | 0.5 N·m | | |
| Weight | | Approx. 200 g | Approx. 125 g | Approx. 165 g |

Note: 1. When two or more Units are connected by logical AND, the operating time and response time are the sum total of the operating times and response times, respectively, of all the Units connected by logical AND.

2. Represents the operating time when the safety input turns ON with all other conditions set.
3. Represents the operating time when the logical AND input turns ON with all other conditions set.
4. This does not include the operating time or response time of Advanced Units that are connected.
5. This does not include the operating time or response time of internal relays in the G9SX-EX-□.
6. For the G9SX-□-RT (with screw terminals) only.

Logical AND Connection

| Item | G9SX-AD322-□/ADA222-□ | G9SX-BC202-□ | G9SX-EX-□ |
|--|-----------------------|--------------|-----------|
| Number of Units connected per logical AND output | 4 Units max. | --- | --- |
| Total number of Units connected by logical AND (See note 2.) | 20 Units max. | --- | --- |
| Number of Units connected in series by logical AND | 5 Units max. | --- | --- |
| Max. number of Expansion Units connected (See note 3.) | --- | --- | 5 Units |
| Maximum cable length for logical AND input | 100 m | --- | --- |

Note: 1. See Logical AND Connection Combinations below for details.

- The number of G9SX-EX401-□ Expansion Units or G9SX-EX041-T-□ Expansion Units (OFF-delayed Model) not included.
- G9SX-EX401-□ Expansion Units and G9SX-EX041-T-□ Expansion Units (OFF-delayed Model) can be mixed.

Logical AND Connection Combinations

- One logical AND connection output from an Advanced Unit G9SX-AD can be logical AND connected to up to four Advanced Units.

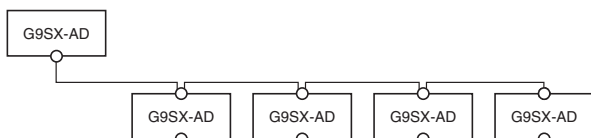

- Two logical AND outputs from a Basic Unit G9SX-BC can be logical AND connected to up to eight Advanced Units.

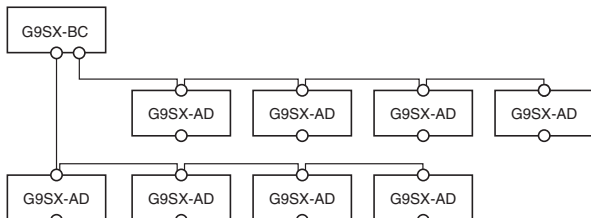

- Two logical AND outputs from an Advanced Unit G9SX-ADA can be logical AND connected to up to eight Advanced Units.

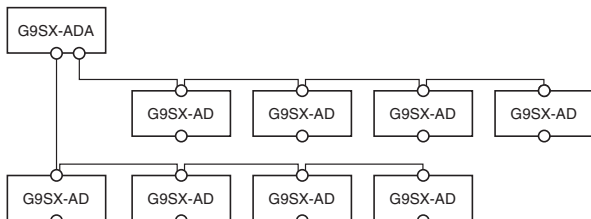

- Any Advanced Unit with logical AND input can be logical AND connected to Advanced Units on up to five tiers.

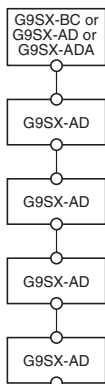

- Two logical AND connection outputs, each from different Advanced/Basic Units, can be logical AND connected to a single G9SX-ADA Unit.

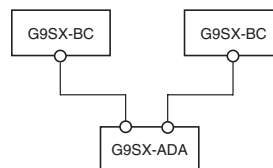



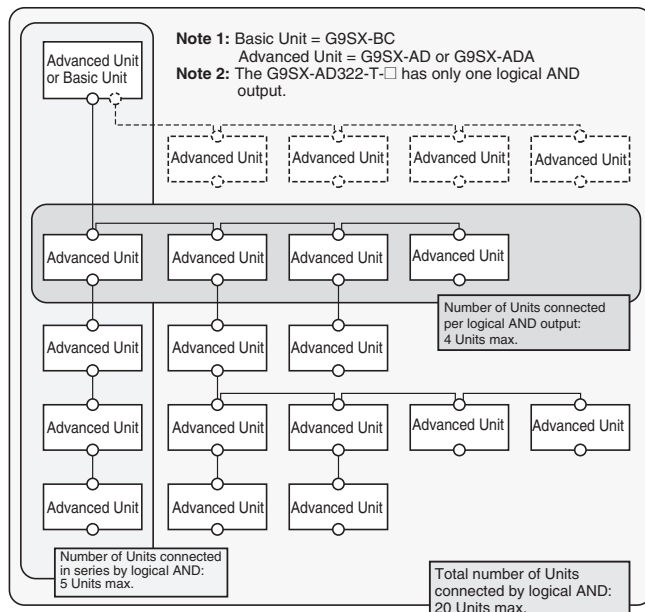

- The largest possible system configuration contains a total of 20 Advanced and Basic Units. In this configuration, each Advanced Unit can have up to five Expansion Units.

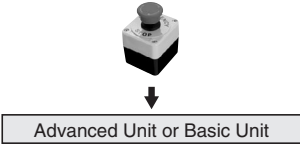

Response Time and Operating Time

The following table shows the response time for two or more Units that are logical AND connected.

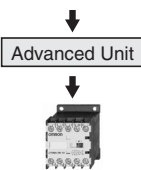
| Item | Block flow diagram | Max. response time (not including Expansion Units) (See note 1.) | Max. response time (including Expansion Units) (See note 2.) | Max. operating time (not including Expansion Units) (See note 3.) | Max. operating time (including Expansion Units) (See note 4.) |
|--------------------|---|--|--|---|---|
| Tier | | | | | |
| First tier |  | 15 ms | 25 ms | 50 ms | 80 ms |
| Second tier |  | 30 ms | 40 ms | 150 ms | 180 ms |
| Third tier |  | 45 ms | 55 ms | 250 ms | 280 ms |
| Fourth tier |  | 60 ms | 70 ms | 350 ms | 380 ms |
| Fifth tier |  | 75 ms | 85 ms | 450 ms | 480 ms |

- Note:**
1. The maximum response time (not including Expansion Units) in this block flow diagram is the time it takes the output from the Unit on the lowest tier to switch from ON to OFF after the input to the Unit on the highest tier switches from ON to OFF.
 2. The maximum response time (including Expansion Units) in this block flow diagram is the time it takes the output from the Expansion Unit connected to the Unit on the lowest tier to switch from ON to OFF after the input to the Unit on the highest tier switches from ON to OFF.
 3. The maximum operating time (not including Expansion Units) in this block flow diagram is the time it takes the output from the Unit on the lowest tier to switch from OFF to ON after the input to the Unit on the highest tier switches from OFF to ON.
 4. The maximum operating time (including Expansion Units) in this block flow diagram is the time it takes the output from the Expansion Unit connected to the Unit on the lowest tier to switch from OFF to ON after the input to the Unit on the highest tier switches from OFF to ON.

Connections

Internal Connection

G9SX-AD322-□ (Advanced Unit)

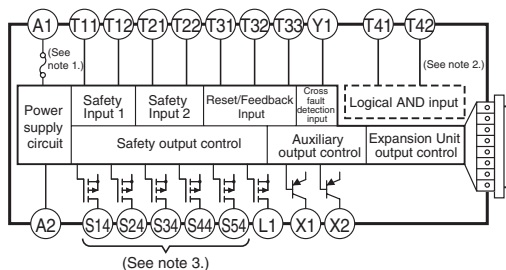

- Note:**
1. Internal power supply circuit is not isolated.
 2. Logical AND input is isolated.
 3. Outputs S14 to S54 are internally redundant.

G9SX-ADA222-□ (Advanced Unit)

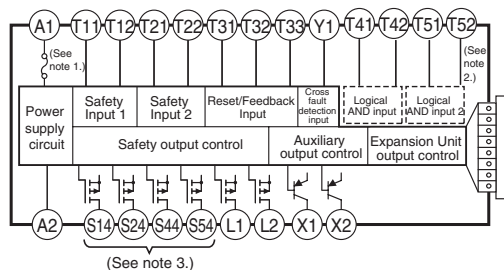

- Note:**
1. Internal power supply circuit is not isolated.
 2. Logical AND inputs are isolated.
 3. Outputs S14 to S54 are internally redundant.

G9SX-BC202-□ (Basic Unit)

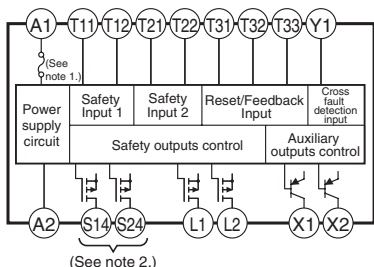

- Note:**
1. Internal power supply circuit is not isolated.
 2. Outputs S14 and S24 are internally redundant.

G9SX-EX401-□/ G9SX-EX041-T-□ (Expansion Unit / Expansion Unit OFF-delayed model)

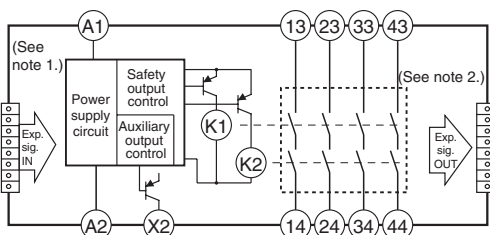

- Note:**
1. Internal power supply circuit is not isolated.
 2. Relay outputs are isolated.

Dimensions

Note: All units are in millimeters unless otherwise indicated.

Advanced Unit

G9SX-AD322-□

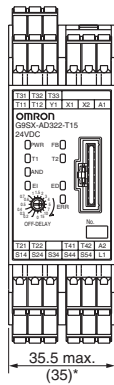
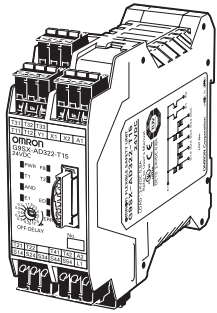

* Typical dimension

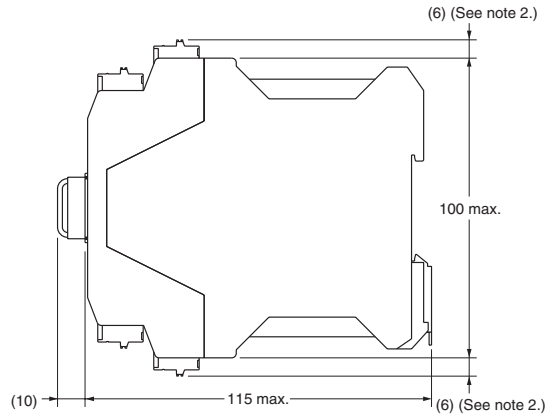

Note: 1. Above outline drawing is for -RC terminal type.
2. For -RC terminal type only.

Terminal arrangement

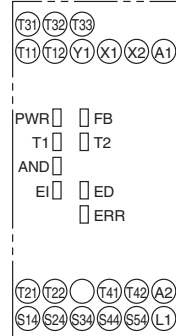

G9SX-ADA222-□

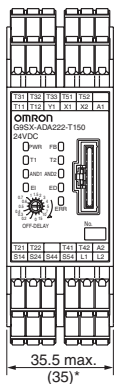
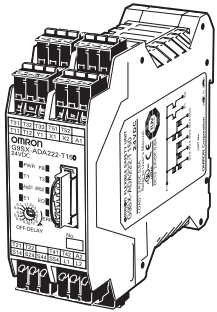

* Typical dimension

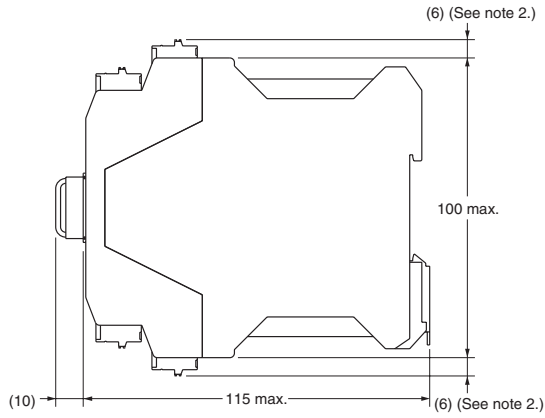

Note: 1. Above outline drawing is for -RC terminal type.
2. For -RC terminal type only.

Terminal arrangement

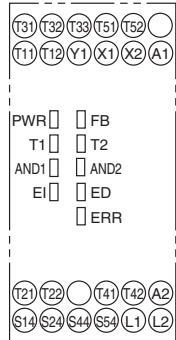

Basic Unit

G9SX-BC202-□

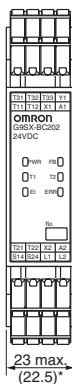
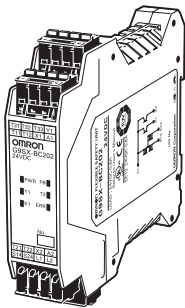

* Typical dimension

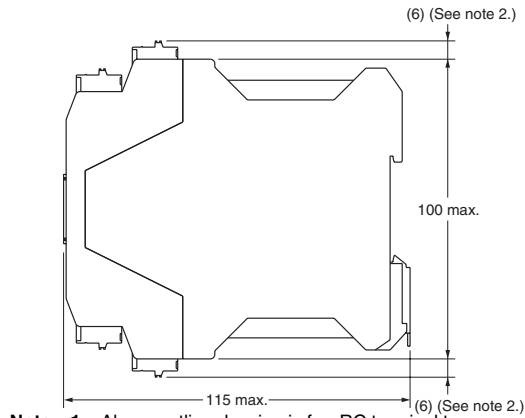

Note: 1. Above outline drawing is for -RC terminal type.
2. For -RC terminal type only.

Terminal arrangement

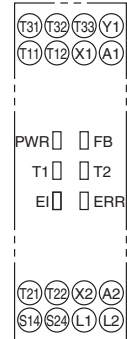

Expansion Unit

G9SX-EX401-□

Expansion Unit (OFF-delayed Model)

G9SX-EX041-T-□

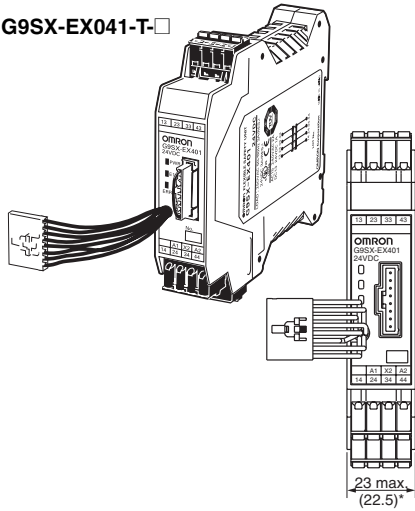

* Typical dimension

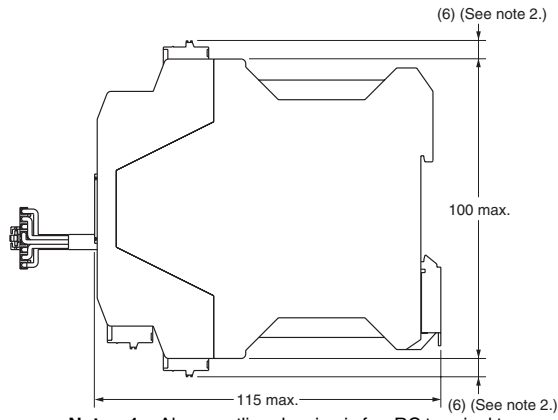

Note: 1. Above outline drawing is for -RC terminal type.
2. For -RC terminal type only.

Terminal arrangement

G9SX-EX401-□
(Expansion Unit)

G9SX-EX041-T-□
(Expansion Unit
with OFF Delay)

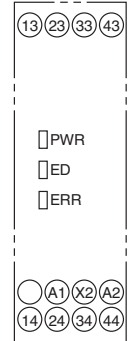
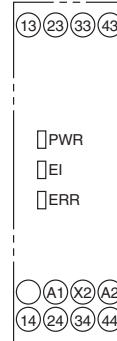

■ Wiring of Inputs and Outputs

| Signal name | Terminal name | Description of operation | Wiring |
|------------------------------|--------------------|--|--|
| Power supply input | A1, A2 | The input terminals for power supply. Connect the power source to the A1 and A2 terminals. | Connect the power supply plus (24 VDC) to the A1 terminal. Connect the power supply minus (GND) to the A2 terminal. |
| Safety input 1 | T11, T12 | To set the safety outputs in the ON state, the HIGH state signals must be input to both safety input 1 and safety input 2. Otherwise the safety outputs cannot be in the ON state. | Corresponds to Safety Category 2 |
| Safety input 2 | T21, T22 | | Corresponds to Safety Category 3 |
| Safety input 2 | T21, T22 | | Corresponds to Safety Category 4 |
| Feedback/reset input | T31, T32, T33 | To set the safety outputs in the ON state, the ON state signal must be input to T33. Otherwise the safety outputs cannot be in the ON state. | Auto reset |
| | | To set the safety outputs in the ON state, the signal input to T32 must change from the OFF state to the ON state, and then to the OFF state. Otherwise the safety outputs cannot be in the ON state. | Manual reset |
| Logical AND connection input | T41, T42, T51, T52 | A logical AND connection means that one unit (Unit A) outputs a safety signal "a" to a subsequent unit (Unit B) and Unit B calculates the logical multiplication (AND) (i.e., outputs the AND) of the signal "a" and safety signal "b", which is input to Unit B. Thereby the logic of the safety output of Unit B is "a" AND "b". (An AND of inputs "a" and "b" is output.) To set the safety outputs of the subsequent Unit in the ON state, its logical AND connection preset switch must be set to AND (enable) and the HIGH state signal must be input to T41 of the subsequent unit. | |
| Cross fault detection input | Y1 | Selects the mode for the failure detecting (cross fault detecting) function for the safety inputs of G9SX corresponding to the connection of the cross fault detection input. | Keep Y1 open when using T11, T21. (Wiring corresponding to category 4) Connect Y1 to 24 VDC when not using T11, T21. (Wiring corresponding to category 2 or 3, or when connecting safety sensors) |
| Instantaneous safety output | S14, S24, S34 | Turns ON/OFF according to the state of the safety inputs, feedback/reset inputs, and logical AND connection inputs. During OFF-delay state, the Instantaneous safety outputs are not able to turn ON. | Keep these outputs open when not used. |
| OFF-delayed safety output | S44, S54 | OFF-delayed safety outputs. The OFF-delay time is set by the OFF-delay preset switch. When the delay time is set to zero, these outputs can be used as non-delay outputs. | Keep these outputs open when not used. |
| Logical connection output | L1, L2 | Outputs a signal of the same logic as the instantaneous safety outputs. | Keep these outputs open when not used. |
| Auxiliary monitor output | X1 | Outputs a signal of the same logic as the instantaneous safety outputs | Keep these outputs open when not used. |
| Auxiliary error output | X2 | Outputs when the error indicator is lit or blinking. | Keep these outputs open when not used. |

■ Connecting Safety Sensors and the G9SX

- When connecting safety sensors to the G9SX, the Y1 terminal must be connected to 24 VDC. The G9SX will detect a connection error, if the Y1 terminal is open.
- In many cases, safety sensor outputs include an OFF-shot pulse for self diagnosis. The following condition of test pulse is applicable as safety inputs for the G9SX.
 - OFF-shot pulse width of the sensor, during the ON-state: 340 μ s max.

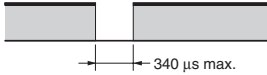

Operation

■ Functions

Logical AND Connection

● Example with G9SX-AD322-□

The logical AND connection means that the Basic Unit (or Advanced Unit) outputs a safety signal "a" to an Advanced Unit, and the Advanced Unit calculates the logical multiplication (AND) of the safety signal "a" and safety signal "b." The safety output of an Advanced Unit with the logical AND connection shown in the following diagram is "a" AND "b".

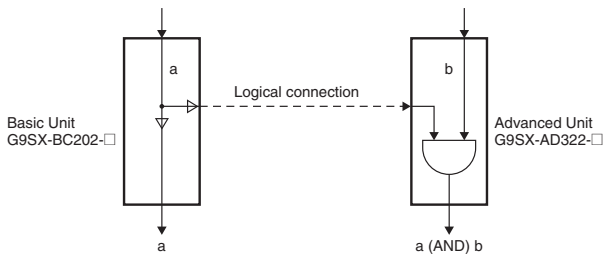

This is illustrated using the application in the following diagram as an example. The equipment here has two hazards identified as Robot 1 and Robot 2, and it is equipped with a safety door switch and an emergency stop button. You may have overall control where both Robot 1 and Robot 2 are stopped every time the emergency stop button is pressed. You may also have partial control where only Robot 1, which is closest to the door, is stopped when the door is opened. In that case, Robot 2 will continue to operate.

The actual situation using a G9SX for this application is shown in this example.

(Note: The logical AND setting on the Advanced Unit must be set to AND (enabled).)

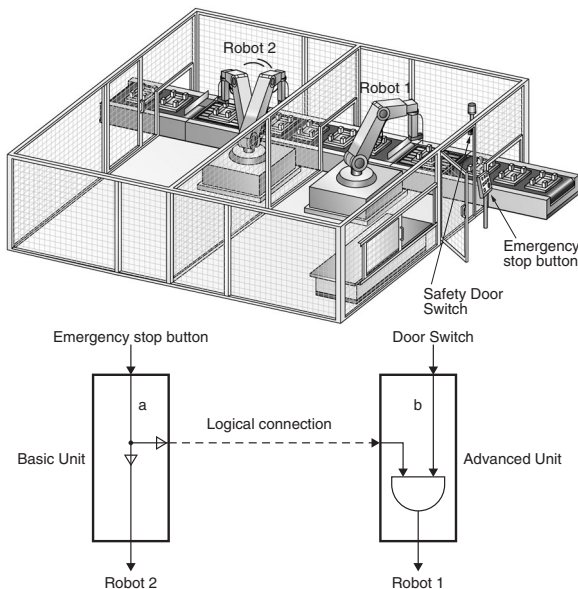

● Example with G9SX-ADA222-□ ^{NEW}

The Advanced Unit G9SX-ADA222-□ is equipped with two logical AND connection inputs. Therefore, it is capable of receiving two safety signals, each from different Advanced or Basic Units. As shown in the diagram below, the output of Advanced Unit G9SX-ADA222-□ will be "a" AND "b" AND "c".

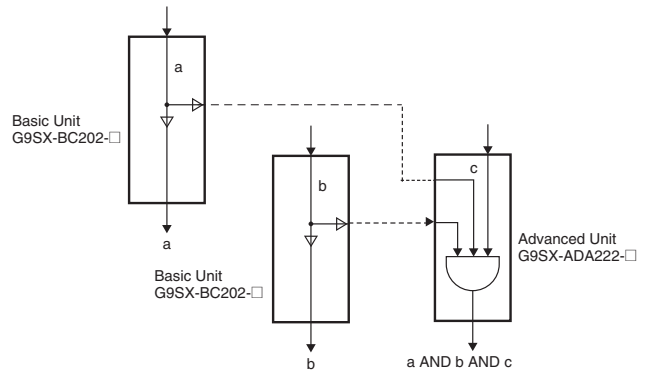

Connecting Expansion Units

- The G9SX-EX and G9SX-EX-T Expansion Units can be connected to an Advanced Unit (G9SX-AD322-□/G9SX-ADA222-□) to increase the number of safety outputs. (They cannot be connected to a Basic Unit.)
- A maximum of five Expansion Units can be connected to one Advanced Unit. This may be a combination of G9SX-EX Instantaneous types and G9SX-EX-T OFF-delayed types.
- Remove the terminating connector from the receptacle on the Advanced Unit and insert the Expansion Unit cable connector into the receptacle. Insert the terminating connector into the receptacle on the Expansion Unit at the very end (rightmost).
- When Expansion Units are connected to an Advanced Unit, make sure that power is supplied to every Expansion Unit. (Refer to the following diagram for actual Expansion Unit connection.)

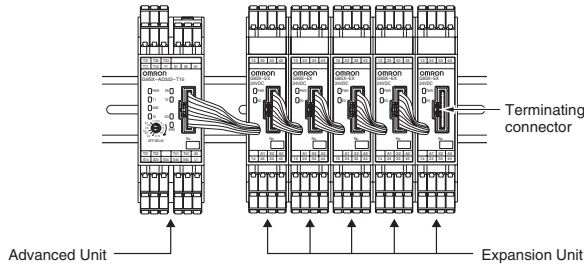

Setting Procedure

1. Cross Fault Detection (Advanced Unit/Basic Unit)

Set the cross fault detection mode for safety inputs by shorting Y1 to 24 V or leaving it open. When cross fault detection is set to ON, short-circuit failures are detected between safety inputs T11-T12 and T21-22. When a cross fault is detected, the following will occur.

1. The safety outputs and logical AND outputs lock out.
2. The LED error indicator is lit.
3. The error output (auxiliary output) turns ON.

| Cross fault detection | | Wiring |
|-----------------------|----------------------------------|--------|
| OFF | Corresponds to Safety Category 2 | |
| | Corresponds to Safety Category 3 | |
| ON | Corresponds to Safety Category 4 | |

2. Reset Mode (Advanced Unit/Basic Unit)

Set the reset mode using feedback/reset input terminals T31, T32, and T33. Auto reset mode is selected when terminal T32 is shorted to 24 V and manual reset mode is selected when terminal T33 is shorted to 24 V.

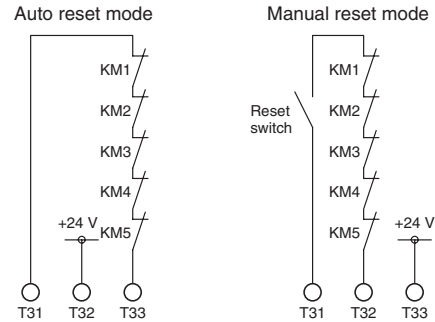

3. Setting Logical AND Connection (Advanced Unit)

When connecting two or more Advanced Units (or Basic Units) by logical AND connection, set the logical AND connection preset switch on the Advanced Unit that is on the input side (Advanced Unit G9SX-AD322 in the following diagram) to AND.

(1) Using G9SX-AD322 on the Input Side

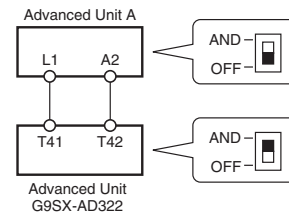

- Note:**
1. A setting error will occur and Advanced Unit G9SX-AD322 will lock out if the logical AND setting switch on the Unit is set to OFF.
 2. Set the logical AND setting switch on Advanced Unit A to OFF or an error will occur.
 3. A logical AND input cannot be sent to a Basic Unit.

(2) Using G9SX-ADA222 on the Input Side

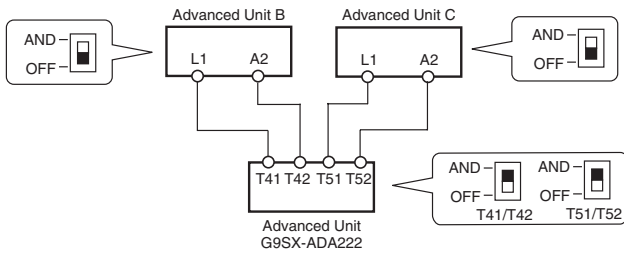

- Note:**
1. When not connecting Advanced Unit B, leave terminals T41 and T42 of the G9SX-ADA222 Advanced Unit open, and set the logical AND setting switch T41/T42 to OFF.
 2. When not connecting Advanced Unit C, leave terminals T51 and T52 of the G9SX-ADA222 Advanced Unit open, and set the logical AND setting switch T51/T52 to OFF.

The following table shows the relationship between the logical ON setting switches and the conditions for safety outputs turning ON.

| Logical ON setting switch | | Conditions for safety outputs turning ON | | |
|---------------------------|---------|--|---------------|---------------|
| T41/T42 | T51/T52 | Safety input | Logic input 1 | Logic input 2 |
| OFF | OFF | ON | OFF | OFF |
| AND | OFF | ON | ON | OFF |
| OFF | AND | ON | OFF | ON |
| AND | AND | ON | ON | ON |

4. Setting the OFF-delay Time (Advanced Unit)

The OFF-delay preset time on an Advanced Unit is set from the OFF-delay time preset switch (1 each on the front and back of the Unit). Normal operation will only occur if both switches are identically set. An error will occur if the switches are not identically set.

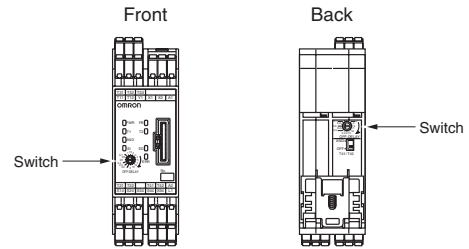

Refer to the following illustration for details on setting switch positions.

G9SX-AD322-T15/G9SX-ADA222-T15

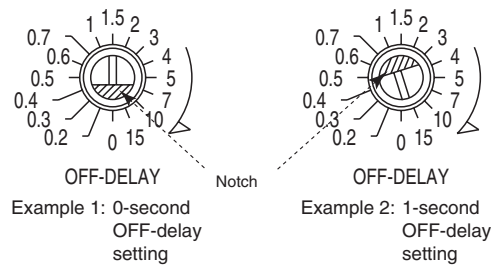

G9SX-AD222-T150/G9SX-ADA222-T150 *NEW*

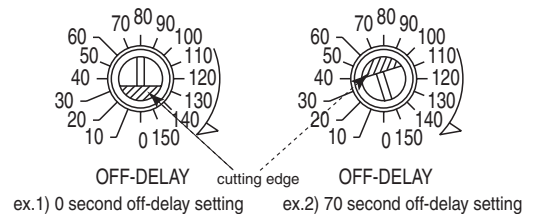

LED Indicators

| Marking | Color | Name | G9SX-AD | G9SX-ADA | G9SX-BC | G9SX-EX | G9SX-EX-T | Function | Reference |
|---------|--------|-------------------------------------|---------|----------|---------|---------|-----------|---|-------------|
| PWR | Green | Power supply indicator | ○ | ○ | ○ | ○ | ○ | Lights up while power is supplied. | --- |
| T1 | Orange | Safety input #1 indicator | ○ | ○ | ○ | --- | --- | Lights up while a HIGH state signal is input to T12. Blinks when an error relating to safety input #1 occurs. | (See note.) |
| T2 | Orange | Safety input #2 indicator | ○ | ○ | ○ | --- | --- | Lights up while a HIGH state signal is input to T22. Blinks when an error relating to safety input #2 occurs. | |
| FB | Orange | Feedback/reset input indicator | ○ | ○ | ○ | --- | --- | Lights up in the following cases: With automatic reset while a HIGH state signal is input to T33. With manual reset while a HIGH state signal is input to T32. Blinks when an error relating to feedback/reset input occurs. | |
| AND | Orange | Logical AND input indicator | ○ | --- | --- | --- | --- | Lights up while a HIGH state signal is input to T41. Blinks when an error relating to logical AND connection input occurs. | |
| AND1 | Orange | Logical AND input indicator | --- | ○ | --- | --- | --- | Lights up while a HIGH state signal is input to T41. Blinks when an error relating to logical AND connection input occurs. | |
| AND2 | Orange | Logical AND input indicator | --- | ○ | --- | --- | --- | Lights up while a HIGH state signal is input to T51. Blinks when an error relating to logical AND connection input occurs. | |
| EI | Orange | Safety output indicator | ○ | ○ | ○ | ○ | --- | Lights up while the Instantaneous safety outputs (S14, S24, S34) are in the ON-state. Blinks when an error relating to the instantaneous safety output occurs. | |
| ED | Orange | OFF-delayed safety output indicator | ○ | ○ | --- | --- | ○ | Lights up while OFF-delayed safety outputs (S44, S54) are in the ON-state. Blinks when an error relating to OFF-delayed safety output occurs. | |
| ERR | Red | Error indicator | ○ | ○ | ○ | ○ | ○ | Lights up or blinks when an error occurs. | |

Note: Refer to *Fault Detection* on the next page for details.

Settings Indication (at Power ON)

Settings for the G9SX can be checked by the orange indicators for approx. 3 seconds after the power is turned ON. During this settings indication period, the ERR indicator will light, however the auxiliary error output will remain OFF









| Indicator | Item | Setting position | Indicator status | Setting mode | Setting status |
|------------------|-----------------------------------|--------------------------------------|------------------|---------------------------|----------------|
| T1 | Cross fault detection mode | Y1 terminal | Lit | Detection mode | Y1 = open |
| | | | Not lit | Non-detection mode | Y1 = 24 VDC |
| FB | Reset mode | T32 or T33 terminal | Lit | Manual reset mode | T33 = 24 VDC |
| | | | Not lit | Auto reset mode | T32 = 24 VDC |
| AND (AND1, AND2) | Logical AND connection input mode | Logical AND connection preset switch | Lit | Enable logical AND input | "AND" |
| | | | Not lit | Disable logical AND input | "OFF" |

Fault Detection

When the G9SX detects a fault, the ERR indicator and/or other indicators light up or blink to inform the user about the fault.

Check and take necessary measures referring to the following table, and then re-supply power to the G9SX.

(Advanced Unit/Basic Unit)

| ERR indicator | Other indicator | Fault | Expected causes of the fault | Check points and measures to take | |
|---|---|--|--|--|---|
|  Blinks | --- | Fault due to electro-magnetic disturbance or of internal circuits. | <ol style="list-style-type: none"> Excessive electro-magnetic disturbance Failure of the internal circuit | <ol style="list-style-type: none"> Check the disturbance level around the G9SX and the related system. Replace with a new product. | |
|  Lights up |  T1 blinks | Fault involved with safety input 1 | <ol style="list-style-type: none"> Failure involving the wiring of safety input 1 Incorrect setting of cross fault detection input Failure of the circuit of safety input 1 | <ol style="list-style-type: none"> Check the wiring to T11 and T12. Check the wiring to Y1. Replace with a new product. | |
| |  T2 blinks | Fault involved with safety input 2 | <ol style="list-style-type: none"> Failure involving the wiring of safety input 2 Incorrect setting of cross fault detection input Failure of circuits of safety input 2 | <ol style="list-style-type: none"> Check the wiring to T21 and T22. Check the wiring to Y1. Replace with a new product. | |
| |  FB blinks | | Faults involved with feedback/reset input | <ol style="list-style-type: none"> Failures involving the wiring of feedback/reset input. Failures of the circuit of feedback/reset input | <ol style="list-style-type: none"> Check the wiring to T31, T32 and T33. Replace with a new product. |
| | | | Fault in Expansion Unit | <ol style="list-style-type: none"> Improper feedback signals from Expansion Unit Abnormal supply voltage to Expansion Unit Failure of the circuit of safety relay contact outputs | <ol style="list-style-type: none"> Check the connecting cable of Expansion Unit and the connection of the termination socket. Check the supply voltage to Expansion Unit. Note: Make sure that all Expansion units' PWR indicators are lit. Replace the Expansion Unit with a new one. |
| |  EI blinks | | Fault involved with instantaneous safety outputs or logical connection outputs or auxiliary monitor output | <ol style="list-style-type: none"> Failure involving the wiring of instantaneous safety outputs Failure of the circuit of Instantaneous safety outputs Failure involving the wiring of the logical connection output Failure of the circuit of the logical connection output Failure involving the wiring of the auxiliary monitor output Impermissible high ambient temperature | <ol style="list-style-type: none"> Check the wiring to S14, S24, and S34. Replace with a new product. Check the wiring to L1 and L2. Replace with a new product. Check the wiring to X1. Check the ambient temperature and spacing around the G9SX. |
| |  ED blinks | | Fault involved with OFF-delayed safety outputs | <ol style="list-style-type: none"> Failure involving the wiring of OFF-delayed safety relay contact outputs Incorrect set values for OFF-delay time Failure of the circuit of OFF-delayed safety relay contact outputs Impermissible high ambient temperature | <ol style="list-style-type: none"> Check the wiring to S44 and S54. Confirm the set values of the two OFF-delay time preset switches. Replace with a new product. Check the ambient temperature and spacing around the G9SX. |
| |  AND blinks (AND1, AND2) | | Fault involved with logical AND connection input | <ol style="list-style-type: none"> Failure involving the wiring of the logical AND connection input Incorrect setting for the logical AND connection input Failure of the circuit of the logical AND connection input | <ol style="list-style-type: none"> Check the wiring to T41 and T42 (T51 and T52). Note: Make sure that the wiring length for the T41, T42, T51, T52 terminal is less than 100 meters. Note: Make sure that the logical AND connection signal is branched for less than 4 units. Confirm the set value of the logical AND connection preset switch. Replace with a new product. |
| |  All indicators except PWR blink | | Supply voltage outside the rated value | <ol style="list-style-type: none"> Supply voltage outside the rated value | <ol style="list-style-type: none"> Check the supply voltage to Expansion Units. |

When indicators other than the ERR indicator blink, check and take necessary actions referring to the following table.

| ERR indicator | Other indicators | Fault | Expected cause of the fault | Check points and measures to take |
|---------------|------------------|---------------------------------------|---|--|
| ○ Off | T1 | Mismatch between input 1 and input 2. | The input status between input 1 and input 2 is different, due to contact failure or a short circuit of safety input device(s) or a wiring fault. | Check the wiring from safety input devices to the G9SX. Or check the input sequence of safety input devices. After removing the fault, turn both safety inputs to the OFF state. |
| | T2 | | | |

(Expansion Unit)

| ERR indicator | Other indicators | Fault | Expected cause of the faults | Check points and measures to take |
|---------------|------------------|---|--|-----------------------------------|
| ● Light up | --- | Fault involved with safety relay outputs of Expansion Units | 1) Welding of relay contacts 2) Failure of the internal circuit | Replace with a new product. |

Precautions

⚠ WARNING

Serious injury may possibly occur due to breakdown of safety outputs.

Do not connect loads beyond the rated value to the safety outputs.



Serious injury may possibly occur due to loss of required safety functions.

Wire G9SX properly so that supply voltages or voltages for loads do NOT touch the safety inputs accidentally or unintentionally.



Serious injury may possibly occur due to damages of safety inputs.

Apply protection circuitry against back electromotive force in case connecting inductive loads to safety outputs.



Serious injury may possibly occur due to loss of safety functions. Use devices appropriate for the application and the condition where G9SX is used.



| Control Devices | Requirements |
|--|--|
| Emergency stop switch | Use approved devices with Direct Opening Mechanism complying with IEC/EN 60947-5-1 |
| Door interlocking switch Limit switch | Use approved devices with Direct Opening Mechanism complying with IEC/EN 60947-5-1 and capable of switching micro loads of 24VDC, 5mA. |
| Safety Sensor | Use approved devices complying with the relevant product standards, regulations and rules in the country where it is used. Consult a certification body to assess that the entire system satisfies the required safety category level. |
| Relay with forcibly guided contacts | Use approved devices with forcibly guided contacts complying with EN 50205. For feedback purpose use devices with contacts capable of switching micro loads of 24VDC, 5mA. |
| Contactors | Use contactors with forcibly guided mechanism to input the signal to Feedback/Reset input of G9SX through the NC contact of the contactor. For feedback purpose use devices with contacts capable of switching micro loads of 24VDC, 5mA. Failure to open contacts of a contactor cannot be detected by monitoring its auxiliary NC contact without forcibly guided mechanism. |
| Other devices | Evaluate whether devices used are appropriate to satisfy the requirements of safety category level. |

■ Precautions for Safe Use

- Use G9SX within an enclosure with IP54 protection or higher of IEC/EN60529.
- Incorrect wiring may lead to loss of safety function. Wire conductors correctly and verify the operation of G9SX before commissioning the system in which G9SX is incorporated.
- Do not apply DC voltages exceeding the rated voltages, or any AC voltages to the G9SX power supply input.
- Use DC supply satisfying requirements below to prevent electric shock.
 - DC power supply with double or reinforced insulation, for example, according to IEC/EN60950 or EN50178 or a transformer according to IEC/EN61558.
 - DC supply satisfies the requirement for class 2 circuits or limited voltage/current circuit stated in UL 508.
- Apply properly specified voltages to G9SX inputs. Applying inappropriate voltages cause G9SX to fail to perform its specified function, which leads to the loss of safety functions or damages to G9SX
- Auxiliary error outputs and auxiliary monitoring outputs are NOT safety outputs. Do not use auxiliary outputs as any safety output. Such incorrect use causes loss of safety function of G9SX and its relevant system.
Also Logical connection outputs can only be used for logical connections between G9SXs.
- After installation of G9SX, qualified personnel should confirm the installation, and should conduct test operations and maintenance. The qualified personnel should be qualified and authorized to secure the safety on each phases of design, installation, running, maintenance and disposal of system.
- A person in charge, who is familiar to the machine in which G9SX is to be installed, should conduct and verify the installation.
- Turn OFF the signal to Safety input or Logical AND connection input every 24hours and make sure G9SX operates without faults by checking the state of the ERR indicator.
- Do not dismantle, repair, or modify G9SX. It may lead to loss of its safety functions.
- Use only appropriate components or devices complying with relevant safety standards corresponding to the required level of safety categories.
Conformity to requirements of safety category is determined as an entire system.
It is recommended to consult a certification body regarding assessment of conformity to the required safety level.
- OMRON shall not be responsible for conformity with any safety standards regarding to customer's entire system.
- Disconnect G9SX from power supply when wiring, to prevent electric shock or unexpected operation.
- Be cautious not to have your fingers caught when attaching terminal sockets to the plugs on G9SX.
- The lifetime of G9SX depends on the conditions of switching of its outputs. Be sure to conduct its test operation under actual operating conditions in advance and use it within appropriate switching cycles
- Do not use in combustible gases or explosive gases. Arcs or heat generated by switching elements of G9SX can lead to fire or explosion.

■ Precautions for Correct Use

1. Handle with care
Do not drop G9SX to the ground or expose to excessive vibration or mechanical shocks. G9SX may be damaged and may not function properly.
2. Conditions of storage
Do not store in such conditions stated below.
 - a. In direct sunlight
 - b. At ambient temperatures out of the range of -10 to 55°C.
 - c. At relative humidity out of the range of 25% to 85% or under such temperature change that causes condensation.
 - d. In corrosive or combustible gases
 - e. With vibration or mechanical shocks out of the rated values.
 - f. Under splashing of water, oil, chemicals
 - g. In the atmosphere containing dust, saline or metal powder.
 G9SX may be damaged and may not function properly.
3. Mounting
Mount G9SX to DIN rails with attachments (TYPE PFP-M, not incorporated to this product), not to drop out of rails by vibration etc. especially when the length of DIN railing is short compared to the widths of G9SX.
4. Following spacing around G9SX should be available to apply rated current to outputs of G9SX and for enough ventilation and wiring:
 - a. At least 25 mm beside side faces of the Advanced Unit (G9SX-AD322-□-□/G9SX-ADA222-□-□) and side faces of the Basic Unit (G9SX-BC202-□).
 - b. At least 50 mm above top face of G9SX and below bottom face of G9SX.

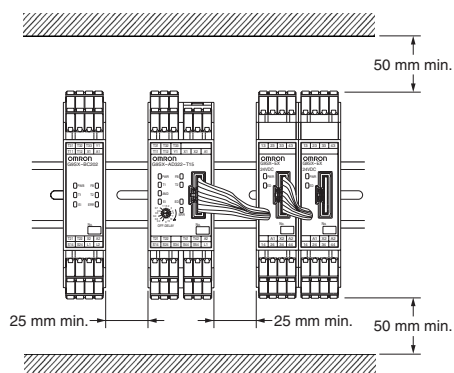

5. Wiring

- a. For model G9SX-□-RT (with screw terminals)
 - Use the following to wire to G9SX-□-RT.

| | |
|--------------------------------------|--|
| Solid wire | 0.2 to 2.5mm ² AWG24 to AWG12 |
| Stranded wire (Flexible wire) | 0.2 to 2.5mm ² AWG24 to AWG12 |

- Tighten each screw with a specified torque of 0.5 to 0.6Nm, or the G9SX may malfunction or generate heat.
- Strip the cover of wire no longer than 7mm.

- b. For model G9SX-□-RC (with spring-cage terminals)

- Use the following to wire to G9SX-□-RC

| | |
|----------------------|---|
| Solid wire | 0.2 to 2.5mm ² AWG24 to AWG12 |
| Stranded wire | 0.34 to 1.5mm ² AWG22 to AWG16 |

- It is recommended that stranded wire should be terminated with insulation-covered bar terminal (DIN 46228-4 standard compatible type) at its ends before using for connection.

6. When connecting Expansion Units (G9SX-EX□-□) to Advanced Unit (G9SX-AD322-□-□/G9SX-ADA222-□-□):
 - a. Follow the procedure below:
 - Remove the termination connector from the receptacle on Advanced Unit,
 - Insert the head of the connecting cable of Expansion Unit to the receptacle on the Advanced Unit
 - Set the termination connector to the receptacle on the Expansion Unit at the end position. When Advanced Unit is used without expansion units, leave the termination connector set on the Advanced Unit.
 - b. Do not remove the termination connector or the connecting cable of the Expansion Unit while the system is operating.
 - c. Before applying supply voltage, confirm that the connecting sockets and plugs are locked firmly.
 - d. All of the Expansion Units should be supplied with its specified voltages within 10s after the connected Advanced Unit is supplied with voltage. Otherwise, Advanced Unit detects the power-supply error for the Expansion Units.
7. Use cables with length less than 100m to connect to Safety Inputs, Feed-back/Reset inputs, or between Logical AND connection inputs and Logical connection outputs, respectively.
8. Set the time duration of OFF-delay to an appropriate value that does not cause the loss of safety function of system.
9. Logical connection between Units:
 - a. When using Logical AND connection inputs, set the Logical connection preset switch to 'AND' position for the units which the logical connection signal are input to.
 - b. Connect Logical connection outputs appropriately to Logical AND connection inputs of the relevant unit. Verify the operation of G9SX before commissioning the system.
 - c. When configuring the safety related system, be sure to consider that the delay of response time caused by logical connections do not degrade the safety function of the system.
10. To determine safety distance to hazards, take into account the delay of Safety outputs caused by the following time:
 - a. Response time of Safety inputs
 - b. Response time of Logical AND connection input (See also "Ratings and specifications, note 5.")
 - c. Preset off-delay time
 - d. Accuracy of off-delay time
11. Start entire system after more than 5s have passed since applying supply voltage to all G9SXs in the system.
12. G9SX may malfunction due to electro-magnetic disturbances. Be sure to connect the terminal A2 to ground. To suppress electrical noise, apply a surge absorber to the coil of inductive load.
13. Devices connected to G9SX may operate unexpectedly. When replacing G9SX, disconnect it from power supply.
14. Adhesion of solvent such as alcohol, thinner, trichloroethane or gasoline on the product should be avoided. Such solvents make the marking on G9SX illegible and cause deterioration of parts.
15. Do NOT mix AC load and DC load to be switched in one G9SX-EX□-□. When switching of both AC load and DC load is necessary, connect more than two G9SX-EX□-□ and use each unit for AC load and DC load exclusively.

Category of EN 954-1

In the condition shown in *Application Examples*, G9SX can be used for the corresponding categories up to category 4.

This does NOT mean that G9SX can always be used for required category under all the similar conditions and situations.

Conformity to the categories must be assessed as a whole system. When using G9SX for safety categories, be sure to confirm the conformity as a whole system.

1. Input the signals to both of the Safety inputs (T11-T12 and T21-T22).
2. Input a signal to the Safety inputs (T11-T12 and T21-T22) through switches with Direct Opening Mechanism.
When using limit switches, at least one of them must have Direct Opening Mechanism.
3. When connecting Safety sensor with G9SX, use TYPE 4 safety sensor.
4. Input the signal through a NC contact of the contactor to Feedback/Reset input (T31-T32 for manual reset or T31-T33 for auto reset).(Refer to *Application Examples*)
5. Keep Cross fault detection mode input (Y1) open. However, when connecting devices with self-diagnosis function, such as safety sensors, apply 24VDC to Y1.
6. Be sure to Connect A2 to ground.
7. When using a G9SX-EX-□-□ Expansion Unit, connect fuses with a current rating of 3.15 A max. to the safety relay outputs to prevent the contacts from welding.

Compliance with International Standards

G9SX-AD-□/G9SX-ADA-□/G9SX-BC-□/G9SX-EX-□

- Approved by TÜV Product Service
EN50178
IEC/EN60204-1
EN954-1 Cat.4
IEC/EN61508 SIL3
IEC/EN61000-6-2
IEC/EN61000-6-4
- Approved by UL
UL508
UL1998
NFPA79
IEC61508
- Approved by CSA
CAN/CSA C22.2 No.142

Application Examples

G9SX-AD322-T15 (24 VDC) (1-channel Emergency Stop Switch Input / Manual Reset)

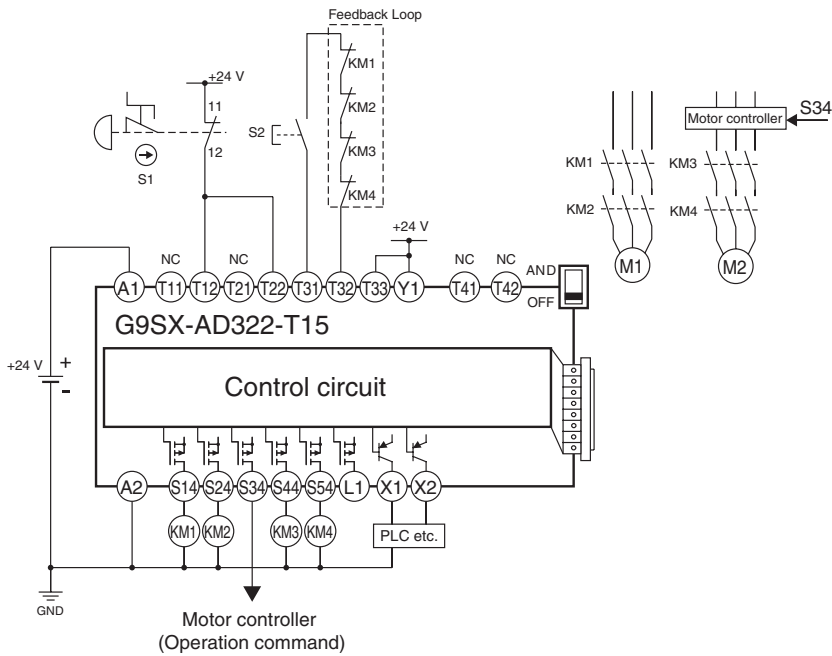

Timing chart

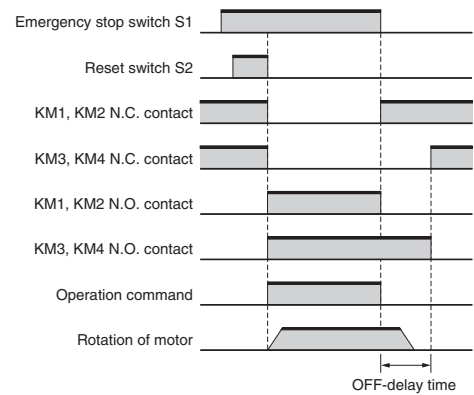

- S1: Emergency Stop Switch
- S2: Reset Switch S2
- KM1 to KM4: Contactor
- M1, M2: 3-phase motor

Note: This example corresponds to category 2 (EN 954-1)

G9SX-AD322-T15 (24 VDC) (2-channel Safety Sensor / Auto Reset)

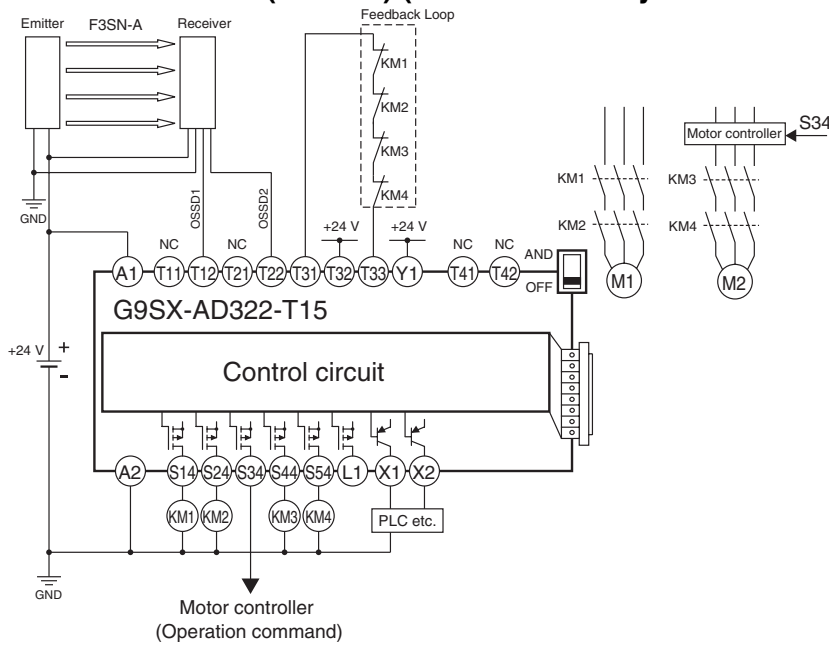

- F3SN-A: Safety sensor
- KM1 to KM4: Contactor
- M1, M2: 3-phase motor

- Note:**
1. This example corresponds to category 4 (EN 954-1).
 2. For further information of settings and wiring, refer to the catalog or instruction manual of the connected sensor.
 3. Use safety sensors with PNP outputs.

Timing chart

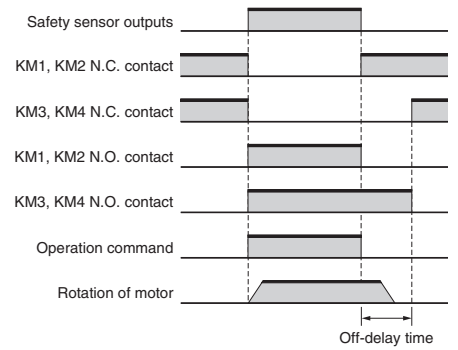

G9SX-BC202 (24 VDC) (2-channel Emergency Stop Switch Input / Manual Reset) + G9SX-AD322-T15 (24 VDC) (2-channel Safety Limit Switch Input / Auto Reset)

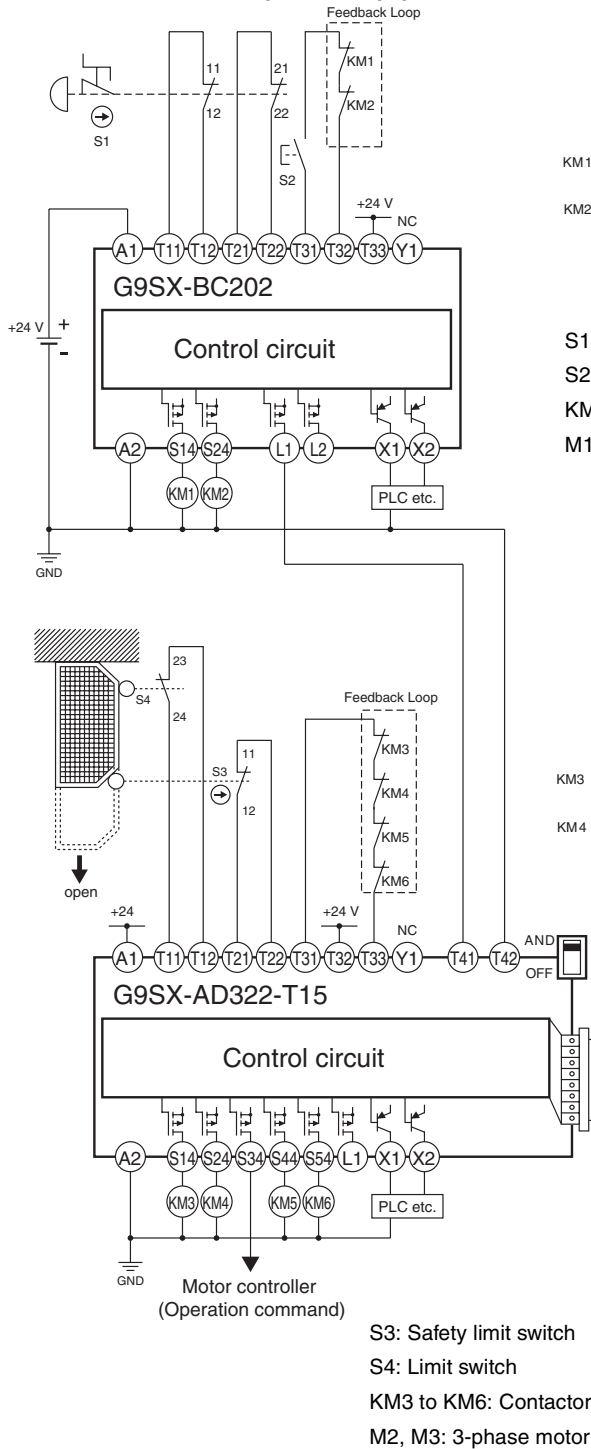

Note: This example corresponds to category 4 (EN 954-1).

Timing chart

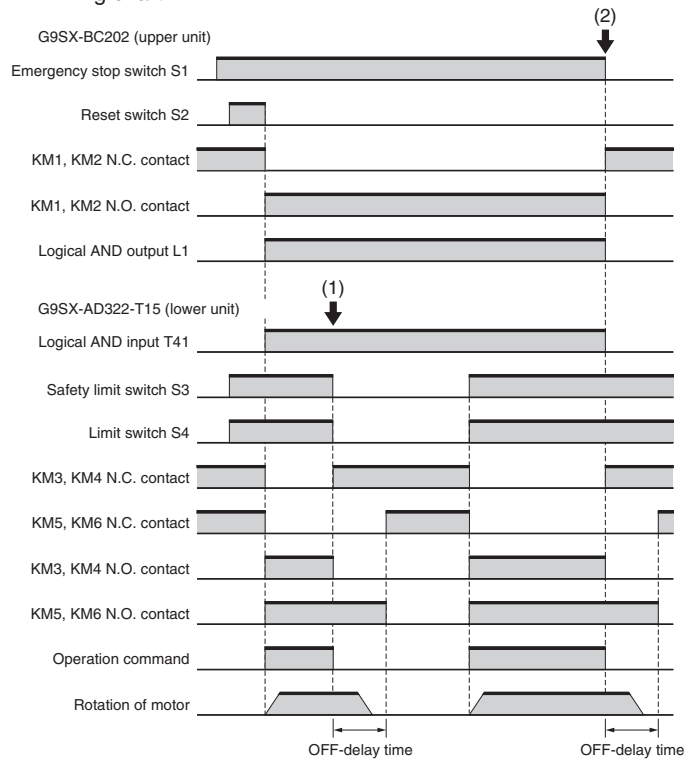

G9SX-AD322-T15 (24 VDC) + G9SX-EX041-T (24 VDC)
(Guard Lock Safety Door Switch (Mechanical Lock), 2-channel Safety Limit Switch Inputs / Manual Reset)

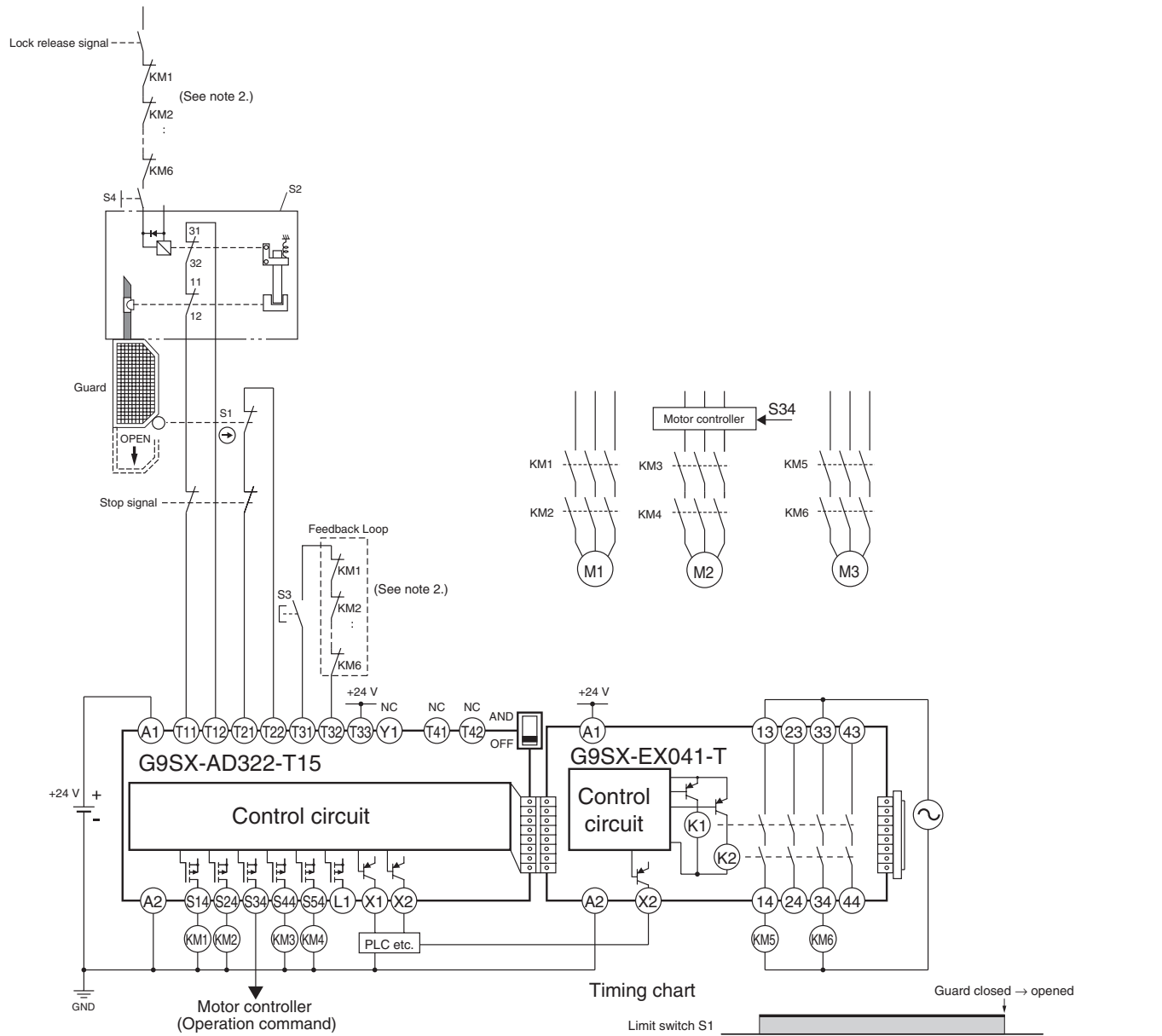

- S1: Safety limit switch
- S2: Guard lock safety door switch
- S3: Reset switch
- S4: Lock release switch
- KM1 to KM6: Contactor
- M1 to M3: 3-phase motor

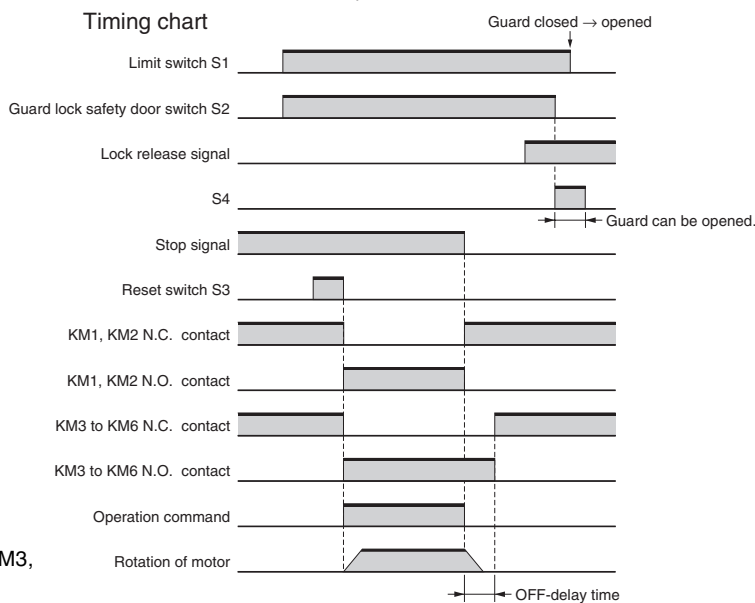

Note: 1. This example corresponds to category 4 (EN 954-1).
2. Connect the N.C. contacts of contactors KM1, KM2, KM3, KM4, KM5, and KM6 in series.

**G9SX-BC202 (24 VDC) (2-channel Emergency Stop Switch Input/Manual Reset) +
 G9SX-AD322-T15 (24 VDC) (2-channel Safety Limit Switch Input/Auto Reset) +
 G9SX-AD322-T15 (24 VDC) (2-channel Safety Limit Switch Input/Auto Reset) +
 G9SX-ADA222-T150 (24 VDC) (2-channel Safety Limit Switch Input/Auto Reset) +**

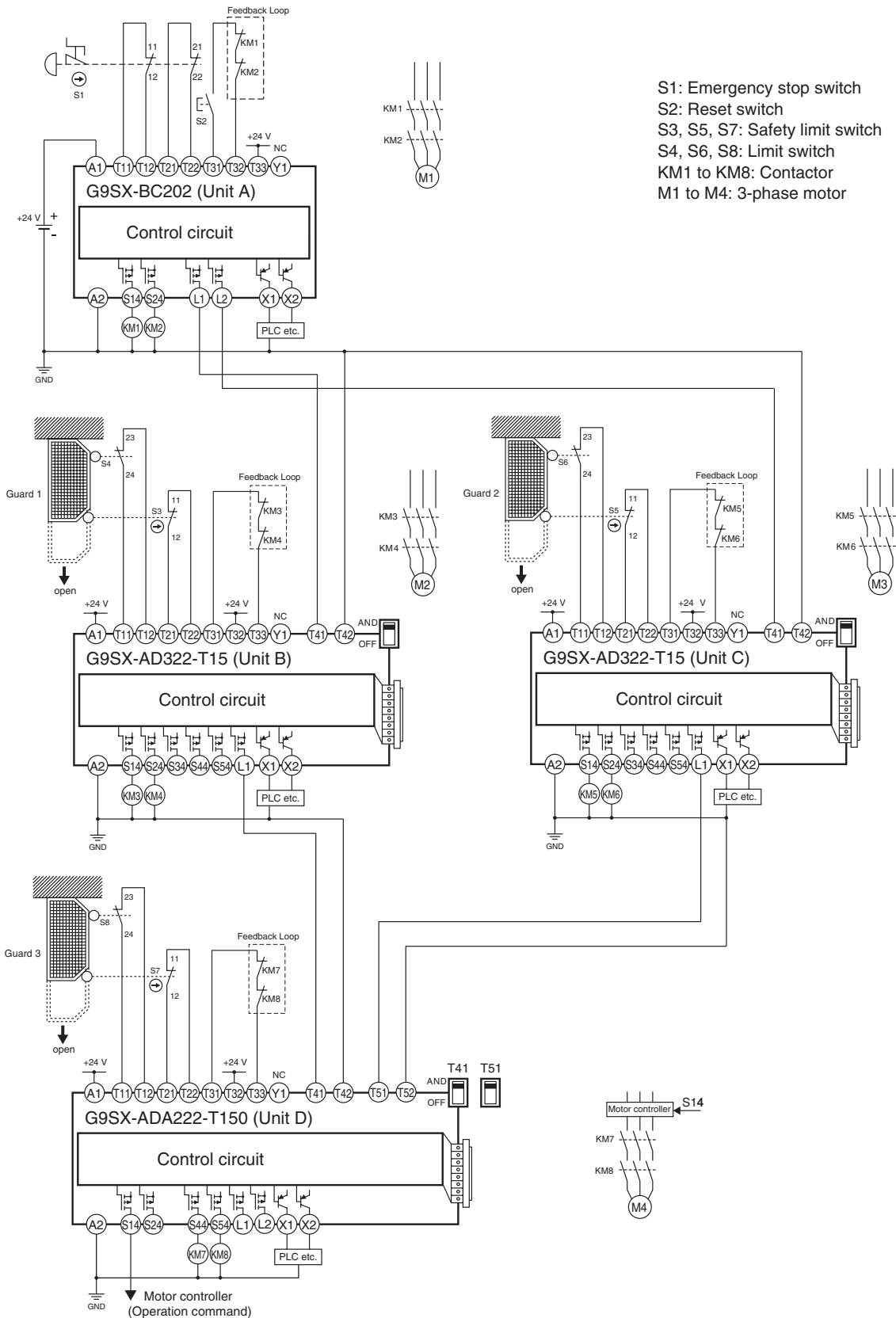

Note: This example corresponds to category 4.

Timing chart

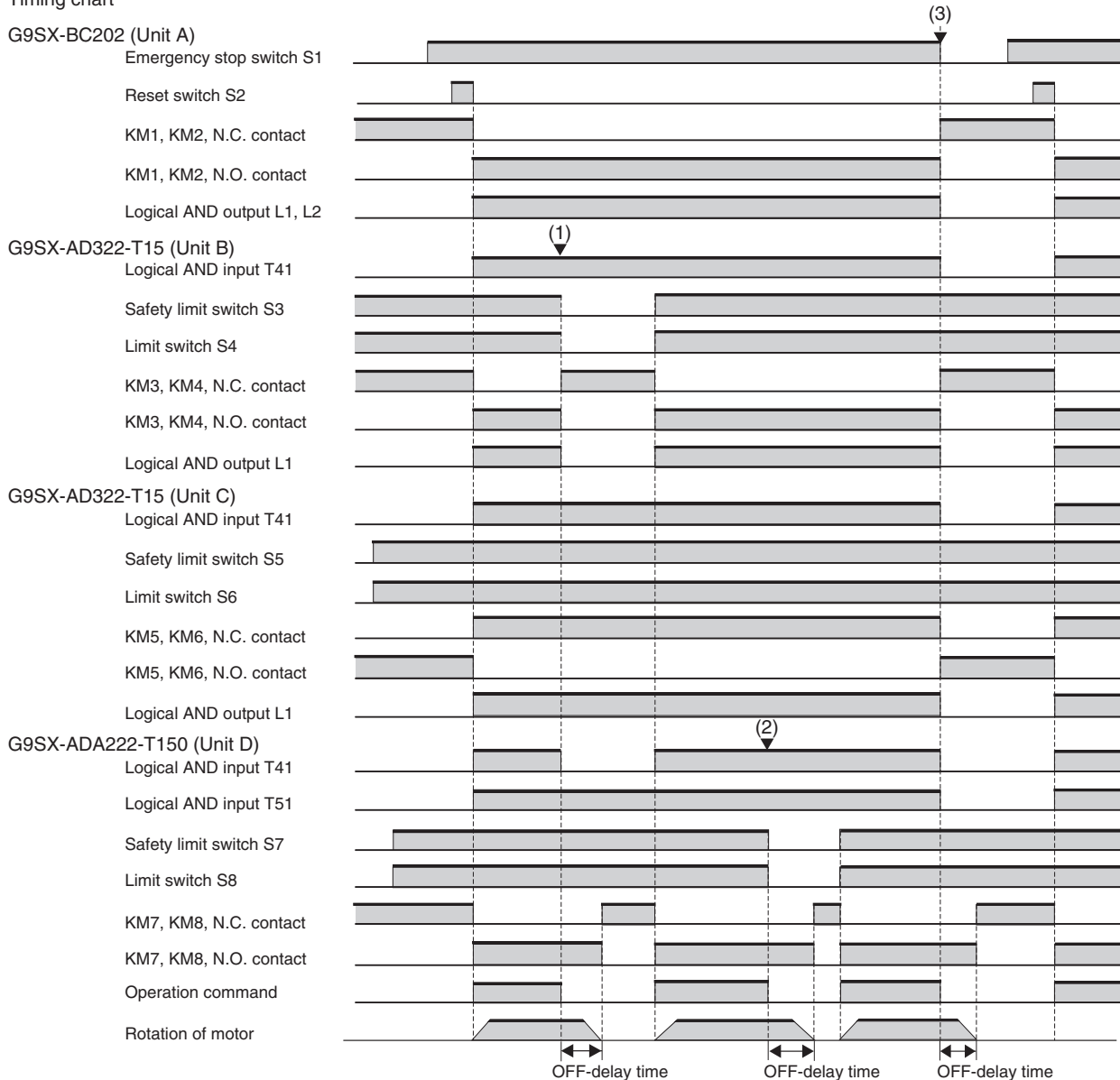

- (1) Guard 1 opened: Unit B and Unit D stops.
- (2) Guard 3 opened: Unit D stops.
- (3) Emergency stop button pressed: All units stop.

Warranty and Application Considerations

Read and Understand this Catalog

Please read and understand this catalog before purchasing the products. Please consult your OMRON representative if you have any questions or comments.

Warranty and Limitations of Liability

WARRANTY

OMRON's exclusive warranty is that the products are free from defects in materials and workmanship for a period of one year (or other period if specified) from date of sale by OMRON.

OMRON MAKES NO WARRANTY OR REPRESENTATION, EXPRESS OR IMPLIED, REGARDING NON-INFRINGEMENT, MERCHANTABILITY, OR FITNESS FOR PARTICULAR PURPOSE OF THE PRODUCTS. ANY BUYER OR USER ACKNOWLEDGES THAT THE BUYER OR USER ALONE HAS DETERMINED THAT THE PRODUCTS WILL SUITABLY MEET THE REQUIREMENTS OF THEIR INTENDED USE. OMRON DISCLAIMS ALL OTHER WARRANTIES, EXPRESS OR IMPLIED.

LIMITATIONS OF LIABILITY

OMRON SHALL NOT BE RESPONSIBLE FOR SPECIAL, INDIRECT, OR CONSEQUENTIAL DAMAGES, LOSS OF PROFITS, OR COMMERCIAL LOSS IN ANY WAY CONNECTED WITH THE PRODUCTS, WHETHER SUCH CLAIM IS BASED ON CONTRACT, WARRANTY, NEGLIGENCE, OR STRICT LIABILITY.

In no event shall the responsibility of OMRON for any act exceed the individual price of the product on which liability is asserted.

IN NO EVENT SHALL OMRON BE RESPONSIBLE FOR WARRANTY, REPAIR, OR OTHER CLAIMS REGARDING THE PRODUCTS UNLESS OMRON'S ANALYSIS CONFIRMS THAT THE PRODUCTS WERE PROPERLY HANDLED, STORED, INSTALLED, AND MAINTAINED AND NOT SUBJECT TO CONTAMINATION, ABUSE, MISUSE, OR INAPPROPRIATE MODIFICATION OR REPAIR.

Application Considerations

SUITABILITY FOR USE

OMRON shall not be responsible for conformity with any standards, codes, or regulations that apply to the combination of products in the customer's application or use of the products.

Take all necessary steps to determine the suitability of the product for the systems, machines, and equipment with which it will be used.

Know and observe all prohibitions of use applicable to this product.

NEVER USE THE PRODUCTS FOR AN APPLICATION INVOLVING SERIOUS RISK TO LIFE OR PROPERTY WITHOUT ENSURING THAT THE SYSTEM AS A WHOLE HAS BEEN DESIGNED TO ADDRESS THE RISKS, AND THAT THE OMRON PRODUCTS ARE PROPERLY RATED AND INSTALLED FOR THE INTENDED USE WITHIN THE OVERALL EQUIPMENT OR SYSTEM.

Disclaimers

PERFORMANCE DATA

Performance data given in this catalog is provided as a guide for the user in determining suitability and does not constitute a warranty. It may represent the result of OMRON's test conditions, and the users must correlate it to actual application requirements. Actual performance is subject to the OMRON *Warranty and Limitations of Liability*.

CHANGE IN SPECIFICATIONS

Product specifications and accessories may be changed at any time based on improvements and other reasons. Consult with your OMRON representative at any time to confirm actual specifications of purchased product.

DIMENSIONS AND WEIGHTS

Dimensions and weights are nominal and are not to be used for manufacturing purposes, even when tolerances are shown.

ALL DIMENSIONS SHOWN ARE IN MILLIMETERS.

To convert millimeters into inches, multiply by 0.03937. To convert grams into ounces, multiply by 0.03527.

Cat. No. J150-E1-04 **In the interest of product improvement, specifications are subject to change without notice.**

OMRON Corporation

Industrial Automation Company

Safety Devices Division

Shiokoji Horikawa, Shimogyo-ku,
Kyoto, 600-8530 Japan

Tel: (81)75-344-7093/Fax: (81)75-344-8197