

### Surface Mounting Relay with the World's Smallest Mounting Area and a Height of Only 5.2 mm

- Subminiature model as small as 5.2 (H) x 6.5 (W) x 10 (L) mm is ideal for high-density mounting.
- Low profile of 5.2 mm and weight of only 0.7 g combine to improve mounting efficiency.
- Models with inside-L surface mounting terminals are available.
- Consumes approximately 70% the power of a conventional OMRON model and operates at a current that is as low as 100 mA.
- Surface mounting terminal models incorporate a unique terminal structure with high infrared irradiation efficiency which allows the terminal temperature to rise easily when mounting the IRS, thus ensuring excellent soldering.
- Ensures a dielectric strength of 1,500 VAC and conforms to FCC Part 68 (i.e., withstanding an impulse withstand voltage of 1,500 V for 10 x 160 μs).
- New-Y models offer an impulse withstand voltage of 2,500 V for 2 x 10 μs (conforms to Telcordia specifications) by optimizing the distance between coil and contacts.
- Conforms to UL1950 (File No. E41515)/CSA C22.2 No. 950 (File No. LR24825)

The above specifications are ensured as of August 1999.

RoHS Compliant

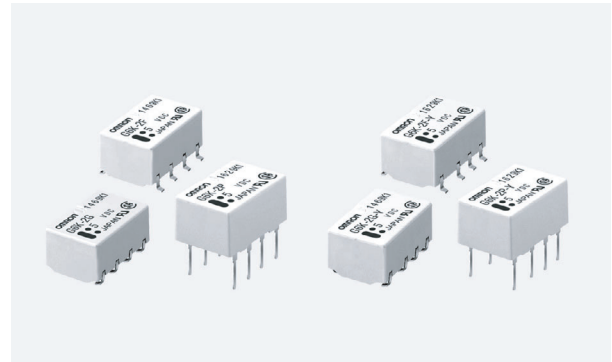

## Ordering Information

Classification			Single-side stable	Single-winding latching	Single-side stable Bellcore: 2,500 V for 2x10 μs	
DPDT	Fully sealed	PCB terminal	G6K-2P	G6KU-2P-Y	G6K-2P-Y	
		Surface mounting terminal	Inside-L	G6K-2G	G6KU-2G-Y	G6K-2G-Y
			Outside-L	G6K-2F	G6KU-2F-Y	G6K-2F-Y

**Note:** 1. When ordering, add the rated coil voltage to the model number.

Example: G6K-2F 12 VDC

Rated coil voltage

2. When ordering tape packing, add -TR" to the model number.

Example: G6K-2F-TR 12 VDC

Tape packing

Be sure since -TR" is not part of the relay model number, it is not marked on the relay case.

### Model Number Legend

G6K    -    -    -    VDC

1    2    3    4    5

#### 1. Relay function

None: Single-side stable model

U: Single-winding latching model

#### 2. Contact form

2: DPDT

#### 3. Terminal shape

F: Outside-L surface mounting terminal

G: Inside-L surface mounting terminal

P: PCB terminal

#### 4. Approved standards

None: UL, CSA

Does not conform to Telcordia specifications

Y: UL, CSA

Conforms to Telcordia specifications: 2,500 V for 2 x 10 μs

#### 5. Rated Coil Voltage

3, 4.5, 5, 12, 24 VDC

# Application Examples

Telephones, communications equipment, measurement devices, office automation machines, and audio–visual products.

## Specifications

Contact mechanism: Bifurcated crossbar Ag (Au-alloy contact)

Enclosure ratings: Fully sealed

### ■ Coil Ratings

#### Single-side Stable Models

G6K-2F, G6K-2G, G6K-2P

Rated voltage	3 VDC	4.5 VDC	5 VDC	12 VDC
Rated current	33.0 mA	23.2 mA	21.1 mA	9.1 mA
Coil resistance	91 Ω	194 Ω	237 Ω	1,315 Ω
Must operate voltage	80% max. of rated voltage			
Must release voltage	10% min. of rated voltage			
Max. voltage	150% of rated voltage at 23°C to 70°C			
Power consumption	Approx. 100 mW			

- Note:**
1. The rated current and coil resistance are measured at a coil temperature of 23°C with a tolerance of ±10%.
  2. The operating characteristics are measured at a coil temperature of 23°C.
  3. The maximum voltage is the highest voltage that can be imposed on the relay coil instantaneously.

#### Single-side Stable Models (Bellcore Version)

G6K-2F-Y, G6K-2G-Y, G6K-2P-Y

Rated voltage	3 VDC	4.5 VDC	5 VDC	12 VDC	24 VDC
Rated current	33.0 mA	23.2 mA	21.1 mA	9.1 mA	4.6 mA
Coil resistance	91 Ω	194 Ω	237 Ω	1,315 Ω	5,220 Ω
Must operate voltage	80% max. of rated voltage				
Must release voltage	10% min. of rated voltage				
Max. voltage	150% of rated voltage at 23°C to 70°C				
Power consumption	Approx. 100 mW				

- Note:**
1. The rated current and coil resistance are measured at a coil temperature of 23°C with a tolerance of ±10%.
  2. The operating characteristics are measured at a coil temperature of 23°C.
  3. The maximum voltage is the highest voltage that can be imposed on the relay coil instantaneously.

#### Single-winding Latching Models (Bellcore Version)

G6KU-2F-Y, G6KU-2G-Y, G6KU-2P-Y

Rated voltage	3 VDC	4.5 VDC	5 VDC	12 VDC	24 VDC
Rated current	33.0 mA	23.2 mA	21.1 mA	9.1 mA	4.6 mA
Coil resistance	91 Ω	194 Ω	237 Ω	1,315 Ω	5,220 Ω
Must set voltage	75% max. of rated voltage				
Must reset voltage	75% max. of rated voltage				
Max. voltage	150% of rated voltage at 23°C to 70°C				
Power consumption	Approx. 100 mW				

- Note:**
1. The rated current and coil resistance are measured at a coil temperature of 23°C with a tolerance of ±10%.
  2. The operating characteristics are measured at a coil temperature of 23°C.
  3. The maximum voltage is the highest voltage that can be imposed on the relay coil instantaneously.

## ■ Contact Ratings

Load	Resistive load
Rated load	0.3 A at 125 VAC; 1 A at 30 VDC
Rated carry current	1 A
Max. switching voltage	125 VAC, 60 VDC
Max. switching current	1 A

## ■ Characteristics

Item		Single-side stable models (double-pole)		Single-winding latching model
		G6K-2F, G6K-2G, G6K-2P	G6K-2F-Y, G6K-2G-Y, G6K-2P-Y	G6KU-2F-Y, G6KU-2G-Y, G6KU-2P-Y
Contact resistance (See note 1.)		100 mΩ max.		
Operating (set) time (See note 2.)		3 ms max. (approx. 1.4 ms)		3 ms max. (approx. 1.2 ms)
Release (reset) time (See note 2.)		3 ms max. (approx. 1.3 ms)		3 ms max. (approx. 1.2 ms)
Insulation resistance (See note 3.)		1,000 MΩ min. (at 500 VDC)		
Dielectric strength	Coil and contacts	1,500 VAC, 50/60 Hz for 1 min		
	Contacts of different polarity	1,000 VAC, 50/60 Hz for 1 min		
	Contacts of same polarity	750 VAC, 50/60 Hz for 1 min		
Impulse withstand voltage	Coil and contacts	1,500 V (10 x 160 μs)	2,500 V (2 x 10 μs), 1,500 V (10 x 160 μs)	
	Contacts of different polarity	1,500 V (10 x 160 μs)		
	Contacts of same polarity			
Vibration resistance		Destruction: 10 to 55 Hz, 2.5-mm single amplitude (5-mm double amplitude) and 55 to 500 Hz, 300 m/s <sup>2</sup> (approx. 30G) Malfunction: 10 to 55 Hz, 1.65-mm single amplitude (3.3-mm double amplitude) and 55 to 500 Hz, 200 m/s <sup>2</sup> (approx. 20G)		
Shock resistance		Destruction: 1,000 ms <sup>2</sup> (approx. 100G) Malfunction: 750 ms <sup>2</sup> (approx. 75G)		
Endurance		Mechanical: 50,000,000 operations min. (at 36,000 operations/hour) Electrical: 100,000 operations min. (with a rated load at 1,800 operations/hour)		
Failure rate (P level) (See note 4.)		10 μA at 10 mVDC		
Ambient temperature		Operating: -40°C to 70°C (with no icing or condensation)		
Ambient humidity		Operating: 5% to 85%		
Weight		Approx. 0.7 g		

**Note:** The above values are initial values.

**Note:** 1. The contact resistance was measured with 10 mA at 1 VDC with a voltage-drop method.

2. Values in parentheses are actual values.

3. The insulation resistance was measured with a 500-VDC megohmmeter applied to the same parts as those used for checking the dielectric strength.

4. This value was measured at a switching frequency of 120 operations/min and the criterion of contact resistance is 50 Ω. This value may vary depending on the switching frequency and operating environment. Always double-check relay suitability under actual operating conditions.

# Engineering Data

## Maximum Switching Power

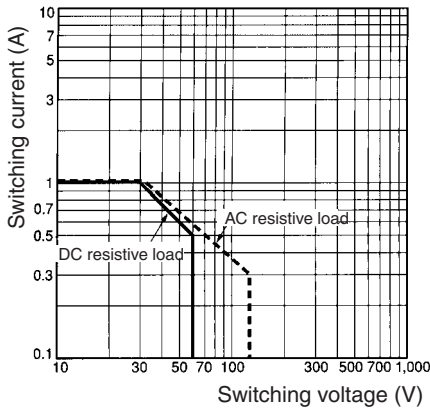

## Ambient Temperature vs. Maximum Coil Voltage

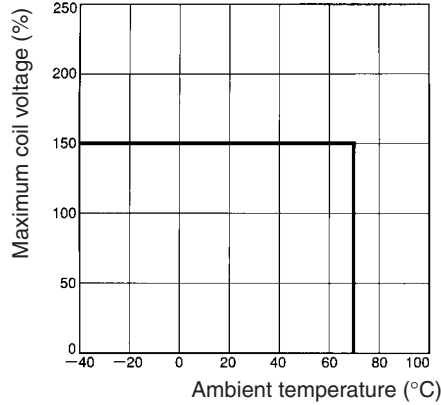

## Ambient Temperature vs. Switching Current

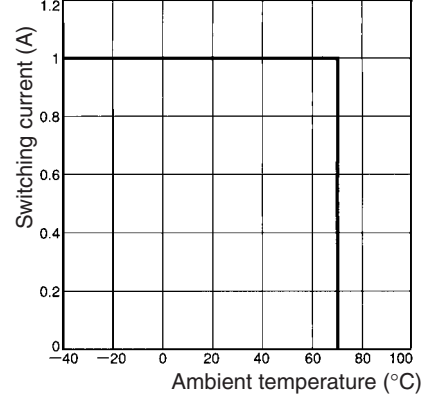

**Note:** The maximum coil voltage refers to the maximum value in a varying range of operating power voltage, not a continuous voltage.

## Endurance

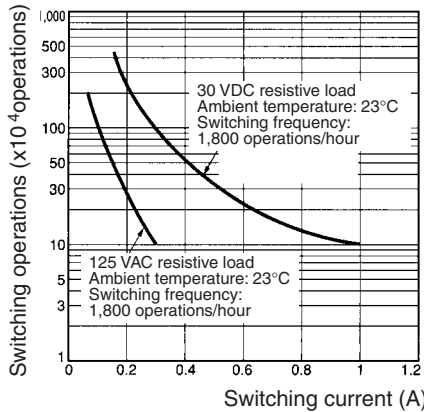

## Ambient Temperature vs. Must Operate or Must Release Voltage G6K-2G (F/P), G6K-2G (F/P)-Y

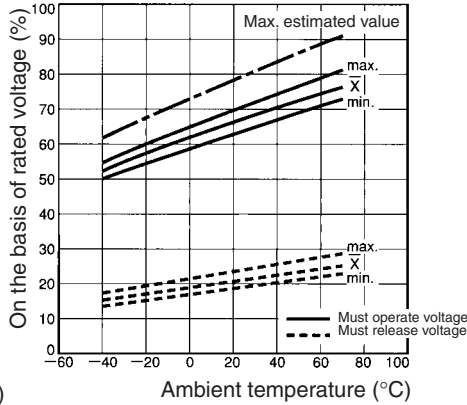

## Ambient Temperature vs. Must Set or Must Reset Voltage G6KU-2G (F/P)-Y

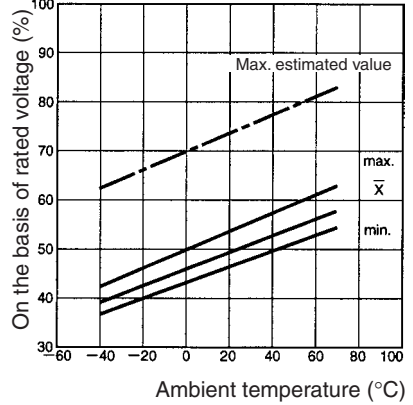

## Shock Malfunction

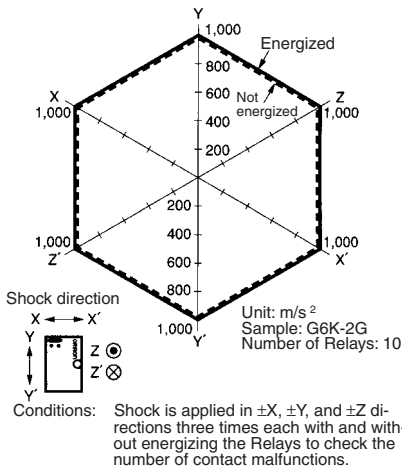

## Electrical Endurance (with Must Operate and Must Release Voltage) (See note.) G6K-2G (F/P), G6K-2G (F/P)-Y

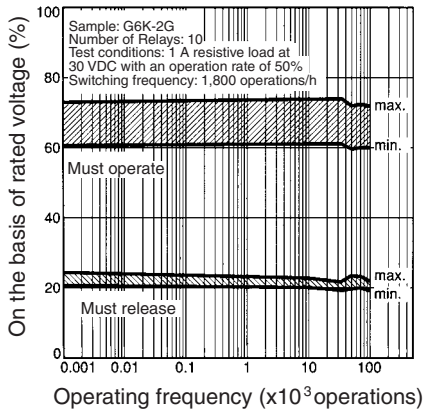

**Note:** The tests were conducted at an ambient temperature of 23°C.

## Electrical Endurance (Contact Resistance) (See note.) G6K-2G (F/P), G6K-2G (F/P)-Y

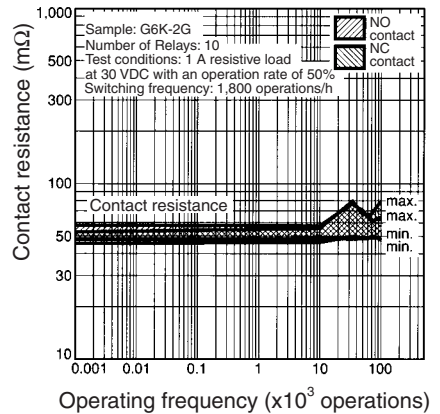

**Note:** The tests were conducted at an ambient temperature of 23°C.

**Contact Reliability Test (See note.)**  
**G6K-2G (F/P), G6K-2G (F/P)-Y**

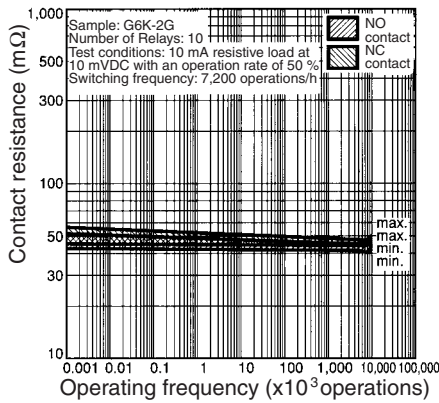

**Mutual Magnetic Interference**  
**G6K-2G (F/P), G6K-2G (F/P)-Y**

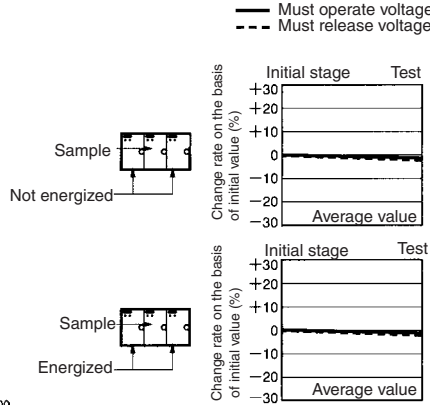

**Mutual Magnetic Interference**  
**G6K-2G (F/P), G6K-2G (F/P)-Y**

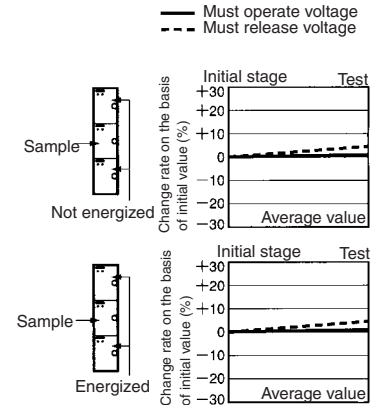

**Note 1:** The test was conducted at an ambient temperature of 23°C.

**2:** The contact resistance data are periodically measured reference values and are not values from each monitoring operation. Contact resistance values will vary according to the switching frequency and operating environment, so be sure to check operation under the actual operating conditions before use.

**External Magnetic Interference**  
**G6K-2G (F/P), G6K-2G (F/P)-Y**

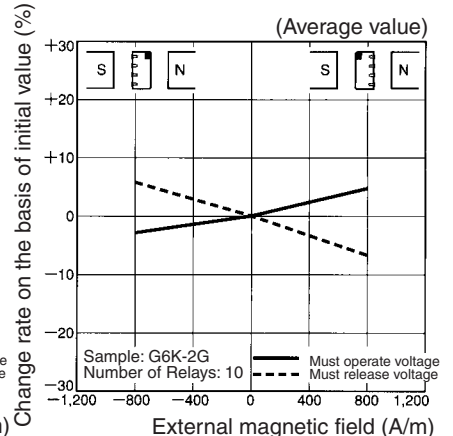
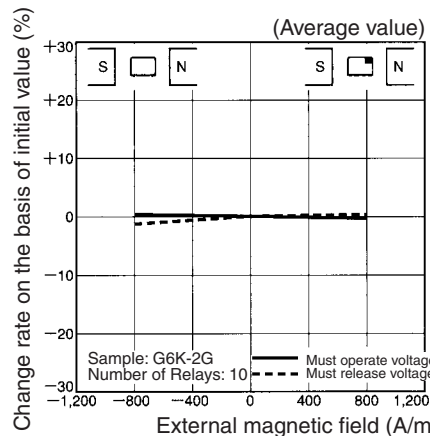
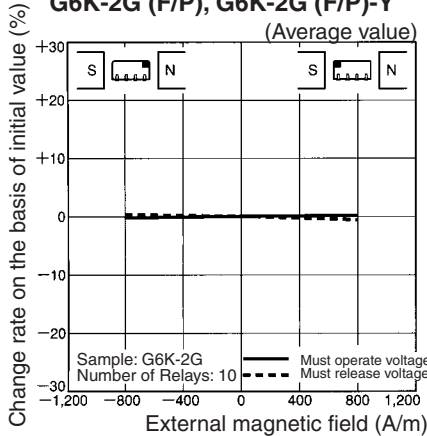

**High-frequency Characteristics (Isolation)**  
**G6K-2G (F/P), G6K-2G (F/P)-Y**

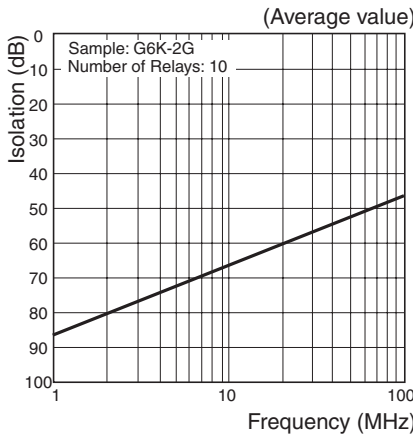

**High-frequency Characteristics (Insertion Loss)**  
**G6K-2G (F/P), G6K-2G (F/P)-Y**

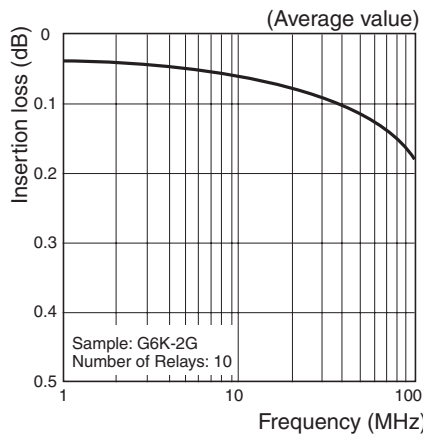

**High-frequency Characteristics (Return Loss)**  
**G6K-2G (F/P), G6K-2G (F/P)-Y**

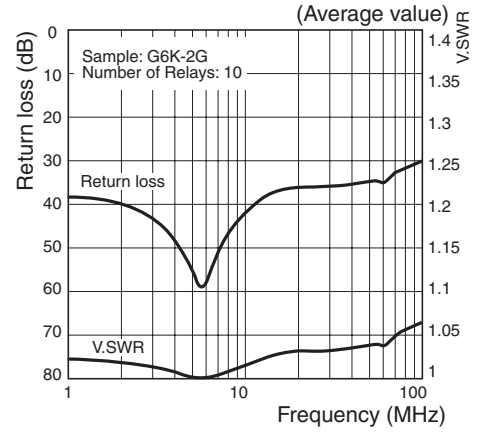

**Note:** 1. The tests were conducted at an ambient temperature of 23°C.

**2.** High-frequency characteristics depend on the PCB to which the Relay is mounted. Always check these characteristics including endurance in the actual machine before use.

**Must Operate and Must Release Time Distribution (See note.)**  
**G6K-2G (F/P), G6K-2G (F/P)-Y**

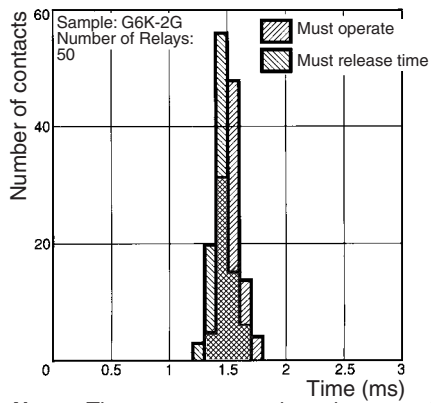

**Note:** The tests were conducted at an ambient temperature of 23°C.

**Must Operate and Must Release Bounce Time Distribution (See note.)**  
**G6K-2G (F/P), G6K-2G (F/P)-Y**

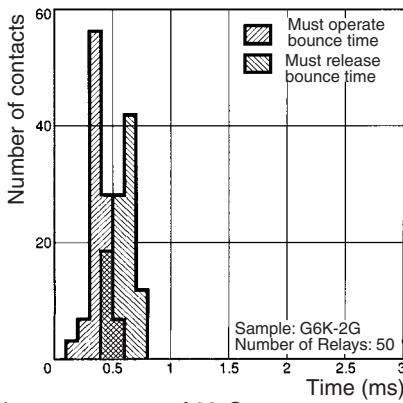

**Vibration Resistance**  
**G6K-2G (F/P), G6K-2G (F/P)-Y**

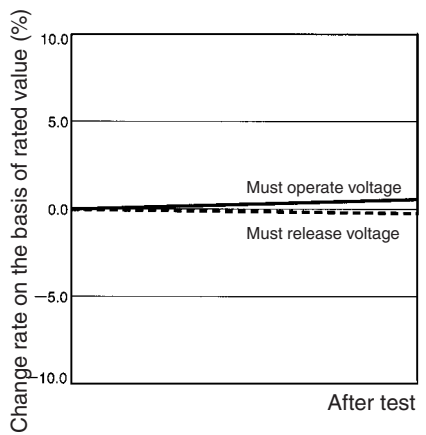

**Dimensions**

**Note:** All units are in millimeters unless otherwise indicated.

■ **DPDT**

**G6K-2F**

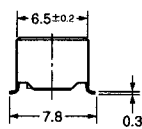
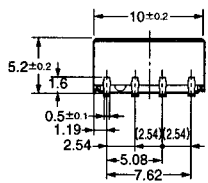
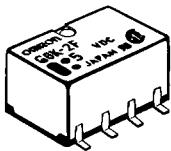

**Mounting Dimensions (Top View)**

Tolerance: ±0.1 mm

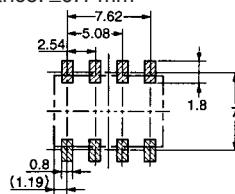

**Terminal Arrangement/Internal Connections (Top View)**

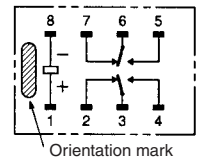

**Note:** Each value has a tolerance of ±0.3 mm.

**G6K-2G**

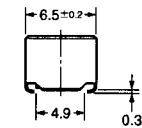
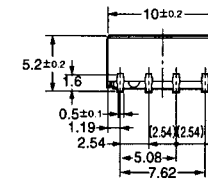
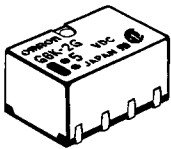

**Mounting Dimensions (Top View)**

Tolerance: ±0.1 mm

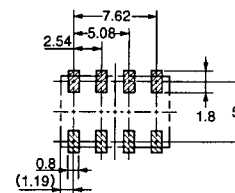

**Terminal Arrangement/Internal Connections (Top View)**

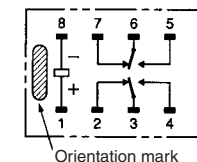

**Note:** Each value has a tolerance of ±0.3 mm.

**G6K-2P**

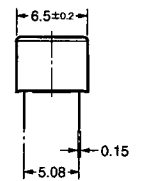
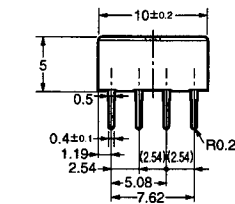
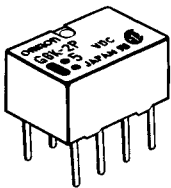

**Mounting Dimensions (Bottom View)**

Tolerance: ±0.1 mm

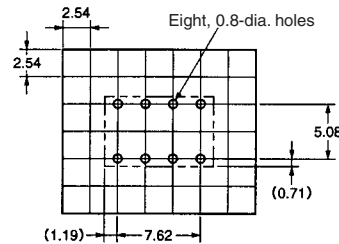

**Terminal Arrangement/Internal Connections (Bottom View)**

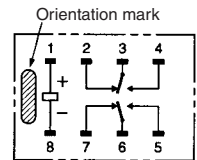

**Note:** Each value has a tolerance of ±0.3 mm.

G6K-2F-Y

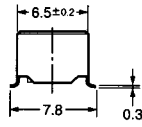
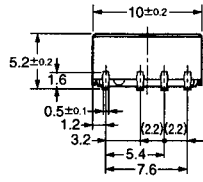
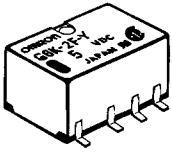

Mounting Dimensions (Top View)

Tolerance:  $\pm 0.1$  mm

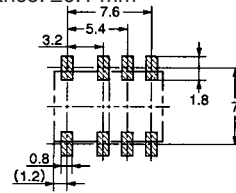

Terminal Arrangement/Internal Connections (Top View)

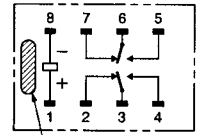

Orientation mark

G6K-2G-Y

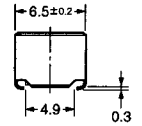
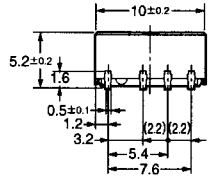
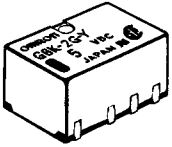

Mounting Dimensions (Top View)

Tolerance:  $\pm 0.1$  mm

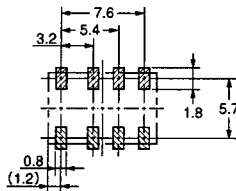

Terminal Arrangement/Internal Connections (Top View)

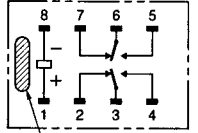

Orientation mark

G6K-2P-Y

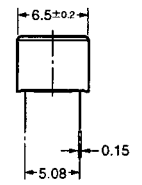
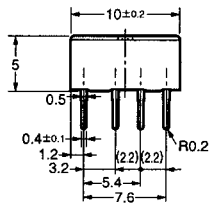
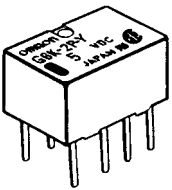

Mounting Dimensions (Bottom View)

Tolerance:  $\pm 0.1$  mm

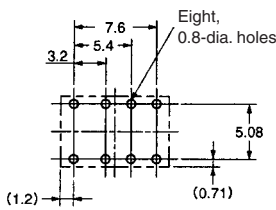

Terminal Arrangement/Internal Connections (Bottom View)

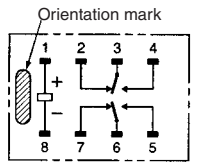

Orientation mark

Note: Each value has a tolerance of  $\pm 0.3$  mm.

Note: Each value has a tolerance of  $\pm 0.3$  mm.

G6KU-2F-Y

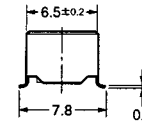
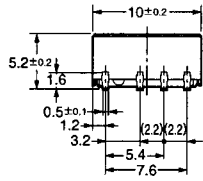
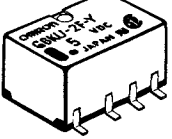

Mounting Dimensions (Top View)

Tolerance:  $\pm 0.1$  mm

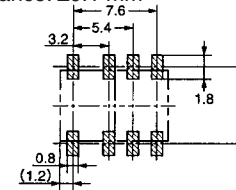

Terminal Arrangement/Internal Connections (Top View)

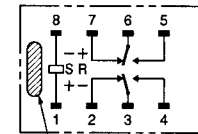

Orientation mark

G6KU-2G-Y

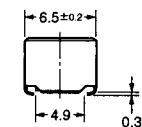
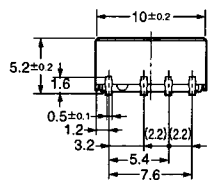
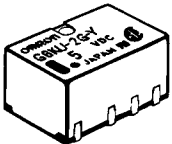

Mounting Dimensions (Top View)

Tolerance:  $\pm 0.1$  mm

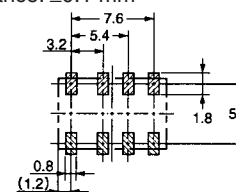

Terminal Arrangement/Internal Connections (Top View)

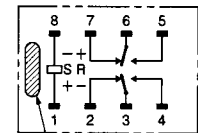

Orientation mark

G6KU-2P-Y

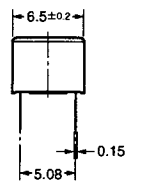
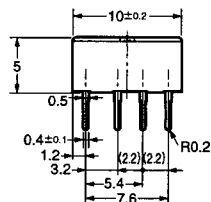
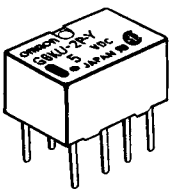

Mounting Dimensions (Bottom View)

Tolerance:  $\pm 0.1$  mm

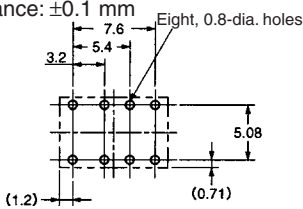

Terminal Arrangement/Internal Connections (Bottom View)

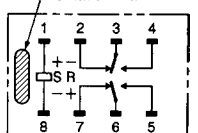

Orientation mark

Note: Each value has a tolerance of  $\pm 0.3$  mm.

Note: Each value has a tolerance of  $\pm 0.3$  mm.

Note: Each value has a tolerance of  $\pm 0.3$  mm.

# Stick Packing and Tape Packing

## Stick Packing

Relays in stick packing are arranged so that the orientation mark of each Relay in on the left side. Fifty Relays are packed on one stick.

Be sure not to make mistakes in Relay orientation when mounting the Relay to the PCB.

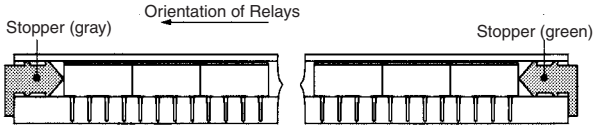

Stick length: 520 mm (stopper not included)  
 No. of Relays per stick: 50

## Tape Packing (Surface Mounting Terminal Models)

When ordering Relays in tape packing, add the prefix “-TR” to the model number, otherwise the Relays in stick packing will be provided.

Tape Type:ETX7200  
 (EIAJ (Electronic Industrial Association of Japan))  
 Reel type:RPM-16D (EIAJ)  
 Relays per Reel: 900

### 1. Direction of Relay Insertion

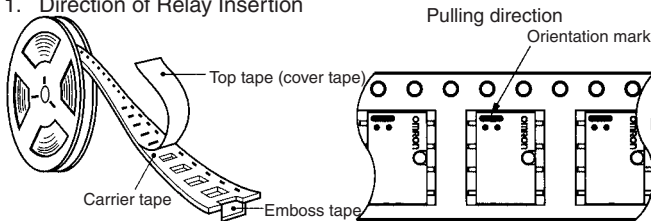

### 2. Reel Dimensions

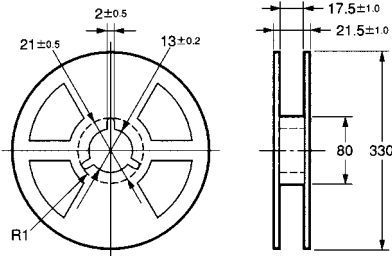

### 3. Carrier Tape Dimensions

G6K-2F, G6K-2F-Y, G6KU-2F-Y

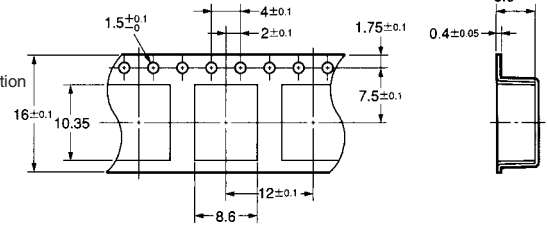

G6K-2G, G6K-2G-Y, G6KU-2G-Y

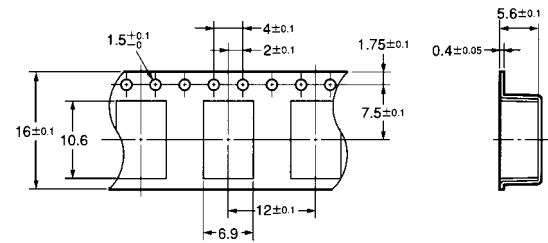



# Recommended Soldering Method

Temperature indicate the surface temperature of the PCBs.

IRS Method (for surface mounting terminal models)

## (1) IRS Method (Mounting Solder: Lead)

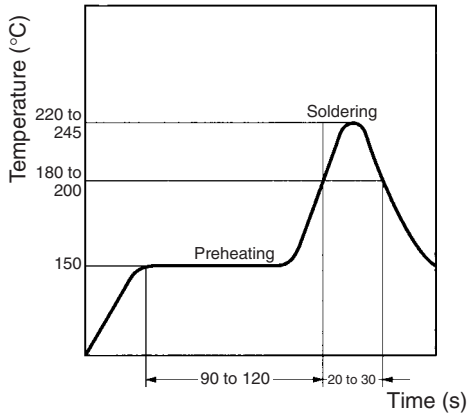

## (2) IRS Method (Mounting Solder: Lead-free)

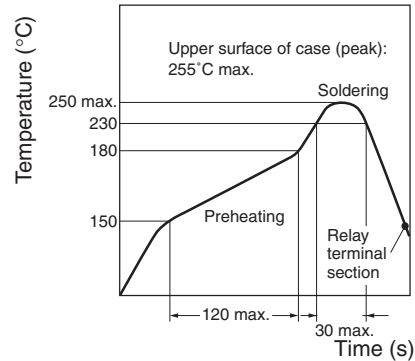

**Note:** The temperature profile indicates the temperature of the relay terminal section.

- The thickness of cream solder to be applied should be within a range between 150 and 200  $\mu\text{m}$  on OMRON's recommended PCB pattern.
- In order to perform correct soldering, it is recommended that the correct soldering conditions be maintained as shown below on the left side.

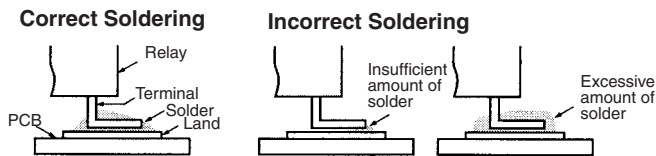

Visually check that the Relay is properly soldered.

## ■ Approved Standards

UL approval:UL1950 (File No. E41515)

CSA approval:C22.2 No. 950 (File No. LR31928)

Contact form	Coil rating	Contact rating	Number of test operations
DPDT	G6K-2G(F/P): 3 to 12 VDC G6K(U)-2G(F/P)-Y: 3 to 24 VDC	1 A at 30 VDC 0.5 A at 60 VDC 0.3 A at 125 VAC	6,000

# Precautions

Refer to *PCB Relays Catalog (X033)* for information on general precautions. Be sure to read these precautions before using the Relay.

## Correct Use

### Long-term Continuously ON Contacts

Using the Relay in a circuit where the Relay will be ON continuously for long periods (without switching) can lead to unstable contacts because the heat generated by the coil itself will affect the insulation, causing a film to develop on the contact surfaces. We recommend using a latching relay (magnetic-holding relay) in this kind of circuit. If a single-side stable model must be used in this kind of circuit, we recommend using a fail-safe circuit design that provides protection against contact failure or coil burnout.

### Relay Handling

Use the Relay as soon as possible after opening the moisture-proof package. If the Relay is left for a long time after opening the moisture-proof package, the appearance may suffer and seal failure may occur after the solder mounting process. To store the Relay after opening the moisture-proof package, place it into the original package and sealed the package with adhesive tape.

When washing the product after soldering the Relay to a PCB, use a water-based solvent or alcohol-based solvent, and keep the solvent temperature to less than 40°C. Do not put the Relay in a cold cleaning bath immediately after soldering.

### Soldering

Soldering temperature: Approx. 250°C (260°C if the DWS method is used)

Soldering time: Approx. 5 s max. (approx. 2 s for the first time and approx. 3 s for the second time if the DWS method is used)

Be sure to adjust the level of the molten solder so that the solder will not overflow onto the PCB.

### Claw Securing Force During Automatic Mounting

During automatic insertion of Relays, make sure to set the securing force of each claw to the following so that the Relays characteristics will be maintained.

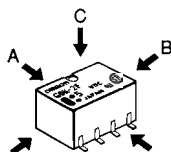

Direction A: 1.96 N  
Direction B: 4.90 N  
Direction C: 1.96 N

### Environmental Conditions During Operation, Storage, and Transportation

Protect the Relay from direct sunlight and keep the Relay under normal temperature, humidity, and pressure.

If the Relay is stored for a long time in an adverse environment with high temperature, high humidity, organic gases, or sulfide gases, sulfide or oxide films will form on the contact surfaces. These films may result in unstable contact, contact problems, or functional problems. Therefore, operate, store, or transport the product under specified environmental conditions.

### Latching Relay Mounting

Make sure that the vibration or shock that is generated from other devices, such as relays in operation, on the same panel and imposed on the Latching Relay does not exceed the rated value, otherwise the Latching Relay that has been set may be reset or vice versa. The Latching Relay is reset before shipping. If excessive vibration or shock is imposed, however, the Latching Relay may be set accidentally. Be sure to apply a reset signal before use.

### Maximum Allowable Voltage

The maximum allowable voltage of the coil can be obtained from the coil temperature increase and the heat-resisting temperature of coil insulating sheath material. (Exceeding the heat-resisting temperature may result in burning or short-circuiting.) The maximum allowable voltage also involves important restrictions which include the following:

- Must not cause thermal changes in or deterioration of the insulating material.
- Must not cause damage to other control devices.
- Must not cause any harmful effect on people.
- Must not cause fire.

Therefore, be sure to use the maximum allowable voltage beyond the value specified in the catalog.

As a rule, the rated voltage must be applied to the coil. A voltage exceeding the rated value, however, can be applied to the coil provided that the voltage is less than the maximum allowable voltage. It must be noted that continuous voltage application to the coil will cause a coil temperature increase thus affecting characteristics such as electrical life and resulting in the deterioration of coil insulation.

### Coating

The Relay mounted on the PCB may be coated or washed but do not apply silicone coating or detergent containing silicone, otherwise the silicone coating or detergent may remain on the surface of the Relay.

### PCB Mounting

If two or more Relays are closely mounted with the long sides of the Relays facing each other and soldering is performed with infrared radiation, the solder may not be properly exposed to the infrared rays. Be sure to keep the proper distance between adjacent Relays as shown below.

#### G6K-2G

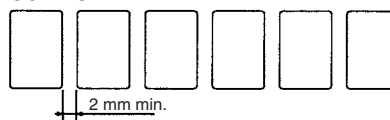

#### G6K-2F

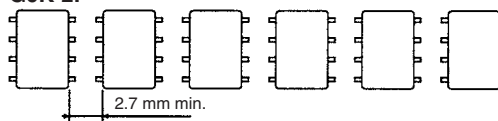

Two or more Relays may be closely mounted with the short sides of the Relays facing each other.



**ALL DIMENSIONS SHOWN ARE IN MILLIMETERS.**

To convert millimeters into inches, multiply by 0.03937. To convert grams into ounces, multiply by 0.03527.

Cat. No. K106-E1-04 **In the interest of product improvement, specifications are subject to change without notice.**

## **OMRON RELAY & DEVICES Corporation**

**Low Signal Relay Division**

**Marketing & Product Engineering Department**

1110, Sugi, Yamaga-city, Kumamoto-Pref., 861-0596 Japan

Tel: (81)968-44-4194/Fax: (81)968-44-4107

Printed in Japan

0106-0.4M (0898) (C)