

### Flat Relays that Switch 10-A/15-A Loads with New Quick-connect Terminals

- Ideal for switching power in household appliances or for outputs from industrial devices.
- Subminiature dimensions: 22 x 16 x 11 mm (L x W x H).
- High-sensitivity models available with low power consumption (150 mW).
- UL and CSA approved.
- Fully sealed models and quick-connect terminal models available (#187 load contact terminals).

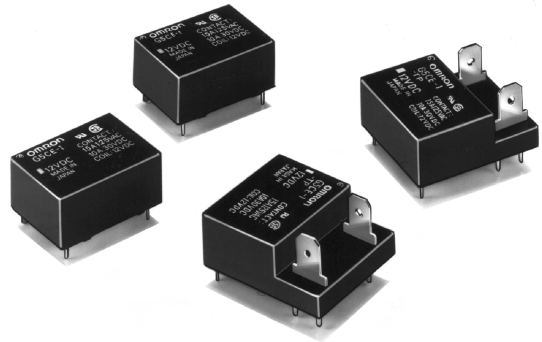

RCE

### Ordering Information

Contact form	Enclosure ratings	General purpose	High-sensitivity	High-capacity	Quick-connect terminals
SPST-NO	Flux protection	G5C-1	G5C-1-H	G5CE-1	G5CE-1-TP
	Fully sealed	G5C-14	G5C-14-H	---	---

- Note:**
1. When ordering, add the rated coil voltage to the model number.  
Example: G5C-1 12 VDC  
Rated coil voltage
  2. High-capacity models with a Fully sealed structure are not available.
  3. Standard or high-sensitivity models with quick-connect terminals are not available.
  4. VDE-approved models are available. Contact your OMRON representative for more details.
  5. Models with PTI250 are also available.  
Contact your OMRON representative for more details.

### Model Number Legend

G5C  -  -    VDC  
1    2    3    4    5

- |   |   |   |
|---|---|---|
| <b>1. Relay</b><br>None: General-purpose<br>E: High-capacity            | <b>2. Number of Poles</b><br>1: 1 pole (SPST-NO)        | <b>4. Classification</b><br>H: High-sensitivity<br>TP: Quick-connect terminals (#187) |
| <b>3. Enclosure Ratings</b><br>None: Flux protection<br>4: Fully sealed | <b>5. Rated Coil Voltage</b><br>3, 5, 6, 12, 24, 48 VDC |   |

# Specifications

## ■ Coil Ratings

Item	Standard, high-capacity, or quick-connect terminals			High-sensitivity		
	5 VDC	12 VDC	24 VDC	5 VDC	12 VDC	24 VDC
Rated current	40 mA	16.7 mA	8.3 mA	30 mA	12.5 mA	6.25 mA
Coil resistance	125 $\Omega$	720 $\Omega$	2,880 $\Omega$	167 $\Omega$	960 $\Omega$	3,840 $\Omega$
Must operate voltage	75% max. of rated voltage			80% max. of rated voltage		
Must release voltage	10% min. of rated voltage					
Max. voltage	130% (standard)/110% (high-capacity, quick-connect terminals) of rated voltage			130%		
Power consumption	Approx. 200 mW			Approx. 150 mW		

## ■ Contact Ratings

Item	Standard		High-sensitivity		High-capacity, or quick-connect terminals	
	Resistive load ( $\cos\phi = 1$ )	Inductive load ( $\cos\phi = 0.4$ , L/R = 7 ms)	Resistive load ( $\cos\phi = 1$ )	Inductive load ( $\cos\phi = 0.4$ , L/R = 7 ms)	Resistive load ( $\cos\phi = 1$ )	Inductive load ( $\cos\phi = 0.4$ , L/R = 7 ms)
Rated load	10 A at 250 VAC; 10 A at 30 VDC	3 A at 250 VAC; 3 A at 30 VDC	10 A at 250 VAC; 10 A at 30 VDC	3 A at 250 VAC; 3 A at 30 VDC	15 A at 110 VAC; 10 A at 30 VDC	5 A at 110 VAC; 3 A at 30 VDC
Rated carry current	10 A		10 A		15 A	
Max. switching voltage	250 VAC		250 VAC		250 VAC	
Max. switching current	10 A		10 A		15 A	
Max. switching power	2,500 VA, 300 W	750 VA, 90 W	2,500 VA, 300 W	750 VA, 90 W	2,500 VA, 300 W	750 VA, 90 W

## ■ Characteristics

Contact resistance	30 m $\Omega$ max. (Quick-connect terminals type: 100 m $\Omega$ max.)
Operate time	10 ms max. (High-sensitivity type: 15 ms max.)
Release time	10 ms max.
Insulation resistance	1,000 M $\Omega$ min.
Dielectric strength	2,500 VAC, 50/60 Hz for 1 min between contacts of same polarity 1,000 VAC, 50/60 Hz for 1 min between contacts of same polarity
Impulse withstand voltage	4,500 V (1.2 x 50 $\mu$ s) between coil and contacts
Vibration resistance	Destruction: 10 to 55 Hz, 1.5-mm double amplitude Malfunction: 10 to 55 Hz, 1.5-mm double amplitude
Shock resistance	Destruction: 1,000 m/s <sup>2</sup> Malfunction: 200 m/s <sup>2</sup>
Life expectancy	Mechanical: 20,000,000 operations min. at 18,000 operations/hr Electrical: 300,000 operations min. (100,000 operations min. for Fully sealed Type) at 1,200 operations/hr under rated load of 10 A at 250 VAC; 100,000 operations min. under load of 15 A at 110 VAC for high-capacity models 100,000 operations min. at 1,200 operations/hr under rated load of 10 A at 30 VDC
Ambient temperature	Operating: -25°C to 70°C (with no icing) Storage: -25°C to 70°C (with no icing)
Ambient humidity	Operating: 35% to 85%
Weight	Approx. 8 g (for TP model: Approx. 9.6 g)

- Note:** 1. The rated current and coil resistance are measured at a coil temperature of 23°C with a tolerance of  $\pm 10\%$ .  
2. Operating characteristics are measured at a coil temperature of 23°C.

## ■ Approved Standards

UL508 (file No. E41515)/CSA C22.2 No.14 (file No. LR31928)

Coil rating	Contact rating
3 to 100 VDC	15 A, 125 VAC 10 A, 250 VAC 10 A, 30 VDC (resistive load only)

# Engineering Data

## Maximum Switching Power

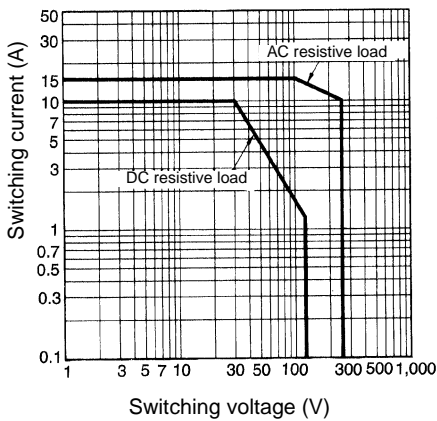

## Electrical Life Expectancy

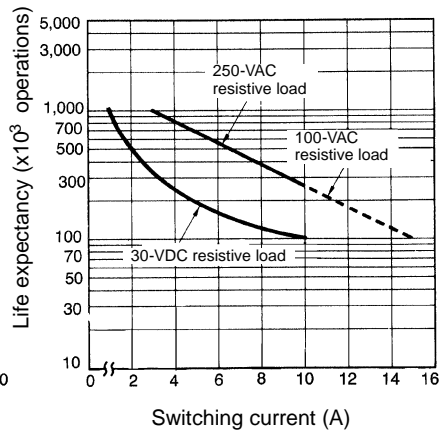

## Ambient Temperature vs. Maximum Coil Voltage

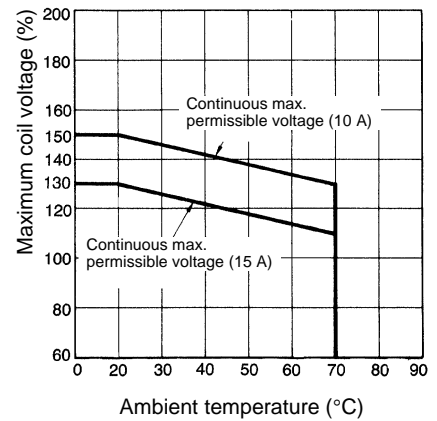

**Note:** The maximum coil voltage refers to the maximum value in a varying range of operating power voltage, not a continuous voltage.

# Dimensions

- Note:** 1. All units are in millimeters unless otherwise indicated.  
 2. Orientation marks are indicated as follows:

### G5C(E)-1

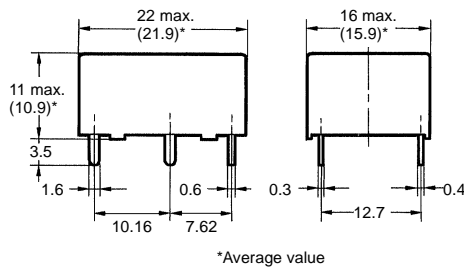
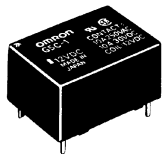

### Terminal Arrangement/Internal Connections (Bottom View)

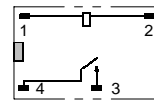

### Mounting Holes (PCB)

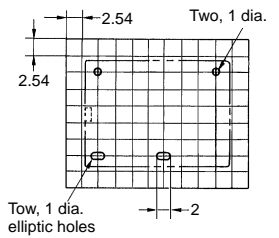

### G5CE-1-TP

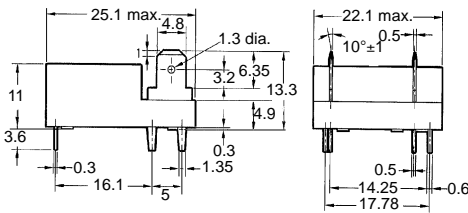
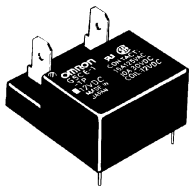

### Terminal Arrangement/Internal Connections

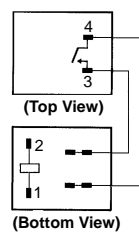

### Mounting Holes (Bottom View)

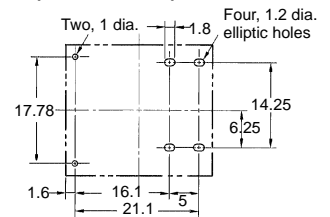

## Precautions

### Quick-connect Terminals

The quick-connect terminals can be connected to an appropriate load. Consult your OMRON representative, however, when you intend to impose voltage on the quick-connect terminals mounted on a PCB.

The terminals are compatible to the Fasten receptacle #187 positive block connector.

The portion marked with oblique lines includes the charged terminals of the power relay. When you mount the power relay on a PCB, make sure any unnecessary metal patterns on the PCB are kept away from this portion.

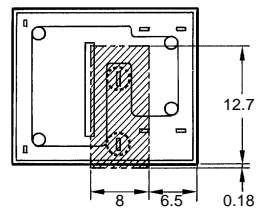

**ALL DIMENSIONS SHOWN ARE IN MILLIMETERS.**

To convert millimeters into inches, multiply by 0.03937. To convert grams into ounces, multiply by 0.03527.