

OMRON

Vision Sensor

FQ

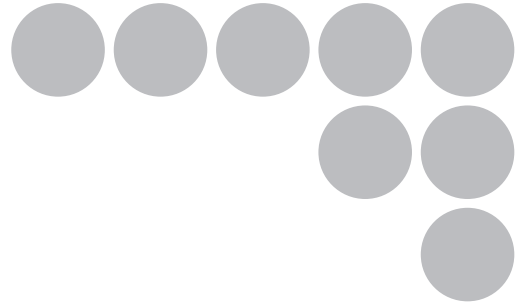

User's Manual



Cat. No. Z302-E1-03

User's Manual

APPLICATION CONSIDERATIONS
(Please Read)

Introduction

1

Installation and Connections

2

Taking Images

3

Setting Up Inspections

4

Testing and Saving Settings

5

Operation

6

Convenient Functions

7

Communications with External Devices

8

Troubleshooting

9

Appendices

10

Vision Sensor

FQ

READ AND UNDERSTAND THIS DOCUMENT

Please read and understand this document before using the products. Please consult your OMRON representative if you have any questions or comments.

WARRANTY

OMRON's exclusive warranty is that the products are free from defects in materials and workmanship for a period of one year (or other period if specified) from date of sale by OMRON.

OMRON MAKES NO WARRANTY OR REPRESENTATION, EXPRESS OR IMPLIED, REGARDING NON-INFRINGEMENT, MERCHANTABILITY, OR FITNESS FOR PARTICULAR PURPOSE OF THE PRODUCTS. ANY BUYER OR USER ACKNOWLEDGES THAT THE BUYER OR USER ALONE HAS DETERMINED THAT THE PRODUCTS WILL SUITABLY MEET THE REQUIREMENTS OF THEIR INTENDED USE. OMRON DISCLAIMS ALL OTHER WARRANTIES, EXPRESS OR IMPLIED.

LIMITATIONS OF LIABILITY

OMRON SHALL NOT BE RESPONSIBLE FOR SPECIAL, INDIRECT, OR CONSEQUENTIAL DAMAGES, LOSS OF PROFITS OR COMMERCIAL LOSS IN ANY WAY CONNECTED WITH THE PRODUCTS, WHETHER SUCH CLAIM IS BASED ON CONTRACT, WARRANTY, NEGLIGENCE, OR STRICT LIABILITY.

In no event shall responsibility of OMRON for any act exceed the individual price of the product on which liability is asserted.

IN NO EVENT SHALL OMRON BE RESPONSIBLE FOR WARRANTY, REPAIR, OR OTHER CLAIMS REGARDING THE PRODUCTS UNLESS OMRON'S ANALYSIS CONFIRMS THAT THE PRODUCTS WERE PROPERLY HANDLED, STORED, INSTALLED, AND MAINTAINED AND NOT SUBJECT TO CONTAMINATION, ABUSE, MISUSE, OR INAPPROPRIATE MODIFICATION OR REPAIR.

SUITABILITY FOR USE

THE PRODUCTS CONTAINED IN THIS DOCUMENT ARE NOT SAFETY RATED. THEY ARE NOT DESIGNED OR RATED FOR ENSURING SAFETY OF PERSONS, AND SHOULD NOT BE RELIED UPON AS A SAFETY COMPONENT OR PROTECTIVE DEVICE FOR SUCH PURPOSES.

Please refer to separate catalogs for OMRON's safety rated products.

OMRON shall not be responsible for conformity with any standards, codes, or regulations that apply to the combination of products in the customer's application or use of the product.

At the customer's request, OMRON will provide applicable third party certification documents identifying ratings and limitations of use that apply to the products. This information by itself is not sufficient for a complete determination of the suitability of the products in combination with the end product, machine, system, or other application or use.

The following are some examples of applications for which particular attention must be given. This is not intended to be an exhaustive list of all possible uses of the products, nor is it intended to imply that the uses listed may be suitable for the products:

- Outdoor use, uses involving potential chemical contamination or electrical interference, or conditions or uses not described in this document.

- Nuclear energy control systems, combustion systems, railroad systems, aviation systems, medical equipment, amusement machines, vehicles, safety equipment, and installations subject to separate industry or government regulations.
- Systems, machines, and equipment that could present a risk to life or property.

Please know and observe all prohibitions of use applicable to the products.

NEVER USE THE PRODUCTS FOR AN APPLICATION INVOLVING SERIOUS RISK TO LIFE OR PROPERTY WITHOUT ENSURING THAT THE SYSTEM AS A WHOLE HAS BEEN DESIGNED TO ADDRESS THE RISKS, AND THAT THE OMRON PRODUCT IS PROPERLY RATED AND INSTALLED FOR THE INTENDED USE WITHIN THE OVERALL EQUIPMENT OR SYSTEM.

PERFORMANCE DATA

Performance data given in this document is provided as a guide for the user in determining suitability and does not constitute a warranty. It may represent the result of OMRON's test conditions, and the users must correlate it to actual application requirements. Actual performance is subject to the OMRON Warranty and Limitations of Liability.

CHANGE IN SPECIFICATIONS

Product specifications and accessories may be changed at any time based on improvements and other reasons.

It is our practice to change model numbers when published ratings or features are changed, or when significant construction changes are made. However, some specifications of the product may be changed without any notice. When in doubt, special model numbers may be assigned to fix or establish key specifications for your application on your request. Please consult with your OMRON representative at any time to confirm actual specifications of purchased products.

DIMENSIONS AND WEIGHTS

Dimensions and weights are nominal and are not to be used for manufacturing purposes, even when tolerances are shown.

ERRORS AND OMISSIONS

The information in this document has been carefully checked and is believed to be accurate; however, no responsibility is assumed for clerical, typographical, or proofreading errors, or omissions.

PROGRAMMABLE PRODUCTS

OMRON shall not be responsible for the user's programming of a programmable product, or any consequence thereof.

COPYRIGHT AND COPY PERMISSION

This document shall not be copied for sales or promotions without permission.

This document is protected by copyright and is intended solely for use in conjunction with the product. Please notify us before copying or reproducing this document in any manner, for any other purpose. If copying or transmitting this document to another, please copy or transmit it in its entirety.

Meanings of Signal Words

The following signal words are used in this manual.



Indicates a potentially hazardous situation which, if not avoided, will result in minor or moderate injury, or may result in serious injury or death. Additionally there may be significant property damage.

Meanings of Alert Symbols

The following alert symbols are used in this manual

	Indicates general prohibitions for which there is no specific symbol.
	Indicates the possibility of laser radiation.
	Indicates the possibility of explosion under specific conditions.
	Indicates prohibition when there is a risk of minor injury from electrical shock or other source if the product is disassembled.



This product is not designed or rated for ensuring safety of persons.
Do not use it for such purposes.



The Sensor emits visible light, which may adversely affect the eyes in rare instances.
Do not look directly into the light emitted from the Sensor. When the subject is a specular reflective object, protect your eyes from reflected light.



A lithium ion battery is built into the Touch Finder and may occasionally combust, explode, or burn if not treated properly.
Dispose of the Touch Finder as industrial waste, and never disassemble, apply pressure that would deform, heat to 100 °C or higher, or incinerate the Touch Finder.



High-voltage parts inside; danger of electrical shock. Do not open the product cover.



Precautions for Safe Use

The following points are important to ensure safety, so make sure that they are strictly observed.

1. Installation Environment

- Do not use the product in environments where it can be exposed to inflammable/explosive gas.
- To secure the safety of operation and maintenance, do not install the product close to high-voltage devices and power devices.
- Install the product in such a way that its ventilation holes are not blocked.
- Tighten mounting screws at the torque specified in this manual.

2. Power Supply and Wiring

- The power supply voltage must be within the rated range (24 VDC \pm 10%), and an AC voltage must not be used.
- Reverse connection of the power supply is not allowed. Do not short the load of the open collector output.
- The load must be within the rated range.
- High-voltage lines and power lines must be wired separately from this product. Wiring them together or placing them in the same duct may cause induction, resulting in malfunction or damage.
- Use the products within the power supply voltages specified in this manual.
- Use the specified size of crimp terminals to wire connections. Do not connect wires that have been simply twisted together directly to the power supply or terminal block.
- Use a DC power supply with safety measures against high voltages (safety extra low-voltage circuit).
- Use independent power sources for the products. Do not use a shared power source.
- Tighten mounting screws at the torque specified in this manual.
- Always turn OFF the power supply before connecting or disconnecting cables or the power supply wiring.

3. Battery

- Do not short the positive and negative terminals of the Battery.
- Do not use the Touch Finder in an environment that exceeds the operating temperature range of the Battery. If the Touch Finder is used at temperatures that exceed the operating temperature range, the protective device may activate and prevent charging.
- Do not connect the Battery directly to a power supply or car cigarette lighter socket.
- Do not use the Touch Finder with any other type of battery.
- Turn OFF the power supply immediately if the Battery leaks or produces an odor. Electrolyte leaked from the Battery may ignite, possibly causing smoke, rupture, or fire.
- If during usage, charging, or storage, the Battery produces an odor, heats, becomes discolored, becomes misshapen, or exhibits any other unusual conditions, remove it and do not use it. Continuing to use such a Battery may result in the Battery heating, smoking, rupturing, or igniting.
- If the Touch Finder (FQ-D31) will be installed permanently or semi-permanently, remove the Battery (FQ-BAT1). If the rated temperature is exceeded with the Battery inserted, the protective circuit may activate and stop the Touch Finder.

4. AC Adapter

- Use an AC cable that is suitable for the power supply and power voltage you are using.
- Do not touch the power plug with a wet hand. Doing so may result in electrical shock.
- If you notice an abnormal condition, such as smoke, abnormal heating of the outer surface, or a strange odor, immediately stop using the AC Adapter, turn OFF the power, and remove the power plug from the outlet.
Consult your dealer, as it is dangerous to attempt to repair the AC Adapter yourself.
- If the AC Adapter is dropped or damaged, turn OFF the power, remove the power plug from the outlet, and contact your dealer. There is a risk of fire if you continue using the AC Adapter.

5. Other

- Do not use this product in safety circuits associated with nuclear power and human life.
- Do not disassemble, repair, modify, deform by pressure, or incinerate this product.
- Dispose of this product as industrial waste.
- Connect the special products (Sensor, Touch Finder, Cables). The product might break down or malfunction if you use a part not included in the special products.
- If you notice an abnormal condition, such as a strange odor, extreme heating of any product, or smoke, immediately stop using the product, turn OFF the power, and consult your dealer.
- The Sensor surfaces become hot during use. Do not touch them.
- Do not drop or subject the products to shock.
- Use the special Sensor (FQ-S), Touch Finder (FQ-D), Cables (FQ-WN and FQ-WD), Battery (FQ-BAT1), and AC Adapter (FQ-AC). Using other than the specified products may cause fire, burning, malfunction or failure.
- If the product has a lock mechanism, always make sure it is locked before using the product.

6. Laws and Regulations, Standards

- This product complies with the following EC Directives and EN Standards:
EC Directive No.2004/104/EC
EN Standards EN61326

Precautions for Correct Use

Observe the following precautions to prevent failure to operate, malfunctions, or undesirable effects on product performance.

1. Installation Site

Do not install this product in locations subjected to the following conditions:

- Ambient temperature outside the rating
- Rapid temperature fluctuations (causing condensation)
- Relative humidity outside the range of 35 to 85%
- Direct vibration or shock
- Strong ambient light (such as other laser beams, light from arc-welding machines, or ultraviolet light)
- Direct sunlight or near heaters
- Strong magnetic or electric field

Also, do not install this product in locations subjected to the following conditions to ensure its protective performance as described in the specifications:

- Presence of corrosive or flammable gases
- Presence of dust, salt, or iron particles
- Water, oil, or chemical fumes or spray, or mist atmospheres

2. Power Supply, Connection, and Wiring

- When using a commercially available switching regulator, make sure that the FG terminal is grounded.
- If surge currents are present in the power lines, connect surge absorbers that suit the operating environment.
- Before turning ON the power after the product is connected, make sure that the power supply voltage is correct, there are no incorrect connections (e.g. load short-circuit) and the load current is appropriate. Incorrect wiring may result in breakdown of the product.
- For cables, use only the special products specified in this manual.

 p.197, p.198

- Use only combinations of the Sensor and Touch Finder specified in this manual. Using other combinations may cause malfunction or damage.
- Do not turn the power OFF in the following instances. Doing so will damage data that is in the process of being saved.
 - While data is being saved in internal memory
 - While data is being saved on the SD card
- The LCD panel has been made using precision technology, and sometimes a few pixels are missing in the panel. This is due to the structure of the LCD panel, and is not a malfunction.
- Connector cover
Always attach the covers of I/O cable connector and Ethernet cable connector. This prevents extraneous material from making malfunction of the Sensor.

3. Battery

- Do not use or charge the Battery with other than the specified products.
- Do not charge the Battery with other than the specified AC adapter.
- When using the Touch Finder, the battery cover screw must be tightened.

4. AC Adapter

- During maintenance and when not using the Touch Finder for an extended time, remove the power plug from the outlet.
- Do not bend the power cable past its natural bending radius.
- Do not use the AC Adapter with other than the specified products.
- If a voltage higher than 380 V is applied, there is a risk that the capacitor will be damaged, the pressure valve will open, and vaporized gas will be emitted. If there is a possibility that a voltage higher than 380 V will be applied, use a protective device.

5. Maintenance and Inspection

Do not use thinner, benzene, acetone or kerosene to clean the Sensor and Touch Finder. If large dust particles adhere to the Camera, use a blower brush (used to clean camera lenses) to blow them off. Do not use breath from your mouth to blow the dust off. To remove dust particles from the Camera, wipe gently with a soft cloth (for cleaning lenses) moistened with a small amount of alcohol. Do not use excessive force to wipe off dust particles. Scratches to the Camera might cause error.

Editor's Note

■ Meaning of Symbols

Menu items that are displayed on the Touch Finder LCD screen, and windows, dialog boxes and other GUI elements displayed on the PC are indicated enclosed by brackets "[]".

■ Visual Aids

Important

Indicates points that are important to achieve the full product performance, such as operational precautions.

Note

Indicates application procedures.



Indicates pages where related information can be found.

Table of Contents

1. Introduction

1-1 FQ-series Vision Sensors	14
1-2 Measurement Process	15
1-3 Startup Display and Display Elements	16
1-4 Basic Operational Flow	18

2. Installation and Connections

2-1 System Configuration	20
2-2 Part Names and Functions	21
2-3 Installation	23
2-4 Wiring	28
2-5 Setting Up Ethernet	33

3. Taking Images

3-1 Selecting a Sensor for Configuration	36
3-2 Adjusting Image Quality	37
3-3 Adjusting the Object Position	42
3-4 Preventing Mutual Interference of Multiple Sensors	46

4. Setting Up Inspections

4-1 Inspection Item Selection Guide	48
4-2 Setup Procedure for Inspection Items	49
4-3 Configuring Inspection Items	50
4-4 Inspecting with the Search Inspection Item	52
4-5 Inspecting with the Edge Position Inspection Item	59
4-6 Inspecting with the Edge Width Inspection Item	64
4-7 Inspecting with the Area Inspection Item	68
4-8 Inspecting with Color Data Inspection Item	72
4-9 Calculations and Judgements Using Inspection Item Data	75

5. Testing and Saving Settings

5-1 Performing Test Measurements.....	86
5-2 Shortening the Measurement Takt Time.....	88
5-3 Adjusting the Judgement Parameters.....	89
5-4 Checking a List of All Inspection Item Results	91
5-5 Saving Data to the Sensor	92

6. Operation

6-1 Starting Operation.....	94
6-2 Configuring the Run Mode Display	96
6-3 Checking the Trend of Measurement Results with Graphs	98
6-4 Adjusting Judgement Parameters during Operation.....	101

7. Convenient Functions

7-1 Changing the Scene to Change the Line Process	104
7-2 Display Functions	106
7-3 Monitoring the Signal I/O Status	109
7-4 Logging Measurement Data and Image Data	110
7-5 Saving Sensor Settings	117
7-6 SD Card Operations	118
7-7 Convenient Functions for Operation.....	120
7-8 Convenient Functions for Setup	122
7-9 Functions Related to the System.....	123

8. Communications with External Devices

8-1 Controlling/Outputting in Parallel	126
8-2 Outputting/Controlling with Ethernet	142

9. Troubleshooting

9-1 Error Table.....	168
9-2 Basic Troubleshooting	170

10. Appendices

10-1 Menu Tables.....	172
10-2 External Reference Parameters.....	183
10-3 Specifications and Dimensions.....	188
10-4 Updating the Software.....	199
10-5 LED Safety.....	200
10-6 Requirements from Regulations and Standards.....	201
Index.....	206
Version Upgrade Information.....	211
Revision History.....	212

Introduction

1-1 FQ-series Vision Sensors	14
1-2 Measurement Process	15
1-3 Startup Display and Display Elements	16
1-4 Basic Operational Flow	18

1-1 FQ-series Vision Sensors

FQ-series Vision Sensors are real-color Vision Sensors with integrated processing. Once configured, they are used stand-alone for quality inspection of presence, position, and other product characteristics. To set up or monitor the sensors, either the touch screen based console 'Touch Finder' or a 'PC Tool' can be used.

FQ Vision Sensor

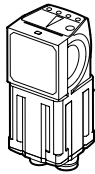

Includes the camera, lighting, measurement processor, and I/O functions. After the Sensor has been set up, it can be operated alone to perform measurements without the Touch Finder or PC Tool.

Setup, Image Confirmation, and Logging Tools

Touch Finder

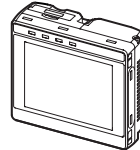

Used to check images and set the judgement parameters. It can also be used to save measurement results and check status during operation.

PC Tool



The same functions as those that are provided by the Touch Finder can be performed from a computer. The PC Tool is available free of charge.

FQ-series Vision Sensors are available in two different models. The differences are given in the following table.

Model	Standard model	Single-function model
Model number	FQ-S2□□□□□□	FQ-S1□□□□□□
Number of simultaneous measurements	32	1
Number of registered scenes	32	8
Position compensation	Supported	Not supported

1-2 Measurement Process

This section describes the basic flow of the measurement process.

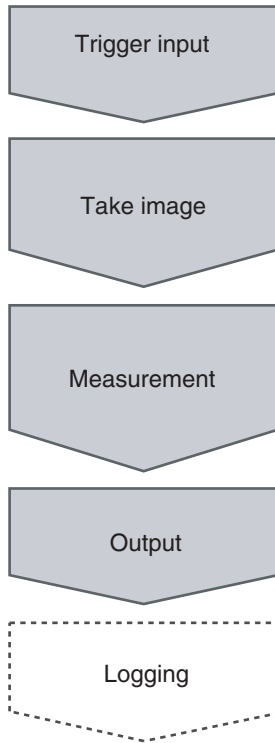

- The measurement is started by inputting a trigger signal from an external device.
- Images are taken according to the trigger.
- The image is measured to see if it matches the configured settings.
- You can also perform calculations based on the measurement results from inspection items.
- The overall judgement of all inspection items are output using OR logic.
- You can output detailed measurement results from the inspection items. (An Ethernet connection is required.)
- Measurement data and image data can be logged in memory in the Sensor or in an SD card.

1-3 Startup Display and Display Elements

Startup Display

- 1 The Sensor is automatically detected by the Touch Finder when power supply to the Sensor and Touch Finder is turned ON.**

The Auto Connect Display will appear if the Sensor cannot be detected. Check that cables are connected correctly to the Sensor and Touch Finder, and then press [Auto connect].



Note

If the Sensor is still not detected after pressing [Auto Connect], refer to the following information.

 The Sensor cannot be detected: p. 170

- 2 When the Sensor is detected, the following display will appear.**

- The Setup Mode will appear if a Sensor that has not been set up is connected.

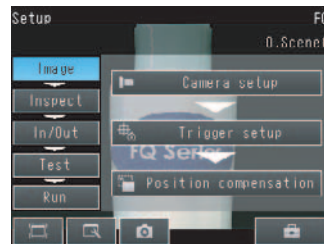

- The Run Mode will appear if a Sensor that has been set up is connected.



Note

When the Touch Finder is started, IP addresses are automatically set for each Sensor. To allocate specific IP addresses, set the IP address of each Sensor and the Touch Finder.

 Setting Up Ethernet: p. 33

Display Elements

This Sensor has a Setup Mode and a Run Mode.
Refer to the following information for menu items.

 p. 172

Setup Mode

In Setup Mode, you can set the image conditions, judgement parameters, and I/O settings for the Sensor.

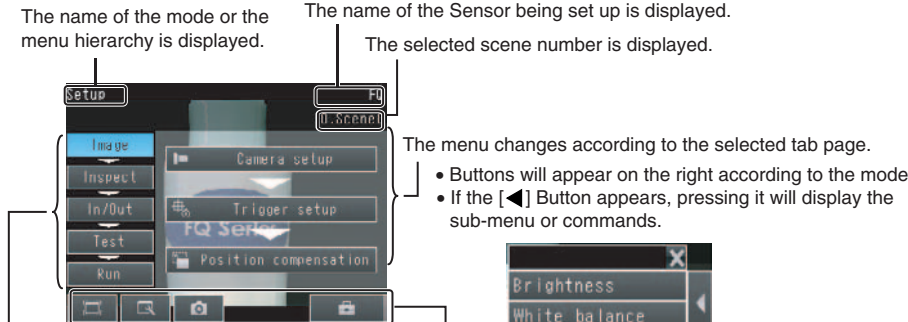

The name of the mode or the menu hierarchy is displayed.

The name of the Sensor being set up is displayed.

The selected scene number is displayed.







The menu changes according to the selected tab page.

- Buttons will appear on the right according to the mode.
- If the [◀] Button appears, pressing it will display the sub-menu or commands.

The setup flow is shown by these five tabs.

[Image]: Used to adjust the image.
[Inspect]: Used to set the inspection items.
[In/Out]: Used to set the I/O.
[Test]: Used to test and adjust the set measurements.
[Run]: Used to switch to Run Mode.

This button menu is always displayed.

-  Only-image Button: Used to select either displaying the camera image and messages, or only the camera image.
-  Display Button: Used to select the source of the image or to zoom the image.
 Display Functions: p. 106
-  Capture Button: Used to capture the current screen to the SD card.
 p. 121
-  Tool Button: Used to call functions, such as saving data or select scenes.

Note

The Display Button can be used to switch between the following images.

- Live: The live image is displayed.
- Freeze: The image that was taken last is displayed.
- Log: An image saved in internal memory is displayed.
- File: An image saved on an SD card is displayed.

Run Mode

In Run Mode, measurements are performed, and measurement results are output.

 p. 93

1-4 Basic Operational Flow

The following flow shows the basic operation of FQ-series Vision Sensors.

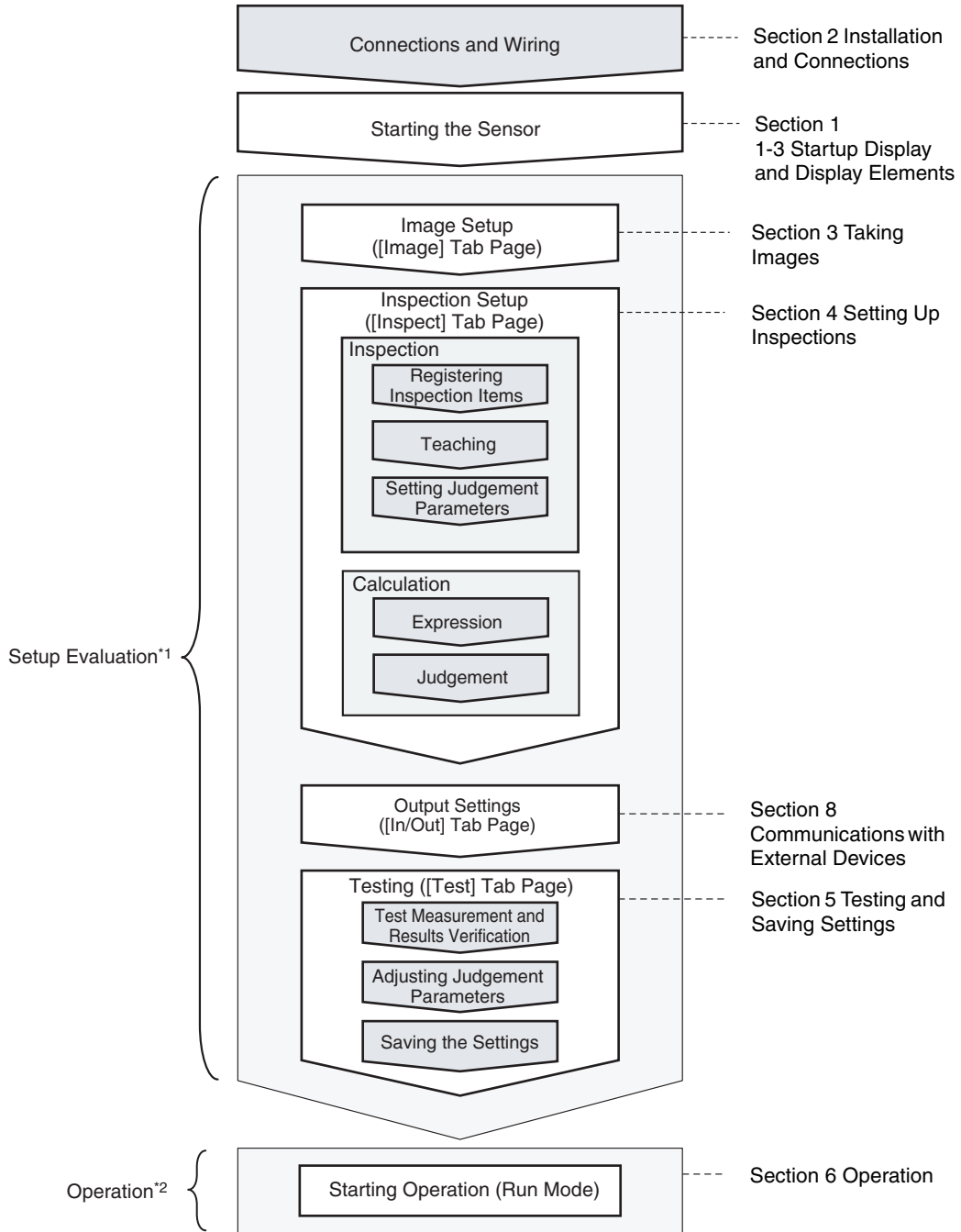

*1: In Setup Mode, the Sensor can be set up and adjusted, but it does not output signals on the I/O lines.

*2: In Run Mode, the Sensor performs measurements and outputs signals on the I/O lines.

Installation and Connections

2-1 System Configuration	20
2-2 Part Names and Functions	21
2-3 Installation	23
2-4 Wiring	28
2-5 Setting Up Ethernet	33

2-1 System Configuration

Parallel Interface Connection

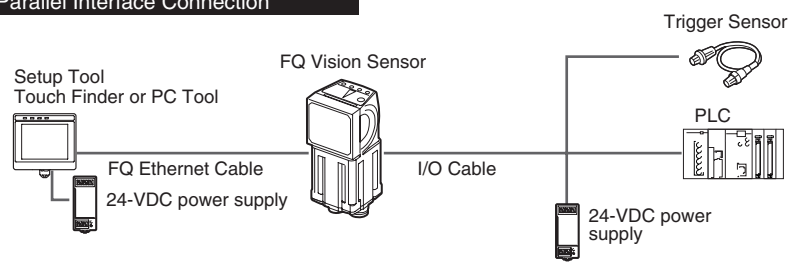

Connecting to Ethernet

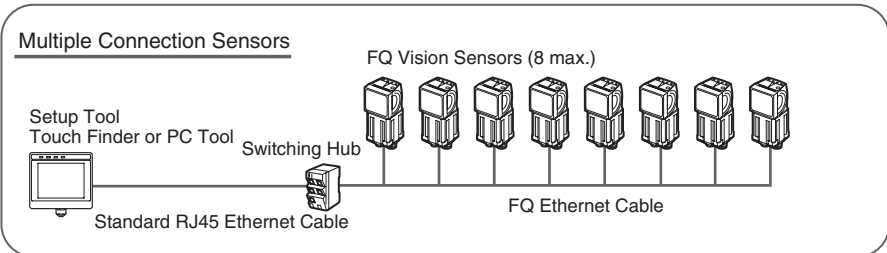
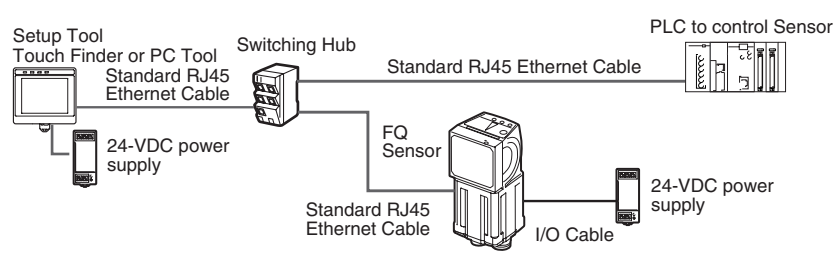

Product	Model number	Remarks
FQ Vision Sensor	FQ-S□□□□□□	This is the Vision Sensor.
Touch Finder	FQ-D□□	This is a setup console.
PC Tool	---	The PC Tool can be used instead of the Touch Finder. If you register as a member, you can download the free PC Tool as a special service to purchasers. Refer to the <i>Member Registration Sheet</i> that is enclosed with the Sensor for the member registration procedure and the download procedure for special member software.
FQ Ethernet Cable	FQ-WN0□□	Connects the Sensors to external devices such as the Touch Finder, computers, and PLCs.
Standard RJ45 Ethernet Cable ^{*1}	---	Connects the Switching Hub to the Touch Finder, computers, and PLCs. Use a connector that complies with the FCC RJ45 standard. (STP (shielded twisted-pair) cable, category 5e or 6, impedance: 100 Ω)
I/O Cable	FQ-WD0□□	Connects the Sensor to the power supply and external devices.
Switching Hub	W4S1-0□□	Used to connect multiple Sensors to one Touch Finder or PC Tool.

*1: The shape and dimensions of the Ethernet connector plug and jack are specified in ISO/IEC8877:1992 (JIS X 5110:1996) and RJ-45 of the FCC regulations. To prevent connector connection failures, the structure of the jack of this product does not allow insertion of plugs that do not comply with the standard. If a commercially available plug cannot be inserted, it is likely that the plug is non-compliant.

Important

Do not connect network devices other than PLCs on the same network as the Touch Finder or computer. If another device is connected, the responsiveness of displays and settings of the Touch Finder or computer may become slow.

2-2 Part Names and Functions

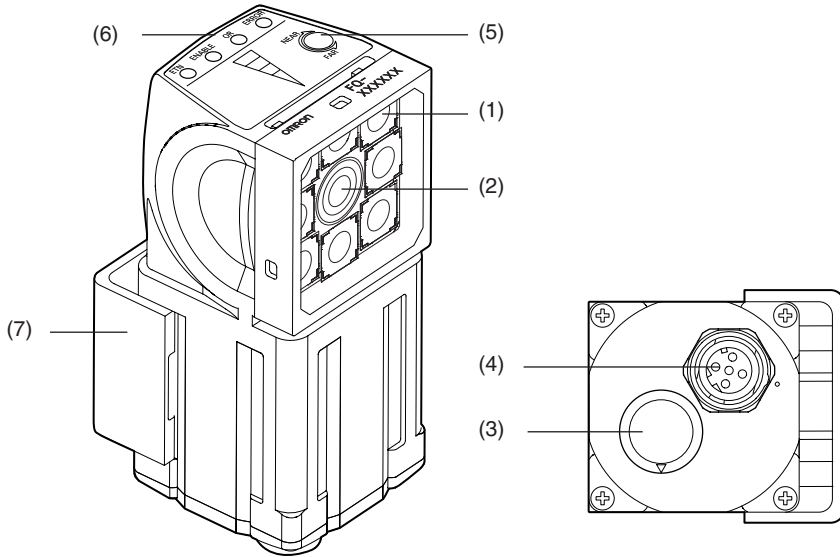

FQ Vision Sensor

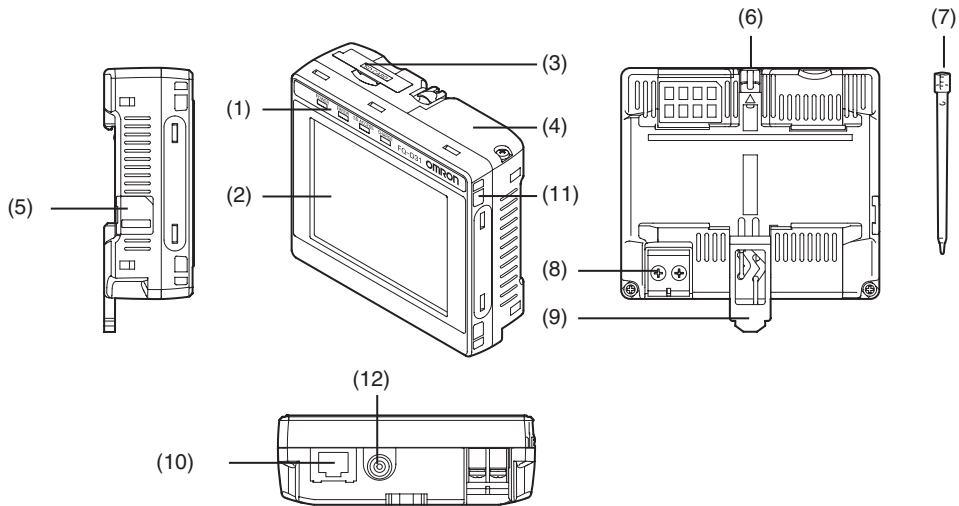

No.	Name	Description	
(1)	Lighting	LEDs for illumination	
(2)	Camera lens	This lens can be focused.	
(3)	I/O Cable connector	An I/O Cable is used to connect the Sensor to the power supply and external I/O.	
(4)	Ethernet cable connector	An Ethernet cable is used to connect the Sensor to external devices such as PLCs, the Touch Finder, or computers.	
(5)	Focus adjustment screw	Used to adjust the focus of the image.	
(6)	Operation indicators	OR	Lights orange when the OR output signal turns ON.
		ETN	Lights orange during Ethernet communications.
		ERROR	Lights red when an error occurs.  9-1 Error Table p. 168.
		BUSY	Lights green when the Sensor is executing a process.
(7)	Mounting Bracket	Used to mount the Sensor. The Mounting Bracket can be attached to the front, left side, right side, or back of the Sensor.	

Touch Finder



No.	Name	Description
(1)	Operation indicators	POWER Lights green when the Touch Finder is turned ON.
		ERROR Lights red when an error occurs.  9-1 Error Table p. 168.
		SD ACCESS Lights yellow when an SD card is inserted. Flashes yellow when the SD card is being accessed.
		CHARGE* ¹ Lights orange when the Battery is charging.
(2)	LCD/touch panel	Displays the setting menu, measurement results, and images input by the camera.
(3)	SD card slot	An SD card can be inserted.
(4)	Battery cover* ¹	The Battery is inserted behind this cover. Remove the cover when mounting or removing the Battery.
(5)	Power supply switch	Used to turn the Touch Finder ON and OFF.
(6)	Touch pen holder	The touch pen can be stored here when it is not being used.
(7)	Touch pen	Used to operate the touch panel.
(8)	DC power supply connector	Used to connect a DC power supply.  p. 30
(9)	Slider	Used to mount the Touch Finder to a DIN Track.
(10)	Ethernet port	Used when connecting the Touch Finder to the Sensor with an Ethernet cable. Insert the connector until it locks in place.
(11)	Strap holder	This is a holder for attaching the strap.
(12)	AC power supply connector* ¹	Used to connect the AC adapter.

*1: Applicable to the FQ-D31 only.

2-3 Installation

Installing the Sensor

Installation Procedure

- 1** Align the tabs on one side of the Mounting Bracket with the slot on the Sensor.
The FQ-XL Mounting Bracket can be attached to the back, side, or front of the Sensor.
- 2** Press the Mounting Bracket onto the Sensor until the other tabs click into place.
- 3** Use the following optical charts to check the field of view and installation distance of the Sensor so that it is mounted at the correct position.
Tightening torque (M4): 1.2 N·m

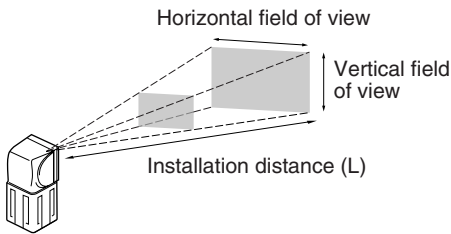
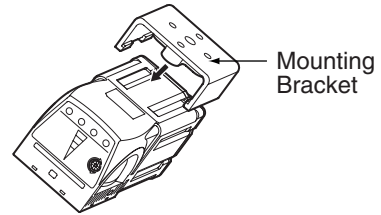

The optical chart indicates the horizontal field of view. The vertical field of view will be approximately 60% of the horizontal field of view.

Note: The tolerance is $\pm 10\%$.

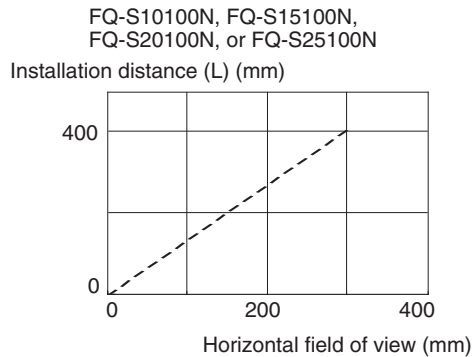
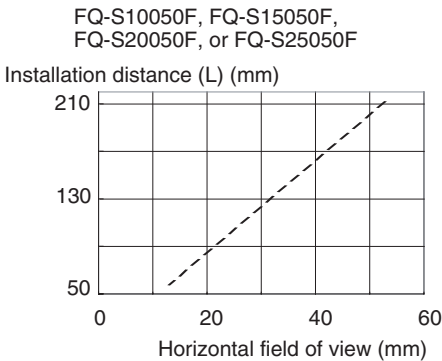
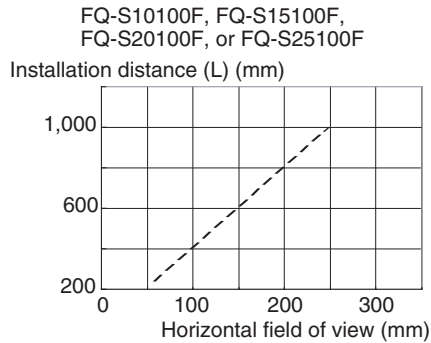
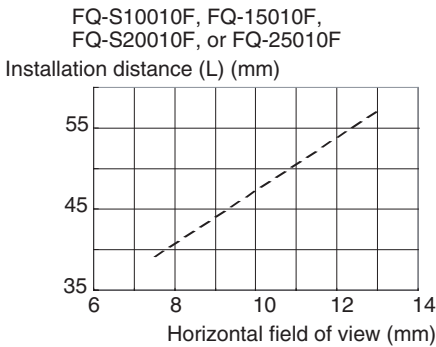

Important

- There is a certain amount of deviation among Sensors in the center of the optical axis. For this reason, when installing the Sensor, check the center of the image and the field of view on the LCD monitor of the Touch Finder and in the PC Tool.

Removal Procedure

- 1 Insert a flat-blade screwdriver between the Mounting Bracket and the Sensor case on either side and remove the Mounting Bracket.

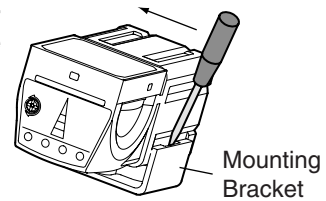

Installing the Touch Finder

Installation Precautions

Install the Touch Finder in the following orientation to allow sufficient heat dissipation.



Do not mount it in the following orientations.

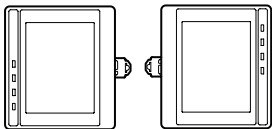

Important

- To improve ventilation, leave space on both sides of the Touch Finder. The distance between the Touch Finder and other devices should be at least that shown in the following diagram.

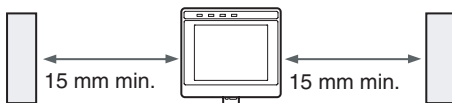

- Make sure that the ambient temperature is 50°C or lower. If it exceeds 50°C, install a cooling fan or an air conditioner and maintain the temperature at 50°C or lower.
- To prevent interference by noise, do not mount the Sensor on panels which contain high-voltage devices.
- To keep the level of noise from the surrounding environment to a minimum, install the Sensor and Touch Finder at least 10 m away from power lines.

Mounting to DIN Track

Installation Procedure

- 1** Press the slider on the Touch Finder to the top.
- 2** Hook the clip at the top of the Touch Finder on to the DIN Track.
- 3** Press the Touch Finder onto the DIN Track until the bottom clip clicks into place.

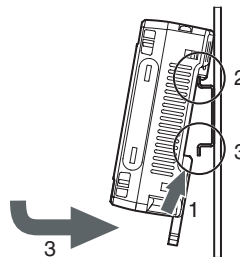

Important

- Attach End Plates (sold separately) on the sides of the Touch Finder on the DIN Track.
- If other devices will be installed next to the Touch Finder on the same DIN Track, make sure that sufficient space is kept between the devices as indicated on previous page.
- Always hook the clip at the top of the Touch Finder on the DIN Track first. If the lower clip is hooked on first, the Touch Finder will not be mounted very securely.

Removal Procedure

- 1** Pull down on the slider on the Touch Finder.
- 2** Lift the Touch Finder at the bottom and remove it from the DIN Track.

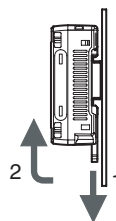

Mounting to a Control Panel

The Touch Finder can be mounted on a panel using the FQ-XPM Panel Mounting Adapter.

Important

- Always turn OFF the Touch Finder power before attaching or detaching the Panel Mount Adapter. Attaching or detaching with the power turned ON may cause a failure.

- 1** Set the Touch Finder in the Panel Mount Adapter.

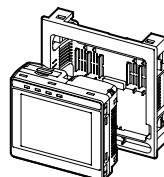

2 Press the slider up on the Touch Finder.

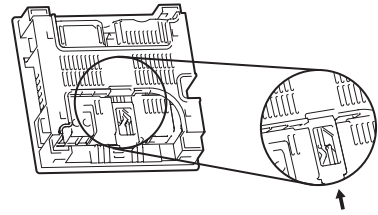

3 Create holes in the panel for mounting.
Refer to the following page for hole dimensions.

 p. 195

4 Connect the cable to the Touch Finder.

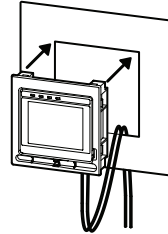

5 Mount the Touch Finder with the Panel Mount Adapter from the front of the panel.

6 Hook the hooks on the Mounting Bracket in the four holes of the Panel Mount Adapter and secure them with screws. (Tightening torque: 1.2 N·m)

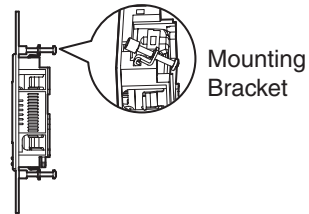

7 Check that the Touch Finder is attached properly to the Panel.

Using the Touch Finder as a Portable Device (with Battery)

The Touch Finder with a Battery can be used as a portable device. Use the strap when carrying it to prevent dropping it.

There are two types of straps (FQ-XH, sold separately), a Neck Strap and a Hand Strap.

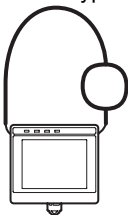

Neck Strap

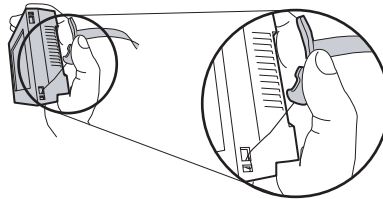

Hand Strap

1 Attach the Mini-strap to the Touch Finder.

There are a total of four holes for attaching the Mini-strap on the left and on the right of the Touch Finder.

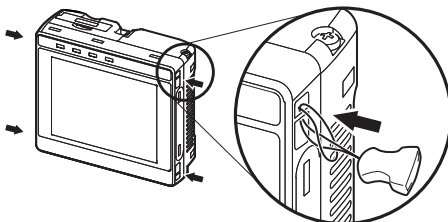

2 Connect the Neck Strap or Hand Strap to the Mini-strap.

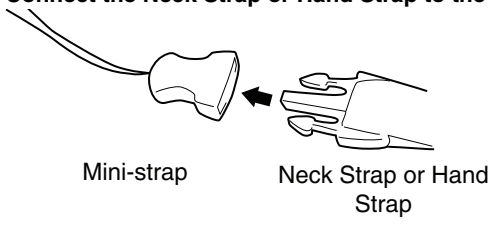

2-4 Wiring

Wiring the Sensor

Connect the I/O Cable to the I/O Cable connector located at the bottom of the Sensor.

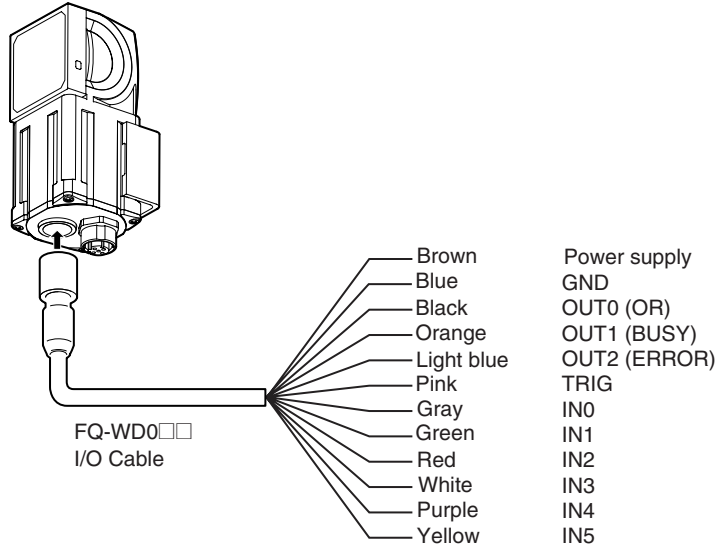

Important

Cut off lines that are not required so that they do not come into contact with the other signal lines.

Classification	Signal	Application
Power supply	Power supply (24 V)	<p>These terminals are for the external power supply (24 V).</p> <p>Important Wire the power supply separately from other devices. If the wiring for other devices is placed together or in the same duct as the wiring for the Vision Sensor, the influences of electromagnetic induction may cause the Sensor to malfunction or may damage it.</p>
	GND	
Inputs	TRIG	This terminal is the trigger signal input.
	IN0 to IN5	These are the command input terminals.
Outputs	OUT0 (OR)	By default, this is the OR output signal (overall judgement). The assignment can be changed to an individual judgement signal from OR0 to OR31.
	OUT1 (BUSY)	By default, this is the BUSY output signal. The assignment can be changed to an individual judgement signal from OR0 to OR31.
	OUT2 (ERROR)	By default, this is the ERROR output signal. The assignment can be changed to an individual judgement signal from OR0 to OR31.

Note

The assignments of I/O signals can be changed.

 Section 8 Communications with External Devices: p. 125

I/O Signal Circuit Diagrams

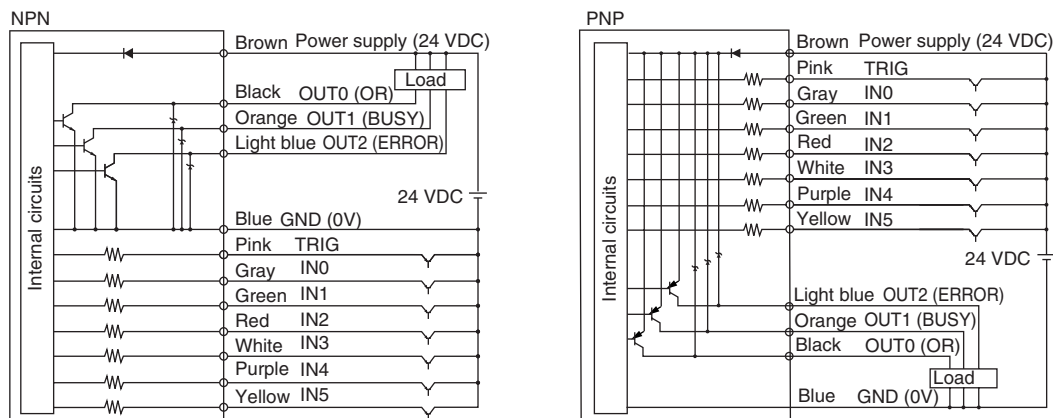

Important

Preventing Chattering

- The Sensor is equipped with an anti-chattering function, but if the chattering is 100 μ s or longer, a faulty input may occur. (Input signals of 99 μ s or shorter are ignored. Signals of 100 μ s or longer are treated as input signals.)
- Use no-contact output devices (e.g., SSR or PLC transistor output) for the input signals. If contacts (e.g., relay) are used, chattering may cause the trigger to be input again during execution of a measurement.

Power Supply Specifications When a Switching Regulator Is Connected

Use a power supply that meets the following specifications. (The power supply is sold separately.)

Item	Description
Power supply voltage	24 VDC (21.6 to 26.4 V)
Output current	3.75 A min.
Recommended Power Supply	S8VS-09024□ (24 VDC, 3.75 A)
External power supply terminal screws	M4 (tightening torque: 1.2 N·m)

Important

Supply power from a DC power supply for which measures have been applied to prevent high voltages (e.g., a safety extra low voltage circuit).

If UL certification is required for the overall system, use a UL Class II DC power supply.

Attaching the LED Warning Label

Attach the enclosed LED warning label to the cable or other location. The LED warning label must be attached to a location that is readily visible from the Sensor.

Attachment Example

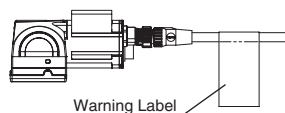

Warning Label

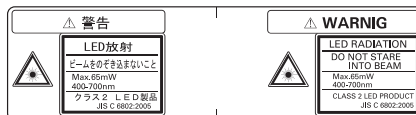

10-5 LED Safety p. 200

Wiring the Touch Finder

Power Supply Wiring

Connecting the Power Supply

- 1** Loosen the two terminal screws using a Phillips screwdriver.
- 2** Attach crimp terminals to the power lines. Secure the positive and negative lines as indicated using M3 screws.
Power supply tightening torque: 0.54 N·m
- 3** In environments where there is excessive noise, attach a ferrite core (ZCAT1730-0730 from TDK or the equivalent) to the power supply cable.

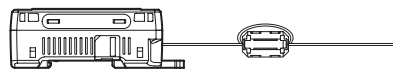
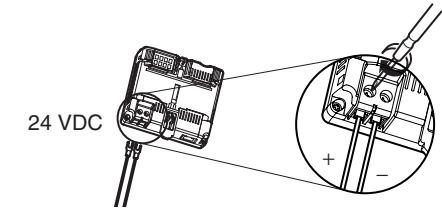

When you attach the ferrite core to the power supply cable, wrap the cable only one time.

Turning ON the Touch Finder

- 1** Remove the cover from the power switch on the left side of the Touch Finder.
- 2** Press the switch toward *ON*.

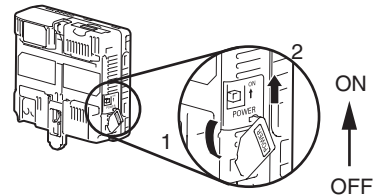

Power Supply Specifications

Use a power supply that meets the following specifications. (The power supply is sold separately.)

Item	Description
Power supply voltage	24 VDC (21.6 to 26.4 V)
Output current	0.65 A min.
Recommended Power Supply	S8VS-01524□ (24 VDC, 0.65 A)
External power supply terminal screws	M4 (tightening torque: 1.2 N·m)
Recommended power line wire size	AWG16 to AWG22 (length of 5 m max.)

Important

- Supply power from a DC power supply for which measures have been applied to prevent high voltages (e.g., a safety extra low voltage circuit).
If UL certification is required for the overall system, use a UL Class II DC power supply.
- When using the FQ-D31, do not connect a switching regulator and AC Adapter (FQ-AC□) at the same time.

Charging the Battery

This section describes how to charge and install the FQ-D31 Battery and provides applicable precautions.

Charge the Battery while it is attached to the Touch Finder.

Use the AC adapter to charge the battery.

Mounting the Battery in the Touch Finder

- 1 Remove the screw from the battery cover on the top of the Touch Finder, slide the cover in the direction of the arrow, and open the battery cover.**

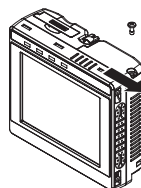

- 2 Face the rounded side of the battery toward the back of the Touch Finder and insert the battery.**

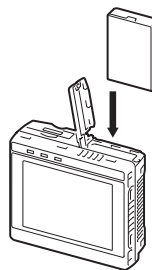

Important

Do not insert the battery in the wrong orientation.

- 3 Close the battery cover, slide the battery cover in the direction of the arrow, and tighten the screw on the battery cover.**

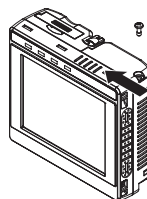

- 4 Attach the AC adapter to the Touch Finder to start charging the battery.**

The CHARGE indicator will be lit while the battery is being charged. It will go out when charging the battery has been completed.

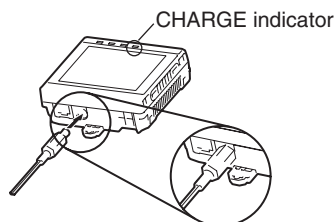

Note

The Touch Finder will operate even if the AC adapter is connected when no battery is mounted in the Touch Finder.

Important

- If the Touch Finder (FQ-D31) will be installed permanently or semi-permanently, remove the Battery (FQ-BAT1). If the rated temperature is exceeded with the Battery inserted, the protective circuit may activate and stop the Touch Finder.
- The battery complies with the following recycling regulation.

Japan



Li-ion00

EU



Taiwan



- California regulations concerning perchlorate:

This product is a lithium battery that contains perchlorate, which is regulated by the State of California. Please comply with these regulations. For details see the following URL:

www.dtsc.ca.gov/hazardouswaste/perchlorate/

2-5 Setting Up Ethernet

Connecting to Sensors from the Touch Finder

When the Sensor is used with a Touch Finder, IP addresses are automatically assigned. No settings are required to use Ethernet.

However, if a Sensor or Touch Finder is connected to a network where a PLC or computer is already connected, the Ethernet must be set to be compatible with the existing network.

- Sensor

▶  (Setup Mode) – [Sensor settings] – [Network] – [Ethernet]

- 1** Set [Auto connection] to [OFF].
- 2** Set the IP address and subnet mask according to the network settings.

- Touch Finder

▶  (Setup Mode) – [TF settings] – [Ethernet]

- 1** Set the IP address and subnet mask according to the network settings.

Connecting to Sensors from External Devices Such as PLCs

Set the IP address of the Sensor according to the network where the external devices, such as PLCs, are connected.

▶  (Setup Mode) – [Sensor settings] – [Network] – [Ethernet]

- 1** Set [Auto] to [OFF].
- 2** Set the IP address and subnet mask according to the network where the external devices, such as PLCs, are connected.

Note

If you connect OMRON CS/CJ-series PLCs to the Ethernet, the following default IP addresses are assigned to the PLCs.

- IP address: 192.168.250.*node_address*

Connecting to Sensors from a Computer Using the PC Tool

When connecting the Sensor directly to a computer using an Ethernet Cable, set the network settings on the computer as given below. Setting a fixed IP address is not required if there is a hub between the computer and Sensor and a DHCP server is used.

The following procedure is for Windows XP.

- 1** Select [Control Panel] from the Windows Start Menu.
- 2** Click [Network and Internet Connections] in the control panel and then double-click [Network Connections].

- 3** Right-click the [Local Area Connection] Icon and select [Properties].

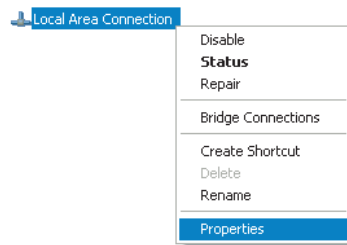

- 4** On the [General] Tab Page, double-click *Internet Protocol (TCP/IC)*.

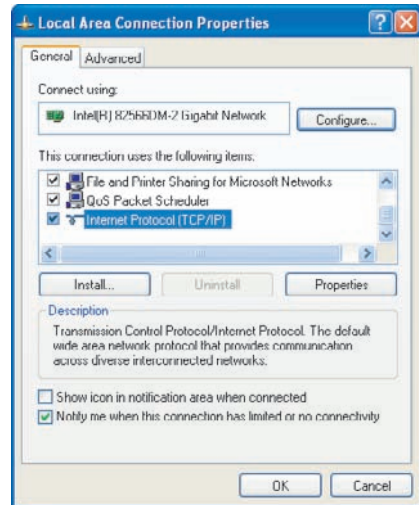

- 5** Select the *Use the following IP address* Option and enter the following IP address and subnet mask.

- IP address: 10.5.5.101
- Subnet mask: 255.255.255.0

- 6** Click the [OK] Button. This completes the settings.

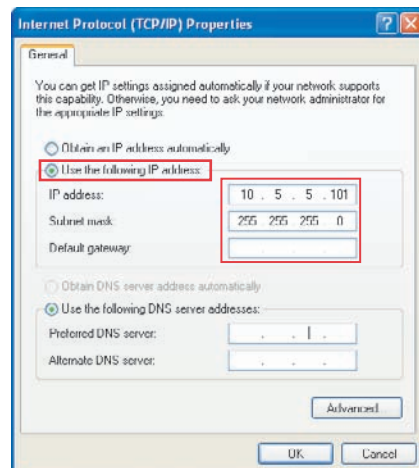

Taking Images

3-1 Selecting a Sensor for Configuration.....	36
3-2 Adjusting Image Quality	37
3-3 Adjusting the Object Position.....	42
3-4 Preventing Mutual Interference of Multiple Sensors	46

3-1 Selecting a Sensor for Configuration



If multiple Sensors are connected to a single Touch Finder or computer, you can select the Sensor that you want to set up.

- 1 Press [Run].**
This will enable setting the current Sensor into RUN Mode before selecting another Sensor.
- 2 Then press [Switch to Run mode].**

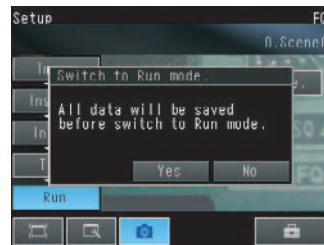

- 3 Press [Yes].**



- 4 Press  - [Switch Sensor].**
- 5 Press the image of the Sensor to be set up.**
 will be displayed for Sensors that are not yet set.

Note

Once the Touch Finder detects and records a Sensor, the display order for showing more than one Sensor is fixed. Even if the system configuration is changed to reduce the number of Sensors, the previous display location will remain for Sensors that were removed. To update displays of multiple Sensors to the current connection status, press [] - [Auto connect] on the right of the display in step 5, above, to automatically reconnect.

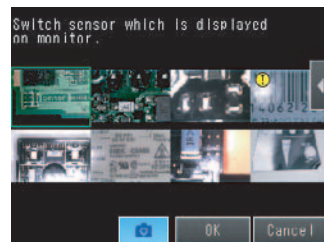

- 6 Press  - [Sensor settings] to return to Setup Mode.**

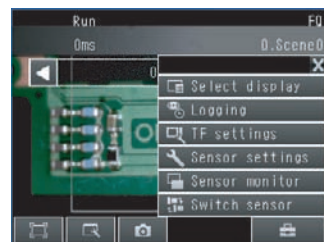

- 7 Press [Yes].**

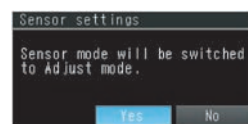

3-2 Adjusting Image Quality

Adjusting the Focus

► [Image] – [Camera setup]

1 Display the Camera Setup Display.

The focus can be seen as a numerical value. The higher the value, the better the focus.

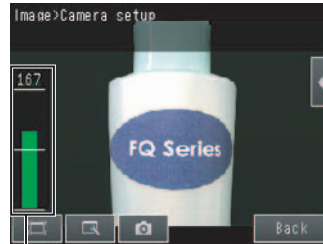

Focus Level

2 Manually adjust the focus using the focus adjustment screw on the Sensor while checking the image and focus value on the Touch Finder.

In the default settings, the field of view is set to the narrowest setting.

3 Press [Back].

Focus adjustment screw

Turn clockwise to focus on closer objects.
(The field of view will narrow.)



Turn the screw counterclockwise to focus on objects at a distance.
(The field of view will widen.)

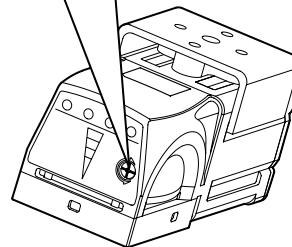

Important

- Turn the focus adjustment screw clockwise or counterclockwise a little bit to make sure that it has not already reached the dead stop. Do not force the screw if it does not rotate anymore. This will damage the Sensor.
- Do not turn the focus adjustment knob with a force that is greater than 0.1 N·m. This may damage it.

Adjusting the Brightness

To achieve stable measurements, the brightness of the camera image must be adjusted so that the characteristic to be measured is clearly visible.

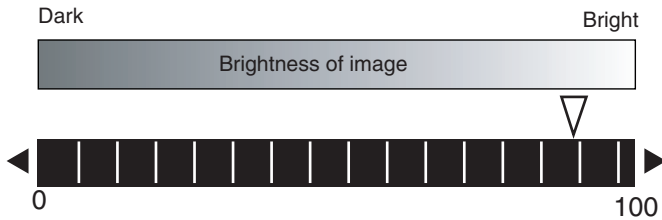

► [Image] – [Camera setup]

- 1 Press [◀] – [Brightness] on the right side of the display.
- 2 Move the bar to the left or right to adjust the brightness.
Moving it to the right will make the image brighter, while moving it to the left will reduce the brightness of the image.
Press [AUTO] to automatically adjust the brightness according to the image.



- 3 Press [OK].

Important

- The exposure time will be longer for larger values. This may cause the image to blur if the object is moving fast. If the Sensor is used on a high-speed line, check that the images are not blurred under actual operating conditions.
- If the brightness changes inconsistently with each image, turn ON the Brightness Correction Mode.

► [Image] – [◀] – [Brightness correction]

When the Brightness Correction Mode is ON, the brightness will be consistent but the timing when images are taken will be delayed by 25 ms. Make sure that appropriate images of the measured objects are taken when the Brightness Correction Mode is ON.

Timing Chart When the Brightness Correction Mode Is ON

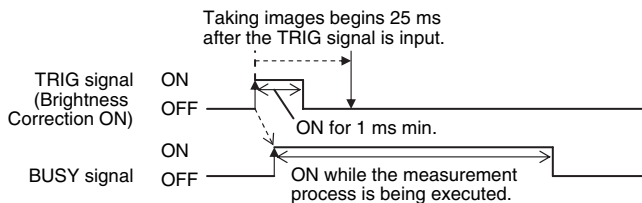

📖 Reference Timing Chart When the Brightness Correction Mode Is OFF: p. 127

Taking Clear Images of Moving Objects

For quick moving objects, the effect of blurring can be reduced by decreasing the exposure time.

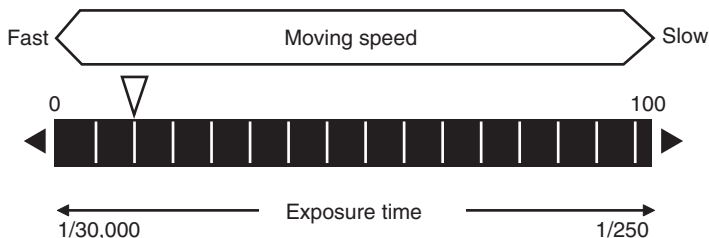

► [Image] – [Camera setup] – [◀] – [Brightness]

Adjusting the Brightness: p. 38

Important

The image becomes darker the smaller the exposure time. If the Sensor is used in a dark environment, make sure that the darkness of the image does not cause the measurements to be unstable.

Improving the Image Quality of Metallic and other Shiny Surfaces

When objects with shiny surfaces are being measured, the lighting may be reflected off the surface and affect the image.

To remove reflections, one of the following two functions can be used.

Function	Description
HDR (High Dynamic Range)	If objects have contrasting light and dark areas, the dynamic range can be made wider to improve the quality of the images.
Polarizing filter	Specular reflections can be eliminated from an image by attaching a polarizing filter to the Sensor.

• Selection Tips

• When the measurement object is not moving	→ Use the HDR function.
• When the measurement object is moving	→ Use a polarizing filter.

HDR Function

The HDR function is used for objects that have a large difference between light and dark areas. For this kind of object, clear images cannot be achieved with the standard brightness setting. The HDR function combines several images of different brightnesses (exposure times) so that the resulting image has a lower degree of contrast and can be measured stably for the desired characteristic.

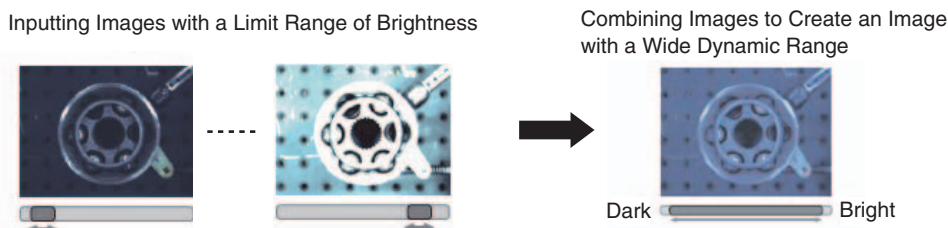

Observe the following precautions.

- Use the HDR function only for objects that are not moving to avoid image blurring.
Several images are taken with different shutter speeds and combined. If the object moves while the image is being taken, the image will become blurred.
- Images with different brightnesses are combined, so the resulting image will have a lower degree of contrast.

► **[Image] – [Camera setup]**

1 Press [◀] – [Brightness] on the right side of the display.

2 Press [◀] – [HDR] on the right side of the display.

The best HDR mode will be selected automatically.

The enabled range will appear in blue on the brightness adjustment bar.

3 Press the [OK] Button.



Note

- If the measurement object is changed after setting the HDR function, press the [AUTO] Button to automatically set the HDR mode again.
- If the automatic selection does not achieve the desired results, press [◀] – [HDR] on the right side of the display and manually set the best HDR mode. As shown below, the higher the level, the wider the combined dynamic range will be.

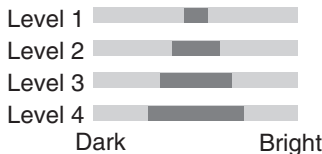

- If the reflections cannot be sufficiently removed using the HDR function, use a polarizing filter as well.

Using a Polarizing Filter

Specular reflections can be eliminated from an image by attaching a FQ-XF1 Polarizing Filter to the Sensor.

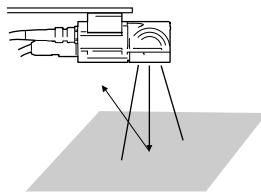

Observe the following precautions.

- The image will be darker compared to when no filter is used.
- If the image becomes too dark, adjust the brightness.

📖 p. 38

• **Mounting the Filter**

1 Hook the filter in the hole at the top of the Sensor.

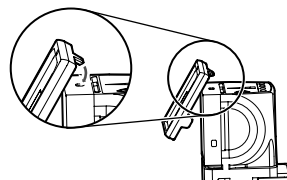

- Using the top section as a pivot point, pull down the filter so that it attaches to the Sensor.

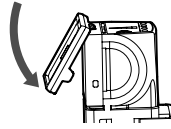

Adjusting the Colors of the Image (White Balance)

If external lighting is used, the image may appear as having different colors than the actual object. If this is the case, adjust the white balance.

If the lighting built in to the Sensor is used, the white balance is already adjusted. No setting is required in this case.

► [Image] – [Camera setup]

- Input a picture of white paper or cloth.
- Press [◀] – [White balance] on the right side of the display.
- Press the [Auto] Button. The Sensor will automatically adjust the colors.
- Move the bar to the left (light) or right (dark) to fine-tune the colors.
- Press [OK].

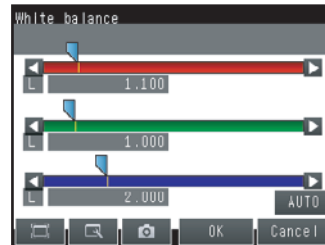

3-3 Adjusting the Object Position

If objects are moving, the position in the image of the characteristic that is to be measured will vary according to the timing of the trigger signal. The FQ Vision Sensor offers two different ways to adjust this position variation.

Function	Description	Reference
Position compensation	If the timing of the trigger is accurate, the FQ Vision Sensor can correct variations in the position of the object for each measurement with the Position Compensation function.	p. 42
Trigger delay	A delay can be applied from when the trigger (the TRIG signal) is input until when the image is input, to synchronize the timing of image input with the speed of the moving objects.	p. 44

Position Compensation

The FQ Vision Sensor performs measurements in measurement regions that are set to a fixed shape and position by the operator. A measurement is not performed properly if the object is not positioned inside this measurement region (e.g., the result will be NG even if the object is OK). In machines in which the position of the object varies for each image, stable measurements would be impossible. To cope this problem, the Position Compensation function aligns the whole image so that the object to be measured is moved exactly to the measurement region.

- Reference position (as set by the operator)
The measurement object is properly within the measurement region.

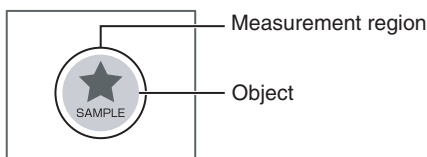

- Object is out of place:
The measurement object is outside the measurement region.

The image is aligned so that the object is returned to the reference position before performing measurements.

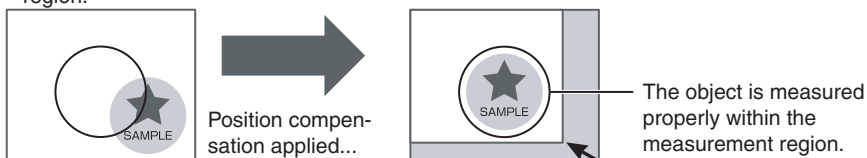

► [Image] – [Position compensation] – [Mode on/off]

- 1 Press [ON] for [Mode on/off]
- 2 Press [Settings].

- 3 Press [Teach].
- 4 Adjust the image so that the measurement object is in the center.
- 5 Press [◀] – [Model region].
- 6 Move the rectangle so that the characteristic part for position compensation is inside it.
- 7 Press [OK].
- 8 Press [Teach].
The characteristic part and reference position for position compensation will be registered.
- 9 Press [OK] to save the settings.

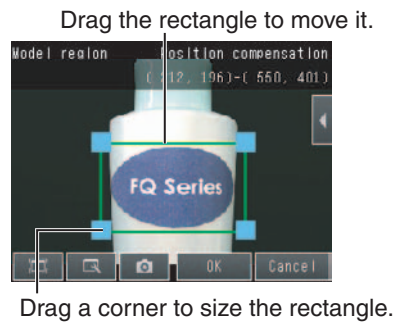

Adjusting the Judgement Parameters

Set how similar the image must be to the registered image for position compensation to be applied.

▶ [Image] – [Position compensation] – [Settings] – [Judgement]

- 1 Set the correlation range for an OK judgement.

Operating procedures: p. 52

• Measurement Data That Can Be Used for External Outputs and Calculations

The following values can be output to external devices or used in calculations as measurement data.

Expression text string	Data name	Description	Data range
JG	Judgement	This is the judgement result.	-2: No judgement (not measured), 0: Judgement is OK, -1: Judgement is NG, -13: Teaching not performed error, -14: Figure not registered error, -15: Out of range error
X	Position X	This is the X coordinate of the position where the model was found.	-99999.9999 to 99999.9999
Y	Position Y	This is the Y coordinate of the position where the model was found.	-99999.9999 to 99999.9999
CR	Correlation	This value indicates how similar the image is to the image registered as reference.	0 to 100
SX	Reference position X	This is the X coordinate of the position where the model was registered.	-99999.9999 to 99999.9999
SY	Reference position Y	This is the Y coordinate of the position where the model was registered.	-99999.9999 to 99999.9999
DX	Scroll X	X coordinate of measured position – X reference position	-99999.9999 to 99999.9999
DY	Scroll Y	Y coordinate of measured position – Y reference position	-99999.9999 to 99999.9999

4-9 Calculations and Judgements Using Inspection Item Data: p. 75

Measures to Stabilize Position Correction

• Low Mark Contrast and Inconsistent Correlations

Areas with high contrast are registered as model registration sections. The adjustment procedure is the same as for the search function. Or, adjust the brightness to increase the contrast of the mark.

 Making dark images brighter: p. 38

• Inconsistent Marks and Inconsistent Correlations

Inconsistent portions can be masked so that are omitted from matching.

Operating procedures for other functions are basically the same as those for searching. Refer to the following information.

 Unstable search results: p. 54

Increasing the Speed of Position Compensation

The following method can be used to reduce processing time.

- Reduce the range in which searches are performed for the model.

Operating procedures for other functions are basically the same as those for searching. Refer to the following information.

 Changing the measurement region: p. 57

Adjusting the Image Timing

The internal timing for taking an image can be set to be delayed in relation to the external trigger signal. This can be used to adjust the object position in the image, e.g., if an external trigger sensor is used. If the object position still varies in the image the Position Compensation function must also be used.

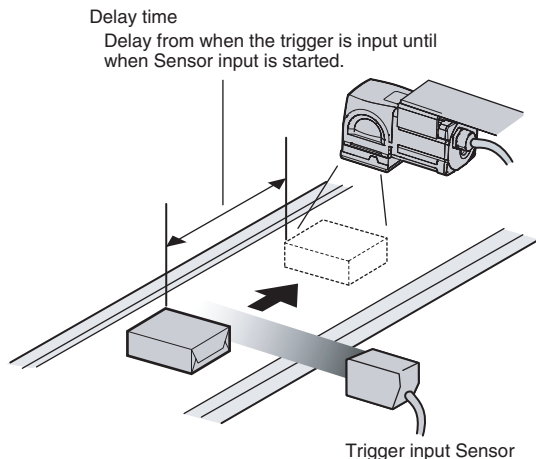

► [Image] – [Trigger setup] – [Trigger delay]

- 1** A TRIG signal is input.
Images are input continuously.
- 2** Select the image with the measurement object in the center using [←] and [→].
- 3** Press the image.
- 4** Press [OK].

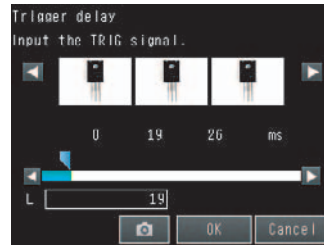

Note

The delay time can be set using the adjustment bar or by directly entering a value.

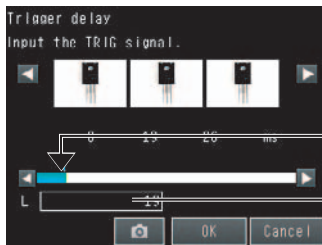

Move the bar to the left or right.

Or

Directly input the delay time.

3-4 Preventing Mutual Interference of Multiple Sensors

When the same trigger signal is input to multiple Sensors, the lighting from one Sensor may affect the measurements of the other Sensors. This is called mutual interference. This kind of interference can be prevented offsetting the image input timing of each Sensor from when the trigger signal is received.

Example:

A trigger (i.e., the TRIG signal) is input to Sensor 0 and Sensor 1 at the same time.

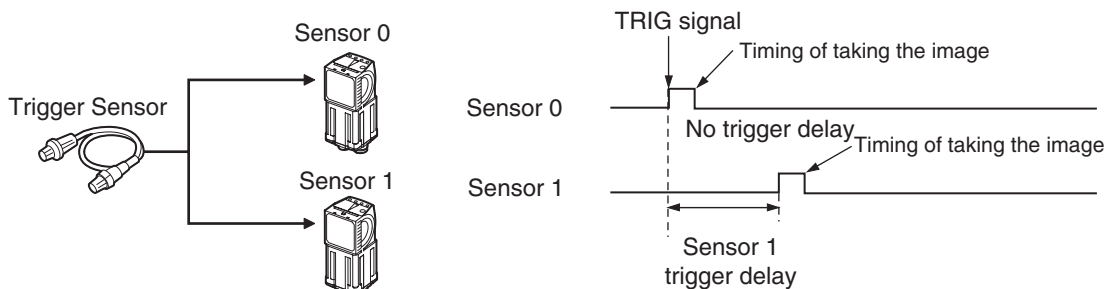

Sensor 0 immediately begins image input when the trigger is input.
Sensor 1 begins image input after the specified time has passed.

1 Change to the setup for to Sensor 1.

p. 36

2 Press [Image] – [Trigger setup] – [Trigger delay].

3 Set the trigger input delay time for Sensor 1.

p. 44

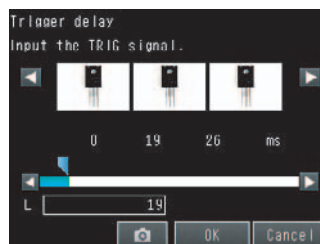

Important







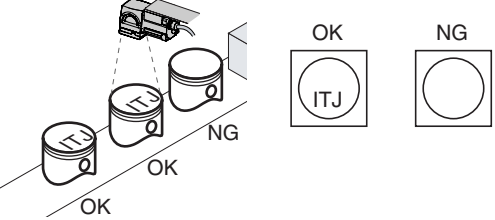

- The delay time for preventing mutual interference must be longer than the shutter time.
When the lighting built into the Sensor is used, the shutter time is 4 ms max. Therefore make the delay at least 4 ms.

Setting Up Inspections

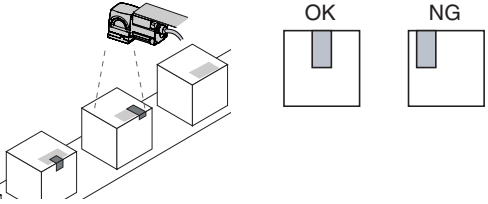
4-1 Inspection Item Selection Guide	48
4-2 Setup Procedure for Inspection Items	49
4-3 Configuring Inspection Items	50
4-4 Inspecting with the Search Inspection Item	52
4-5 Inspecting with the Edge Position Inspection Item	59
4-6 Inspecting with the Edge Width Inspection Item	64
4-7 Inspecting with the Area Inspection Item	68
4-8 Inspecting with Color Data Inspection Item	72
4-9 Calculations and Judgements Using Inspection Item Data	75

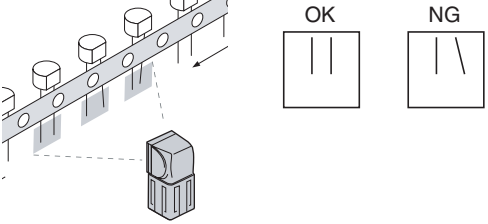
4-1 Inspection Item Selection Guide

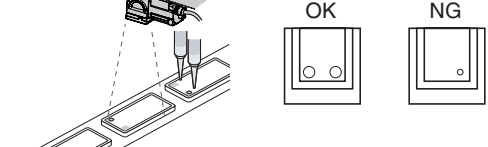
The FQ Vision Sensor uses inspection items to judge measurement objects. There are five different measurement objects. Select the best inspection items for the characteristics of the measurement object that are being judged.

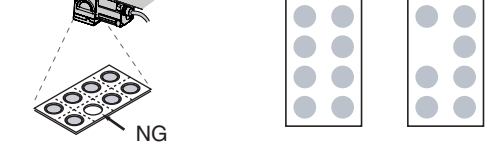
Inspection	Example	Inspection items used	Reference
Judging according to shapes 	Judging if there is a mark 	Search	p. 52
Judging according to positions 	Measuring the position offset of a seal 	Edge Position	p. 59
Judging according to widths 	Measuring the width between lead wires 	Edge Width	p. 64
Judging according to sizes 	Judging if there is silver paste 	Area	p. 68
Judging according to colors 	Detecting parts 	Color Data	p. 72

4-2 Setup Procedure for Inspection Items

The basic steps for setting up inspection items are shown below.

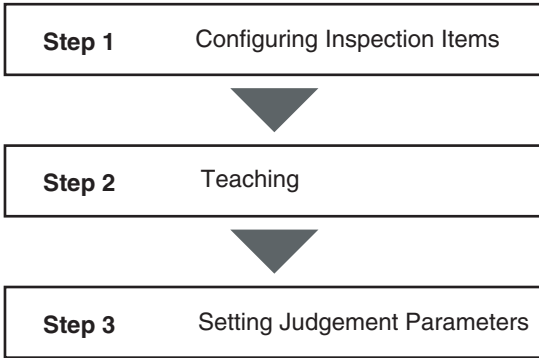

If measurements are unstable

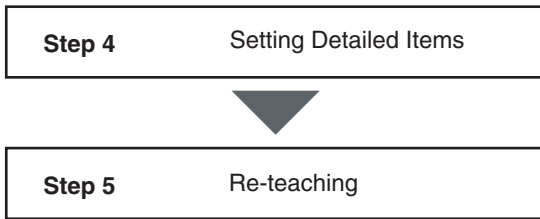

Note

- Only one inspection item can be used with a single-function model (FQ-S1 Sensors).
- Up to 32 inspection items can be combined and used with a standard model (FQ-S2 Sensors).

4-3 Configuring Inspection Items

Adding New Inspection Items

1 Press [Inspect] – [Inspection].

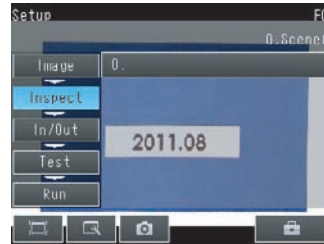

2 Press an unused inspection item number.

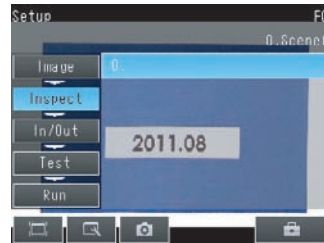

3 Press [Add item.] on the menu.

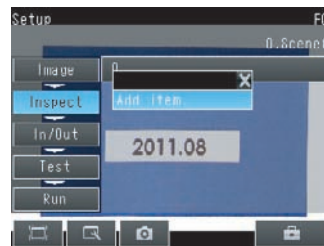

4 Select an inspection item, such as [Search].

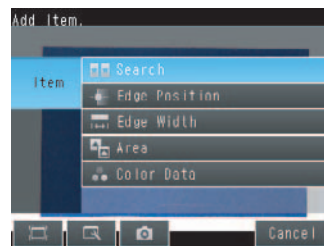

When registering multiple inspection items, press the inspection item number after 1.--- and set it in the same way.

Note

If more than six inspection items are set, drag the  icon at the bottom of the menu up to display the next inspection item numbers.

Modifying Existing Inspection Items

- 1 Press the number of the inspection item to be set.

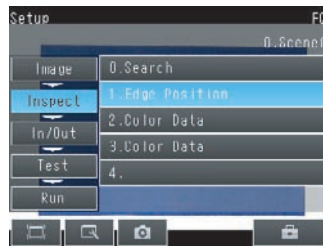

- 2 Press [Modify] on the menu.

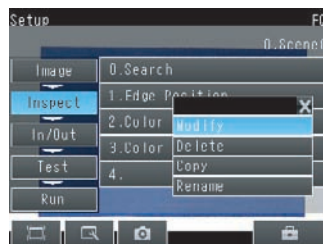

Deleting Inspection Items

- 1 Press the number of the inspection item to be deleted.
- 2 Press [Delete] on the menu.

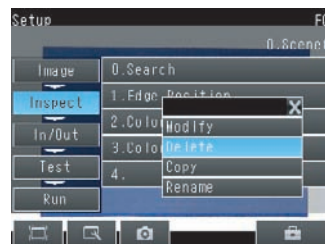

Note

Executing Similar Measurements in Different Places

→ Copy an inspection item that is already registered: [Copy].

→ Change the name of an inspection item: [Rename].

4-4 Inspecting with the Search Inspection Item

Search Inspection Item

This inspection item is used to perform inspections for shapes or for presence. The image pattern that is to be measured is registered in advance and measurements are performed to see if the pattern is present or if the shape is different.

The image pattern that is registered in advance is called the model. The degree to which the image matches the model is called the correlation.

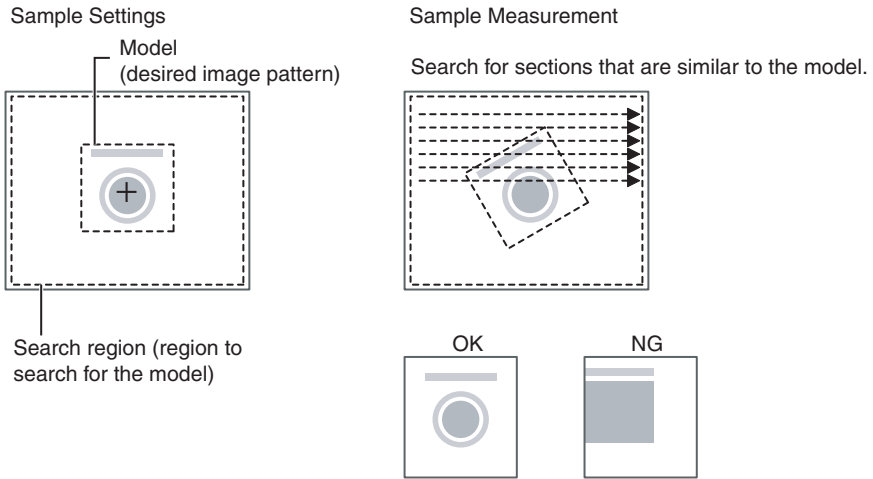

Setup Procedure for the Search Inspection Item

Step 1 Selecting the Inspection Item

► [Inspect] – [Inspection]

- 1 Press an unused inspection item number and press [Add item.].
- 2 Press [Search].

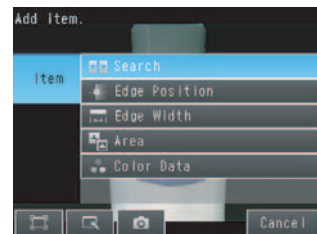

Registering inspection items: p. 50

Step 2 Teaching

Teaching means to store the region and partial image as reference data for the measurement.

► [Inspect] – [Inspection] – [Add item.] – [Search] – [Settings] Tab Page

- 1 Press [Teach].
- 2 Place the object that is to be used as the measurement reference in front of the camera.
- 3 Move the rectangle to the location to be measured.
- 4 Press [OK].
- 5 Press [TEACH] on the lower right of the display.
The basic settings will be registered when teaching has been completed.
- 6 Press [Back] to end teaching.

Drag the rectangle to move it. Drag a corner to size the rectangle.

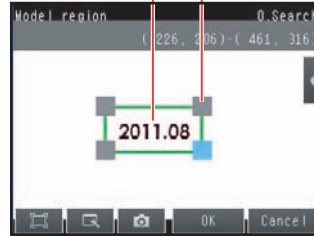

The following data is stored as the measurement reference.

Item	Parameter	Description
Reference data	Model image	This is the partial image that is stored as the reference.
	Reference position X	These are coordinates of the model image that are stored as reference.
	Reference position Y	

Step 3 Adjusting Judgement Parameters

► [Inspect] – [Inspection] – [Add item.] – [Search] – [Settings] Tab Page

- 1 Press [Judgement].
- 2 Set the correlation range for an OK judgement.
Continuous measurements will be performed for the images that are taken.
- 3 Press [OK] to accept the value.
- 4 Press [Back] to end making the setting.

Lower limit Upper limit

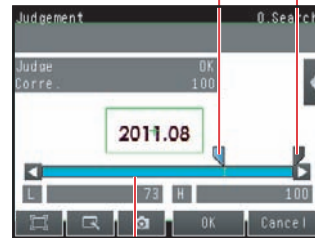

Blue for OK. Red for NG.

Parameter	Setting	Description
Correlation	Range: 0 to 100 Default: Lower limit: 60, Upper limit: 100	Adjust the upper and lower limits of the correlation for an OK judgement.

Unstable Search Results

Inclined Measurement Objects

Adjust the [Angle range] parameter to increase the range in which a search is made for the model. The Search inspection item judges whether an image is OK or NG according to the correlation with a previously registered image pattern. For this reason, if the object is at an angle, the correlation is reduced and the image may be judged as NG. To achieve an OK judgement for the same image pattern even when the object is at an angle, the rotation range must be widened.

► [Inspect] – [Inspection] – [Search] – [Modify] – [Details] Tab Page

Parameter	Setting	Description
Angle range	$\pm 0^\circ$ (default), $\pm 5^\circ$, $\pm 10^\circ$, $\pm 15^\circ$, $\pm 20^\circ$, $\pm 25^\circ$, $\pm 30^\circ$, $\pm 35^\circ$, $\pm 40^\circ$, or $\pm 45^\circ$	A search is performed within the set angle range. The larger the angle range, the longer the processing time. Important If you change the angle range, perform teaching again.  p. 53

Correlation Is Inconsistent Due to Low Contrast

Adjust the brightness to improve the contrast of the mark.

 Adjust the brightness: p. 38

Correlation Is Inconsistent Due to Variations in the Measurement Object

Inconsistent portions can be masked so that they are omitted from matching.

 Model masking: p. 56

Increasing Processing Speed

The following two methods can be used to reduce processing time.

- **Reduce the range in which a search is performed for the model.**

 Changing the measurement region: p. 57

- **Reduce the angle range setting.**

Adjust the [Angle range] parameter to reduce the range in which a search for the model is performed.

 Setting the angle range: p. 54

Editing the Model and Measurement Regions

This section describes how to edit the following regions.

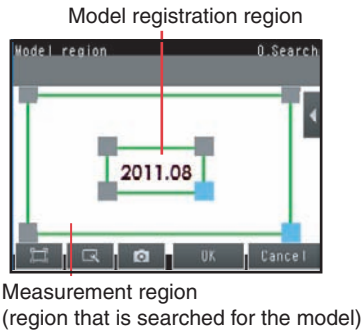

Important

If the model region is changed, perform teaching again.

 p. 53

Changing the Model Registration Region to a Shape Other Than a Rectangle

One rectangular region is registered as the default model registration region.

Other than rectangles, circles and polygons can be set as the model registration regions.

► **[Inspect] – [Inspection] – [Search] – [Modify] – [Settings] Tab Page – [Teach] – [◀] – [Model region]**

- 1 Press [◀] – [Model region].**
- 2 Press [◀] – [Delete] in the model registration editing display.**
The rectangle will be deleted.

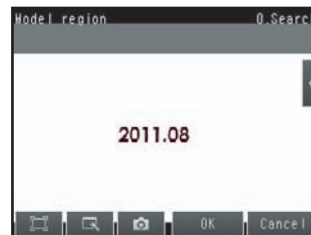

- 3 Press [Yes].**
- 4 Press [Add] in [◀].**
- 5 Press the shape of the region that you want to use.**
- 6 Draw the region.**
- 7 Press [OK].**

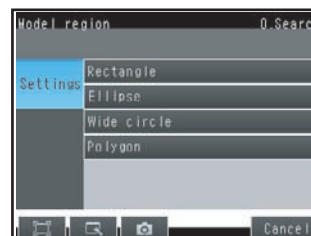

Note

Up to 8 shapes can be combined to create a region for one model.

Masking Parts of the Model

The model registration region can be formed freely by combining enabled and disabled regions.

Example:

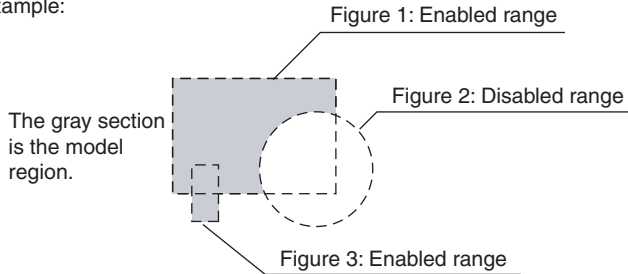

- ▶ **[Inspect] – [Inspection] – [Search] – [Modify] – [Settings] Tab Page – [Teach] – [◀] – [Model region]**

1 Draw the figure according to the section that you want to mask.

p. 55

2 While the figure to be masked is selected, press [◀] on the right of the display and then press [OR/NOT]

The selected area will be removed from the model.
Every time you press [OR/NOT], the area will switch between being enabled and disabled.

OR: Enabled range
NOT: Disabled range

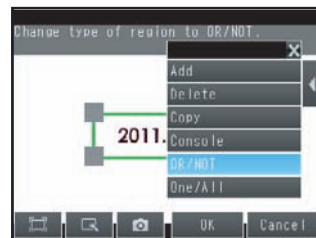

Fine-tuning the Position of the Region

This section describes the console which is useful to fine-tune the position of the measurement region or the model registration region in 1-pixel increments.

- ▶ **[Inspect] – [Inspection] – [Search] – [Modify] – [Settings] Tab Page – [Teach] – [◀] – [Model region]**

1 Press [◀] – [Console] on the right side of the display where you draw the region.

The console will appear.

2 To adjust the position of the figure, press within the frame. To adjust the size of the figure, press a corner of the figure.

3 Use the cross-key to align the figure with the search object.

The position of the figure can be adjusted by pressing the cross-key. Pressing it once will change the coordinate values by one pixel.

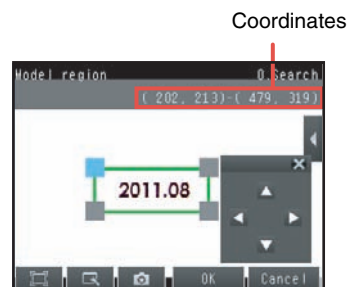

Changing the Measurement Region

The region within which the model is searched can be changed. In the default settings, the whole display is set as the measurement region.

► [Inspect] – [Inspection] – [Search] – [Modify] – [Settings] Tab Page – [Teach]

1 Press [◀] – [Insp. region] on the right of the display.
The [Insp. region] Display will appear.

2 Adjust the size and position of the measurement region.

- Change the size.
Press the frame at one corner.
The processing time can be shortened by making the region smaller.
- Change the position.
Drag the figure to move it.

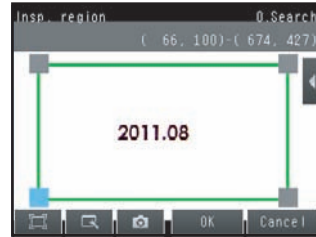

• Measurement Data That Can Be Used for External Outputs and Calculations

The following values can be used as measurement data and output to external devices via the Ethernet or used in calculations.

Expression text string	Data name	Description	Data range
JG	Judgement	This is the judgement result.	-2: No judgement (not measured), 0: Judgement is OK, -1: Judgement is NG, -13: Teaching not performed error, -14: Figure not registered error, -15: Out of range error
X	Position X	This is the X coordinate of the position where the model was found.	-99999.9999 to 99999.9999
Y	Position Y	This is the Y coordinate of the position where the model was found.	-99999.9999 to 99999.9999
TH	Angle	This is the angle of the position where the model was found.	-180 to 180
CR	Correlation	Correlation	0 to 100
SX	Reference position X	This is the X coordinate of the position where the model was registered.	-99999.9999 to 99999.9999
SY	Reference position Y	This is the Y coordinate of the position where the model was registered.	-99999.9999 to 99999.9999
ST	Reference angle	This is the angle when the model was registered.	-180 to 180

4-9 Calculations and Judgements Using Inspection Item Data: p. 75

• Measurement Data That Can Be Logged

The following values can be logged as measurement data.

Parameter	Range of value	Description
Correlation	0 to 100	This is the measured correlation.

7-4 Logging Measurement Data and Image Data: p. 110

Errors

Errors in Teaching

A teaching error message will appear if the contrast of the image within the model registration region is too low. Select a region with a larger contrast between light and dark areas compared to the region that was registered as the model and re-register it as the model.

4-5 Inspecting with the Edge Position Inspection Item

Edge Position

This inspection item is used to inspect positions. For example, it can be used to see if a label is attached at the correct position or if a product is set in the correct position.

Places where the color changes greatly are called edges. The positions of these edges are measured.

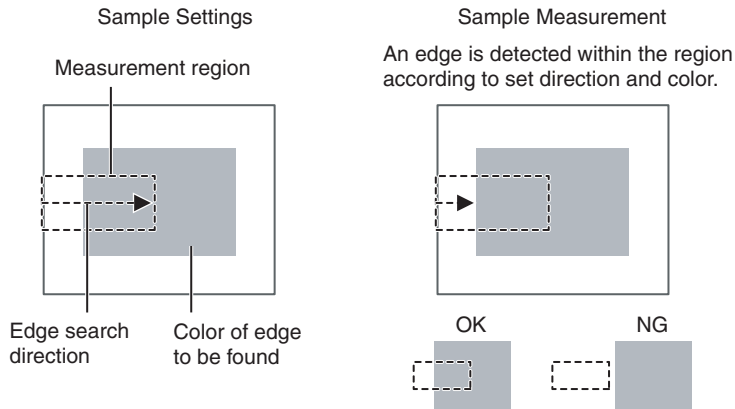

Setup Procedure for Edge Position

Step 1 Selecting the Inspection Item

► [Inspect] – [Inspection]

- 1 Press an unused inspection item number and press [Add item.].
- 2 Press [Edge position].

 Registering inspection items: p. 50

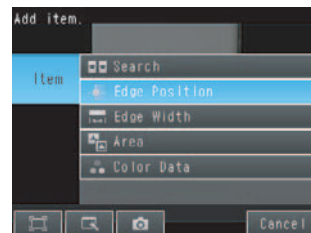

Step 2 Teaching

Teaching means to store the region and the edge position in the region as reference data for the measurement.

► [Inspect] – [Inspection] – [Add item.] – [Edge Position] – [Settings] Tab Page

- 1 Press [Teach].
- 2 Place the object that is to be used as the measurement reference in front of the camera.
- 3 Move the rectangle to the location to be measured.
- 4 Press [OK].
- 5 Press [TEACH] on the lower right of the display.
The basic settings will be registered when teaching has been completed.
- 6 Press [Back] to end teaching.

The arrow in the middle shows the direction for detecting an edge.

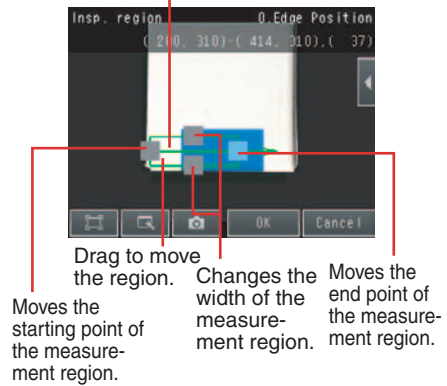

 Changing the measurement region: p. 57

The following data is stored as basic measurement data.

Item	Parameter	Description
Reference data	Reference position X	The reference coordinates (X, Y) of the position are set automatically.
	Reference position Y	

Step 3 Adjusting Judgement Parameters

► [Inspect] – [Inspection] – [Add item.] – [Edge Position] – [Settings] Tab Page

- 1 Press [Judgement].
- 2 Set the range within which the D. Position is judged as OK.
Continuous measurements will be performed for the images that are displayed.
- 3 Press [OK] to enter the value.

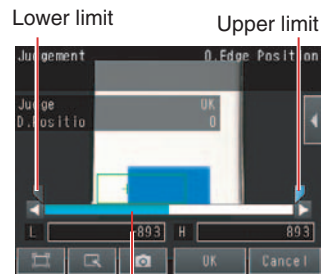

Blue for OK. Red for NG.

Item	Parameter	Setting	Description
Judgement Parameter	D. Position	Range: -893 to 893 Default: Lower limit: -893, Upper limit: 893	Set the upper and lower limits from the reference position as the offset within which the judgement will be OK.

Unstable Edge Position Results

There Is an Edge But It Cannot Be Detected

► [Inspect] – [Inspection] – [Edge Position] – [Modify] – [Details] Tab Page

Parameter	Setting	Description
Edge level	Range: 0 to 100 Default: 50	Set the color change level to detect as an edge. The edge point is found based on a threshold that is set for a color change. Important If you change the edge level, perform teaching again.

Note

Edge Level

An edge is detected in the following way.

1. The color change distribution of the entire measurement region is determined.
2. The minimum color change is 0%. The maximum color change is 100%.
3. The location where the color change intersects with the edge level is detected as the edge.

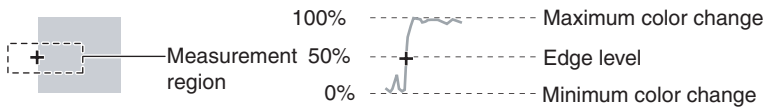

Noise Is Mistaken as an Edge

► [Inspect] – [Inspection] – [Edge Position] – [Modify] – [Details] Tab Page

Parameter	Setting	Description
Noise level	Range: 0 to 422 Default: 10	Sets the density level to be considered as noise. If the difference between the maximum and minimum color changes in the region is below the noise level, it will be assumed that there is no edge. Increase this value if noise is incorrectly detected as an edge. Important If you change the noise level, perform teaching again.

Note

Noise Level

The maximum and minimum color changes within the edge detection region are determined. If the difference is less than the noise level, it is assumed that there are no edges. Normally there is no problem with the default value of 10, but if noise is mistakenly detected as an edge, make this value higher.

Within the Region

Max. color change – Min. color change < Noise level → No edge found → Measurement result: NG

Max. color change – Min. color change ≥ Noise level → Edge found → Perform measurement

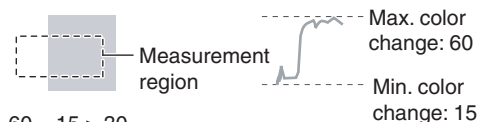

Judges that there is an edge and performs measurements.

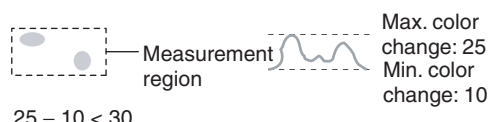

Judges that there is no edge (measurement result is NG).

Screen Display When the Edge Level and Noise Level Are Changing

A bar showing the threshold level moves up and down on the graphic as the edge level/noise level value changes. A cross-key cursor will also appear at the detected edge position.

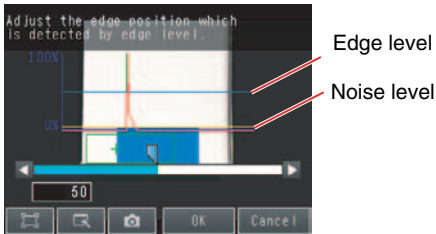

Undesired Edge Position Is Automatically Detected When Teaching

Manually set the color of the edge that you want to detect.

► [Inspect] – [Inspection] – [Edge Position] – [Modify] – [Settings] Tab Page – [Teach]

- 1 Press [◀] – [Color ON/OFF] on the right side of the display.
- 2 Press [ON].
- 3 Press [◀] – [Set color.] on the right of the display.
- 4 Draw a rectangle around the color that you want to use to extract an edge.
The specified color will be extracted.
- 5 Press [OK] to enter the edge color.
- 6 Press [TEACH] again.
- 7 Press [Back].

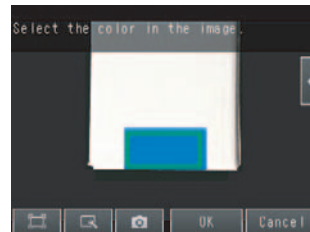

(Only a rectangle can be used to specify the region.)

Note

It is also possible to check the extraction colors or specify them using the color palette.
The RGB values of the extraction color can be checked and adjusted using the color palette.
If you press [◀] – [Color palette], a color palette will appear.



When a color is pressed on the color palette, its RGB values will be displayed.

Increasing Processing Speed for Edge Position

Make the measurement region smaller to reduce the processing time.

📖 Changing the measurement region: p. 57

• Measurement Data That Can Be Used for External Outputs and Calculations

The following values can be used as measurement data and output to external devices via the Ethernet or used in calculations.

Expression text string	Data name	Description	Data range
JG	Judgement	This is the judgement result.	-2: No judgement (not measured), 0: Judgement is OK, -1: Judgement is NG, -13: Teaching not performed error, -14: Figure not registered error, -15: Out of range error
X	Edge position X	This is the X coordinate of the measured edge position.	-99999.9999 to 99999.9999
Y	Edge position Y	This is the Y coordinate of the measured edge position.	-99999.9999 to 99999.9999
DF	Offset amount	This is the offset from the measured reference position.	-99999.9999 to 99999.9999
SX	Reference position X	This is the X coordinate of the edge position when a range is set.	-99999.9999 to 99999.9999
SY	Reference position Y	This is the Y coordinate of the edge position when a range is set.	-99999.9999 to 99999.9999

 4-9 Calculations and Judgements Using Inspection Item Data: p. 75

• Measurement Data That Can Be Logged for Edge Position

The following values can be logged as measurement data.

Measured item	Range of value	Description
D. Position	-893 to 893	This is the offset from the measured reference position.

 7-4 Logging Measurement Data and Image Data: p. 110

Errors

Errors in Teaching

A teaching error message will appear if the edge position cannot be detected when teaching. Perform the following.

- If the color of the measurement object has changed from the specified color, set the color again and try teaching again.
- If there is an edge and it cannot be detected, adjust the [Noise level] on the [Details] Tab Page and try teaching again.

Edge Not Found

If an edge is not found, the measurement result will be NG. Perform the following.

- If a color was specified, make sure the color of the measurement object has not changed from the specified color.
- Set the color again if necessary.
- If there is an edge and it cannot be detected, make sure the [Edge level] parameter on the [Details] Tab Page is correct.

 Edge level: p. 61

4-6 Inspecting with the Edge Width Inspection Item

Edge Width Inspection Item

This inspection item is used to measure dimensions. Places where the color changes greatly are called edges. The distance between two edges is called the edge width.

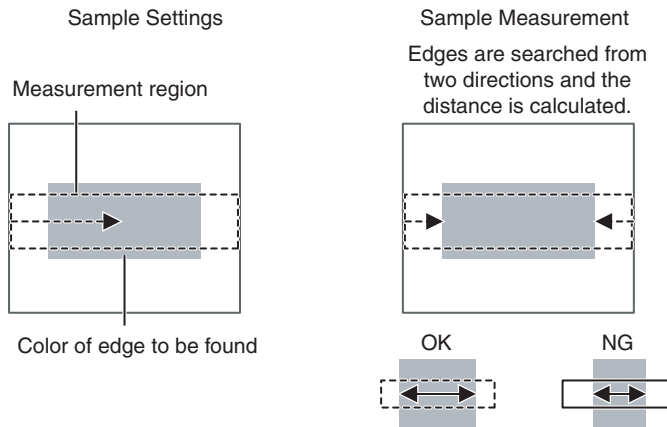

Setup Procedure for Edge Width Inspection Item

Step 1 Selecting the Inspection Item

► [Inspect] – [Inspection]

- 1 Press an unused inspection item number and press [Add item.].
- 2 Press [Edge Width].

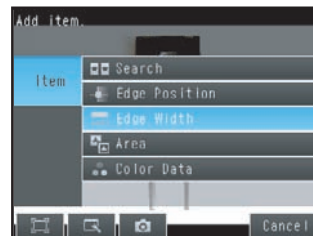

 Registering inspection items: p. 50

Step 2 Teaching

Teaching means to store the region and the edge width in the region as reference data for the measurement.

► [Inspect] – [Inspection] – [Add item.] – [Edge Width] – [Settings] Tab Page

- 1 Press [Teach].
- 2 Place the object that is to be used as the measurement reference in front of the camera.
- 3 Move the rectangle to the location to be measured.
- 4 Press [OK].
- 5 Press [TEACH] on the lower right of the display.
The basic settings will be registered when teaching has been completed.
- 6 Press [Back] to end teaching.

The middle arrow is the direction for detecting an edge.

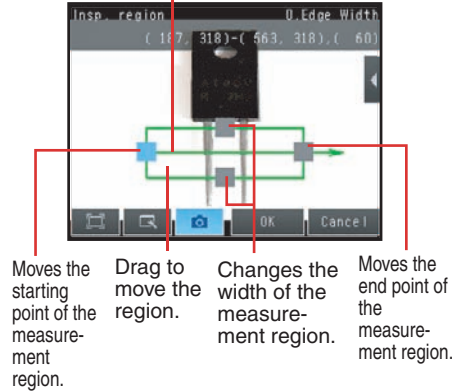

Changing the measurement region: p. 57

The following data is stored as the measurement reference.

Item	Parameter	Description
Reference data	Reference width	The reference edge width is set automatically.

Step 3 Adjusting the Judgement Parameters

► [Inspect] – [Inspection] – [Add item.] – [Edge Width] – [Settings] Tab Page

- 1 Press [Judgement].
- 2 Set the D. Width range for an OK judgement.
Continuous measurements will be performed for the images that are displayed.
- 3 Press [OK] to enter the value.

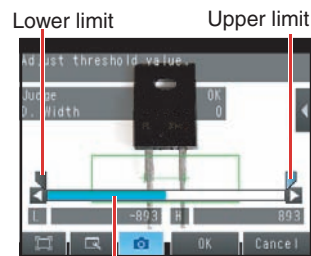

Blue for OK. Red for NG.

Item	Parameter	Setting	Description
Judgement Parameter	D. Width	Range: -893 to 893 Default: Lower limit: -893, Upper limit: 893	Set the upper and lower limits of the reference width for an OK judgement.

Unstable Edge Width Results

If the measurement result is not stable, adjust the [Edge level], [Noise level], and [Set color.] parameters.

p. 61

Increasing Edge Width Processing Speed

Make the measurement region smaller to reduce the processing time.

 Changing the measurement region: p. 57

Measurement Data That Can Be Used for External Outputs and Calculations

The following values can be output to external devices or used in calculations as measurement data.

Expression text string	Data name	Description	Data range
JG	Judgement	This is the judgement result.	-2: No judgement (not measured), 0: Judgement is OK, -1: Judgement is NG, -13: Teaching not performed error, -14: Figure not registered error, -15: Out of range error
W	Edge Width	Edge Width	0 to 99999.9999
DF	Width amount	This is the difference between the reference width and the measured edge width.	0 to 99999.9999
SW	Reference width	This is the reference width when the model was registered.	0 to 99999.9999

 4-9 Calculations and Judgements Using Inspection Item Data: p. 75

Measurement Data That Can Be Logged for Edge Width

The following values can be logged as measurement data.

Measured item	Range of value	Description
D. Width	-893 to 893	This is the difference between the reference width and the measured edge width.

 7-4 Logging Measurement Data and Image Data: p. 110

Errors

Errors in Teaching

A teaching error message will appear if the edge position cannot be detected when teaching. Perform the following.

- If the color of the measurement object has changed from the specified color, set the color again and try teaching again.
- If there is an edge and it cannot be detected, adjust the [Noise level] on the [Details] Tab Page and try teaching again.

If an edge is not detected when teaching, 0 will be registered as the reference width. If the result is OKed when there is not edge, set the judgement parameters for a reference position of 0.

Edge Not Found

The measured edge width will be 0. Perform the following.

- If a color was specified, make sure the color of the measurement object has not changed from the specified color.
- Set the color again if necessary.
- If there is an edge and it cannot be detected, make sure the [Edge level] parameter on the [Details] Tab Page is correct.

 Edge level: p. 61

4-7 Inspecting with the Area Inspection Item

Area Inspection Item

This inspection item is used to measure sizes. It measures the amount of a color within the measurement region. The size is calculated as a number of pixels and it is called the area.

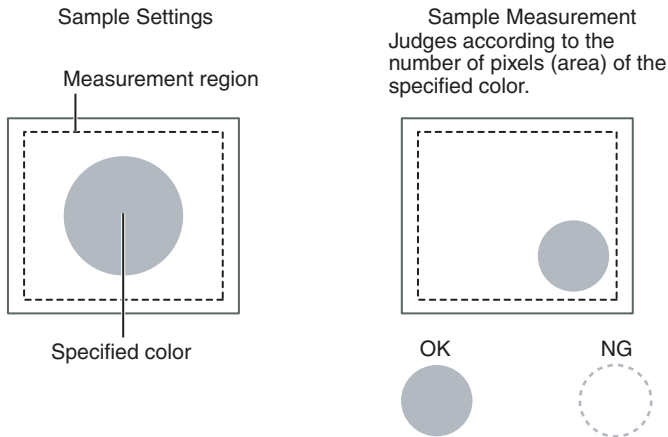

Setup Procedure for Area

Step 1 Selecting the Inspection Item

► [Inspect] – [Inspection]

- 1 Press an unused inspection item number and press [Add item].
- 2 Press [Area].

 Registering inspection items: p. 50

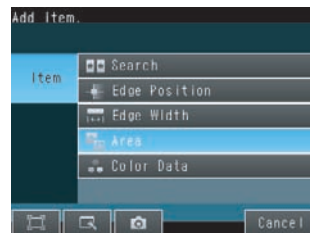

Step 2 Teaching

Teaching means to store the region and the color area in the region as reference data for the measurement.

► [Inspect] – [Inspection] – [Add item.] – [Area] – [Settings] Tab Page

- 1 Press [Teach].
- 2 Place the object that is to be used as the measurement reference in front of the camera.
- 3 Move the rectangle to the location to be measured.
- 4 Press [OK].
- 5 Press [TEACH] on the lower right of the display.
The basic settings will be registered when teaching has been completed.
- 6 Press [Back] to end teaching.

Drag the rectangle to move it. Drag a corner to size the rectangle.

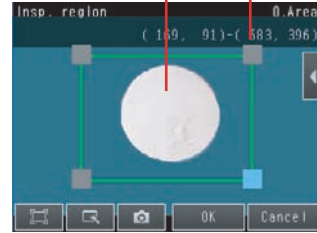

Changing the measurement region: p. 57

The following data is stored as the measurement reference.

Item	Parameter	Description
Reference data	Extract color	This is the color for which to measure the area. The color occupying the largest area will be automatically registered.
	Reference area	The area to use as a reference is set automatically.

Step 3 Adjusting Judgement Parameters

► [Inspect] – [Inspection] – [Add item.] – [Area] – [Settings] Tab Page

- 1 Press [Judgement].
- 2 Set the D. Area range for an OK judgement.
Continuous measurements will be performed for the images that are displayed.
- 3 Press [OK] to enter the value.

Lower limit Upper limit

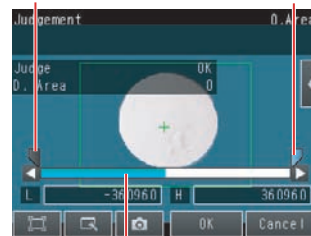

Blue for OK. Red for NG.

Item	Parameter	Setting	Description
Judgement Parameter	D. Area	Range: -360,960 to 360,960 Default: Lower limit: -360,960, Upper limit: 360,960	Set the upper and lower limits for an OK judgement. The set range is the difference between the reference area and the measured areas.

Unstable Area Results

The Desired Color Cannot Be Detected

Add a specific color or enlarge the color range.

Extraction Is Automatically Performed for an Undesired Color When Teaching

Manually set the color for which to measure the area.

► [Inspect] – [Inspection] – [Area] – [Modify] – [Settings] Tab Page – [Teach]

- 1 Press [◀] – [Set color] on the right of the display.
- 2 Drag around the color for which you want to measure the area.
Areas with that color will be automatically detected.
Continuous measurements will be performed for the images that are displayed.
Only the extracted color will appear on the display.
- 3 Press [OK].
- 4 Press [TEACH].
- 5 Press [Back] to end teaching.

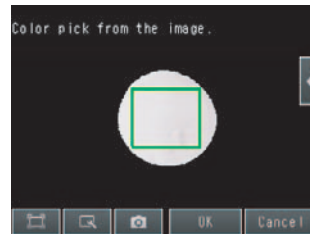

Note

Measuring More Than One Color

Set the colors using the color palette.

Press [◀] – [Color palette] on the Set Color Display to display the color palette. Up to four colors can be specified. If the *Color inv.* Option is selected, the color outside the region will become the selected color.

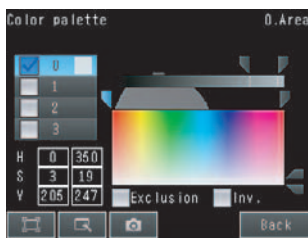

Making the Extract Color Easier to Check

- The display for the extracted color can be switched by using [◀] – [Display setting].
(The following display patterns can be selected for the extracted color: [Measurement image], [All color image] (default), [Selected color image], or [Binary image].)
- Press [◀] – [Background color] to change the display for colors other than the extraction color.
(The color can be chosen from [Black] (default), [White], [Red], [Green], or [Blue].)

Increasing Processing Speed for Area

Make the measurement region smaller to reduce the processing time.

 Changing the measurement region: p. 57

Measurement Data That Can Be Used for External Outputs and Calculations

The following values can be used as measurement data and output to external devices via the Ethernet or used in calculations.

Expression text string	Data name	Description	Data range
JG	Judgement	This is the judgement result.	-2: No judgement (not measured), 0: Judgement is OK, -1: Judgement is NG, -13: Teaching not performed error, -14: Figure not registered error, -15: Out of range error
AR	Area	This is the area in the measurement region with the specified color.	0 to 999999999.9999
X	Gravity X	This is the X coordinate of the center of the measurement area with the specified color.	-99999.9999 to 99999.9999
Y	Gravity Y	This is the Y coordinate of the center of the measurement area with the specified color.	-99999.9999 to 99999.9999
SA	Reference area	This is the area with the specific color to be measured when a range is set.	0 to 999999999
SX	Reference point X	This is the X coordinate of the center of gravity when a range is set.	-99999.9999 to 99999.9999
SY	Reference point Y	This is the Y coordinate of the center of gravity when a range is set.	-99999.9999 to 99999.9999
DF	Area difference	This is the difference between the reference area and the measured area.	-99999.9999 to 99999.9999

 4-9 Calculations and Judgements Using Inspection Item Data: p. 75

Measurement Data That Can Be Logged for Area

The following values can be logged as measurement data.

Measured item	Range of value	Description
D. Area	-360,960 to 360,960	This is the difference between the standard color area and the measured color area.

 7-4 Logging Measurement Data and Image Data: p. 110

Errors

Errors in Teaching

A teaching error message will appear if the reference area registered during teaching is 0. Perform the following.

- If the color of the measurement object has changed from the specified color, set the color again and try teaching again.

If the specified color is not found during teaching, the reference area will be registered as 0. If having no area is OK, adjust the judgement parameters with this value as the reference.

4-8 Inspecting with Color Data Inspection Item

Color Data Inspection Item

This inspection item is used to perform inspections for foreign matter with a different color or for presence. The region is set for a portion of the image with the color that is to be measured. This region is called the measurement region. The average color within the measurement region is measured.



Setup Procedure for Color Data Inspection Item

Step 1 Selecting the Inspection Item

► [Inspect] – [Inspection]

- 1 Press an unused inspection item number and press [Add item.].
- 2 Press [Color Data].

 Registering inspection items: p. 50



Step 2 Teaching

Teaching means to store the region and the average color in the region as reference data for the measurement.

► [Inspect] – [Inspection] – [Add item.] – [Color Data] – [Settings] Tab Page

- 1 Press [Teach].
- 2 Place the object that is to be used as the measurement reference in front of the camera.
- 3 Move the rectangle to the location to be measured.
- 4 Press [OK].
- 5 Press [TEACH] on the lower right of the display.
The basic settings will be registered when teaching has been completed.
- 6 Press [Back] to end teaching.

Drag the rectangle to move it.
Drag a corner to size the rectangle.

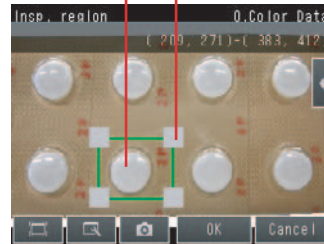

Changing the measurement region: p. 57

The following data is stored as the measurement reference.

Item	Parameter	Description
Reference data	Hue	The hue to use as a reference is set automatically.
	Saturation	The saturation to use as a reference is set automatically.
	Brightness	The brightness to use as a reference is set automatically.

Step 3 Adjusting Judgement Parameters

► [Inspect] – [Inspection] – [Add item.] – [Color Data] – [Settings] Tab Page

- 1 Press [Judgement].
- 2 Set the range of color differences that are to be judged as OK.
Continuous measurements will be performed for the images that are displayed.
- 3 Press [OK] to enter the value.

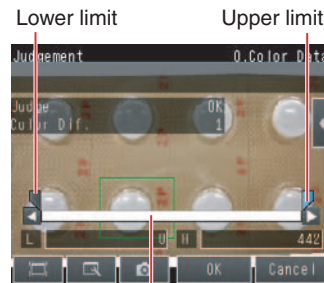

Blue for OK. Red for NG.

Item	Parameter	Setting	Description
Judgement Parameter	Color Dif.	Range: 0 to 442 Default: Lower limit: 0, Upper limit: 442	Sets the upper and lower limits of the difference between the average color and reference color that is to be judged as OK.

Measurement Data That Can Be Used for External Outputs and Calculations

The following values can be used as measurement data and output to external devices via the Ethernet or used in calculations.

Expression text string	Data name	Description	Data range
JG	Judgement	This is the judgement result.	-2: No judgement (not measured), 0: Judgement is OK, -1: Judgement is NG, -13: Teaching not performed error, -14: Figure not registered error, -15: Out of range error
AR	R average	This is the average value of the R (red) component.	0 to 255
AG	G average	This is the average value of the G (green) component.	0 to 255
AB	B average	This is the average value of the B (blue) component.	0 to 255
AD	Color difference	This is the difference between the average color and reference color within the region.	0 to 442
DV	Color deviation	This is the color deviation within the region.	0 to 221

 4-9 Calculations and Judgements Using Inspection Item Data: p. 75

Measurement Data That Can Be Logged (Color Data)

The following values can be logged as measurement data.

Measured item	Range of value	Description
Color Dif.	0 to 442	This is the difference between the color that was registered as the reference and the measured color. The average color within the measurement area is used in both cases.

 7-4 Logging Measurement Data and Image Data: p. 110

Increasing Processing Speed for Color Data

Make the measurement region smaller to reduce the processing time.

 Changing the measurement region: p. 57

4-9 Calculations and Judgements Using Inspection Item Data

You can set inspection item judgement results and measurement data with the Calculation menu command to use them in basic arithmetic operations and functions. The judgement results of the calculations are reflected in the overall judgement.

Calculation

Use the Calculation menu command to set the calculation expressions and the judgement parameters for the calculation results.

Expression

You can get up to 32 expressions. You can also combine expressions.

You can use the following values in calculations.

- Inspection item data (measurement data, reference values, and judgement results)
- Constants
- Other calculation results

Judgement

Upper and lower limit values are used for the judgement of calculation results (D0 to D31). Each calculation judgement result (J0 to J31) is turned ON if the result falls within the upper and lower limits. The OR logic of these results will be the overall judgement result JG.

Outputting the Calculation Results

The overall judgement (JG) of the calculations are reflected in the overall judgement of the inspection item. The calculation results (D0 to 31) can be output as Ethernet outputs or it can be output by using logging.

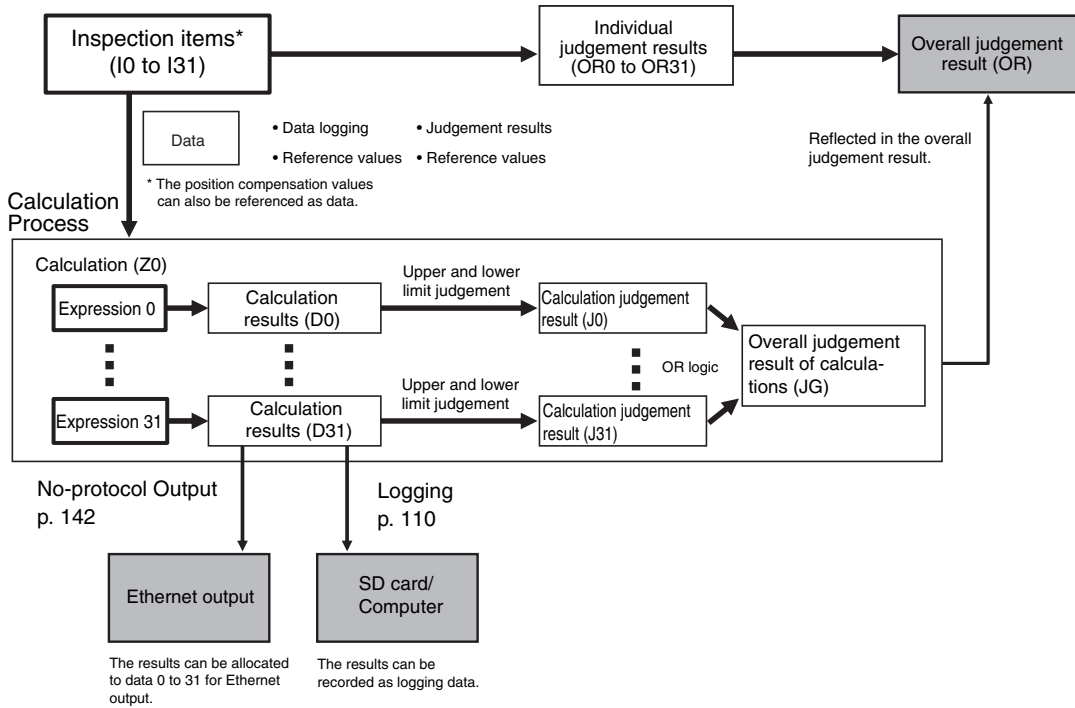

Examples for Calculation

Finding the Distance between Two Measured Points

This example finds edge position 2 by detecting the two edge positions of inspection item 0 and inspection item 1, and calculates the distance between the two points.

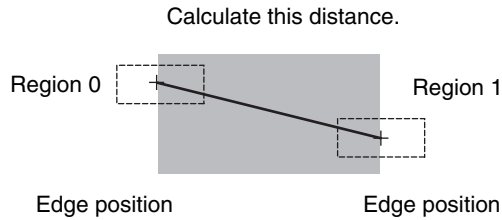

- Region 0 (edge position coordinates of inspection item 0): (I0.X,I0.Y)
- Region 1 (edge position coordinates of inspection item 1): (I1.X,I1.Y)
- Distance between two points = DIST (I0.X,I0.Y,I1X,I1.Y)

Procedure (Calculation)

- 1 Press [Inspect] – [Calculation].



Setting Expressions

- 1 Press [Expression] on the [Settings] Tab Page.

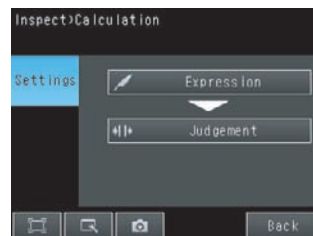

- 2 Press the expression number that you want to use.

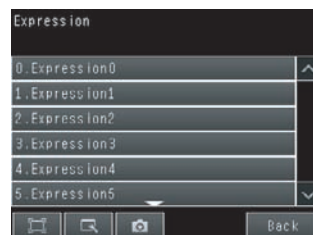

3 Press [Modify] on the menu.

Note

Performing Similar Calculations At Different Locations

- [Rename] The name of the calculation can be changed. (16 characters max.)
- [Copy] Previously registered calculation expressions can be copied.



4 Set the expression by selecting items from the [Data], [Const.], and [Math.] Tab Pages.

The expression will be displayed in the space under [Expression settings].

Do not exceed 255 characters in the expression.

Item	Description
Const.	Press this to input constants or a mathematical operator. The following operators can be used: + (addition), - (subtraction), × (multiplication), and / (division).
Data	Press this to use measurement data, reference values, and judgement results of other items.
Math.	Press this to use functions.

Expression Notation

Expressions must have the following notation.

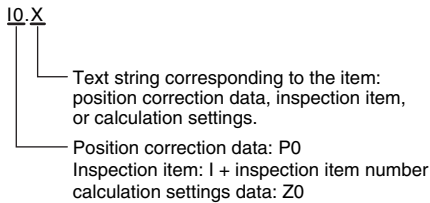

Example: Finding the distance between the centers of gravity of inspection item 1 and inspection item 2 using a function.

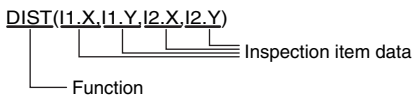

Example: Subtracting 120 from the calculation result of expression 0.

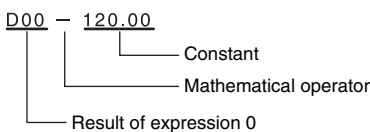

Example: Adding the judgement result of inspection items 0 and 1.

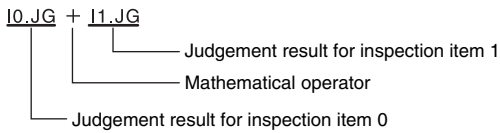

Function List

The following functions can be used in calculations.

Function	Description
SIN	Finds the sine. The result is a value between -1 and 1 . The angle in the expression is in degrees. $SIN(\text{angle})$
COS	Finds the cosine. The result is a value between -1 and 1 . The angle in the expression is in degrees. $COS(\text{angle})$
ATAN	Finds the arctangent of the value (Y component, X component). The result is a radian value between $-\pi$ and π . $ANGL(Y_component, X_component)$ Example: Finding the angle between the straight line joining the centers of region 0 and region 1 and horizontal. $ATAN(R1.Y-R0.Y, R1.X-R0.X)$ If the two arguments are both 0, the result is 0 and the judgement is NG.
AND	Finds the logical AND. If one of the arguments is 0, the calculation result is 0. Otherwise it is -1 . $AND(\text{argument}_1, \text{argument}_2)$
OR	Finds the logical OR. If both of the arguments are 0, the calculation result is 0. Otherwise it is -1 . $OR(\text{argument}_1, \text{argument}_2)$
NOT	Applies a logical NOT operation. If the argument is 0, the calculation result is -1 . Otherwise it is 0. $NOT(\text{argument})$
ABS	Finds the absolute value. $ABS(\text{argument})$
MAX	Returns the larger of the two arguments. $MAX(\text{argument}_1, \text{argument}_2)$
MIN	Returns the smaller of the two arguments. $MAX(\text{argument}_1, \text{argument}_2)$

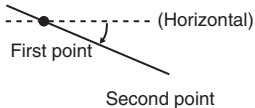
Function	Description
ANGL	<p>Finds the angle of the straight line joining two points (the center of gravity and center of the model). The angle against the horizontal is found. The result is a value between -180 and 180.</p> <p><i>ANGL(Y_component, X_component)</i></p> <p>Example: Finding the angle of the straight line joining the centers of region 0 and region 1</p> <p><i>ANGL(R1.Y-R0.Y, R1.X-R0.X)</i></p>  <p>If the two arguments are both 0, the result is 0 and the judgement is NG.</p>
MOD	<p>Finds the remainder after dividing a non-ordinal number with an ordinal number.</p> <p><i>MOD(non-ordinal, ordinal)</i></p> <p>If any of the arguments are real numbers, the decimals are rounded off before calculating the remainder. The remainder is the result of dividing integers.</p> <p>Example: <i>MOD(13,4)</i> ... Result: 1 (remainder when 13 is divided by 4)</p> <p><i>MOD(25.68,6.99)</i> ... Result: 5 (remainder when 26 is divided by 7)</p>
SQRT	<p>Finds the square root.</p> <p>If the argument is negative, the result is 0. The judgement will be NG.</p> <p><i>SQRT(argument)</i></p>
DIST	<ul style="list-style-type: none"> Finds the distance between two points (the center of gravity and the center of the model). <p><i>DIST(first_position_X, first_position_Y, second_position_X, second_position_Y)</i></p> <p>Example: Finding the distance between the centers of gravity of region 0 and region 1</p> <p><i>DIST(R0.X, R0.Y, R1.X, R1.Y)</i></p> <p>The following calculation is performed internally.</p> $\sqrt{(R1.X-R0.X)^2+(R1.Y-R0.Y)^2}$ <ul style="list-style-type: none"> Finds the length of a perpendicular line from point (x,y) to line $ax + by + c = 0$. <p><i>DIST(X_coordinate_of_point, Y_coordinate_of_point, coefficient_a_of_line, coefficient_b_of_line, coefficient_c_of_line)</i></p>

Setting Judgement Parameters for Expressions

1 Press [Judgement] on the [Settings] Tab Page.

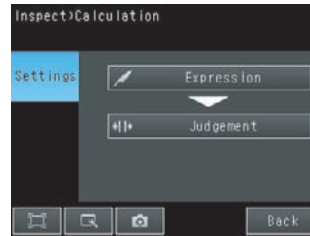

2 Press an expression between 0 to 31 and set the corresponding judgement parameters using the slider.

3 Press the [OK] Button.

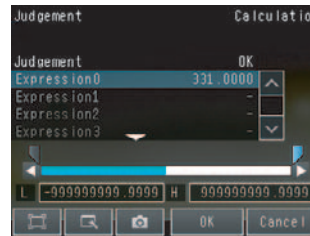

Inspection Item Data That Can Be Used in Expressions

Inspection item	Data name	Expression text string	Data range	Default
Position compensation	Judgement	JG	-2: No judgement (not measured) 0: Judgement is OK -1: Judgement is NG -13: Teaching not performed error -14: Figure not registered error -15: Out of range error	-2
	Position X	X	-99999.9999 to 99999.9999	0
	Position Y	Y	-99999.9999 to 99999.9999	0
	Correlation	CR	0 to 100	0
	Reference position X	SX	-99999.9999 to 99999.9999	0
	Reference position Y	SY	-99999.9999 to 99999.9999	0
	Scroll X	DX	-99999.9999 to 99999.9999	0
	Scroll Y	DY	-99999.9999 to 99999.9999	0
Search	Judgement	JG	-2: No judgement (not measured) 0: Judgement is OK -1: Judgement is NG -13: Teaching not performed error -14: Figure not registered error -15: Out of range error	-2
	Position X	X	-99999.9999 to 99999.9999	0
	Position Y	Y	-99999.9999 to 99999.9999	0
	Angle	TH	-180 to 180	0
	Correlation	CR	0 to 100	0
	Reference position X	SX	-99999.9999 to 99999.9999	0
	Reference position Y	SY	-99999.9999 to 99999.9999	0
	Reference angle	ST	-180 to 180	0
Edge position	Judgement	JG	-2: No judgement (not measured) 0: Judgement is OK -1: Judgement is NG -13: Teaching not performed error -14: Figure not registered error -15: Out of range error	0
	Edge position X	X	-99999.9999 to 99999.9999	-2
	Edge position Y	Y	-99999.9999 to 99999.9999	0
	Offset amount	DF	-99999.9999 to 99999.9999	0
	Reference position X	SX	-99999.9999 to 99999.9999	0
	Reference position Y	SY	-99999.9999 to 99999.9999	0
Edge Width	Judgement	JG	-2: No judgement (not measured) 0: Judgement is OK -1: Judgement is NG -13: Teaching not performed error -14: Figure not registered error -15: Out of range error	-2
	Edge width	W	0 to 99999.9999	0
	Width difference	DF	0 to 99999.9999	0
	Reference width	SW	0 to 99999.9999	0

Inspection item	Data name	Expression text string	Data range	Default
Area	Judgement	JG	-2: No judgement (not measured) 0: Judgement is OK -1: Judgement is NG -13: Teaching not performed error -14: Figure not registered error -15: Out of range error	-2
	Area	AR	0 to 999999999.9999	0
	Gravity X	X	-99999.9999 to 99999.9999	0
	Gravity Y	Y	-99999.9999 to 99999.9999	0
	Reference area	SA	0 to 999999999	0
	Reference position X	SX	-99999.9999 to 99999.9999	0
	Reference position Y	SY	-99999.9999 to 99999.9999	0
	Area difference	DF	-99999.9999 to 99999.9999	0
Color data	Judgement	JG	-2: No judgement (not measured) 0: Judgement is OK -1: Judgement is NG -13: Teaching not performed error -14: Figure not registered error -15: Out of range error	-2
	R average	AR	0 to 255	0
	G average	AG	0 to 255	0
	B average	AB	0 to 255	0
	Color difference	AD	0 to 442	0
	Color deviation	DV	0 to 221	0

The following values can be specified as calculation data to output them.

Data name	Expression text string	Description
Judgement	JG	This is the judgement result. It is the OR logic of the judgement results of all expressions.
Data 0	D00	This is the result of expression 0.
Data 1	D01	This is the result of expression 1.
Data 2	D02	This is the result of expression 2.
Data 3	D03	This is the result of expression 3.
Data 4	D04	This is the result of expression 4.
Data 5	D05	This is the result of expression 5.
Data 6	D06	This is the result of expression 6.
Data 7	D07	This is the result of expression 7.
Data 8	D08	This is the result of expression 8.
Data 9	D09	This is the result of expression 9.
Data 10	D10	This is the result of expression 10.
Data 11	D11	This is the result of expression 11.
Data 12	D12	This is the result of expression 12.
Data 13	D13	This is the result of expression 13.
Data 14	D14	This is the result of expression 14.
Data 15	D15	This is the result of expression 15.
Data 16	D16	This is the result of expression 16.
Data 17	D17	This is the result of expression 17.
Data 18	D18	This is the result of expression 18.
Data 19	D19	This is the result of expression 19.
Data 20	D20	This is the result of expression 20.
Data 21	D21	This is the result of expression 21.
Data 22	D22	This is the result of expression 22.

Data name	Expression text string	Description
Data 23	D23	This is the result of expression 23.
Data 24	D24	This is the result of expression 24.
Data 25	D25	This is the result of expression 25.
Data 26	D26	This is the result of expression 26.
Data 27	D27	This is the result of expression 27.
Data 28	D28	This is the result of expression 28.
Data 29	D29	This is the result of expression 29.
Data 30	D30	This is the result of expression 30.
Data 31	D31	This is the result of expression 31.

Measurement Data That Can Be Logged

The following values can be logged as measurement data.

Parameter	Setting	Description
Results 0 to 31	-999999999.9999 to 999999999.9999	This is the results of expressions 1 to 31.

Testing and Saving Settings

5-1 Performing Test Measurements.....	86
5-2 Shortening the Measurement Takt Time.....	88
5-3 Adjusting the Judgement Parameters.....	89
5-4 Checking a List of All Inspection Item Results	91
5-5 Saving Data to the Sensor.....	92

5-1 Performing Test Measurements

After completing the settings in the [Image], [Inspect], and [In/Out] Tab Pages, move to the [Test] Tab Page. The displayed image is measured automatically. This is called a test measurement. A test measurement is used to verify that the settings that have been made will produce stable results and, if necessary, to fine-tune the settings. An overall judgement of all inspection items can be performed. Test measurements can be performed for through images (default) or saved images.

Performing Test Measurements with Samples

► [Test] – [Continuous test]

- 1 Press [Graphics+Details].
- 2 Input an image of a previously prepared object. Check the judgement results.
- 3 When you finish checking the results, press [Back].



Note

The same five types of displays are available for the [Continuous test] on the [Test] Tab Page, i.e., [Graphic], [Graphics + Details], [All results/region], [Trend monitor], and [Histogram]. Press the [Back] Button to access the menu to change the display.

 Changing the Run Mode display: p. 96

Performing Test Measurements with Saved Images (Re-measuring)

This Sensor can save measured images in the Sensor's built-in memory or on an SD card. Test measurements can be performed using these saved images. This function is useful for adjusting the judgement parameters when objects are not available.

► [Test] – [Continuous test] – (Any display)

- 1 Press  - .



2 Select [Log] or [File].

Images in the Sensor's built-in memory: Press *Log*.



Images on the SD card: Press *File*.

3 The display switches to the saved image and measurements are taken again.

 Saving images: p. 122



5-2 Shortening the Measurement Takt Time

Checking the Measurement Takt Time

The measurement time of this Sensor can be checked from the Setup or Run Mode display.



The measurement time is the time taken from when a trigger is input until when all measurement processes are executed.

During the measurement time, this Sensor will not accept the next trigger. This means that the measurement time is the basic measurement takt time.

Inputting a trigger

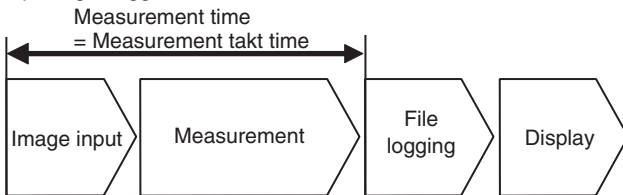

Increasing Image Input Speed

With the partial input function, it is possible to input only images that are in the region that is necessary for measurements.

The image measurement region becomes smaller and thus the image input time is shortened.

► [Image] – [Camera setup]

- 1 Press [◀] – [Partial input] on the right side of the display.
- 2 Change the input size.
- 3 Press [OK].
- 4 Press [Back].



Important

If you use partial input, perform teaching again.

5-3 Adjusting the Judgement Parameters

Adjusting Judgement Parameters While Looking at Measurement Results

If correct judgements are not possible, you can move directly from the Setup Mode display to the judgement parameters display to make adjustments.

► [Test] – [Continuous test] – (Either display)

- 1 Press [◀] – [Adjust judgement] on the right of the display.
- 2 Adjust the judgement parameters.

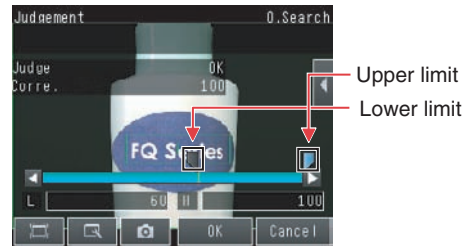

Setting Up the Best Judgement Parameters Automatically

The judgement parameters of the selected inspection items can be automatically adjusted by using actual workpieces which are considered as good and faulty products.

► [Test] – [Continuous test]

- 1 Move to the inspection item for which you want to automatically adjust the judgement parameters and press [◀] – [Adjust judgement] on the right side of the display.
- 2 Press [◀] – [Auto adjustment].
- 3 Display a sample image of a good object and press [OK Teach]. Display a sample image of a bad object and press [NG Teach].

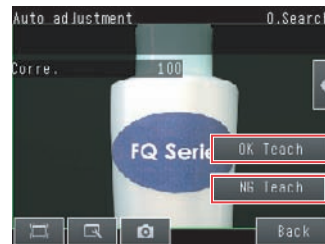

- 4 Repeat these steps for at least three samples each.
- 5 Press [Back].
The best judgement parameters will be set automatically.
- 6 Press [OK].

Note

You can select one of the following three patterns as the judgement method.

► [◀] – [Select the method.] on the right side of the display

- 1) Threshold (minimum): The lower limit of the variations between OK object is used as the judgement condition.
- 2) Threshold (average): The median value between the OK object variations and NG object variations is used as the judgement condition.
- 3) Threshold (maximum): The upper limit of the variations between NG object is used as the judgement condition.

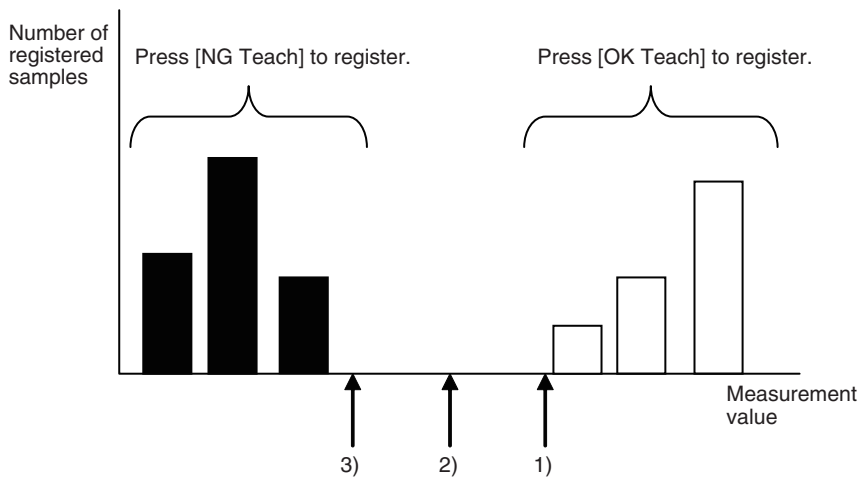

5-4 Checking a List of All Inspection Item Results

Individual judgement results for all inspection items can be checked in a list. The individual inspection items can be selected to change the judgement parameters.

► [Test] – [Continuous test]

1 Press [All results/region] to display the list.

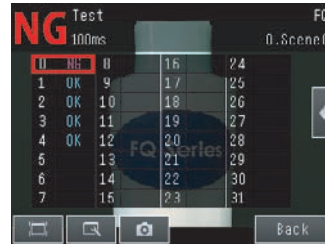

Note

Judgement parameters can also be changed from this display. Select an inspection item and press [◀] – [Adjust judgement].

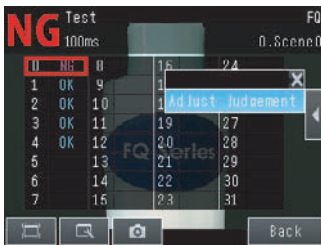

5-5 Saving Data to the Sensor

Until you have saved your settings explicitly to the memory in the FQ Vision Sensor, the settings are only stored temporarily. They will be lost if the power is turned OFF. Execute [Save data] after you have finished making your settings. The FQ Vision Sensor will remind you to do so with a message if you switch from Setup Mode to Run Mode. You can use this feature to keep the previous settings and discard the new settings if desired, but keep in mind that all settings that are not saved explicitly are replaced by the settings that are stored in the memory of the FQ Vision Sensor the next time you turn ON the FQ Vision Sensor.

Important



Do not turn the power supply OFF while data is being saved. The data that is being saved may become corrupted.

► [Test]

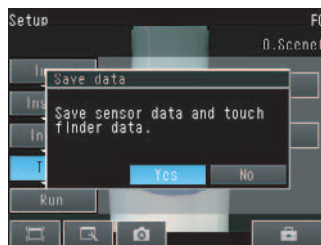
- 1 Press [Save data].
- 2 Press [Yes].



Note

- Scene data and system data can be saved in this way.
 Scene data and system data details: p. 117
- Measurement data and image data cannot be saved in this way.
 Logging measurement data: p. 110
- Settings data can also be backed up to an external memory.
 Saving settings: p. 117

Operation

6-1 Starting Operation	94
6-2 Configuring the Run Mode Display	96
6-3 Checking the Trend of Measurement Results with Graphs	98
6-4 Adjusting Judgement Parameters during Operation	101

6-1 Starting Operation

When test measurements and adjustments in Setup Mode have been finished, the display moves to Run Mode and actual measurements begin. In Run Mode, the Sensor operates stand-alone and outputs the measurement judgement results on the I/O lines accordingly to the settings. If the Touch Finder or the PC Tool is connected via network to the Sensor, the operation of the Sensor can be monitored in the following ways.

Run Mode Display

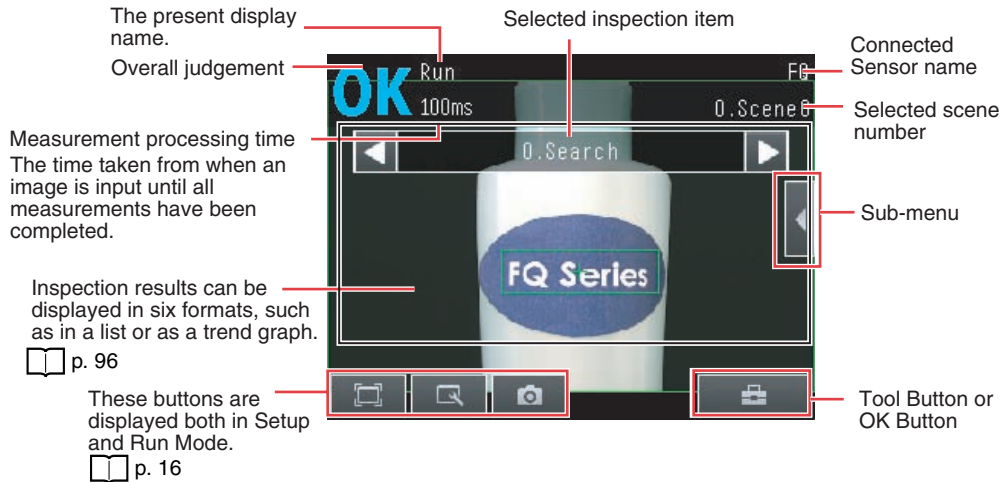

Moving to Run Mode

You can move from Setup Mode to Run Mode by using the following procedure.

- 1 Press [Run].**
- 2 Press [Switch to Run mode.].**
- 3 Press [Yes].**
If you press [No], the setting will not be saved and you will move to Run Mode.

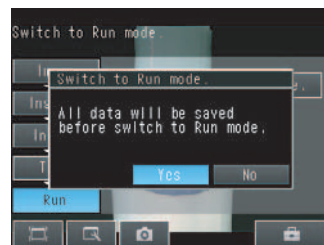
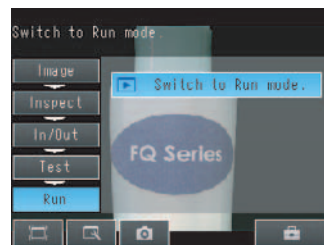

Note

- Returning to Setup Mode

Press  and press [Sensor settings].

- Signal Status When Moving to Run Mode

When moving to Run Mode, the signal will change as shown below and data can be input from and output to an external device.

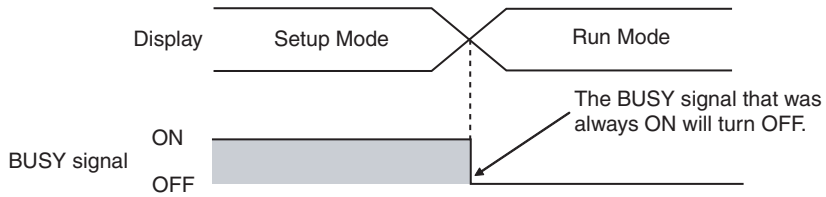

6-2 Configuring the Run Mode Display

There are six types of displays that can be used, as shown below. Select the display as desired.

Checking the Judgement Results of Inspection Items

Graphics



The image and region currently being measured will appear.

Graphics + Details



In addition to [Graphics] display, individual judgement results and measurement values of selected inspection items will appear.

Checking the Overall Judgement Result History

Statistical data



The currently measured image and history of the overall judgement results (measurement count, NG count, and NG rate) will appear.

Checking the Judgements of All Inspection Items in a List

All results/region
(Standard Models Only)



The judgement results of all inspection items can be checked in a list.

Displaying Measurement Result Histories

Trend monitor



The statistical data for the currently selected inspection item can be checked against time.

p. 98

Histogram



The distribution of measurement results of the currently selected inspection item can be checked.

p. 99

▶ (Run Mode) – [Select display]

The following displays are convenient if more than one Sensor is connected.

Multi sensor

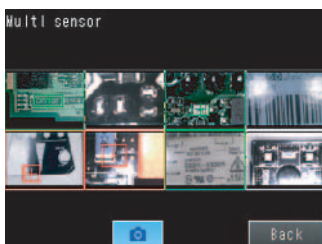

Displays the measurement results of all connected Sensors.
Green display: OK, Red display: NG

NG sensor

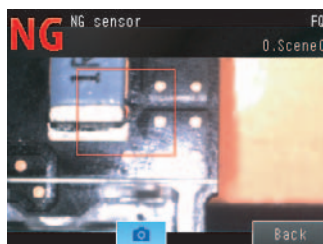

Automatically changes to the display for any Sensor with an NG result.

▶ (Run Mode) – [Sensor monitor]

Specifying the Startup Run Mode Display

The display that appears when power supply is turned ON can be set.
The default setting is [Graphics].

▶  (Setup Mode or Run Mode) – [TF settings] – [Startup display] – [Display pattern]

Note

You can set the scene to be displayed when the power supply is turned ON.

 Setting the Startup Scene: p. 105

Displaying the Inspection Item Results

You can scroll through the measurement results of all the configured inspection items by using the following operations.

Switches to the previous inspection item.



Switches to the next inspection item.

Note

The following are also displayed in addition to the measurement results for each inspection item.

- Camera input: The image that is being measured is displayed.
- Position comp.: The result of position compensation is displayed.
- All Region: The measurement regions for all inspection items are displayed.

6-3 Checking the Trend of Measurement Results with Graphs

Measurement result histories can be checked using the trend monitor and histograms.

Trend Monitor

Changes in the measurement values of the selected inspection item against time can be observed from the graph. It becomes possible to predict when malfunctions may occur or to analyze the cause of the malfunction by checking the trends in the measurement values. The most recent 1,000 measurement values are displayed on the graph.

• [Trend Monitor] Display

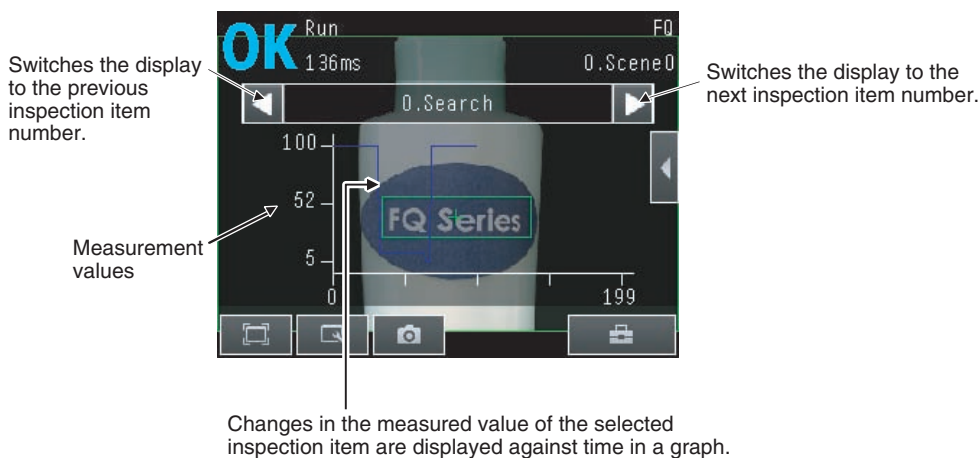

► (Run Mode) – [Select display] – [Trend monitor]

Arranging the Trend Monitor Display

The display range for the vertical axis and display conditions for the horizontal axis can be changed. However, the display range and the number of data settings are disabled when a display other than the trend monitor is displayed.

• Disabling Automatic Selection of the Display Range

- 1 Press [] – [Auto display] on the right of the trend monitor.
- 2 Press [OFF].

• Changing the Display Range of the Vertical Axis

- 1 Press [] – [Display range] on the right of the trend monitor.
- 2 Set the minimum and maximum values of the measurement values.

• Changing the Number of Values That Are Displayed

- 1 Press [] – [Number of data] on the right of the trend monitor.
- 2 Select the number of values from 200, 400, and 1,000.

Note

- Trend monitor data is held until the power supply is turned OFF.
- You can select whether to display all data on the trend monitor or only data for which the overall judgement is NG. Logging settings are applied to the trend monitor as well. However, they are not applied to trend monitor when it is displayed in Setup Mode.

 Check recent measurement trends (recent results logging): p. 113

Histograms

The distribution of each measurement value can be checked on a histogram. The most recent 1,000 measurement values are displayed on a graph.

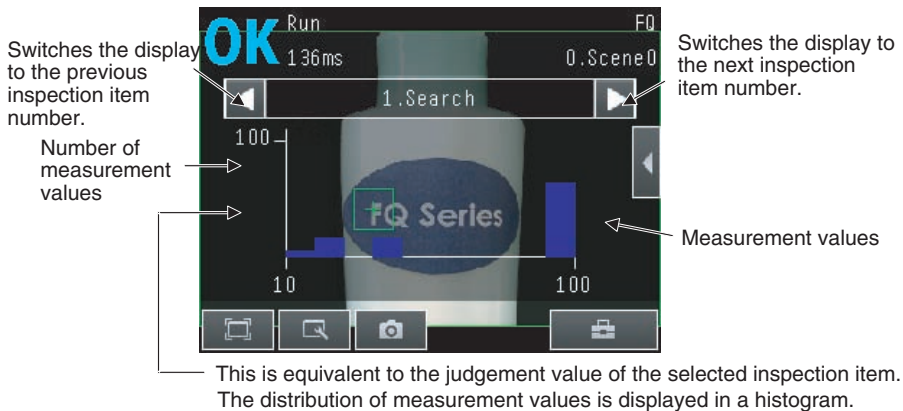

▶  (Run Mode) – [Select display] – [Histogram]

Arranging Histogram Display

The display range on the horizontal axis and the number of data on the vertical axis of the histogram can be changed.

• Disabling Automatic Adjustment of the Display Range

- 1 Press [◀] – [Auto display] on the right of the histogram.
- 2 Press [OFF].

• Changing the Display Range of the Horizontal Axis

- 1 Press [◀] – [Display range] on the right of the histogram.
- 2 Select the maximum measurement value, the minimum measurement value, and the class.

• Changing the Number of Data on the Vertical Axis

- 1 Press [◀] – [Number of data] on the right of the histogram.
- 2 Select the maximum number of data to display.

Note

-
- Histogram data is held until the power supply is turned OFF.
 - You can select whether to display all data in the histogram or only data for which the overall judgement is NG. Logging settings are applied to the histogram as well. However, they are not applied to histograms displayed in Setup Mode.



Check recent measurement trends (recent results logging): p. 113

6-4 Adjusting Judgement Parameters during Operation

This Sensor enables judgement parameters to be adjusted while measurements are being performed. Downtime can be eliminated with this feature because the production line does not have to be stopped while making adjustments.

Preparations

This function is switched OFF as a default to prevent it from inadvertently working during operation. Turn ON the function if you want to use it.



▶ (Setup Mode) – [Sensor settings] – [Adjustment mode in Run]

- 1 Press [ON].

Changing the Judgement Parameters in Run Mode

This section describes how to change the judgement parameters without stopping measurement in Run Mode.

▶ Run Mode

- 1 Select the inspection item for which you want to adjust the judgement parameters using the  and  Buttons.
- 2 Press [] – [Adjust judgement].
- 3 Change the adjustment parameters with the slider.
- 4 Press [OK].
The judgement results with the changed judgement parameters will appear.



Important

The changed judgement parameters will not be reflected in the measurement result until [OK] is pressed.

MEMO

Convenient Functions

7-1 Changing the Scene to Change the Line Process	104
7-2 Display Functions	106
7-3 Monitoring the Signal I/O Status.....	109
7-4 Logging Measurement Data and Image Data	110
7-5 Saving Sensor Settings	117
7-6 SD Card Operations	118
7-7 Convenient Functions for Operation.....	120
7-8 Convenient Functions for Setup.....	122
7-9 Functions Related to the System	123

7-1 Changing the Scene to Change the Line Process

What Are Scenes?

With an FQ Vision Sensor, the inspection items that can be processed at the same time are registered as scenes. A command input from an external device or a touch panel operation can be used to select a certain scene.

If a scene is registered for each type of measurement object or inspection, the line process can be changed simply by changing the scene when the measurement object or inspection changes.

Example:

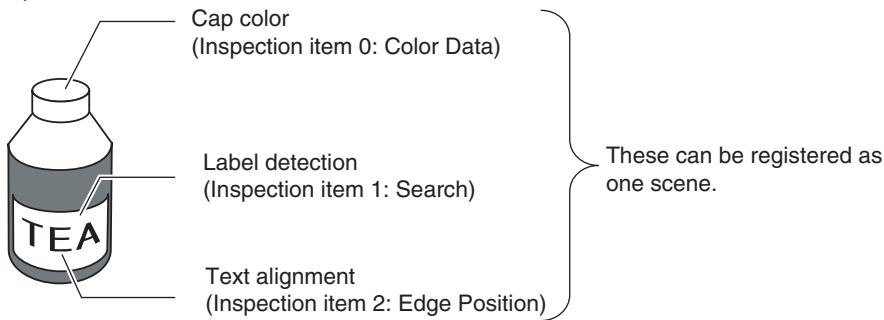

Line Process Changes:

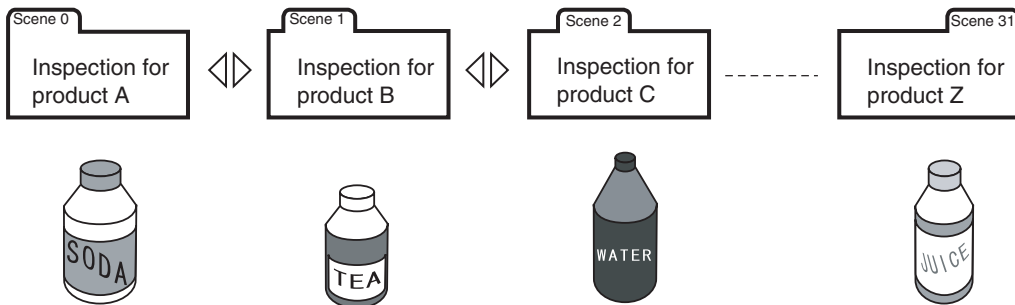

• Maximum Number of Scenes

Item	Model	Standard model (FQ-S2)	Single-function model (FQ-S1)
Number of scenes		32	8

• Settings Included with Scenes

The following settings are changed when the scene is changed: Camera image ([Image] Tab Page) and Inspection Items ([Inspect] Tab Page). The settings related to external I/O specifications that are included in the output settings and the system settings for the overall Sensor are used for all of the scenes.

Refer to the following information for the data that is included in the scene data.

10-1 Menu Tables: p. 172

Creating New Scenes

The default scene number is 0. To create another scene, use the following procedure to switch the scene and then make the settings.

▶ (Setup Mode) – [Select scene]

- 1 Press the number of the scene to change to and then press [Select].
- 2 The scene will change. Make the settings for the scene.

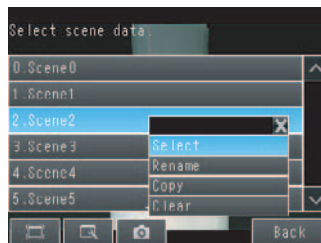

Changing Scene Names, Copying Scenes, and Deleting Scenes

▶ (Setup Mode) – [Select scene]

- 1 Press the number of the scene and then press [Rename], [Copy], or [Clear].
- 2 To change the name, enter a new scene name in 15 alphanumeric characters or less.
To copy a scene, press the number of the scene to copy.

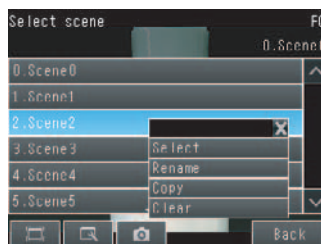

Switching Scenes from an External Device

- Controlling with Parallel Inputs

 Changing the Scene: p. 137

- Controlling with Ethernet Inputs

 Command Details: p. 149

Setting the Startup Scene

▶ (Setup Mode) – [Sensor settings] – [Startup settings]

The following items can be set.

Item	Purpose	Setting range
Startup mode	Select whether the startup scene number is set manually.	ON OFF (The scene number when the settings were saved will be the startup scene number. The startup mode is set to OFF in the default settings.)
Startup scene	Set the scene number to use at startup.	Standard models: 0 to 31, Single-function models: 0 to 8, Default: 0

7-2 Display Functions

The procedures given in this section can be used to make the Sensor easier to use and the display easier to see.

Image Zoom

The display can be zoomed in or out to make the image easier to see.

▶ (Setup Mode or Run Mode)



- Enlarges the display.
- Reduces the display.
- Fits the image to the display size.

Press [Back] to end setting the display.

Displaying a Live Image

You can display a live image to check the image that is input by the Sensor in realtime.

▶ (Setup Mode)

- 1 Press .
- 2 Press [Camera].
- 3 Press [Live].
- 4 Press the [Back] Button to return to the [Display] Display.



Displaying a Frozen Image

You can display a frozen image to stop image refreshing and display the last image that was input.

▶ (Setup Mode)

- 1 Press .
- 2 Press [Camera].
- 3 Press [Freeze].
- 4 Press the [Back] Button to return to the [Display] Display.

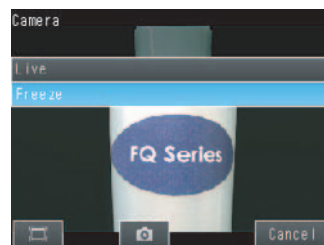

Displaying a Saved Image

You can display an image that was saved in internal memory in the Sensor or in an SD card. This can be done to configure inspection items or to check measurements using saved images.

▶ (Setup Mode)

- 1 Press .
- 2 Images in the Sensor's built-in memory: Press [Log].
Images on the SD card: Press [File].
- 3 Press the [Back] Button to return to the [Display] Display.



Note

Refer to the following information for the procedures to save images.

 Logging Measurement Data: p. 110

Updating the Display and Measurement Results Only for NG Measurement Results

In Run Mode, you can specify updating the display of the image and measurement results only when the measurement result is NG.

▶ (Run Mode)

- 1 Press .
- 2 Press [Last NG image].
- 3 Press [Back].



Change the following setting to display the last NG image after restarting.

▶ (Setup Mode or Run Mode) - [TF Settings] - [Startup display] - [Display update mode]

- 1 Press [Last NG image].



Note

If an operation to change the display is performed (e.g., if the display pattern is changed or the inspection item is changed) when displaying images for NG results is set, the display will change to refreshing the most recent measurement results and the most recent NG display will disappear.
To ensure that you can check the NG results, log the NG results.



Checking Recent Measurement Trends (Recent Results Logging): p. 113

Automatically Changing to the Display for Any Sensor with an NG Result

You can change the settings to automatically display the Sensor for which the measurement result is NG if more than one Sensor is connected.

▶  (Run Mode) – [Sensor monitor] – [NG Sensor]

Hiding the Menu

You can hide the menu and display only the image on the Touch Finder or PC Tool to check the part of the image hidden behind the menu.

If you press the icon again, the menu will be displayed.

▶  (Setup Mode or Run Mode)

Turning ON/OFF the Touch Finder Backlight

You can use Eco Mode to turn OFF the LCD backlight and reduce the power consumed by the Touch Finder whenever there is no operation on the Touch Finder for 30 seconds or longer. The LCD backlight will turn ON whenever any part of the touch panel is pressed.

▶  (Setup Mode or Run Mode) – [TF settings] – [LCD Backlight] – [ECO mode]

Changing the Brightness of the Touch Finder

The brightness of the LCD backlight can be changed to any of five levels.

▶  (Setup Mode or Run Mode) – [TF settings] – [LCD Backlight] – [Brightness]

7-3 Monitoring the Signal I/O Status

You can check if the I/O connections are working normally.

► [In/Out] – [I/O monitor] – [I/O Monitor]

- 1** The I/O status of the external devices will be displayed.
- 2** Press the [OK] Button to return to the [I/O monitor] Display.

Input Signals (TRIG and IN0 to IN5)
Signals that are displayed in red are currently being input from the external devices to the Sensor.

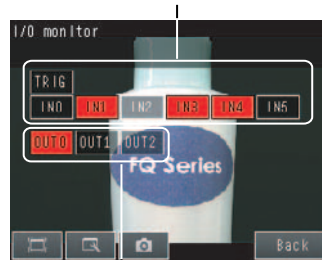

Output Signals

(OUT0, OUT1, and OUT2)

Signals that are displayed in red are currently being output from the Sensor to the external devices.

You can turn the signals ON and OFF by pressing them to test the outputs.

7-4 Logging Measurement Data and Image Data

There are two ways to log data. Data can be temporarily saved in memory inside the Sensor (called recent results logging) or large amounts of data can be saved in SD cards or other external media (called file logging). The amounts of data that can be logged are given in the following table.

Logged data	Recent results logging	File logging
Measurement data (Measured values and calculation results)	1,000 measurement values max.	Up to the capacity of the external memory
Image data (Measured values and calculation results)	20 images max.	

Logging All Data (File Logging)

Large amounts of measurement and image data can be saved in files in external memory (SD cards or computer).

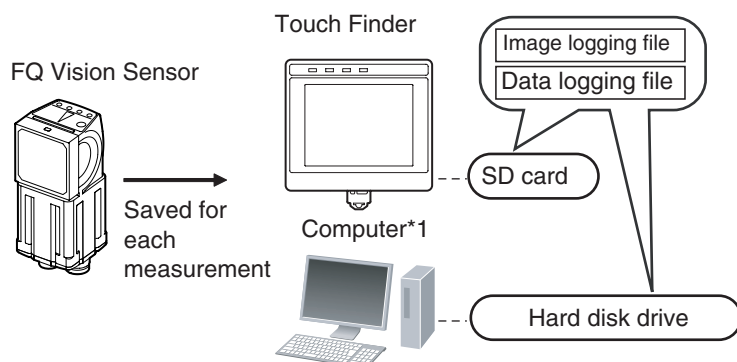

*1: Image data and measurement data can be logged in the same way as for the Touch Finder by installing the PC Tool for FQ.

System Configuration: p. 20

Note

Only the data for the Sensor that is currently being displayed will be logged even if more than one Sensor is connected.

If multiple sensors are displayed, or if the most recent NG sensor is displayed, only the results of the sensor that was displayed before changing to the other sensor monitor screen will continue to be logged. Simultaneous logging of the results of multiple sensors is not possible.

Setting the Data To Be Logged

You can select the data to be logged.

► [In/Out] – [Log setting]

- 1 Press the data for which to change the logging parameter.
- 2 Change the logging parameter and then press [Back].

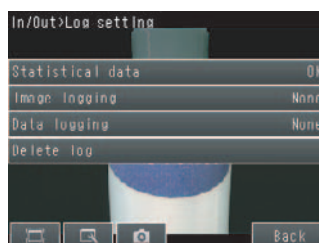

Item	Description
Image logging	<ul style="list-style-type: none"> All: All images will be logged regardless of the measurement results. Only NG: Only images for which the overall judgement was NG will be logged. None: No images will be logged (default).
Data logging	<ul style="list-style-type: none"> All: All measurement data (Measured values and calculation results) will be logged regardless of the measurement results. Only NG: Only measurement data (Measured values and calculation results) for which the overall judgement was NG will be logged. None: No measurement data (Measured values and calculation results) will be logged (default).

Note

The logging parameter settings are the same for file logging and recent results logging.

Starting and Stopping Logging

After logging is started (i.e., set to ON), the specified image data and measurement data will be saved in the SD card or computer hard disk each time measurements are performed.

▶ (Run Mode)

- 1 Press [Logging].
- 2 Press [Image logging] or [Data logging].
- 3 Press [ON] to start logging.
Press [OFF] to stop logging.
- 4 Press [Back].

Saved Log Data

• Storage Locations and File Names for Logged File Data

Data	Storage location	File name
Image logging	\sensor_name\ LOGIMAGE\number ^{*1, *2}	YYYY_MM_DD-HH_MM_SS.IFZ Example: The following name would be used for measurements performed at 10:10:21 pm on March 10, 2010. 2010_03_10-22_10_21.IFZ
Data logging	\sensor_name\LOGDATA ^{*2}	YYYY_MM_DD-HH_MM_SS.CSV Example: The following name would be used for measurements performed at 10:10:21 pm on March 10, 2010. 2010_03_10-22_10_21.CSV

*1: A five-digit number is assigned as a name to the image data storage folder in the order of folder creation as shown below.

Up to 100 images are stored in each folder.

```
00000
00001
⋮
```

*2: Files are stored in the following folder when the PC Tool is used.

My Documents\OMRON FQ\ SDCard

• File format

Image logging: Image data is saved in a special format for OMRON Vision Sensors. (The file name extension is IFZ.)

Data logging: Measurement data is saved in the following CSV format.

<Date*1>,<Time*1>,<Measurement value for inspection item 0>,<Measurement value for inspection item 1>,...,<Measurement value for inspection item 31>,

<D0 of expression 0>, ..., <D31 of expression 31>Delimiter
 ↑
 Field separator
 ↑
 Record separator

*1: The date is given in the following format: 2010/6/1 (for June 1, 2010). The time is given in the following format: 12:01:20 (for 12:01 and 20 seconds pm).

Changing the File Format

The output CSV file format can be changed according to the external device.

Item	Symbol
Field separator	None, comma (default), tab, space, or semicolon
Decimal symbol	None, point (default), or comma
Record separator	None, comma, tab, space, or CR or CF+LF (default)

Use the following menu command to change the output CSV file format.

▶  (Setup Mode or Run Mode) – [TF settings] – [File format]

Ensuring That All Measurement Results Are Logged in External Memory

To ensure that all measurement results are actually saved, change the settings so that the BUSY signal remains ON until logging has been completed. During operation, do not input the next trigger until the BUSY signal turns OFF.

▶ [In/Out] – [I/O setting] – [I/O terminals] – [Output] Tab Page – [BUSY output]

Change the BUSY output parameter to [Data logging].

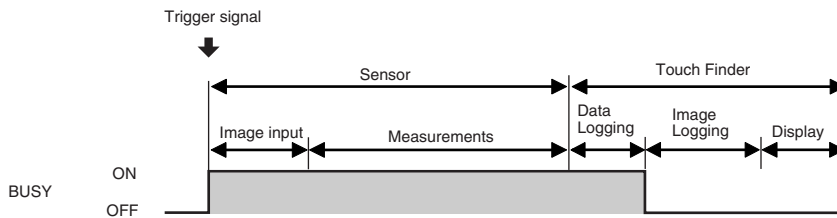

Note

- File logging cannot be used when performing continuous measurements.
- If you use the PC Tool, the logging time may vary by up to 100 ms depending on the application conditions of your computer.
- If logging data to an SD card, the write time varies depending on the amount of the available space on the SD card.

Reference value: For SDHC class 4, the time required to write image data is approx. 200 to 800 ms.

Checking Recent Measurement Trends (Recent Results Logging)

The most recent measurement results can be logged inside the Sensor.

Even if data is not logged in external memory, such as an SD card, trends in measurement results can be easily checked on the Touch Finder.

However, if the power supply is turned OFF or the scene is changed, this data will be lost.

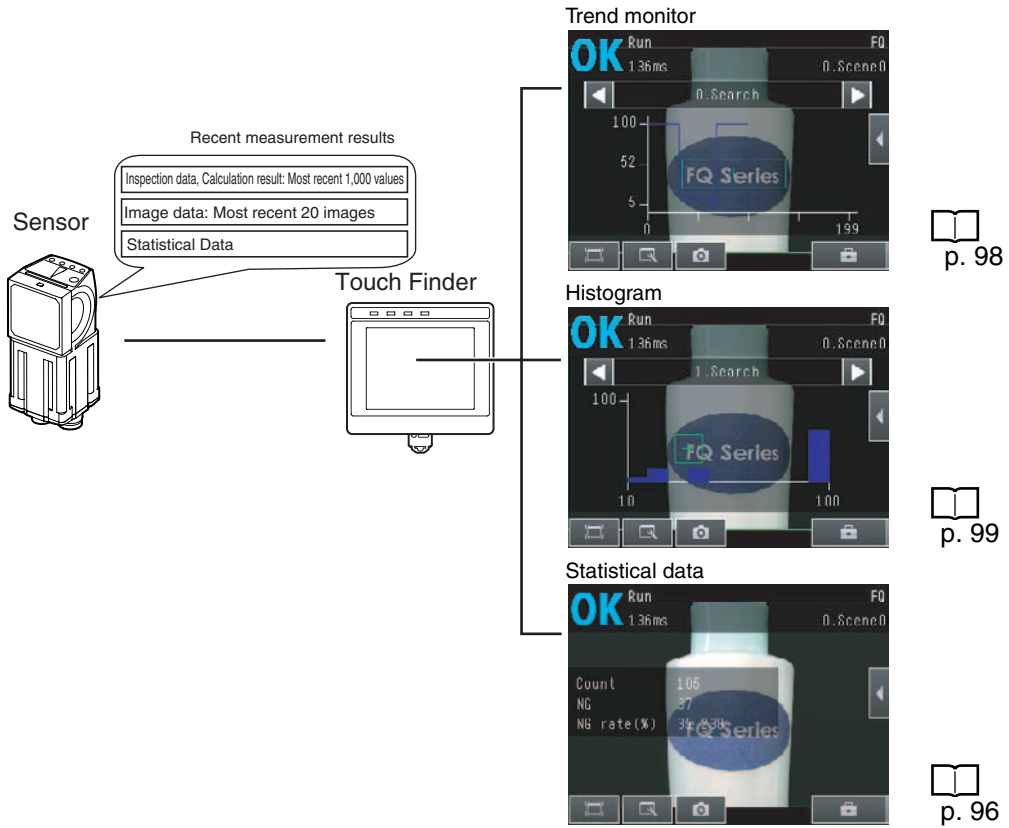



Setting the Data To Be Logged

Use the following procedure to set the statistical data, image data, and measurement data that will be logged.

► [In/Out] – [Log setting]

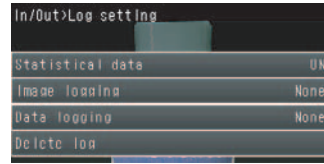
- 1 Press the data for which to change the logging parameters.
- 2 Change the logging parameter and then press [Back].



Item	Description
Statistical Data	Statistical data, such as the number of measurements, the number of NG overall judgements, and the NG rate, since the power supply was turned ON will be logged. <ul style="list-style-type: none">• ON: Statistical data will be displayed (default).• OFF: Statistical data will not be displayed.
Image logging	These are the same as for file logging.
Data logging	 Logging All Data (File Logging): p. 110

Note

The logging parameters for image data and measurement data are the same as those for file logging.

Starting Logging

Logging will be started as soon as the data to be logged has been set.

If the settings are saved, logging will start automatically the next time the power supply is turned ON.

Checking the Results of Logging

The results of logging can be checked using the trend monitors, histograms, or statistical data.

 p. 96

Use the following menu command to check the measurement images.

-  (Setup Mode) –  – [Log]

Deleting Logged Data

The logged data will be deleted when the power supply to the Sensor is turned OFF or the scene is changed. The logged data can also be deleted without turning OFF the power supply.

• Setup Mode

► [In/Out] – [Log setting]

- 1 Press [Delete Log].

Changing the File Format

The output CSV file format can be changed as shown below according to the external device.

 Changing the File Format: p. 112

7-5 Saving Sensor Settings

The Sensor settings are saved in flash memory inside the Sensor.

This section describes how to back up the settings in and restore them from an SD card or other external memory.

Backing Up Settings in External Memory

▶  (Setup Mode) – [Save to file] – [Setting] Tab Page

- 1 Press the data to save.
- 2 Enter the file name in 15 characters or less.
After entering the file name, press [OK]. The data will be saved and the display will return to [Save to file].

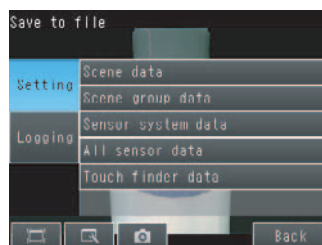

Applicable Data

Data	Storage location	Description
Scene data (The file name extension is SCN.)	\sensor_name\SCN	The following data is backed up for each scene. <ul style="list-style-type: none"> • Settings for all inspection items • Order of inspection items
Scene group data (The file name extension is SGP.)	\sensor_name\SGP	All scene data is backed up.
Sensor system data (The file name extension is SYD.)	\sensor_name\SYD	All system data in the Sensor is backed up. The system data is the same for all scenes.
All Sensor data (The file name extension is BKD.)	\sensor_name\BKD	All settings in the Sensor (all scene data and Sensor system data) is backed up.
Touch Finder data (The file name extension is MSD.)	\MSD	All settings in the Touch Finder are backed up.

For the PC Tool, data will be saved in the following folder: \\.\My Documents\OMRON FQ

Restoring Data to the Sensor from External Memory

▶  (Setup Mode) – [Load from file]

- 1 Press the data to be restored.
- 2 The selected data will be read from external memory and displayed.
Press the file to load.

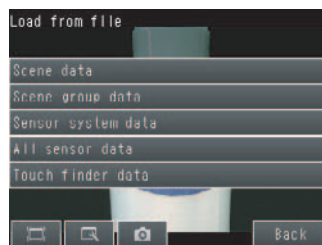

7-6 SD Card Operations

With an FQ Vision Sensor, the following folders are automatically created in the SD card according to the data that is saved. The specified data is saved in files in these folders.

Storage folder*1	Data
\sensor_name\SCN	Scene data (The file name extension is SCN.)
\sensor_name\SGP	Scene group data (The file name extension is SGP.)
\sensor_name\SYD	Sensor system data (The file name extension is SYD.)
\sensor_name\BKD	All sensor data (The file name extension is BKD.)
\MSD	Touch Finder data (The file name extension is MSD.)
\sensor_name\LOGIMAGE	Image data (The file name extension is IFZ.)
\sensor_name\LOGDATA	Statistical data and measurement data (The file name extension is CSV.)
\CAPTURE	Captured images (The file name extension is BMP.)

*1: For the PC Tool, data will be saved in the following folder: \\.\My Documents\OMRON FQ

Note

The PC Tool does not support SD card operations.

Inserting and Removing SD Cards

Inserting an SD Card in the Touch Finder

- 1** Open the cover to the SD card slot on the top of the Touch Finder.
- 2** Insert the SD card with the back of the SD card facing the front of the Touch Finder and press it in until it clicks into place.
- 3** Close the cover to the SD card slot.

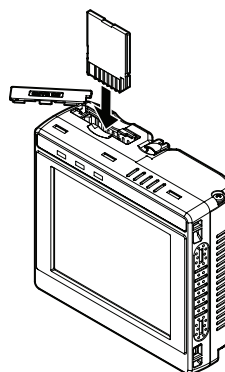
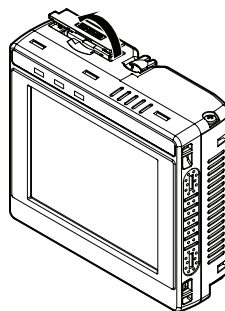

Removing an SD Card from the Touch Finder

- 1 Open the cover to the SD card slot on the top of the Touch Finder.
- 2 Press in on the SD card until you hear a click.
- 3 Pull out the SD card.
- 4 Close the cover to the SD card slot.

- Never remove the SD card while data is being saved or read. The data on the SD card may be corrupted.

Important

Do not restart or turn OFF the power supply to the Sensor or Touch Finder while a message is being displayed saying that data is being saved to or read from the SD card. The settings or system data may be corrupted.

Checking the Available Space on the SD Card

Before saving data to the SD card, use the following display to make sure that there is sufficient space available on the SD card.

- ▶  (Setup Mode or Run Mode) – [TF settings] – [SD card] – [SD card information]

The following information in the SD card inserted in the Touch Finder can be checked.



Formatting an SD Card

- ▶  (Setup Mode or Run Mode) – [TF settings] – [SD card] – [Format]

Press [Yes] to start formatting.

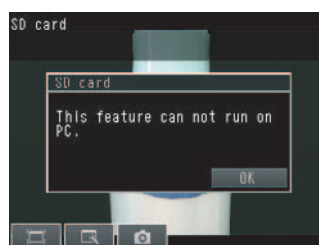

7-7 Convenient Functions for Operation

This section describes the functions that can be used during Sensor operation.

Setting a Password to Prevent Unwanted Changes

A password can be set to prevent unwanted changes to settings.

If a password is set, you cannot change from Run Mode to Setup Mode without entering the password.

Setting a Password

▶  (Setup Mode) – [Sensor settings] – [Password settings]

- 1 Press [Password on/off] and press [ON].
- 2 Press [Enter password].
- 3 Enter a password containing up to 15 characters and press [OK].

Clearing the Password

▶  (Setup Mode) – [Sensor settings] – [Password settings]

Press [Password on/off] and press [OFF].

Entering the password when switching from [Run] Mode to [Setup] Mode.

- 1 If a password is set and you try to change from Run Mode to Setup Mode, the following password entry display will appear.

▶  (Setup Mode) – [Sensor settings]

- 2 Press the text box. A keyboard display will appear. Enter the password and press [OK]. If the password is correct, the Setup Mode will be displayed.

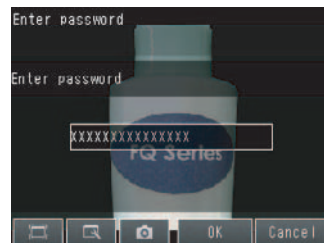

Important

- This password restricts only the operation to switch from Run Mode to Setup Mode. It does not restrict other operations.
- If you forget the password, contact your OMRON representative for the procedure to clear the password.
- The password is deleted when the Sensor is initialized.

Capturing the Displayed Image

The current display on the Touch Finder or PC Tool can be captured and used in text files and other files on the computer.

The captured images are saved in external memory*¹ as bit maps.

*1: Images captured on the Touch Finder are saved in the SD card. Images captured with the PC Tool are saved in the computer's hard disk drive.

▶ (Setup Mode or Run Mode)

The image that is being displayed when the button is pressed is saved in external memory.

• Storage Location and File Names

Storage location	File name
\CAPTURE	YYYY_MM_DD-HH_MM_SS_MS.BMP Example: The following name would be used for an image that was captured at 10:10:21.350 pm on March 10, 2010. 2010_03_10-22_10_21_350.BMP

Important

Make sure an SD card is inserted in the Touch Finder before capturing display images.

Note

For the PC Tool, data will be saved in the following folder: \\.\My Documents\OMRON FQ

7-8 Convenient Functions for Setup

This section describes the functions that can be used when setting inspection items.

Making Settings with Stored Images

With an FQ Vision Sensor, judgement parameters can be set by using the following images.

- Images saved in internal Sensor memory
- Image files in an SD card

Saving Image Data

• Temporarily Saving Images in the Sensor

The measured images can be temporarily saved inside the Sensor. These images are held until the Sensor power supply is turned OFF.

▶ **[In/Out]** – **[Log setting]** – **[Image logging]**

 Setting Logging Parameters for Image Data: p. 113

• Saving Images in the Sensor to an SD Card

The images that are temporarily saved inside the Sensor can be saved to an SD card.

▶  **(Setup Mode)** – **[Save to file]** – **[Logging] Tab Page**

1 Press **[Logging image]**.

2 Select whether to save the most recently logged image or to save all of the data that is logged in the Sensor.

Storage location	File name
\\sensor_name\LOGIMAGE	YYYY_MM_DD-HH_MM_SS.IFZ Example: The following name would be used for files saved at 10:10:21 pm on March 10, 2010. 2010_03_10-22_10_21.IFZ

• Saving Images in an SD Card

The image data can be saved in the SD card each time measurements are performed.

▶  **(Run Mode)** – **[Logging]**

 Logging All Data (File Logging): p. 110

Displaying Image Data

• Images Saved in Internal Sensor Memory

▶  **(Setup Mode)** –  – **[Log]**

• Image Files in a SD Card

▶  **(Setup Mode)** –  – **[File]**

 Arranging the Display - Displaying a Saved Image: p. 107

7-9 Functions Related to the System

This section describes system settings.

Turning OFF the Integrated Sensor Lighting

The internal light can be turned OFF to use external illumination.

▶  [Image] – [Camera setup] – [] – [Lighting control]

Press [OFF].

Switching the Display Language

Any of the following languages can be selected for display on the Touch Panel or PC Tool.

Japanese, English, German, French, Italian, Spanish, Traditional Chinese, Simplified Chinese, or Korean

▶  (Setup Mode or Run Mode) – [TF settings] – [Language]

Press the language to be displayed.

Setting the Time on the Touch Finder

You can set the date and time.

▶  (Setup Mode or Run Mode) – [TF settings] – [Time settings]

Initializing the Sensor and Touch Finder

• Initializing the Sensor

▶  (Setup Mode) – [Sensor settings] – [Initialize]

• Initializing the Touch Finder

▶  (Setup Mode or Run Mode) – [TF settings] – [Initialize]

Restarting the Sensor and Touch Finder

• Restarting the Sensor

▶  (Setup Mode) – [Sensor settings] – [Restart]

• Restarting the Touch Finder

▶  (Setup Mode or Run Mode) – [TF settings] – [Restart]

Checking Versions

- **Checking the Sensor Version**

▶  (Setup Mode) – [Sensor settings] – [Information]

- **Checking the Touch Finder Version**

▶  (Setup Mode or Run Mode) – [TF settings] – [Information]

Checking the Touch Finder Battery Level

▶  (Setup Mode or Run Mode) – [TF settings] – [Battery level]

Important

- The battery level is displayed only for a Touch Finder with a DC/AC/battery power supply (FQ-D31).
- The settings will be lost if the battery runs out while you are making the settings. If the battery level is low, save the settings and charge the battery immediately.

Changing the Sensor Name

An alphanumeric name can be assigned to a Sensor to make it easier to recognize. This is convenient when more than one Sensor is connected.

▶  (Setup Mode) – [Sensor settings] – [Information] – [◀] – [Rename]

Checking Available Memory in the Sensor

If a setting cannot be made, check the amount of memory that is available in the Sensor.

▶  (Setup Mode) – [Sensor settings] – [Information] – [◀] – [Memory State]

Correcting the Touch Screen Positions of the Touch Finder

Use this function to correct the touch screen positions if they are offset from the opposite position.

▶  (Setup Mode) – [TF settings] – [Touch screen calib]

Setting the Resolution of Measurement Objects Displayed on the PC Tool

Use this function to set the resolution of measurement object that are displayed on the Touch Finder on the PC.

▶  (Run Mode) – [TF settings] – [Resolution]

Communications with External Devices

8-1 Controlling/Outputting in Parallel.	126
8-2 Outputting/Controlling with Ethernet.	142

8-1 Controlling/Outputting in Parallel

Operation with Default Configuration

This section describes the basic connections and signal flow with external devices. With the default settings, the Sensor operates in the following manner.

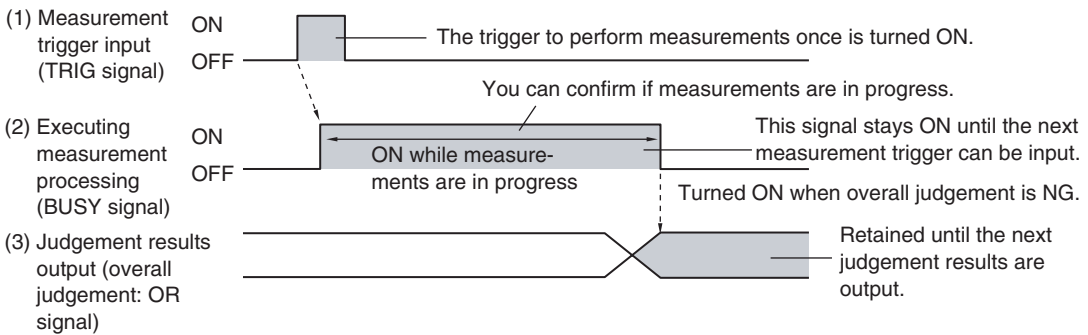
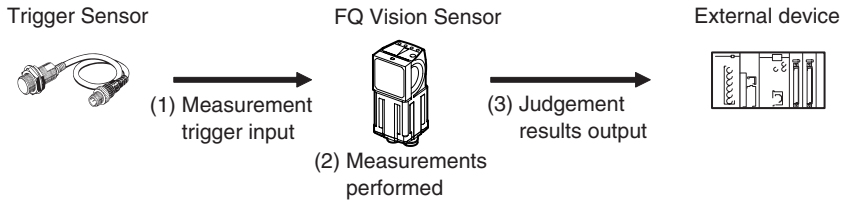

Important

- Create the ladder program to control the TRIG and IN5 input signals so that they do not turn ON while the BUSY signal is ON. If not, a TRIG input error will occur and the ERROR signal will turn ON.

• Operation When the Sensor Power Supply Is Turned ON

The BUSY signal will operate as shown below when the Sensor's power supply is turned ON.

Create the ladder program in the PLC or other external device so that the BUSY signal is ignored while it turns OFF, ON, and OFF again for up to 5 s after the power supply is turned ON.

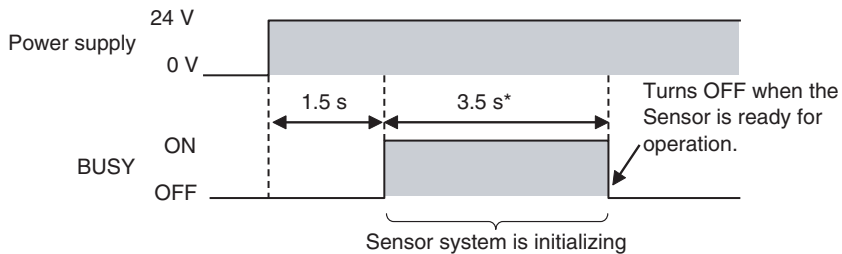

* Depends on the scene data.

Configuring the Operation

The following settings can be selected depending on the system configuration and application.

Type of change	Change	Reference
Changing the type of measurement trigger	Performing continuous measurements	p. 129
Changing the output method of the judgement results	Obtaining individual judgement results	p. 132
	Adjust the judgement output timing	p. 134
	Changing the judgement output ON conditions	p. 136
Changing the polarity of the BUSY output	Reversing the polarity of the BUSY signal	p. 136

Setting the Measurement Trigger

The measurement trigger can be chosen from the following two types:

- One-shot measurement: One measurement is performed for each external trigger.
- Continuous measurement: Measurements are performed continuously.

Performing One Measurement for Each External Trigger

A measurement trigger is input as the TRIG signal from a proximity sensor, PLC, or other external device. One measurement is performed when the TRIG signal turns ON.

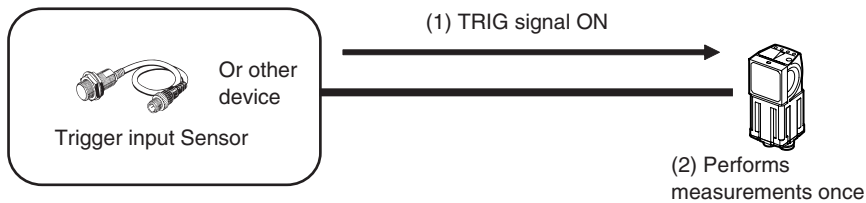

Wiring

Color	Signal	Description
Pink	TRIG	Trigger signal
Black	OUT0 (OR)	Overall judgement (default assignment)
Orange	OUT1 (BUSY)	Processing in progress (default assignment)

The signals shown at the left are used. Refer to the following information for signal wiring.



Wiring: p. 28

Timing Chart

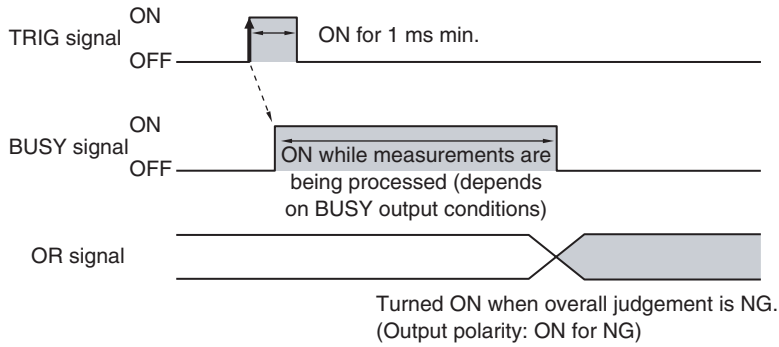

1. Turn ON the TRIG signal while the BUSY signal is OFF.
2. Measurement begins and the BUSY signal is turned ON during the measurement process.
3. When the measurement has been finished, the measurement result is output using an OR signal, and the BUSY signal is turned OFF. *1

*1: You can also set the signal to be turned OFF after data logging, image logging, or displaying results in the [BUSY output].

Important

When the Brightness Correction Mode is ON, the timing when images are taken is delayed.



Timing Chart When the Brightness Correction Mode Is ON: p. 38

Sample Ladder Program

The following sample program is used to input a TRIG signal to perform a single measurement. A single measurement will be performed when W0.00 turns ON.

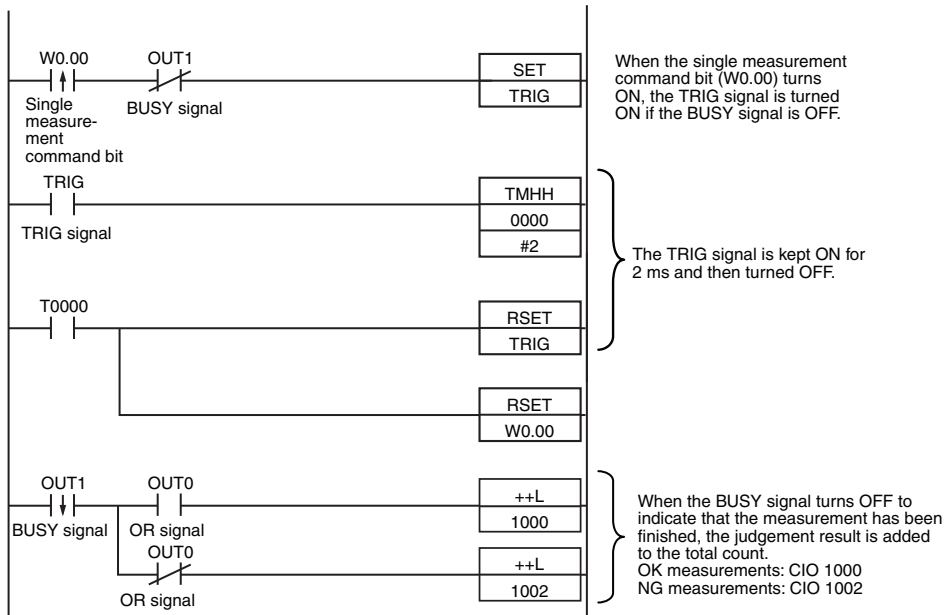

• I/O Signal Allocations

Signal		Address
Output signals	OUT0 (OR signal)	CIO 0.00
	OUT1 (BUSY signal)	CIO 0.01
Input signals	TRIG	CIO 1.00

Important

The BUSY signal will remain ON while the measurement is being executed.

Performing Continuous Measurements

Continuous measurements are performed while the continuous measurement command is input from an external device.

Immediately after a measurement is performed, the next measurement is performed.

This is repeated while a continuous measurement command is input with the IN0 to IN5 signals.

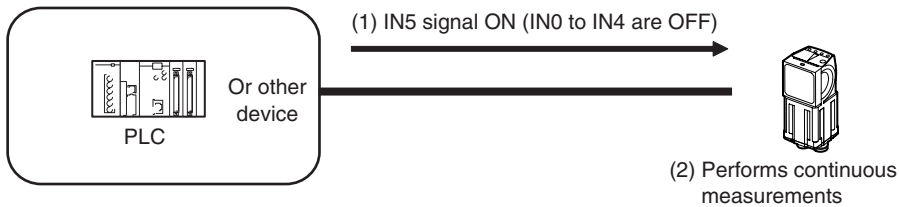

Note

This function can be used only when the input mode is set to Expanded Mode.

Wiring

Color	Signal	State	Description
Gray	IN0	OFF	Command parameters for continuous measurements
Green	IN1	OFF	
Red	IN2	OFF	
White	IN3	OFF	
Purple	IN4	OFF	
Yellow	IN5	ON	Command input for continuous measurements
Black	OUT0 (OR)	--	Overall judgement (default assignment)
Orange	OUT1 (BUSY)	--	Processing in progress (default assignment)

The signals shown at the left are used. Refer to the following information for signal wiring.



Wiring: p. 28

Timing Chart

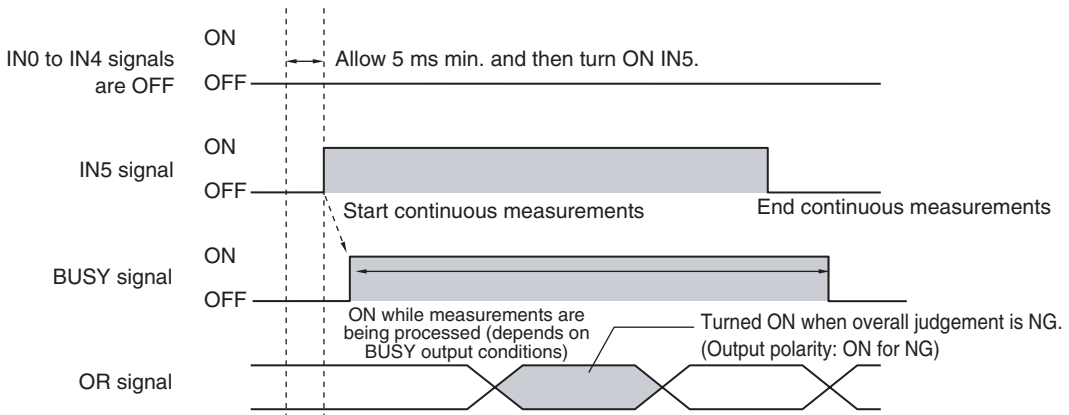

1. Turn ON IN5 while IN0 to IN4 are OFF. If status is held while the BUSY signal is OFF, continuous measurements will begin and the BUSY signal will remain ON while continuous measurements are being performed.
2. Continuous measurements end when IN5 is turned OFF.

Settings

► [In/Out] – [I/O setting] – [I/O terminals] – [Input] – [Input mode]

Press [Expanded mode].

Sample Ladder Program

The following sample program is used to input a IN5 signal to perform continuous measurements. Continuous measurements will be started when W0.00 turns ON and stopped when W0.01 turns ON.

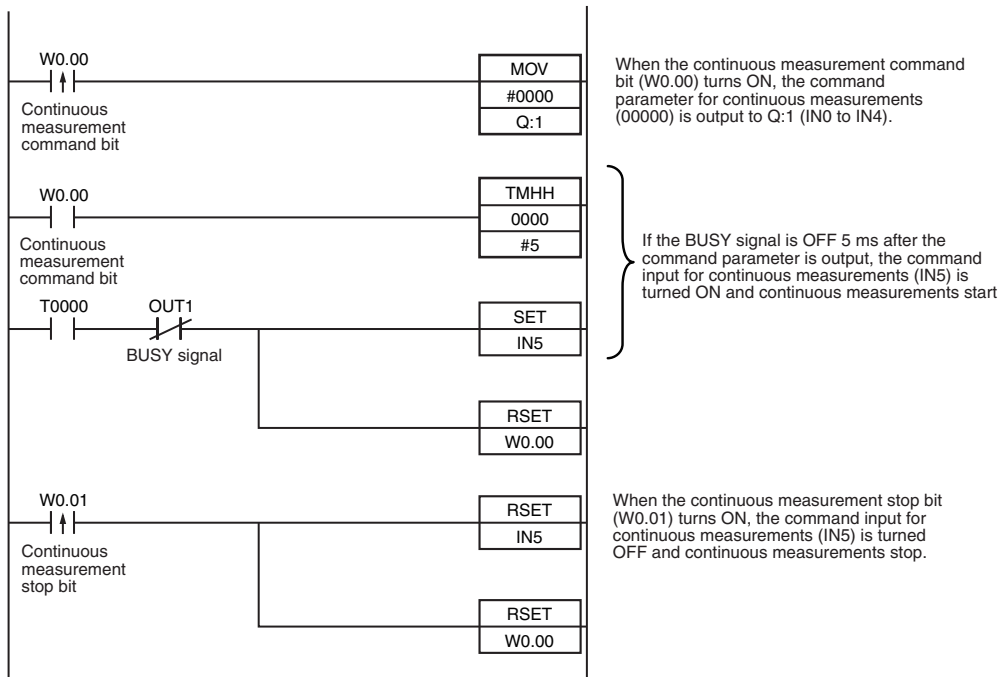

• I/O Signal Allocations

Signal	Address	
Output signals	OUT1 (BUSY signal)	CIO 0.01
Input signals	IN0	CIO 1.08
	IN1	CIO 1.09
	IN2	CIO 1.10
	IN3	CIO 1.11
	IN4	CIO 1.12
	IN5	CIO 1.15

Setting the Outputs

Using the Overall Judgement Result

When the results of the inspection items are judged, if even one individual judgement result is NG, the OR output signal is turned ON.

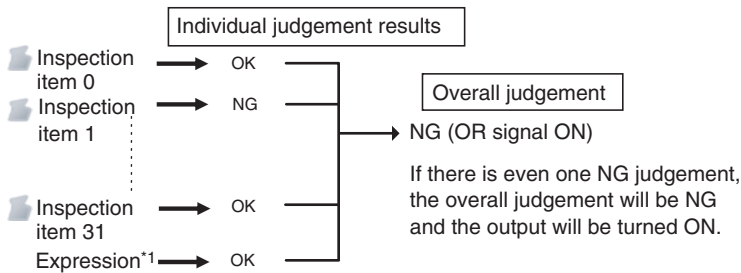

*1: When judgement results from calculations are set to be reflected in overall judgement.

Note

The overall judgement result output signal can also be turned ON when all individual judgement results are OK.

Changing the judgement output ON condition: p. 136

Wiring

Color	Signal	Description
Black	OUT0 (OR)	Overall judgement (default assignment)

The signals shown at the left are used. Refer to the following information for signal wiring.

2-4 Wiring: p. 28

Timing Chart

The OR signal that is output is held until the next overall judgement is output.

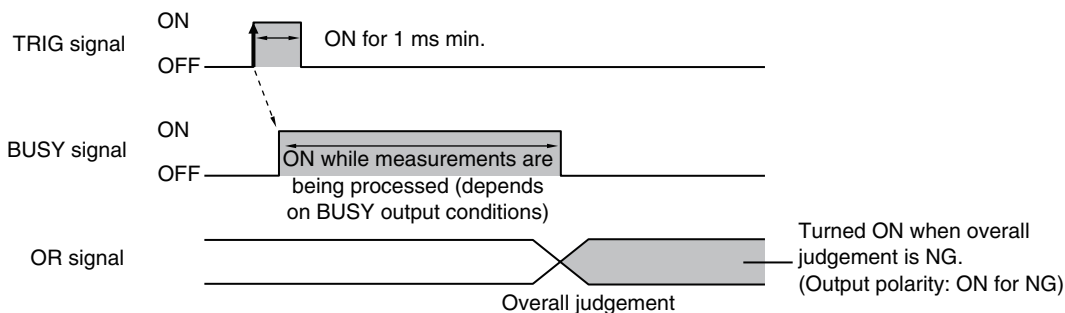

Note

The timing for updating the OR signal and the ON time after judgement processing can be adjusted.

Adjusting the judgement output timing: p. 134

Obtaining Individual Judgement Results

Up to three judgement results of individual inspection items (individual judgement signals OR0 to OR31) can be assigned to terminals OUT0 to OUT2 and output to external devices.

Output terminal	Output signals that can be assigned
OUT0	<ul style="list-style-type: none"> OR (Total judgement)...(default) OR0 (Item 0 judgement) to OR31 (Item 31 judgement)
OUT1	<ul style="list-style-type: none"> BUSY (default) OR0 (Item 0 judgement) to OR31 (Item 31 judgement)
OUT2	<ul style="list-style-type: none"> ERROR (default) OR0 (Item 0 judgement) to OR31 (Item 31 judgement)

Wiring

Example: Signals are assigned to terminals OUT0 to OUT2 as shown below.

- OUT0: Inspection number 2 (OR2)
- OUT1: Inspection number 5 (OR5)
- OUT2: Inspection number 14 (OR14)

Color	Signal	Description
Black	OUT0 (OR2)	Outputs the judgement for OR2.
Orange	OUT1 (OR5)	Outputs the judgement for OR5.
Light blue	OUT2 (OR14)	Outputs the judgement for OR14.

The signals shown at the left are used. Refer to the following information for signal wiring.

2-4 Wiring: p. 28

As described above, if terminals OUT0 to OUT2 are all assigned to individual judgement output signals, the BUSY signal and ERROR signal assigned as the default settings will no longer be output.

Timing Chart

Output OR0 to OR31 signals are held until the next judgement output.

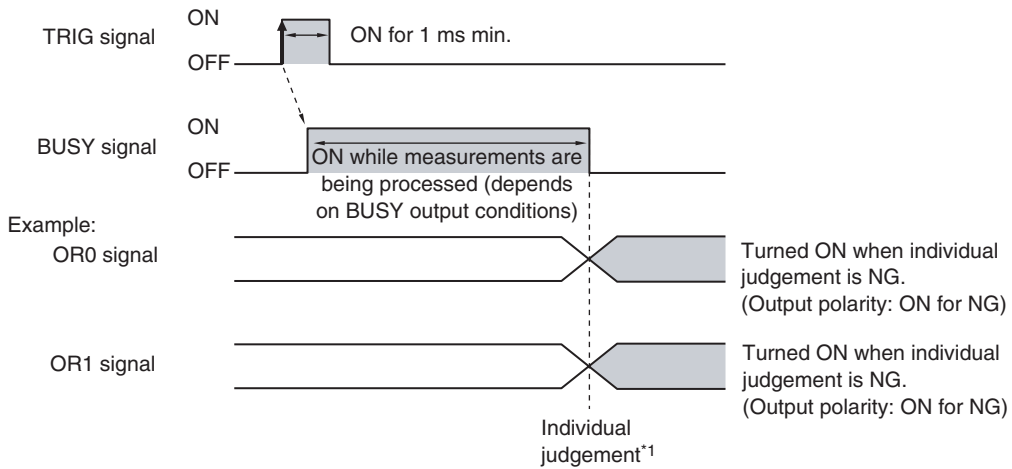

*1: The timing for updating the OR signal is when the measurement results are finalized, regardless of the output settings of the BUSY signal (BUSY output conditions).

Note

The timing for updating the OR0 to OR31 signals and the ON time after judgement processing can be changed.

Adjusting the judgement output timing: p. 134

Settings

► [In/Out] – [I/O setting] – [I/O terminals] – [Output]

- 1** Press [OUT0].
- 2** Press [OR2 (Item 2 judgement)].
OR2 output signal was assigned to OUT0.
- 3** Assign the others in the following manner.
OUT1: OR5
OUT2: OR14

Adjusting the Judgement Output Timing

The output timing of the OR signal or OR0 to OR31 signals can be selected from two modes depending on the external device.

Selecting the OFF Timing

- Level output (default)

The status of the output OR signal is held until the next OR signal is output.

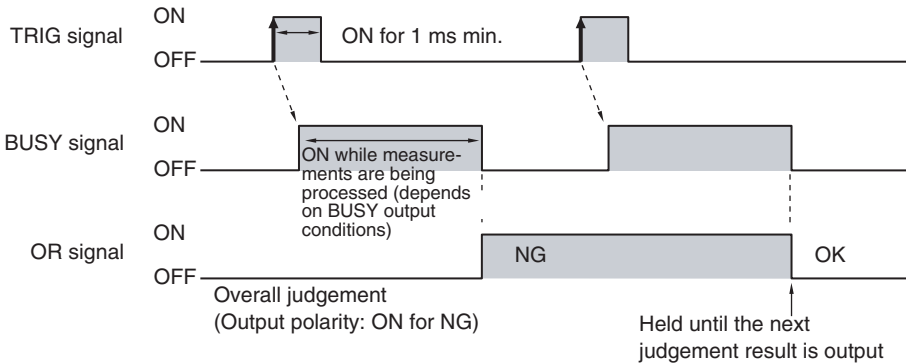

- One-shot output

The status of the output OR signal is turned OFF after a specified time has passed. (Setting range: 0 to 1,000 ms)

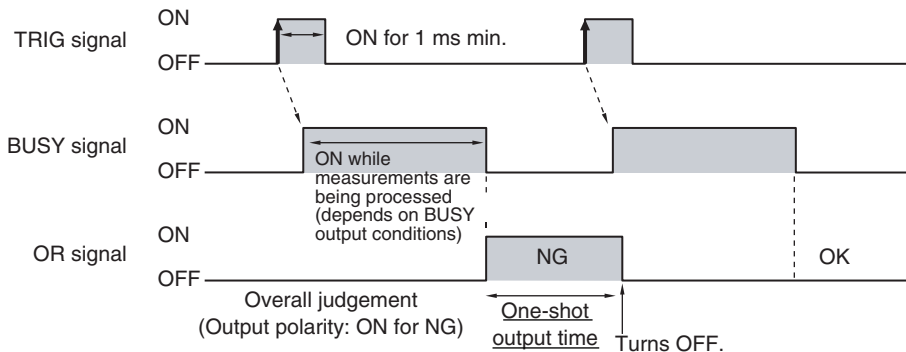

Delaying the Output Timing

When using one-shot output, the output timing of the OR signal can be delayed. (Setting range: 0 to 1,000 ms)

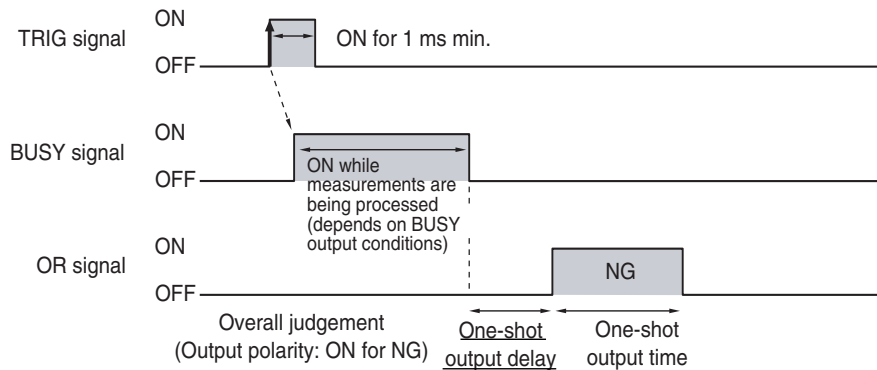

Settings

► [In/Out] – [I/O setting] – [I/O terminals] – [Output]

- 1 Press [Output mode] and press [Level output] or [One-shot output].
- 2 Press [Output delay] and set the one-shot output delay.
- 3 Press [OK].



- 4 Press [Output time] and set the one-shot output time.
- 5 Press [OK].

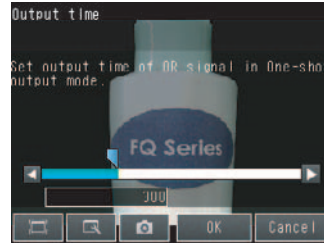

Item		Description
Output mode	One-shot output	After the measurement results are finalized, if the judgement output ON condition is met, the OR signal is turned ON for the one-shot output time. It is then turned OFF once the specified time has expired.
	Level output (default)	The judgement is output after measurement results are finalized and the ON/OFF status of the OR signal is held until it is changed for the next measurement result.
Output delay		When one-shot output mode is selected, this parameter sets the delay from when a measurement is completed until when the OR signal turns ON. (Setting range: 0 to 1,000 ms)
Output time		When one-shot output mode is selected, this parameter sets the time that the OR signal is ON. (Setting range: 1 to 1,000 ms)

Important

When one-shot output is selected as the output mode, make the following value smaller than the trigger input period.

- One-shot delay time + One-shot output time

Changing the Judgement Output ON Conditions

The ON condition for the OR signal or the OR0 to OR31 signals can be set to be output when the judgement results are OK or when they are NG. The default setting is when they are NG.

Settings

► [In/Out] – [I/O setting] – [I/O terminals] – [Output] – [Output polarity]

Item		Description
Output polarity	OK: ON	The output is turned ON if the judgement is OK. For the overall judgement, the output is turned ON if all judgements are OK.
	NG: ON (default)	The output is turned ON if the judgement is NG. For the overall judgement, the output is turned ON if even one judgements is NG.

Changing the Polarity of the BUSY Output

The Sensor turns ON the BUSY output signal during measurements and other processing to indicate that a measurement trigger cannot be received. The polarity of the BUSY signal can be reversed so that it is ON only when a trigger signal can be received.

Settings

► [In/Out] – [I/O setting] – [I/O terminals] – [Output] – [BUSY polarity]

Item		Description
BUSY polarity	BUSY: ON (default)	The BUSY signal is ON while the Sensor is processing data.
	READY: ON	The BUSY signal is ON while the Sensor can receive a trigger signal.

Important

All timing charts in this manual show the operation of the BUSY signal at the default setting. If you change the polarity of the BUSY signal, take this into consideration when reading the timing charts.

Changing the BUSY Output Condition

The end timing of the BUSY signal can be changed.

► [In/Out] – [I/O setting] – [I/O terminals] – [Output] Tab Page – [BUSY output]

Item		Description
BUSY output	Measurement (default)	The BUSY signal turns OFF when the measurement is completed.
	Data logging	The BUSY signal turns OFF when data logging is completed.
	Image logging	The BUSY signal turns OFF when image logging is completed.
	Result display	The BUSY signal turns OFF when the result display is completed.

Controlling the Sensor from an External Device

The following Sensor functions can be controlled with command inputs from an external device without connecting the Touch Finder.

Function	Description	Reference
Switching the scene	This command changes the scene when the line process changes.	p. 137
Re-registering the model or reference color	This command re-registers the judgement references for measurement when levels are changed.	p. 139
Clearing an error	This command turns the ERROR signal OFF.	p. 141
Continuous measurement	Continuous measurement is performed while this command is input.	p. 129

Changing the Scene

This section describes how to change the line process by changing the scene.

Wiring

Color	Signal	State		Description
		Input Mode		
		Standard Mode	Expanded Mode	
Gray	IN0	Scene number (0 to 31)	Scene number (0 to 15)	Specifies the scene number.
Green	IN1			
Red	IN2			
White	IN3			
Purple	IN4			
Yellow	IN5	ON		Trigger to change the scene
Orange	OUT1 (BUSY)	--		Processing in progress (default)

The signals shown at the left are used. Refer to the following information for signal wiring.



2-4 Wiring: p. 28

Timing Chart

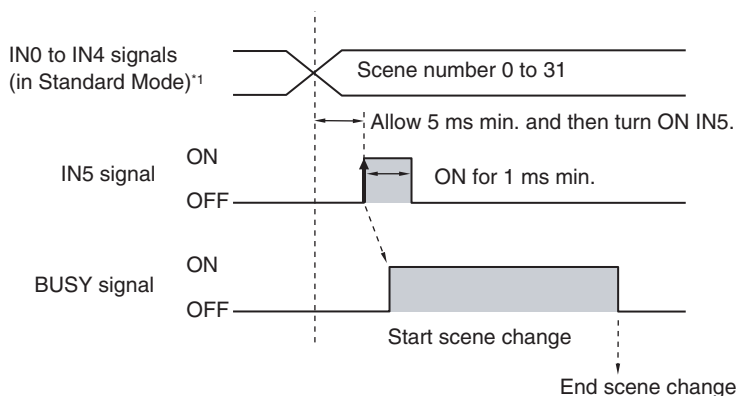

*1: In Expanded Mode, specify scene numbers 0 to 15 using the IN0 to IN3 signals.

- 1 Specify the scene number with the IN0 to IN4 signals. (Standard Mode)
- 2 Turn ON the IN5 signal while the BUSY signal is ON to change the scene to the specified scene.
- 3 The BUSY signal turns ON while the scene is being switched.

Settings

► [In/Out] – [I/O setting] – [I/O terminals] – [Input] – [Input mode]

The scene numbers that can be used depend on the input mode.

[Standard mode] (default): Scene 0 to 31

[Expanded mode]: Scene 0 to 15

Sample Ladder Program

This sample program is used to change the scene when the input mode is set to Expanded Mode. The scene changes to scene 1 when W0.00 turns ON.

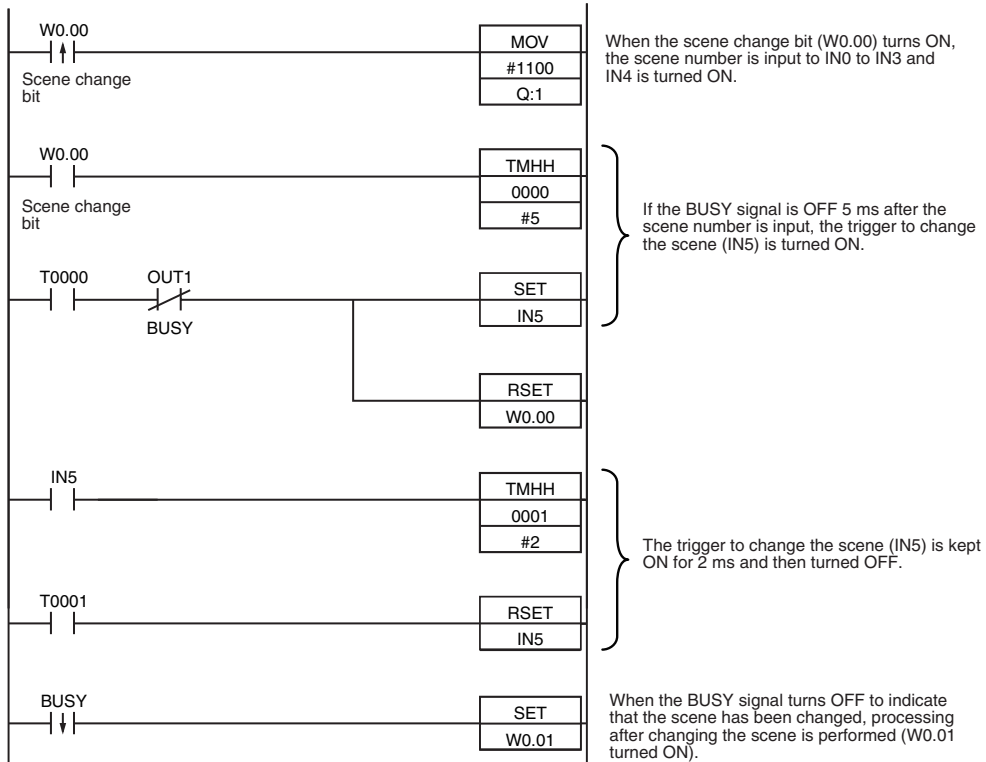

• I/O Signal Allocations

Signal		Address
Output signals	OUT1 (BUSY signal)	CIO 0.01
Input signals	IN0	CIO 1.08
	IN1	CIO 1.09
	IN2	CIO 1.10
	IN3	CIO 1.11
	IN4	CIO 1.12
	IN5	CIO 1.15

Note

The BUSY signal will be ON while the scene it being changed.

Important

If the cycle time is too long, the PLC may not be able to detect when the BUSY signal is ON. If necessary, turn OFF W0.00 after a suitable time elapses.

Registering the Measurement Reference Again

The model and reference color can be re-registered with commands from an external device, such as a PLC, based on the image that was just input when the line process was changed.

Inspection item	Re-registered data
Search	Model data
Color data	Reference color (hue, saturation, and brightness)
Edge Position, Edge Width, Area	None

Note

- Application is possibly only from the Run Mode
- If the parameter is applicable to more than one inspection item, it will be re-registered for all inspection items.

Settings

► [In/Out] – [I/O setting] – [I/O terminals] – [Input] – [Input mode]

Press [Expand mode].

Wiring

Color	Signal	State	Description
Gray	IN0	OFF	Command parameter for registering the model again
Green	IN1	OFF	
Red	IN2	OFF	
White	IN3	ON	
Purple	IN4	OFF	
Yellow	IN5	ON	Command input for registering the model again
Orange	OUT1 (BUSY)	--	Processing in progress (default)

The signals shown at the left are used.
Refer to the following information for signal wiring.



2-4 Wiring: p. 28

Timing Chart

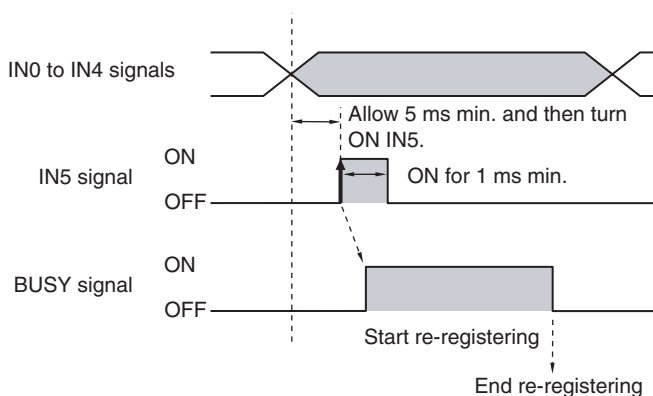

- 1 Turn OFF IN 0 to IN4 and turn ON IN3.
- 2 Turn ON the IN5 signal while the BUSY signal is OFF to register the model data and reference color again from the image that was just input.
- 3 The BUSY signal turns ON while the parameters are being re-registered.

Sample Ladder Program

This sample program is used to input IN5 to re-register a model.

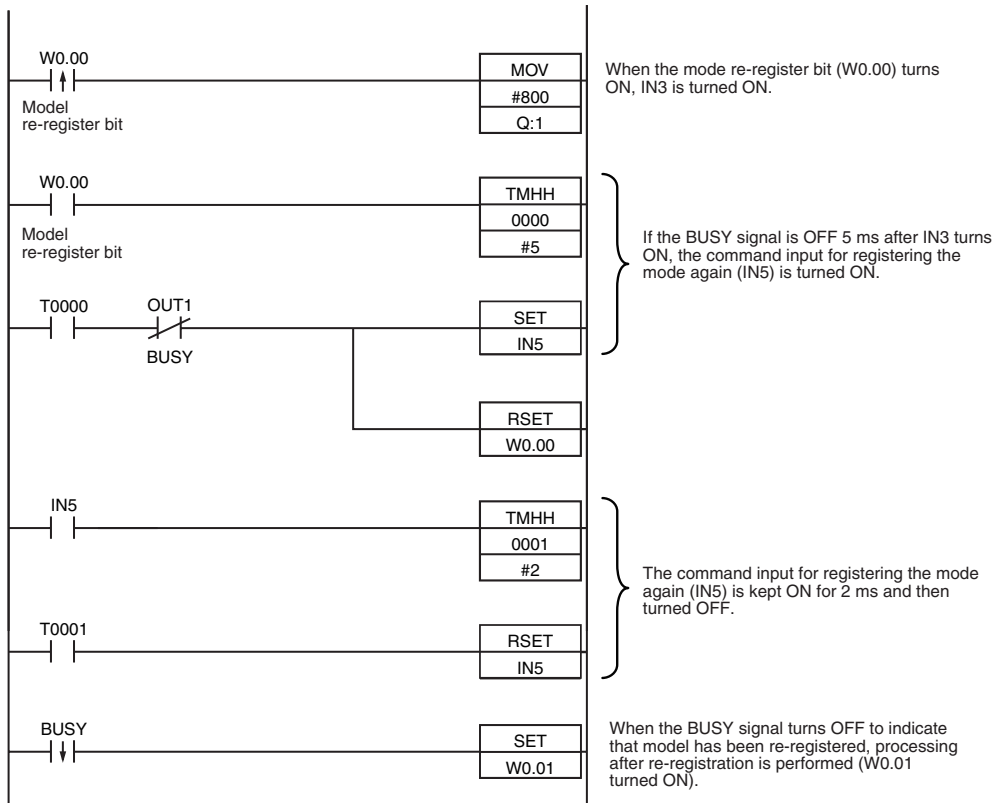

• I/O Signal Allocations

Signal		Address
Output signals	OUT1 (BUSY signal)	CIO 0.01
Input signals	IN0	CIO 1.08
	IN1	CIO 1.09
	IN2	CIO 1.10
	IN3	CIO 1.11
	IN4	CIO 1.12
	IN5	CIO 1.15

Note

The BUSY signal will be ON while the model is being re-registered.

Important

If the cycle time is too long, the PLC may not be able to detect when the BUSY signal is ON. If necessary, turn OFF W0.00 after a suitable time elapses.

Turning the ERROR Signal OFF

The ERROR signal turns ON when an error occurs.

After removing the cause of the error, turn the ERROR signal OFF using one of the following methods.

Method 1: Input an error clear command from an external device such as a PLC.

Method 2: Input a measurement trigger again.

(For example, turn the TRIG signal ON during a one-shot measurement.)

The ERROR signal will turn OFF when measurement is executed correctly.

Note

This function can be used in Run Mode only.

Settings

► **[In/Out] – [I/O setting] – [I/O terminals] – [Input] – [Input mode]**

Press [Expand mode].

Wiring

Color	Signal	State	Description
Gray	IN0	OFF	Command parameter for clearing errors
Green	IN1	OFF	
Red	IN2	ON	
White	IN3	OFF	
Purple	IN4	OFF	
Yellow	IN5	ON	Command input for clearing errors
Orange	OUT1 (BUSY)	--	Processing in progress (default)
Light blue	OUT2 (ERROR)	--	ERROR signal (default)

The signals shown at the left are used.

Refer to the following information for signal wiring.



2-4 Wiring: p. 28

Timing Chart

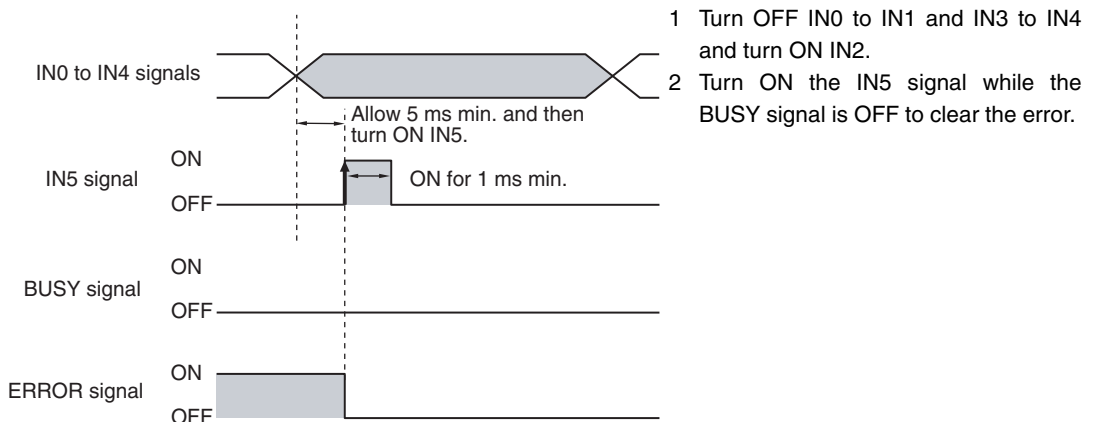

8-2 Outputting/Controlling with Ethernet

Data can be input and output to external devices via Ethernet. The two methods are described below.

- No-protocol Data Output

Data that is already specified for output is automatically output from the Sensor to Ethernet when an overall judgement result is output. Up to 32 data can be output in the specified format (ASCII format or binary format).



- No-protocol Command/Response Method

The external device sends a command to the Sensor and receives a response from the Sensor.

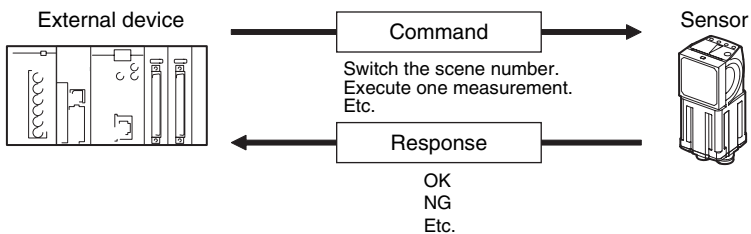

Connections

Connect the Switching Hub and PLC using an FQ-WN□□ Special Ethernet Cable.

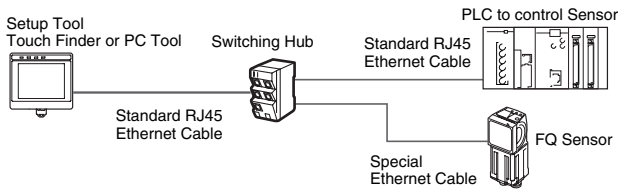

Important

When connecting more than one Sensor, set the IP addresses so that the same IP address is not used for more than one Sensor.

Set the Basic Settings of the Ethernet

Use the following procedure to turn OFF automatic settings for Ethernet, and enter the IP address and subnet mask.

► [Sensor settings] – [Network] – [Ethernet]

- 1** Press [Auto connection].
- 2** Press [OFF] to select it.
You can now set the IP address manually.
- 3** Enter the IP address and subnet mask.

Item	Purpose	Setting range
IP address	Enter the IP address of the Sensor.	a.b.c.d a: 1 to 223 b: 0 to 255 c: 0 to 255 d: 2 to 254 (Default: 10.5.5.100)
Subnet mask	Enter the subnet mask.	0.0.0.0 to 255.255.255.255 (Default: 255.255.255.0)

Note

The port number is always 9876.

Setting the Data to Output via Ethernet

Allocate the data to output via Ethernet according to the output method for the Ethernet as shown below.

- No-protocol Command/Response Method

When executing one-shot measurements and continuous measurements with commands (MEASURE or M, MESAURE/C or M/C), set the data to output via Ethernet as a response.

- No-protocol Data Output

Set in advance the data to output via Ethernet after the measurements (32 max.).

Data That Can Be Output

Up to 32 data can be output (data 0 to data 31). The measurement data from position compensation and inspection items that can be output and the results from the expression settings can be output. For data that can be output, refer to the *Measurement Data That Can Be Used for External Outputs and Calculations* for each inspection item.

Allocating Output Data

Allocate Ethernet output data to data 0 to 31. This section describes the setting procedure when the X coordinate (Position X) of measurement 0.search is output as binary data to data 0.

► [In/Out] – [I/O setting] – [Ethernet] – [Output data set]

1 Press [0. Data 0].

2 Press [Settings].



3 Press [0. Search].

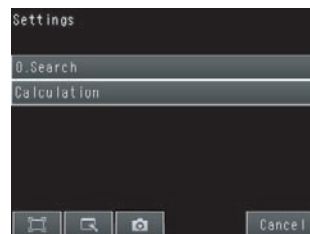

4 Press [Position X].



This process is repeated to register data 1 or higher. The settings are enabled after restarting the Sensor.

Note

Measurement data of inspection items for which logging is not supported can be logged by using the Ethernet output settings. Set the measurement data of inspection items for which logging is not supported as calculation parameters using the Calculation menu command, and use them as the calculation results. Allocate the results to Ethernet outputs. In this way, measurement data can be logged as calculation results.

Outputting Data to an External Device Using No-protocol Communications

Setting the Data To Output Automatically

Refer to *Setting the Data to Output via Ethernet*.

Setting the Data Format

▶ **[In/Out] – [I/O setting] – [Ethernet]**

- 1 Press [Output form].
- 2 Set the output format to ASCII or binary.
- 3 Set the data format.

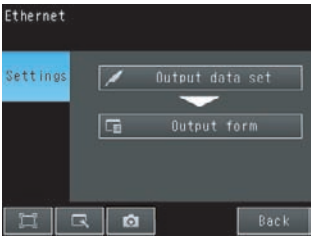

• **When Output Format Is ASCII**

Set the parameters for integer digits, decimal digits, negative numbers, 0 suppression, the field separator, and the record separator.

• **Output Format**

Measured value of data 0	,	Measured value of data 1	,	...	Measured value of data 7	CR
--------------------------	---	--------------------------	---	-----	--------------------------	----

Note

The data output method, digits, and data separators can be changed as needed.

Example: Integer digits: 5, decimal digits: 3, negative number expression: -, field separator: comma, record separator: CR

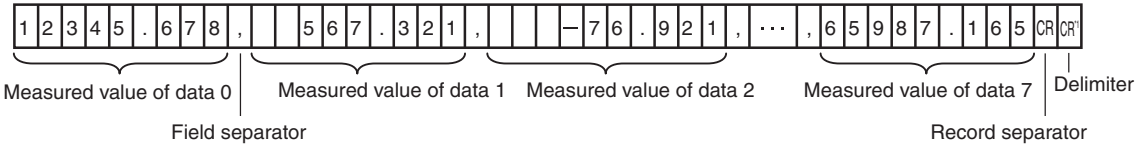

*1 Because the record separator is set to CR, only one record is output for each measurement. A blank line (CR: delimiter) will therefore be entered after the record separator. If you do not want a blank line, set the record separator to None.

Note

The field separator is not output unless the data continues.

The following range of values can be output.

$-999,999,999.9999 \leq \text{Measured value} \leq 999,999,999.9999$

If the measured value is lower than $-999,999,999.9999$, then $-999,999,999.9999$ is output.

If the measured value is higher than $999,999,999.9999$, then $999,999,999.9999$ is output.

The following values are output if JG (Judge) is set.

OK: 1

NG: -1

Note

Data that is output after measurement is output until the last data even after the measurement is finished. Data output is not interrupted midway.

• When Output Format Is Binary

Set the numerical expression.

Select either fixed decimal or floating-point decimal.

• Output Format

$\underbrace{\langle \text{Measured value of data } 0 \times 1,000 \rangle}_{4 \text{ bytes}}$
 $\underbrace{\langle \text{Measured value of data } 1 \times 1,000 \rangle}_{4 \text{ bytes}}$
 \dots
 $\underbrace{\langle \text{Measured value of data } 7 \times 1,000 \rangle}_{4 \text{ bytes}}$
CR
|
Delimiter

The measurement data multiplied by 1,000 is output continuously at 4 bytes per data. Negative numbers are output as two's complements.

Example: When Data 0 is 256.324 and Data 1 is -1.000 .

\$00	\$03	\$E9	\$44	\$FF	\$FF	\$FC	\$18	\$0D
$\underbrace{\hspace{10em}}$ Data 0: 256324 (256.324 × 1000)				$\underbrace{\hspace{10em}}$ Data 1: -1000 (-1.000 × 1000)			$\underbrace{\hspace{10em}}$ A delimiter will be attached to the end.	

Note

Binary output does not use data separators, i.e., field separators or record separators. These separators are used only for ASCII output.

The following range of values can be output.

$-2,147,483.648 \leq \text{Measured value} \leq 2,147,483.647$

If the measured value is lower than $-2,147,483.648$, then $-2,147,483.648$ is output.

If the measured value is higher than $2,147,483.648$, then $2,147,483.648$ is output.

The following values are output if JG (Judge) is set.

OK: 1000 (1×1000)

NG: -1000 (-1×1000)

Note

Data that is output after measurement is output until the last data even after the measurement is finished. Data output is not interrupted midway.

Command Format

This section describes the command format for no-protocol communications.

Commands defined in the command list can be used.

Set commands and parameters in ASCII.

If the command has an argument parameter, set the parameter after inserting a space (0x20).

If it has multiple parameters, insert a space before each parameter.

Place a delimiter at the end of the command. No space is required before the delimiter.

The delimiter is always CR.

<Command Format>

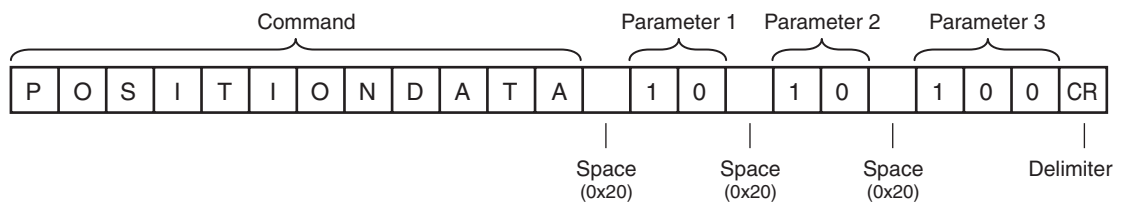

<Response Format>

If a parameter is attached, the parameter and delimiter are output when the command is processed normally, and the command execution result is OK. A delimiter is inserted at the end of the response.

The delimiter is always CR.

Command Execution Result

Parameter

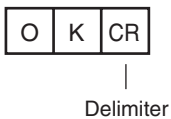
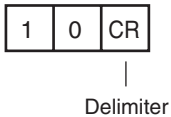

If the command is not processed normally, the command execution result is NG.

Command Execution Result

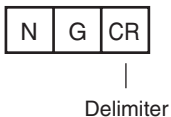

An error occurs in the following cases.

- A non-existent command was specified.
- The number of parameters is incorrect.
- The parameter range is incorrect.
- The parameter content is incorrect.
- Operation could not be performed normally for the operation command.

Command List

The following table lists the no-protocol commands.

Commands that can be used in no-protocol Ethernet communications are listed below.

Type of command	Command	Abbreviation	Function	Reference
Scene control commands	SCENE	S	Acquires the current scene number.	p. 149
	SCENE <i>Scene_number</i>	S <i>Scene_number</i>	Changes the scene number being used.	p. 150
Measurement control commands	MEASURE	M	Executes one measurement.	p. 151
	MEASURE/C	M/C	Starts continuous measurements.	p. 152
	MEASURE/E	M/E	Ends continuous measurements.	p. 153
Data acquisition/setting commands	POSITIONDATA <i>External_reference_data_number</i>	PD <i>External_reference_data_number</i>	Acquires the position compensation data.	p. 154
	POSITIONDATA <i>External_reference_data_number</i> <i>Set_value</i>	PD <i>External_reference_data_number</i> <i>Set_value</i>	Sets the position compensation data.	p. 155
	ITEMDATA <i>Inspection_item_number</i> <i>External_reference_data_number</i>	ID <i>Inspection_item_number</i> <i>External_reference_data_number</i>	Acquires the inspection item data.	p. 156
	ITEMDATA <i>Inspection_item_number</i> <i>External_reference_data_number</i> <i>Set_value</i>	ID <i>Inspection_item_number</i> <i>External_reference_data_number</i> <i>Set_value</i>	Sets the inspection item data.	p. 157
Model re-registration command	MODEL	None	Re-registers the models for registered Search and Color Data inspection items.	p. 158
Setting acquisition command	VERGET/S	None	Acquires the version information of the Sensor software.	p. 159
	VERGET/H	None	Acquires the Sensor model information.	p. 160
	ERRGET	None	Acquires the latest error code of the Sensor.	p. 161
Utility commands	CLRMEAS	None	Clears the measurement values.	p. 162
	CLRERR	None	Clears the error output status (error signal and error indicator).	p. 163
	RESET	None	Restarts the Sensor.	p. 164

Command Details

Scene Control Commands

● SCENE or S

Acquire Scene Number

This command acquires the scene number currently being used.

<Command Format>

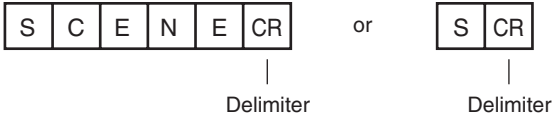

<Response Format>

When the Command Is Processed Normally

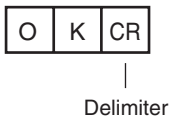
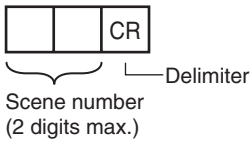

When the Command Is Not Processed Normally

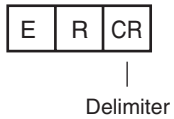

<Parameter Descriptions>

Scene number	The acquired scene number (currently used scene number) is returned.
--------------	--

Example:

When Scene 0 Is Being Used

<Command>



<Response>

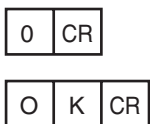

Change Scene Number

This command changes the scene number to use.

<Command Format>

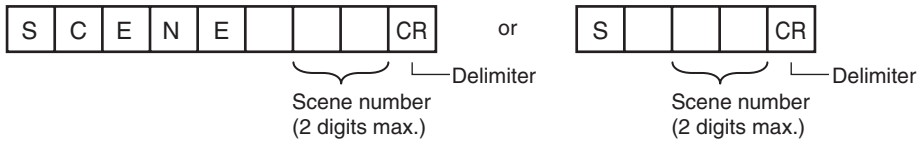

<Response Format>

When the Command Is Processed Normally

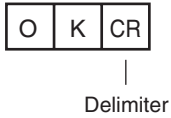

When the Command Is Not Processed Normally

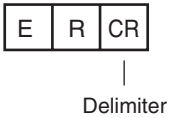

<Parameter Descriptions>

Scene number	Specifies the scene number (0 to 31) to change to.
--------------	--

Measurement Control and Measurement Acquisition Commands

● MEASURE or M

Execute Measurement

This command executes one measurement.

If Ethernet output is not set, only the measurement is performed.

If Ethernet output is set, the measurement is performed and the result is returned as response data.

<Command Format>



<Response Format>

When the Command Is Processed Normally



Delimitter

When the Command Is Not Processed Normally



Delimitter

<Parameter Descriptions>

Measurement result	<p>The measurement result is output as the response when Ethernet output is set. The measurement result is not output when Ethernet output is not set.</p> <p> Reference: <i>Setting the Data to Output via Ethernet</i> (p. 144)</p>
--------------------	---

Start Continuous Measurements

This command starts continuous measurements.

If Ethernet output is not set, only continuous measurement is performed.

If Ethernet output is set, continuous measurement is performed and the results corresponding to the number of measurements made are returned as response data.

<Command Format>

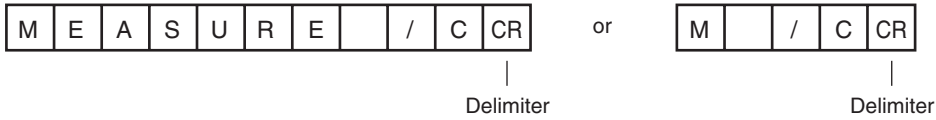

<Response Format>

When the Command Is Processed Normally

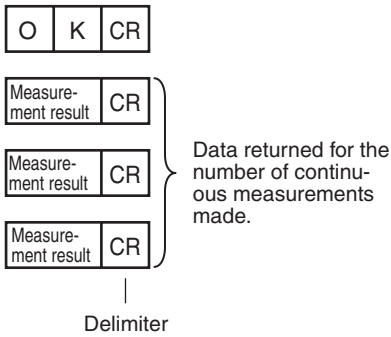

When the Command Is Not Processed Normally

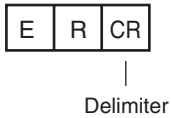

<Parameter Descriptions>

Measurement result	<p>The measurement results corresponding to the number of measurements made are output when Ethernet output is set.</p> <p>The measurement result is not output when Ethernet output is not set.</p> <p> Reference: <i>Setting the Data to Output via Ethernet</i> (p. 144)</p>
--------------------	--

End Continuous Measurements

The command ends continuous measurements.

<Command Format>

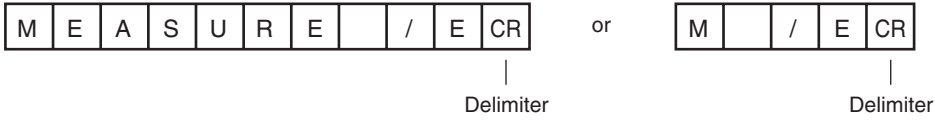

<Response Format>

When the Command Is Processed Normally

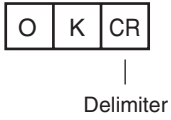

When the Command Is Not Processed Normally

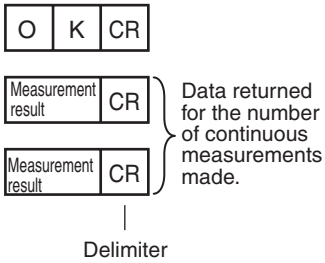

Note

Set the Ethernet output to output measurement results.
If Ethernet output is not set, only the command response is output.

 Reference: *Setting the Data to Output via Ethernet* (p. 144)

Data Acquisition/Setting Commands

● POSITIONDATA or PD

Acquire Position Compensation Data

The command acquires position compensation parameters and measurement values.

<Command Format>

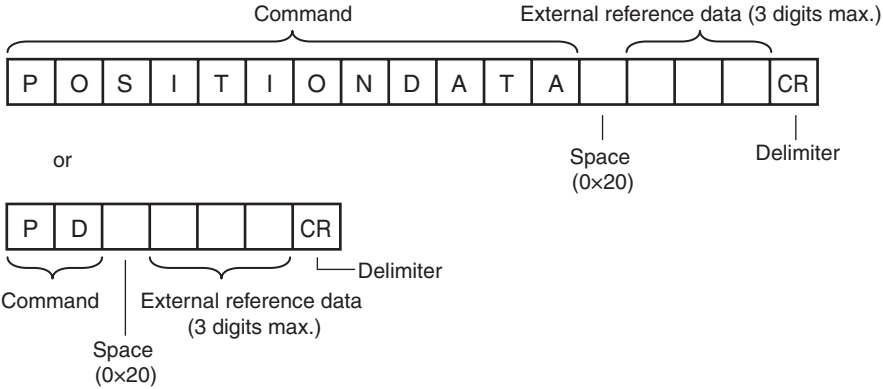

<Response Format>

When the Command Is Processed Normally

Acquired value	CR
----------------	----

O	K	CR
---	---	----

Delimiter

When the Command Is Not Processed Normally

E	R	CR
---	---	----

Delimiter

<Parameter Descriptions>

Data number	Specifies the data number. Refer to 10-2 External Reference Parameters (p. 183) for details.
Acquired value	The position compensation data and threshold value are returned. Refer to 10-2 External Reference Parameters (p. 183) for details.

Sets the Position Compensation Data.

The command sets position compensation parameters and measurement values.

<Command Format>

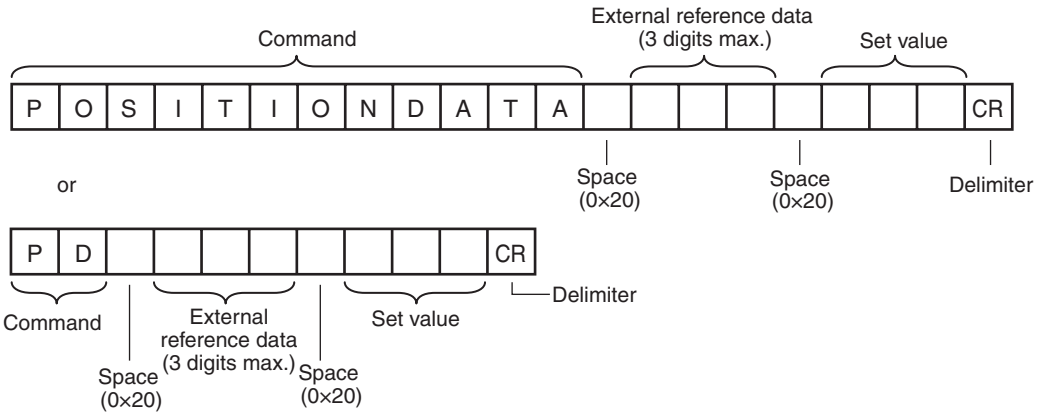

<Response Format>

When the Command Is Processed Normally

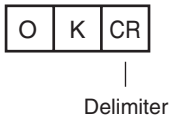

When the Command Is Not Processed Normally

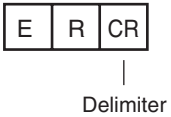

<Parameter Descriptions>

External reference data number	Specifies the external reference data number. Refer to 10-2 External Reference Parameters (p. 183) for details.
Setting	Specifies the set value. Refer to 10-2 External Reference Parameters (p. 183) for details.

● ITEM DATA or ID

Acquire Inspection Item Data

This command acquires the parameters and measurement values of the specified inspection item.

<Command Format>

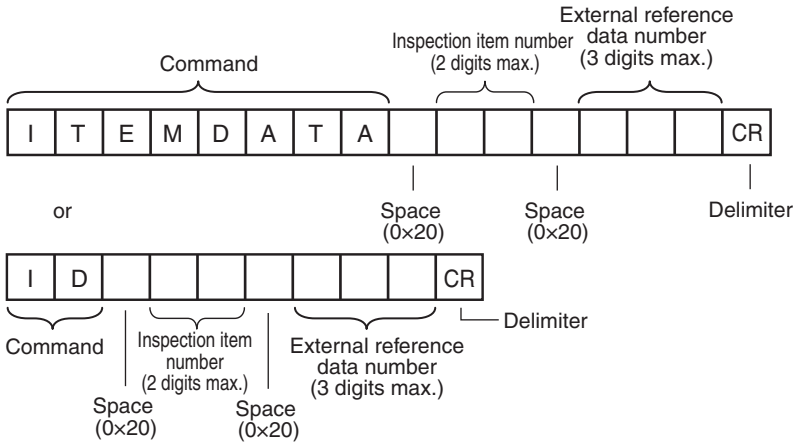

<Response Format>

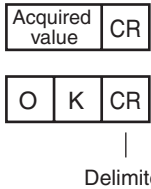

When the Command Is Processed Normally

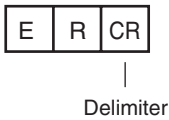

When the Command Is Not Processed Normally



<Parameter Descriptions>

Inspection item number	Specifies the inspection item number. (0 to 31)
External reference data number	Specifies the external reference data number. (0 to 999)  Refer to <i>10-2 External Reference Parameters</i> (p. 183) for details.
Acquired value	Returns the data for the specified inspection item.  Refer to <i>10-2 External Reference Parameters</i> (p. 183) for details.

Set Inspection Item Data

This command sets the parameters and measurement values of the specified inspection item.

<Command Format>

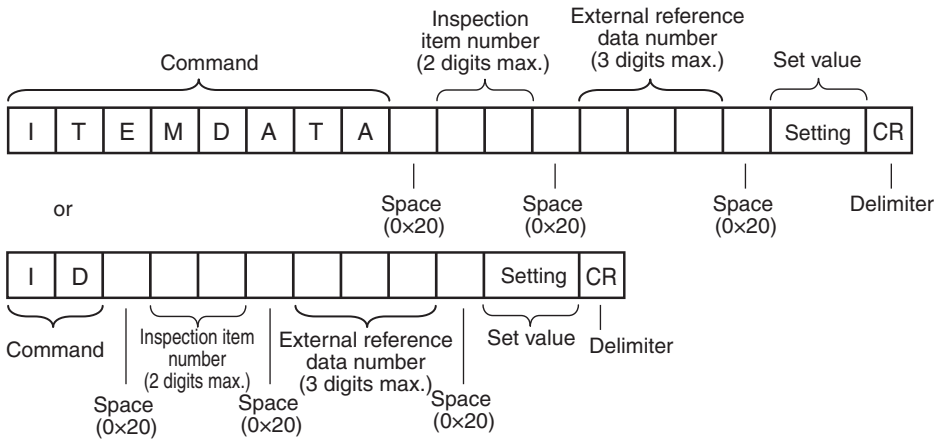

<Response Format>

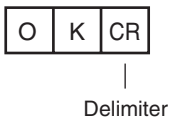

When the Command Is Processed Normally

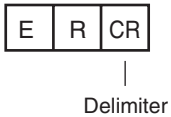

When the Command Is Not Processed Normally



<Parameter Descriptions>

Inspection item number	Specifies the inspection item number. (0 to 31)
External reference data number	Specifies the external reference data number. (0 to 999)  Refer to <i>10-2 External Reference Parameters</i> (p. 183) for details.
Acquired value	Returns the data for the specified inspection item.  Refer to <i>10-2 External Reference Parameters</i> (p. 183) for details.

● MODEL

Re-register Models

This command re-registers the models for registered Search and Color Data inspection items.

<Command Format>

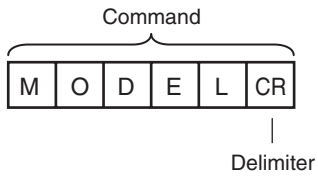

<Response Format>

When the Command Is Processed Normally

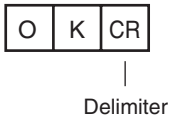

When the Command Is Not Processed Normally

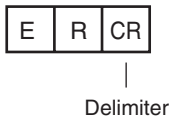

● VERGET

Acquire Software Version

This command acquires the version information of the Sensor software.

<Command Format>

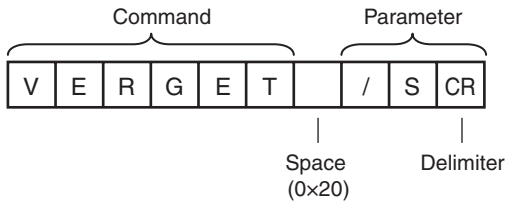

<Response Format>

When the Command Is Processed Normally

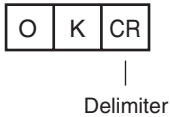
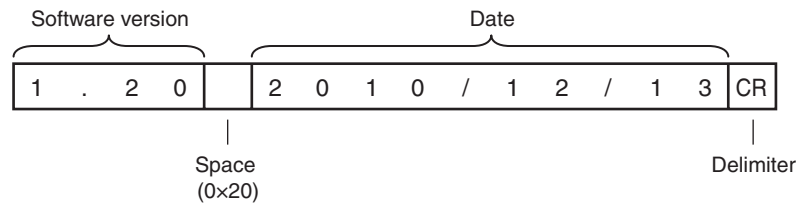

When the Command Is Not Processed Normally

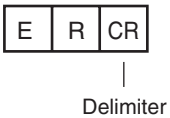

<Parameter Descriptions>

Software version	Returns the software version. Example: When the software version is 1.20, the response is 1.20.
Date	Returns the date. Example: When the date is 13 December 2010, the response is 2010/12/13.

Acquire Sensor Model

This command acquires the Sensor model.

<Command Format>

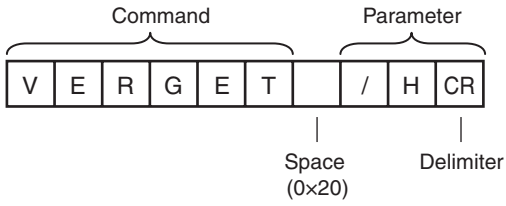

<Response Format>

When the Command Is Processed Normally

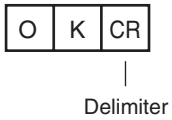
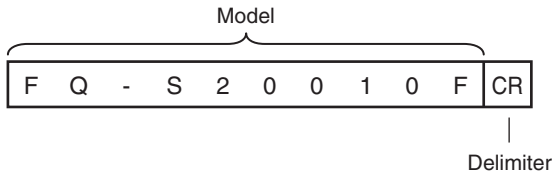

When the Command Is Not Processed Normally

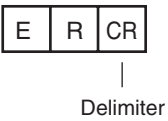

<Parameter Descriptions>

Model	Returns the model. Example: When the model is FQ-S20010F, the response is FQ-S20010F.
-------	--

● ERRGET

Acquire Error Information

This command acquires the latest error code from the Sensor.

<Command Format>

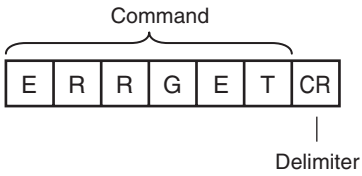

<Response Format>

When the Command Is Processed Normally

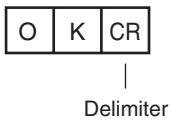
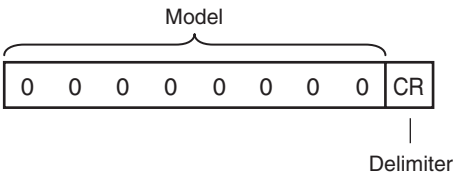

When the Command Is Not Processed Normally

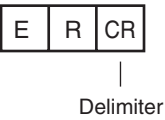

<Parameter Descriptions>

Error code	Returns the latest error code. If there is no error history, the response is 00000000.  Refer to <i>9-1 Error Table</i> (p. 168) for details.
------------	---

● CLRMEAS

Clear Measurement Values

This command clears the measurement values.

<Command Format>

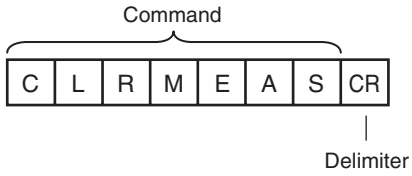

<Response Format>

When the Command Is Processed Normally

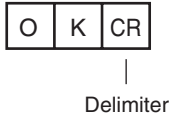

When the Command Is Not Processed Normally

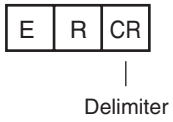

● CLRERR

Clear Errors

This command clears the error output status (error output and error indicator).

<Command Format>

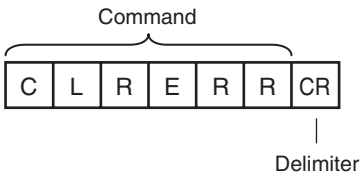

<Response Format>

When the Command Is Processed Normally

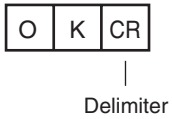

When the Command Is Not Processed Normally

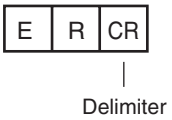

● RESET

Restarts the Sensor.

This command restarts the Sensor.

<Command Format>

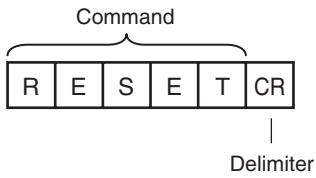

<Response Format>

When the Command Is Processed Normally

If process is completed normally, the Sensor is restarted. There is therefore no response.

When the Command Is Not Processed Normally

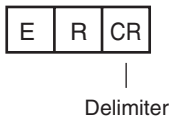

Communications Example

An example of the communications log when a computer is connected and communications is performed with a no-protocol command from a terminal application is shown below.

Example 1: Changing Scenes (Scene number 1 is specified.)

```
S_1
  |
  |-----Space
OK
```

Example 2: Acquiring inspection item data (Acquires the judgement result for a search registered to inspection item 10.)

```
ITEMDATA_100
  |
  |-----Space
0
OK
```

Example 3: Measurement when Ethernet Output Is Not Set

```
M
OK
```

Example 4: Measurement when Ethernet Output Is Set

```
M
OK
    1.0000    0.0000    0.0000    306.0000
M
OK
    2.0000    0.0000    0.0000    0.0000
```

Troubleshooting

9-1 Error Table	168
9-2 Basic Troubleshooting	170





9-1 Error Table

Error History

Up to 10 errors will be stored in the error history in the Sensor or Touch Finder.

This section describes the causes of and measures for errors that are stored in the error history.

Errors Stored in the Error History

Error in error history	Cause	Points to check	Measures to perform
TRIG input error  ERR (Error code: 01040302)	The TRIG signal was input while the BUSY signal was ON.	<ul style="list-style-type: none"> • Check the program in the PLC or other host to see if an interlock or similar measure has been implemented. • If a relay or other device with contacts is being used as the input device, see if chattering has occurred. 	<ul style="list-style-type: none"> • Program interlocks to control the TRIG and IN5 input signals so that they do not turn ON while the BUSY signal is ON. • Switch from a device with contacts (e.g., relay) to a device without contacts (e.g., SSR or PLC transistor output).
IN input error  ERR (Error code: 11020900)			
Scene data error  ERR (Error code: 01030800)	The scene could not be switched for an input signal from an external device.	---	The scene data to be switched to is corrupted. Reset the scene data from the beginning.
Model error  ERR (Error code: 01050405, 01050500)	The model could not be registered for a command from an external device.	Check the image to see if the contrast is too low to register the model.	Increase the image contrast and try again to register the model.
Logging error (Error code: 02160702, 02160703)	All of the data was not saved when logging data to a file.	Check to see if the BUSY output parameter is set to <i>Measurement</i> .	Set the BUSY output parameter to <i>Data logging</i> or <i>Image logging</i> .
SD card output error (Error code: None)	A write to the SD card failed.	Check to see if the SD card is locked. Check to see if there is sufficient space available on the SD card.	Unlock the SD card. Delete unnecessary files from the SD card.

 ERR If an error that is indicated by this icon occurs, the ERROR operation indicator will light and the ERROR signal will turn ON.

Checking the Error Histories

• Checking the History of Errors That Have Occurred in the Sensor

- ▶  (Setup Mode) – [Sensor settings] – [Error history] – [View history]

Errors will be displayed in order with the most recent ones on top.

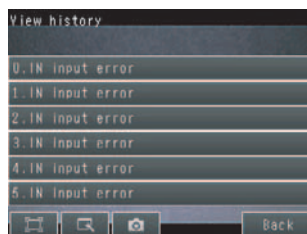

• Checking the Log of Errors That Have Occurred in the Touch Finder

- ▶  (Setup Mode or Run Mode) – [TF settings] – [Error history] – [View history]

Clearing the Error Histories

• Deleting the History of Errors That Were Detected in the Sensor

- ▶  (Setup Mode) – [Sensor settings] – [Error history] – [Delete history]

• Deleting the History of Errors That Were Detected in the Touch Finder

- ▶  (Setup Mode or Run Mode) – [TF settings] – [Error history] – [Delete history]

Note

Refer to the following information for the measures to take when errors occur.

 Errors Stored in the Error History: p. 168

Checking the Latest Error Information (for No-protocol Connection to Ethernet)

The error code of the latest error can be acquired as a response using the error information acquisition command (ERRGET).

- Error Codes: p. 168
- Error Information Acquisition Command (ERRGET): p. 161

Error Messages

If an error occurs while making settings on the Touch Finder, an error message will appear on the display. For these errors, the ERR indicator on the Sensor will not light, the ERROR signal will not be output, and the error will not be recorded in the error history.

Follow the instructions that are given in the error message.

If the following messages appear, the hardware may be faulty. Contact your OMRON representative.

- System error.
- Application system error. Please reboot.
- Failed to startup.

9-2 Basic Troubleshooting

Problem	Measures to perform	Reference
The Sensor or Touch Finder will not start.	Check the power supply capacity to see if it is sufficient.	---
The Sensor cannot be detected.	Check the Ethernet cable to see if it is connected correctly.	---
	Check the Ethernet settings to see if they are correct between the devices.	p. 33
	Check if there are any Sensors that were not detected by the Sensor connection check.	p. 180
	Check the communications cable to see if it is disconnected.	---
	Check the switching hubs to see if any of them are faulty. (If switching hubs are used.)	---
The results display is not updated.	Check to see if the TRIG signal is being correctly input to the Sensor.	p. 109
	Check to see if the most recent NG result is being displayed.	p. 16
Updating the results display is slow.	If other devices are connected to the same network as the Sensor, disconnect the other devices from the network and check the update speed. If the update speed returns to normal, check the specifications of the disconnected devices and take suitable measures.	---
	If there are power lines running in parallel with the Ethernet cable or if there are inverters or other sources of noise near the communications cable, separate the communications cable from them and check the update speed. Noise may be adversely affecting the communications response.	---
Data is not logged properly.	Check to see if the logging setting in the Sensor are correct.	p. 110
	If logging to an SD card is not possible, check the available space on the SD card and check to see if the SD card is write-protected.	p. 118
The ERROR indicator lights.	Check the error history to see what error has occurred and take suitable measures.	p. 168
The image brightness does not stabilize.	Turn ON the brightness correction mode. When the Brightness Correction Mode is ON, the timing when images are taken changes. Check that the images of the measured objects taken when the Brightness Correction Mode is ON are appropriate.	p. 38

Appendices

10-1 Menu Tables.....	172
10-2 External Reference Parameters	183
10-3 Specifications and Dimensions.....	188
10-4 Updating the Software.....	199
10-5 LED Safety	200
10-6 Requirements from Regulations and Standards.....	201

10-1 Menu Tables

Image Tab Page

Menu command		Description	Setting range	Data	Reference	
Camera setup	Focus	The value shown here is used as a reference when adjusting the focus with the focus adjustment screw.	---	---	p. 37	
	Brightness	Brightness	Adjusts the brightness of the image.	AUTO or 1 to 100	Scene	p. 38
		HDR	Suppresses reflections and differences in brightness.	OFF (default) or 1 to 4	Scene	p. 39
		Brightness correction	Use to stabilize the brightness.	ON or OFF (default)	Scene	p. 170
	White balance	Corrects differences in coloring between the image and the actual object.	<ul style="list-style-type: none"> • AUTO • R: 0.001 to 7.999 • G: 0.001 to 7.999 • B: 0.001 to 7.999 	Scene	p. 41	
	Partial input	Used to make the image input range smaller.	752 × 8 to 752 × 480	Scene	p. 88	
	Lighting control	Turns the light in the Sensor ON and OFF.	ON (default) or OFF	Scene	p. 123	
Trigger setup	Trigger delay	Adjusts the time until the Camera shutter opens after the trigger signal is received.	0 to 163 ms (default: 0)	System	p. 44	
Position compensation (Standard Models Only)		Mode ON/OFF	Adjusts the position of the measurement object before measurement.	ON or OFF (default)	Scene	p. 42
Settings	Teach		Performs teaching and sets the judgement parameters.	---	p. 43	
	Model region					
	Insp. region					
	Judgement		Correlation: 0 to 100 (Defaults: Upper limit: 100, Lower limit: 60)			

Inspect Tab Page

Menu command		Description	Setting range	Data	Reference	
Inspection	Item selected	Add item	Used to add, modify, delete, copy, or change the name of an inspection item.	Search, Edge Position, Edge Width, Area, Color Data	---	p. 50
		Modify		---	---	p. 51
		Delete		---	---	p. 51
		Copy		---	---	
		Rename		15 alphanumeric characters	---	

Menu command		Description	Setting range	Data	Reference		
Inspection Settings	Teach for Search	Model region	Used to specify the region of the image to register as the model with a combination of figures.	---	Scene	p. 55	
		Add		Rectangle, Ellipse, Wide circle, or Polygon	Scene	p. 55	
		Delete		---	Scene		
		Copy		---	Scene	---	
		Console		---	Scene	p. 56	
		OR/NOT		OR (default) or NOT	Scene	p. 56	
		One/All		One or All	Scene	---	
		Insp. region	Adjusts the size and position of the measurement region.	---	Scene	p. 57	
		Insp. region	Adjusts the size and position of the measurement region, changes the measurement direction, etc.	---	Scene	p. 62	
		Color ON/OFF	Sets whether to specify an edge color.	ON or OFF (default)	Scene	p. 62	
		Set color.	Specifies the color of the image for edge detection (i.e., the border between the measurement object and background).	R: 0 to 255 B: 0 to 255 G: 0 to 255	Scene		
		Color palette	Displays a palette for color specification.				
		for Area	Insp. region	Adjusts the size and position of the measurement region.	---	Scene	p. 71
			Set color	The color for which to find the area is specified.	---	Scene	p. 70
			Color palette	Displays a palette for color specification.	Hue: 0 to 359, Saturation: 0 to 255 Brightness: 0 to 255 Exclusion: ON or OFF Color inv.: Yes or No (default)	Scene	
			Display Setting	Specifies the type of image to display on the color specification display to check on the image the color that was set for the reference color.	Measurement Image, All Color Image (default), Selected Color Image, or Binary Image	Scene	
			Background color	Specifies the background color of the extracted image.	Black (default), white, red, green, or blue	Scene	
		for Color Data	Insp. region	Moves the measurement region or adjusts the size of the measurement region.	---	Scene	p. 74

Menu command		Description	Setting range	Data	Reference		
Inspection	Settings	Judgement	Used to specify the parameters for an OK judgement for individual judgements. The range for the reference value to judge OK is specified.	0 to 100 (Defaults: Upper limit: 100, Lower limit: 60)	Scene	---	
		Corre. (for Search)				p. 53	
		Position (for Edge Position)				-893 to 893 (Defaults: Upper limit: +893, Lower limit: -893)	p. 60
		Width (for Edge Width)				-893 to 893 (Defaults: Upper limit: +893, Lower limit: -893)	p. 65
		Area (for Area)				-360,960 to 360,960 (Defaults: Upper limit: +360,960, Lower limit: -360,960)	p. 69
		Color Dif. (for Color Data)				0 to 442 (Defaults: Upper limit: +442, Lower limit: 0)	p. 73
		Adjust judgement	Adjusts judgement parameters without stopping measurements.	---	p. 89		
		Auto adjustment	Automatically adjusts the judgement parameters by using actual workpieces which are considered as good or faulty products.	OK Teach or NG Teach	p. 89		
	Method	Sets the calculations to use to automatically adjust the judgement parameters.	Threshold (minimum), Threshold (average) (default), or Threshold (maximum)				
	Details	For Search	Angle range	Sets the rotational range for when the measurement object is at an angle.	$\pm 0^\circ$ (default), $\pm 5^\circ$, $\pm 10^\circ$, $\pm 15^\circ$, $\pm 20^\circ$, $\pm 25^\circ$, $\pm 30^\circ$, $\pm 35^\circ$, $\pm 40^\circ$, or $\pm 45^\circ$	Scene	p. 54
For Edge Width or Edge Position		Edge level	Sets the color density level of the edge.	0 to 100 (default: 50)	Scene	p. 61	
		Noise level	Sets the color density level to treat as noise.	0 to 442 (default: 10)	Scene		
Calculation	Settings	Expression [MENU]	Expression 0 to expression 31	Sets the number of the expression for which to set a calculation.	---	Scene	p. 77
			Expression settings	Sets the expressions.	---	Scene	
			Const.	Inputs constants or mathematical operators.	0 to 9, calculation symbol (() / * - , + TJG)	Scene	p. 77
			Data	Uses the measurement result of other items.	Inspection item, calculation symbols (() / * - , + TJG)	Scene	p. 82
			Math.	Uses functions in expressions.	SIN, COS, ATAN, AND, OR, NOT, ABS, MAX, MIN, MOD, SQRT, ANGL (angle of straight line joining two points (center of gravity and model center)), DIST (distance between two points), calculation symbols (() / * - , + TJG)	Scene	p. 79
			Rename	Deletes/copies the expression or changes the expression name.	---	Scene	p. 77
			Copy		---	Scene	
			Delete		---	Scene	
	Judgement	Specifies the parameters for judgement of results.		Scene	p. 81		

In/Out Tab Page

Menu command		Description	Setting range	Data	Reference		
Log setting	Statistical data	Sets whether to record the number of measurements and the number of NG overall judgements.	ON (default) or OFF	System	p. 114		
	Image logging	Sets the parameter to log measurement image data.	All, Only NG, or None (default)	System	p. 110 p. 114		
	Data logging	Sets the parameter to log measurement data from inspection items.	All (default), Only NG, or None (default)	System			
	Delete Log	Resets the log data without turning OFF the power supply.	---	---	p. 114		
I/O setting	I/O terminals	Output	OUT0	Used to assign output signals to OUT0, OUT1, and OUT2. OR (Total judgement) (default) or OR0 (Item0 judgement) to OR31 (Item31 judgement)	System	p. 132	
			OUT1		BUSY (default) or OR0 (Item0 judgement) to OR31 (Item31 judgement)		System
			OUT2		ERROR (default) or OR0 (Item0 judgement) to OR31 (Item31 judgement)		System
		Output polarity	Sets the ON condition for the OR signal.	OK: ON or NG: ON (default)	System	p. 136	
		Output mode	Sets the output timing for the judgement result.	One-shot output or Level output (default)	System	p. 134	
		Output delay	When one-shot output mode is selected, this parameter sets the delay from when measurement processing is completed until when the OR signal turns ON.	0 to 1,000 ms (default: 0 ms)	System		
		Output time	When one-shot output mode is selected, this parameter sets the time that the OR signal is ON.	0 to 1,000 ms (default: 5 ms)	System		
		BUSY output	Specifies when to turn OFF the BUSY signal after starting measurement processing.	Measurement (default), Data logging, Image logging, or Result display	System	p. 112	
		BUSY polarity	Sets the ON condition for the BUSY signal output.	BUSY: ON (default), READY: ON	System	p. 136	
		Input	Input mode	Specifies whether to use functions other than scene switching for external parallel commands.	Standard mode (default) or Expanded mode	System	p. 137

Menu command		Description	Setting range	Data	Reference		
I/O setting	Ethernet	Output data set	---	Data 0 to data 31	---	p. 144	
		[MENU]	Settings	Sets data to output to selected data number.	Text strings of the set inspection items and expressions.		---
		Rename	Changes the name of the selected data number.	The name can be changed to a name with up to 15 alphanumeric characters.	---		
		Copy	Copies the contents registered in the selected data number to another data number.	---	---		
		Delete	Clears the content of the selected data number.	---	---		
	Output form		---	---	---	p. 145	
	Output form		Selects the format of the data to be output.	ASCII (default) or Binary	Scene		
	When output format is ASCII	Digits of integer	Sets the digits of the integer part, including the sign. However, + is not output for positive numbers. Example: Setting 4-digit data: -5963 is output as -999.	1 to 10 (Default: 6)	Scene		
		Digits of decimal	Sets the output digits for the decimal part. If it is set to 0, the decimal part is rounded off before the data is output.	0 to 4 (default: 4)	Scene		
		Minus	Selects what to display as the sign when the number is negative.	- (Default) or 8	Scene		
		0 suppress	Selects the method to adjust unused digits on the left in output data. ON: Zeros are inserted for unused digits. OFF: Spaces are inserted for unused digits. Example: The following examples are for when five integer digits and three decimal digits are set and the data is 100.000. ON: 00100.000 OFF: _100.000 (The underscore indicates a space.)	ON or OFF (default)	Scene		
	Output form	When Output Format Is ASCII	Field separator	Selects the separator to use between output data.	None (default), comma, tab, space, CR, LF, or CR+LF	Scene	p. 152
Record separator			Selects the separator to use between sets of output data.	None (default), comma, tab, space, CR, LF, or CR+LF	Scene	p. 145	
When output format is Binary		Decimal output form	Selects the numerical expression for binary output. Fixed-decimal-point data is multiplied by 1,000 and the result is output.	Floating-point decimal or fixed decimal (default)	Scene	p. 146	
I/O monitor	I/O monitor		Used to check I/O connections.	---	---	p. 109	







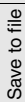

Test Tab Page

Menu command	Description	Setting range	Data	Reference
Continuous test	Used to check the individual judgement results for the inspection items and to adjust the judgement parameters.	---	---	p. 86
Graphic	Displays the input image.			
Graphics + Details	Displays the inspection item individual judgement results and measurement values.			
All results/Region	Displays the inspection item individual judgement results for all inspection items.			p. 91
Trend Monitor	Displays the individual judgement results saved in the Sensor in a trend monitor.			p. 86
Histogram	Displays the individual judgement results saved in the Sensor in a histogram.			
Adjust judgement	Adjusts judgement parameters without stopping measurements.	---	Scene	p. 89
Auto adjustment	Automatically adjusts the judgement parameters by using actual workpieces which are considered as good or faulty products.	OK Teach, NG Teach		
Method	Selects the expression to use to automatically adjust the judgement parameters.	Threshold (minimum), Threshold (average) (default), or Threshold (maximum)		
Auto display (trend monitor and histogram only)	Same as the trend monitor and histogram for [Run] Mode.		---	p. 98 p. 99
Display range (trend monitor and histogram only)				
Number of data (trend monitor only)				p. 98
Number of data (histogram only)				p. 99
Save data		Saves scene data and system data.	---	---

Run Tab Page (from Setup Display)

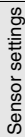
Menu command	Description	Setting range	Data	Reference
Switch to Run mode	Switches to Run Mode.	---	---	p. 94



Setup Mode

Menu command		Description	Setting range	Data	Reference		
Select scene			---	---	p. 104		
	Select	Switches to a registered scene.	---				
	Rename	Used to delete, copy, or change the name of a scene.	15 alphanumeric characters				
	Copy		---				
	Clear						
		Scene data	---	---	p. 117		
		Scene group data				Saves all scene data with an SGP file name extension.	
		Sensor system data				Saves system data with an SYD file name extension.	
		All Sensor data				Saves all Sensor data with a BKD file name extension.	
		Touch Finder data				Saves Touch Finder data with an MSD file name extension.	
		Statistical data	---	---	p. 110		
		Logging image				Saves image data with an IFZ file name extension.	
		Logging data				Saves measurement data with a CSV file name extension.	
	Scene data		---	---	p. 117		
	Scene group data					Loads scene group data.	
	Sensor system data					Loads system data.	
	All Sensor data					Loads all Sensor data.	
	Touch Finder data					Loads Touch Finder data.	
	Information		---	---	p. 124		
		Model				Used to check the model and software version of the connected Sensor.	System
		Version					
		Name					
	MAC address		Used to check the MAC address of the connected Sensor.	---	---		
		Rename	Used to change the name of a connected Sensor.	15 alphanumeric characters max.	---	p. 124	
		Memory state	Used to check the status of Sensor memory.	---	---	p. 124	
	View history	Displays a history of errors that have occurred in the Sensor.	---	System	p. 168		
	Delete history	Deletes the error history.		---	---	p. 169	







Menu command		Description	Setting range	Data	Reference		
Sensor settings	Startup settings	Startup mode	Sets whether the startup scene number is set manually.	ON or OFF (Scene number when settings were saved is startup scene number.)	System	p. 105	
		Startup scene	Set the scene number to use at startup.	Standard models: 0 to 31, Single-function models: 0 to 7, Default: 0	System		
	Password settings	Password ON/OFF	Enables (ON) or disables (OFF) the password.	OFF (default) or ON	System	p. 120	
		Enter password	Sets a password.	15 characters max.	System		
	Adjustment mode in Run		Sets whether to adjust judgement parameters in Run Mode.	OFF (default) or ON	---	p. 101	
	Network settings	Ethernet					p. 33
		Auto		Selects whether to use the automatic IP address setting method.	ON (default) or OFF	System	
		IP address		Enter the IP address of the Sensor. (Enabled when automatic setting is OFF.)	a.b.c.d a: 1 to 223 b: 0 to 255 c: 0 to 255 d: 2 to 254 (Default: 10.5.5.100)	System	p. 33
		Subnet mask		Inputs the subnet mask. (Enabled when automatic setting is OFF.)	0.0.0.0 to 255.255.255.255 (Default: 255.255.255.0)	System	p. 33
	Initialize		Initializes the Sensor settings and saved data.	---	---	p. 123	
Restart		Restarts the Sensor	---	---			
Update		Updates the Sensor system to the most recent data.	---	---	p. 199		
TF settings	Information		Used to check the Touch Finder information.	---	System	p. 124	
	Model		Used to check the Touch Finder model.	---	---	---	
	Version		Used to check the software version of the Touch Finder.	---	---	p. 124	
	MAC address		Used to check the MAC address of the Touch Finder.	---	---		
	Memory state		Used to check the Touch Finder memory state.	---	---	p. 124	
	Error history	View history	Displays a history of errors that have occurred in the Touch Finder.	---	System	p. 168	
		Delete history	Deletes the error history.	---	---		
	Battery level		Used to check the battery level.	---	---	p. 124	
	File format		Used to set the output format for output log data to a file.	---	---	p. 111	
	Field separator			None, Comma (default), Tab, Space, Colon, Semicolon, CR, or CR+LF	---		
Decimal symbol			None, Point (default), or Comma	---			
Record separator			None, Comma, Tab, Space, Colon, Semicolon, CR, or CR+LF (default)	---			

Menu command		Description	Setting range	Data	Reference	
TF settings	SD card	SD card information	Displays the capacity and remaining memory in the SD card.	---	---	p. 119
		Format	Formats an SD card.	---	---	p. 119
	Startup display	Display pattern	Sets the display to use in Run Mode.	Graphic, Graphics + Details, All results/Region, Statistical data, Trend monitor, Histogram	System	p. 96
		Display update mode	Sets the image to update in Run Mode.	Latest image, Last NG image		
	LCD backlight	Brightness	Sets the brightness.	0 to 5	System	p. 108
		ECO mode	Enables (ON) or disables (OFF) ECO Mode.	ON, OFF	System	p. 108
	Ethernet			---	System	p. 33
		IP address	Inputs the IP address of the Touch Finder.	a.b.c.d a: 1 to 223 b: 0 to 255 c: 0 to 255 d: 0 to 255 (Default: 10.5.5.100)	System	p. 33
		Subnet mask	Inputs the subnet mask.	0.0.0.0 to 255.255.255.255 (Default: 255.255.255.0)		
		Search unreachable sensors	Displays the IP address if the same IP address is used for more than one Sensor or if there is Sensor that is not in the subnet. You can change this IP address and subnet mask. This setting is valid only when automatic setting of the Sensor's IP address is OFF.	---	---	---
	Language		Changes the language to display on the Touch Finder.	English, German, French, Italian, Spanish, Traditional Chinese, Simplified Chinese, Korean, or Japanese (The default language is selected at startup.)	System	p. 123
	Time settings		Used to set the current date and time.	Default: Selected at startup.	System	p. 123
	Touch screen calib		Used when there is an offset between the touch screen positions and pointers.	---	---	p. 124
	Initialize		Initializes the Touch Finder settings.	---	---	p. 123
Restart		Restarts the Touch Finder.	---	---	p. 123	
Update		Updates the Touch Finder system to the most recent data.	---	---	p. 199	

Run Mode

Menu command		Description	Setting range	Data	Reference
Select display	Graphic	Displays the input image.	---	---	p. 96
	Graphics + Details	Displays the inspection item individual judgement results and measurement values.		---	
	Statistical data	Displays the total number of measurements and the total number of NG overall judgements and the NG ratio from when the power supply was turned ON.			
	All results/Region	Displays the inspection item individual judgement results for all inspection items.		---	
	Trend Monitor	Displays the individual judgement results saved in the Sensor in a trend monitor.		---	p. 98
	Histogram	Displays the individual judgement results saved in the Sensor in a histogram.		---	p. 99
	Adjust judgement (Except for statistical data)	Adjusts judgement parameters without stopping measurements.	---	---	p. 101
	Auto display (trend monitor and histogram only)	Automatically sets the display range according to the measurement results.	OFF or ON (default)	---	p. 98, p. 99
	Display range (trend monitor and histogram only)	Changes the display range of measurement values.	-999,999,999 to 999,999,999		p. 98, p. 99
	Number of data (trend monitor only)	Changes the number of displayed measurement values.	200, 400, or 1,000 (default: 200)		p. 98
	Number of data (histogram only)	Changes the number of displayed measurement values (i.e., the vertical display range of the histogram).	5 to 1,000	---	p. 99
	Clear results (graphic or graphic + details list)	Clears the measurement results of the inspection items.	---	---	---
	Delete stats (total data)	Clears the total results of the inspection items.	---	---	---
Logging	Image logging	Starts and stops logging in external memory.	ON: Start or OFF: Stop	---	p. 110
	Data logging		ON: Start or OFF: Stop	---	
TF settings		The same as for Setup Mode. (This does not apply to the PC Tool.) The resolution of the measurement image can be set on the PC Tool.		---	p. 123
Sensor setting		Switches to Setup Mode.	---	---	p. 94
Sensor monitor	Multi sensor	Simultaneously displays the images for multiple connected Sensors.	---	---	p. 96
	NG sensor	From multiple connected Sensors, displays the image of only the Sensors with NG results.	---	---	
Switch sensor	Select	Switches to the selected Sensor.	---	---	---
	Connections		Displays the name of the Sensor detected by the Touch Finder and the connection status.		
		Auto connect	Automatically detects and connects the Sensors that are connected.		

Common Menu Commands

Menu command	Description	Setting range	Data	Reference
 Only-image Button	Hides text and displays only the image.	---	---	p. 108
 Display Button	 Zoom-in Button	Enlarges the image display.	---	p. 106
	 Zoom-out Button	Reduces the image display.		
	 FIT Button	Fits the image to the display size.		
	 Display Button	Changes the image display method.	Setup Mode: Camera (Live, Freeze) Log, or File Run Mode: Latest image or Last NG image	---
 Capture Button	Used to capture the current display and save it in external memory, e.g., an SD card.	---	---	p. 121

10-2 External Reference Parameters

Position compensation

External reference number	Data name	Setting/Acquisition	Data range	Default	Expression text string	Logged data/Judgement parameter
0	Judgement	Acquisition only	-2: No judgement (not measured), 0: Judgement is OK, -1: Judgement is NG, -13: Teaching not performed error, -14: Figure not registered error, -15: Out of range error	-2	JG	---
5	Scroll X	Acquisition only	-99999.9999 to 99999.9999	0	DX	---
6	Scroll Y	Acquisition only	-99999.9999 to 99999.9999	0	DY	---
8	Position X	Acquisition only	-99999.9999 to 99999.9999	0	X	---
9	Position Y	Acquisition only	-99999.9999 to 99999.9999	0	Y	---
11	Reference position X	Acquisition only	-99999.9999 to 99999.9999	0	SX	---
12	Reference position Y	Acquisition only	-99999.9999 to 99999.9999	0	SY	---
14	Correlation	Acquisition only	0 to 100	0	CR	---
124	Reference position X	Setting/Acquisition	0 to 99999.9999	0	---	---
125	Reference position Y	Setting/Acquisition	0 to 99999.9999	0	---	---
166	Correlation judgement upper limit	Setting/Acquisition	0 to 100	100	---	Adjust judgement
167	Correlation judgement lower limit	Setting/Acquisition	0 to 100	60	---	

Search

External reference number	Data name	Setting/Acquisition	Data range	Default	Expression text string	Logged data/Judgement parameter
0	Judgement	Acquisition only	-2: No judgement (not measured), 0: Judgement is OK, -1: Judgement is NG, -13: Teaching not performed error, -14: Figure not registered error, -15: Out of range error	-2	JG	---
5	Correlation	Acquisition only	0 to 100	0	CR	Logged data
6	Position X	Acquisition only	-99999.9999 to 99999.9999	0	X	---
7	Position Y	Acquisition only	-99999.9999 to 99999.9999	0	Y	---
8	Angle	Acquisition only	-180 to 180	0	TH	---
9	Reference position X	Acquisition only	-99999.9999 to 99999.9999	0	SX	---
10	Reference position Y	Acquisition only	-99999.9999 to 99999.9999	0	SY	---

External reference number	Data name	Setting/Acquisition	Data range	Default	Expression text string	Logged data/Judgement parameter
11	Reference angle	Acquisition only	-180 to 180	0	ST	---
142	Correlation upper limit	Setting/Acquisition	0 to 100	100	---	Adjust judgement
143	Correlation lower limit	Setting/Acquisition	0 to 100	60		
151	Angle range	Setting/Acquisition	0: no rotation, 1: ± 5 , 2: ± 10 , 3: ± 15 , 4: ± 20 , 5: ± 25 , 6: ± 30 , 7: ± 35 , 8: ± 40 , or 9: ± 45	0	---	---

Edge position

External reference number	Data name	Setting/Acquisition	Data range	Default	Expression text string	Logged data/Judgement parameter
0	Judgement	Acquisition only	-2: No judgement (not measured), 0: Judgement is OK, -1: Judgement is NG, -13: Teaching not performed error, -14: Figure not registered error, -15: Out of range error	-2	JG	---
5	Edge position X	Acquisition only	-99999.9999 to 99999.9999	0	X	---
6	Edge position Y	Acquisition only	-99999.9999 to 99999.9999	0	Y	---
7	Reference position X	Acquisition only	-99999.9999 to 99999.9999	0	SX	---
8	Reference position Y	Acquisition only	-99999.9999 to 99999.9999	0	SY	---
9	Offset amount	Acquisition only	-99999.9999 to 99999.9999	0	DF	Logged data
120	Edge color specification	Setting/Acquisition	0: none or 1: enabled	0	---	---
121	Edge color R	Setting/Acquisition	0 to 255	255	---	---
122	Edge color G	Setting/Acquisition	0 to 255	255	---	---
123	Edge color B	Setting/Acquisition	0 to 255	255	---	---
132	Edge level	Setting/Acquisition	0 to 100	50	---	---
133	Noise level	Setting/Acquisition	0 to 442	5	---	---
145	Offset amount upper limit	Setting/Acquisition	-99999.9999 to 99999.9999	893	---	Adjust judgement
146	Offset amount lower limit	Setting/Acquisition	-99999.9999 to 99999.9999	-893		

Edge width

External reference number	Data name	Setting/Acquisition	Data range	Default	Expression text string	Logged data/Judgement parameter
0	Judgement	Acquisition only	-2: No judgement (not measured), 0: Judgement is OK, -1: Judgement is NG, -13: Teaching not performed error, -14: Figure not registered error, -15: Out of range error	-2	JG	---
5	Edge width	Acquisition only	0 to 99999.9999	0	W	---
6	Reference width	Acquisition only	0 to 99999.9999	0	SW	---
7	Width difference	Acquisition only	0 to 99999.9999	0	DF	Logged data
8	Edge position X0	Acquisition only	-99999.9999 to 99999.9999	0	---	---
9	Edge position Y0	Acquisition only	-99999.9999 to 99999.9999	0	---	---
10	Edge position X1	Acquisition only	-99999.9999 to 99999.9999	0	---	---
11	Edge position Y1	Acquisition only	-99999.9999 to 99999.9999	0	---	---
12	Reference position X0	Acquisition only	-99999.9999 to 99999.9999	0	---	---
13	Reference position Y0	Acquisition only	-99999.9999 to 99999.9999	0	---	---
14	Reference position X1	Acquisition only	-99999.9999 to 99999.9999	0	---	---
15	Reference position Y1	Acquisition only	-99999.9999 to 99999.9999	0	---	---
16	Position offset X0	Acquisition only	-99999.9999 to 99999.9999	0	---	---
17	Position offset Y0	Acquisition only	-99999.9999 to 99999.9999	0	---	---
18	Position offset X1	Acquisition only	-99999.9999 to 99999.9999	0	---	---
19	Position offset Y1	Acquisition only	-99999.9999 to 99999.9999	0	---	---
121	Edge color specification	Setting/Acquisition	Edge color specification 0: Not specified, 1: Specified	0	---	---
131	Edge color R	Setting/Acquisition	0 to 255	255	---	---
132	Edge color G	Setting/Acquisition	0 to 255	255	---	---
133	Edge color B	Setting/Acquisition	0 to 255	255	---	---
137	Edge level	Setting/Acquisition	0 to 100	50	---	---
139	Noise level	Setting/Acquisition	5 to 442	5	---	---
192	Width upper limit	Setting/Acquisition	-893.0000 to 893.0000	893	---	Adjust judgement
193	Width lower limit	Setting/Acquisition	-893.0000 to 893.0000	-893		

Area

External reference number	Data name	Setting/Acquisition	Data range	Default	Expression text string	Logged data/Judgement parameter
0	Judgement	Acquisition only	-2: No judgement (not measured), 0: Judgement is OK, -1: Judgement is NG, -13: Teaching not performed error, -14: Figure not registered error, -15: Out of range error	-2	JG	---
5	Area	Acquisition only	0 to 999999999.9999	0	AR	---
6	Gravity X	Acquisition only	-99999.9999 to 99999.9999	0	X	---
7	Gravity Y	Acquisition only	-99999.9999 to 99999.9999	0	Y	---
8	Reference area	Acquisition only	0 to 99999.9999	0	SA	---
9	Reference point X	Acquisition only	-99999.9999 to 99999.9999	0	SX	---
10	Reference point Y	Acquisition only	-99999.9999 to 99999.9999	0	SY	---
11	Area difference	Acquisition only	-999999999.9999 to 999999999.9999	0	DF	Logged data
127	Background color	Setting/Acquisition	0: black, 1: white, 2: red, 3: green, or 4: blue	0	---	---
129	Area color inversion	Setting/Acquisition	0: None or 1: Enabled	0	---	---
144	Image type	Setting/Acquisition	0: Measurement Image 1: All Color Image 2: Selected Color Image 3: Binary Image	0	---	---
145	Enable/disable multiple selection	Setting/Acquisition	0: Enabled 1: Disabled	0	---	---
146	Area difference upper limit	Setting/Acquisition	-999999999.9999 to 999999999.9999	360960.0000	---	Adjust judgement
147	Area difference lower limit	Setting/Acquisition	-999999999.9999 to 999999999.9999	-360960.0000	---	
160+N×10	Use registered color flag	Setting/Acquisition	0: Enabled 1: Disabled	1 (N=0) 0 (N=1 to 3)	---	---
161+N×10	Registered color OR/NOT flag	Setting/Acquisition	0: OR 1: NOT	0	---	---
162+N×10	Maximum registered hue	Setting/Acquisition	0 to 359	359	---	---
163+N×10	Minimum registered hue	Setting/Acquisition	0 to 359	0	---	---
164+N×10	Maximum registered saturation	Setting/Acquisition	0 to 255	255	---	---
165+N×10	Minimum registered saturation	Setting/Acquisition	0 to 255	0	---	---
166+N×10	Maximum registered brightness	Setting/Acquisition	0 to 255	255	---	---
167+N×10	Minimum registered brightness	Setting/Acquisition	0 to 255	0	---	---

Color data

External reference number	Data name	Setting/Acquisition	Data range	Default	Expression text string	Logged data/Judgement parameter
0	Judgement	Acquisition only	-2: No judgement (not measured), 0: Judgement is OK, -1: Judgement is NG, -13: Teaching not performed error, -14: Figure not registered error, -15: Out of range error	-2	JG	---
5	R average	Acquisition only	0 to 255	0	AR	---
6	G average	Acquisition only	0 to 255	0	AG	---
7	B average	Acquisition only	0 to 255	0	AB	---
8	Color difference	Acquisition only	0 to 442	0	AD	Logged data
9	Color deviation	Acquisition only	0 to 221	0	DV	---
124	Color difference upper limit	Setting/Acquisition	0 to 442	442	---	Adjust judgement
125	Color difference lower limit	Setting/Acquisition	0 to 442	0		

10-3 Specifications and Dimensions

Sensor

Specifications

Item		Single-function models	Standard models
Model	NPN	FQ-S10□□□□	FQ-S20□□□□
	PNP	FQ-S15□□□□	FQ-S25□□□□
Field of view		Refer to Table 1.	
Installation distance		Refer to Table 1.	
Main functions	Inspection items	Search, area, color data, edge position, and edge width	
	Number of simultaneous measurements	1	32
	Position compensation	None	Supported
	Number of registered scenes	8	32
Image input	Image processing method	Real color	
	Image filter	High dynamic range (HDR), polarizing filter (attachment), and white balance	
	Image elements	1/3-inch color CMOS	
	Shutter	1/250 to 1/30,000	
	Processing resolution	752 × 480	
Lighting	Lighting method	Pulse	
	Lighting color	White	
Data logging	Measurement data	In Sensor: 1,000 items (If a Touch Finder is used, results can be saved up to the capacity of an SD card.)	
	Images	In Sensor: 20 images (If a Touch Finder is used, images can be saved up to the capacity of an SD card.)	
Auxiliary function		Math (arithmetic, calculation functions, trigonometric functions, and logic functions)	
Measurement trigger		External trigger (single or continuous)	

Item		Single-function models	Standard models
I/O specifications	Input signals	7 signals <ul style="list-style-type: none"> • Single measurement input (TRIG) • Control command input (IN0 to IN5) 	
	Output signals	3 signals <ul style="list-style-type: none"> • Control output (BUSY) • Overall judgement output (OR) • Error output (ERROR) Note: The three output signals can be allocated for the judgements of individual inspection items.	
	Ethernet specifications	100Base-TX/10Base-T Numerical outputs and control commands are supported with no-protocol communications.	
	Input specifications	Refer to Table 2.	
	Output specifications		
	Connection method	Special connector cables Power supply and I/O: 1 cable (FQ-WD□□□□) Touch Finder and computer: 1 cable (FQ-WN□□□□)	
Indications		Judgement results indicator (color: orange), ERROR indicator (color: red), and BUSY indicator (color: green)	
Ratings	Power supply voltage	20.4 to 26.4 VDC (including ripple)	
	Insulation resistance	Between all lead wires and case: 0.5 MΩ (at 250 V)	
	Current consumption	2.4 A max.	
Environmental immunity	Ambient temperature range	Operating: 0 to 50°C Storage: -25 to 65°C (with no icing or condensation)	
	Ambient humidity range	Operating and storage: 35% to 85% (with no condensation)	
	Ambient atmosphere	No corrosive gas	
	Vibration resistance (destruction)	10 to 150 Hz, single amplitude: 0.35 mm, X/Y/Z directions 8 min each, 10 times	
	Shock resistance (destruction)	150 m/s ² 3 times each in 6 direction (up, down, right, left, forward, and backward)	
	Degree of protection	IEC 60529 IP67 (Except when Polarizing Filter Attachment is mounted.)	
Materials		Sensor: PBT, PC, SUS Mounting Bracket: PBT Polarizing Filter Attachment: PBT, PC Ethernet connector: Oil-resistance vinyl compound I/O connector: Lead-free heat-resistant PVC	
Weight		Depends on field of view and installation distance. Refer to Table 1.	
Accessories		Mounting Bracket (FQ-XL)(1) Polarizing Filter Attachment (FQ-XF1) (1) Instruction Manual Quick Startup Guide Member Registration Sheet Warning Label	
LED class ²		Class 2	

Table 1

Single-function models		Standard models		Field of view (H×V) *1	Installation distance	Number of LEDs	Weight
NPN	PNP	NPN	PNP				
FQ-S10010F	FQ-S15010F	FQ-S20010F	FQ-S25010F	7.5 × 4.7 to 13 × 8.2 mm	38 to 60 mm	4	200 g max.
FQ-S10050F	FQ-S15050F	FQ-S20050F	FQ-S25050F	13 × 8.2 to 53 × 33 mm	56 to 215 mm	4	
FQ-S10100F	FQ-S15100F	FQ-S20100F	FQ-S25100F	53 × 33 to 240 × 153 mm	220 to 970 mm	8	
FQ-S10100N	FQ-S15100N	FQ-S20100N	FQ-S25100N	29 × 18 to 300 × 191 mm	32 to 380 mm	8	

*1: Tolerance: ±10% max.

*2: Applicable standards: JIS C 6802:2005

Table 2

Item	NPN	PNP
Input specifications	ON: Shorted to 0 V, or 1.5 V max. OFF: Open (leakage current: 0.1 mA max.)	ON: Shorted to power supply voltage, or power supply voltage -1.5 V max. OFF: Open (leakage current: 0.1 mA max.)
Output specifications	NPN open collector 30 VDC, 50 mA max., residual voltage: 1.2 V max.	PNP open collector 30 VDC, 50 mA max., residual voltage: 1.2 V max.

Dimensions

FQ-S10010F/-S10050F
 FQ-S15010F/-S15050F
 FQ-S20010F/-S20050F
 FQ-S25010F/-S25050F

(Unit: mm)

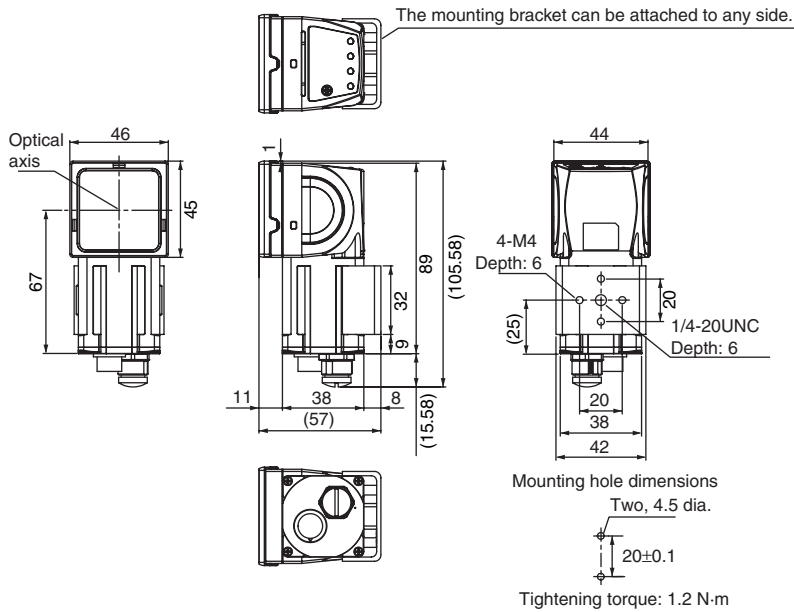

FQ-S10100F/-S10100N/-S20100N
 FQ-S15100F/-S15100N/-S25100N
 FQ-S20100F
 FQ-S25100F

(Unit: mm)

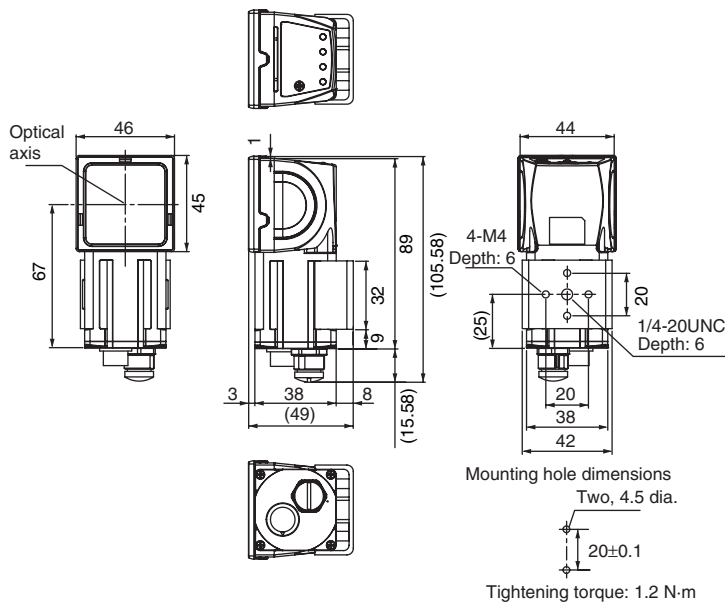

Touch Finder

Specifications

Item		Model with DC power supply		Model with AC/DC/battery power supply	
		FQ-D30		FQ-D31	
Number of connectable Sensors		8 max.			
Main functions	Types of measurement displays		Last result display, last NG display, trend monitor, histograms		
	Types of display images		Through, frozen, zoom-in, and zoom-out images		
	Data logging		Measurement results, measured images		
	Menu language		English, German, French, Italian, Spanish, Traditional Chinese, Simplified Chinese, Korean, or Japanese		
Indications	LCD	Display device	3.5-inch TFT color LCD		
		Pixels	320 × 240		
		Display colors	16,777,216		
	Backlight	Life expectancy ¹	50,000 hours at 25°C		
		Brightness adjustment	Provided		
		Screen saver	Provided (The time setting can be changed.)		
	Indicators		Power indicator (color: green): POWER Error indicator (color: red): ERROR SD card access indicator (color: yellow): SD ACCESS	Power indicator (color: green): POWER Error indicator (color: red): ERROR SD card access indicator (color: yellow): SD ACCESS Charge indicator (color: orange): CHARGE	
Operation interface	Touch screen	Method	Resistance film		
		Life expectancy ²	1,000,000 operations		
External interface	Ethernet		100BASE-TX/10BASE-T		
	SD card		SDHC-compliant, Class 4 or higher recommended		
Ratings	Power supply voltage		DC power connection: 20.4 to 26.4 VDC (including ripple)	DC power connection: 20.4 to 26.4 VDC (including ripple) AC adapter (manufactured by Sino-American Japan Co., Ltd) connection: 100 to 240 VAC, 50/60 Hz Battery connection: FQ-BAT1 Battery (1 cell, 3.7 V)	
	Continuous operation on Battery ³		---	1.5 h	
	Current consumption		DC power connection: 0.2 A	DC power connection: 0.2 A, Charging battery: 0.4 A	
	Insulation resistance		Between all lead wires and case: 0.5 MΩ (at 250 V)		

Item		Model with DC power supply	Model with AC/DC/battery power supply
		FQ-D30	FQ-D31
Environmental immunity	Ambient temperature range	Operating: 0 to 50°C Storage: -25 to 65°C (with no icing or condensation)	Operating: 0 to 50°C when mounted to DIN Track or panel 0 to 40°C when operated on a Battery Storage: -25 to 65°C (with no icing or condensation)
	Ambient humidity range	Operating and storage: 35% to 85% (with no condensation)	
	Ambient atmosphere	No corrosive gas	
	Vibration resistance (destruction)	10 to 150 Hz, single amplitude: 0.35 mm, X/Y/Z directions 8 min each, 10 times	
	Shock resistance (destruction)	150 m/s ² 3 times each in 6 direction (up, down, right, left, forward, and backward)	
	Degree of protection	IEC 60529 IP20	
Weight		Approx. 270 g (without Battery and hand strap)	
Dimensions		95 × 85 × 32.5 mm	
Materials		Case: ABS	
Accessories		Touch Pen (FQ-XT), Instruction Manual	

- *1 This is a guideline for the time required for the brightness to diminish to half the initial brightness at room temperature and humidity. No guarantee is implied. The life of the backlight is greatly affected by the ambient temperature and humidity. It will be shorter at lower or higher temperatures.
- *2 This value is only a guideline. No guarantee is implied. The value will be affected by operating conditions.
- *3 This value is only a guideline. No guarantee is implied. The value will be affected by the operating environment and operating conditions.

• Battery Specifications

Item	FQ-BAT1
Battery type	Secondary lithium ion battery
Nominal capacity	1,800 mAh
Rated voltage	3.7 V
Dimensions	35.3 × 53.1 × 11.4 mm
Ambient temperature range	Operating: 0 to 40°C Storage: -25 to 65°C (with no icing or condensation)
Ambient humidity range	Operating and storage: 35% to 85% (with no condensation)
Charging method	Charged in Touch Finder (FQ-D31).
Charging time ^{*1}	2 h
Usage time ^{*1}	1.5 h
Battery backup life ^{*2}	300 charging cycles
Weight	50 g max.

- *1 This value is only a guideline. No guarantee is implied. The value will be affected by operating conditions
- *2 This is a guideline for the time required for the capacity of the Battery to be reduced to 60% of the initial capacity. No guarantee is implied. The value will be affected by the operating environment and operating conditions.

Dimensions

- FQ-D30/-D31

(Unit: mm)

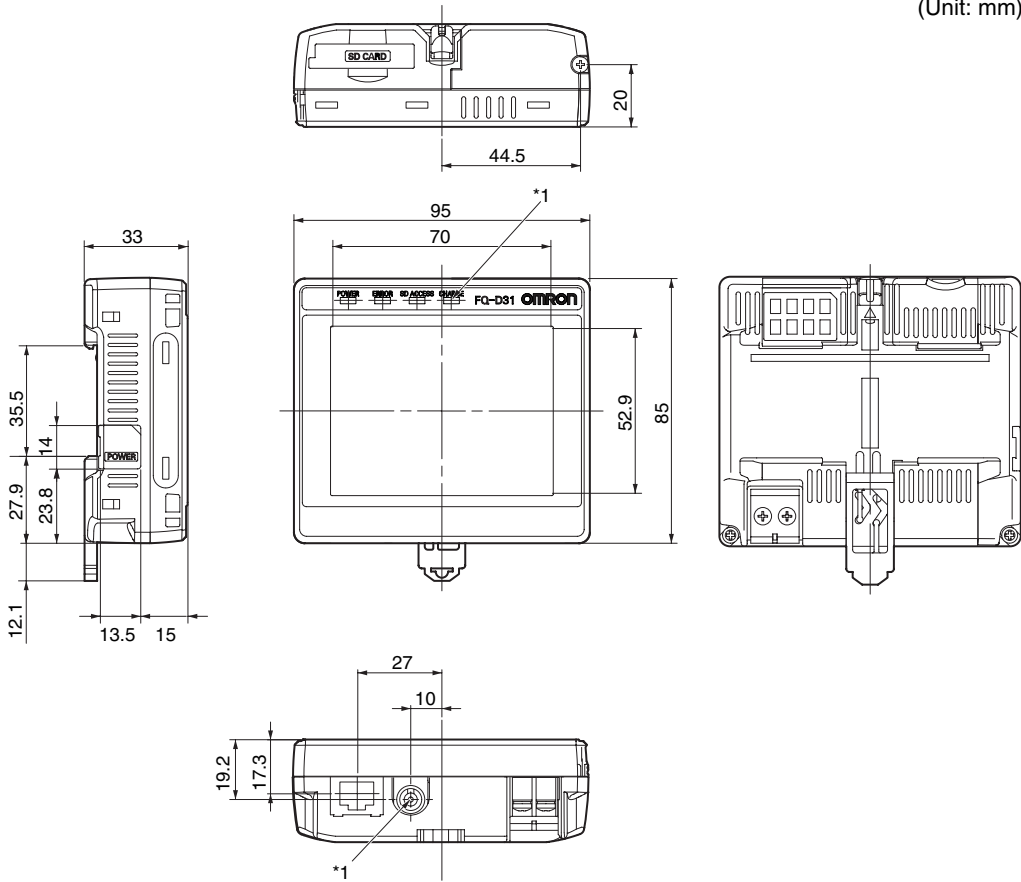

*1: Provided on the FQ-D31 only.

- Panel Mounting Adapter (FQ-XPM)

(Unit: mm)

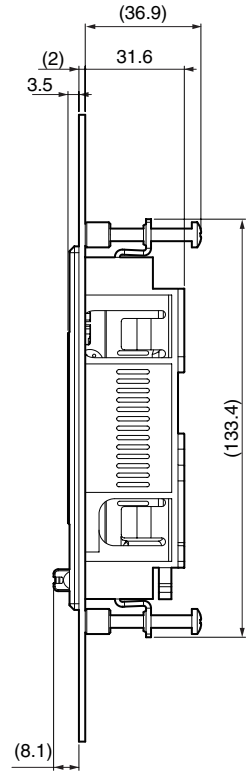
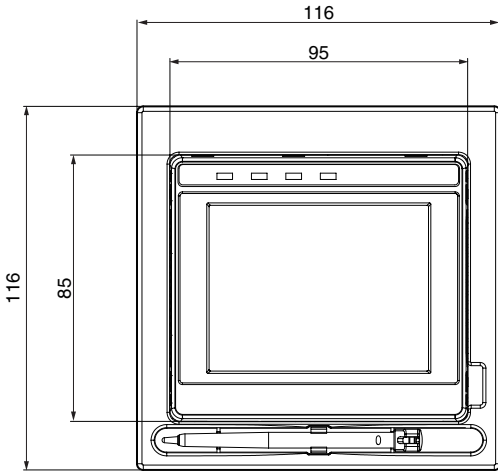

- Panel cutout dimensions

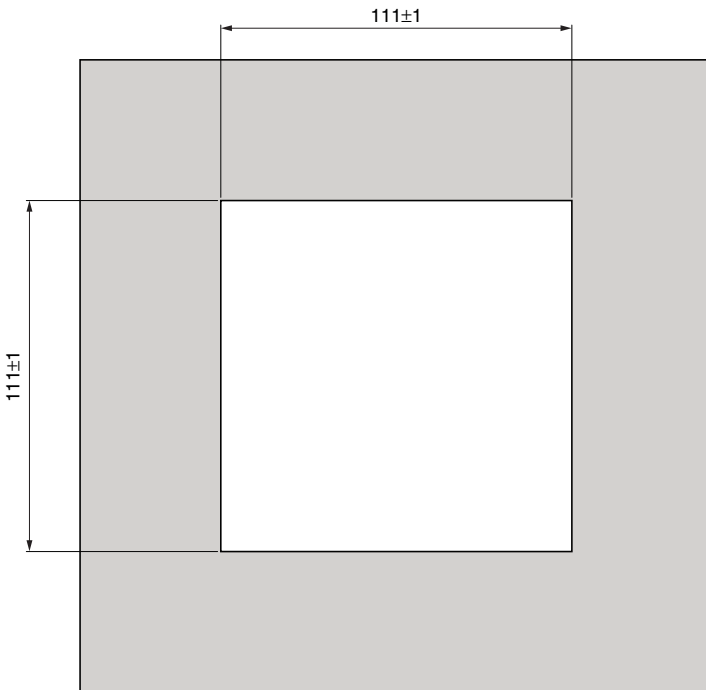

System Requirements for PC Tool for FQ

The system requirements for the PC Tool are given in the following table.

Item	Requirement
OS	<ul style="list-style-type: none"> Microsoft Windows XP Home Edition/Professional SP2 or higher^{*1} Microsoft Windows 7 Home Premium or higher^{*1}
Hardware	<ul style="list-style-type: none"> CPU: Core 2 Duo 1.06 GHz or the equivalent or higher RAM: 1 GB min. HDD: 500 MB min. available space^{*2} Monitor: 1,024 x 768 dots min.

*1. The Japanese and English versions support only 32-bit OS versions.

*2. Available space is also required separately for data logging.

Options

Specifications

• I/O Cables

Item	Model	FQ-WD002	FQ-WD010	FQ-WD020
Cable length		2 m	10 m	20 m
Cable type		Robot cable		
Wire gauge	Power line	AWG24	AWG24 to AWG20	
	Other lines	AWG28		
Cable diameter		6.4	6.4 to 6.7	
Minimum bending radius		41.4 mm		
Weight		100 g	500 g	1500 g

• FQ Ethernet Cable

Item	Model	FQ-WN002	FQ-WN010	FQ-WN020
Cable length		2 m	10 m	20 m
Cable type		Robot cable		
Minimum bending radius		40 mm		
Weight		125 g	620 g	1780 g

• AC Adapter

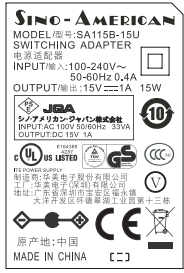
Item	Model	FQ-AC1	FQ-AC2	FQ-AC3	FQ-AC4	FQ-AC5	FQ-AC6
Plug type		A	A	A	C	BF	O
Certified standards		PSE	UL/CSA	CCC mark	---	---	---
Input voltage		100 to 240 VAC (90 to 264 VAC)					
Input current		0.4 A max., 100 VAC, 50 Hz when connected to maximum load					
Input frequency		47 to 63 Hz					
Output voltage		15 VDC±5%					
Output current		1 A max.					
Ambient temperature range		Operating: 0 to 40°C Storage: -20 to 65°C (with no icing or condensation)					
Ambient humidity range		Operating and storage: 35% to 80% (with no condensation)					
Material		Case: PPE					
Cable length		1.5 m					
Dimensions		78 × 50 × 30 mm (without power cable)					
Weight		Approx. 270 g					
Contents of label on AC Adapter		 <p>SINO-AMERICAN MODEL/型号: SA115B-15U SWITCHING ADAPTER 电源适配器 INPUT输入: 100-240V~ 50-60Hz 0.4A OUTPUT输出: 15V=1A 15W JSA シノアメリカン・ジャパン株式会社 INPUT AC: 100V-240V 50/60Hz 0.4A OUTPUT DC: 15V 1A UL LISTED 原产地: 中国 MADE IN CHINA</p>					

Dimensions

• I/O Cables

FQ-WD002

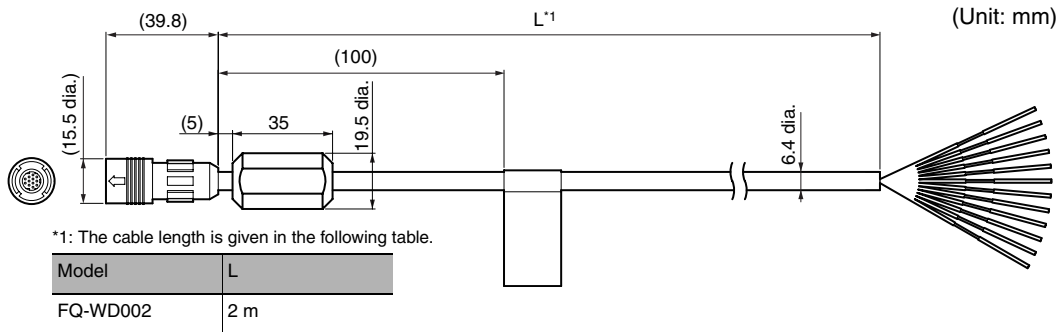

FQ-WD010/WD020

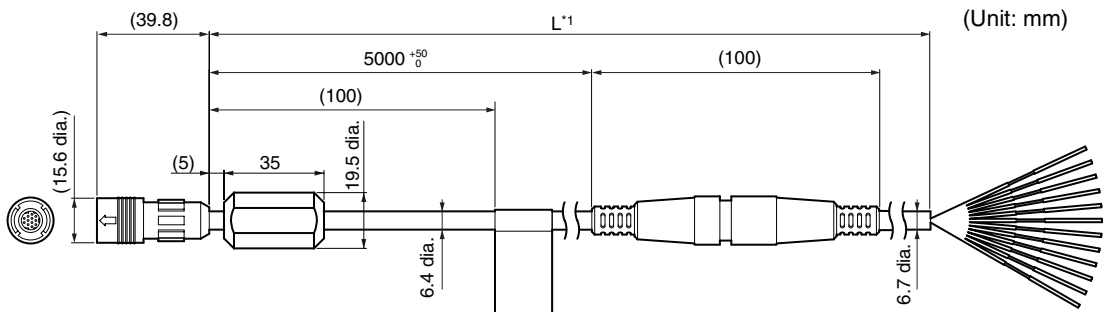

*1: The cable length is given in the following table.

Model	L
FQ-WD010	10 m
FQ-WD020	20 m

• FQ Ethernet Cable

FQ-WN002/WN010/WN020

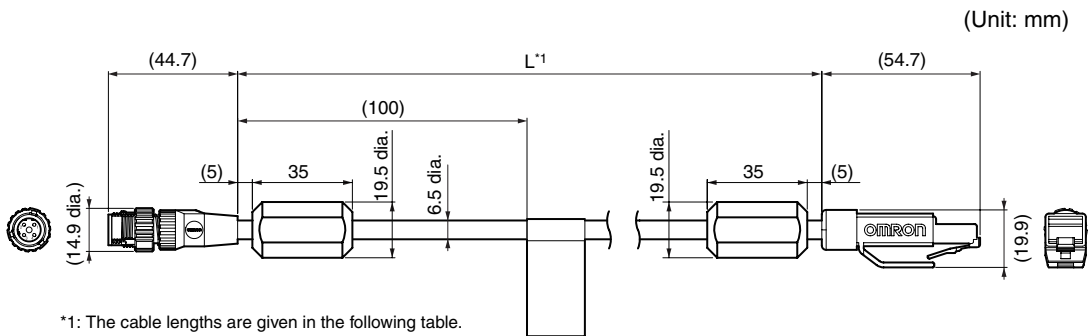

*1: The cable lengths are given in the following table.

Model	L
FQ-WN002	2 m
FQ-WN010	10 m
FQ-WN020	20 m

• AC Adapter

FQ-AC□

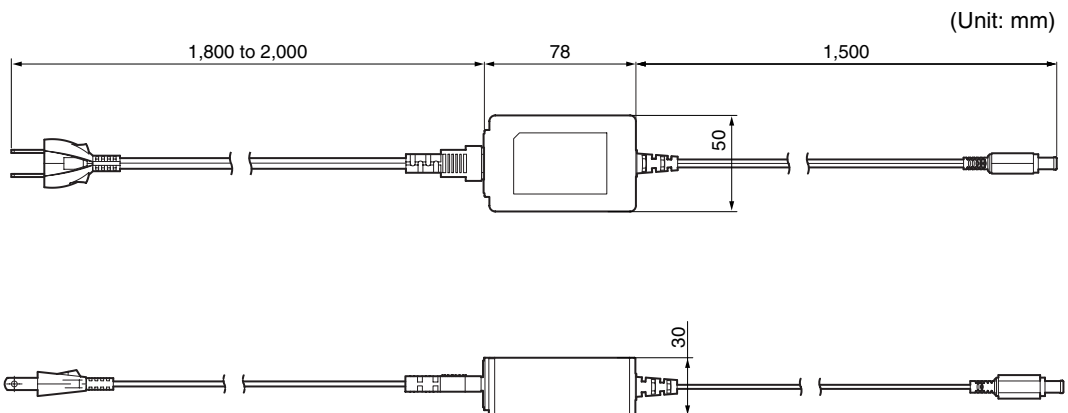

10-4 Updating the Software

The most recent version of the software and PC Tool can be downloaded from the following website for OMRON members. Refer to the *Member Registration Sheet* that is enclosed with the Sensor.



http://www.omron-cxone.com/vision_sys

After you download the software, use the following procedure to update.

- Updating from the PC Tool

- 1** Store the update file you obtained in the following directory.
\\...\My Documents\OMRON FQ\SDCard\UPDATE\SENSOR
- 2** To update the software in the Sensor, press  (Setup Mode) - [Sensor settings] - [Update].

- Updating from the Touch Finder

- 1** Place the update file that you obtained directly in the root folder of the SD card.
- 2** Insert an SD card into the Touch Finder.
- 3** To update the software in the Sensor, press  (Setup Mode) - [Sensor settings] - [Update].
- 4** To update the software in the Touch Finder, press  (Setup Mode) - [TF settings] - [Update].

The software will be updated automatically.

Important

Do not turn OFF the power supply until updating the software has been completed.
The Sensor or Touch Finder may not start normally if power is turned OFF during the update.

10-5 LED Safety

For LED devices, class classification to indicate dangerous level and safety standards are stipulated in respective countries. Take necessary safety preventive measures according to the standards.

Warning Label

Warning labels are supplied as accessories with products that comply with the Class 2 Laser Product Classification. Attach them to appropriate positions near the Sensor where they can be easily noticed.

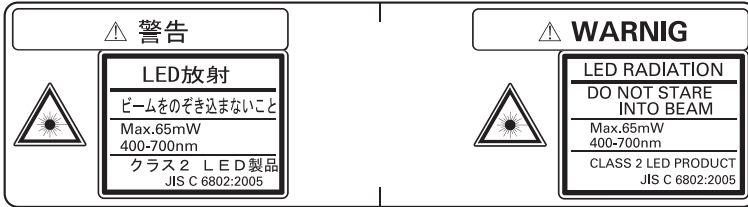

10-6 Requirements from Regulations and Standards

Summary of Requirements to Manufactures

For Europe

EN 60825-1 "Safety of Laser Products, Equipment Classification, Requirements and User's Guide"
Summary of Manufacturer's Requirements

Requirements subclause	Classification						
	Class 1	Class 1M	Class 2	Class 2M	Class 3R	Class 3B	Class 4
Description of hazard class	Safe under reasonably foreseeable conditions	As for Class 1 except may be hazardous if user employs optics	Low power; eye protection normally afforded by aversion responses	As for Class 2 except may be more hazardous if user employs optics	Direct intra-beam viewing may be hazardous	Direct intra-beam viewing normally hazardous	High power; diffuse reflections may be hazardous
Protective housing	Required for each laser product; limits access necessary for performance of functions of the products						
Safety interlock in protective housing	Designed to prevent removal of the panel until accessible emission values are below that for Class 3R				Designed to prevent removal of the panel until accessible emission values are below that for Class 3B		
Remote control	Not required					Permits easy addition of external interlock in laser installation	
Key control	Not required					Laser inoperative when key is removed	
Emission warning device	Not required				Give audible or visible warning when laser is switched on or if capacitor bank of pulsed laser is being charged. For Class 3R only, applies invisible radiation is emitted		
Attenuator	Not required					Give means beside the On/Off switch to temporarily block beam	
Location controls	Not required				Controls so located that there is no danger of exposure to AEL above Classes 1 or 2 when adjustments are made		
Viewing optics	Not required	Emission from all viewing systems must be below Class 1M AEL					
Scanning	Scan failure shall not cause product to exceed its classification						
Class label	Required wording		Figures A required wording				
Aperture label	Not required				Specified wording required		
Service entry label	Required as appropriate to the class of accessible radiation						
Override interlock label	Required under certain conditions as appropriate to the class of laser used						
Wavelength range label	Required for certain wavelength ranges						

Requirements subclause	Classification						
	Class 1	Class 1M	Class 2	Class 2M	Class 3R	Class 3B	Class 4
LED label	Make required word substitutions for LED products						
User information	Operation manuals must contain instructions for safe use. Additional requirement apply for Class 1M and Class 2M						
Purchasing and service information	Promotion brochures must specify product classification; service manuals must contain safety information						

- Note:** 1. This table is intended to provide a convenient summary of requirements. See text of this standard for complete requirements.
2. For the safety medical laser products, IEC 60601-2-22 applies.
3. AEL: Accessible Emission Limit
The maximum accessible emission level permitted within a particular class. For your reference, see ANSI Z136.1-1993, Section 2.

Symbol and border: black
Background: yellow



Figure A Warning label - Hazard symbol

Summary of Requirements to User

For Europe

EN 60825-1

Requirements subclause	Classification						
	Class 1	Class 1M	Class 2	Class 2M	Class 3R	Class 3B	Class 4
Laser safety officer	Not required but recommended for applications that involve direct viewing of the laser beam				Not required for visible emission Required for non-visible emission	Required	
Remote interlock	Not required					Connect to room or door circuits	
Key control	Not required					Remove key when not in use	
Beam attenuator	Not required					When in use prevents inadvertent exposure	
Emission indicator device	Not required				Indicates laser is energized for non-visible wavelengths	Indicates laser is energized	
Warning signs	Not required					Follow precautions on warning signs	
Beam path	Not required	Class 1M as for Class 3B (see note 2)	Not required	Class 2M as for Class 3B (see note 3)	Terminate beam at end of useful length		
Specular reflection	No requirements	Class 1M as for Class 3B (see note 2)	No requirements	Class 2M as for Class 3B (see note 3)	Prevent unintentional reflections		
Eye protection	No requirements				Not required for visible emission Required for non-visible emission	Required if engineering and administrative procedures not practicable and MPE exceeded	
Protective clothing	No requirements					Sometimes required	Specific requirements
Training	No requirements	Class 1M as for Class 3R (see note 2)	No requirements	Class 2M as for Class 3R (see note 3)	Required for all operator and maintenance personnel		

Note: 1. This table is intended to provide a convenient summary of requirements. See text of this standard for complete precautions.

2. Class 1M laser products that failed condition 1 of table 10 of the standard. Not required for Class 1M laser products that failed condition 2 of table 10 of the standard. See the text for details.

3. Class 2M laser products that failed condition 1 of table 10 of the standard. Not required for Class 2M laser products that failed condition 2 of table 10 of the standard. See the text for details.

Definitions of Laser Classification

For Europe

Laser Product Classifications

EN

Class	Description
Class 1	Laser that are safe under reasonably foreseeable conditions of operation, including the use of optical instruments for intrabeam viewing.
Class 1M	Laser emitting in the wavelength range from 302.5 nm to 4000 nm which are safe under reasonably foreseeable conditions of operation, but may be hazardous if the user employs optics within the beam.
Class 2	Laser that emit visible radiation in the wavelength range from 400 nm to 700 nm where eye protection is normally afforded by aversion responses, including the blink reflex. This reaction may be expected to provide adequate protection under reasonably foreseeable conditions of operation including the use of optical instruments for intrabeam viewing.
Class 2M	Laser that emit visible radiation in the wavelength range from 400 nm to 700 nm where eye protection is normally afforded by aversion responses, including the blink reflex. However, viewing of the output may be more hazardous if the user employs optics within the beam.
Class 3R	Laser that emit in the wavelength range from 302.5 nm to 10 ⁶ nm where direct intrabeam viewing is potentially hazardous but the risk is lower than for Class 3B lasers, and fewer manufacturing requirements and control measures for the user apply than for Class 3B lasers. The accessible emission limit is within five times the AEL of Class 2 in the wavelength range from 400 nm to 700 nm and within five times the AEL of Class 1 for other wavelengths.
Class 3B	Lasers that are normally hazardous when direct intrabeam exposure occurs (i.e. within the NOHD). Viewing diffuse reflections is normally safe (see also note).
Class 4	Lasers which are also capable of producing hazardous diffuse reflections. They may cause skin injuries and could also constitute a fire hazard. Their use requires extreme caution.

Note: Conditions for safe viewing of diffuse reflections for Class 3B visible lasers are: minimum viewing distance of 13 cm between screen and cornea and a maximum viewing time of 10 s. Other viewing conditions require a comparison of the diffuse reflection exposure with the MPE.

Index

A	
AC Adapter	197
AC power supply connector	
Touch Finder	22
adjusting parameters	
Adjustment mode in Run	101
adjustment during operation	101
all color images	70
all regions	97
angle range	54
area	68
auto connect	16
<hr/>	
B	
backing up data	117
backlight	108
Battery	31
specifications	193
battery level	124
binary images	70
brightness	38, 73, 108
BUSY output	112
BUSY polarity	136
BUSY: ON	136
READY: ON	136
BUSY signal	126
<hr/>	
C	
camera input	97
camera setup	37
capturing	121
changing line process	
using scenes	104
color	
setting	62, 70
color data	72
Color Dif.	73
color difference	73
Color ON/OFF	62
color palette	62, 70
configuration	50
connection	
automatic	16
console	56
correlation	52, 53
CSV	112
<hr/>	
D	
D. Area	69
D. Position	60
D. Width	65
data	
backup	117
saving	92, 117
saving to file	117
DC power supply connector	
Touch Finder	22
decimal symbol	112
<hr/>	
Definitions of Laser Classification	204
deleting log	114
deviation area	69
deviation position	60
display elements	17
display language	123
display patterns	97
All color image	70
Binary image	70
Measurement image	70
Selected color image	70
display settings	70
display types	
Graphics	96
Graphics + Details	96
Statistical data	96
displaying image data	122
<hr/>	
E	
ECO mode	108
edge level	61
edge position	59
edge width	64
error history	168, 169
deleting	169
viewing	169
ERROR signal	141
errors	
clearing	137
messages	169
Ethernet	33
Ethernet cable	196
connector	21
Ethernet port	
Touch Finder	22
exposure time	39
external trigger	127
<hr/>	
F	
field separator	112
file format	112
files	
logging	110
focus	37
adjustment screw	37
formatting SD cards	119
FQ Ethernet Cable	196
frozen images	106
<hr/>	
G	
GUI	
language	123
<hr/>	
H	
HDR function	39
hiding menus	108
high dynamic range	39
histograms	99
auto display	99

display range	
class	99
number of data	99
hue	73
<hr/>	
I	
I/O Cable	28
connector	21
I/O Cables	196
I/O monitor	109
image data	
logging	110
image input	
increasing speed	88
partial input	88
images	
displaying last NG image	107
displaying saved images	107
frozen	106
live	106
updating	107
zooming in	106
zooming out	106
zooming to fit display	106
individual judgements	132
initialize	123
initializing	
Sensor and Touch Finder	123
input mode	175
inputs	
IN0 to IN5	28
TRIG	28
inspection items	48
Area	68
color palette	70
teaching errors	71
Color Data	72
copying	51
deleting	51
Edge Position	59
color palette	62
teaching errors	63
Edge Width	64
teaching errors	66
renaming	51
Search	52
measurement region	57
teaching errors	58
searching	52
integrated Sensor lighting	123
IP address	34
<hr/>	
J	
judgements	
adjusting	89
all results/region	91
auto adjustment	89
individual	132
method	90
overall	131

<hr/>	
L	
language	123
LCD backlight	108
level output	135
lighting	123
control	123
live images	106
loading data from files	117
logging	110, 111
deleting log	114
recent results	113
selecting data to be logged	110
settings	110
starting and stopping	111
<hr/>	
M	
MAC address	178, 179
masking	56
measurement data	
logging	110
measurement images	70
measurement time	88
measurements	
continuous	129, 137
takt time	88
Memory State	124
menus	
hiding	108
models	52
re-registering	137
mounting	
control panel	25
DIN Track	25
Mounting Bracket	21
mutual interference	
preventing	46
<hr/>	
N	
noise level	61
NPN	29
<hr/>	
O	
one-shot output	135
operation	93
operation indicators	
BUSY	21
CHARGE	22
ERROR	21, 22
ETN	21
OR	21
POWER	22
SD ACCESS	22
Touch Finder	22
Vision Sensor	21
optical charts	23
OR signal	126
OR/NOT	56
output delay	135
output mode	135
output polarity	136
NG: ON	136
OK: ON	136

output time	135	Sensor information	124
outputs		Sensor monitor	96
BUSY	28	Sensor system data	
ERROR	28	saving	117
OR	28	Sensors	
OUT0	28	renaming	124
OUT1	28	single-function models	188
OUT2	28	specifications	188
overall judgements	131	standard models	188
<hr/>		switching	36
P		Set color	70
Panel Mounting Adapter	25, 195	Set color.	62
password	120	Setup Mode	17
PC Tool	20, 196	returning to Setup Mode	95
PNP	29	startup display	97
Polarizing Filter		startup mode	105
using	40	startup scene	105
position compensation	42, 97	startup settings	105
power supply switch		statistical data	
Touch Finder	22	logging	114
Preventing Mutual Interference of Multiple Sensors	46	straps	26
<hr/>		subnet mask	34
R		Summary of Requirements to Manufactures	
record separator	112		201
reference color		Summary of Requirements to User	203
re-registering	137	Switch Sensor	36
remaining Sensor	124	Switching Hub	20
re-measuring	86	system configuration	20
restart	123	<hr/>	
restarting		T	
Sensor and Touch Finder	123	test measurements	
Run Mode	17, 94	continuous test	86
<hr/>		performing	86
S		Test Tab Page	86
saturation	73	threshold	
saved images		average	90
displaying	107	maximum	90
saving data	92, 117	minimum	90
saving data to files	117	time	
saving image data	122	Touch Finder	123
scene data		Touch Finder	192
saving	117	information	124
scene group data		model with AC/DC/battery power supply	
saving	117	192	
scenes		model with DC power supply	192
changing	104	time settings	123
changing names	105	Touch Finder data	
copying	105	saving	117
deleting	105	trend monitor	98
switching	137	Auto display	98
SD card		Display range	98
available space	119	Number of data	98
formatting	119	TRIG signal	126
information	119	trigger delay	45, 46
operations	118	<hr/>	
slot	22	U	
searching		updating	
inspection items	52	software version	199
selected color images	70	<hr/>	
Sensor data		V	
saving all Sensor data	117	versions	124

W	
white balance	41
width amount	65
wiring	28
Sensor	28
Touch Finder	30

Z	
zooming	106

Version Upgrade Information

The following describes the content of the version upgrade.

Version 1.00 → Version 1.10

Changes	Reference
Functionality added to enable connecting multiple Sensors to one Touch Finder or PC Tool	p. 20, p.36
Functionality added to display all Sensors on the RUN mode display.	p.96
Functionality added to automatically change to the display for any Sensor with an NG result.	p.96

Version 1.10 → Version 1.20

Changes	Reference
Ethernet no-protocol communications has been added.	p. 142
Ethernet data output has been added.	p. 144
A function that makes a judgement based on the measurement results of multiple inspection items has been added.	p. 75
A brightness correction function has been added.	p. 38
A touch screen calibration function has been added.	p. 124

Revision History

A manual revision code appears as a suffix to the catalog number at the bottom of the front and back covers of this manual.

Cat. No. Z302-E1-03

↑
Revision code

Revision code	Date	Revised contents
01	July 2010	Original production
02	September 2010	Additions for version upgrade (version 1.10).
02A	October 2010	Minor corrections (p.20,95,99,100,119)
03	February 2011	Additions for version upgrade (version 1.20).

OMRON Corporation Industrial Automation Company

Tokyo, JAPAN

Contact: www.ia.omron.com

Regional Headquarters

OMRON EUROPE B.V.

Sensor Business Unit

Carl-Benz-Str. 4, D-71154 Nufringen, Germany
Tel: (49) 7032-811-0/Fax: (49) 7032-811-199

OMRON ELECTRONICS LLC

One Commerce Drive Schaumburg,
IL 60173-5302 U.S.A.

Tel: (1) 847-843-7900/Fax: (1) 847-843-7787

OMRON ASIA PACIFIC PTE. LTD.

No. 438A Alexandra Road # 05-05/08 (Lobby 2),
Alexandra Technopark,
Singapore 119967
Tel: (65) 6835-3011/Fax: (65) 6835-2711

OMRON (CHINA) CO., LTD.

Room 2211, Bank of China Tower,
200 Yin Cheng Zhong Road,
PuDong New Area, Shanghai, 200120, China
Tel: (86) 21-5037-2222/Fax: (86) 21-5037-2200

Authorized Distributor:

© OMRON Corporation 2010 All Rights Reserved.
In the interest of product improvement,
specifications are subject to change without notice.

Printed in Japan

Cat. No. Z302-E1-03

0211