

Cat. No. Z173-E1-02A

F160-2

Vision Sensor

**Manual 3:
EXPERT MENU
OPERATION MANUAL**

OMRON

READ AND UNDERSTAND THIS DOCUMENT

Please read and understand this document before using the products. Please consult your OMRON representative if you have any questions or comments.

WARRANTY

OMRON's exclusive warranty is that the products are free from defects in materials and workmanship for a period of one year (or other period if specified) from date of sale by OMRON.

OMRON MAKES NO WARRANTY OR REPRESENTATION, EXPRESS OR IMPLIED, REGARDING NON-INFRINGEMENT, MERCHANTABILITY, OR FITNESS FOR PARTICULAR PURPOSE OF THE PRODUCTS. ANY BUYER OR USER ACKNOWLEDGES THAT THE BUYER OR USER ALONE HAS DETERMINED THAT THE PRODUCTS WILL SUITABLY MEET THE REQUIREMENTS OF THEIR INTENDED USE. OMRON DISCLAIMS ALL OTHER WARRANTIES, EXPRESS OR IMPLIED.

LIMITATIONS OF LIABILITY

OMRON SHALL NOT BE RESPONSIBLE FOR SPECIAL, INDIRECT, OR CONSEQUENTIAL DAMAGES, LOSS OF PROFITS OR COMMERCIAL LOSS IN ANY WAY CONNECTED WITH THE PRODUCTS, WHETHER SUCH CLAIM IS BASED ON CONTRACT, WARRANTY, NEGLIGENCE, OR STRICT LIABILITY.

In no event shall responsibility of OMRON for any act exceed the individual price of the product on which liability is asserted.

IN NO EVENT SHALL OMRON BE RESPONSIBLE FOR WARRANTY, REPAIR, OR OTHER CLAIMS REGARDING THE PRODUCTS UNLESS OMRON'S ANALYSIS CONFIRMS THAT THE PRODUCTS WERE PROPERLY HANDLED, STORED, INSTALLED, AND MAINTAINED AND NOT SUBJECT TO CONTAMINATION, ABUSE, MISUSE, OR INAPPROPRIATE MODIFICATION OR REPAIR.

SUITABILITY FOR USE

THE PRODUCTS CONTAINED IN THIS DOCUMENT ARE NOT SAFETY RATED. THEY ARE NOT DESIGNED OR RATED FOR ENSURING SAFETY OF PERSONS, AND SHOULD NOT BE RELIED UPON AS A SAFETY COMPONENT OR PROTECTIVE DEVICE FOR SUCH PURPOSES. Please refer to separate catalogs for OMRON's safety rated products.

OMRON shall not be responsible for conformity with any standards, codes, or regulations that apply to the combination of products in the customer's application or use of the product.

At the customer's request, OMRON will provide applicable third party certification documents identifying ratings and limitations of use that apply to the products. This information by itself is not sufficient for a complete determination of the suitability of the products in combination with the end product, machine, system, or other application or use.

The following are some examples of applications for which particular attention must be given. This is not intended to be an exhaustive list of all possible uses of the products, nor is it intended to imply that the uses listed may be suitable for the products:

- Outdoor use, uses involving potential chemical contamination or electrical interference, or conditions or uses not described in this document.

- Nuclear energy control systems, combustion systems, railroad systems, aviation systems, medical equipment, amusement machines, vehicles, safety equipment, and installations subject to separate industry or government regulations.
- Systems, machines, and equipment that could present a risk to life or property.

Please know and observe all prohibitions of use applicable to the products.

NEVER USE THE PRODUCTS FOR AN APPLICATION INVOLVING SERIOUS RISK TO LIFE OR PROPERTY WITHOUT ENSURING THAT THE SYSTEM AS A WHOLE HAS BEEN DESIGNED TO ADDRESS THE RISKS, AND THAT THE OMRON PRODUCT IS PROPERLY RATED AND INSTALLED FOR THE INTENDED USE WITHIN THE OVERALL EQUIPMENT OR SYSTEM.

PERFORMANCE DATA

Performance data given in this document is provided as a guide for the user in determining suitability and does not constitute a warranty. It may represent the result of OMRON's test conditions, and the users must correlate it to actual application requirements. Actual performance is subject to the OMRON Warranty and Limitations of Liability.

CHANGE IN SPECIFICATIONS

Product specifications and accessories may be changed at any time based on improvements and other reasons.

It is our practice to change model numbers when published ratings or features are changed, or when significant construction changes are made. However, some specifications of the product may be changed without any notice. When in doubt, special model numbers may be assigned to fix or establish key specifications for your application on your request. Please consult with your OMRON representative at any time to confirm actual specifications of purchased products.

DIMENSIONS AND WEIGHTS

Dimensions and weights are nominal and are not to be used for manufacturing purposes, even when tolerances are shown.

ERRORS AND OMISSIONS

The information in this document has been carefully checked and is believed to be accurate; however, no responsibility is assumed for clerical, typographical, or proofreading errors, or omissions.

PROGRAMMABLE PRODUCTS

OMRON shall not be responsible for the user's programming of a programmable product, or any consequence thereof.

COPYRIGHT AND COPY PERMISSION

This document shall not be copied for sales or promotions without permission.

This document is protected by copyright and is intended solely for use in conjunction with the product. Please notify us before copying or reproducing this document in any manner, for any other purpose. If copying or transmitting this document to another, please copy or transmit it in its entirety.

F160-2 Vision Sensor

Manual 3: Expert Menu Operation Manual

Revised June 2006

Notice:

OMRON products are manufactured for use according to proper procedures by a qualified operator and only for the purposes described in this manual.

The following conventions are used to indicate and classify precautions in this manual. Always heed the information provided with them. Failure to heed precautions can result in injury to people or damage to property.

 **DANGER** Indicates an imminently hazardous situation which, if not avoided, will result in death or serious injury.

 **WARNING** Indicates a potentially hazardous situation which, if not avoided, could result in death or serious injury.

 **Caution** Indicates a potentially hazardous situation which, if not avoided, may result in minor or moderate injury, or property damage.

OMRON Product References

All OMRON products are capitalized in this manual. The word “Unit” is also capitalized when it refers to an OMRON product, regardless of whether or not it appears in the proper name of the product.

Visual Aids

The following headings appear in the left column of the manual to help you locate different types of information.

Note Indicates information of particular interest for efficient and convenient operation of the product.

1,2,3... 1. Indicates lists of one sort or another, such as procedures, checklists, etc.

Precaution Indicates information required to take full advantage of the functions and performance of the product. Incorrect application methods may result in the loss of damage or damage to the product. Read and follow all precautionary information.

CHECK Indicates points that are important in using product functions or in application procedures.

TwoCamera Indicates information required when using a 2-camera system.

SeeAlso Indicates where to find related information.

HELP Indicates information helpful in operation, such as the definition of terms.

© OMRON, 2003

All rights reserved. No part of this publication may be reproduced, stored in a retrieval system, or transmitted, in any form, or by any means, mechanical, electronic, photocopying, recording, or otherwise, without the prior written permission of OMRON.

No patent liability is assumed with respect to the use of the information contained herein. Moreover, because OMRON is constantly striving to improve its high-quality products, the information contained in this manual is subject to change without notice. Every precaution has been taken in the preparation of this manual. Nevertheless, OMRON assumes no responsibility for errors or omissions. Neither is any liability assumed for damages resulting from the use of the information contained in this publication.

TABLE OF CONTENTS

SECTION 1

Expert Menu Features	1
1-1 Special Features of the Expert Menu	2
1-2 Types and Features of Measurement Methods	4
1-3 Compatibility with Conversational Menu	14
1-4 Operational Flow	15
1-5 Menus	16

SECTION 2

Basic Operations	21
2-1 Starting the F160 and Displaying Images	22
2-2 Menu Operations	24
2-3 Two-camera Unit	32
2-4 Setting Inspection Conditions	34
2-5 Run Mode	63
2-6 Saving Settings and Exiting the F160	65

SECTION 3

Selecting and Setting Measurement Methods	67
3-1 Area (Variable Box)	70
3-2 Defect (Variable Box)	82
3-3 Gravity and Axis	92
3-4 OCR for 1 Character	100
3-5 Classification	104
3-6 Surface Defects	114
3-7 Density Data	119
3-8 Edge Pitch	123
3-9 Edge Position	128
3-10 Edge Width	137
3-11 Gray Search and Precise Search	147
3-12 Flexible Search	155
3-13 Labeling	163
3-14 Relative Search	172
3-15 Rotation Search	180

SECTION 4

Detailed Setting Operations	191
4-1 Calibration	193
4-2 Position Displacement Compensation	205
4-3 Details on Expressions	219

TABLE OF CONTENTS

4-4	Display Details.	233
4-5	Display Strings.	235
4-6	Displaying Measurements	238
4-7	Displaying Judgements	241
4-8	Displaying Measurement Region Names	245
4-9	Displaying Measurement Time	246
4-10	Displaying Fixed Figures.	248
4-11	Displaying Results (Lines, Boxes, Circles, and Cursors)	250
4-12	Editing Measurement Regions and Position Compensation Regions	253

SECTION 5

Other Functions 259

5-1	Changing Scenes and Scene Groups	260
5-2	Backing Up Data	266
5-3	Checking Image Density Distribution: Line Brightness	276
5-4	Checking I/O Status with External Devices	278
5-5	Memory Card Operations	281

SECTION 6

System Settings 291

6-1	Entering System Mode	292
6-2	Camera Settings.	293
6-3	Measurement Result Output Destinations	294
6-4	Screen Display and Monitor	298
6-5	Customizing Operations	309
6-6	Setting Conditions for Saving Measurement Images	318
6-7	Using BUSY Signals	322
6-8	Selecting Items to be Shown in Overall Judgements.	323
6-9	Setting Startup Conditions.	324
6-10	Setting the Calendar Date and Time (Date/Time)	325
6-11	Checking System Information.	325
6-12	Changing to Conversational Menus.	327

SECTION 7

Appendix 329

7-1	Terminology.	330
7-2	Character Codes.	331
7-3	Troubleshooting.	332
7-4	FAQ.	336

TABLE OF CONTENTS

Index.....	337
Revision History	345

About this Manual:

This manual describes setup procedures for the F160 Vision Sensor and it includes the sections described below.

This is one of four manuals used to operate the F160. Refer to the following table for the contents of each manual.

Manual	Contents	Cat. No.
1: Setup Manual	Provides information on system hardware and installation. Be sure to read this manual first.	Z170
2: Conversational Menu Operation Manual	Describes operation of the F160 using the Conversational Menus. The Conversational Menus enable the simplest operation based on registered images of acceptable and unacceptable products.	Z171
3: Expert Menu Operation Manual	Describes operation of the F160 using the Expert Menus. The Expert Menu enable application of all F160 capabilities, including setting region images and criteria.	Z173
4: Communications Reference Manual	Describes the communications settings and communications protocol used to transfer data through the parallel interface or serial interface.	Z172

Please read the above manuals carefully and be sure you understand the information provided before attempting to install or operate the F160.

Section 1 Expert Menu Features explains the features of the Expert Menu mode and its compatibility with the Conversational Menu mode.

Section 2 Basic Operations describes the basic operations of the Expert Menus.

Section 3 Selecting and Setting Measurement Methods explains the measurement methods provided by the Expert Menu (except for the gravity and area measurement method, which is explained in *Section 2*).

Section 4 Detailed Setting Operations explains in more detail the basic setting operations for the Expert Menus that were explained in *Section 2*.

Section 5 Other Functions describes additional functions such as changing the measurement setup or backing up data.

Section 6 System Settings describes how to set conditions related to the system environment.

Section 7 Appendix provides information on terminology, character codes, troubleshooting, and answers to FAQs.

 **WARNING** Failure to read and understand the information provided in this manual may result in personal injury or death, damage to the product, or product failure. Please read each section in its entirety and be sure you understand the information provided in the section and related sections before attempting any of the procedures or operations given.

SECTION 1

Expert Menu Features

This section explains the features of the Expert Menu mode and its compatibility with the Conversational Menu mode.

1-1	Special Features of the Expert Menu	2
1-2	Types and Features of Measurement Methods	4
1-2-1	Measurement Methods	4
1-2-2	Features of Measurement Methods	6
1-3	Compatibility with Conversational Menu	14
1-4	Operational Flow	15
1-5	Menus	16
1-5-1	Menus for One Camera	16
1-5-2	Menus for Two Cameras	19

1-1 Special Features of the Expert Menu

Seventeen Measurement Methods for Various Detection Needs

Select the measurement method according to application.

Complicated detection is also possible, by combining multiple measurement methods and with detailed settings.

- Area (var. box)
- Defect (var. box)
- Gravity and area (See note.)
- Gravity and axis (See note.)
- OCR for 1 chara
- Classification
- Defect
- Density data
- Edge pitch
- Edge position (See note.)
- Edge width
- Gray search (See note.)
- Precise search
- Flexible search
- Labeling (See note.)
- Relative search
- Rotation search (See note.)

Note Position displacement compensation is also supported for these measurement methods.

Two-camera Operation

If two Cameras are connected, detection can be performed from two directions and the field of vision can be split in two.

SeeAlso Refer to page 32.

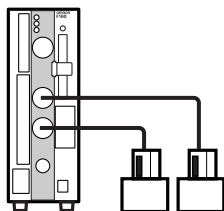

Smooth Setup Changes

Scenes can be used to change between up to 32 types of measurement set-ups. Simply change the scene to change to a different measurement setup. A 128-MB Memory Card can be used to store up to 1,024 scenes.

SeeAlso Refer to page 260.

Flexible Settings for Data Output to External Devices

In addition to simply outputting measurement results, expressions or arithmetic functions can be set to output special data, such as the distance between two regions or the maximum measurement value.

SeeAlso Refer to page 219.

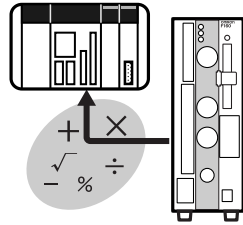

Up to 35 Screens of NG Measurement Object Images

Past defects can be checked on screen.

Saved images are cleared when the power is turned OFF.

Images can be saved as bitmaps, which are useful when creating reports or operating procedures.

SeeAlso Refer to page 318.

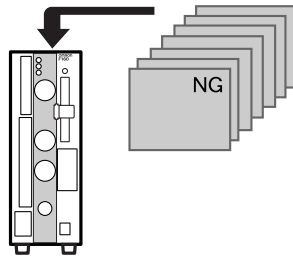

Customizing

Customize Screens

SeeAlso Refer to page 233.

- Messages displayed on screen can be changed for easier comprehension of the measurement and its purpose.

Scene names can be changed according to the measurement details (See note.).

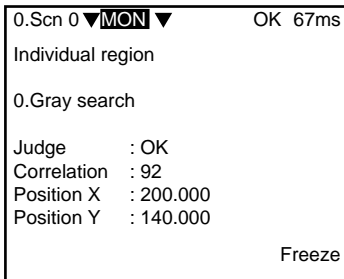

Customize

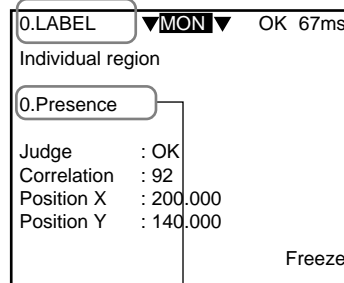

Measurement region names can be changed to suit the measurement. (See note.)

- The display method for the measurement results can also be changed as required.

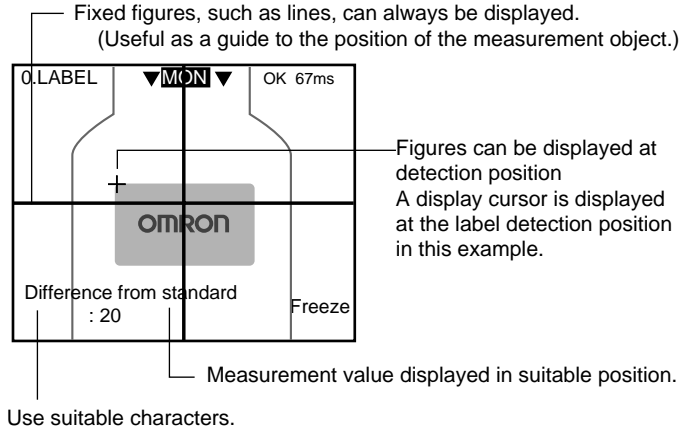

Customize Operations

SeeAlso Refer to page 309.

- Access can be limited by using a password to prevent incorrect operation.
- Frequently-used operations can be allocated to the Console Keys, allowing faster, one-touch operation.

1-2 Types and Features of Measurement Methods









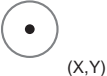

Various measurement methods can be selected according to the application and measurement details. The possible applications for some measurement methods is much wider depending on the way the method is used. In this section, however, only the most typical applications are described.

1-2-1 Measurement Methods

The Expert Menu has 17 types of measurement.

- Area (variable box)
- Defect (variable box)
- Gravity and area
- Gravity and axis
- OCR for 1 character
- Classification
- Defect
- Density data
- Edge pitch
- Edge position
- Edge width
- Gray search
- Precise search
- Flexible search
- Labeling
- Relative search
- Rotation search

Guide to Selecting Measurement Methods

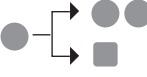
Measurement target		Example measurement methods	Typical application examples
Size (area) 		Gravity and area Area (var. box)	Detect presence (expiration dates, parts, etc.) Detect adhesive coatings. Detect caulking of metal parts.
Position	Center of gravity coordinates (Processing time: Short) 	Gravity and area	Robot handling. Position PCBs.
	Any particular coordinates (Processing time: Long) 	Gray search Precise search Flexible search	Robot handling. Position PCBs.
	Dimensions 	Edge position Edge width	Detect dimensions of molded products (e.g., width of tiles or paper, length of bolts, internal diameter of PCB holes.)
	Position displacement 	Relative search	Detect position displacement (printing, labels, etc.) Fluid volume checks. Detect insufficient tightening of caps.
Shape (correlation) 		Gray search Precise search Flexible search	Detect foreign items in packages. Discriminate between directions (parts, marks, etc.)
Angle 		Gravity and axis Rotation search	Detect rotary switch position (angle).
Number 		Edge pitch Labeling	Detect number of pins (IC, connectors, etc.) Detect detached wiring cables. Detect number of gears.
Defect 		Defect Defect (var. box)	Detect marks on sheeting. Detect defects and burrs on molded products. Check pinholes. Detect impurities in fluids. Examine exterior of chip parts.
Brightness 		Density data	Detect foreign objects. Detect presence.
Characters 		OCR for 1 character	Read lot number.
Classification 		Classification	Discriminate between grades, e.g., on fruit boxes.

1-2-2 Features of Measurement Methods

Area (Var. Box)

Use an area (variable box) measurement to adjust the measurement region (a box) for measurement objects with varying sizes or positions and find their size and center of gravity.

The upper, lower, left, and right edges of the measurement object are found.

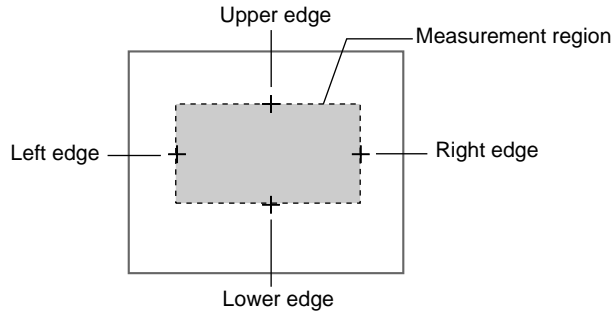

With the edges detected, the F160 can determine where the measurement object is. Even if the size and position of the measurement object changes, the F160 can move the measurement region appropriately.

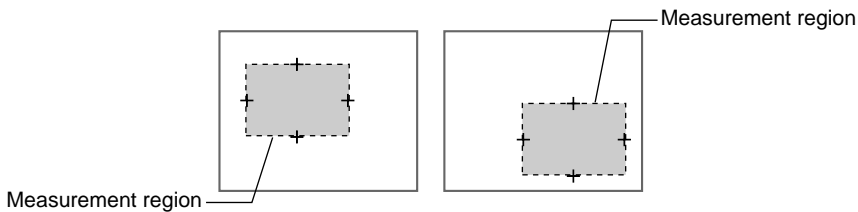

Once the edges have been found, the image is converted to a binary image and the area and center of gravity of the measurement region are found.

SeeAlso Refer to page 7 for information on *Gravity and Area*.

Defect (Var. Box)

Use a defect (variable box) measurement to adjust the measurement region (a box) for measurement objects with varying sizes or positions and find defects.

The edges are found in the same way as for *Area (var. box)* and the measurement region is moved as required.

Once the edges have been found, the defects inside the measurement region are detected.

SeeAlso Refer to page 9 for information on *Defect*.

Gravity and Area

Use a gravity and area measurement to find the size and position (center of gravity) of a measurement object.

The image read by the Camera is a 256-gradation image. This is converted to a binary image made up of black and white pixels. The F160 focusses on the white areas only and performs measurement.

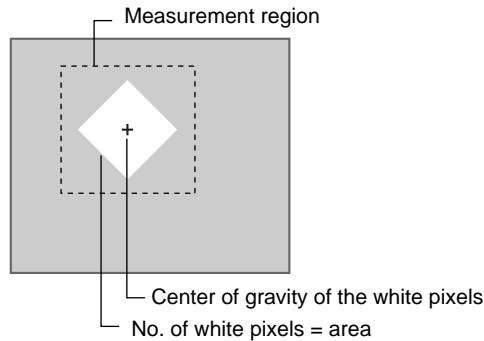
**Area**

The area is the number of white pixels in the measurement region.

Center of Gravity

The center of gravity is the center of the area of white pixel. When the white pixel area of the region forms a square, the center of gravity is the intersection of the lines from diagonal corners.

HELP Refer to page 330 for information on the center of gravity.

CHECK When a gravity and area measurement is used, an object will receive an OK judgement if the number of white pixels is the same as the OK setting, even if the shape is different. To distinguish shapes, use a gray search, precise search, or flexible search.

CHECK Use an area (var. box) measurement for measurement objects with varying measurement region sizes or positions.

Gravity and Axis

Use a gravity and axis measurement to find the angle of a measurement object.

This measurement method also calculates the axis angle, in addition to the binary center of gravity and area calculations described previously.

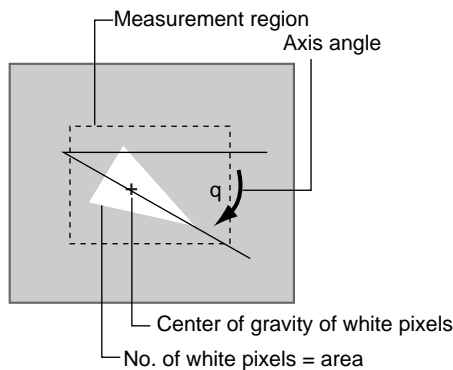
**Axis Angle**

The axis angle is the angle of the major axis of an ellipse that is diagrammatically equivalent to the area occupied by the white pixels.

CHECK More processing time is required to calculate the axis angle. To simply find the area and center of gravity, use a gravity and area measurement.

OCR for 1 Character

Use an OCR for 1 character measurement to recognize alphanumeric characters and special symbols. The F160 provides a dictionary, so no models need to be registered.

The F160 recognizes two candidates, 1st candidate and 2nd candidate, from the dictionary, that are most similar to the character image in the measurement region.

If the density deviation is not greater than the set value, the image is recognized as having no pattern (no detectable marks).

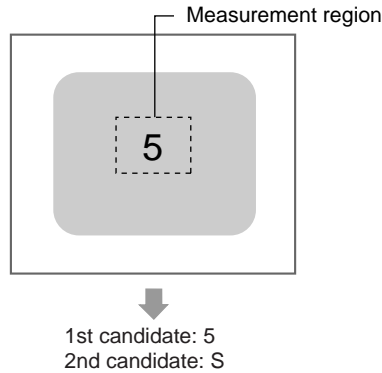

CHECK

An expression can be set to output the character code of the recognized character to an external device. The output when no pattern is detected is the underscore (_) character code.

Classification

Use a classification measurement to classify products, for example, on a line for a variety of products.

A model is registered beforehand that will serve as the classification reference. Up to 36 types of models can be registered to index numbers 0 to 35.

When the printing quality or shape of the model is inconsistent, register multiple models to the same index number. Up to 5 models can be registered to the same index number.

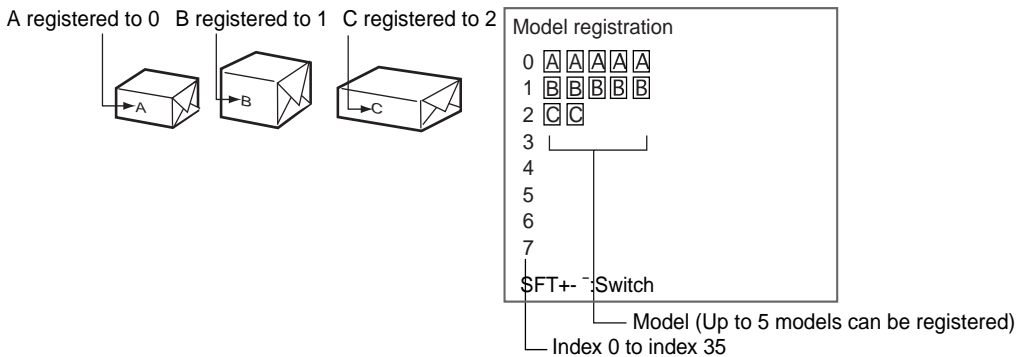

CHECK

When multiple models are registered to the same index number, the F160 automatically creates auxiliary models between the models that are registered. If the auxiliary models are added to the registered models when searches are performed, stable searches are possible even if there are variations between the registered models. You can select whether or not to use auxiliary models in searches. Refer to page 331 for information on auxiliary models.

The F160 outputs the number of the index for the model that most resembles the image. If there is no model that resembles the image, NG is output. Once that data has been received by the external device, the product can be classified at the next processing stage.

Searches for the model with the highest correlation.

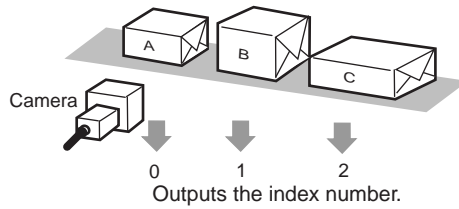

CHECK Expressions must be set to output data to an external device.

Defect

Use a defect measurement to detect defects in unpatterned measurement objects.

This method checks for surface defects by measuring variations in density. The shape of the measurement region can be chosen from arc, box, circumference, or line.

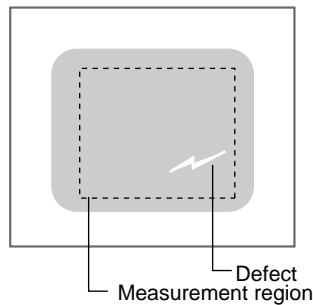

CHECK The measurement object cannot be measured correctly if there is a pattern or marks on the object. This method uses variations in density, so if there is a pattern or marks within the measurement region it will be detected as a defect. To measure areas with patterns or marks, use a gray search, precise search, or flexible search. Refer to page 11.

CHECK Use a defect (variable box) measurement for measurement objects with varying measurement region sizes or positions.

Density Data

Use a density data measurement to detect the presence of a measurement object.

Example: Detecting the Presence of Electronic Parts

Set two measurement regions, one for the part location and one for the background. The density average of each is measured and the difference is used to check if the part is present. If the part is present, the density difference with the background will be large. If the part is not present, the density difference will be small.

The difference in density is compared, so there will be little influence on the measurement if the overall image is dark due to deteriorated lighting.

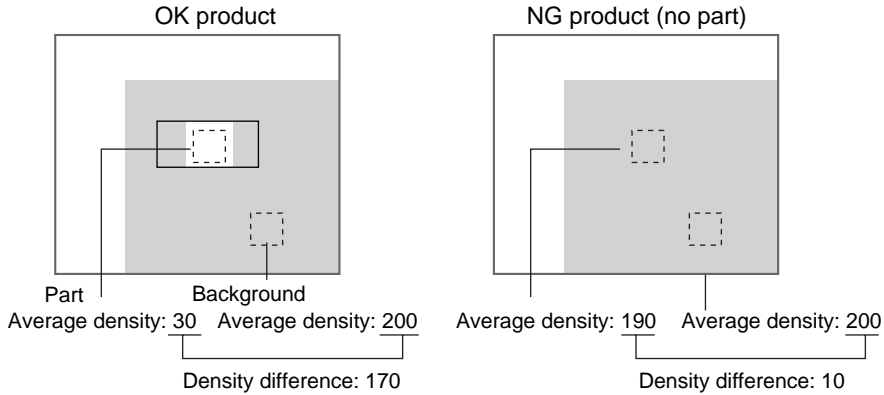

CHECK Use expressions to set the judgement conditions for density difference and OK (part present)/NG (part missing).

Edge Pitch

Use an edge pitch measurement to find the number of edges (number of connector pins, etc.) in a measurement object.

In addition to finding the number of edges, this method can be used to find the pitch and width.

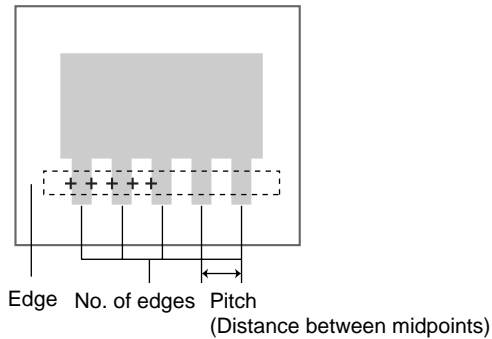

CHECK To find only the width of the measurement object, use an edge width measurement.

Edge Position

Use an edge position measurement to find the coordinates of the edge of the measurement object.

The edge is found by density changes within the measurement region. Set the search direction and color changes for each region.

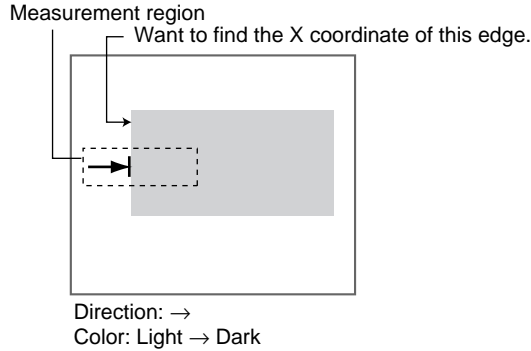

Edge Width

Use an edge width measurement to find the width of the measurement object. This method finds two edges in one measurement region and calculates the width.

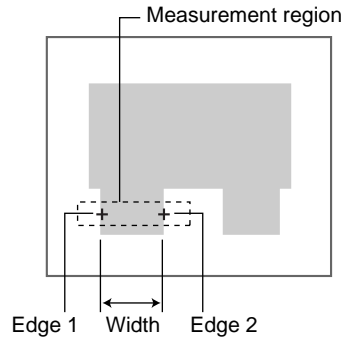

Gray Search, Precise Search, and Flexible Search

Use these measurement methods to distinguish between shapes of measurement objects or to find the position (search coordinates) of a measurement object.

Register a reference image pattern as the model.

When a model is registered, the center position of the model is registered as the search coordinates. (These search coordinates can be changed.)

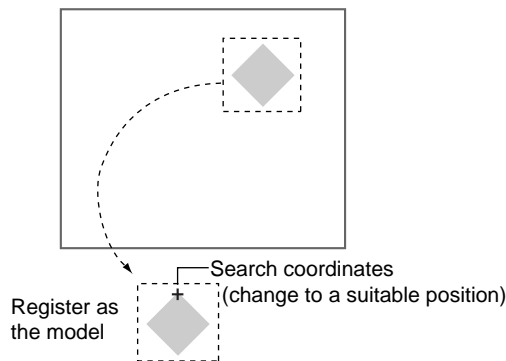

The part of an input image that is most similar to the model is found, the degree of similarity is expressed with a correlation value, and the search coordinates (X, Y) are found.

Correlation : 95
Search coordinates: (180, 291)

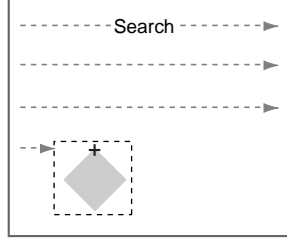

Correlation : 52
Search coordinates: (260, 143)

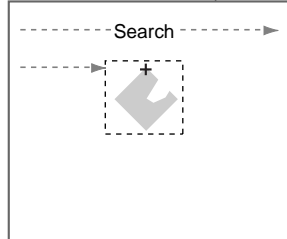

HELP Refer to page 330 for information on density images.

HELP Refer to page 331 for information on models.

HELP Refer to page 330 for information on correlations.

With a precise search, the position is obtained in sub-pixel units. The position accuracy is higher but the processing time is longer than that for a gray search measurement.

Use a flexible search, where multiple models can be registered, for measurement objects with inconsistent shapes that give unstable measurements.

Labeling

Use a labeling measurement to count how many labels there are in a measurement region and to find the area and center of gravity of a specified label.

HELP Labels are areas of white pixels in a binary image.

HELP Labeling is the process where a different number is given to each extracted label.

Images read by the Camera are converted to binary images and the white pixels are extracted as labels. (Any value can be set to the judgement values to determine what area of white pixels becomes a label.)

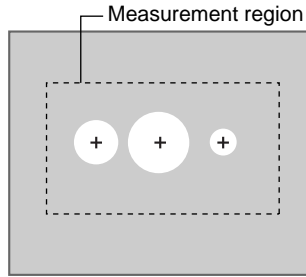

Labels are extracted and the area and gravity coordinates found.

The extracted labels are sorted by area or center of gravity, and numbers are allocated to each label.

Example: Sort by area in descending order

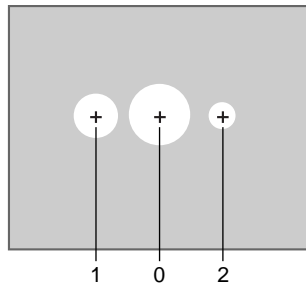

Relative Search

Use a relative search measurement to find the position of marks, holes, or other features in relation to the reference position.

Register two image patterns as models, one for the reference position and one for the measurement position. The part of an input image that is most similar to the model is found, and the correlation with the model, and the relative position and distance between the 2 output points is obtained.

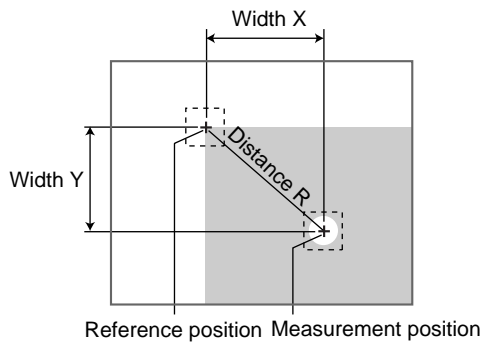

Rotation Search

Use a rotation search measurement to find the angle and position of a measurement object.

Register a model that will serve as the reference image pattern. When a model is registered, the registered status of the measurement object becomes 0° and

the center position of the model becomes the search coordinates. (The search coordinates can be changed.)

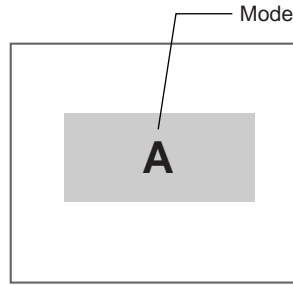

The angle of the measurement object is found in relation to the reference image (model) for the input image.

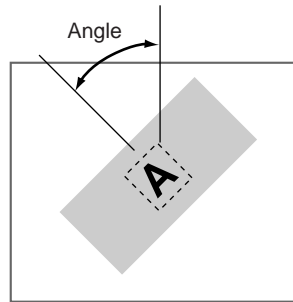

1-3 Compatibility with Conversational Menu

Scene Data (Detection Conditions)

The detection conditions set in Conversational Menu mode can be used in Expert Menu mode to make detailed adjustments. Once the conditions have been adjusted with the Expert Menu, you can return to the Conversational Menu mode and perform measurements using these adjusted conditions.

Region conditions that have been changed or added in the Expert Menu mode cannot be readjusted using the Conversational Menu mode.

Scene data



Set the detection conditions. Add or adjust the conditions. Execute measurements.

Execute measurement.

Register new regions to the scenes added or changed using the Expert Menu.

You cannot change the scene regions added or changed using the Expert Menu.

System Data

The data set using the Conversational Menu mode is used as is.



Only those items that are part of the Conversational Menu system data can be used.
(Other data returns to the default settings.)

1-4 Operational Flow

Turn ON the power.

Preparations for Detection

Starting the Expert Menus. Refer to page 22. See *Starting the F160 and Displaying Images*.

SeeAlso

Refer to page 34 for information on setting detection conditions. Refer to this section to learn about the basic operational flow from setting detection conditions to executing measurements.

Setting Detection Conditions

1. Enter Set Mode. Refer to page 34. See *2-4-1 STEP 1: Entering Set Mode*.
2. Adjust the Camera image. Refer to page 38. See *2-4-2 STEP 2: Adjusting Images*.
3. Set position displacement compensation if necessary. Refer to page 47. See *2-4-3 STEP 3: Position Compensation*. See page 205 for details on position compensation.
4. Select and set the measurement method (Gravity and area). Refer to page 48. See *2-4-4 STEP 4: Measurement Region*.

Select the measurement method appropriate to the measurement goal. Refer to page 67. See *SECTION 3 Selecting and Setting Measurement Methods*.

Area (var. box), page 70

Defect (var. box), page 82

Gravity and axis, page 92

OCR for 1 character, page 100

Classification, page 104

Defect, page 114

Density data, page 119

Edge pitch, page 123

Edge position, page 128

Edge width, page 137

Gray search, page 147

Precise search, page 147

Flexible search, page 155

Labeling, page 163

Relative search, page 172

Rotation search, page 180

5. Setting output details if necessary. Refer to page 59. See *2-4-5 STEP 5: Output Expressions* See page 219 for details on output expressions.
6. Changing the screen for measurement if necessary. Refer to page 60. See *2-4-6 STEP 6: Display*. See page 233 for details on display.

Confirming Settings and Executing

Perform tests and start measurements. Refer to page 60. See *2-4-7 STEP 7: Monitor Mode and Run Mode*.

Troubleshooting

HELP When an error message has been displayed on the screen, refer to page 332 *Troubleshooting*.

HELP If you have a question, refer to page 336 *FAQ*.

HELP If you don't understand a term, refer to page 330 *Terminology*.

Changing and Deleting Settings

Copy, clear, and change names of measurement methods. Refer to page 235. See *Editing Measurement Regions and Position Compensation Regions*.

Saving Settings

1. Save detection conditions. Refer to page 65. See *Saving Settings and Exiting the F160*.
2. Back up image, system, and scene data. Refer to page 266 for information on how to back up settings.

Application Setting Operations

1. Set conditions by model type. Refer to page 260. See *Changing Scenes and Scene Groups* for information on scene and scene-group functions.
2. Set system environment conditions. Refer to page 291. See *System Settings*.
3. Initialize the set detection conditions. Refer to page 260. See *Changing Scenes and Scene Groups* for information on scene and scene group functions.
4. Set communications specifications and I/O format for communications with external devices. Refer to the *Communications Reference Manual*.

Additional Functions

1. Use Memory Cards if required. Refer to page 281. See *Memory Card Operations*.
2. Check communications status with external devices if required. Refer to page 278. See *Checking I/O Status with External Devices (I/O Monitor)*.

1-5 Menus

1-5-1 Menus for One Camera

The structure of the menus is shown on the following pages.

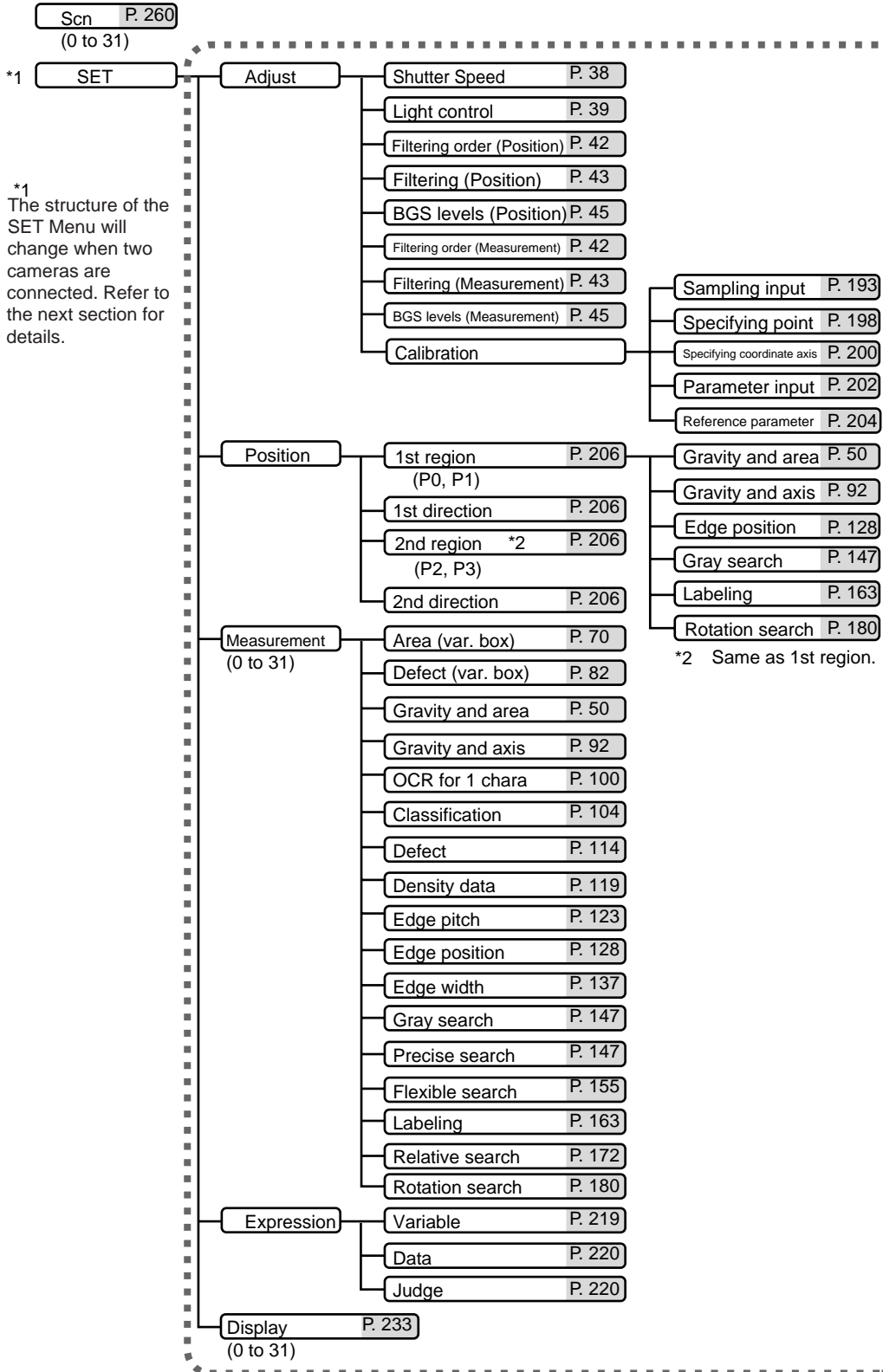

*1
The structure of the SET Menu will change when two cameras are connected. Refer to the next section for details.

MON P. 60

RUN P. 63

SYS

Camera settings P. 293

Communications

Serial

Normal

Host Link

Parallel

Refer to Communications Reference Manual.

Output

Output device P. 294

Serial P. 295

Memory card P. 296

Display

Display settings P. 298

Monitor P. 305

Designate colors P. 306

Make colors P. 307

Operation settings

Set key operation P. 309

Measurement control P. 318

Display capture P. 312

Switch menu P. 327

Setting menu masking P. 314

Startup mode P. 324

Processing item masking P. 315

Date/Time P. 325

Save at switch Scn Group P. 315

Password P. 316

System information

Memory capacity P. 325

Version P. 326

TOOL

System data

Load (Serial) P. 269

Save (Serial) P. 267

Load (Memory card) P. 274

Save (Memory card) P. 272

Scn Group data P. 266 (Same as System Data.)

Scene data P. 266 (Same as System Data.)

System + Scn Group data P. 266 (Same as System Data.)

Image data P. 266 (Same as System Data.)

Memory card

Copy file P. 284

Clear image P. 321

File operation P. 281

Line brightness P. 276

Drive status P. 288

I/O monitor

Serial P. 278

Parallel P. 280

SAVE P. 65

1-5-2 Menus for Two Cameras

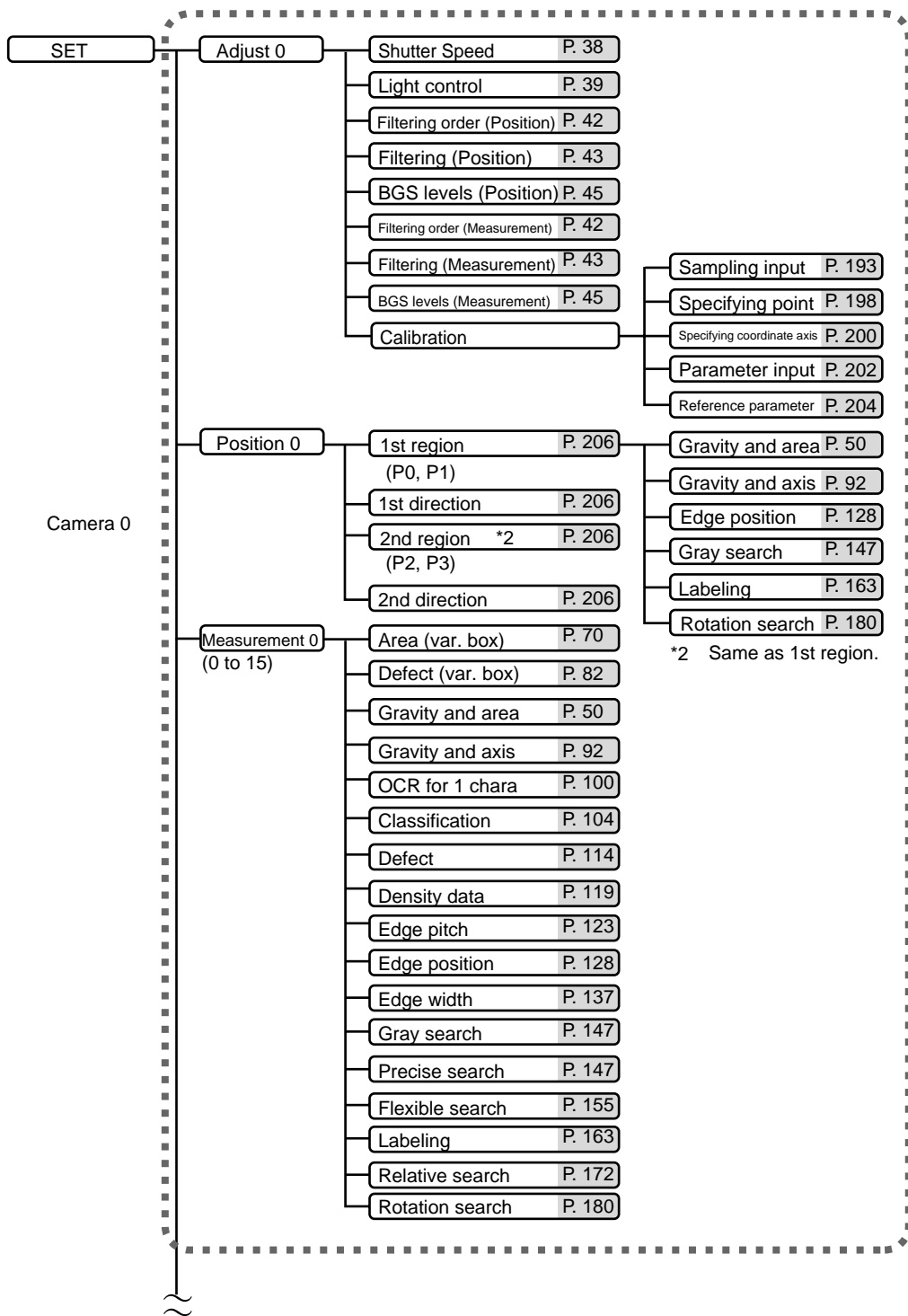

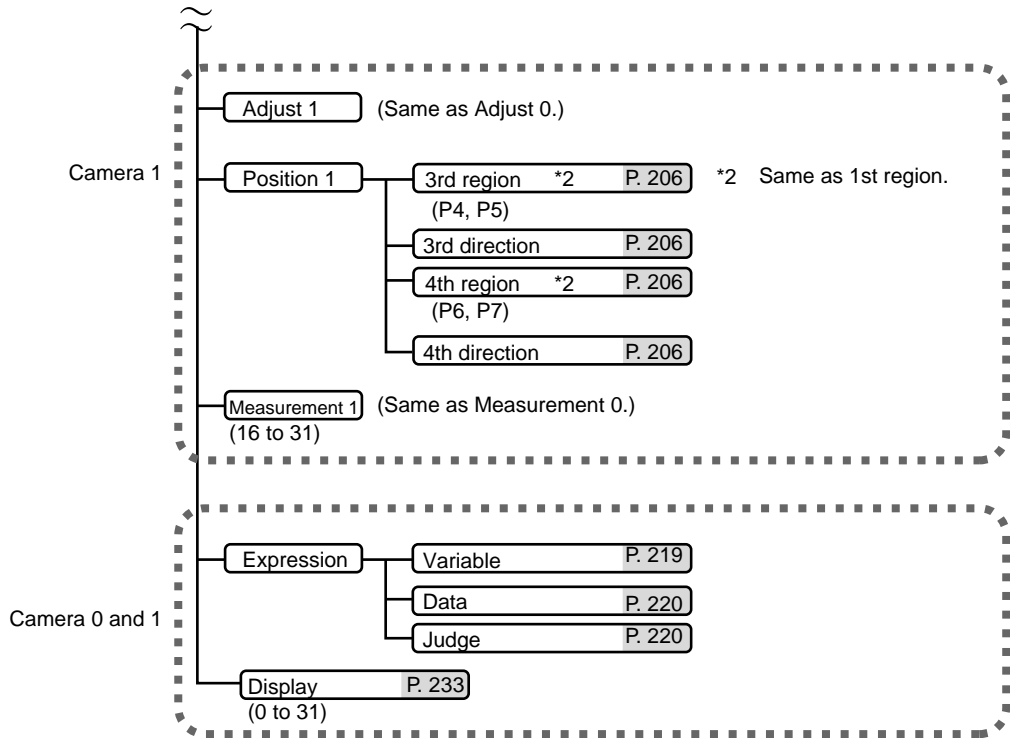

SECTION 2

Basic Operations

This section describes the basic operations of the Expert Menus.

2-1	Starting the F160 and Displaying Images	22
2-1-1	Starting the Expert Menu	22
2-1-2	Displaying Images and Focussing	23
2-2	Menu Operations	24
2-2-1	Input Devices	24
2-2-2	Screen Displays	25
2-2-3	Menu Tree	26
2-2-4	Drawing a Region	28
2-2-5	Inputting Values	29
2-2-6	Inputting Characters	31
2-3	Two-camera Unit	32
2-3-1	Two-camera Menus	33
2-4	Setting Inspection Conditions	34
2-4-1	STEP 1: Entering Set Mode	34
2-4-2	STEP 2: Adjusting Images	38
2-4-3	STEP 3: Position Compensation	47
2-4-4	STEP 4: Measurement Region	48
2-4-5	STEP 5: Output Expressions	59
2-4-6	STEP 6: Display	60
2-4-7	STEP 7: Monitor Mode and Run Mode	60
2-5	Run Mode	63
2-5-1	Entering Run Mode	63
2-5-2	Performing Measurement	63
2-6	Saving Settings and Exiting the F160	65

2-1 Starting the F160 and Displaying Images

This section describes how to start the F160 Expert Menu and how to display images on the monitor. Refer to the displayed image when adjusting the Camera position and focus.

2-1-1 Starting the Expert Menu

1. Check that the basic F160 components have been connected properly.

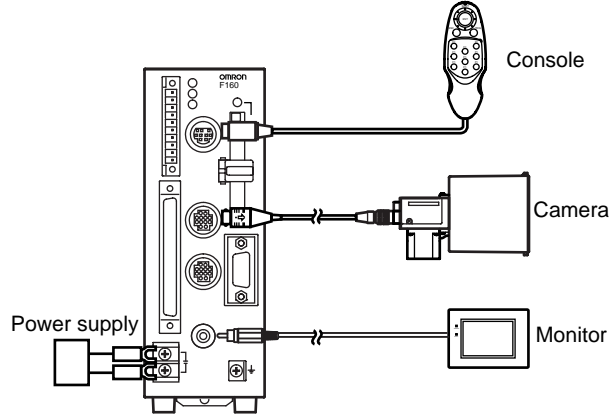

CHECK

Before connecting components or wiring power supply lines and grounding wires, be sure to refer to the relevant section in the *Setup Manual*. Refer to *Setup Manual*.

2. Turn ON the power supply to the Monitor.
3. Turn ON the power supply on the F160.

The Select Menu Screen will be displayed.

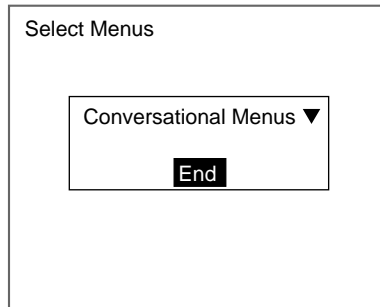

4. Move the cursor from **End** to **Conversational Menu** and press the **ENT** Key.

The menu selections will be displayed.

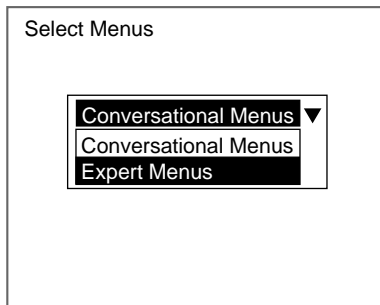

5. Move the cursor to **Expert Menus** and press the **ENT** Key.
 6. Select **END**.
- After a short pause, the Camera Settings Screen will be displayed.

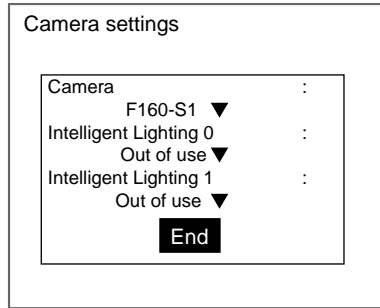

SeeAlso

Refer to page 293 for information on the Camera Settings Screen.

7. Set the Camera that is connected.
8. When using Intelligent Lighting, set the model.
9. Select **END**.

The Basic Screen for the Expert Menu will be displayed.

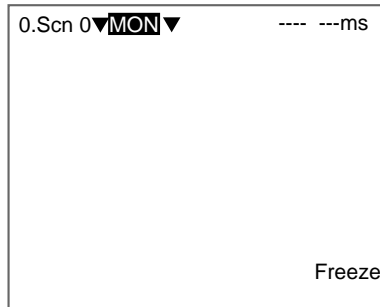

CHECK

When the settings have been completed, it is useful to use Startup Mode when actually operating the F160. Startup Mode is used to set the startup conditions (display screen) when the F160 is next started. For example, set the F160 to start in Run Mode. This will allow measurements to be started immediately and will make day-to-day operations easier. Refer to page 324.

CHECK

You can select whether or not to display the Select Menus or Camera Settings Screens when starting the F160. Refer to page 324.

2-1-2 Displaying Images and Focussing

1. Check that the inspection object is displayed on the monitor screen.

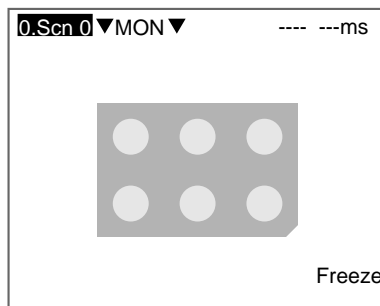

If it is not displayed, change the display image from freeze to through display and adjust the position of the inspection object so that it appears in the center of the monitor screen.

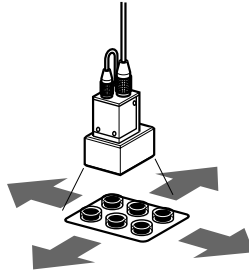

Adjusting the position of the inspection object.

CHECK Press SHIFT+ESC Keys. The screen for changing the display image will be displayed.

2. Focus the Camera.

- Cameras with a light source (including Intelligent Lighting) have lenses with a fixed focal point. Adjust the Camera position based on the positioning distances in the Setup Manual to focus the Camera.

CHECK The light level for Intelligent Lighting can be adjusted from the F160. Refer to page 39.

- When using a Camera Unit, turn the focus ring to focus the Camera.

CHECK Change the shutter speed when the object is moving quickly causing the image to be blurred. Refer to page 38.

2-2 Menu Operations

2-2-1 Input Devices

Menu operations are performed from either the Console or the serial interface.

■ F160-KP Console

■ F150-KP Console

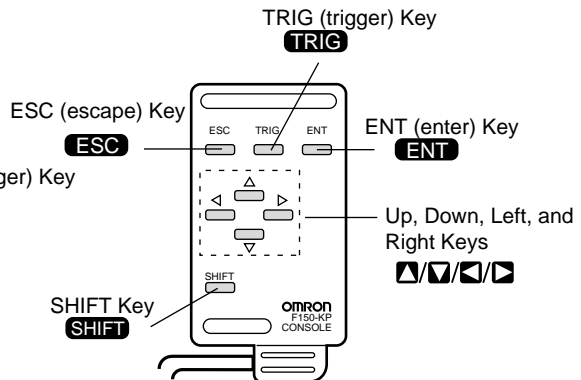
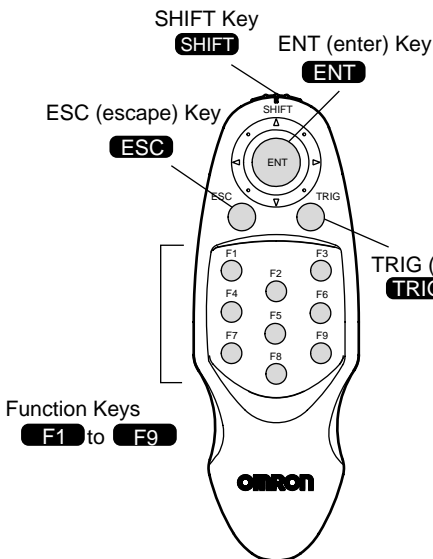

Key	Function
ESC: Escape Key	Returns the user to the previous menu display or operation.
TRIG: Trigger Key	Starts object measurement.
ENT: Enter Key	Executes a function or sets a value. Note: On the F160-KP, also functions as a Cursor Key.
SHIFT Key	Must be pressed in combination with another key to have any effect. Specific functions are assigned to combinations of the SHIFT Key and other keys for specific screens.
Up, Down, Left, and Right Keys	The Up and Down Keys are used to move the cursor up and down and also to set values. The Up Key will increase a value by 1 and the Down Key will decrease a value by 1. Hold down the Up or Down Key to quickly increase or decrease a value. The Left and Right Keys are used to move the cursor left or right.
Function Keys	Functions can be assigned to function keys F1 to F8. Refer to page 309. The display can be captured using F9. Refer to page 312.

CHECK Menu operations can be performed from a personal computer via a serial interface. Refer to the *Communications Reference Manual*.

2-2-2 Screen Displays

The F160 is operated by selecting functions displayed on the screen. Familiarize yourself with each function before operating the F160.

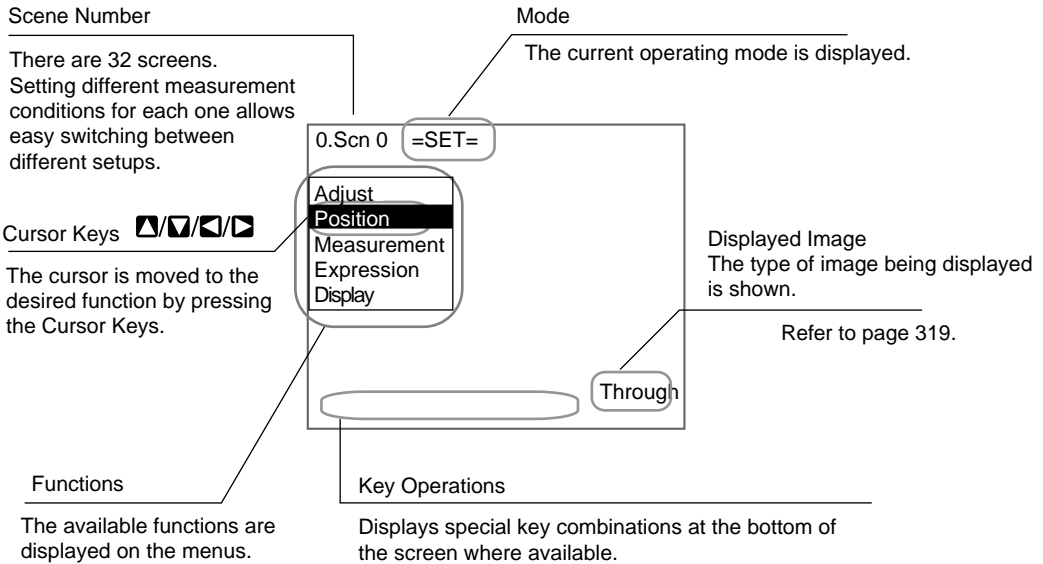

Mode

Display	Meaning
SET	Used to set the inspection conditions.
MON (Monitor)	Used to check whether inspections are being performed correctly under the set inspection conditions. The measurement results are displayed on the monitor only. The results cannot be output to external devices.
RUN	Performs inspection. The measurement results are output to an external device via the parallel interface or RS-232C interface.
SYS (System)	Used to set system conditions for the F160.
TOOL	Used to save settings and images to a computer as backup.
SAVE	Used to saves data to flash memory. If new settings have been made, be sure to save the data before quitting.

2-2-3 Menu Tree

F160 menus are hierarchical. The cursor is moved to the required functions to set measurement conditions. Use the following procedure to move around the menu tree.

1. Move the cursor to the desired function in Set Mode using the **Up, Down, Left, and Right** Keys.

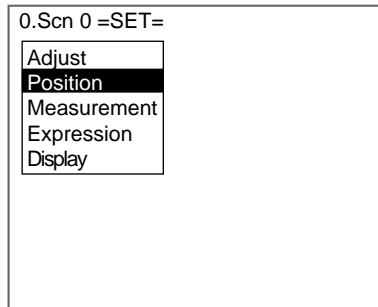

2. Press the **ENT** Key.

In this example, the cursor will move to the Position Menu.

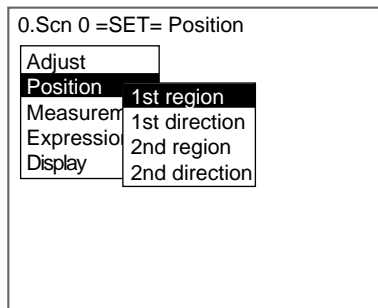

3. Repeat step 2 to move to lower levels.

Press the **ESC** Key to move the display to the previous menu level.

Triangle Mark

Items with an inverted triangle after them have a list of alternatives. The method for selecting the alternatives is given here.

1. Move the cursor to the item to be set. In this example, a Camera alternative will be selected.

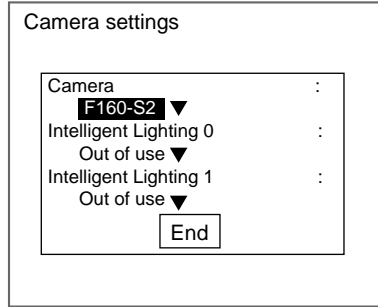

2. Press the **ENT** Key.
The selections will be displayed.

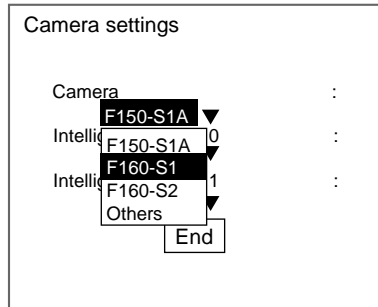

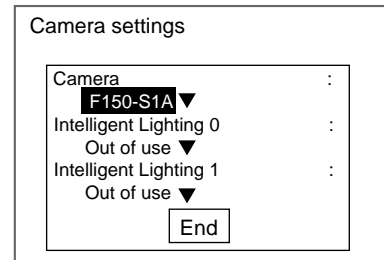

3. Move the cursor to the desired selection using the Up and Down Keys.
4. Press the **ENT** Key.
The selected setting will be entered.



2-2-4 Drawing a Region

Use the following method to draw model regions and measurement regions. Move the cursor with the Up, Down, Left and Right Keys. Use these keys together with the SHIFT Key to move the cursor quickly. Press the ENT Key at the desired positions and press the ESC Key to undo the setting.

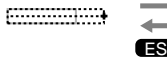
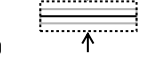
Measurement item	Measurement region selection	Drawing method
Gravity and area Gravity and axis Gray search Precise search	Box	<p>The whole region moves. The lower right coordinates move.</p> <p>The figure is set.</p>
Density data Relative search Rotation search Labeling Classification Defect (region) Flexible search	Ellipse	<p>The whole region moves. The lower right coordinates move.</p> <p>The figure is set.</p>
	Circle	<p>The whole region moves. The circumference changes.</p> <p>The figure is set.</p>
	Circumference	<p>The whole region moves. The circumference changes. The width changes.</p> <p>The figure is set.</p>
	Polygon	<p>Specify the first point. Specify the second point. Specify the third and other points. The figure is set.</p> <p>Press the ENTKey twice. (Up to 10 points can be specified.)</p>
Edge position Edge pitch Edge width OCR for 1 chara Area (var. box) Defect (var. box)	Box	<p>Specify two opposite corner points. Refer to the drawing method for "box" shown above.</p>

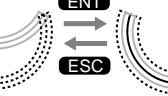
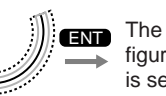
Measurement item	Measurement region selection	Drawing method
Defect	Line	The whole region moves.  The length changes.  The width changes.  → The figure is set.
	Arc	The whole region moves.  The end point moves.  The mid-point moves.  The width changes.  → The figure is set.
	Circumference	Specify the center, diameter, and thickness.
	Region	Up to 3 shapes (rectangle, ellipse, circle, circumference, or polygon) can be combined. Refer to the drawing methods for each shown above.

Drawing Mode

For many measurement methods, up to 3 figures can be combined to draw a measurement region. Select either the OR or NOT drawing mode.

Drawing mode	Function
OR	Use this mode to draw a shape as a model or measurement region.
NOT	Use to delete part of a region.

In this example, the gray area will be the measurement region.

Regions with complicated shapes can be drawn and areas can be omitted from the measurement region by combining figures.

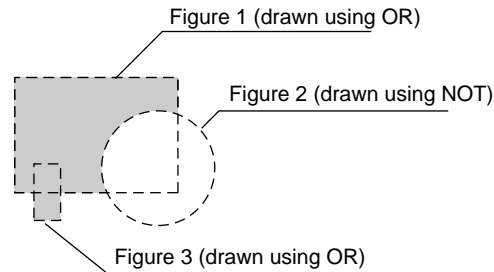

2-2-5 Inputting Values

This section explains how to input values when setting measurement conditions or communications specifications.

1. Move the cursor to the item for which a value is to be changed.

Judgement conditions

```

Area      : 2035.000
[ 2000.000 : 247808.000]
Gravity X : 180.000
[ 0.000 : 511.000]
Gravity Y : 250.000
[ 0.000 : 483.000]

[End]

```

2. Press the **ENT** Key.

The cursor will change to a cursor the size of a single digit.

Judgement conditions

```

Area      : 2035.000
[ 2000.000 : 0247808.000]
Gravity X : 180.000
[ 0.000 : 511.000]
Gravity Y : 250.000
[ 0.000 : 483.000]

[End]

```

3. Move the cursor to the digit to be changed.

Use the **Left** and **Right** Keys to move the cursor.

4. Change the value.

Use the **Up** Key to increase the value.

Use the **Down** Key to decrease the value.

Judgement conditions

```

Area      : 2035.000
[ 2000.000 : 0047808.000]
Gravity X : 180.000
[ 0.000 : 511.000]
Gravity Y : 250.000

```

5. Repeat these steps to change other values.

6. Press the **ENT** Key.

The values will be set.

Judgement conditions

```

Area      : 2035.000
[ 2000.000 : 25000.000]
Gravity X : 180.000
[ 0.000 : 511.000]
Gravity Y : 250.000
[ 0.000 : 483.000]

[End]

```



2-3 Two-camera Unit

Using the Two-camera Unit, two Cameras can be connected to the F160 to enable obtaining two images simultaneously.

Synchronized Images from Different Directions

Example: Checking Boxes from Both Ends

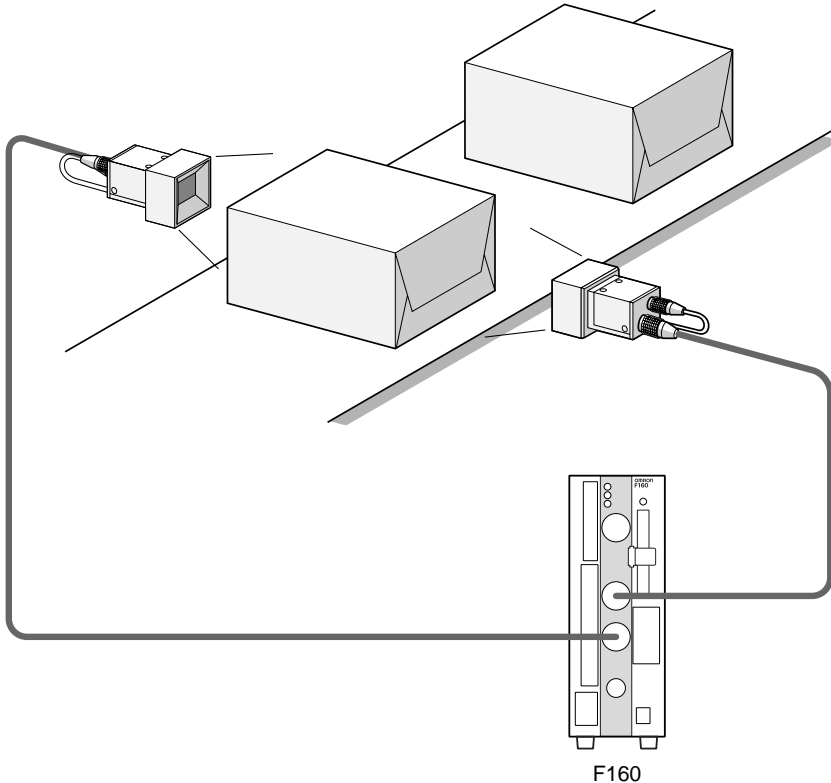
Measurement can be performed for boxes from both ends simultaneously using two Cameras. A Sync Sensor is required.



Prevention Function for Mutual Light Interference

If a Camera with Intelligent Lighting (F160-SLC20/SLC50 or F150-SLC20/SLC50) or a Camera with a Light Source (F150-SL20A/SL50A) is used, there is a slight difference in the time at which the light sources for the two Cameras come ON (first Camera 0 then Camera 1). Therefore, there is no mutual light interference.

Measuring Large Objects with One Controller

Example: Positioning PWB

Using two Cameras, the field of vision can be split in two and the coordinates of positioning markings can be obtained.

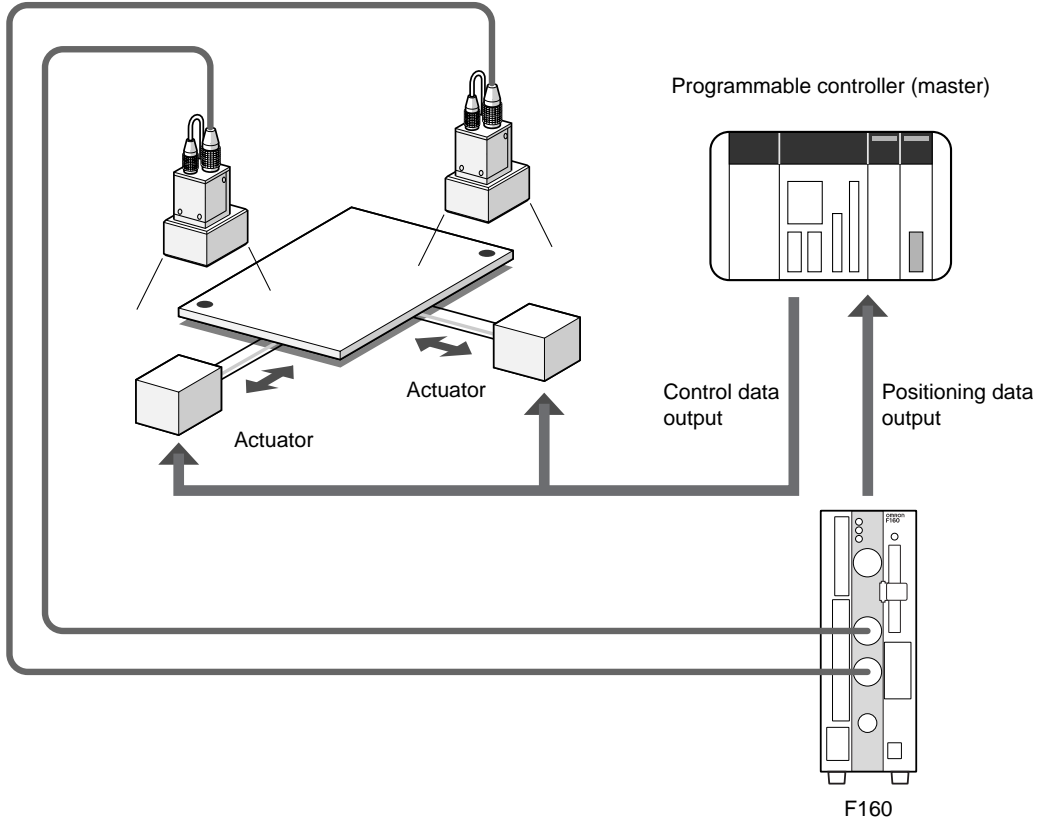

2-3-1 Two-camera Menus

When entering Set Mode for a scene for which the inspection conditions have not been set, the screen for selecting the Camera mode will be displayed. The default menu configuration is for one-Camera operation. For two-Camera operation, change the Camera setting to Camera 0+1 and select the image type (Frame/Field).

SeeAlso Refer to page 34.

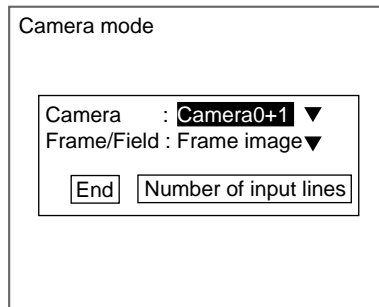

CHECK When *Field* has been selected, check whether measurements can be performed correctly.

Changing Camera Mode after Making Settings

To display the screen for setting the Camera mode, press the **SHIFT+ENT** Keys from the Set Mode screen.

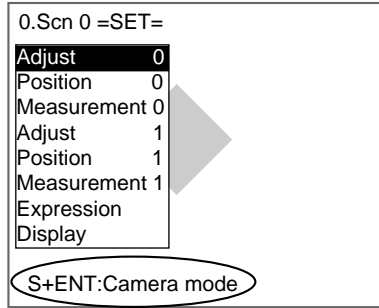

CHECK Once the settings have been changed, save the settings to flash memory. Then restart the F160 and set the measurement conditions.

2-4 Setting Inspection Conditions

This section explains how to set inspection conditions using the Expert Menus and the basic steps before starting inspections. Gravity and area measurement will be used as an example.

2-4-1 STEP 1: Entering Set Mode

To set the inspection conditions, it is first necessary to enter Set Mode.

When entering Set Mode for a scene for which the inspection conditions have not been set, the screen for selecting the Camera mode will be displayed. The menu configuration varies with the Camera mode.

SeeAlso Refer to page 34 for information on changing the Camera mode when settings have been completed.

CHECK When Intelligent Lighting is connected, set the lighting format to be used before entering Set Mode. Refer to page 293

Item	Selections	Meaning
Camera	Camera 0 (default) Camera 1 Camera 0+1	Select the connector number to which the Camera to be used is connected. When measuring with two Cameras, select Camera 0+1. CHECK If the Camera setting is changed, the image adjustment settings are initialized.
Frame/Field	Frame image (default)	Measures using frame images.
	Field (high speed)	Measures images in fields. The processing time can be reduced but the accuracy of the measurement will be reduced because the measurement is performed on an image with low resolution in the vertical direction. When <i>Field</i> has been selected, check whether measurements can be performed correctly.
Number of input lines	12 to 484 lines (default: 484 lines)	<p>This setting is only possible when the F160-S2 is connected. It determines the range of the image obtained from the Camera. The time taken to obtain images can be reduced by specifying an appropriate range with this setting. It is useful when performing inspections on measurement objects that lie within a certain fixed range.</p> <p>Images of the specified number of lines are displayed at the top of the monitor screen. Set the regions for the various processing items so that they lie within the displayed range. Coordinate values for measurement results are displayed using the values for the position in the monitor display. When the number of input lines is changed, the calibration settings must also be changed accordingly.</p>

CHECK The following tables show the relationship between the number of input lines setting and the image capture time (i.e., the time taken to obtain an image).

Frames		Fields	
Number of input lines	Capture time (See note.)	Number of input lines	Capture time (See note.)
484	16.7 ms	484	8.3 ms
432	14.8 ms	384	7.1 ms
402	13.8 ms	324	6.2 ms
372	12.9 ms	264	5.2 ms
342	11.9 ms	204	4.3 ms
312	11.0 ms	144	3.3 ms
282	10.0 ms	84	2.4 ms
252	9.1 ms	60	2.0 ms
222	8.1 ms	24	1.4 ms
192	7.1 ms		
162	6.2 ms		
132	5.2 ms		
102	4.3 ms		
72	3.3 ms		
42	2.4 ms		
12	1.4 ms		

Note The above figures do not include the shutter time.

HELP Frame/Field

Frame and field are units of image information.
 Frame images consist of odd-number and even-number fields.

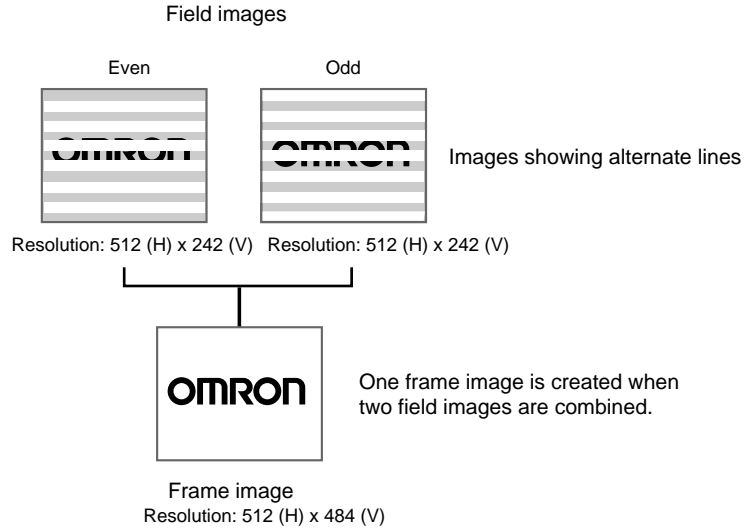

1. Display the Basic Screen, move the cursor to **MON**, and press the **ENT** Key.

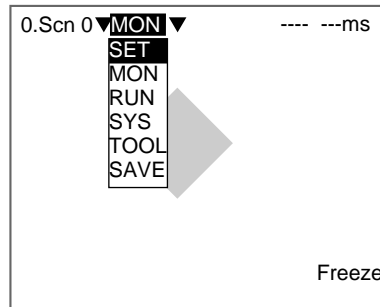

2. Select **SET**.

The Camera mode Settings Screen will be displayed for scenes without set inspection conditions.

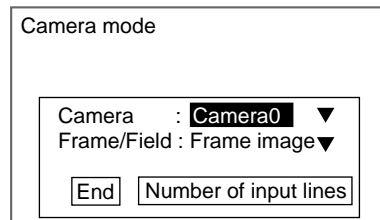

3. Set each item and press the **ENT** Key.

CHECK

When measuring with two Cameras, select *Camera 0+1* as the *Camera* setting.

If the number of input lines needs to be set, go to step 4.

If the number of input lines does not need to be set, go to step 7.

4. Select **Number of input lines**.

The Camera and Frame/Field settings will be registered and the screen for the setting the number of input lines will be displayed.

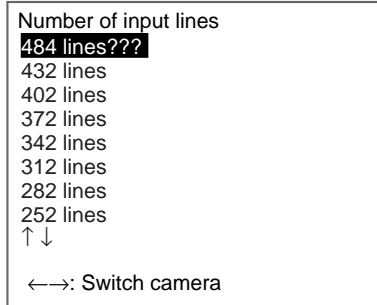

5. Select the desired number of input lines using the **Up** and **Down** Keys. When the selection has been made, the setting range will be displayed with dotted lines.

CHECK

When setting for two Cameras, Camera 0's image is displayed. If necessary, Camera 1's image can be selected using the **Right** and **Left** Keys.

6. Press the **ENT** Key.

The screen for step 3 is returned.

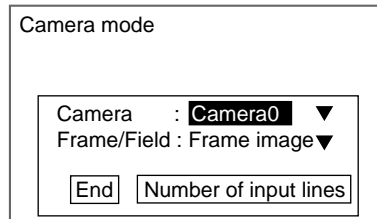

7. Select **End**.

The initial screen for Set Mode will be displayed.

Using One Camera

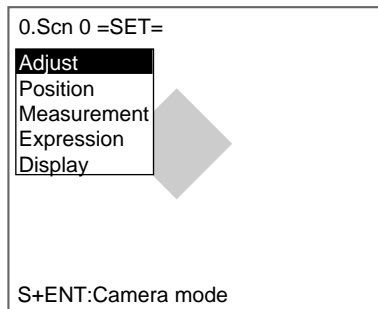

Using Two Cameras

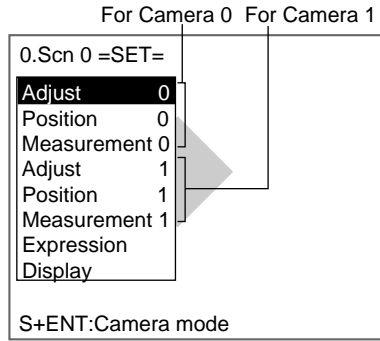

Changing Camera Mode after Making Settings

To display the screen for setting the Camera mode, press the **SHIFT+ENT** Keys from the Set Mode screen.

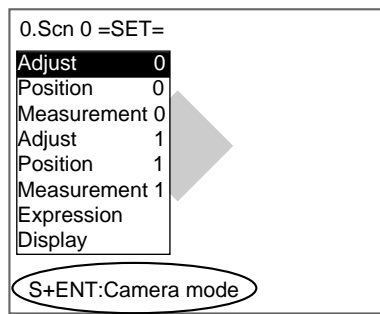

CHECK Once the settings have been changed, save the settings to flash memory. Then restart the F160 and set the measurement conditions.

2-4-2 STEP 2: Adjusting Images

To facilitate accurate and efficient inspections, images are adjusted for clearer display of the section to be inspected.

TwoCamera Adjust 0 is displayed for Camera 0 and Adjust 1 appears for Camera 1.

2-4-2-1 Shutter Speed

Change the shutter speed when the object is moving quickly, causing the image to be blurred.

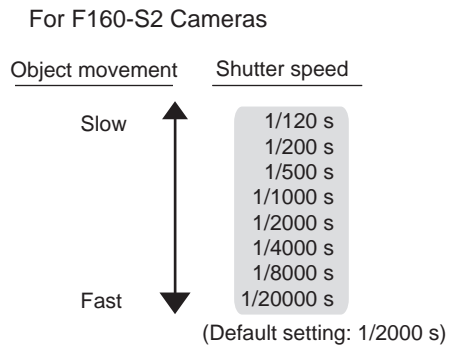
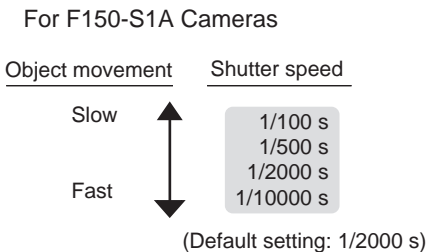

TwoCamera

When using two Cameras, shutter speed can be set independently for each Camera. The shutter speed can be changed from the menu for F150-S1A and F160-S2 Cameras only.

1. Select **Adjust/Shutter speed**.

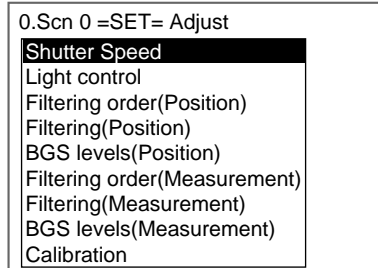

The shutter speed selections will be displayed.

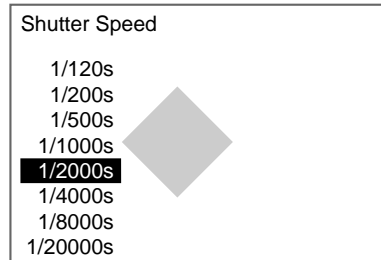

2. Select the shutter speed while monitoring the image.
3. Press the **ENT** Key.

The setting will be registered and the screen in (1.) will return.

2-4-2-2 Light Control

When using Cameras with Intelligent Lighting, the light level can be adjusted from the F160. Before using Intelligent Lighting, be sure to change the settings in *SYS/Camera settings*.

SeeAlso Refer to page 293.

TwoCamera

Light levels for Intelligent Lighting can be adjusted for each Camera. The light level set at Adjust 0/Light Control 0 is for Camera 0 and the light level set at Adjust 1/Light Control 1 is for Camera 1.

CHECK

If the shutter speed is faster than 1/2,000 s, changing the light level may not affect the brightness. Intelligent Lighting emits pulse lighting in synchronization with the shutter speed. The light level is adjusted by changing the pulse width. If the light level is at its maximum setting of 7, the pulse width is approximately 450 μs, which is almost the same as the shutter interval setting of 1/2,000 s. Therefore, setting the shutter speed to a setting faster than 1/2,000 s may have no effect when the light level setting is high. For example, if the shutter speed is set to 1/4,000 s, light level settings will be effective only up to level 4, as shown in the diagram below.

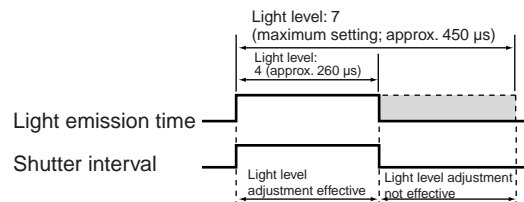

CHECK Intelligent Lighting cannot be used with the F160-S2 unless the Camera mode/ Number of input lines setting is set to 484.

Intelligent Lighting Screen

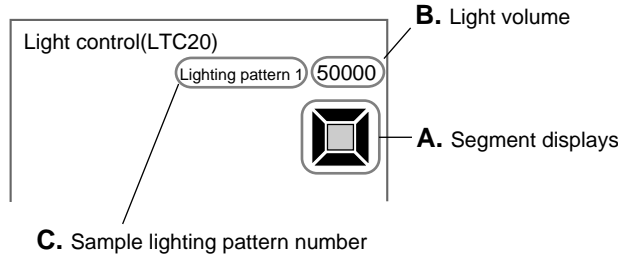

Segment Display

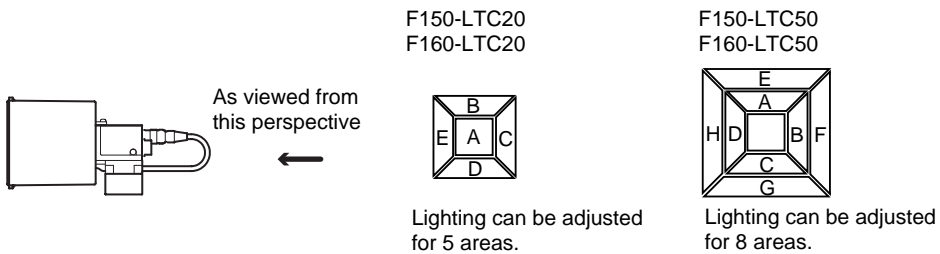

CHECK The measurement points are displayed with thick lines. The brightness depends on the set light level. Refer to page 40.

Displaying Light Levels

The light level for each segment is displayed in a 5- or 8-digit value, with each digit representing the light level of one of the segments. The light levels are displayed from 0 to 7, with 0 indicating that the light is OFF. The higher the setting, the higher the light level.

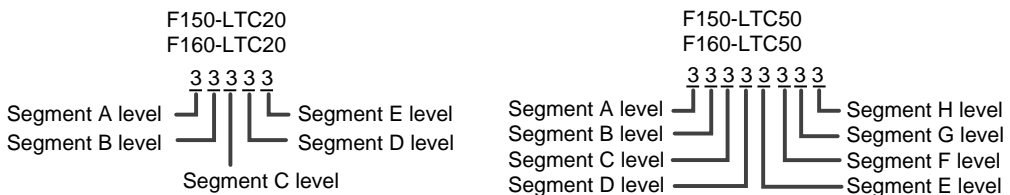

Sample Lighting Patterns

There are 15 sample lighting patterns registered in the F160.

SeeAlso Refer to page 40.

Adjustment Method 1: Sample Lighting Patterns

There are 15 lighting patterns registered in the F160. The lighting can be set simply by going through the different patterns in order and selecting the one that gives the clearest image. Use the SHIFT+Left and Right Keys to switch between sample patterns.

F150-LTC20, F160-LTC20

- Not lit
- Lit (maximum light level)

Pattern No.	Light level	Pattern No.	Light level	Pattern No.	Light level	Pattern No.	Light level	Pattern No.	Light level
1	50000 	4	07070 	7	22727 	10	00070 	13	52222
2	03333 	5	27272 	8	07000 	11	00007 	14	17777
3	07777 	6	00707 	9	00700 	12	51111 	15	27777

F150-LTC50, F160-LTC50

Pattern No.	Light level	Pattern No.	Light level	Pattern No.	Light level	Pattern No.	Light level	Pattern No.	Light level
1	7777777 	4	00004444 	7	07070707 	10	00700000 	13	00000700
2	44440000 	5	00007777 	8	70000000 	11	00070000 	14	00000070
3	77770000 	6	70707070 	9	07000000 	12	00007000 	15	00000007

Adjustment Method 2: Adjusting Light Levels by Segment

The light level for each segment can be set separately to a value between 0 and 7. The setting "0" represents the unlit state, and the higher the setting value the higher the light level. Light levels can also be set by adjusting the light levels for the sections separately after selecting a sample lighting pattern.

Use the Left and Right Keys to select the section to be adjusted and use the Up and Down Keys to adjust the light level.

F150-LTC20, F160-LTC20

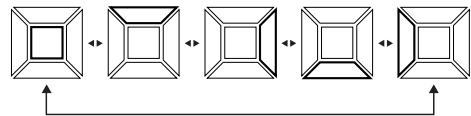

F150-LTC50, F160-LTC50

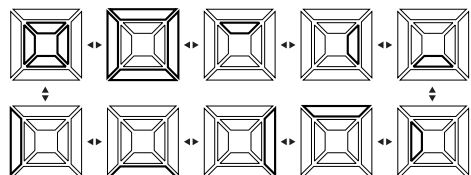

1. Select **Adjust/Light control**.

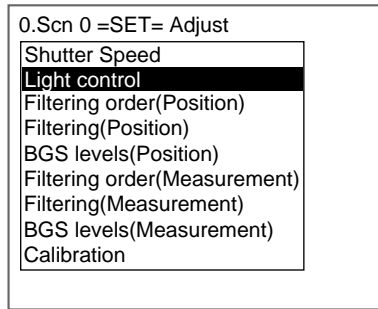

The settings screen for light control will be displayed.

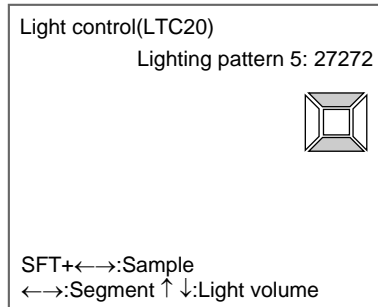

2. Switch the sample pattern lighting level using the **SHIFT+Left/Right** Keys. A graphic showing the lighting level will be displayed.

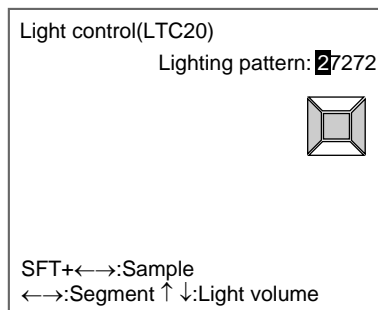

CHECK

For fine adjustment of light levels, move to the desired digit using the Right and Left Keys and adjust the light level using the Up and Down Keys.

3. Press the **ENT** Key.

The setting will be registered and the screen in (1.) will return.

2-4-2-3 Filtering Order

The processing order for filtering and BGS levels can be selected. This processing order can be set separately for position compensation and measurement item.

The cursor can be moved on the image to see the effects of filtering.

TwoCamera

The filtering order can be selected for each Camera separately. The filtering order set at Adjust 0/Filtering Order 0 is for Camera 0 and the filtering order set at Adjust 1/Filtering Order 1 is for Camera 1.

1. Select **Adjust/Filtering order (Measurement)**.

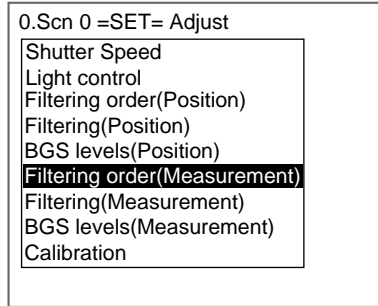

The settings screen for filtering order will be displayed.

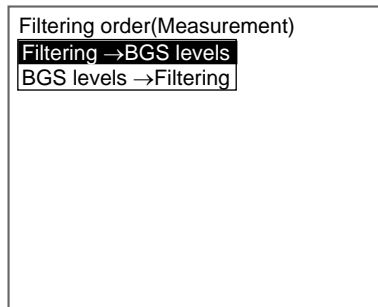

2. Select the filtering order while monitoring the image.
3. Press the **ENT** Key.

The setting will be registered and the screen in (1.) will return.

2-4-2-4 Filtering

The image read by the Camera can be manipulated to create an image that is easier to measure by using the 8 filtering methods: Smoothing, dilation, erosion, median, edge enhancement, vertical edge extraction, horizontal edge extraction, and edge extraction. The filtering can be set separately for position compensation and measurement.

The cursor can be moved on the image to see the effects of filtering.

TwoCamera

The filtering order can be selected for each Camera. The filtering order set with Filtering Order under Adjust 0 is for Camera 0 and the filtering order set with Filtering Order under Adjust 1 is for Camera 1.

Filtering	Target	Function	Example application
OFF	---	---	---
Smoothing	Measurement objects with slight surface irregularity	Reduces the irregularity through smoothing. Select either weak or strong smoothing.	Stable searches
Dilation	White measurement objects with black noise	Increases white to eliminate black noise.	Removal of noise from measurement objects

Filtering	Target	Function	Example application
Erosion	Black measurement objects with white noise	Reduces white to eliminate the white noise.	Removal of noise from measurement objects
Median	Measurement objects with slight surface irregularity	Reduces surface irregularities while maintaining the contour.	Edge positioning (with no reduction in accuracy)
Edge enhancement	Blurred measurement objects (e.g., due to lighting changes)	Enhances edges between bright and dark regions.	Edge positioning
Vertical edge extraction	Measurement objects difficult to extract due to bad image contrast	Extracts the vertical edges (light and dark) of an image.	Defect inspection (using binary processing)
Horizontal edge extraction	Measurement objects difficult to extract due to bad image contrast	Extracts the horizontal edges (light and dark) of an image.	Defect inspection (using binary processing)
Edge extraction	Measurement objects difficult to extract due to bad image contrast	Extracts the vertical edges (light and dark) of an image.	Defect inspection (using binary processing)

CHECK Filter Size

When the Camera mode is set to Frame Image, the strength of the filtering can be selected.

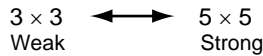

SHIFT + **ENT** The image changes each time these keys are pressed.

SeeAlso Refer to page 33 for information on how to check and change Camera modes.

1. Select **Adjust/Filtering (Measurement)**.

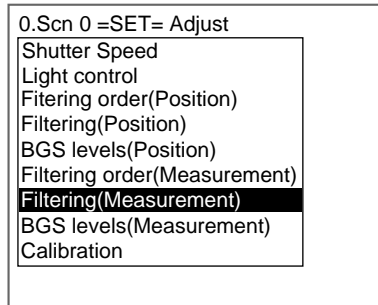

The settings screen for filtering will be displayed.

If the Camera mode is set to Frame Image, the filter size will be displayed in the top right-hand corner of the screen.

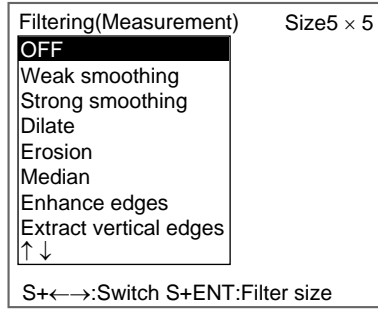

2. Select the filtering method while monitoring the image.
Press the **SHIFT + ENT** Keys to change the filter size.

CHECK

If the image is difficult to see with the Filtering Menu, press the **SHIFT+Left/Right** Keys. The background will become transparent.

3. Press the **ENT** Key to save the selection.

The setting will be registered and the screen in (1.) will return.

CHECK

When filtering is applied to an image, values corresponding to the zone around the edges of the screen will be undefined. Be sure to set the measurement range to that this zone is not included in the range.

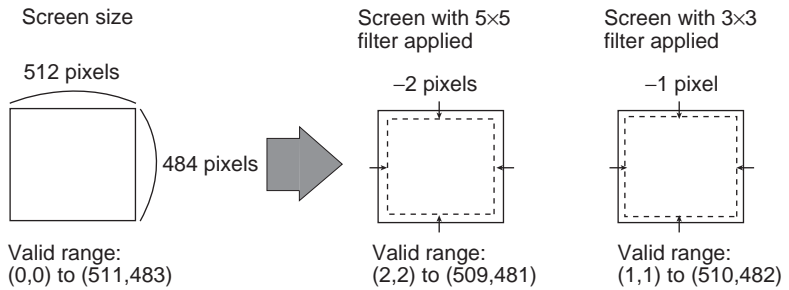

The example below shows the effect of filtering F160-S2 images when the number of input lines is not set to 484. (282 is the setting used in the example.)

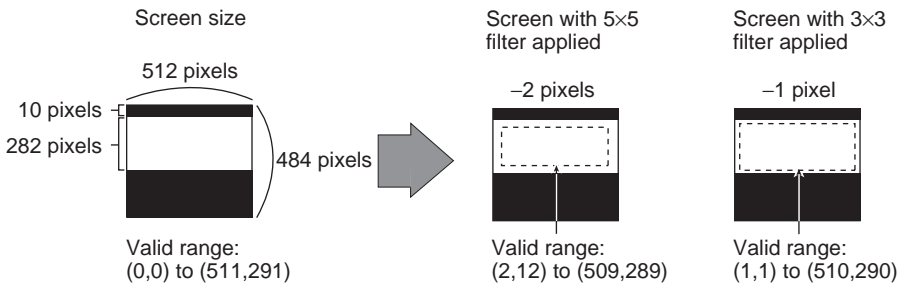

2-4-2-5 Background Suppression

Background suppression (BGS) excludes the background of the measurement object from the measurement process for easier measurement. BGS can be set separately for position compensation and measurement.

Set the upper and lower limits of the BGS density while monitoring the image. BGS changes image areas with densities below the lower limit to 0, and image areas with densities above the upper limit to 255. Image areas with densities

between the lower and upper limits are graded from 0 to 255 so that only images with densities between the lower and upper limits are measured.

Example: Lower limit set to 100 and upper limit set to 220

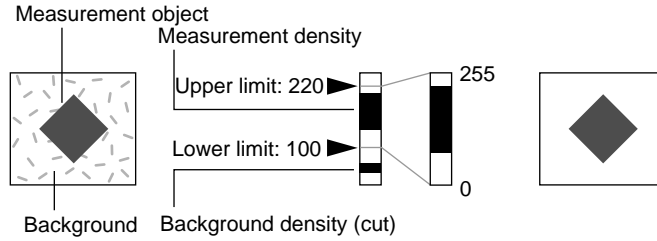

- Images with densities set to less than 100 are not measured and the density becomes 0.
- Only images with densities between 100 and 220 are measured and the images are graded between 0 and 255.

TwoCamera

The BGS settings can be set separately for each Camera. The BGS levels set in Adjust 0/BGS Levels are for Camera 0 and Adjust 1/BGS Levels are for Camera 1.

1. Select **Adjust/Filtering (Measurement)**.

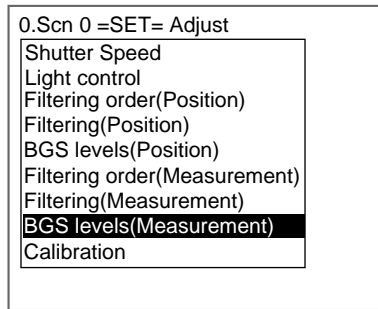

The settings screen for BGS levels will be displayed.

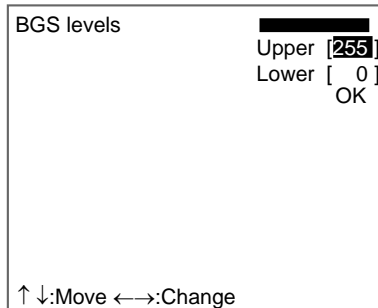

2. Move the cursor to the upper value and use the **Left** and **Right** Keys to adjust the value.
 - Right Key: Increases the lowest digit by one.
 - SHIFT+Right Keys: Increases the value in 10s.
 - Left Key: Reduces the lowest digit by one.
 - SHIFT+Left Keys: Decreases the value in 10s.
 - Up and Down Keys: Switches between setting items.
3. Use the same method to change the lower value.
4. Select **OK**.

The settings will be registered and the screen in (1.) will return.

2-4-2-6 Calibration

Calibration can be set to output the measurement results in physical units.

Set the relationship between the physical coordinates and the camera coordinates to convert the measurement results from pixels to physical units, such as μm , mm, or cm.

This section gives an outline only. Refer to *SECTION 4 Detailed Setting Operations* (page 193) for details on calibration.

CHECK To output measurement results in physical units, set *Coordinate mode/Calibration* to *ON* for each measurement item.

If *Calibration* remains set to *OFF*, the default settings will remain, and measurements using the Camera coordinates will be output.

2-4-3 STEP 3: Position Compensation

The position displacement compensation function is used when the position and orientation of measurement objects are not consistent. By using this function, the displacement between the reference position and the current position is obtained, and this displacement is compensated for in measurements.

This section gives an outlined only. Refer to *SECTION 4 Detailed Setting Operations* (page 205) for details on position compensation.

Reference Position

The measurement region and measurement object are in the correct positions.

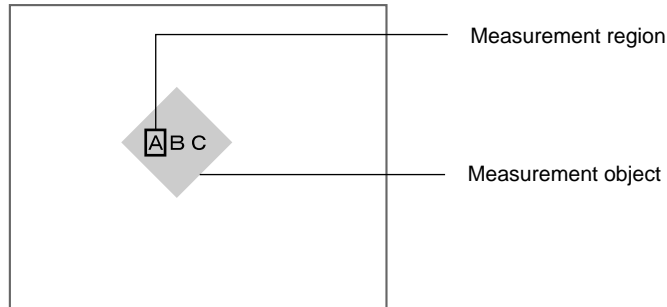

Measurement Object Displaced

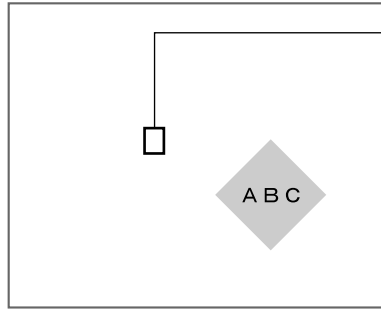

Without compensation, measurement is performed with "A" outside the measurement region.

By making position displacement compensation settings...

Measurement is performed after the image is returned to the reference position.

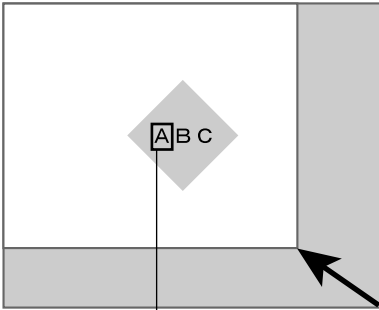

Measurement is performed after the measurement region is moved to compensate for the displacement.

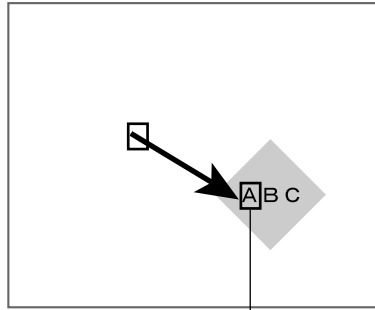

In either case, measurement is performed with "A" in the measurement region.

2-4-4 STEP 4: Measurement Region

The measurement region is drawn on an image of an acceptable measurement object and the judgement conditions are set. The process will be explained in this section using the setting operations for a Gravity and Area measurement as an example.

TwoCamera If Camera 0+1 is selected at Camera mode/Camera, Measurement 0 will be displayed for Camera 0 and Measurement 1 will be displayed for Camera 1. Refer to page 33.

2-4-4-1 Selecting Region Numbers

The F160 supports 32 measurement regions and 17 measurement methods. The measurement method can be set separately for each region.

TwoCamera If two Cameras are used, there are 16 regions (0 to 15) for Measurement 0 and 16 regions (16 to 31) for Measurement 1.

Example: Using Two Measurement Regions

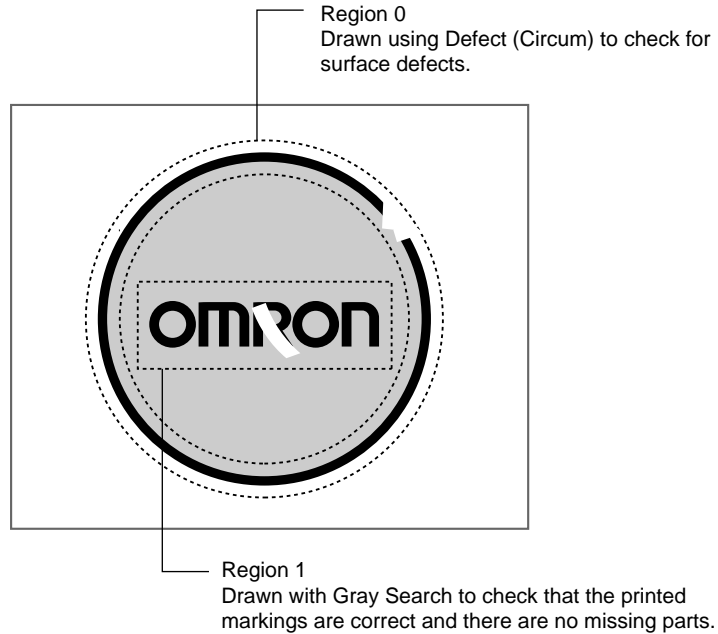

1. Select **Measurement region**.

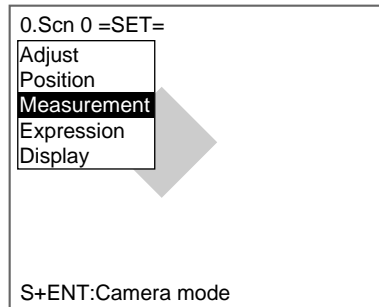

The screen for selecting the region number will be displayed.

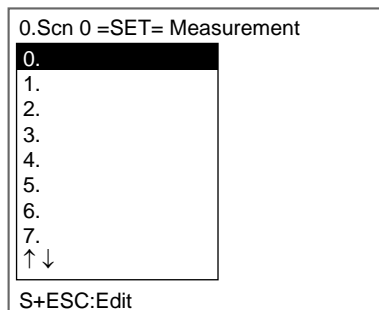

2. Select the desired region number.

CHECK

If the image is difficult to see with the list of region numbers, press the SHIFT+Right Keys. The background to the list of region numbers will become transparent.

The alternative measurement methods will be displayed.

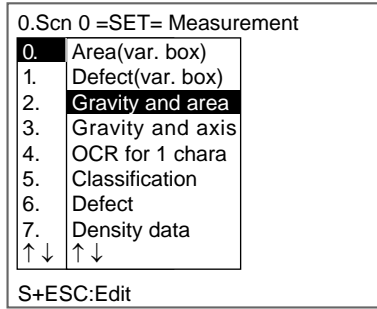

3. Select the measurement method.
In this example a Gravity and Area measurement will be used.
4. Press the **ENT** Key.
The gravity and area measurement will be registered.

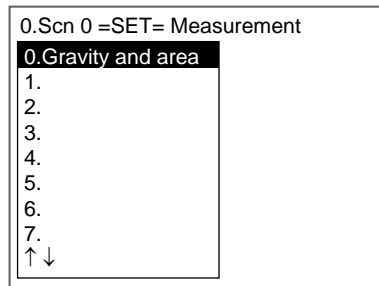

CHECK If you are already familiar with the flow of operations, make operation settings for each measurement method. Refer to page 67.

2-4-4-2 Measuring Binary Center of Gravity and Area

Density images taken by the Camera are converted to binary images, made up of black and white pixels. The F160 performs measurements on the size (area) and position (center of gravity) of the area occupied by the white pixels.

SeeAlso Refer to page 6.

Operational Flow

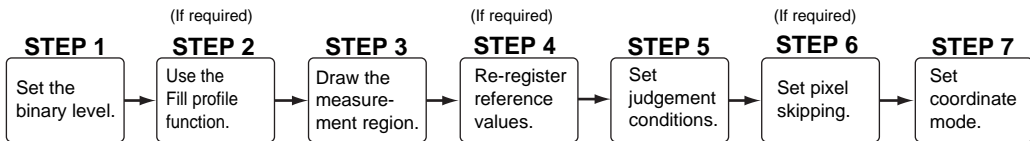

STEP 1: Setting the Binary Level

Set the level for converting 256-gradation images into binary images. The F160 performs measurement for the white pixels. Therefore, make the settings so that the measurement object is white.

1. Move the cursor to **Gravity and area** and press the ENT Key.

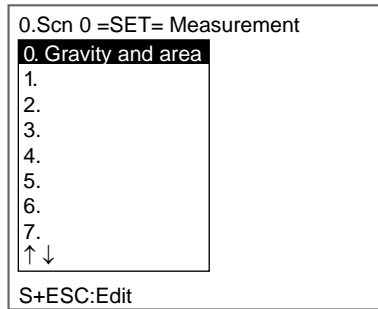

CHECK

If the image is difficult to see with the list of region numbers, press the SHIFT+Right Keys. The background to the list of region numbers will become transparent.

The initial screen for Gravity and area will be displayed.

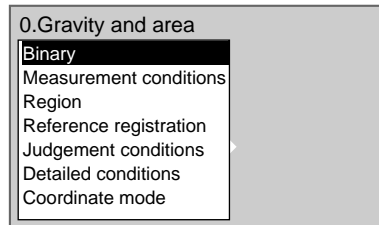

2. Select **Binary**.

The settings screen for binary levels will be displayed.

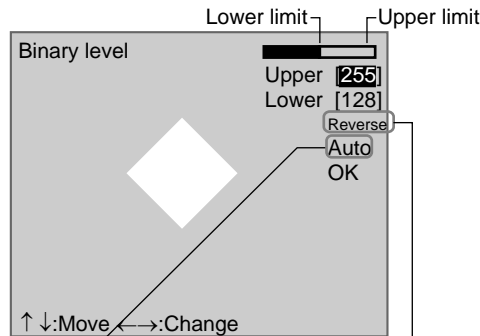

Auto
The F160 automatically sets the binary level

Reverse
Reverses dark and clear in the display

3. Move the cursor to the upper limit and use the **Left** and **Right** Keys to change the value.

Right Key: Increases the lowest digit by one.

SHIFT+Right Keys: Increases the value in 10s.

Left Key: Decreases the lowest digit by one.

SHIFT+Left Keys: Decreases the value in 10s.

Up and Down Keys: Switches between setting items.

4. Use the same method to change the lower value.

CHECK

Set the upper and lower limits to make the measurement object white.

X Make the measurement object white.

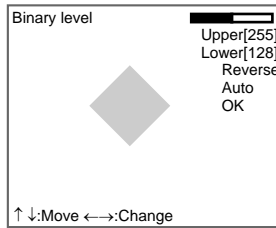

5. Select **OK**.

The settings will be registered and the screen in (2.) will return.

CHECK

It is also possible to set the binary level so that measurement is performed only for an intermediate density range.

STEP 2: Using the Fill Profile Function (Setting Judgement Conditions)

The fill profile function is set when the exterior of the measurement object is being measured.

Turn ON the fill profile function to measure the whole area between the start point (black pixels to white) and the end point (white pixels to black) in the measurement region as white pixels. The default setting for this function is OFF.

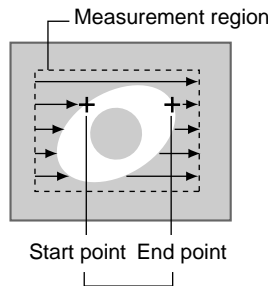

This area will be measured as white pixels.

Example

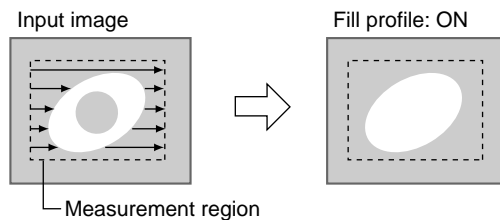

When a White-pixel Section Encroaches on the Measurement Region

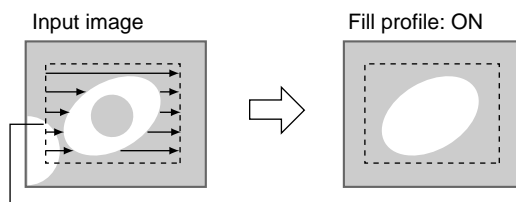

Not recognized as start point because change from white to black.

Measuring Open-form Measurement Objects

The measurement result changes depending on the orientation of the measurement object.

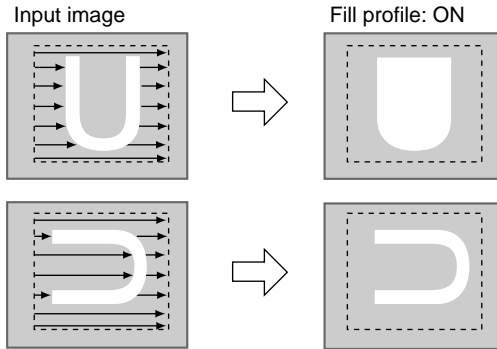

1. Select **Measurement conditions**.

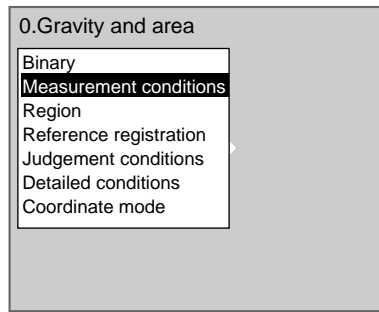

The screen for setting the measurement conditions will be displayed.

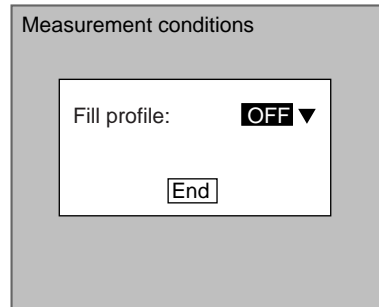

2. Select either **ON** or **OFF**.
3. Select **End**.

The setting will be registered and the screen in (1.) will return.

STEP 3: Drawing Measurement Regions

When a measurement region is drawn, measurement is performed for the displayed image and the results are registered as the reference values (area and center of gravity). This position becomes the reference position for position compensation, so be sure to place the measurement object in the correct position before drawing the measurement region.

CHECK

Regions can be created by combining up to 3 different figures. Regions with difficult shapes can be drawn and sections not to be measured can be left out of the region by combining different figures.

1. Select **Region**.

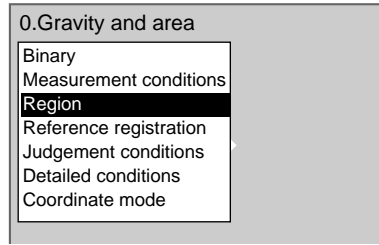

The Region Settings Screen will be displayed.

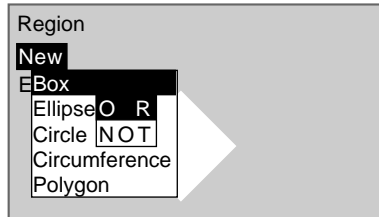

2. Select **New**.
3. Select the shape of the desired figure.
4. Select the desired drawing mode (**OR/NOT**).

SeeAlso

Refer to page 28 for methods for drawing regions.

An arrow cursor will appear.

Up to three figures (0, 1, and 2) can be drawn.

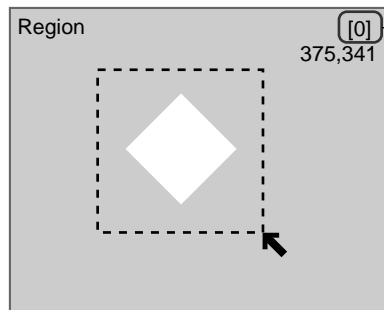

5. Draw the region with the shape selected.

The figure will be registered.

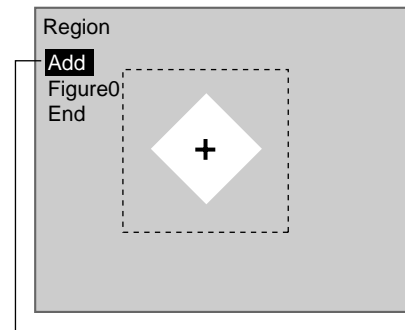

Once three figures have been drawn, **Add** will no longer be displayed.

6. If additional figures are to be drawn, select **Add**.
7. Repeat steps 3 to 5 as necessary to create the desired shape.
8. After drawing is completed, select **End**.

The measurement region will be registered and the screen in (1.) will return.

The center of gravity (marked by an arrow cursor) and the measurement region will be displayed.

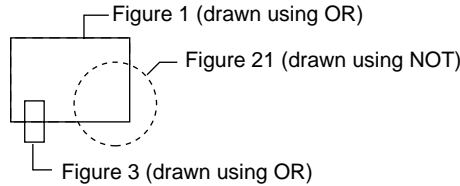

CHECK

Figures drawn using OR mode are displayed with solid lines and figures drawn using NOT mode are displayed with dotted lines.

Correcting or Clearing Figures

1. In the screen for step 6 above, select the figure to be changed or cleared using the **Up** and **Down** Keys and press the **ENT** Key.

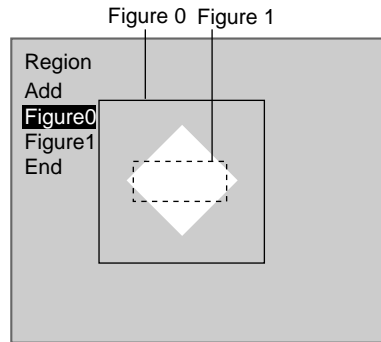

The figure for the figure number selected using the cursor will be displayed with solid lines. The selections **Correct** and **Clear** will be displayed.



2. Select either **Correct** or **Clear** and press the **ENT** Key.
 If **Correct** is selected, the cursor will be displayed. Correct the size and position of the figure as desired.
 If **Clear** is selected, the selected figure will be cleared.

STEP 4: Re-registering Reference Values

This operation is performed when only the reference values are to be re-registered.

When a measurement region is drawn, the measurement is performed for the displayed image and the results are registered as the reference values. If the re-registering function explained here is used, only the reference values for the image currently displayed will be registered. The area and center of gravity are registered for the reference values.

CHECK

The reference position can be changed to enable the following function when **Region** is selected.

Inspecting Positions from a Specified Point

Once the reference values (area and center of gravity) have been obtained for the image currently displayed, the reference position is changed to an suitable point. Position inspection can be performed by calculating the difference between this reference position and the measurement position.

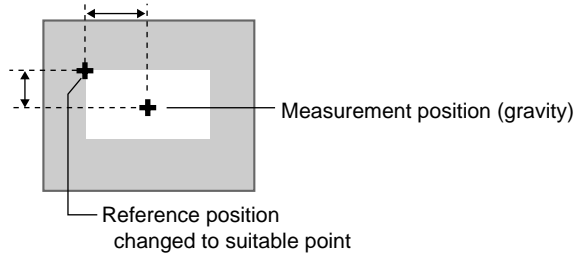

CHECK

When the measurement region is changed, the reference values return to the default settings.

1. Select **Reference registration**.

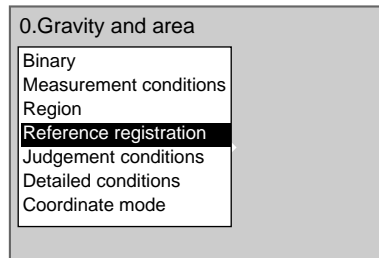

A cursor will appear at the position of the center of gravity.

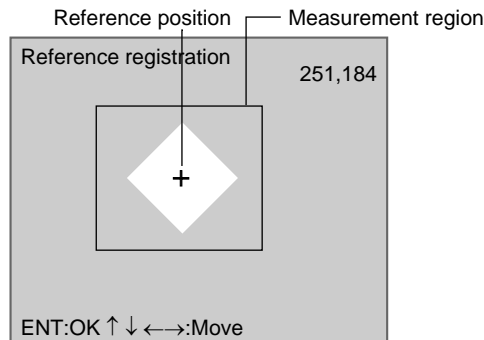

2. To change the position, use the **Up/Down** and **Right/Left** Keys to move the cursor.
3. Press the **ENT** Key to confirm the setting.

The setting will be registered and the screen in (1.) will return.

STEP 5: Setting the Judgement Conditions

Make settings for the area and center of gravity.

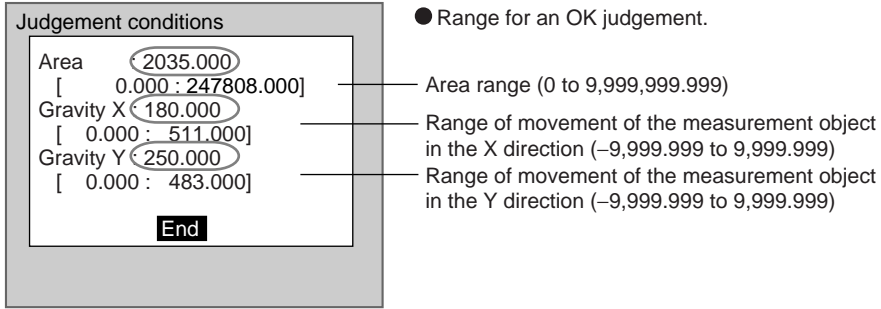

○ : Measurement results for the displayed image.
Use these values as a reference for setting upper and lower limits.

1. Select **Judgement conditions**.

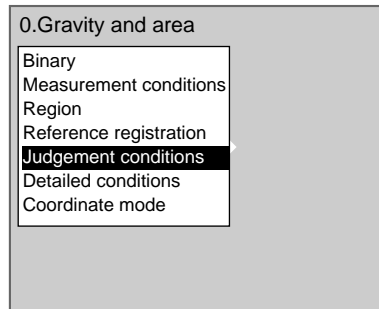

The Judgement Conditions Settings Screen will be displayed.

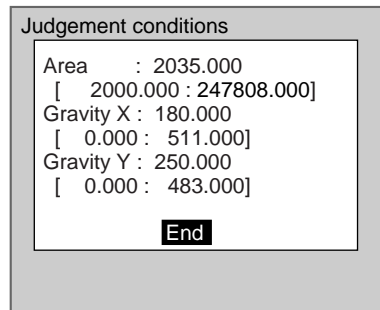

2. Change the settings.

SeeAlso

Refer to page 29 for details on inputting values.

3. Select **End**.

The settings will be registered and the screen in (1.) will return.

STEP 6: Changing Pixel Skipping

To shorten measurement processing time, change the number of pixels to be skipped. The greater the skipping setting, the shorter the processing time. However, the accuracy of the measurement will decrease.

Once the skipping setting has been changed, perform a measurement and confirm that measurement can be performed correctly.

Skipping X and Skipping Y

Set how many pixels to skip in the measurement region during measurement. The default setting is 1, which means that all of the measurement region will be measured.

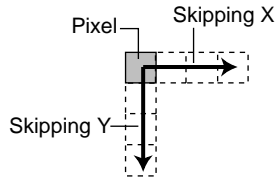

1. Select **Detailed conditions**.

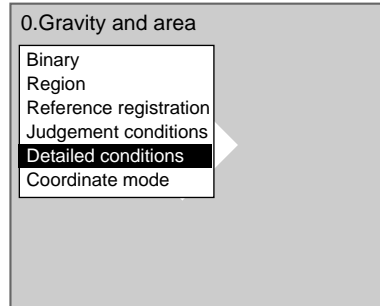

The Detailed Conditions Settings Screen will be displayed.

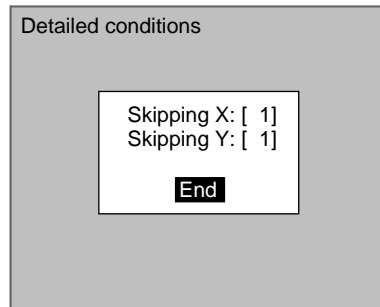

2. Set the number of pixels to skip.

SeeAlso

Refer to page 29 for details on inputting values.

3. Select **End**.

The setting will be registered and the screen in (1.) will return.

STEP 7: Setting the Coordinate Mode

Select the type of coordinates.

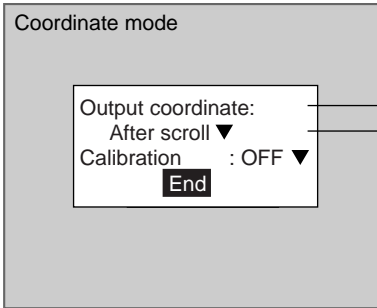

Before scroll: Output made using the coordinate values before position displacement compensation.
 After scroll*: Output made using the coordinate values after position displacement compensation.
 Refer to page 205 for position compensation.
 Refer to page 330 for differences between output coordinates.
 ON : Output made using coordinate values set using calibration.
 OFF*: Output made using Camera coordinate values.
 Refer to page 193 for information on calibration.

The default settings are marked with asterisks.*

CHECK If the coordinate mode is changed after the judgement conditions have been set, the measurement results will change also. Change the judgement conditions to enable correct measurement.

1. Select **Coordinate mode**.

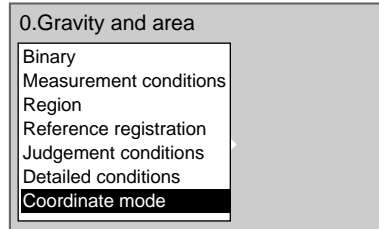

The Coordinate Mode Settings Screen will be displayed.

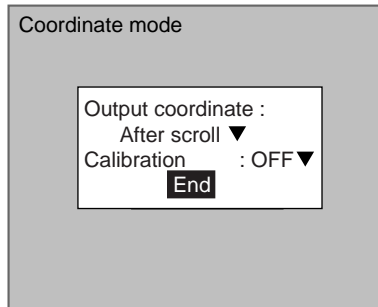

2. Make the settings for each item.
3. Select **End**.

The settings will be registered and the screen in (1.) will return.

2-4-5 STEP 5: Output Expressions

This section explains how to set the contents of outputs made to external devices via serial or parallel interfaces. Output is only made when measurements are executed in Run Mode. No output is made to external devices when measurements are executed in Monitor Mode.

Even without setting output expressions, the overall judgement of the drawn region will be output to the OR signal of the parallel interface.

This section gives an outline only. Refer to *SECTION 4 Detailed Setting Operations* (page 219) for details on output expressions.

CHECK Select the destinations for data output under *SYS/Output settings*. Refer to page 294.

2-4-6 STEP 6: Display

Figures, characters, data, and other information can be added to the screen display in Monitor and Run Modes. Up to 32 pieces of information can be added for each scene.

This section gives an outline only. Refer to *SECTION 4 Detailed Setting Operations* (page 233) for display details.

CHECK The same settings are used by both Camera 0 and Camera 1. Separate settings cannot be made for each Camera.

2-4-7 STEP 7: Monitor Mode and Run Mode

This section explains how to check if measurements are being correctly performed with the set measurement conditions using Monitor Mode, and how to make actual measurements using Run Mode.

2-4-7-1 Entering Monitor Mode

Use the following procedure to check that measurements are being correctly performed with the set measurement conditions.

CHECK The key allocations for the Console Keys used to make input can be changed. In the following explanations, it is assumed that the key allocations are at the default settings. If they are not, adapt the procedure accordingly. Refer to page 309.

Entering Monitor Mode from Set Mode

1. Display the Set Mode Screen.

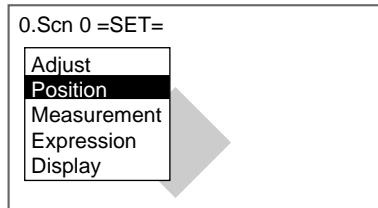

2. Press the **ESC** Key to leave Set Mode and enter Monitor Mode.

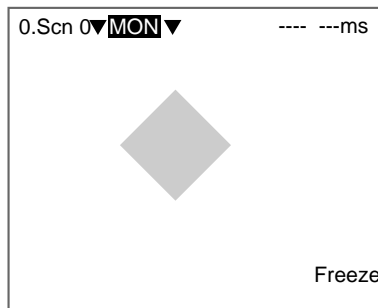

Entering Monitor Mode from Run Mode

1. Move the cursor to **RUN** and press the **ENT** Key. The mode selections will be displayed.

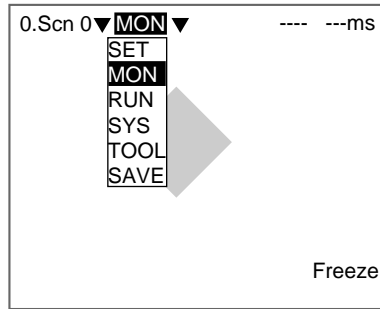

2. Select **MON** to enter Monitor Mode.

2-4-7-2 Test Measurement

Use the following procedure to execute measurements according to the conditions set for the scene currently displayed. The test is completed internally by the F160 and the measurement results are not output via serial or parallel interfaces. The measurement commands can be input, however, via serial or parallel interfaces.

SeeAlso Refer to the *Communications Reference Manual* for details.

1. Press the **TRIG** Key on the Console or input the measurement command from an external device.

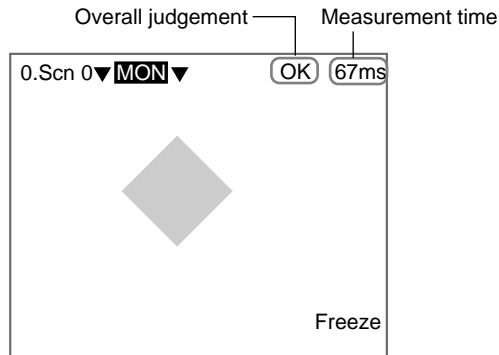

Measurement will be executed and the measurement results displayed on the screen.

Measurement Time

The time taken for the measurement will be displayed.

CHECK Compared to freeze displays, the measurement time for through displays will be up to 20 ms longer for frames and 10 ms longer for fields when F160-S1, F160-S2 Cameras are used.

Overall Judgement

The overall judgement will be NG if there is an NG in one or more measurement regions, position compensations, or output expressions.

CHECK The items to be included in the overall judgement can be set individually. Refer to page 323.

TwoCamera If the camera mode is Camera 0+1, switch between Camera 0 images and Camera 1 images by pressing the Up/Down Keys. Refer to page 33.

CHECK Press the SHIFT + Up/Down Keys to display the stored images in order. Refer to page 319.

Camera 0 image

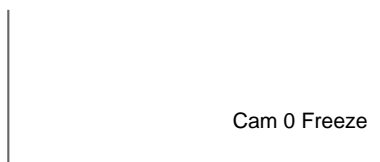

Camera 1 image

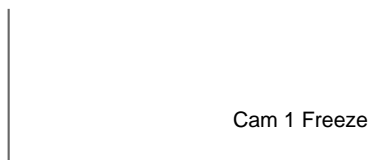

CHECK Measurement images can be stored. Up to 35 screens can be stored in memory. Once 35 screens have been stored, the existing screens will be overwritten in order starting with the oldest. Move to *SYS/Measurement control* and change the conditions for *Image storage*. To store NG images only, select *Only NG*, and to store images regardless of the judgement result, select **All**. Refer to page 318.

CHECK Measurement can be repeated for stored images. Display the desired stored image using the SHIFT+Up/Down Keys and press SHIFT+TRIG Keys to execute measurement. Measurement can also be repeated for freeze images without re-inputting the image using the SHIFT+TRIG Keys. This feature can be used after judgement conditions have been changed to check that the new conditions are appropriate.

2-4-7-3 Changing Display Results

The information displayed on the screen can be changed. The judgement conditions can be changed while monitoring detailed measurement values.

This section gives an outline only. Refer to *SECTION 6 System Settings* (page 300) for details.

1. Press the **SHIFT+ESC** Keys.

The Display Settings Screen will be displayed.

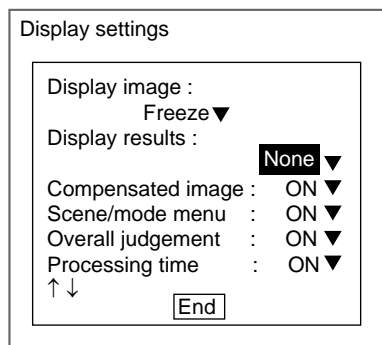

2. Move the cursor to *Display results* and press the **ENT** Key.

Change the settings as required.

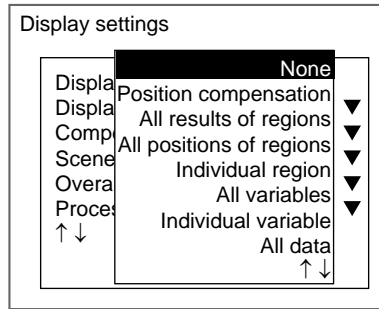

2-5 Run Mode

2-5-1 Entering Run Mode

You can test whether or not correct measurement can be performed with the set measurement conditions.

CHECK The key allocations for the Console Keys can be changed from *MON* and *RUN* screens. In the following explanation, it is assumed that the key allocations are at the default settings. If they are not, adapt the procedure accordingly. Refer to page 309.

1. Move the cursor to **MON** and press the **ENT** Key.

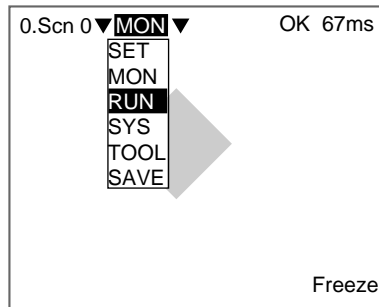

2. Select **RUN** to enter Run Mode.
The mode selections will be displayed.

2-5-2 Performing Measurement

Use the following procedure to execute measurement according to the conditions set for the scene currently displayed. The measurement results will be output to external devices as well.

Press the **TRIG** Key on the Console or input the measurement command from an external device.

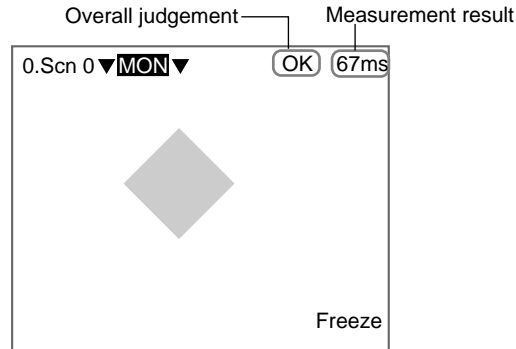

Measurement will be executed and the measurement results will be displayed on the screen.

Measurement Time

The time taken for the measurement will be displayed.

CHECK Compared to freeze display, the measurement time for through display will be up to 20 ms longer for frames and 10 ms longer for fields when F160-S1, F160-S2 Cameras are used.

Overall Judgement

The overall judgement will be NG if there is an NG in one or more measurement regions, position compensations, or output expressions.

CHECK The items to be included in the overall judgement can be set individually. Refer to page 323.

CHECK Various commands can be input from an external device in addition to the measurement command.

Input Commands

Via the parallel interface (Refer to the *Communications Reference Manual*.)

Via the serial interface port using normal communications (Refer to the *Communications Reference Manual*.)

Via the serial interface port using Host Link communications (Refer to the *Communications Reference Manual*.)

CHECK Measurement results can also be output to external devices.

Output Formats

Via the parallel interface (Refer to the *Communications Reference Manual*.)

Via the serial interface port using normal communications (Refer to the *Communications Reference Manual*.)

Via the serial interface port using Host Link communications (Refer to the *Communications Reference Manual*.)

CHECK Measured images can be stored. Up to 35 screens can be stored in memory. Once 35 screens have been stored, the existing screens will be overwritten in order starting with the oldest. Move to *SYS/Measurement control* and change the conditions for *Image storage*. To store NG images only, select *Only NG*, and to store images regardless of the judgement result, select **All**. Refer to page 318.

- CHECK** Measurement can be repeated for stored images. Display the desired stored image using the SHIFT+Up/Down Keys and press SHIFT+TRIG Keys to execute measurement. Measurement can also be repeated for freeze images without re-inputting the image using the SHIFT+TRIG Keys. This feature can be used after evaluation conditions have been changed to check that the new conditions are appropriate.
- CHECK** To display detailed measurement values on the screen, press the **SHIFT+ESC** Keys and change the settings. Refer to page 301.
- CHECK** The lighting will become progressively darker if used for long periods. Make periodic adjustments to the evaluation conditions. When Intelligent Lighting is used, the lighting will lose approximately 20% illumination after 1,500 hours of use.

2-6 Saving Settings and Exiting the F160

Save settings to flash memory before turning the power OFF.

Precaution

Flash memory data is loaded each time the F160 is started. Therefore, when settings have been changed, be sure to save then to flash memory before turning OFF the power. If the power is turned OFF without saving new settings, all of the setting changes will be lost. Stored images cannot be saved to flash memory so all stored images will be cleared when the power is turned OFF. If you want to keep stored images, backup the images to a personal computer or Memory Card. Refer to page 266.

1. Display the Basic Screen for Monitor Mode or Run Mode.

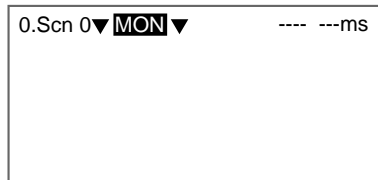

2. Move the cursor to **MON** (or **RUN**) and press the **ENT** Key. The mode selections will be displayed.

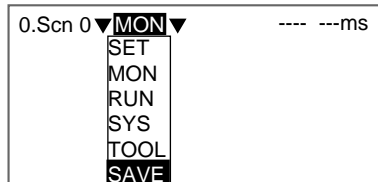

3. Select **SAVE**. A confirmation message will be displayed.

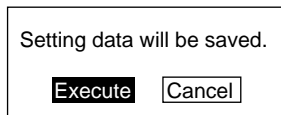

4. Select **Execute**.

Precaution

Do not turn OFF the power or input a RESET signal while a message is being displayed in any save or load operation. Data in memory will be destroyed, and the F160 may not operate correctly the next time it is started.

Once the setting data has been saved, the screen in (1.) return.

5. Turn OFF the power to exit the F160.

CHECK When Using the Scene Group Function
The scene data set to Scene Group 0 and the system data will be saved to flash memory. The settings data for Scene Groups 1 to 31 will be overwritten to the Memory Card when this save operation is executed.

SECTION 3

Selecting and Setting Measurement Methods

The Expert Menu provides 17 different measurement methods. The gravity and area measurement method was already used as an example in *Setting Inspection Conditions, Step 4 Measurement Regions* in *Section 2 Basic Operations*. This section explains the other 16 measurement methods.

3-1	Area (Variable Box)	70
3-1-1	STEP 1: Setting the Binary Level	70
3-1-2	STEP 2: Using the Fill Profile Function (Setting Judgement Conditions)	71
3-1-3	STEP 3: Drawing the Measurement Region	72
3-1-4	STEP 4: Registering Reference Values	78
3-1-5	STEP 5: Setting Judgement Conditions	79
3-1-6	STEP 6: Setting Pixel Skipping	80
3-1-7	STEP 7: Setting the Coordinate Mode	81
3-2	Defect (Variable Box)	82
3-2-1	STEP 1: Setting Measurement Conditions	82
3-2-2	STEP 2: Drawing the Measurement Region	84
3-2-3	STEP 3: Registering Reference Values	88
3-2-4	STEP 4: Setting Judgement Conditions	89
3-2-5	STEP 5: Changing Detection Conditions	90
3-2-6	STEP 6: Setting the Coordinate Mode	91
3-3	Gravity and Axis	92
3-3-1	STEP 1: Setting the Binary Level	92
3-3-2	STEP 2: Drawing Measurement Regions	94
3-3-3	STEP 3: Re-registering Reference Values	96
3-3-4	STEP 4: Setting Judgement Conditions	97
3-3-5	STEP 5: Setting Pixel Skipping	98
3-3-6	STEP 6: Setting the Coordinate Mode	99
3-4	OCR for 1 Character	100
3-4-1	STEP 1: Setting Measurement Conditions	101
3-4-2	STEP 2: Drawing Measurement Regions	102
3-4-3	STEP 3: Setting Judgement Conditions	103
3-5	Classification	104
3-5-1	STEP 1: Registering Models	104
3-5-2	STEP 2: Setting Search Regions	108
3-5-3	STEP 3: Setting Judgement Conditions	109
3-5-4	STEP 4: Changing Detailed Conditions	110
3-5-5	STEP 5: Setting the Coordinate Mode	113

3-6	Surface Defects	114
3-6-1	STEP 1: Drawing the Measurement Region	114
3-6-2	STEP 2: Re-registering Reference Values.	116
3-6-3	STEP 3: Setting the Judgement Conditions	117
3-6-4	STEP 4: Changing Detection Conditions	118
3-6-5	STEP 5: Setting the Coordinate Mode	119
3-7	Density Data	119
3-7-1	STEP 1: Drawing Measurement Regions	120
3-7-2	STEP 2: Setting Judgement Conditions	122
3-8	Edge Pitch	123
3-8-1	STEP 1: Setting the Edge Detection Conditions.	123
3-8-2	STEP 2: Drawing Measurement Regions	124
3-8-3	STEP 3: Setting Judgement Conditions	126
3-8-4	STEP 4: Changing Detailed Conditions	127
3-8-5	STEP 5: Setting the Coordinate Mode	128
3-9	Edge Position.	128
3-9-1	STEP 1: Setting Edge Detection Conditions.	129
3-9-2	STEP 2: Drawing Measurement Regions	130
3-9-3	STEP 3: Re-registering Reference Values.	131
3-9-4	STEP 4: Setting Judgement Conditions	132
3-9-5	STEP 5: Changing Detailed Conditions	133
3-9-6	STEP 6: Monitoring the Density Distribution Near Edges	134
3-9-7	STEP 7: Setting the Coordinate Mode	136
3-10	Edge Width	137
3-10-1	STEP 1: Setting Edge Detection Conditions.	138
3-10-2	STEP 2: Drawing Measurement Regions	139
3-10-3	STEP 3: Re-registering Reference Value	140
3-10-4	STEP 4: Setting Judgement Conditions	142
3-10-5	STEP 5: Changing Detailed Conditions	142
3-10-6	STEP 6: Monitoring the Density Distribution Near Edges	143
3-10-7	STEP 7: Setting the Coordinate Mode	145
3-11	Gray Search and Precise Search	147
3-11-1	STEP 1: Registering the Model.	147
3-11-2	STEP 2: Changing the Search Coordinates.	149
3-11-3	STEP 3: Setting the Search Region.	150
3-11-4	STEP 4: Setting Judgement Conditions	151
3-11-5	STEP 5: Changing Detailed Conditions	153
3-11-6	STEP 6: Referencing the Model	154

3-11-7	STEP 7: Setting the Coordinate Mode	154
3-12	Flexible Search	155
3-12-1	STEP 1: Registering Models	156
3-12-2	STEP 2: Setting Search Regions	159
3-12-3	STEP 3: Setting Judgement Conditions	160
3-12-4	STEP 4: Changing Detailed Conditions	161
3-12-5	STEP 5: Setting the Coordinate Mode	162
3-13	Labeling	163
3-13-1	STEP 1: Setting the Binary Level	163
3-13-2	STEP 2: Setting Measurement Conditions	165
3-13-3	STEP 3: Drawing Measurement Regions	166
3-13-4	STEP 4: Re-registering Reference Values	169
3-13-5	STEP 5: Setting Judgement Conditions	170
3-13-6	STEP 6: Setting the Coordinate Mode	171
3-14	Relative Search	172
3-14-1	STEP 1: Setting Measurement Conditions	172
3-14-2	STEP 2: Setting Judgement Conditions	178
3-14-3	STEP 3: Changing Detailed Conditions	179
3-14-4	STEP 4: Setting the Coordinate Mode	180
3-15	Rotation Search	180
3-15-1	STEP 1: Setting Measurement Conditions	181
3-15-2	STEP 2: Registering a Model	183
3-15-3	STEP 3: Changing the Search Coordinates	185
3-15-4	STEP 4: Setting Search Regions	186
3-15-5	STEP 5: Setting Judgement Conditions	187
3-15-6	STEP 6: Changing Detailed Conditions	188
3-15-7	STEP 7: Setting the Coordinate Mode	189

3-1 Area (Variable Box)

The area (variable box) measurement method measures the area and center of gravity while following the measurement region to suit measurement objects with inconsistent sizes and positions.

First, the upper, lower, left, and right edges of the measurement object are located. The area within the edges becomes the measurement region. The location of the measurement object can be determined using the edge detection points so the measurement region can be adapted to suit if the size or position of the measurement object changes.

Once the edges have been located, the image is converted to binary and the area and center of gravity of the measurement region is measured.

SeeAlso Refer to page 6.

Operational Flow

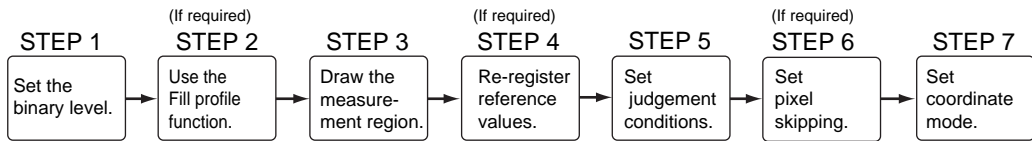

3-1-1 STEP 1: Setting the Binary Level

Set the level for converting 256-gradation images into binary images. The F160 performs measurement for the white pixels. Therefore, make the settings so that the measurement object is white.

1. Select **Measurement**/**<Region number>/Area (var.box)**.

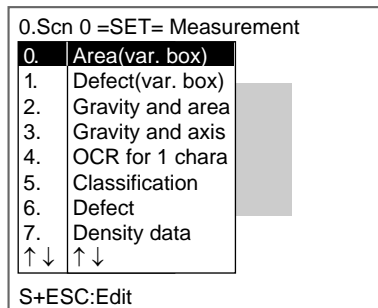

The initial screen for Area (var. box) will be displayed.

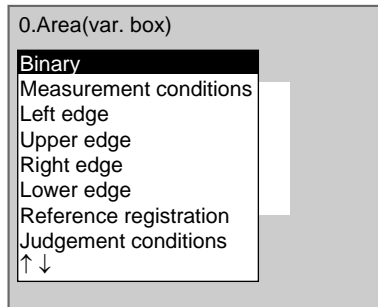

2. Select **Binary**.

The Binary Settings Screen will be displayed.

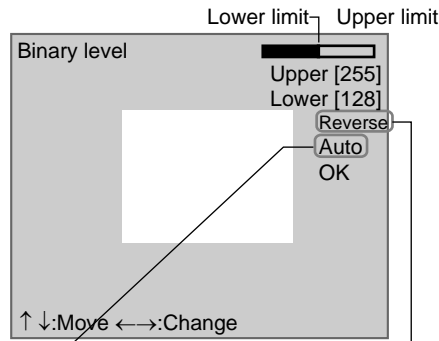

Auto Reverse
 The F160 automatically Reverses black and
 sets the binary level white in the display

3. Move the cursor to the upper limit and use the **Left** and **Right** Keys to change the value.
 Right Key: Increases the lowest digit by one.
 SHIFT+Right Keys: Increases the value in 10s.
 Left Key: Decreases the lowest digit by one.
 SHIFT+Left Keys: Decreases the value in 10s.
 Up and Down Keys: Switches between setting items.
4. Use the same method to change the lower value.

CHECK

Set the upper and lower limits to make the measurement object white.

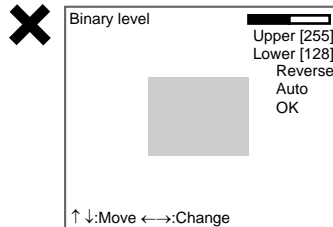

5. Select **OK**.
 The settings will be registered and the screen in (2.) will return.

CHECK

It is also possible to set the binary level so that measurement is performed only for an intermediate density range.

3-1-2 STEP 2: Using the Fill Profile Function (Setting Judgement Conditions)

The fill profile function is set when the exterior of the measurement object is being measured.

Turn ON the fill profile function to measure the whole area between the start point (black pixels to white) and the end point (white pixels to black) in the measurement region as white pixels. The default setting for this function is OFF.

SeeAlso

Refer to page 52 for information on the fill profile function.

1. Select **Measurement conditions**.

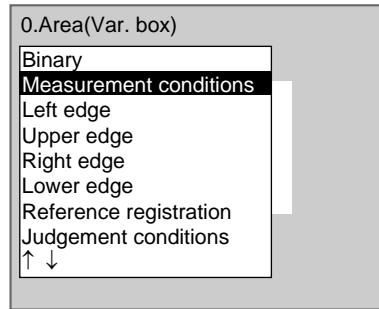

The screen for setting the measurement conditions will be displayed.

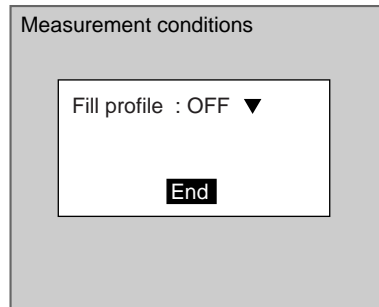

2. Select either **ON** or **OFF**.
3. Select **End**.

The setting will be registered and the screen in (1.) will return.

3-1-3 STEP 3: Drawing the Measurement Region

The measurement region is drawn by specifying the upper, lower, left, and right edges of the measurement object. If even one of the edges cannot be located, the judgement result will be NG.

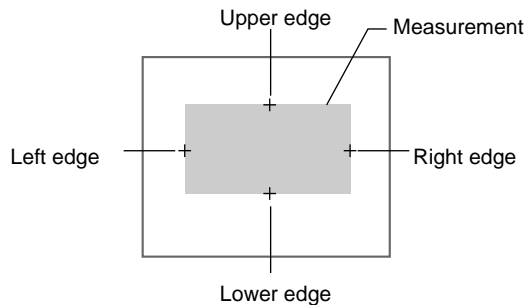

When one of the edges is selected, the settings for the conditions for the selected edge will be displayed. In this example, the settings for the left edge will be explained. Make adjustments as necessary when setting conditions for the upper, lower, and right edges.

1. Set the edge detection conditions.
Set the direction for the edge search and the density changes.

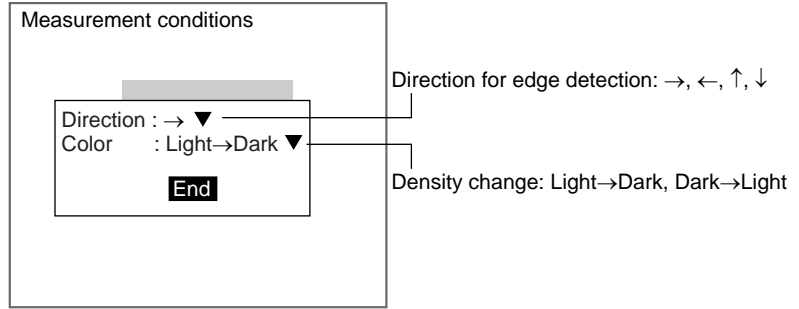

CHECK

Combining Edge Detection Directions
Set a combination of upper, lower, right, and left edge detection directions that surround the area to be measured.

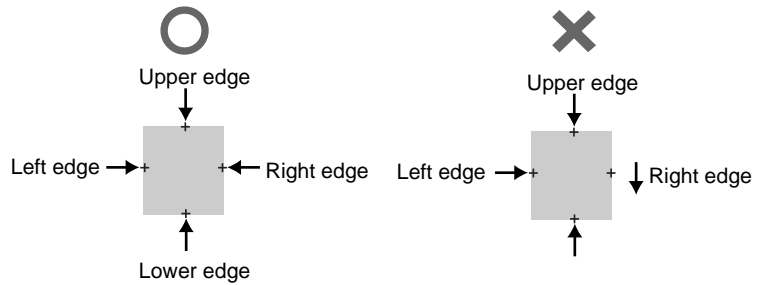

- a) Select **Left edge**.

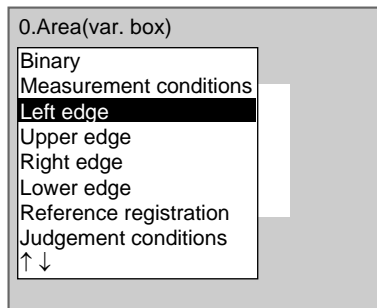

The initial screen for the left edge will be displayed.

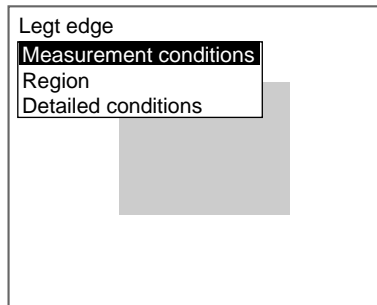

- b) Select **Measurement conditions**.

The Measurement Conditions Settings Screen will be displayed.

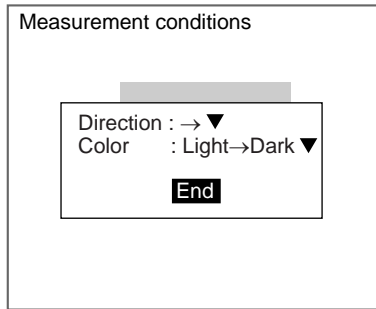

- c) Select the detection conditions for the left edge.
- d) Select **End**.

The settings will be registered and the screen in (2.) will return.

- 2. Drawing the Edge Detection Region
Draw a region that includes the edge.

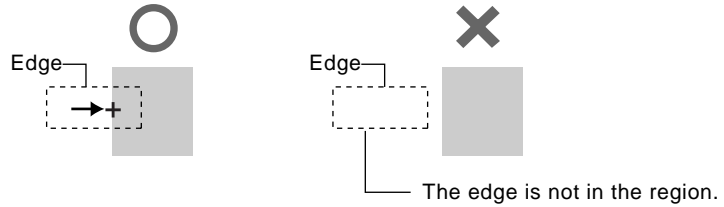

- a) Select **Region**.

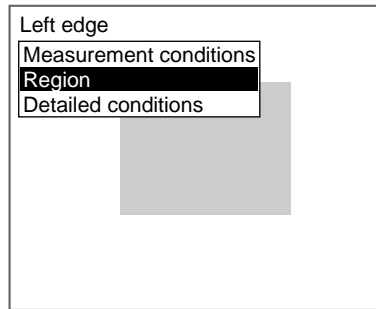

The Region Settings Screen will be displayed.

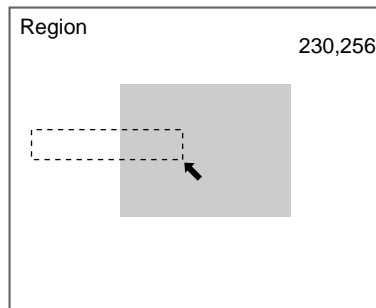

- b) Draw a box-shaped region.

CHECK

The only figure that can be drawn is a box. Refer to page 28.

When the bottom right coordinates are specified, the region will be set and the screen in (1.) will return.

CHECK Use the following procedure to fix the region.

Measurement Objects with Variable Widths Only

Draw the edge detection region so that the measurement region Y coordinates will remain the same for both the upper and lower edges. The upper and lower edges will always have these edge points.

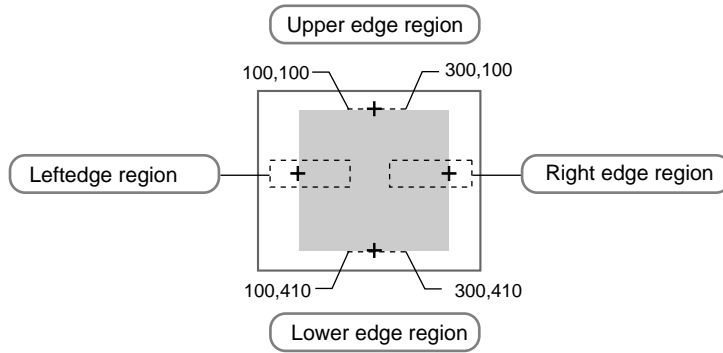

The measurement region will adjust to the right and left edges only before measurement is performed.

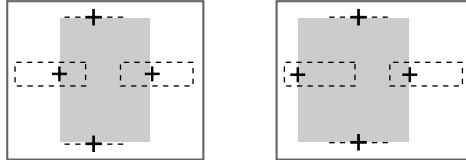

Measurement Objects with Variable Heights Only

Draw the edge detection region so that the measurement region X coordinates will remain the same for both the left and right edges. The left and right edges will always have these edge points.

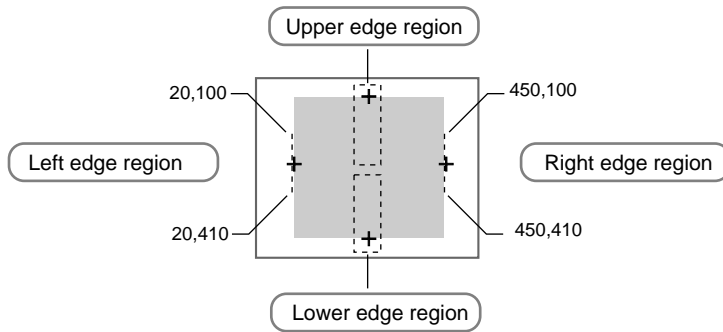

The measurement region will adjust to the upper and lower edges only before measurement is performed.

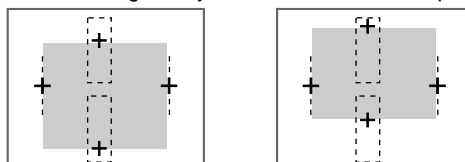

3. Changing Detailed Conditions as Required

Change the detailed conditions when the measurement results are unstable. Change and set the edge level, noise level, noise width, and offset width as required. (Normally, these four conditions can be left on the default settings.) After changing the settings, perform an object measurement to check that measurement can still be performed correctly.

a) Select **Detailed conditions**.

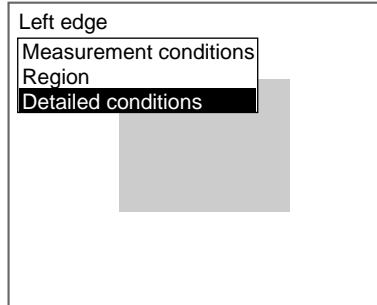

The Detailed Conditions Settings Screen will be displayed.

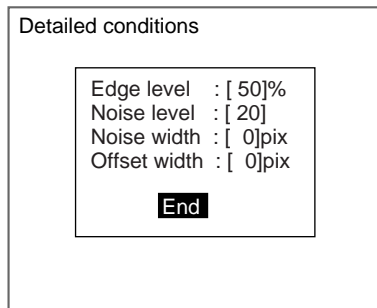

b) Move the cursor to the condition to be changed and change the setting.

SeeAlso

Refer to page 29 for details on inputting values.

c) Select **End**.

The settings will be registered and the screen in (1.) will return.

Press the **ESC** Key to return to the initial screen for Area (var. box).

Edge Level

Set a density change level between 0 and 100 that will indicate the edge. Normally, the default setting of 50% will be fine.

The edge is normally detected as follows:

1. The density distribution of the whole measurement region is calculated.
2. The density difference between the lowest and highest density value becomes 100%.

- The point where the edge level density change is detected becomes the edge.

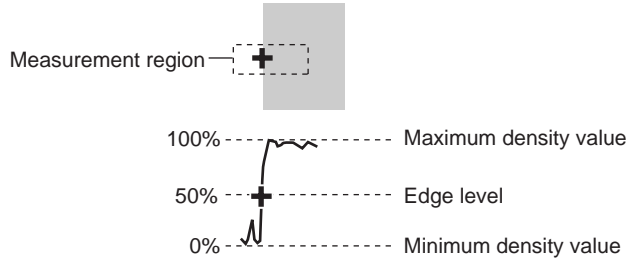

Noise Level

Set a noise level between 0 and 255 to assist the determination of edges. The maximum density and minimum density within the edge detection area is calculated and if the difference between the two values is less than the noise level, then the F160 determines that there is no edge. Normally the default setting of 20 is sufficient. Adjust this to a higher value, however, if noise is causing false edges to be detected.

(Within the edge detection region)

Max. density - min. density < noise level → no edge → NG measurement result

Max. density - min. density ≥ noise level → Edge → Used for measurement

Example: When noise level is set to 30

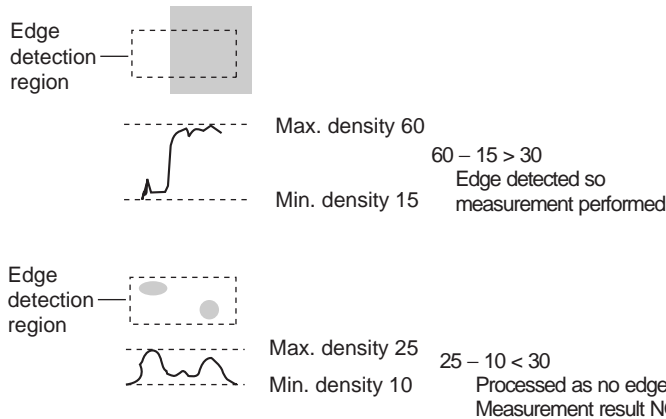

Noise Width

Set the noise width between 0 and 255 to evaluate noise.

If the density distribution from the position where the edge was first detected falls to below the edge level within the noise width range, the detected point is judged as noise. Normally the default noise width setting of 0 is sufficient. If noise is causing incorrect detection, make this value higher.

Example

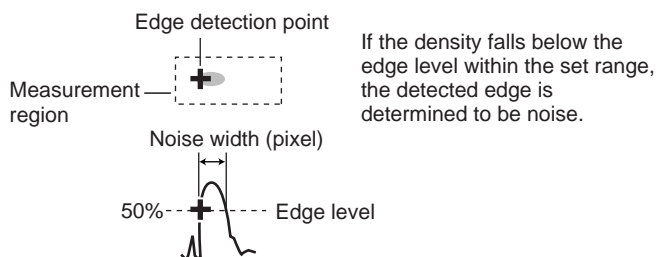

Offset Width

Set the adjustment width (in pixel units) for the detected edge position. Set a value between -511 and 511.

The default setting is 0, which means measurement will start from position where the edge is detected.

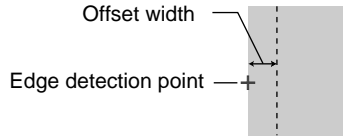

Left and right edges: Set the offset width on the X axis.

Upper and lower edges: Set the offset width on the Y axis.

Example: To Measure from 2 Pixel-widths Inside the Edge Detection Point

The value inside the brackets is the offset width.

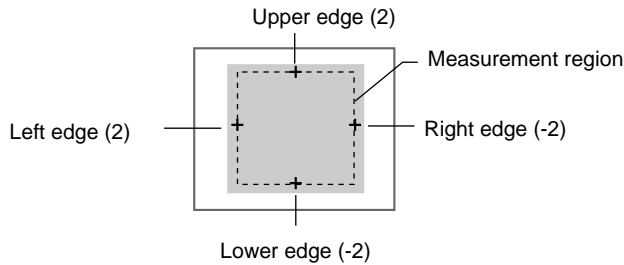

CHECK The display cursor, which indicates the edge detection point, will also appear at the set offset width position.

3-1-4 STEP 4: Registering Reference Values

When detecting differences from an acceptable product, reference values must be registered. Place the acceptable product in the correct position and register the reference values.

The area and center of gravity are registered for the reference values.

CHECK The reference values can be changed to enable the following function.

Inspecting Positions from a Specified Point

Once the reference values (area and center of gravity) have been obtained for the image currently displayed, the reference position is changed to a suitable point. Position inspection can be performed by calculating the difference between this reference position and the measurement position.

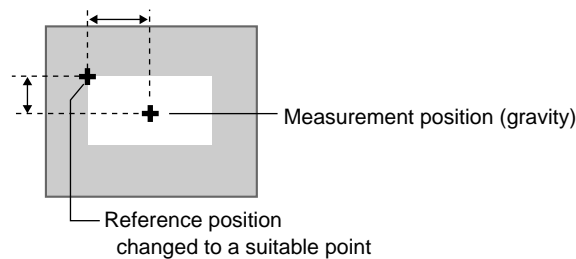

1. Select **Reference registration**.

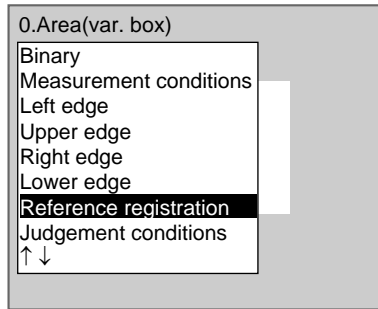

A cursor will appear at the position of the center of gravity.

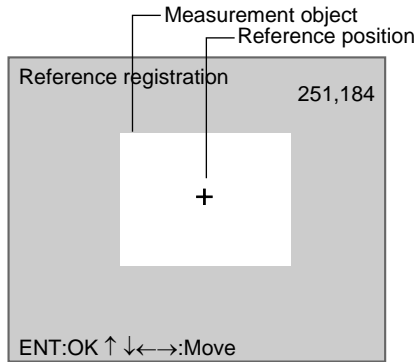

2. To change the position, use the **Up/Down** and **Right/Left** Keys to move the cursor.
3. Press the **ENT** Key to confirm the setting.
The setting will be registered and the screen in (1.) will return.

3-1-5 STEP 5: Setting Judgement Conditions

Make settings for the area and center of gravity.

Judgement conditions

Area : 2035.000
[2000.000 : 247808.000]

Gravity X : 180.000
[0.000 : 511.000]

Gravity Y : 250.000
[0.000 : 483.000]

End

● Range for an OK judgement.

— Area range (0 to 9,999,999.999)

— Range of movement of the measurement object in the X direction (–9,999.999 to 9,999.999)

— Range of movement of the measurement object in the Y direction (–9,999.999 to 9,999.999)

○: Measurement results for the displayed image.
Use these values as a reference for setting upper and lower limits.

1. Select **Judgement conditions**.

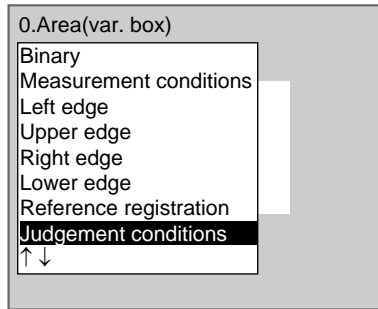

The Judgement Conditions Settings Screen will be displayed.

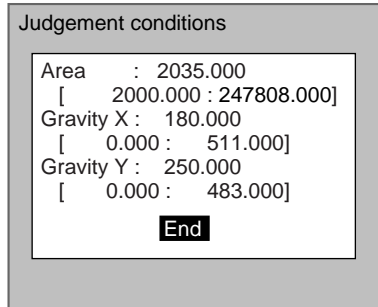

2. Change the settings.

SeeAlso

Refer to page 29 for details on inputting values.

3. Select **End**.

The settings will be registered and the screen in (1.) will return.

3-1-6 STEP 6: Setting Pixel Skipping

To shorten measurement processing time, change the number of pixels to be skipped. The greater the skipping setting, the shorter the processing time. However, the accuracy of the measurement will decrease.

Once the skipping setting has been changed, perform measurements to check that they can be performed correctly.

Skipping X and Skipping Y

Set how many pixels to skip in the measurement region during measurement. The default setting is 1, which means that all of the measurement region will be measured.

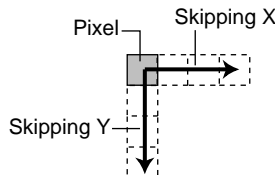

1. Select **Detailed conditions**.

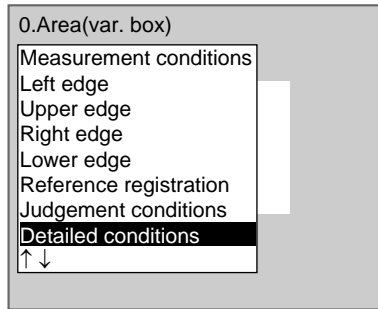

The Detailed Conditions Settings Screen will be displayed.

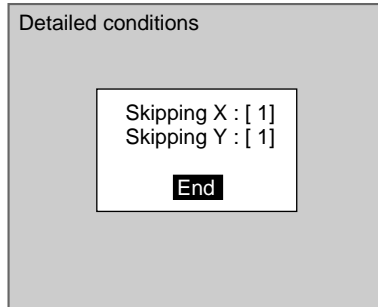

2. Set the number of pixels to skip.

SeeAlso

Refer to page 29 for details on inputting values.

3. Select **End**.

The setting will be registered and the screen in (1.) will return.

3-1-7 STEP 7: Setting the Coordinate Mode

Select the type of coordinates.

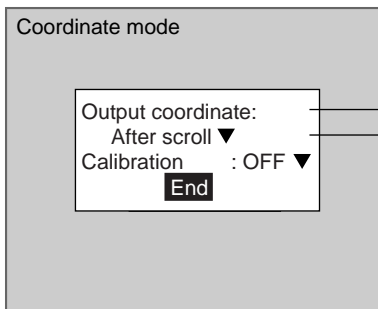

Before scroll: Output made using the coordinate values before position displacement compensation.

After scroll*: Output made using the coordinate values after position displacement compensation.

Refer to page 205 for position compensation.

Refer to page 330 for differences between output coordinates.

ON : Output made using coordinate values set using calibration.

OFF*: Output made using Camera coordinate values.

Refer to page 193 for information on calibration.

The default settings are marked with asterisks.*

CHECK

If the coordinate mode is changed after the judgement conditions have been set, the measurement results will change also. Change the judgement conditions to enable correct measurement.

1. Select **Coordinate mode**.

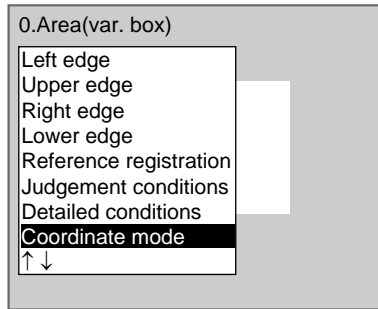

The Coordinate Mode Settings Screen will be displayed.

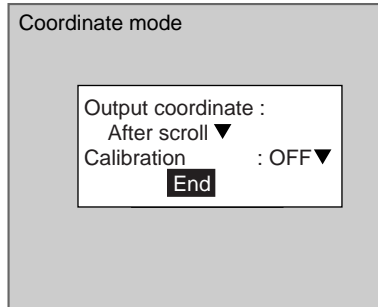

2. Make the settings for each item.
3. Select **End**.

The settings will be registered and the screen in (1.) will return.

3-2 Defect (Variable Box)

The defect (variable box) measurement method measures the area and center of gravity while adapting the measurement region to suit measurement objects with inconsistent sizes and positions.

First, the upper, lower, left, and right edges of the measurement object are located. The area within the edges becomes the measurement region. The location of the measurement object can be determined using the edge detection points so the measurement region can be adapted to suit if the size or position of the measurement object changes.

SeeAlso Refer to page 6.

Operational Flow

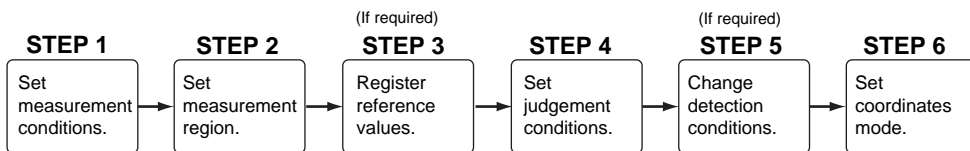

3-2-1 STEP 1: Setting Measurement Conditions

The F160 detects the defect position using density variations in the measurement region.

This section shows how to select the direction for calculating density changes in the measurement region.

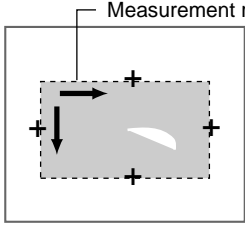
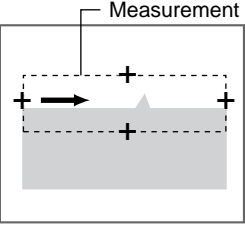
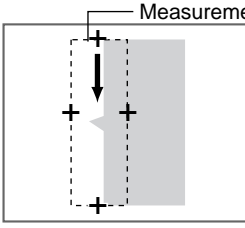
Measurement direction	Application
<p>X and Y directions</p>	<p>Select to detect the defects for the whole measurement region. Calculates the variation in density in the X-axis and Y-axis directions.</p> 
<p>X direction</p>	<p>Select to detect defects or burrs in the upper or lower section of the measurement region. Refer to page 86. Calculates the variation in density on the X axis.</p> 
<p>Y direction</p>	<p>Select to detect defects or burrs in the right or left section of the measurement region. Refer to page 87. Calculates the variation in density on the Y axis.</p> 

1. Select **Measurement**/*<Region number>*/**Defect (var. box)**.

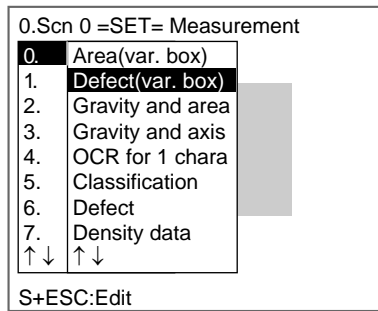

The initial screen for Defect (var. box) will be displayed.

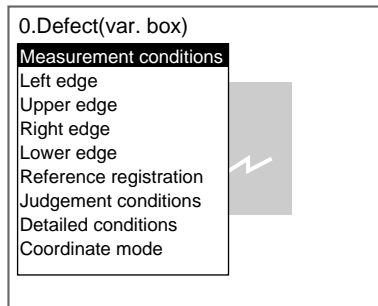

2. Select **Measurement conditions**.

The Measurement Conditions Settings Screen will be displayed.

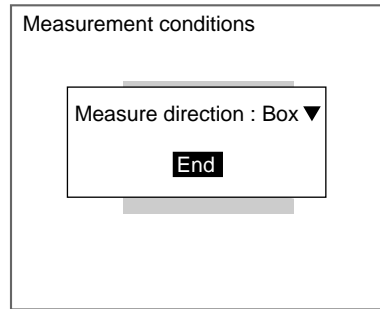

3. Select the measurement direction.
4. Select **End**.

The setting will be registered and the screen in (2.) will return.

3-2-2 STEP 2: Drawing the Measurement Region

The measurement region is drawn by specifying the upper, lower, left, and right edges of the measurement object. If even one of the edges cannot be located, the judgement result will be NG.

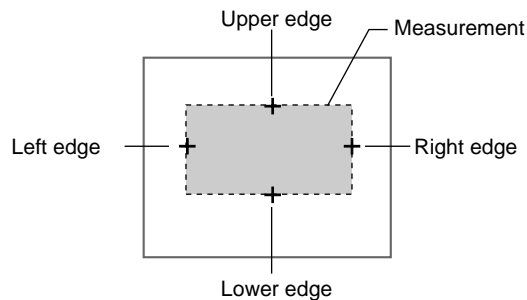

When one of the edges is selected, the settings for the conditions for the selected edge will be displayed. In this example, the settings for the left edge will be explained. Make adjustments as necessary when setting conditions for the upper, lower, and right edges.

1. Set the edge detection conditions.
Set the direction for the edge search and the density changes.

SeeAlso

Refer to page 72 *Area (Variable Box) STEP 3* for information on setting edge detection conditions.

- a) Select **Left edge**.

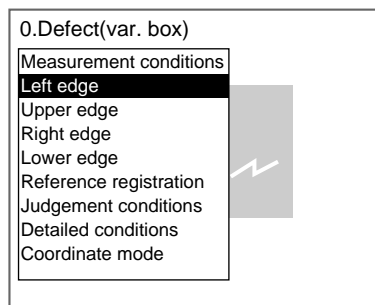

The initial setting screen for the left edge will be displayed.



- b) Select **Measurement conditions**.

The Measurement Conditions Settings Screen will be displayed.

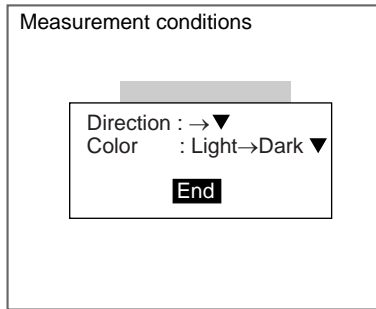

- c) Select the detection conditions for the left edge.
- d) Select **End**.

The settings will be registered and the screen in (2.) will return.

- 2. Drawing the Edge Detection Region
Draw a region that includes the edge.

SeeAlso

Refer to page 72 *Area (Variable Box) STEP 3* for information on drawing edge detection regions.

- a) Select **Region**.

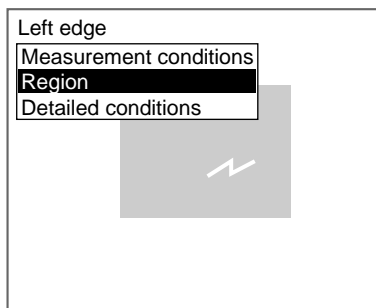

The Region Settings Screen will be displayed.

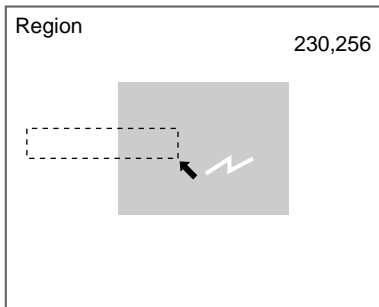

b) Draw a box-shaped region.

CHECK

The only figure that can be drawn is a box. Refer to page 28.

CHECK

Draw the region so that it includes the edge.

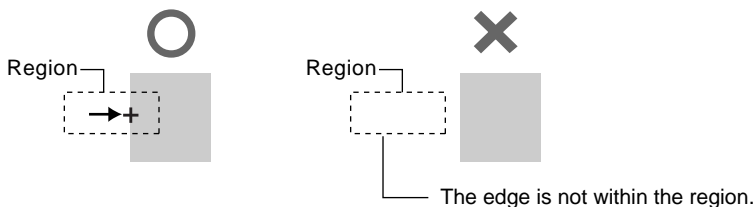

When the bottom right coordinates are specified, the region will be set, and the screen in (1.) will return.

CHECK

Use the following procedure to fix the measurement region.

- To measure defects in measurement objects with variable widths only, refer to page 75.
- To measure defects in measurement objects with variable heights only, refer to page 75.
- To Measure Defects and Burrs in the Upper Section of Measurement Regions with Variable Widths Only.

Draw the edge detection region so that the measurement region Y coordinates will remain the same for both the upper and lower edges. The upper and lower edges will always have these edge points.

Note Specify X line under *Measurement conditions/measurement direction*.

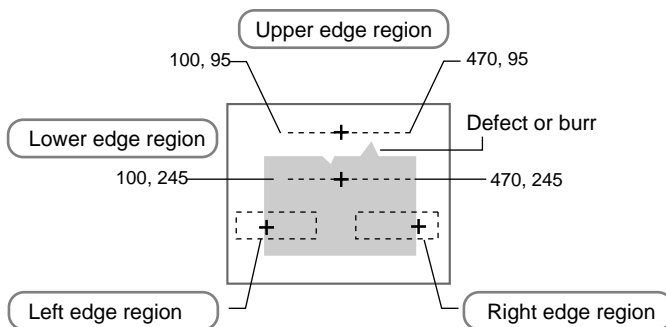

- To Measure Defects and Burrs in the Left Section of Measurement Regions with Variable Heights Only.

Draw the edge detection region so that the measurement region X coordinates will remain the same for both the left and right edges. The left and right edges will always have these edge points.

Note Specify *Y line* under *Measurement conditions/measurement direction*.

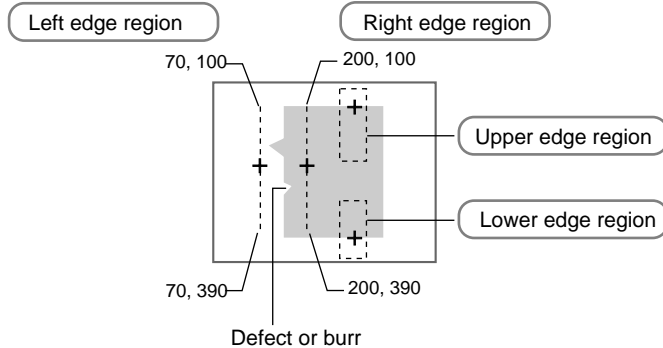

3. Changing Detailed Conditions as Required
Change the detailed conditions when the measurement results are unstable. (Normally, these conditions can be left on the default settings.) After changing the settings, perform an object measurement to check that measurement can still be performed correctly.

SeeAlso

Refer to page 72 *Area (Variable Box) STEP 3* for information on changing the detailed conditions as required.

- a) Select **Detailed conditions**.

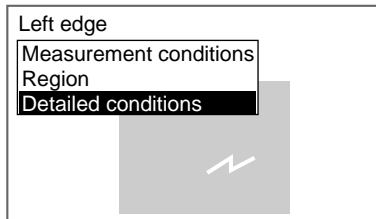

The Detailed Conditions Settings Screen will be displayed.

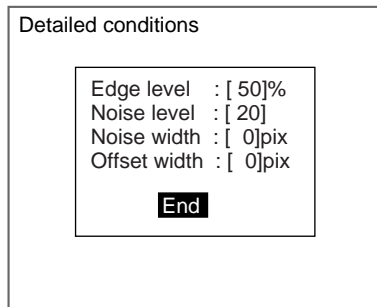

- b) Move the cursor to the condition to be changed and change the setting.

SeeAlso

Refer to page 76 for information on edge levels, noise levels, noise width, and offset width.

SeeAlso

Refer to page 29 for details on inputting values.

- c) Select **End**.

The settings will be registered and the screen in (1.) will return.

Press the **ESC** Key to return to the initial screen for Defect (var. box).

3-2-3 STEP 3: Registering Reference Values

The algorithms used to detect defects can be used for position detection. Register reference values when performing position detection. The X and Y coordinates of the position detected as a defect are registered for the reference values.

Example: Inspecting Whether or Not the Measurement Object Is Always in the Same Position

Display a measurement object in the correct position, detect a mark, and register that position as the reference position.

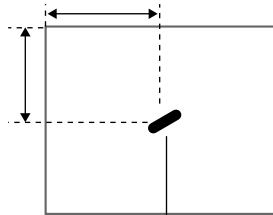

Register the detected mark as the reference position.

CHECK

The reference position can be changed to enable the following function.

Inspecting Positions from a Specified Point

After a mark has been detected for the image currently displayed, the reference position is changed to a suitable point. Position inspection can be performed by calculating the difference between this reference position and the measurement position.

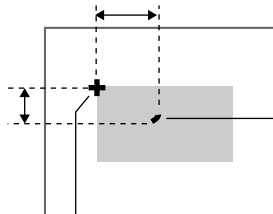

Measurement position (mark detected as a defect)

Reference position (changed to a suitable point)

1. Select **Reference registration**.

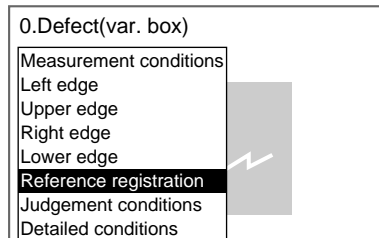

A cursor will appear at the position of the defect.

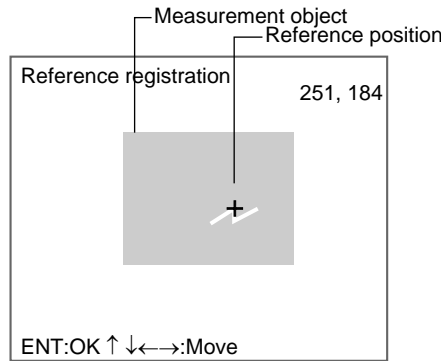

2. To change the position, use the **Up/Down** and **Right/Left** Keys to move the cursor.
3. Press the **ENT** Key to confirm the setting.
The setting will be registered and the screen in (1.) will return.

3-2-4 STEP 4: Setting Judgement Conditions

Set the conditions for determining defects. Set a value between 0 and 255 as the OK judgement value. Measure several samples and set the judgement conditions while referring to the measurement results.

1. Select **Judgement conditions**.

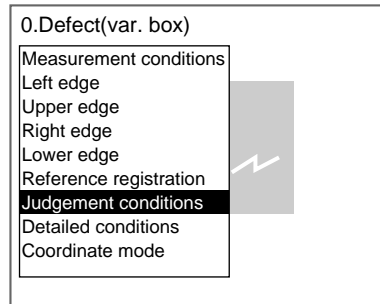

The Judgement Conditions Settings Screen will be displayed.

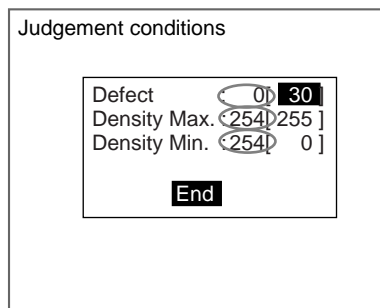

○: Measurement result for the displayed image.
Use this value as a reference for setting upper and lower limits.

2. Change the settings.

SeeAlso

Refer to page 29 for details on inputting values.

3. Select **End**.

The settings will be registered and the screen in (1.) will return.

3-2-5 STEP 5: Changing Detection Conditions

To shorten measurement processing time, change the conditions for detecting defects. The greater the element size and comparing pitch, the shorter the processing time. However, the accuracy of the measurement will decrease.

Once the element size or comparing pitch setting has been changed, perform measurements to check that they can be performed correctly.

1. Select **Detailed conditions**.

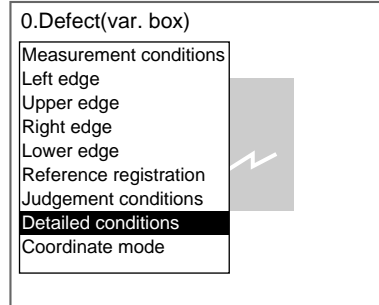

The Detailed Conditions Settings Screen will be displayed.

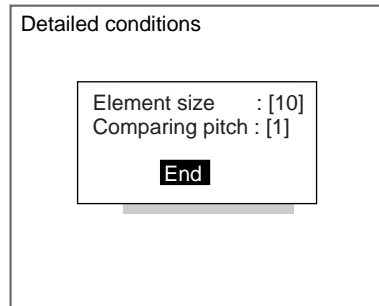

2. Set the element size and comparing pitch.

SeeAlso

Refer to page 29 for details on inputting values.

3. Select **End**.

The settings will be registered and the screen in (1.) will return.

HELP

Element Size and Comparing Pitch

When the measurement region has been drawn, small boxes will be created inside the measurement region. These boxes are called elements. The density for each element is calculated, and this density is compared with the density of the elements around it. The degree of differences in the density is used to detect surface defects.

Example: Measurement Performed in X Direction

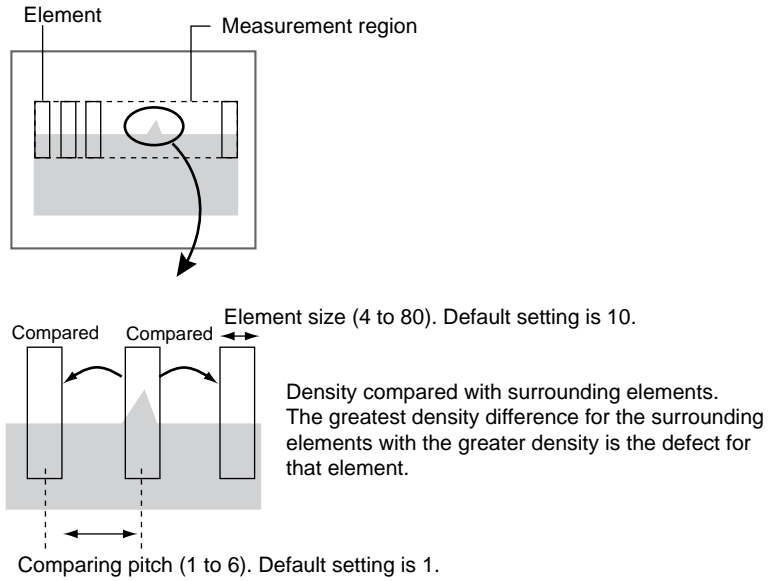

CHECK

Method for Judging Defects

The defect values for all elements are calculated. If the largest defect value is equal to or greater than the judgement condition, a defect will be detected for that measurement region.

3-2-6 STEP 6: Setting the Coordinate Mode

Select the type of coordinates.

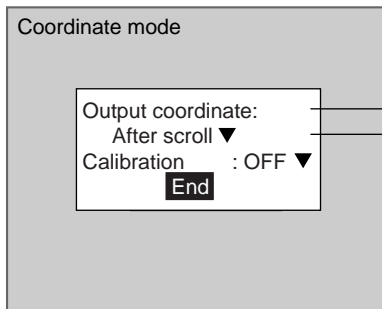

Before scroll: Output made using the coordinate values before position displacement compensation.
 After scroll*: Output made using the coordinate values after position displacement compensation.
 Refer to page 205 for position compensation.
 Refer to page 330 for differences between output coordinates.
 ON : Output made using coordinate values set using calibration.
 OFF*: Output made using Camera coordinate values.
 Refer to page 193 for information on calibration.

The default settings are marked with asterisks.*

CHECK

If the coordinate mode is changed after the judgement conditions have been set, the measurement results will change also. Change the judgement conditions to enable correct measurement.

1. Select **Coordinate mode**.

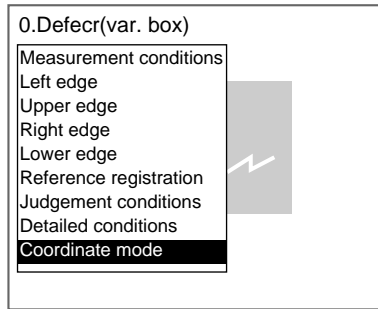

The Coordinate Mode Settings Screen will be displayed.

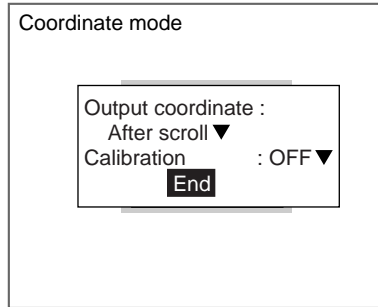

2. Make the settings for each item.
3. Select **End**.

The settings will be registered and the screen in (1.) will return.

3-3 Gravity and Axis

Density images taken by the Camera are converted into binary images made up of black and white pixels and then measured. The size (area), position (center of gravity), and axis angle of the white-pixel area is calculated.

SeeAlso Refer to page 7.

Operational Flow

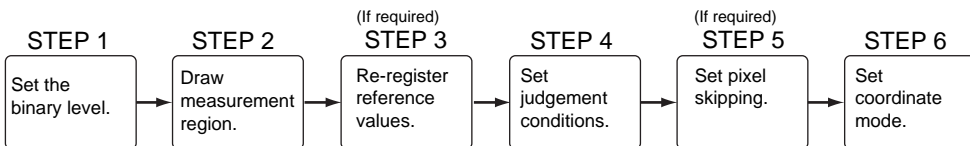

3-3-1 STEP 1: Setting the Binary Level

Set the level for converting 256-gradation images into binary images. The F160 performs measurement for the white areas. Therefore, make the settings so that the areas for the center of gravity or the axis angle are white.

1. Select **Measurement**/**<Region number>**/**Gravity and axis**.

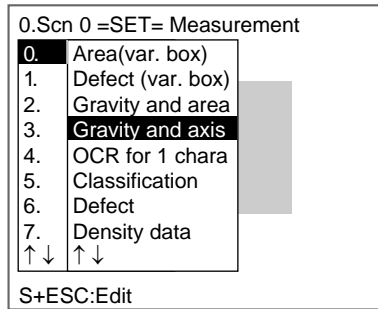

The initial screen for Gravity and axis will be displayed.

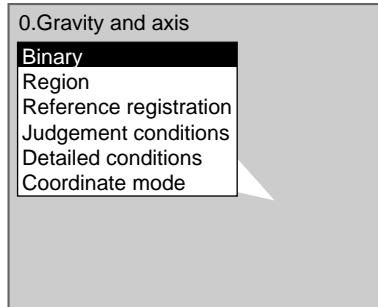

2. Select **Binary**.

The Binary Level Settings Screen will be displayed.

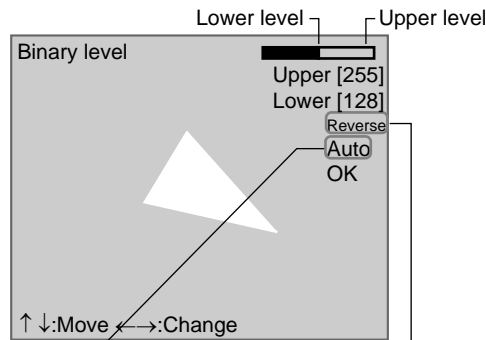

Auto
The F160 automatically sets the binary level

Reverse
Reverses dark and clear in the display

3. Move the cursor to the upper limit and use the **Left** and **Right** Keys to change the value.

Right Key: Increases the lowest digit by one.

SHIFT+Right Keys: Increases the value in 10s.

Left Key: Decreases the lowest digit by one.

SHIFT+Left Keys: Decreases the value in 10s.

Up and Down Keys: Switches between setting items.

4. Use the same method to change the lower value.

CHECK

Set the upper and lower limits to make the measurement object white.

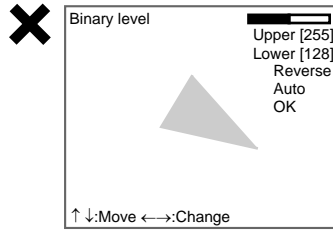

5. Select **OK**.

The settings will be registered and the screen in (2.) will return.

CHECK

It is also possible to set the binary level so that measurement is performed only for an intermediate density range.

3-3-2 STEP 2: Drawing Measurement Regions

When a measurement region is drawn, measurement is performed for the displayed image and the results are registered as the reference values (area, center of gravity, and axis angle). This position becomes the reference position for position compensation, so be sure to place the measurement object in the correct position before drawing the measurement region.

CHECK

Regions can be created by combining up to 3 different figures. Regions with difficult shapes can be drawn and sections not to be measured can be left out of the region by combining different figures.

1. Select **Region**.

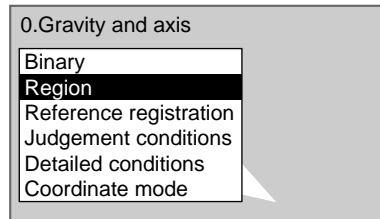

The Region Settings Screen will be displayed.

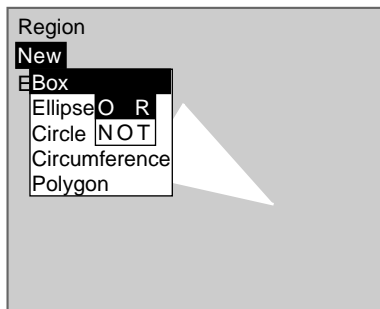

2. Select **New**.
3. Select the shape of the desired figure.
4. Select the desired drawing mode (**OR/NOT**).

SeeAlso

Refer to page 28 for methods for drawing regions.

An arrow cursor will appear.

Up to three figures (0, 1, and 2) can be drawn.

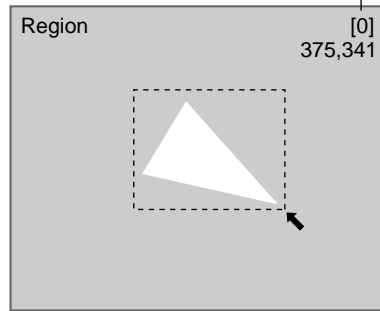

- 5. Draw the region with the shape selected.
The figure will be registered.

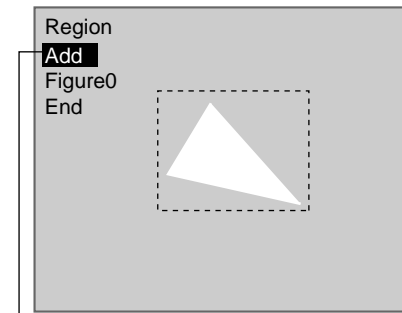

Once three figures have been drawn, **Add** will no longer be displayed.

- 6. If additional figures are to be drawn, select **Add**.
- 7. Repeat steps 3 to 5 as necessary to create the desired shape.
- 8. After drawing is completed, select **End**.

The measurement region will be registered and the screen in (1.) will return. The center of gravity (marked by an arrow cursor) and the measurement region will be displayed.

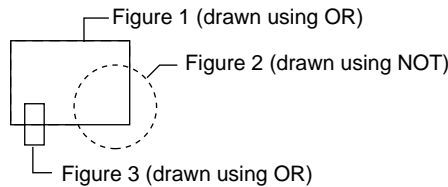

CHECK

Figures drawn using OR mode are displayed with solid lines and figures drawn using NOT mode are displayed with dotted lines.

Correcting or Clearing Figures

1. In the screen for step 6 above, select the figure to be changed or cleared using the **Up** and **Down** Keys and press the **ENT** Key.

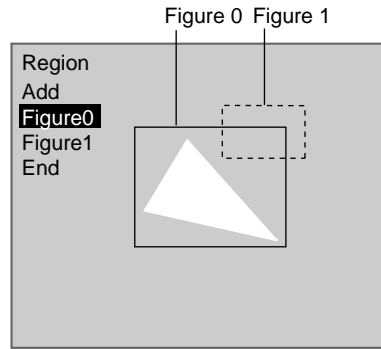

The figure for the figure number selected using the cursor will be displayed with solid lines. The selections **Correct** and **Clear** will be displayed.



2. Select either **Correct** or **Clear** and press the **ENT** Key.
 If **Correct** is selected, the cursor will be displayed. Correct the size and position of the figure as desired.
 If **Clear** is selected, the selected figure will be cleared.

3-3-3 STEP 3: Re-registering Reference Values

This operation is performed when only the reference values are to be re-registered.

When a measurement region is drawn, the measurement is performed for the displayed image and the results are registered as the reference values. If the re-registering function explained here is used, only the reference values for the image currently displayed will be registered. Area, center of gravity, and axis angle are registered for the reference values.

CHECK The reference position can be changed to enable the following function when *Region* is selected.

Inspecting Positions from a Specified Point

Once the reference values (area, center of gravity, and axis angle) have been obtained for the image currently displayed, the reference position is changed to a suitable point. Position inspection can be performed by calculating the difference between this reference position and the measurement position.

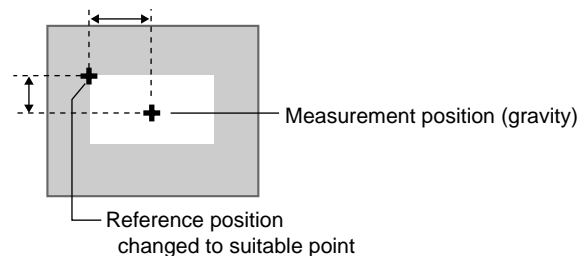

CHECK When the measurement region is changed, the reference values return to the default setting.

1. Select **Reference registration**.

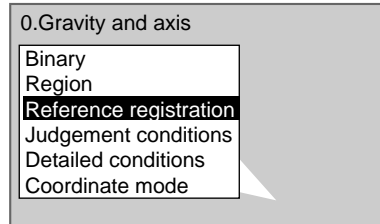

A cursor will appear at the position of the center of gravity.

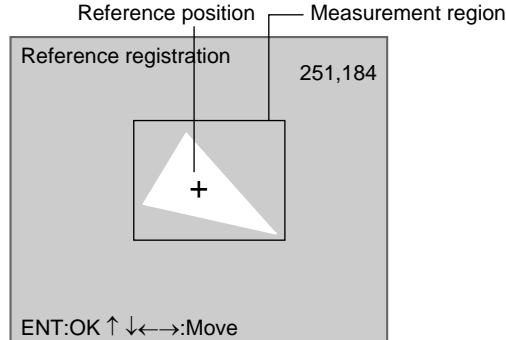

2. To change the position, use the **Up/Down** and **Right/Left** Keys to move the cursor.
3. Press the **ENT** Key to confirm the setting.

The setting will be registered and the screen in (1.) will return.

3-3-4 STEP 4: Setting Judgement Conditions

Make settings for the area, center of gravity, and axis angle.

Judgement conditions

Area : (2035.000)

[2000.000 : 247808.000]

Gravity X : (180.000)

[0.000 : 511.000]

Gravity Y : (250.000)

[0.000 : 483.000]

Axis angle : (75.000)

[-180.000 : 180.000]

End

● Range for an OK judgement.

— Area range (0 to 9,999,999.999)

— Range of movement of the measurement object in the X direction (-9,999.999 to 9,999.999)

— Range of movement of the measurement object in the Y direction (-9,999.999 to 9,999.999)

— Rotation range of the measurement object (-180.000 to 180.000, but only values between -90.000 and 90.000 will be output.)

○: Measurement results for the displayed image.
Use these values as a reference for setting upper and lower limits.

Axis Angle

Measurement value for axis angle: 10.000

-10.000

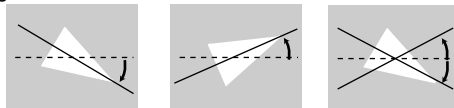

If this range is to be judged OK, set to -10.000: 10.000.

1. Select **Judgement conditions**.

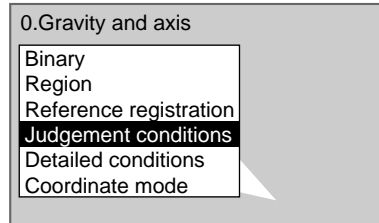

The Judgement Conditions Settings Screen will be displayed.

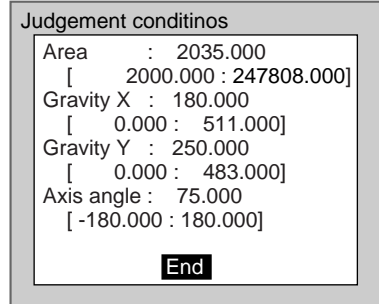

2. Make the settings.

SeeAlso

Refer to page 29 for details on inputting values.

3. Select **End**.

The settings will be registered and the screen in (1.) will return.

3-3-5 STEP 5: Setting Pixel Skipping

To shorten measurement processing time, change the number of pixels to be skipped. The greater the skipping setting, the shorter the processing time. However, the accuracy of the measurement will decrease.

Once the skipping setting has been changed, perform a measurement and check that measurement can be performed correctly.

Skipping X and Skipping Y

Set how many pixels to skip in the measurement region during measurement. The default setting is 1, which means that all of the measurement region will be measured.

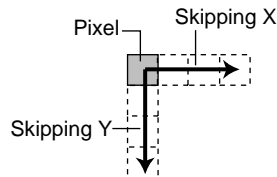

1. Select **Detailed conditions**.

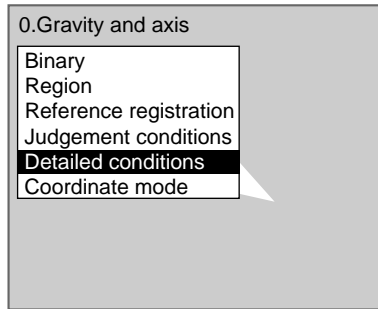

The Detailed Conditions Settings Screen will be displayed.

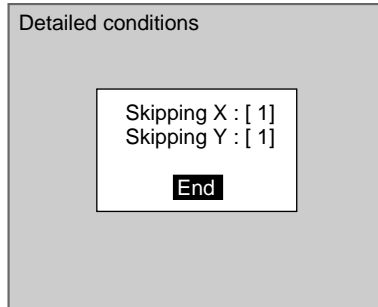

2. Set the number of pixels to skip.

SeeAlso

Refer to page 29 for details on inputting values.

3. Select **End**.

The setting will be registered and the screen in (1.) will return.

3-3-6 STEP 6: Setting the Coordinate Mode

Select the type of coordinates.

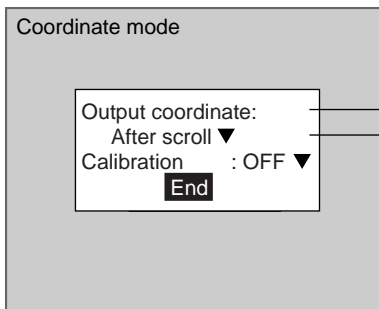

Before scroll: Output made using the coordinate values before position displacement compensation.
 After scroll*: Output made using the coordinate values after position displacement compensation.
 Refer to page 205 for position compensation.
 Refer to page 330 for differences between output coordinates.
 ON : Output made using coordinate values set using calibration.
 OFF*: Output made using Camera coordinate values.
 Refer to page 193 for information on calibration.

The default settings are marked with asterisks.*

CHECK

If the coordinate mode is changed after the judgement conditions have been set, the measurement results will change also. Change the judgement conditions to enable correct measurement.

1. Select **Coordinate mode**.

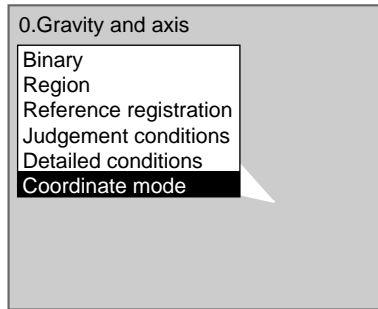

The Coordinate Mode Settings Screen will be displayed.

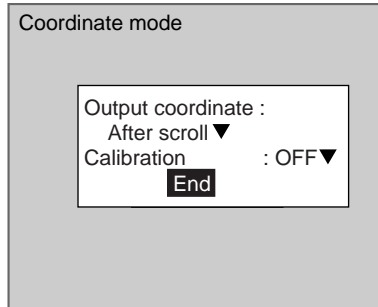

2. Make the settings for each item.
3. Select **End**.

The settings will be registered and the screen in (1.) will return.

3-4 OCR for 1 Character

The dictionary registered in the F160 is used to recognize alphanumeric characters and special symbols. The F160 can also evaluate whether or not the measurement area contains any detectable patterns (i.e., marks of any sort).

The F160 recognizes the character in the dictionary with the greatest similarity and this becomes the 1st candidate. The next most similar character becomes the 2nd candidate. If the density deviation is equal to or less than the setting, the F160 recognizes the area as unpatterned.

SeeAlso Refer to page 8.

CHECK If an expression is set, the character code of the recognized character is output to an external device. When no pattern is detected, the underscore (_) character code is output.

SeeAlso Refer to page 331 for a list of character codes.

Operational Flow

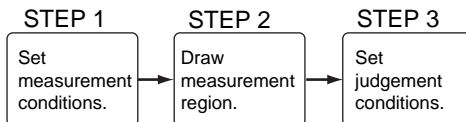

3-4-1 STEP 1: Setting Measurement Conditions

Set the conditions for recognizing characters.

Measurement conditions

Color	: Black ▼
Object	: Normal ▼
Alphabet	: ON ▼
Number	: ON ▼
Symbol	: ON ▼
Unpattern	: ON ▼

End

Color of recognized character
 Black*: The character color is darker than the background.
 White: The character color is lighter than the background.

Character printing type
 Normal*
 Dot

Dictionary
 ON*: Used for character recognition
 OFF: Not used for character recognition

ON*: No pattern recognized.
 OFF: No pattern not recognized.

Type	Registered characters
English	A to Z
Numerals	0 to 9
Symbols	: /

1. Select **Measurement**/**<Region number>/OCR for 1 chara.**

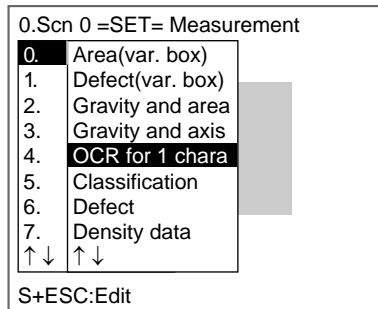

The initial screen for OCR for 1 chara will be displayed.

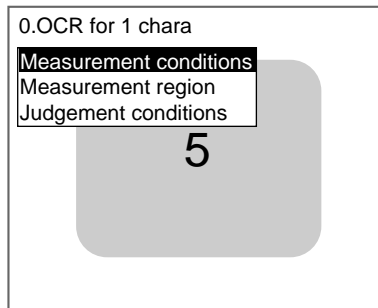

2. Select **Measurement conditions.**

The Measurement Conditions Settings Screen will be displayed.

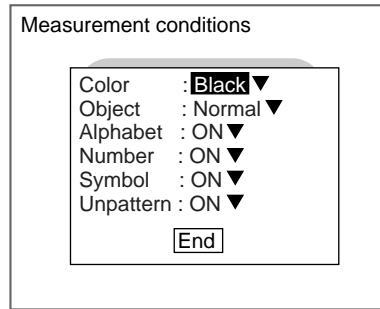

3. Make the settings for each item.
4. Select **End**.

The settings will be registered and the screen in (2.) will return.

3-4-2 STEP 2: Drawing Measurement Regions

The area where the character to be recognized is printed is set as the measurement region.

CHECK

Draw a measurement region just big enough for the character to be recognized. Correct measurement cannot be obtained if two or more characters are in the measurement region.

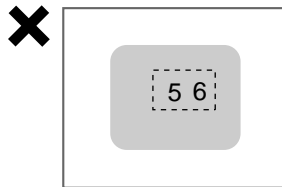

1. Select **Measurement region**.

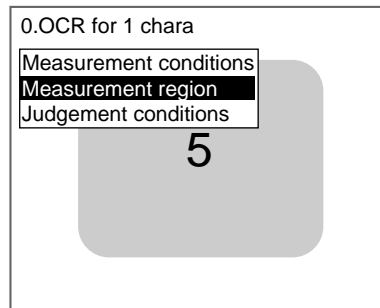

An arrow cursor will appear.

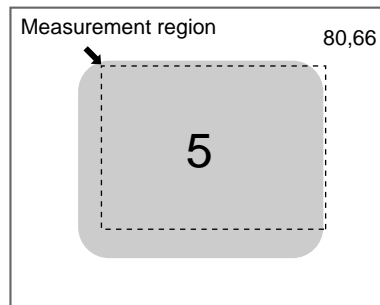

2. Draw a box-shaped region.

CHECK The only figure that can be drawn is a box.

SeeAlso Refer to page 28 for information on how to draw regions.

When the bottom right coordinates are specified, the region will be set, and the screen in (1.) will return.

3-4-3 STEP 3: Setting Judgement Conditions

Set the conditions for the 1st candidate character or for detecting no patterns.

Judgement conditions

Similarity level	100 [60]
Diff. level	70 [10]
Density deviation	0 [10]

[End]

● Value for an OK judgement

— Similarity level for 1st candidate (0 to 100)

— Difference level between 1st and 2nd candidates (0 to 100)

○ Density deviation within measurement region (0 to 127)
Enabled when **Measurement conditions/Unpatterned** is set to ON.
The area is recognized as unpatterned when the density deviation is equal to or less than the setting.

○: Measurement results for the displayed image.
Use these values as a reference for setting upper and lower limits.

CHECK Difference Level

When difference in degree of similarity is set to 10:

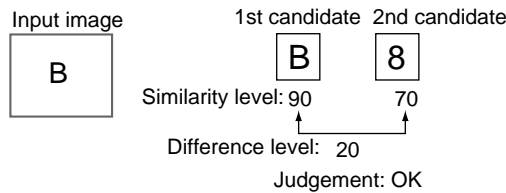

1. Select **Judgement conditions**.

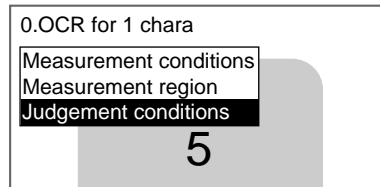

The Judgement Conditions Settings Screen will be displayed.

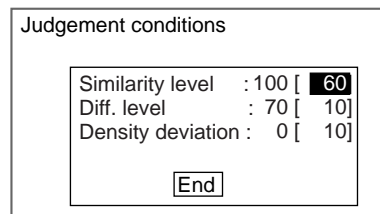

2. Make the settings for each item.

SeeAlso Refer to page 29 for details on inputting values.

3. Select **End**.

The settings will be registered and the screen in (1.) will return.

3-5 Classification

A section is registered beforehand as a model to serve as a reference for classification. Input images are compared with the models and the index number of the model with the greatest correlation with the input image is output.

SeeAlso Refer to page 8.

Operational Flow

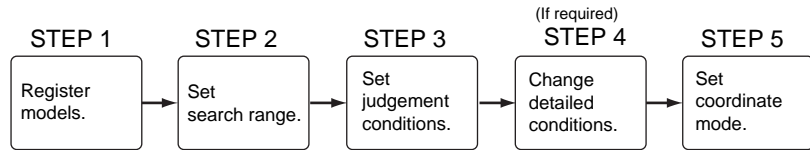

3-5-1 STEP 1: Registering Models

A section that will serve as the classification reference is registered as the model. Up to 36 models can be registered with index numbers 0 to 35. There are no restrictions on the size of the models.

When the model has variations in printing quality or shape, register multiple models to the same index number. Up to 5 models can be registered to the same index number. When a model is registered, the center of the model is registered as the search coordinates.

CHECK Models can be created by combining up to 3 different figures. Regions with difficult shapes can be drawn and sections not to be measured can be left out of the model region by combining different figures.

CHECK When multiple models are registered to the same index number, the F160 automatically creates auxiliary models between the models that are registered. If the auxiliary models are added to the registered models when searches are performed, stable searches are possible even if there are variations between the registered models. You can select whether or not to use auxiliary models in searches under *Detailed settings*. Refer to page 331 for information on auxiliary models.

1. Select **Measurement**/**<Region number>**/**Classification**.

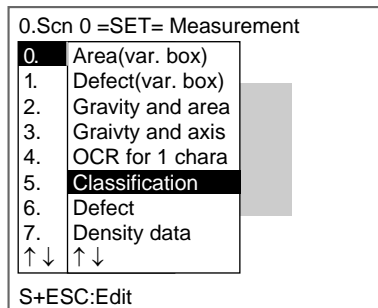

The initial screen for Classification is displayed.

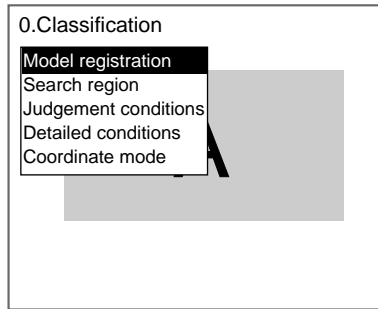

2. Select **Model registration**.

The Model Registration Screen for index numbers 0 to 7 will be displayed.

Use the **SHIFT+Up/Down** Keys to change the index number.

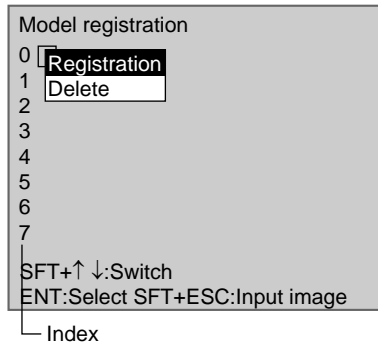

3. Move the cursor to the index number for the model to be registered and press the **ENT** Key. In this example, index 0 will be used.
4. Select **Registration**.

The selections will be displayed.

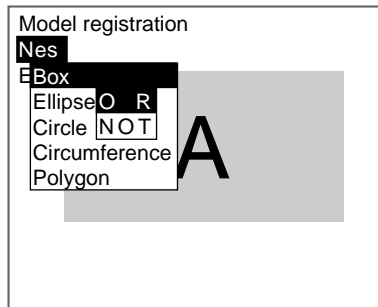

5. Select **New**.
6. Select the shape of the desired figure.
7. Select the desired drawing mode (**OR/NOT**).

SeeAlso

Refer to page 28 for methods for drawing regions.

An arrow cursor will appear.

Up to three figures (0, 1, and 2) can be drawn.

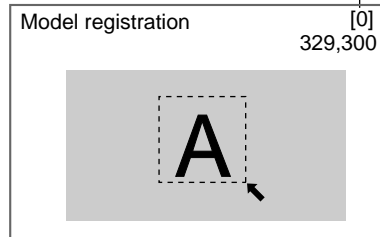

- 8. With the shape selected, draw the region to be registered as the model.

The figure will be registered.

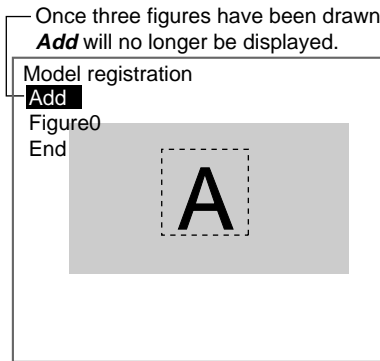

- 9. If additional figures are to be drawn, select **Add**.
- 10. Repeat steps 6 to 8 as necessary to create the desired shape.
- 11. After drawing is completed, select **End**.

The measurement region will be registered and the screen in (3.) will return.

The registered model is displayed as a thumbnail.

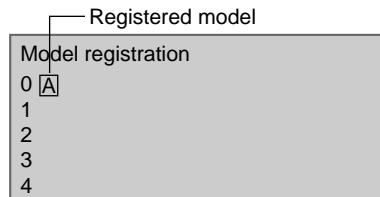

- 12. To register the next model, change the measurement object and press the **SHIFT+ESC** Keys.

The Input Image Screen will be displayed.

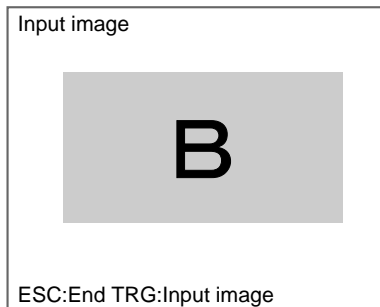

13. Press the **TRIG** Key to refresh the image.
14. Press the **ESC** Key.
The screen in (12.) will return.
15. Repeat steps 3 to 11 to register further models.

CHECK

To add models to the same index number, use the Right Key to move the cursor.

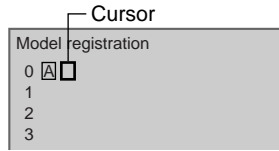

16. When all models have been registered, press the **ESC** Key.
The settings will be registered and the screen in (2.) will return.

Correcting or Clearing Figures

1. In the screen for step 9 above, select the figure to be changed or cleared using the **Up** and **Down** Keys and press the **ENT** Key.

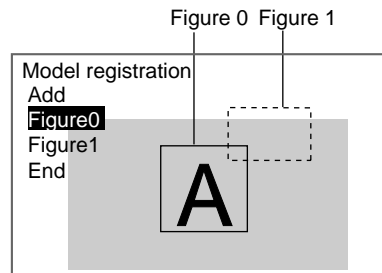

The figure for the figure number selected using the cursor will be displayed with solid lines. The selections **Correct** and **Clear** will be displayed.



2. Select either **Correct** or **Clear** and press the **ENT** Key.
If **Correct** is selected, the cursor will be displayed. Correct the size and position of the figure as desired.
If **Clear** is selected, the selected figure will be cleared.

Clearing or Overwriting Registered Models

1. Select the model to be cleared or overwritten from the thumbnails and press the **ENT** Key.

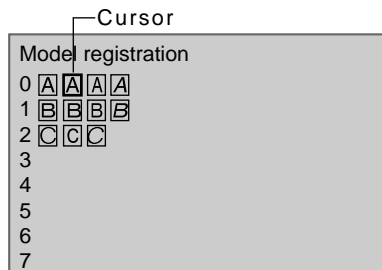

The selections **Registration** and **Delete** will be displayed.



2. Select either **Registration** or **Delete** and press the **ENT** Key.
 If **Registration** is selected, the Model Registration Screen will be displayed. Register the model.
 If **Delete** is selected, the selected model will be deleted.

3-5-2 STEP 2: Setting Search Regions

Set the region to search for the model. The whole region of the input image can be searched, however processing time can be reduced and accuracy improved by limiting the search region.

1. Select **Search region**.

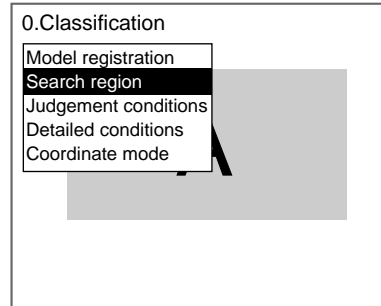

An arrow cursor will appear.

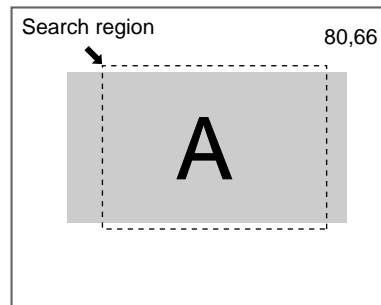

2. Draw a box-shaped search region.

CHECK

The only figure that can be drawn is a box.

SeeAlso

Refer to page 28 for methods for drawing regions.

When the bottom right coordinates are specified, the region will be set, and the screen in (1.) will return.

3-5-3 STEP 3: Setting Judgement Conditions

Set the judgement conditions for the correlation between the measurement object and the models and the position (X, Y) where the object was detected.

○: Measurement results for the displayed image.
Use these values as a reference for setting upper and lower limits.

CHECK Correlation

When OK condition for correlation is set between 60 and 100:

Image 0	Image 1	Image 2	Image 3
A	A	C	A
Correlation: 96	55	50	65
Judgement: OK	NG	NG	OK

CHECK Position X and Position Y

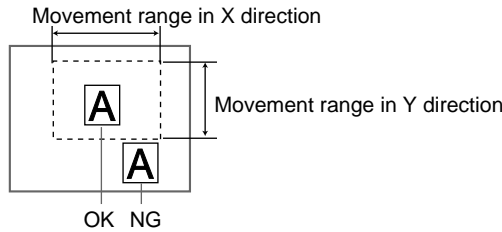

1. Select **Judgement conditions**.

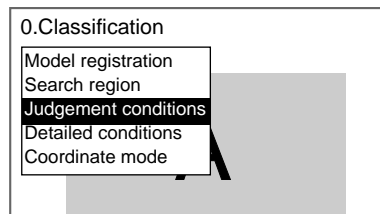

The Judgement Conditions Settings Screen will be displayed.

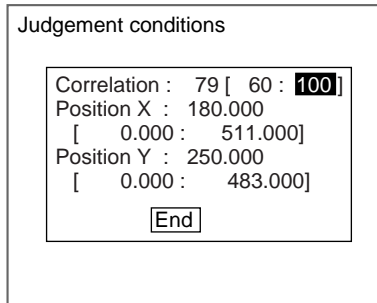

2. Make the settings.

SeeAlso

Refer to page 29 for details on inputting values.

3. Select **End**.

The settings will be registered and the screen in (1.) will return.

3-5-4 STEP 4: Changing Detailed Conditions

Search-related settings can be changed under *Detailed conditions*. Change the detailed conditions when the measurement results are unstable and to increase processing speed. (Normally, these conditions can be left on the default settings.) After changing the settings, perform an object measurement to check that measurement can still be performed correctly.

1. Select **Detailed conditions**.

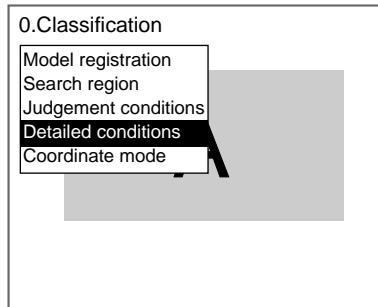

The Detailed Conditions Settings Screen will be displayed.

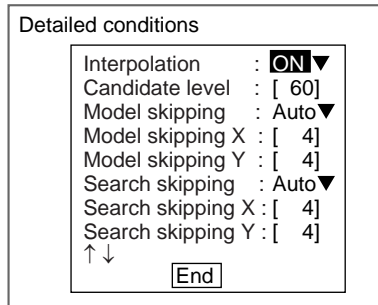

2. Change the settings.

Use the **Down** Key to scroll through the setting items.

SeeAlso

Refer to page 29 for details on inputting values.

3. Select **End**.

The settings will be registered and the screen in (1.) will return.

CHECK

The F160 performs the following two-stage search internally.

1 Rough Search

Using a rough search model, the F160 searches for images with a correlation equal to or greater than the candidate level.

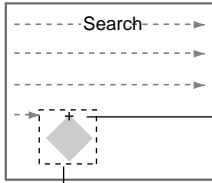

Rough search model

Area with correlation greater than candidate level.



2 Detailed Search

The F160 uses a detailed search model and re-measures the images near the area that was equal to or greater than the candidate level.

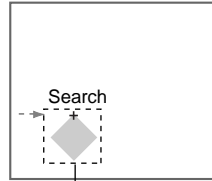

Detailed search model

Auxiliary Models

Sets whether or not auxiliary models will be used in searches.

Selection	Meaning
ON*	The registered models and auxiliary models will be used in searches. The measurement will be more stable, however the processing time will be longer.
OFF	The searches will be performed with registered models only.

Note The asterisk (*) indicates the default setting.

HELP Refer to page 331 for information on auxiliary models.

Candidate Levels

Set the level for the model search during rough searches.

Setting range	Meaning
0 to 100 (60*)	Images with a correlation equal to or greater than the candidate level will become candidates for the detailed search. When the model cannot be found dependably, set this level low.

Note The asterisk (*) indicates the default setting.

Model Pixel Skipping and Detailed Model Pixel Skipping

Use this function to change model pixel skipping (the number of pixels to be skipped from the registered model). *Model skipping* is for the rough search

model and *Detailed model skipping* is for the detailed search model. The setting range is the same for both.

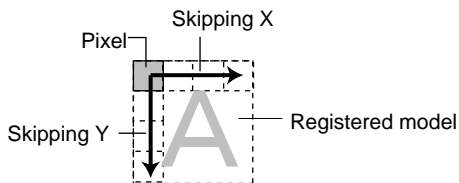

Setting item	Setting range	Meaning
Model skipping Detailed model skipping	Automatic*	The F160 automatically sets the most suitable skipping setting (X and Y) based on the model size. The set values will be displayed for Model skipping X/Y or Detailed model skipping X/Y.
	Fixed	Set any skipping setting. The set skipping will be reflected at Model skipping X/Y or Detailed model skipping X/Y.
Model skipping X Detailed model skipping X	1 to 15	The skipping setting in the X direction.
Model skipping Y Detailed model skipping Y	1 to 15	The skipping setting in the Y direction.

Note The asterisk (*) indicates the default setting.

CHECK Changed skipping settings will be reflected from the next model registration. They will not be reflected in previously registered models.

Search Pixel Skipping

Set the skipping conditions for rough searches. Set the number of pixels to be skipped in the measurement region during rough searches.

Example: When Skipping X Is 2 and Skipping Y Is 2

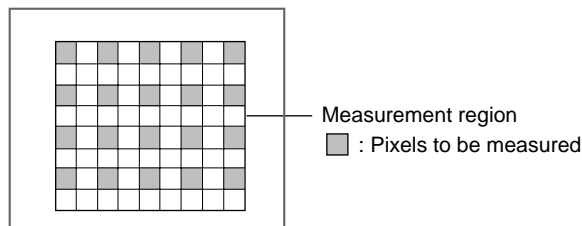

Setting item	Setting range	Meaning
Search skip- ping	Automatic*	The F160 automatically sets the most suitable search skipping setting (X and Y). The set values will be displayed at Search skipping X and Y.
	Fixed	Set any skipping setting. The set skipping will be reflected at Search skipping X and Y.
Search skip- ping X	1 to 15	The skipping setting in the X direction.
Search skip- ping Y	1 to 15	The skipping setting in the Y direction.

Note The asterisk (*) indicates the default setting.

3-5-5 STEP 5: Setting the Coordinate Mode

Select the type of coordinates.

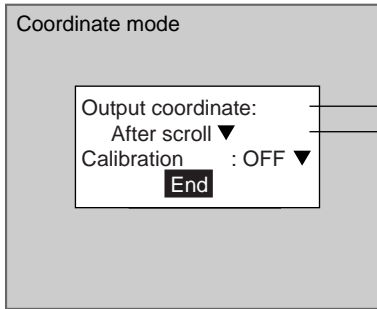

Before scroll: Output made using the coordinate values before position displacement compensation.
 After scroll*: Output made using the coordinate values after position displacement compensation.
 Refer to page 205 for position compensation.
 Refer to page 330 for differences between output coordinates.
 ON : Output made using coordinate values set using calibration.
 OFF*: Output made using Camera coordinate values.
 Refer to page 193 for information on calibration.

The default settings are marked with asterisks.*

CHECK If the coordinate mode is changed after the judgement conditions have been set, the measurement results will change also. Change the judgement conditions to enable correct measurement.

1. Select **Coordinate mode**.

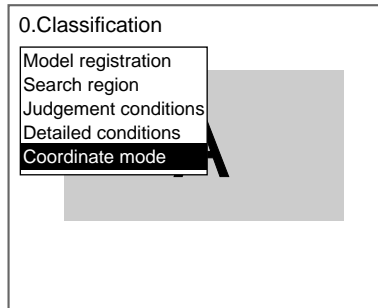

The Coordinate Mode Settings Screen will be displayed.

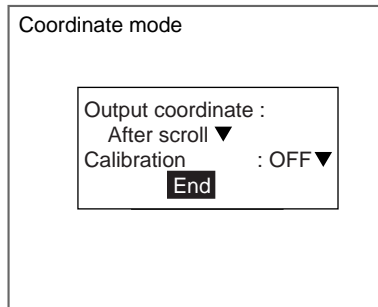

2. Make the settings for each item.
3. Select **End**.

The settings will be registered and the screen in (1.) will return.

3-6 Surface Defects

Surface defects in the F160 measurement region are checked for through variations in density.

SeeAlso Refer to page 9.

Operational Flow

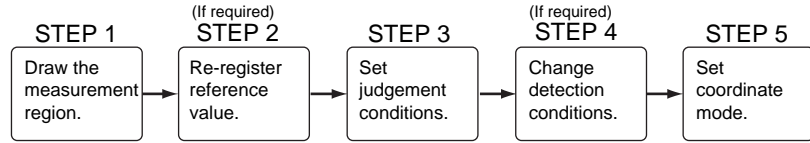

3-6-1 STEP 1: Drawing the Measurement Region

Measurement region shapes can be selected from lines, circumferences, arcs, and region.

Guide to Selecting Figures

Lines

Select *Defect (Line)* when detecting defects or burrs in the measurement object. If line is selected, one line can be drawn.

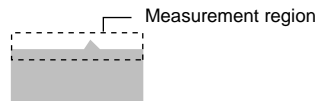

Regions

Select *Defect (Region)* to detect defects in the whole measurement region. The region can be drawn by combining up to 3 figures (box, ellipse, circle, circumference, or polygon).

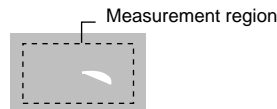

Circumferences and Arcs

Select *Defect (Circum)* or *Defect (Arc)* to detect defects or burrs in circular measurement objects. Either a circumference or arc can be drawn.

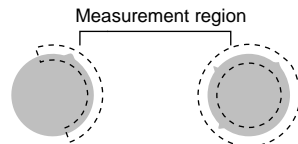

SeeAlso Refer to page 28 for methods for drawing regions.

CHECK

Do not include areas with marks and patterns in the measurement region. It will not be possible to distinguish them from surface defects, and measurement will not be performed properly.

CHECK

Position detection can be performed using algorithms for detecting defects.

When a measurement region is drawn, measurement is performed for the displayed image and the results are registered as the reference values (X and Y coordinates of the position where the defect was found). This position becomes the reference position, so be sure to place the measurement object in the correct position before drawing the measurement region.

1. Select **Measurement**/**<Region number>**/**Defect**.

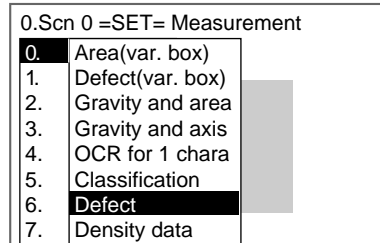

The initial screen for Defect will be displayed.

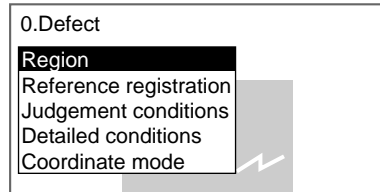

2. Select **Region**.

The figure selections will be displayed.

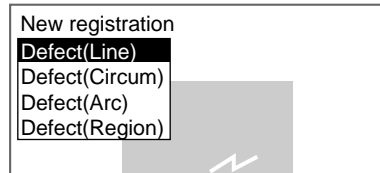

3. Select a figure.

The Region Settings Screen will be displayed.

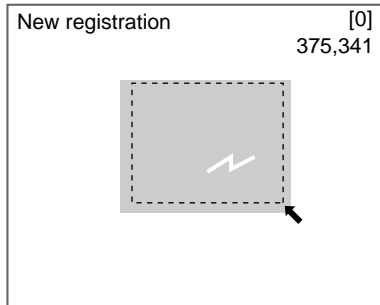

4. Draw the measurement region.

SeeAlso

Refer to page 28 for methods for drawing regions.

CHECK

When *Defect (Region)* is selected, up to 3 figures can be combined. From this point, the procedures for the various measurement methods are given separately. Refer to the appropriate explanation.

SeeAlso

Refer to page 94 for information on drawing regions for Gravity and axis. The settings will be registered and the screen in (2.) will return. The position where a defect was found (marked by the display cursor) and the measurement region will be displayed.

3-6-2 STEP 2: Re-registering Reference Values

Position detection can also be performed using algorithms for detecting defects. When a measurement region is drawn, measurement is performed for the displayed image and the results are registered as the reference values (X and Y coordinates of the position where the defect was found). If this function is used, however, the reference value alone can be re-registered based on the currently displayed image.

Example: Inspecting whether or not the measurement object is always in the same position

Display a measurement object in the correct position, detect a mark, and register that position as the reference position.

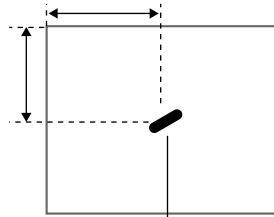

Register the detected mark as the reference position.

CHECK

The reference value can be changed to enable the following function.

Inspecting Positions from a Specified Point

Once a mark has been detected in the image currently displayed, the reference position is changed to a suitable point. Position inspection can be performed by calculating the difference between this reference position and the measurement position.

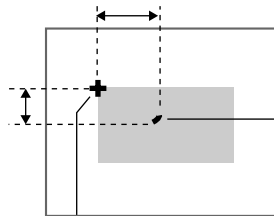

Measurement position (mark detected as a defect)

Reference position (changed to a suitable point)

CHECK

If the measurement region is changed, the reference values return to the default setting.

1. Select **Reference registration**.

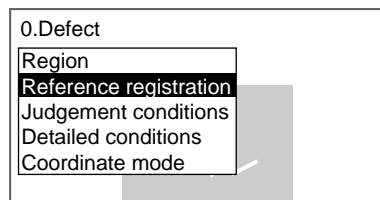

A cursor will appear at the position of the defect.

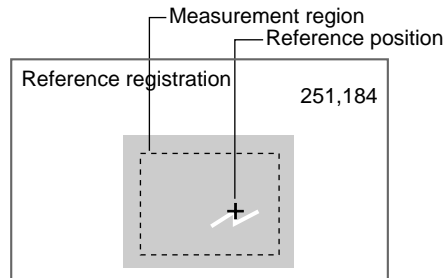

2. To change the position, use the **Up/Down** and **Right/Left** Keys to move the cursor.
3. Press the **ENT** Key to confirm the setting.
The setting will be registered and the screen in (1.) will return.

3-6-3 STEP 3: Setting the Judgement Conditions

Set the conditions for determining defects. Set a value between 0 and 255 as the OK judgement value. Measure several samples and set the judgement conditions while referring to the measurement results.

1. Select **Judgement conditions**.

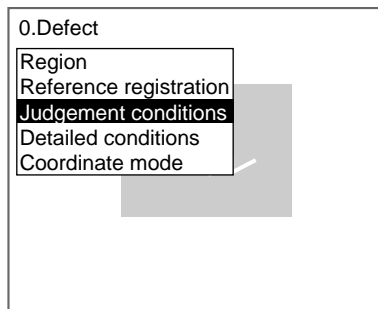

The Judgement Conditions Settings Screen will be displayed.

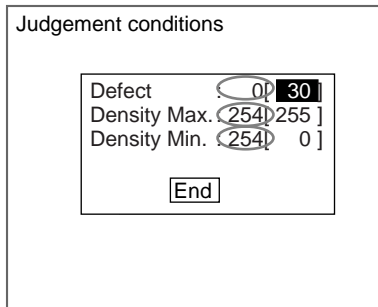

○: Measurement result for the displayed image.
Use this value as a reference for setting upper and lower limits.

2. Change the settings.

SeeAlso

Refer to page 29 for details on inputting values.

3. Select **End**.

The settings will be registered and the screen in (1.) will return.

3-6-4 STEP 4: Changing Detection Conditions

To shorten measurement processing time, change the conditions for detecting defects. The greater the element size and comparing pitch, the shorter the processing time. However, the accuracy of the measurement will decrease.

Once the element size or comparing pitch setting has been changed, perform measurements to check that they can be performed correctly.

Element size (4 to 80). Default setting is 10.

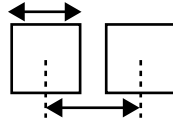

Comparing pitch (1 to 6). Default setting is 1.

HELP

Refer to page 90 for information on element size and comparing pitch.

1. Select **Detailed conditions**.

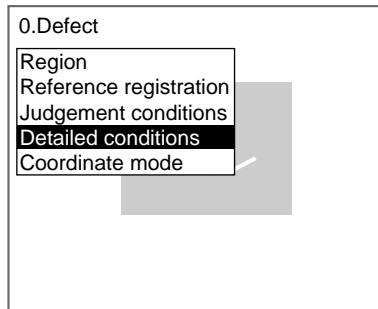

The Detailed Conditions Settings Screen will be displayed.

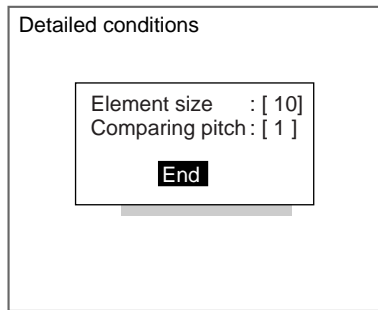

2. Set the element size and comparing pitch.

SeeAlso

Refer to page 29 for details on inputting values.

3. Select **End**.

The settings will be registered and the screen in (1.) will return.

3-6-5 STEP 5: Setting the Coordinate Mode

Select the type of coordinates.

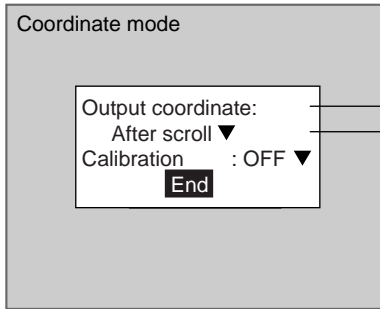

Before scroll: Output made using the coordinate values before position displacement compensation.

After scroll*: Output made using the coordinate values after position displacement compensation.

Refer to page 205 for position compensation.

Refer to page 330 for differences between output coordinates.

ON : Output made using coordinate values set using calibration.
 OFF*: Output made using Camera coordinate values.

Refer to page 193 for information on calibration.

The default settings are marked with asterisks.*

CHECK If the coordinate mode is changed after the judgement conditions have been set, the measurement results will change also. Change the judgement conditions to enable correct measurement.

1. Select **Coordinate mode**.

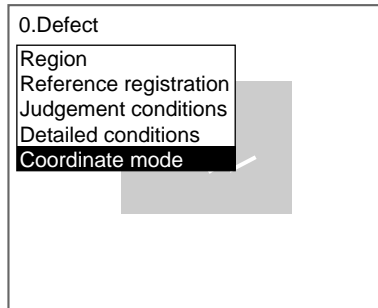

The Coordinate Mode Settings Screen will be displayed.

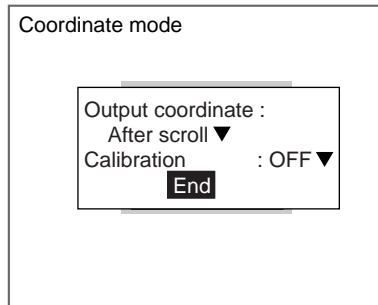

2. Make the settings for each item.
3. Select **End**.

The settings will be registered and the screen in (1.) will return.

3-7 Density Data

This function detects the density of each pixel (0 to 255) and calculates the density average and deviation to be used for inspection.

SeeAlso Refer to page 9.

Operational Flow

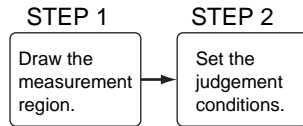

3-7-1 STEP 1: Drawing Measurement Regions

CHECK Regions can be created by combining up to 3 different figures. Regions with difficult shapes can be drawn and sections not to be measured can be left out of the region by combining different figures.

1. Select **Measurement**/**<Region number>**/**Density data**.

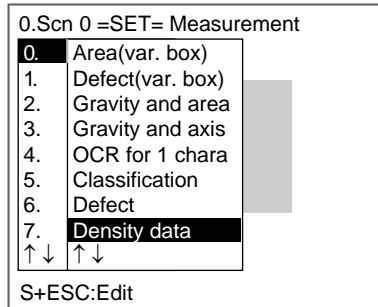

The initial screen for Density data will be displayed.

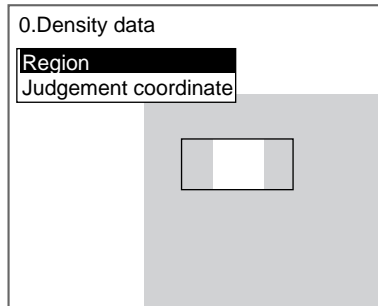

2. Select **Region**.

The Region Settings Screen will be displayed.

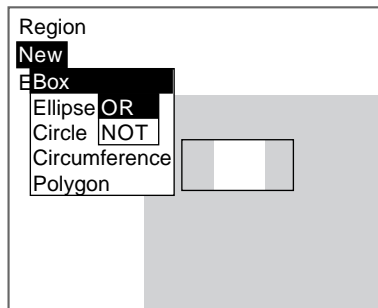

3. Select **New**.
4. Select the shape of the desired figure.
5. Select the desired drawing mode (**OR/NOT**).

SeeAlso Refer to page 28 for methods for drawing regions.

An arrow cursor will appear.

Up to three figures (0, 1, and 2) can be drawn.

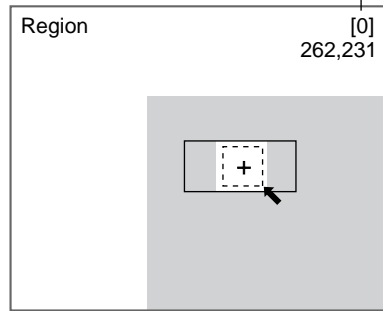

6. Draw the figure in the region to be used as the measurement region.
The figure will be registered.

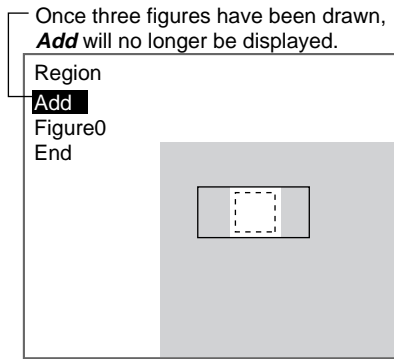

7. If additional figures are to be drawn, select **Add**.
8. Repeat steps 4 to 6 as necessary to create the desired shape.
9. After drawing is completed, select **End**.

The measurement region will be registered and the screen in (2.) will return. The measurement region will be displayed.

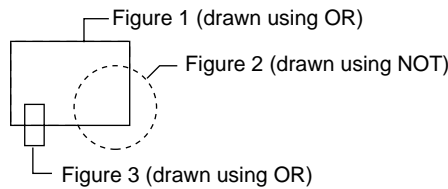

CHECK

Figures drawn using OR mode are displayed with solid lines and figures drawn using NOT mode are displayed with dotted lines.

Correcting or Clearing Figures

1. In the screen for step 7 above, select the figure to be changed or cleared using the **Up** and **Down** Keys and press the **ENT** Key.

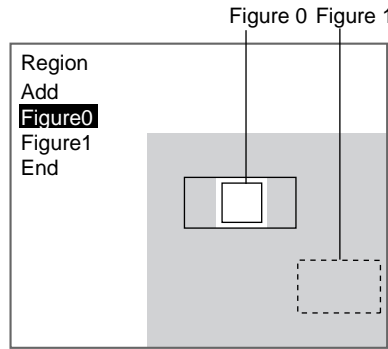

The figure for the figure number selected using the cursor will be displayed with solid lines. The selections **Correct** and **Clear** will be displayed.



2. Select either **Correct** or **Clear** and press the **ENT** Key.
 If **Correct** is selected, the cursor will be displayed. Correct the size and position of the figure as desired.
 If **Clear** is selected, the selected figure will be cleared.

3-7-2 STEP 2: Setting Judgement Conditions

Set the average density and density deviation range for an OK judgement.

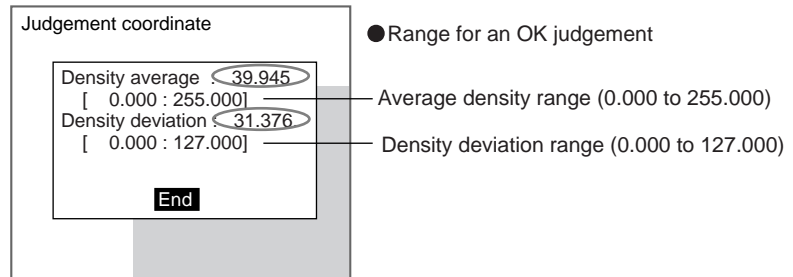

○: Measurement results for the displayed image.
 Use these values as a reference for setting upper and lower limits.

1. Select **Judgement conditions**.

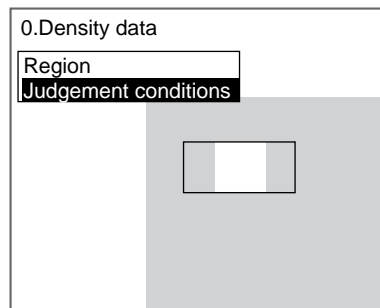

The Judgement Conditions Settings Screen will be displayed.

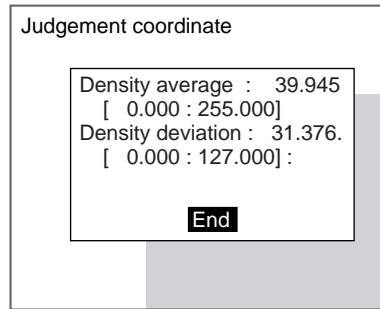

2. Make the settings for each item.

SeeAlso

Refer to page 29 for details on inputting values.

3. Select **End**.

The settings will be registered and the screen in (1.) will return.

3-8 Edge Pitch

Use the following procedure to find edges through density variations and obtain the number of objects, width, and pitch.

SeeAlso

Refer to page 10.

Operational Flow

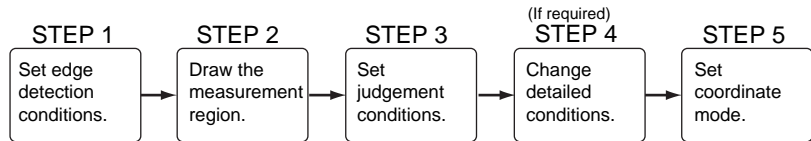

3-8-1 STEP 1: Setting the Edge Detection Conditions

Set the conditions for the edge search.

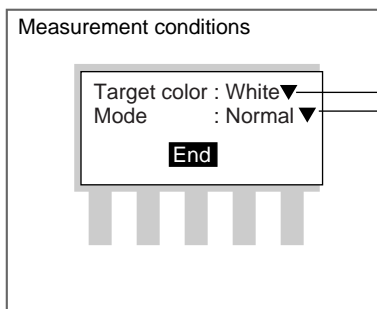

Target color for counting edges: White or black

Normal: For measurement objects with a width and separation of 2 pixels or more.

Fine: For stable measurement of objects with smaller widths and separation than normal.

1. Select **Measurement region**/**<Region number>/Edge pitch**.

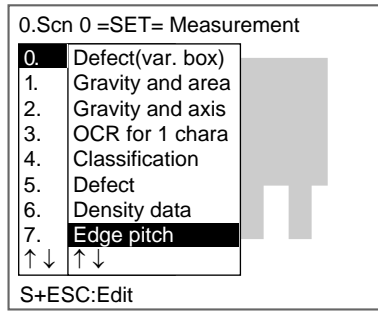

The initial screen for Edge Pitch will be displayed.

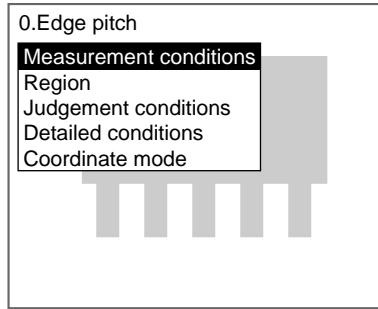

2. Select **Measurement conditions**.

The Measurement Conditions Settings Screen will be displayed.

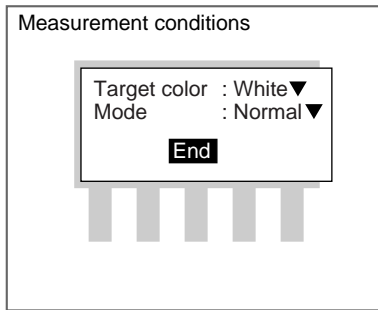

3. Select the edge detection conditions.
4. Select **End**.

The settings will be registered and the screen in (1.) will return.

3-8-2 STEP 2: Drawing Measurement Regions

Draw a region to include all the edges to be detected.

CHECK Edges are detected in the direction of the long side of the measurement region.

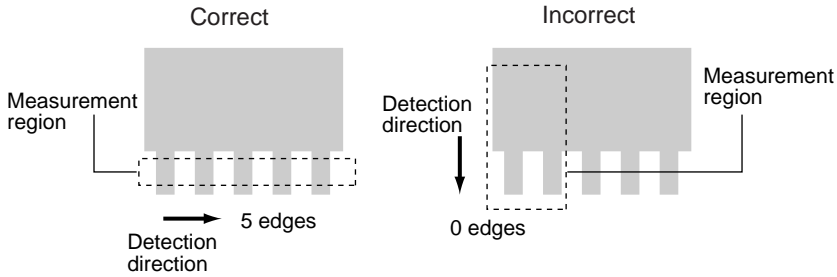

1. Select **Region**.

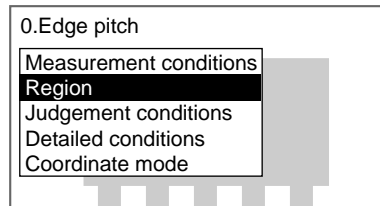

The Region Settings Screen will be displayed.

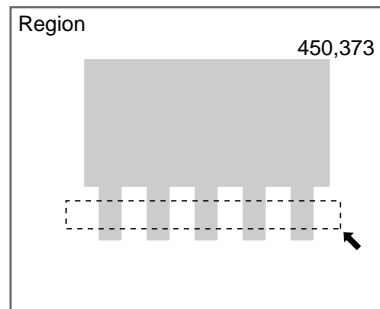

2. Draw a box-shaped measurement region.

CHECK

The only figure that can be drawn is a box.

SeeAlso

Refer to page 28 for methods for drawing regions.

When the coordinates of the lower right corner are specified, the region is registered and the screen in (1.) will return.

3-8-3 STEP 3: Setting Judgement Conditions

Set the ranges for an OK judgement.

Judgement conditions

- Ranges for an OK judgement
- : Measurement results for the displayed image. Use these values as a reference for setting upper and lower limits.

Number of edges : 5 [0 : 255] — Range for number of edges (0 to 255)

Average pitch : 9.322 [0.000 : 9999.999] — Range for average pitch (0 to 9999.999)

Average width : 3.234 [0.000 : 9999.999] — Range for average width (0 to 9999.999)

End

1. Select **Judgement conditions**.

0.Edge pitch

- Measurement conditions
- Region
- Judgement conditions**
- Detailed conditions
- Coordinate mode

The Judgement Conditions Settings Screen will be displayed.

Judgement conditions

Number of edges : 5 [0 : 255]

Average pitch : 9.322 [0.000 : 9999.999]

Average width : 3.234 [0.000 : 9999.999]

End

2. Make the settings for each item.

SeeAlso

Refer to page 29 for details on inputting values.

3. Select **End**.

The settings will be registered and the screen in (1.) will return.

3-8-4 STEP 4: Changing Detailed Conditions

Change the detailed conditions when the measurement results are unstable. Normally, these conditions can be left on the default settings.

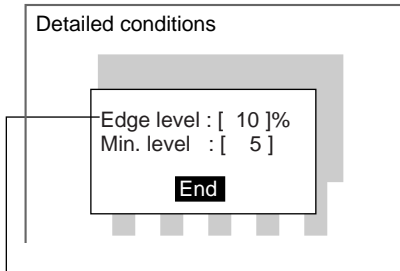

To prevent incorrect detection due to noise (0 to 255). (If the density variation is less than the minimum value, it will be considered to be noise.)

Threshold value for finding an edge (0 to 100).
 If the measured number of objects is less than the actual number of objects, set the edge level (or the minimum level) to a smaller value. If the measured number of objects is greater than the actual number of objects, set the edge level (or the minimum level) to a larger value.

- Edges are detected in the following way:
1. The density differentiation for the entire measurement range is obtained.
 2. The points corresponding to the maximums and minimums that exceed the edge level setting are detected as edges.

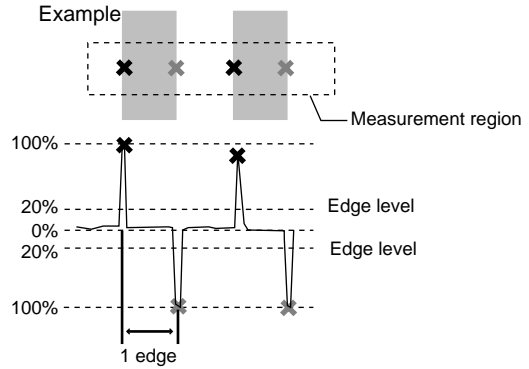

1. Select **Detailed conditions**.

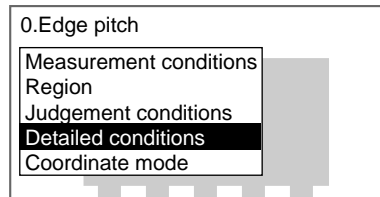

The Detailed Conditions Settings Screen will be displayed.

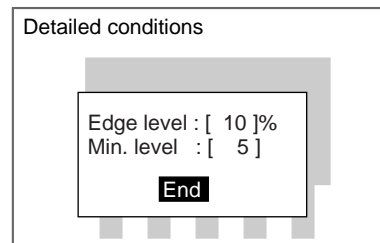

2. Change the settings.

SeeAlso

Refer to page 29 for details on inputting values.

3. Select **End**.

The settings will be registered and the screen in (1.) will return.

3-8-5 STEP 5: Setting the Coordinate Mode

Select the type of coordinates.

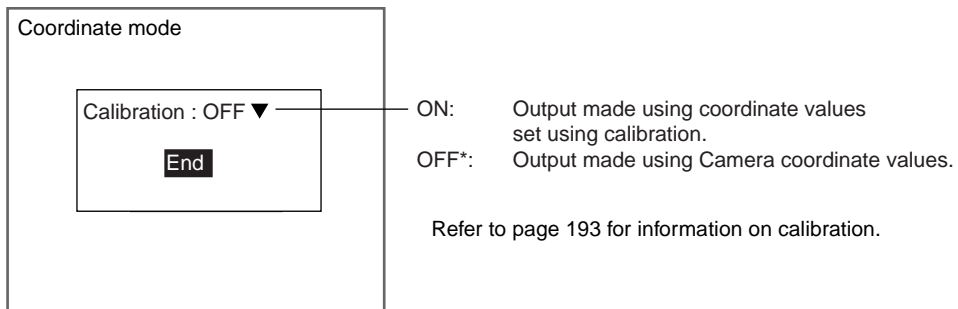

The default setting is marked with an asterisk.*

CHECK If the coordinate mode is changed after the judgement conditions have been set, the measurement results will change also. Change the judgement conditions to enable correct measurement.

1. Select **Coordinate mode**.

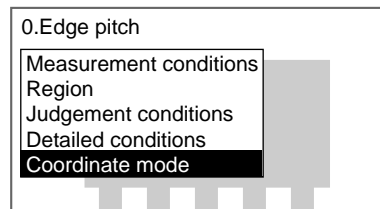

The Coordinate Mode Settings Screen will be displayed.

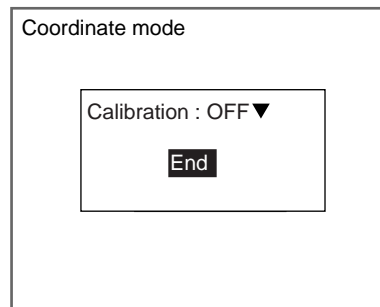

2. Make the settings for each item.
3. Select **End**.

The settings will be registered and the screen in (1.) will return.

3-9 Edge Position

Edges are identified by changes in the density within the region. The search direction and color change for edge detection can be set for each region.

SeeAlso Refer to page 10.

Operational Flow

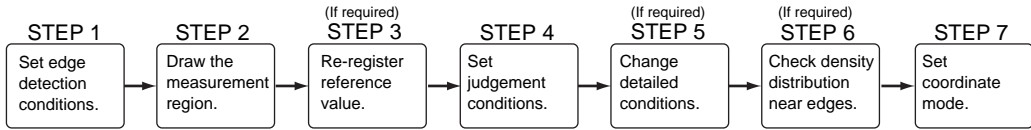

3-9-1 STEP 1: Setting Edge Detection Conditions

Set the direction for edge detection and the density changes.

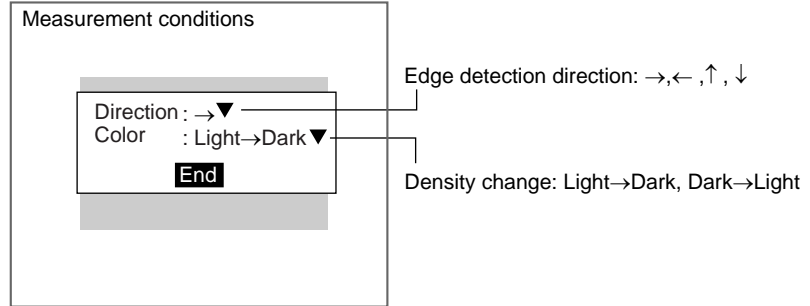

Example: To detect the following position

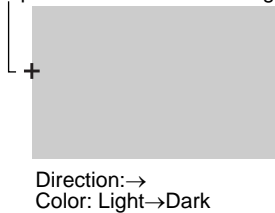

1. Select **Measurement**/**<Region number>**/**Edge position**.

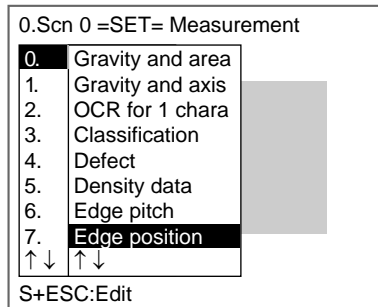

The initial screen for Edge Position will be displayed.

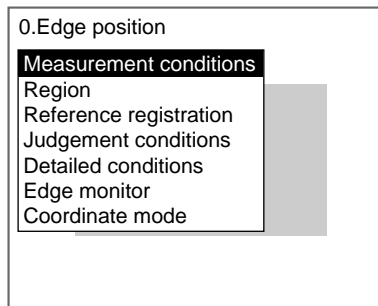

2. Select **Measurement conditions**.

The Measurement Conditions Settings Screen will be displayed.

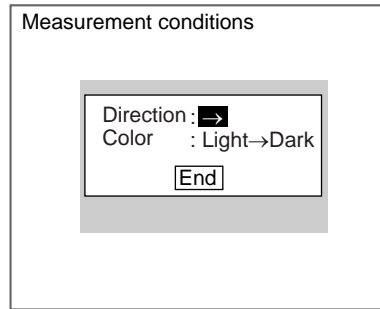

- 3. Select the edge detection conditions.
- 4. Select **End**.

The settings will be registered and the screen in (2.) will return.

3-9-2 STEP 2: Drawing Measurement Regions

Draw a measurement region to include all the edges for detection.

When a measurement region is drawn, measurement is performed for the displayed image and the result is registered as the reference value (edge position). This position becomes the reference position for position compensation, so be sure to place the measurement object in the correct position before drawing the measurement region.

CHECK If the edge is not in the measurement region, measurement will not be possible. Make a region of a size and position that allows for movement of the range of the measurement object.

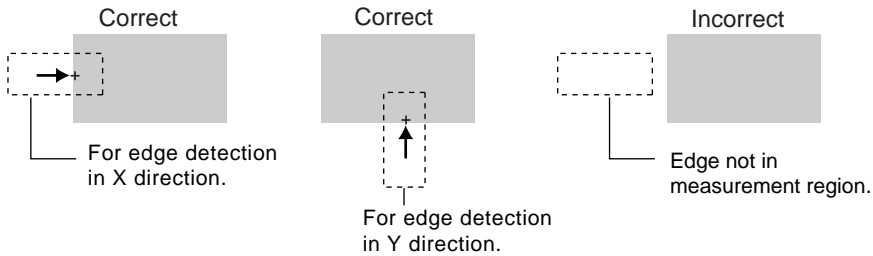

- 1. Select **Region**.

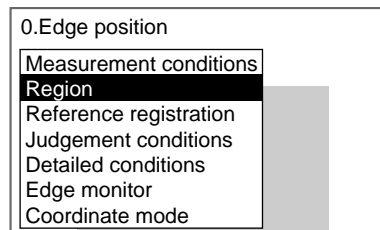

The Region Settings Screen will be displayed.

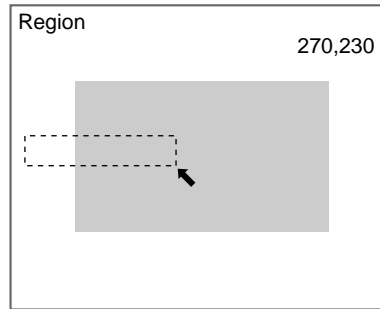

- 2. Draw a box-shaped region.

CHECK

The only figure that can be drawn is a box.

SeeAlso

Refer to page 28 for information on how to draw regions.

The region will be set and the screen in (1.) will return. The edge position (display cursor) and the measurement region will be displayed.

3-9-3 STEP 3: Re-registering Reference Values

This operation is performed when only the reference value is to be re-registered.

When a measurement region is drawn, the measurement is performed for the displayed image and the result is registered as the reference value. If the re-registering function explained here is used, only the reference value for the image currently displayed will be registered. Edge position is registered for the reference value.

CHECK

The reference position can be changed to enable the following function when *Region* is selected.

Inspecting Positions from a Specified Point

Once the reference value (edge position) has been obtained for the image currently displayed, the reference position is changed to an suitable point. Position inspection can be performed by calculating the difference between this reference position and the measurement position.

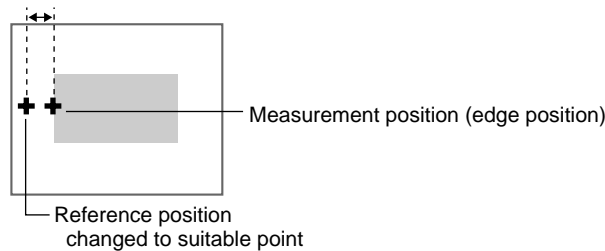

CHECK

When the measurement region is changed, the reference value returns to the default setting.

1. Select **Reference registration**.

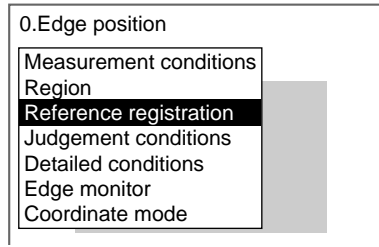

A cursor will appear at the edge position.

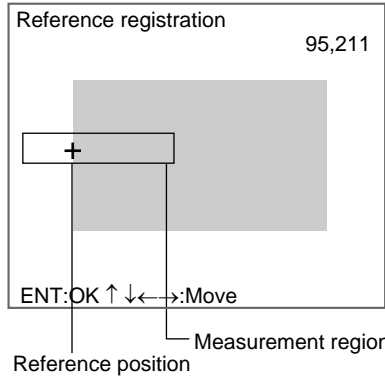

2. To change the position, use the **Up/Down** and **Right/Left** Keys to move the cursor.
3. Press the **ENT** Key to confirm the setting.
The setting will be registered and the screen in (1.) will return.

3-9-4 STEP 4: Setting Judgement Conditions

Set the position ranges for an OK judgement.

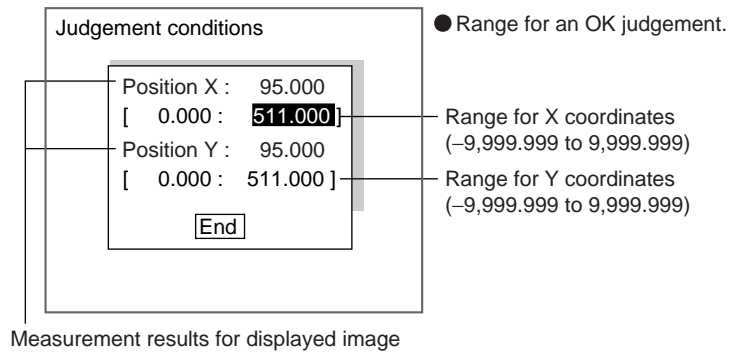

CHECK Position X and Position Y will change depending on the settings under *Measurement/Direction*.

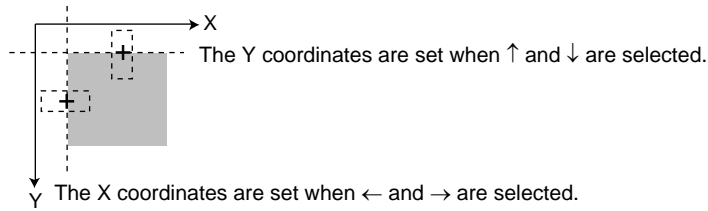

Note: The origin and coordinate system change depending on the calibration settings.

1. Select **Judgement conditions**.

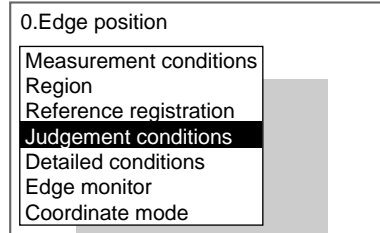

The Judgement Conditions Settings Screen will be displayed.

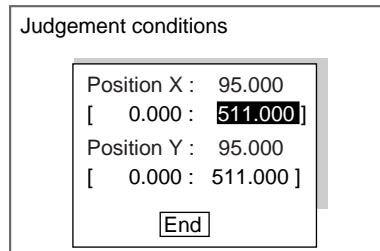

2. Change the settings.

SeeAlso

Refer to page 29 for details on inputting values.

3. Select **End**.

The settings will be registered and the screen in (1.) will return.

3-9-5 STEP 5: Changing Detailed Conditions

Change the detailed conditions when the measurement results are unstable. Normally, these conditions can be left on the default settings. After changing the settings, perform an object measurement to check that measurement can still be performed correctly.

1. Select **Detailed conditions**.

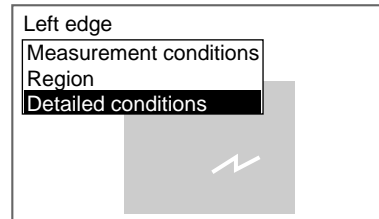
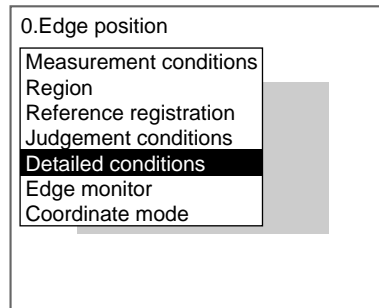

The Detailed Conditions Settings Screen will be displayed.

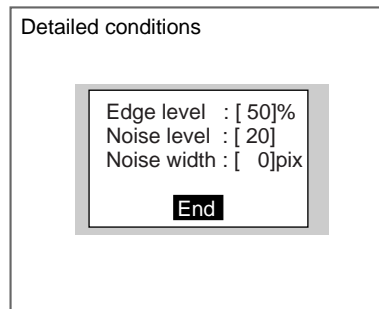

2. Change the settings.

SeeAlso

Refer to page 76 for information on edge levels, noise levels, noise width, and offset width.

SeeAlso

Refer to page 29 for details on inputting values.

3. Select **End**.

The settings will be registered and the screen in (1.) will return.

3-9-6 STEP 6: Monitoring the Density Distribution Near Edges

The density distribution and edge level within a region can be monitored on the screen. It is also possible to set the edge level while monitoring the density distribution. If the setting is changed, perform actual measurements to check whether or not correct measurement is possible.

Edge Detection in Horizontal Direction

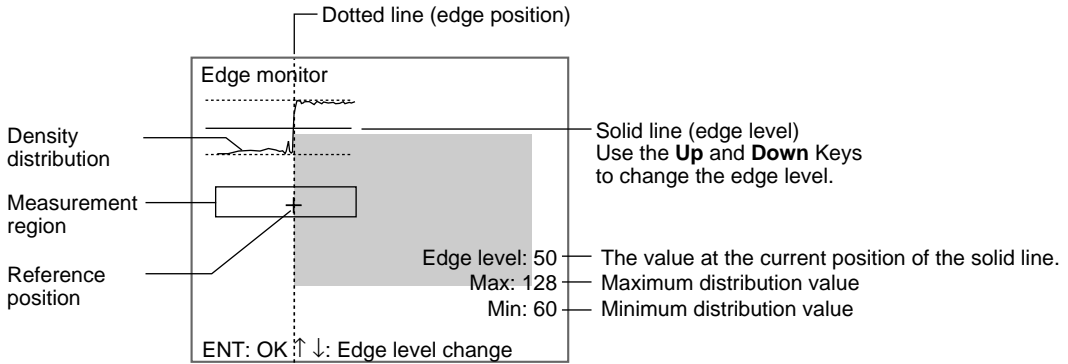

Edge Detection in Vertical Direction

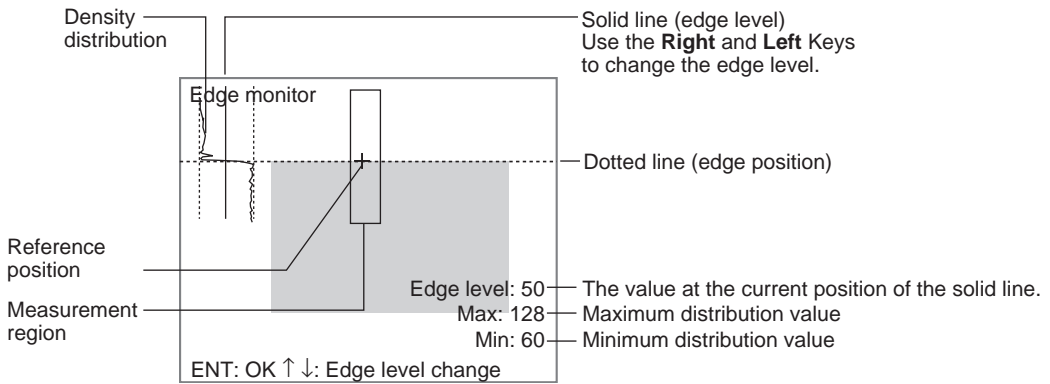

CHECK The edge level can also be set in the detailed conditions settings. (The value set last will be the valid one.)

SeeAlso Refer to page 133 for details on making detailed condition settings.

1. Select **Edge monitor**.

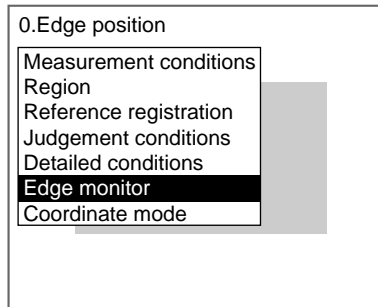

The Edge Monitor Screen will be displayed. If the edge level needs to be changed, go to step 2. If the edge level does not need to be changed, go to step 4.

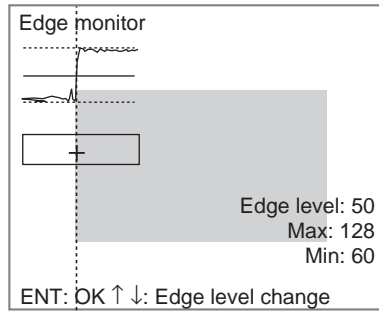

2. Use the **Up** and **Down** Keys to change the edge level.
3. Press the **ENT** Key to confirm the setting.
4. Press the **ESC** Key.

The screen for step 1 is returned. If the edge level was changed, the changes are registered.

3-9-7 STEP 7: Setting the Coordinate Mode

Select the type of coordinates.

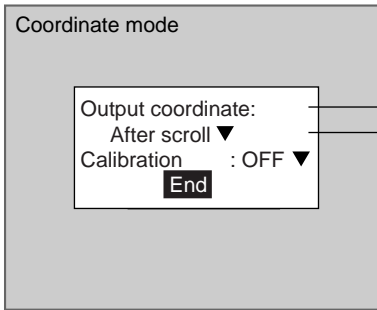

Before scroll: Output made using the coordinate values before position displacement compensation.

After scroll*: Output made using the coordinate values after position displacement compensation.

Refer to page 205 for position compensation.

Refer to page 330 for differences between output coordinates.

ON : Output made using coordinate values set using calibration.

OFF*: Output made using Camera coordinate values.

Refer to page 193 for information on calibration.

The default settings are marked with asterisks.*

CHECK

If the coordinate mode is changed after the judgement conditions have been set, the measurement results will change also. Change the judgement conditions to enable correct measurement.

1. Select **Coordinate mode**.

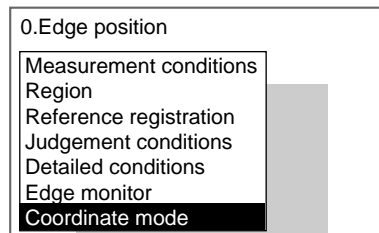

The Coordinate Mode Settings Screen will be displayed.

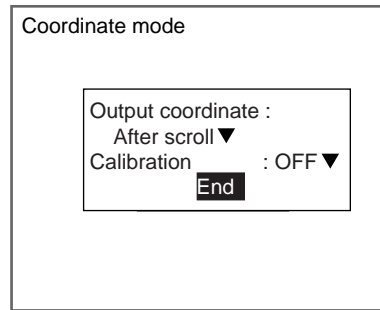

2. Make the settings for each item.
3. Select **End**.

The settings will be registered and the screen in (1.) will return.

3-10 Edge Width

Use Edge Width to locate two edges within a region and calculate the width.

SeeAlso Refer to page 11.

Operational Flow

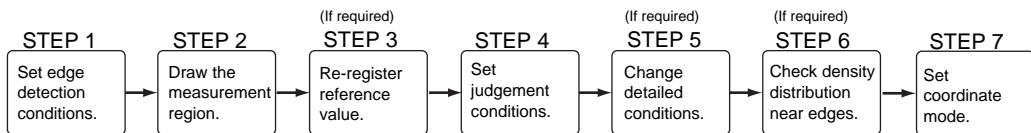

3-10-1 STEP 1: Setting Edge Detection Conditions

Set the direction for the edge search and density deviation range.

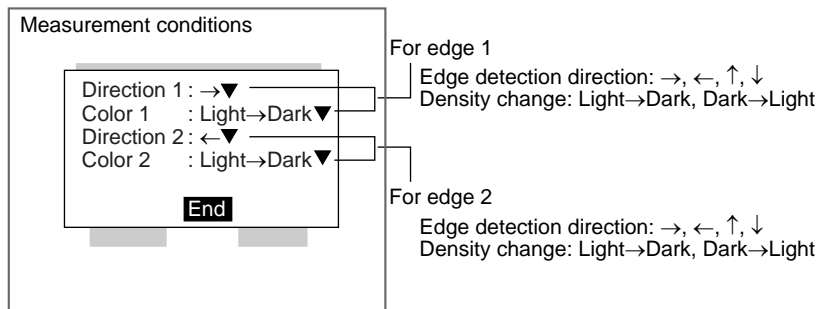

Example: When searching for this width

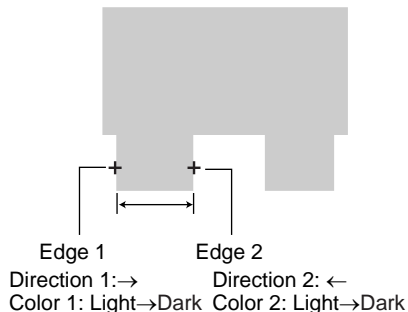

CHECK

Combining Edge Detection Directions

Combine the detection directions for edges 1 and 2 so that edges spanning the width to be set will be enclosed as shown below.

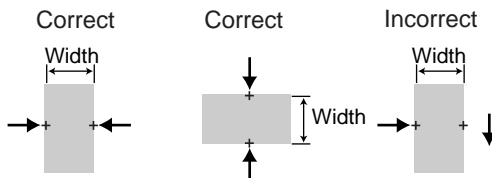

1. Select **Measurement**/**<Region number>**/**Edge width**.

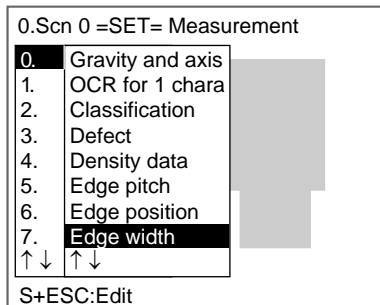

The initial screen for Edge width will be displayed.

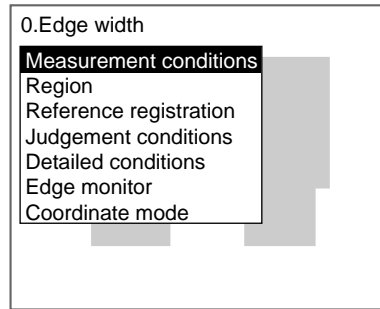

- 2. Select **Measurement conditions**.

The Measurement Conditions Settings Screen will be displayed.

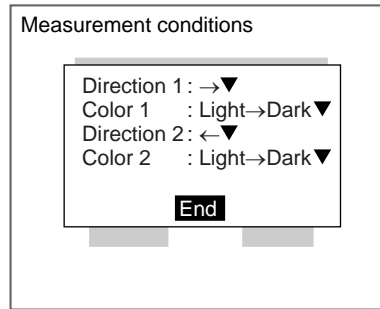

- 3. Select the detection conditions for edge 1 and edge 2.
- 4. Select **End**.

The settings will be registered and the screen in (2.) will return.

3-10-2 STEP 2: Drawing Measurement Regions

Draw a measurement region large enough for two edges to be included.

When a measurement region is drawn, the measurement is performed for the displayed image and the results are registered as the reference values. Two edge positions and an edge width are registered for the reference values.

CHECK

If the two edges are not in the measurement region, measurement will not be possible. Make a region of a size and position that allows for movement of the range of the measurement object.

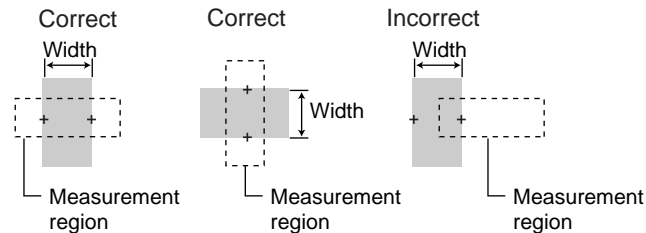

1. Select **Region**.

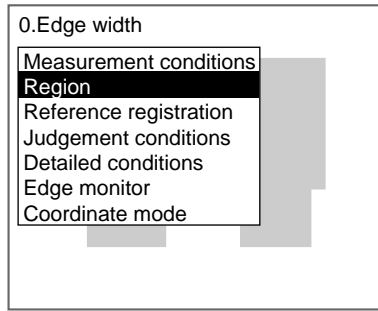

The Region Settings Screen will be displayed.

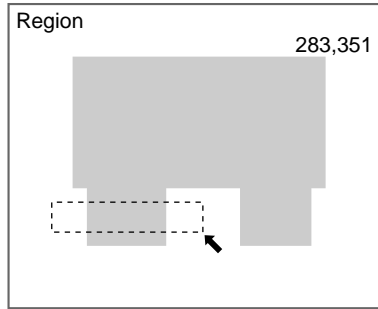

2. Draw a box-shaped region.

CHECK

The only figure that can be drawn is a box.

SeeAlso

Refer to page 28 for information on how to draw regions.

The region will be set and the screen in (1.) will return. The two edge positions (display cursors) and the measurement region will be displayed.

3-10-3 STEP 3: Re-registering Reference Value

This operation is performed when only the reference value is to be re-registered.

When a measurement region is drawn, the measurement is performed for the displayed image and the results are registered as the reference values. If the re-registering function explained here is used, only the reference values for the image currently displayed will be registered. Two edge positions (edge 1 and edge 2) and the edge width are registered for the reference values.

CHECK

The reference position can be changed to enable the following function when *Region* is selected.

Inspecting Positions from a Specified Point

Once the reference value (edge position) has been obtained for the image currently displayed, the reference position is changed to a suitable point. Position inspection can be performed by calculating the difference between this reference position and the measurement position.

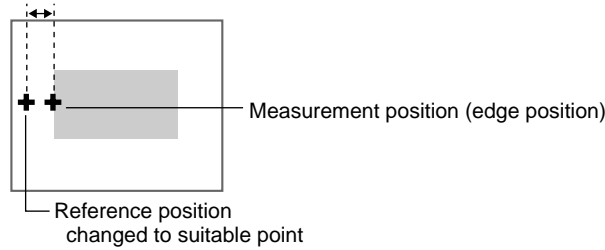

CHECK

When the measurement region is changed, the reference value returns to the default setting.

1. Select **Reference registration**.

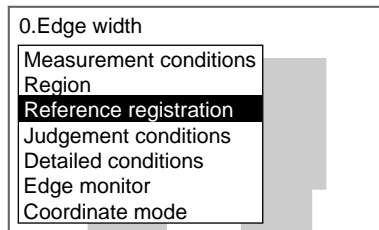

A cursor will appear at Edge 1 position.

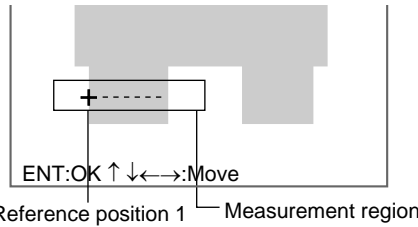

2. To change the position, use the **Up/Down** and **Right/Left** Keys to move the cursor.
3. Press the **ENT** Key to confirm the setting.

A cursor will appear at Edge 2 position.

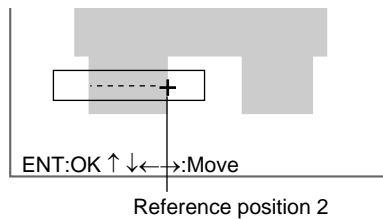

4. To change the position, use the **Up/Down** and **Right/Left** Keys to move the cursor.
5. Press the **ENT** Key to confirm the setting.
The setting will be registered and the screen in (1.) will return.

3-10-4 STEP 4: Setting Judgement Conditions

Set the width range for an OK judgement.

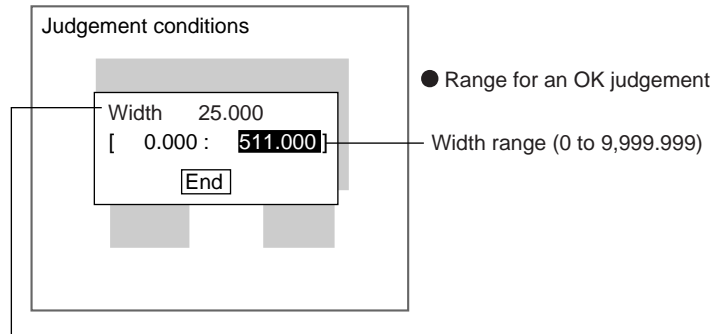

Measurement result for displayed image

1. Select **Judgement conditions**.

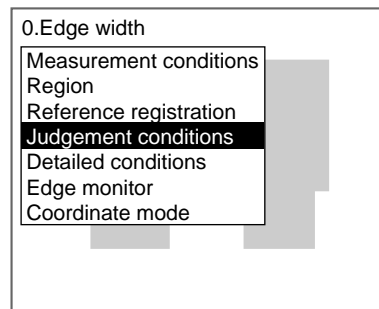

The Judgement Conditions Settings Screen will be displayed.

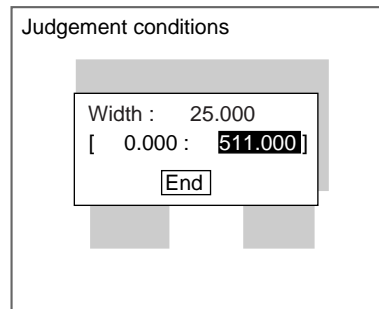

2. Make the width settings for an OK judgement.

SeeAlso

Refer to page 29 for details on inputting values.

3. Select **End**.

The settings will be registered and the screen in (1.) will return.

3-10-5 STEP 5: Changing Detailed Conditions

Change the detailed conditions when the measurement results are unstable. Normally, these conditions can be left on the default settings. After changing the settings, perform an object measurement to check that measurement can still be performed correctly.

1. Select **Detailed conditions**.

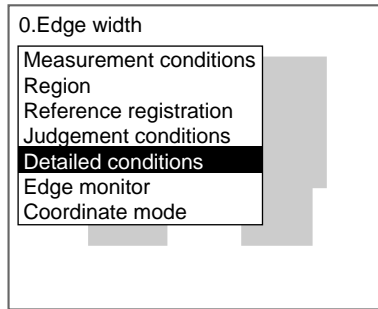

The Detailed Conditions Settings Screen will be displayed.

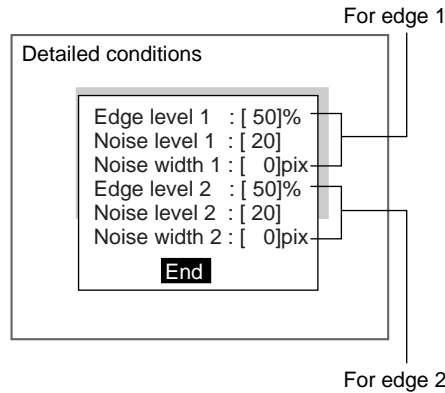

2. Change the settings.

SeeAlso

Refer to page 76 for information on edge levels, noise levels, and noise width.

SeeAlso

Refer to page 29 for details on inputting values.

3. Select **End**.

The settings will be registered and the screen in (1.) will return.

3-10-6 STEP 6: Monitoring the Density Distribution Near Edges

The density distribution and edge level within a region can be monitored on the screen. It is also possible to set the edge level while monitoring the density distribution. If the setting is changed, perform actual measurements to check whether or not correct measurement is possible.

Edge Detection in Horizontal Direction

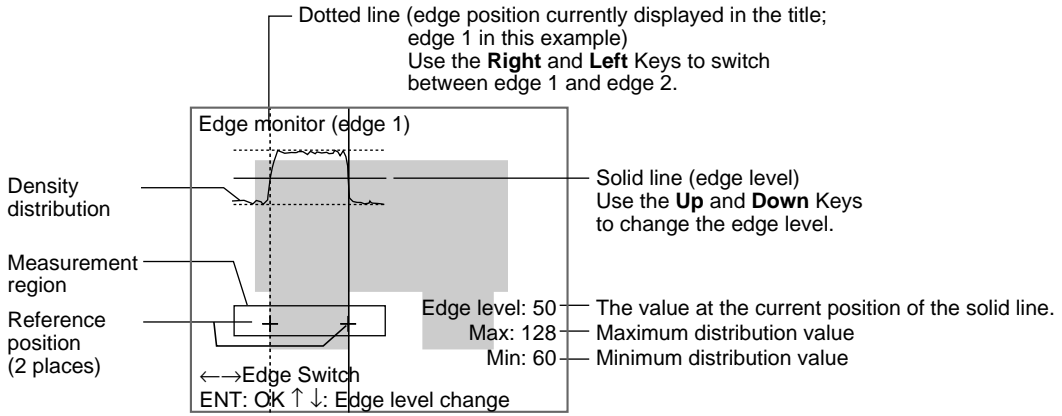

Edge Detection in Vertical Direction

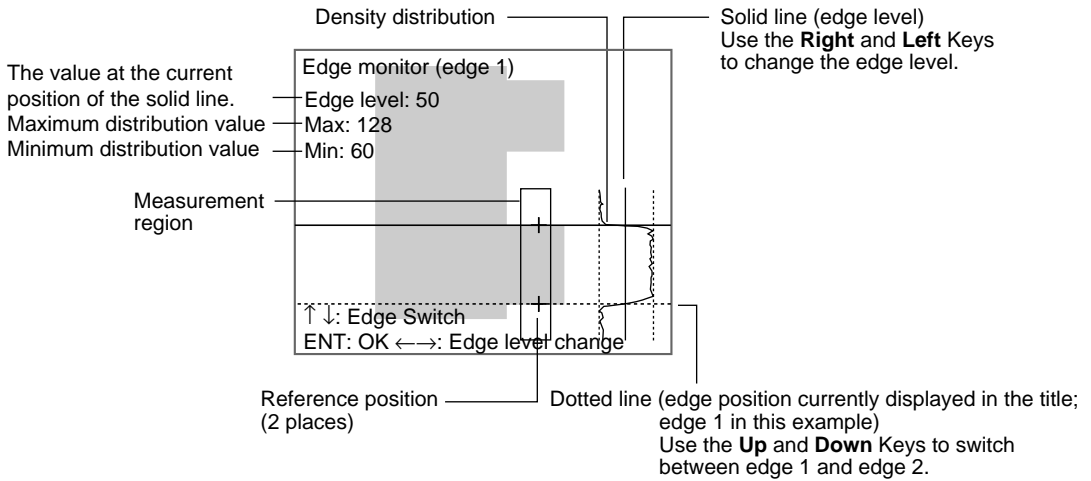

CHECK The edge level can also be set in the detailed conditions settings. (The value set last will be the valid one.)

SeeAlso Refer to page 142 for details on making detailed condition settings.

1. Select **Edge monitor**.

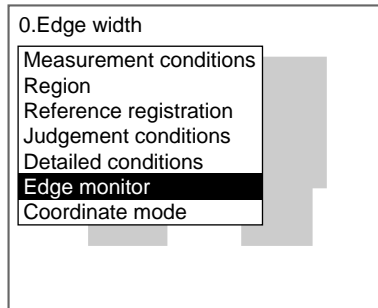

The Edge Monitor Screen will be displayed. If the edge level needs to be changed, go to step 2. If the edge level does not need to be changed, go step 4.

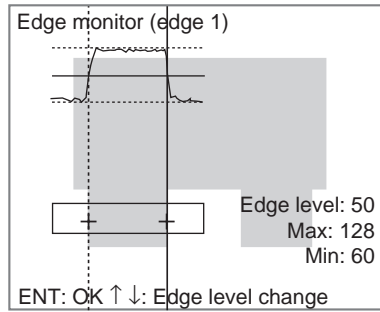

2. Use the **Up** and **Down** Keys to change the edge level.
3. Press the **ENT** Key to confirm the setting.
4. Press the **ESC** Key.

The screen for step 1 is returned. If the edge level was changed, the changes are registered.

3-10-7 STEP 7: Setting the Coordinate Mode

Select the type of coordinates.

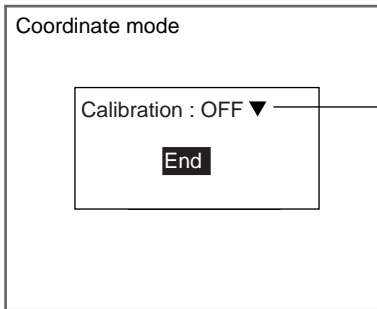

- ON: Output made using coordinate values set using calibration.
- OFF*: Output made using Camera coordinate values.

Refer to page 193 for information on calibration.

The default setting is marked with an asterisk.*

CHECK If the coordinate mode is changed after the judgement conditions have been set, the measurement results will change also. Change the judgement conditions to enable correct measurement.

1. Select **Coordinate mode**.

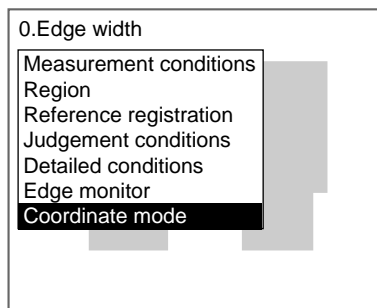

The Coordinate Mode Settings Screen will be displayed.

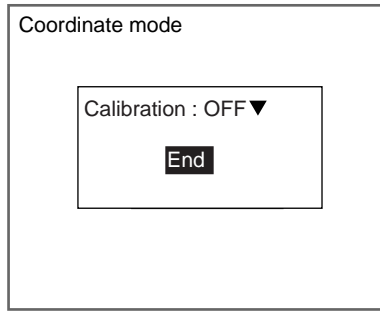

2. Make the settings for each item.
3. Select **End**.

The settings will be registered and the screen in (1.) will return.

3-11 Gray Search and Precise Search

Register an image pattern (called a model) in advance. The part of an input image that is most similar to the model is found, the position is calculated in pixel units, and the degree of similarity is expressed with a correlation value. Perform processing directly on the density image taken by the Camera.

SeeAlso Refer to page 11.

HELP Refer to page 330 for information on density images.

HELP Refer to page 331 for information on models.

Gray Search With a gray search, the position is obtained in pixel units.

Precise Search With a precise search, the position is obtained in sub-pixel (smaller than a pixel) units. The processing time is longer than that for gray search.

CHECK Use flexible searches when the shape of the model varies.

Operational Flow

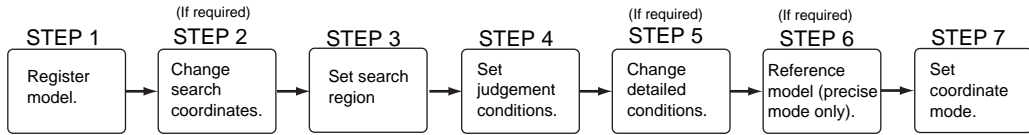

3-11-1 STEP 1: Registering the Model

The area of the image to be inspected is registered as a model. The model can be of any size.

When a model is registered, the center position of the model is registered as the search coordinates. When several figures have been combined in the drawing, the center coordinates of circumscribing rectangle becomes the search coordinates. This position becomes the reference position for position compensation, so be sure to place the measurement object in the correct position before drawing the measurement region.

CHECK Regions can be created by combining up to 3 different figures. Regions with difficult shapes can be drawn and sections not to be measured can be left out of the region by combining different figures.

1. Select **Measurement**<Region number>/**Gray search** (or **Precise search**).

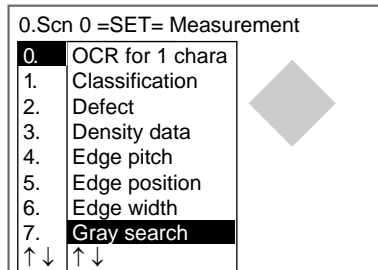

The initial screen for Gray Search will be displayed.

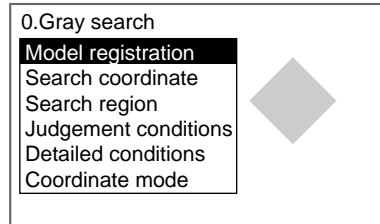

2. Select **Model registration**.

CHECK

When using precise search, the selection *Model reference* is displayed under *Coordinate mode*. The registered model can be referenced.

SeeAlso

Refer to page 154 for details on referencing the model.

The Model Registration Screen will be displayed.

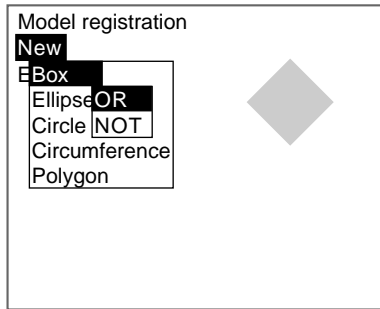

3. Select **New**.
4. Select the shape of the desired figure.
5. Select the desired drawing mode (**OR/NOT**).

Note Refer to page 28 for methods for drawing regions.

An arrow cursor will appear.

Up to three figures (0, 1, and 2) can be drawn.

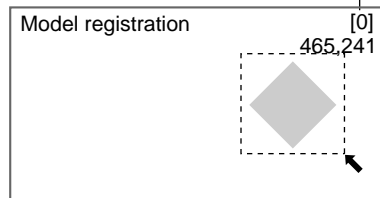

6. Draw the region to be registered as the model with the shape selected. The figure will be registered.

Once three figures have been drawn, **Add** will no longer be displayed.

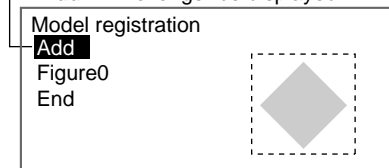

7. If additional figures are to be drawn, select **Add**.
8. Repeat steps 4 to 6 as necessary to create the desired shape.

- After drawing is completed, select **End**.

The measurement region will be registered and the screen in (2.) will return. The search coordinates (display cursor) and the model region will be displayed.

CHECK

Figures drawn using OR mode are displayed with solid lines and figures drawn using NOT mode are displayed with dotted lines.

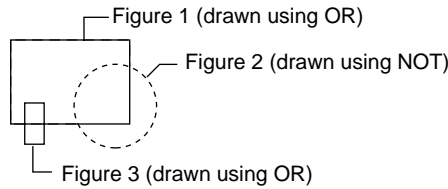

Correcting or Clearing Figures

- In the screen for step 7 above, select the figure to be changed or cleared using the **Up** and **Down** Keys and press the **ENT** Key.

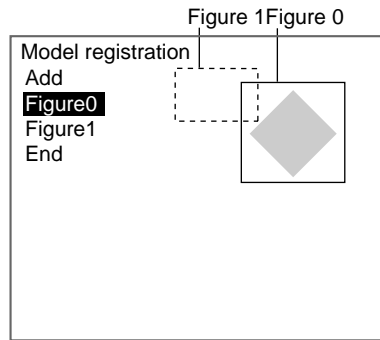

The figure for the figure number selected using the cursor will be displayed with solid lines. The selections **Correct** and **Clear** will be displayed.



- Select either **Correct** or **Clear** and press the **ENT** Key.
 If **Correct** is selected, the cursor will be displayed. Correct the size and position of the figure as desired.
 If **Clear** is selected, the selected figure will be cleared.

CHECK

To re-register a model, repeat the procedure from step 2 of *Step 1: Registering the Model*.

3-11-2 STEP 2: Changing the Search Coordinates

Use this function to change the search coordinates only.

When a model is registered, the center position of the model is registered as the search coordinates. This function can be used to register a point other than the center of the model as the search coordinates.

CHECK

The search coordinates are used for the point output as the measurement value. This point can be changed to any suitable point.

Changing the Point Output as the Measurement Value

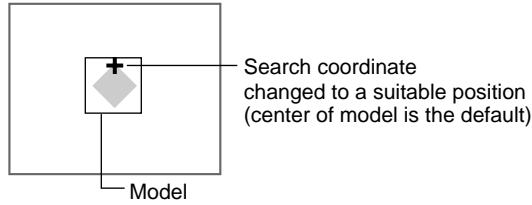

CHECK If the model is re-registered, the search coordinates are changed to the center position of the new model.

1. Select **Search coordinates**.

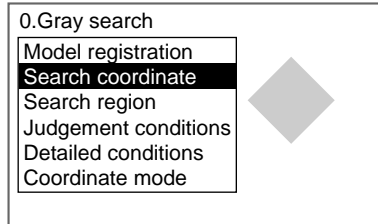

CHECK When using precise search, the selection *Model reference* is displayed under *Coordinate mode*. The registered model can be referenced.

SeeAlso

Refer to page 154 for details on referencing the model.

A cursor will appear in the center position.

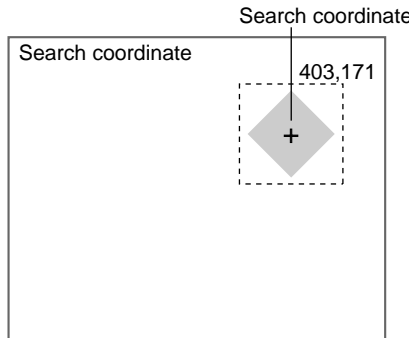

2. To change the position, use the **Up/Down** and **Right/Left** Keys to move the cursor.
3. Press the **ENT** Key to confirm the setting.
The setting will be registered and the screen in (1.) will return.

3-11-3 STEP 3: Setting the Search Region

Set the region in which the model is to be searched for. It is possible to perform a search for the entire input image but processing time can be reduced and accuracy can be increased by setting limits on the search range.

1. Select **Search region**.

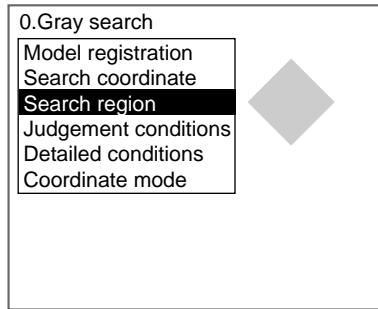

CHECK

When using precise search, the selection *Model reference* is displayed under *Coordinate mode*. The registered model can be referenced.

SeeAlso

Refer to page 154 for details on referencing the model.

An arrow cursor will appear.

The model will be displayed in solid lines.

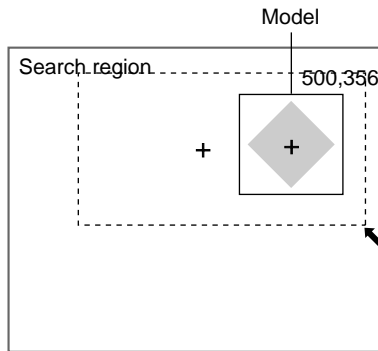

2. Draw a box-shaped search region.

CHECK

The only figure that can be drawn is a box.

SeeAlso

Refer to page 28 for methods for drawing regions.

The search region will be set and the screen in (1.) will return.

3-11-4 STEP 4: Setting Judgement Conditions

Set the judgement conditions for the correlation with the model and for the position (X, Y) where the object was detected.

<p>Judgement conditions</p> <p>Correlation : 79 [60 : 100]</p> <p>Position X : 180.000</p> <p>[0.000 : 511.000]</p> <p>Position Y : 250.000</p> <p>[0.000 : 483.000]</p> <p>[End]</p>	<p>● Range for an OK judgement.</p> <p>— Correlation range (0 to 100)</p> <p>— Range of movement of the measurement object in the X direction (–9,999.999 to 9,999.999)</p> <p>— Range of movement of the measurement object in the Y direction (–9,999.999 to 9,999.999)</p>
---	---

○ The measurement results for the displayed image.
Use these values as references in setting the upper and lower limits.

CHECK Correlation

When OK condition for correlation is set between 60 and 100:

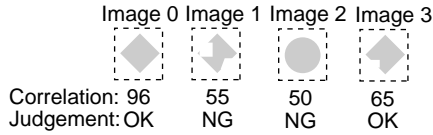

CHECK Position X and Position Y

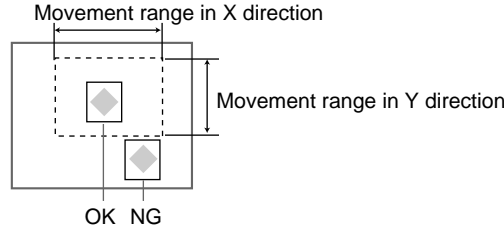

1. Select **Judgement conditions**.

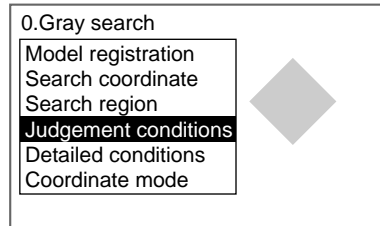

CHECK

When using precise search, the selection *Model reference* is displayed under *Coordinate mode*. The registered model can be referenced.

SeeAlso

Refer to page 154 for details on referencing the model.

The Judgement Conditions Settings Screen will be displayed.

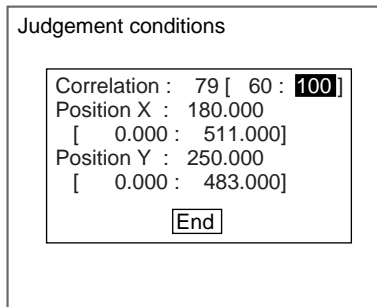

2. Make the settings.

SeeAlso

Refer to page 29 for details on inputting values.

3. Select **End**.

The settings will be registered and the screen in (1.) will return.

3-11-5 STEP 5: Changing Detailed Conditions

Search-related settings can be changed under *Detailed conditions*. Change the detailed conditions when the measurement results are unstable and to increase processing speed. Change the candidate level, model skipping, search skipping, and detailed model skipping (See note.) as required. Normally, these four conditions can be left at the default settings.

After changing the settings, perform an object measurement to check that measurement can still be performed correctly.

Note Detailed model skipping is displayed only for gray searches.

SeeAlso Refer to page 111 for information on each setting item.

1. Select **Detailed conditions**.

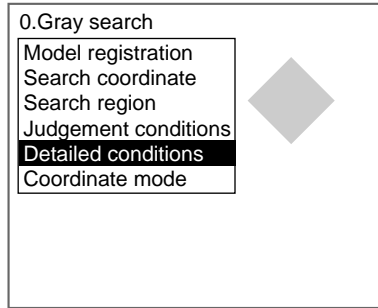

CHECK

When using precise search, the selection *Model reference* is displayed under *Coordinate mode*. The registered model can be referenced.

SeeAlso

Refer to page 154 for details on referencing the model.

The Detailed Conditions Settings Screen will be displayed.

Use the **Down** Key to scroll through the setting items.

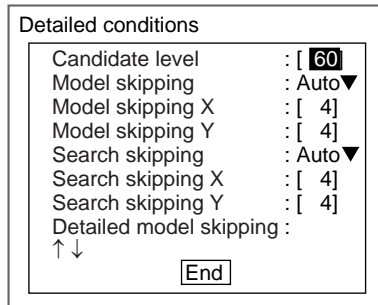

2. Change the settings.

SeeAlso

Refer to page 29 for details on inputting values.

3. Select **End**.

The settings will be registered and the screen in (1.) will return.

3-11-6 STEP 6: Referencing the Model

This item is displayed only when using precise search. It is possible to confirm what kind of image is registered as the model by displaying it on the screen.

- 1. Select **Model reference**.

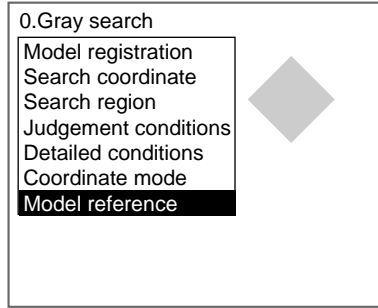

The image registered as the model is displayed on the screen.

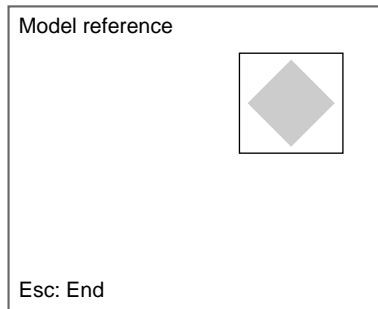

- 2. Press the **ESC** Key.
The screen in (1.) will return.

3-11-7 STEP 7: Setting the Coordinate Mode

Select the type of coordinates.

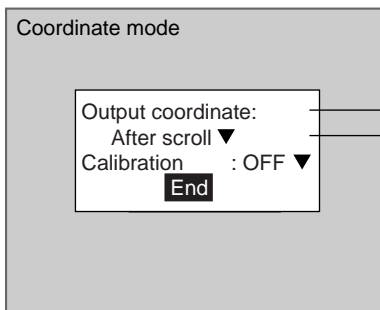

Before scroll: Output made using the coordinate values before position displacement compensation.
 After scroll*: Output made using the coordinate values after position displacement compensation.
 Refer to page 205 for position compensation.
 Refer to page 330 for differences between output coordinates.
 ON : Output made using coordinate values set using calibration.
 OFF*: Output made using Camera coordinate values.
 Refer to page 193 for information on calibration.

The default settings are marked with asterisks.*

CHECK If the coordinate mode is changed after the judgement conditions have been set, the measurement results will change also. Change the judgement conditions to enable correct measurement.

1. Select **Coordinate mode**

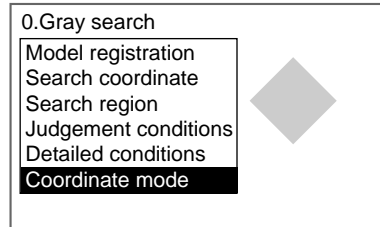

CHECK

When using precise search, the selection *Model reference* is displayed under *Coordinate mode*. The registered model can be referenced.

SeeAlso

Refer to page 154 for details on referencing the model. The Coordinate Mode Settings Screen will be displayed.

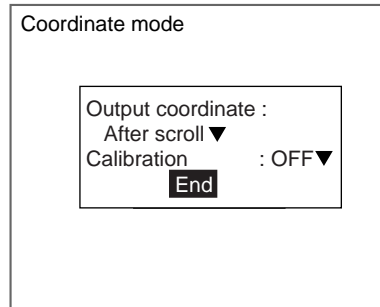

2. Make the settings for each item.
3. Select **End**.

The settings will be registered and the screen in (1.) will return.

3-12 Flexible Search

Use flexible search to identify the shapes of inconsistent measurement objects.

Multiple image patterns (called models) that will serve as references are registered beforehand. The area that is most similar to the multiple models is found in the input image, the position is calculated in pixel units and a correlation displayed to show how similar the area is to the model. The images read by the Camera are processed as is, i.e., as density images.

SeeAlso Refer to page 11.

HELP Refer to page 330 for information on density images.

HELP Refer to page 331 for information on models.

CHECK The search coordinates is fixed at the center position of the model.

Operational Flow

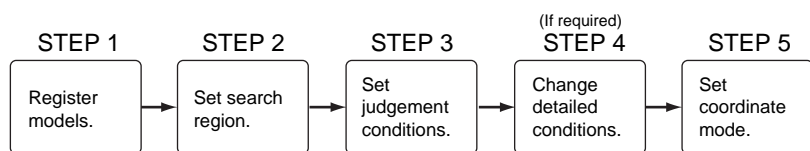

3-12-1 STEP 1: Registering Models

The area of the image to be inspected is registered as a model. Up to 5 models can be registered (0 to 4) and the models can be of any size.

Register more than model if there are variations in the printing quality and shape.

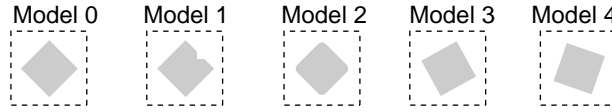

When a model is registered, the center position of the model is registered as the search coordinates. When several figures have been combined in the drawing, the center coordinates of the circumscribing rectangle become the search coordinates.

CHECK Models can be created by combining up to 3 different figures. Regions with difficult shapes can be drawn and sections not to be measured can be left out of the region by combining different figures.

CHECK When multiple models are registered to the same index number, the F160 automatically creates auxiliary models between the models that are registered. If the auxiliary models are added to the registered models when searches are performed, stable searches are possible even if there are variations between the registered models. You can select whether or not to use auxiliary models in searches under *Detailed settings*. Refer to page 331 for information on auxiliary models.

1. Select **Measurement**/**<Region number>/Flexible search**.

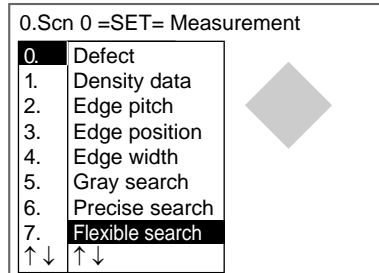

The initial screen for Flexible search will be displayed.

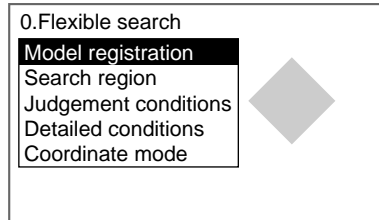

2. Select **Model Registration**.

The Model Registration Screen will be displayed.

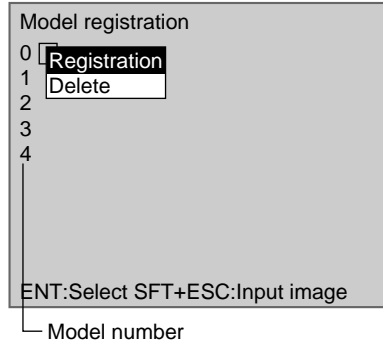

3. Press the **ENT** Key at model number **0**.
4. Select **Registration**.

The selection items will be displayed.

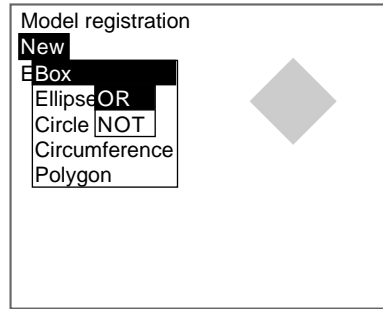

5. Select **New**.
6. Select the shape of the desired figure.
7. Select the desired drawing mode (**OR/NOT**).

SeeAlso

Refer to page 28 for methods for drawing regions.
The arrow cursor will be displayed.

Up to three figures (0, 1, and 2) can be drawn.

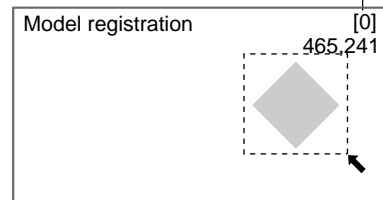

- 8. Draw the model region with the shape selected.

The figure will be registered.

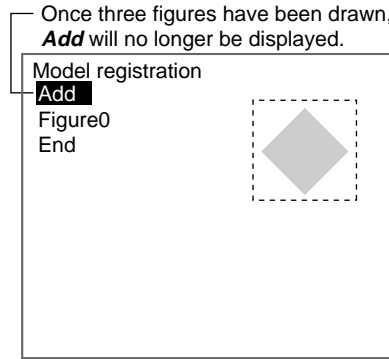

- 9. If additional figures are to be drawn, select **Add**.
- 10. Repeat steps 6 to 8 as necessary to create the desired shape.
- 11. After drawing is completed, select **End**.

The Model 0 settings will be registered and the screen in (3.) will return. The registered model is displayed as a thumbnail.

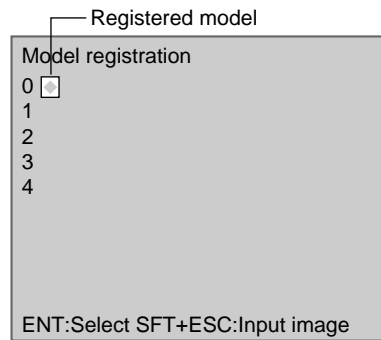

- 12. Repeat steps 3 to 11 to register further models.

CHECK

To refresh the display image, press the SHIFT + ESC Keys at the Model Registration Screen. The image input screen will be displayed. Press the TRIG Key to update to the latest camera image.

SeeAlso

Refer to page 104 for information on classification.

- 13. Press the **ESC** Key to finish registering models. The settings will be saved and the screen in (2.) will return.

Correcting or Clearing Figures

- 1. In the screen for step 9 above, select the figure to be changed or cleared using the **Up** and **Down** Keys and press the **ENT** Key.

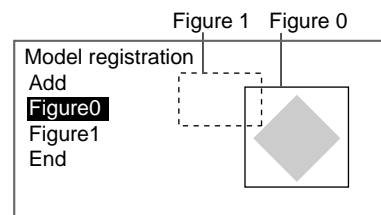

The figure for the figure number selected using the cursor will be displayed with solid lines. The selections **Correct** and **Clear** will be displayed.

Correct
Clear

2. Select either **Correct** or **Clear** and press the **ENT** Key.
If **Correct** is selected, the cursor will be displayed. Correct the size and position of the figure as desired.
If **Clear** is selected, the selected figure will be cleared.

Clearing or Overwriting Registered Models

1. Select the model to be cleared or overwritten from the thumbnails and press the **ENT** Key.

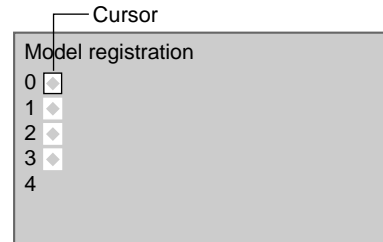

The selections **Registration** and **Delete** will be displayed.

Registration
Delete

2. Select either **Registration** or **Delete** and press the **ENT** Key.
If **Registration** is selected, the Model Registration Screen will be displayed. Register the model.
If **Delete** is selected, the selected model will be deleted.

3-12-2 STEP 2: Setting Search Regions

Set the region to search for the model. The whole region of the input image can be searched, however processing time can be reduced and accuracy improved by limiting the search region.

1. Select **Search region**.

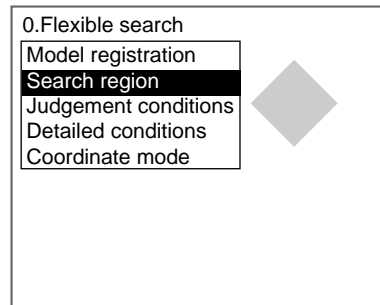

An arrow cursor will appear.

The model will be displayed with solid lines.

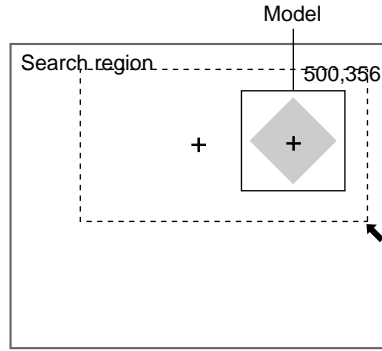

2. Draw a box-shaped search region.

CHECK

The only figure that can be drawn is a box.

SeeAlso

Refer to page 28 for methods for drawing regions. The search region will be set and the screen in (1.) will return

3-12-3 STEP 3: Setting Judgement Conditions

Set the judgement conditions for the correlation between the measurement image and the models and the position (X, Y) where the object was detected.

Judgement conditions

Correlation : 60 :

Position X :

[0.000 : 511.000]

Position Y :

[0.000 : 483.000]

- Range for an OK judgement.
- Correlation range (0 to 100)
- Range of movement of the measurement object in the X direction (-9,999.999 to 9,999.999)
- Range of movement of the measurement object in the Y direction (-9,999.999 to 9,999.999)

○ : Measurement results for the displayed image.
Use these values as references for setting upper and lower limits.

CHECK

Correlation

When OK condition for correlation is set between 60 and 100:



CHECK

Position X and Position Y

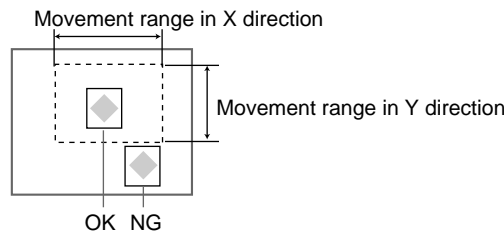

1. Select **Judgement conditions**.

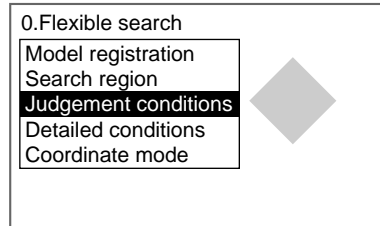

The Judgement Conditions Settings Screen will be displayed.

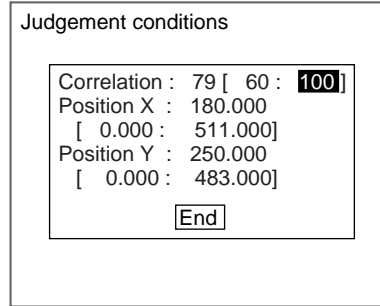

2. Make the settings.

SeeAlso

Refer to page 29 for details on inputting values.

3. Select **End**.

The settings will be registered and the screen in (1.) will return.

3-12-4 STEP 4: Changing Detailed Conditions

Search-related settings can be changed under *Detailed conditions*. Change the detailed conditions when the measurement results are unstable and to increase processing speed. Normally, these conditions can be left at the default settings. After changing the settings, perform an object measurement to check that measurement can still be performed correctly.

1. Select **Detailed conditions**.

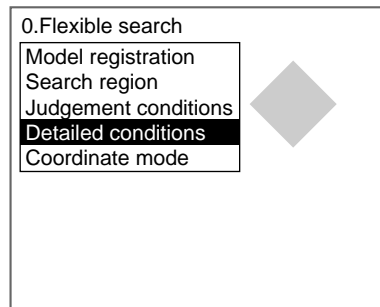

The Detailed Conditions Settings Screen will be displayed.

Use the **Down** Key to scroll through the setting items.

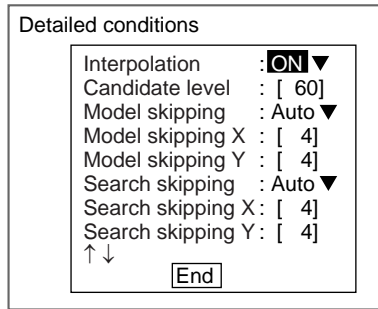

2. Change the settings.

SeeAlso

Refer to page 29 for details on inputting values.

3. Select **End**.

The settings will be registered and the screen in (1.) will return.

3-12-5 STEP 5: Setting the Coordinate Mode

Select the type of coordinates.

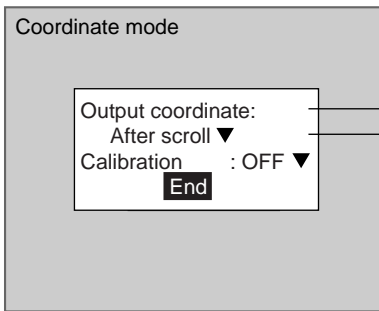

Before scroll: Output made using the coordinate values before position displacement compensation.

After scroll*: Output made using the coordinate values after position displacement compensation.

Refer to page 205 for position compensation.

Refer to page 330 for differences between output coordinates.

ON : Output made using coordinate values set using calibration.

OFF*: Output made using Camera coordinate values.

Refer to page 193 for information on calibration.

The default settings are marked with asterisks.*

CHECK

If the coordinate mode is changed after the judgement conditions have been set, the measurement results will change also. Change the judgement conditions to enable correct measurement.

1. Select **Coordinate mode**.

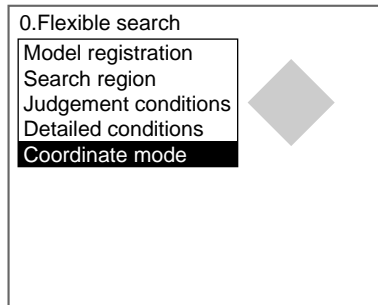

The Coordinate Mode Settings Screen will be displayed.

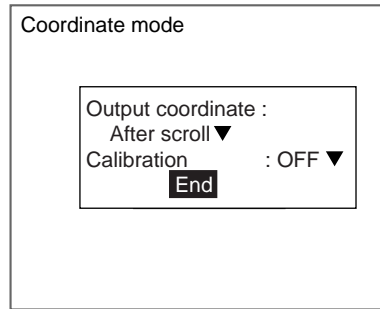

2. Make the settings for each item.
3. Select **End**.

The settings will be registered and the screen in (1.) will return.

3-13 Labeling

The labeling function counts how many labels there are in a measurement region and calculates the area and center of gravity for the specified label numbers. Images read by the Camera are converted to binary images and the white pixels are measured.

SeeAlso Refer to page 12.

Operational Flow

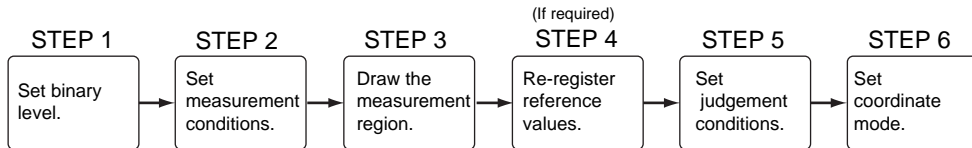

3-13-1 STEP 1: Setting the Binary Level

Set the level for converting 256-gradation images into binary images. The F160 performs measurement for the white pixels. Therefore, make the settings so that the label measurement areas are white.

In this explanation, 3 circles on a measurement object will be used as an example.

1. Select **Measurement**/**<Region number>**/**Labeling**.

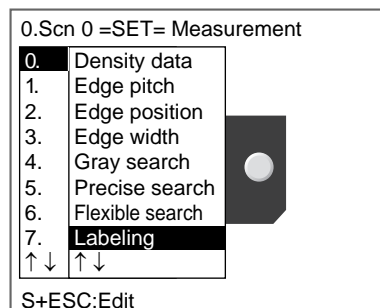

The initial screen for Labeling will be displayed.

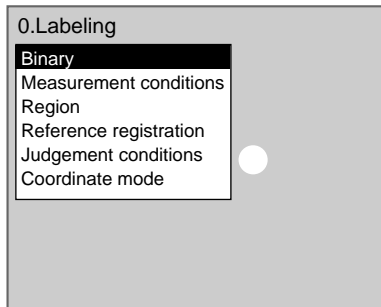

2. Select **Binary**.

The Binary Settings Screen will be displayed.

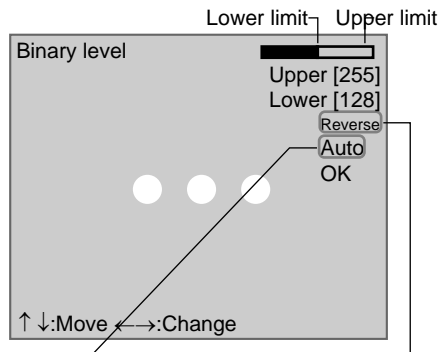

Auto
The F160 automatically sets the binary level

Reverse
Reverses dark and white in the display

3. Move the cursor to the upper limit and use the **Left** and **Right** Keys to change the value.

Right Key: Increases the lowest digit by one.

SHIFT + Right Keys: Increases the value in 10s.

Left Key: Decreases the lowest digit by one.

SHIFT + Left Keys: Decreases the value in 10s.

Up and Down Keys: Switches between setting items.

4. Use the same method to change the lower value.

Set the upper and lower limits to make the area to be measured for labels white.

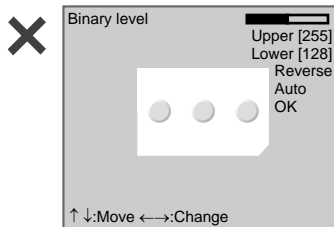

5. Select **OK**.

The settings will be registered and the screen in (2.) will return.

CHECK

It is also possible to set the binary level so that measurement is performed only for an intermediate density range.

3-13-2 STEP 2: Setting Measurement Conditions

Set the *Area*, *Sort*, and *Label No.* conditions for label measurement.
Change the other settings as well when necessary.

Default settings are indicated with an asterisk.

Conditions for reassigning label numbers

- Area descending order:* Sorts in descending order by area.
- Area ascending: Sorts in ascending order by area.
- X coordinate descending: Sorts in descending order by center of gravity X coordinate. (See note.)
- X coordinate ascending: Sorts in ascending order by center of gravity X coordinate. (See note.)
- Y coordinate ascending: Sorts in descending order by center of gravity Y coordinate. (See note.)
- Y coordinate ascending: Sorts in ascending order by center of gravity Y coordinate. (See note.)

Note When X and Y center of gravity are sorted, the upper left corner of the measurement region is the origin.

CHECK The coordinates set using calibration are not affected by labeling.

CHECK When *Position compensation* is set, the sort is performed on center of gravity coordinates *after* position compensation.

1. Select **Measurement conditions**.

The Measurement Conditions Settings Screen will be displayed.

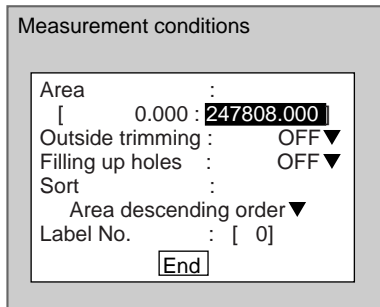

2. Change the settings.

SeeAlso

Refer to page 29 for details on inputting values.

The settings will be registered and the screen in (1.) will return.

CHECK

Outside Trimming

Select *Outside trimming* when there is a white-pixel area inside the measurement region that is not to be measured.

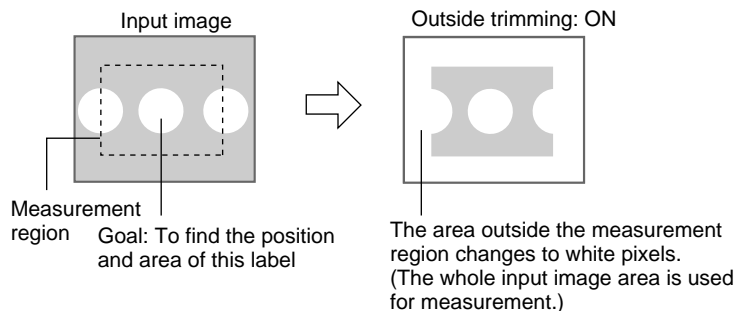

The position and the size of the middle label will be found if the following conditions are set:
 Sort conditions: Area, ascending order
 Label number: 1

CHECK

Filling Up Holes

Use the *Filling up holes* setting to specify how areas of black pixels contained inside donut-shaped areas of white pixels are processed. If selected, the black pixels will be processed as white pixels.

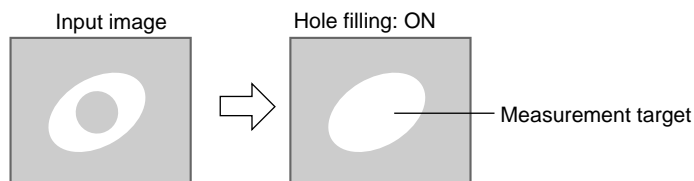

3-13-3 STEP 3: Drawing Measurement Regions

When a measurement region is drawn, measurement is performed for the displayed image and the results are registered as the reference values (area and the position of center of gravity of the label number specified under *Measurement conditions*). This position becomes the reference position for position compensation, so be sure to place the measurement object in the correct position before drawing the measurement region.

CHECK Regions can be created by combining up to 3 different figures. Regions with difficult shapes can be drawn and sections not to be measured can be left out of the region by combining different figures.

1. Select **Region**.

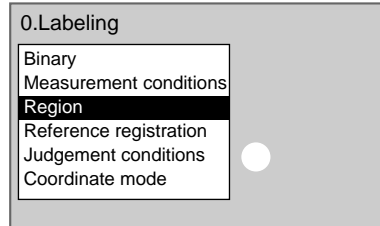

The Region Settings Screen will be displayed.

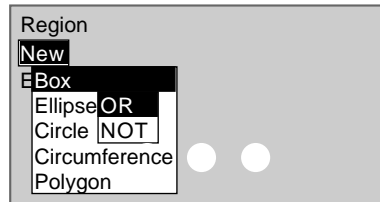

2. Select **New**.
3. Select the shape of the desired figure.
4. Select the desired drawing mode (**OR/NOT**).

SeeAlso

Refer to page 28 for methods for drawing regions.

An arrow cursor will appear.

Up to three figures (0, 1, and 2) can be drawn.

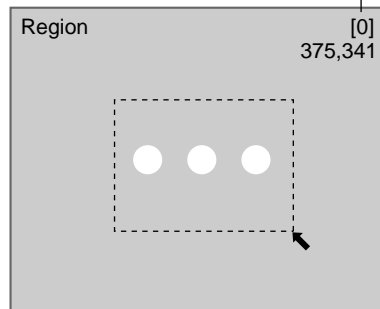

5. Draw the region with the shape selected.

The figure will be registered.

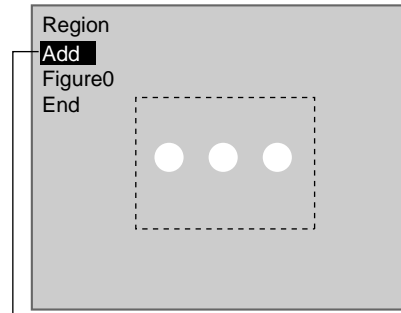

Once three figures have been drawn, **Add** will no longer be displayed.

6. If additional figures are to be drawn, select **Add**.
7. Repeat steps 3 to 5 as necessary to create the desired shape.
8. After drawing is completed, select **End**.

The measurement region will be registered and the screen in (1.) will return.

The center of gravity (display cursor) and measurement region will be displayed.

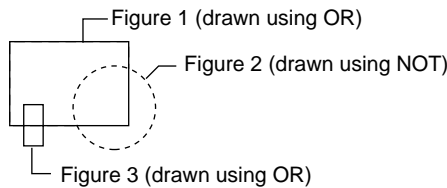

CHECK

Figures drawn using OR mode are displayed with solid lines and figures drawn using NOT mode are displayed with dotted lines.

Correcting or Clearing Figures

1. In the screen for step 6 above, select the number of the figure to be changed or cleared using the **Up** and **Down** Keys and press the **ENT** Key.

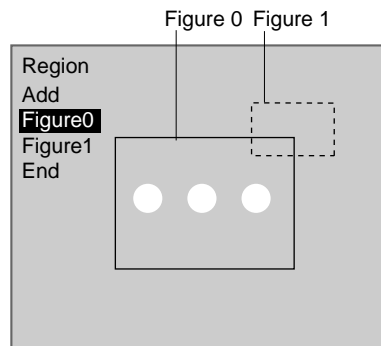

The figure for the figure number selected using the cursor will be displayed with solid lines. The selections **Correct** and **Clear** will be displayed.



2. Select either **Correct** or **Clear** and press the **ENT** Key.

If **Correct** is selected, the cursor will be displayed. Correct the size and position of the figure as desired.

If **Clear** is selected, the selected figure will be cleared.

3-13-4 STEP 4: Re-registering Reference Values

This operation is performed when only the reference values are to be re-registered.

When a measurement region is drawn, the measurement is performed for the displayed image and the results are registered as the reference values. If the re-registering function explained here is used, only the reference values for the image currently displayed will be registered. The area and center of gravity of the specified label number is registered for the reference value.

CHECK

The reference position can be changed to enable the following function when *Region* is selected.

Inspecting Positions from a Specified Point

Once the reference values (area and center of gravity) have been obtained for the image currently displayed, the reference position is changed to an suitable point. Position inspection can be performed by calculating the difference between this reference position and the measurement position.

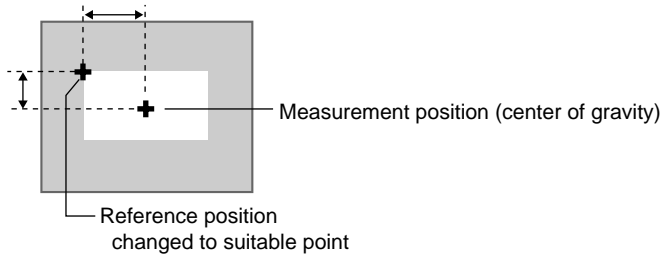

CHECK

When the measurement region is changed, the reference values return to the default setting.

1. Select **Reference registration**.

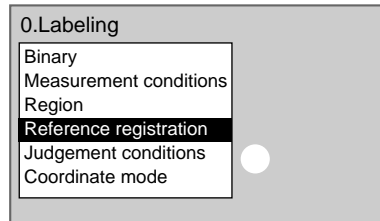

A cursor will appear at the center of gravity of the label number set under *measurement conditions*.

If the following conditions are set, the screen shown in the following diagram will be displayed:

Sort conditions: X center of gravity, ascending
 Label number: 0

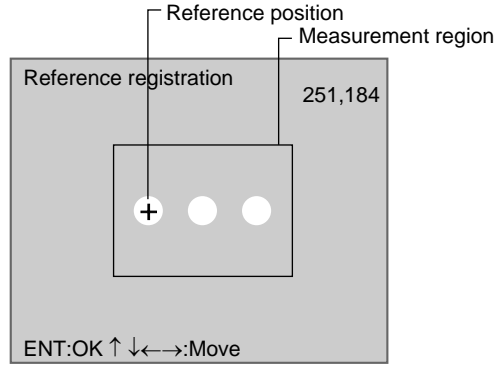

2. To change the position, use the **Up/Down** and **Right/Left** Keys to move the cursor.
3. Press the **ENT** Key to confirm the setting.
 The setting will be registered and the screen in (1.) will return.

3-13-5 STEP 5: Setting Judgement Conditions

Set the ranges for the number of labels, area and center of gravity for an OK judgement.

Judgement conditions

Number of labels : 8 [0: 2500]

Judge area : 2035.000
 [0.000 : 247808.000]

Gravity X : 26.000
 [0.000 : 511.000]

Gravity Y : 157.000
 [0.000 : 483.000]

[End]

● Ranges for an OK judgement

Range for number of labels in measurement region (0 to 2,500)

Range for specified label number area (0 to 9,999,999.999)

Range of movement in X direction for specified label number (–9,999.999 to 9,999.999)

Range of movement in Y direction for specified label number (–9,999.999 to 9,999.999)

○ : Measurement results for the displayed image.
 Use these values as references for setting upper and lower limits.

1. Select **Judgement conditions**.

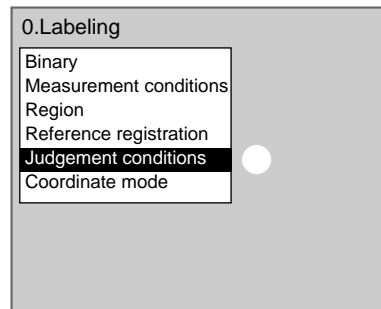

The Judgement Conditions Settings Screen will be displayed.

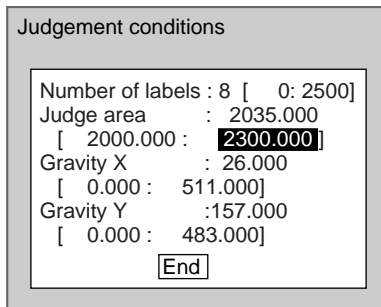

2. Make the settings for each item.

SeeAlso

Refer to page 29 for details on inputting values.

3. Select **End**.

The settings will be registered and the screen in (1.) will return.

3-13-6 STEP 6: Setting the Coordinate Mode

Select the type of coordinates.

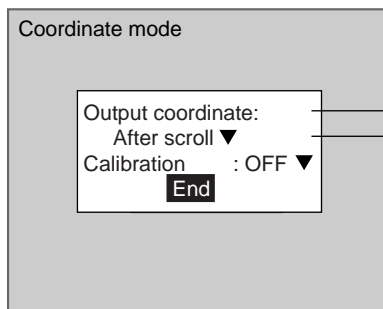

Before scroll: Output made using the coordinate values before position displacement compensation.

After scroll*: Output made using the coordinate values after position displacement compensation.

Refer to page 205 for position compensation.

Refer to page 330 for differences between output coordinates.

ON : Output made using coordinate values set using calibration.

OFF*: Output made using Camera coordinate values.

Refer to page 193 for information on calibration.

The default settings are marked with asterisks.*

CHECK

If the coordinate mode is changed after the judgement conditions have been set, the measurement results will change also. Change the judgement conditions to enable correct measurement.

1. Select **Coordinate mode**.

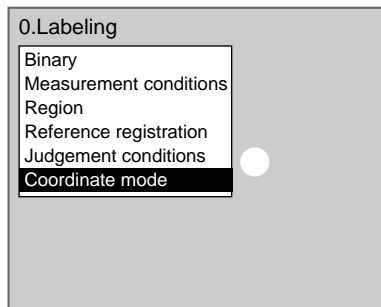

The Coordinate Mode Settings Screen will be displayed.

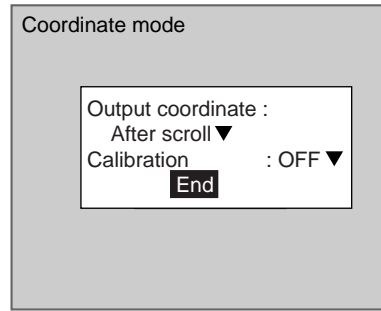

2. Make the settings for each item.
3. Select **End**.

The settings will be registered and the screen in (1.) will return.

3-14 Relative Search

Use this method to obtain the positions of markings, holes, and other features, and to judge whether these features are within acceptable ranges. This method is based on relative position, so models must be registered in two positions: A measurement position and a reference position.

SeeAlso Refer to page 13.

Operational Flow

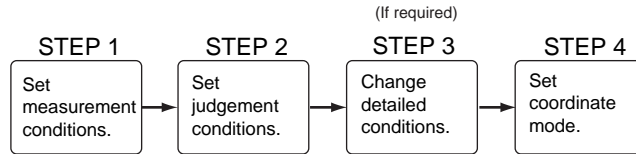

3-14-1 STEP 1: Setting Measurement Conditions

Set the conditions for measuring the detection and reference positions.

1. Register the models.
The reference and measurement positions are registered as Model 0 and Model 1.

When a model is registered, the center position of the model is registered as the search coordinates. When several figures have been combined in the drawing, the center coordinates of circumscribing rectangle becomes the search coordinates.

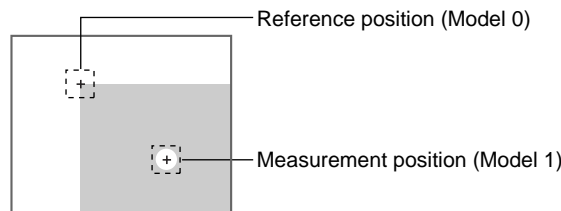

CHECK

Models can be created by combining up to 3 different figures. Regions with difficult shapes can be drawn and sections not to be measured can be left out of the region by combining different figures.

CHECK

It does not matter whether the reference position or measurement position is registered as Model 1 or Model 2. Decide which is registered as which model, based on whether the width is to be output as a positive or negative value. The coordinates will depend on the calibration setting.

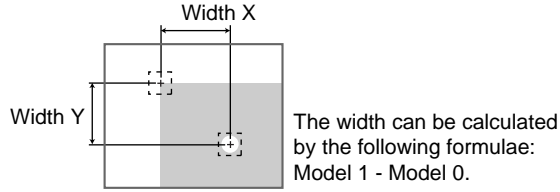

When *Model 0 setting* or *Model 1 setting* is selected, the settings for that model number are displayed. In this example, *Model 0 setting* is selected. Make adjustments as necessary when *Model 1 setting* is selected.

- a) Select **Measurement**/*<Region number>*/**Relative search**.

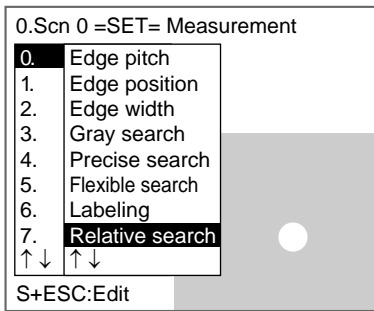

The Relative Search Settings Screen will be displayed.

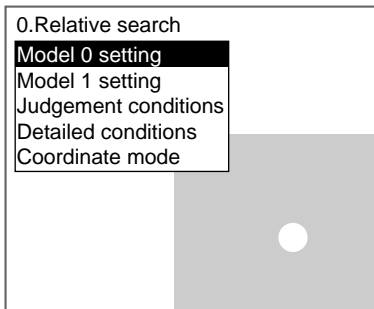

- b) Select **Model 0 setting**.

The setting selections will be displayed.

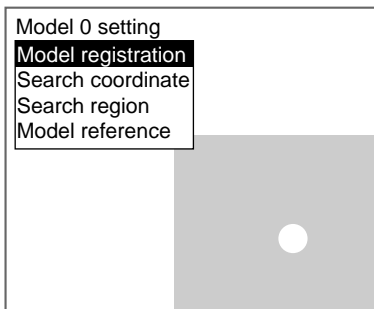

- c) Select **Model registration**.

The Model Registration Screen will be displayed.

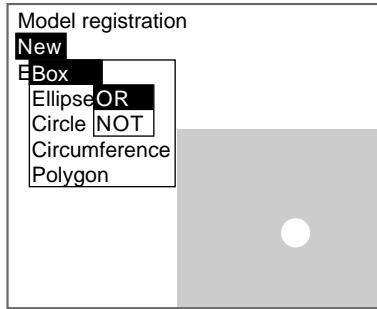

- d) Select **New**.
- e) Select the shape of the desired figure.
- f) Select the desired drawing mode (**OR/NOT**).

SeeAlso

Refer to page 28 for methods for drawing regions.
An arrow cursor will appear.

Up to three figures (0, 1, and 2) can be drawn.

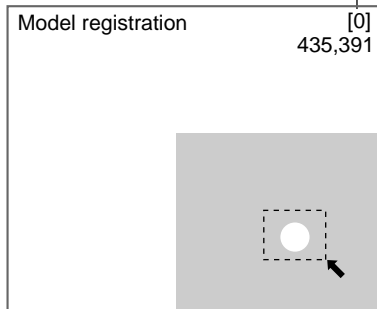

- g) With the shape selected, draw the region to register as the model.
The figure will be registered.

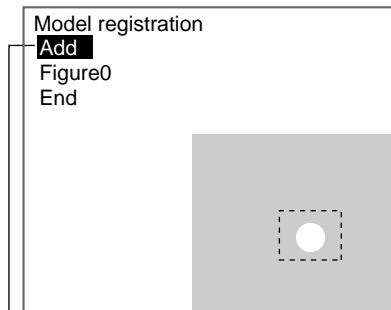

Once three figures have been drawn, **Add** will no longer be displayed.

- h) If additional figures are to be drawn, select **Add**.
- i) Repeat steps e) to g) as necessary to create the desired shape.
- j) After drawing is completed, select **End**.
The measurement region will be registered and the screen in c) will return.

The search coordinates (display cursor) and the model region will be displayed.

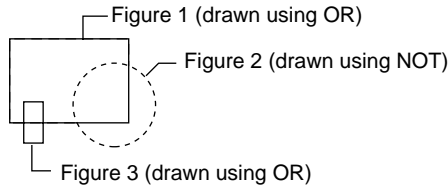

CHECK

Figures drawn using OR mode are displayed with solid lines and figures drawn using NOT mode are displayed with dotted lines.

Correcting or Clearing Figures

In the screen for h) above, select the figure to be changed or cleared using the **Up** and **Down** Keys and press the **ENT** Key.

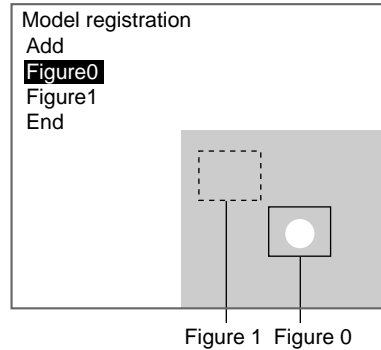

The figure for the figure number selected using the cursor will be displayed with solid lines. The selections **Correct** and **Clear** will be displayed.



Select either **Correct** or **Clear** and press the **ENT** Key.

If **Correct** is selected, the cursor will be displayed. Correct the size and position of the figure as desired.

If **Clear** is selected, the selected figure will be cleared.

2. Changing the Search Coordinates

Use this function to change the search coordinates only.

When a model is registered, the center position of the model is registered as the search coordinates. However, this function can be used to register a point other than the center of the model as the search coordinates.

CHECK

The search coordinates are used as the point output as the measurement value. This point can be changed to any suitable point.

Changing the Point Output as the Measurement Value

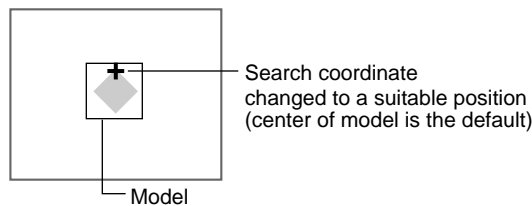

CHECK

If the model is re-registered, the search coordinates are changed to the center position of the new model.

- a) Select **Search coordinates**.

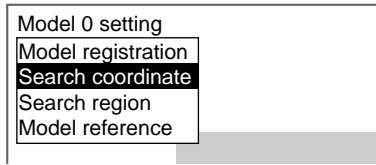

A display cursor will appear in the center position.

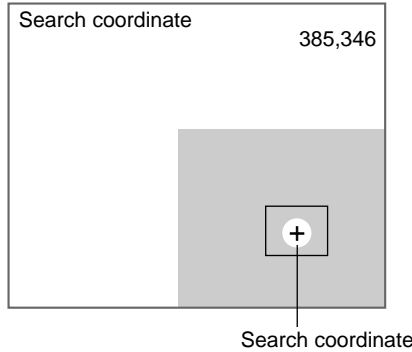

- b) To change the position, use the **Up/Down** and **Right/Left** Keys to move the cursor.
- c) Press the **ENT** Key to confirm the setting.

The setting will be registered and the screen in a) will return.

3. Setting the Search Region

Set the region for which the model is to be searched. It is possible to perform a search for the entire input image but processing time can be reduced and accuracy can be increased by setting limits on the search range.

- a) Select **Search region**.

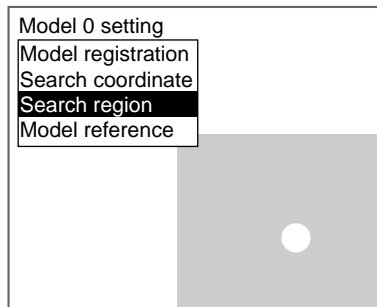

An arrow cursor will appear.

The model will be displayed with solid lines.

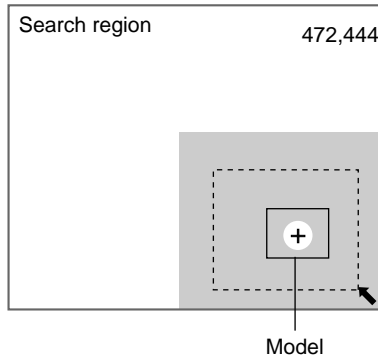

- b) Draw a box-shaped search region.

CHECK

The only figure that can be drawn is a box.

SeeAlso

Refer to page 28 for methods for drawing regions.

The search region will be set and the screen for step a) will return.

- 4. Referencing the Model
It is possible to confirm what kind of image is registered as the model by displaying it on the screen.

- a) Select **Model reference**.

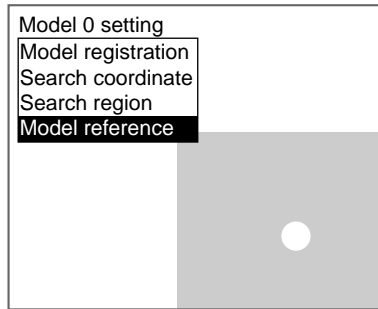

The image registered as the model is displayed on the screen.

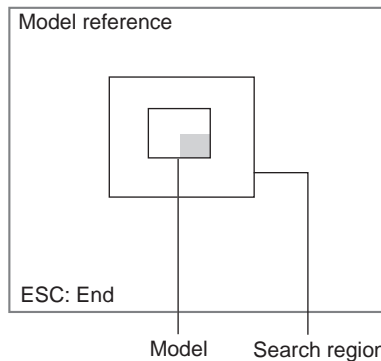

- b) Press the **ESC** Key.

The screen in (1.) will return.

3-14-2 STEP 2: Setting Judgement Conditions

Set the ranges for model and measurement object correlation and the relative search conditions for Models 0 and 1 for an OK judgement.

Judgement conditions

Correlation 0 : 79 [60 : 100]

Correlation 1 : 82 [60 : 100]

Width X(1-0) : 85.737
[0.000 : 511.000]

Width Y(1-0) : 62.239
[0.000 : 483.000]

Distance : 109.737
[0.000 : 705.556]

End

- Ranges for an OK judgement
- Range for Model 0 correlation (0 to 100)
- Range for Model 1 correlation (0 to 100)
- Width for X direction (Model 1 - Model 0)
(-9,999.99 to 9,999.999)
- Width for Y direction (Model 1 - Model 0)
(-9,999.99 to 9,999.999)
- Distance for Model 0 and Model 1
(0 to 999.999)

○ : Measurement results for the displayed image.
Use these values as references for setting upper and lower limits.

CHECK Correlation

When OK condition for correlation is set between 60 and 100:

	Image 0	Image 1	Image 2	Image 3
Correlation:	96	55	50	65
Judgement:	OK	NG	NG	OK

CHECK Width X, Width Y, and Distance

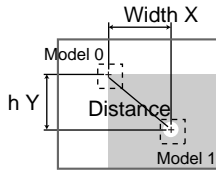

1. Select **Judgement conditions**.

0.Relative search

- Model 0 setting
- Model 1 setting
- Judgement conditions**
- Detailed conditions
- Coordinate mode

The Judgement Conditions Settings Screen will be displayed.

Judgement conditions

Correlation 0 : 79 [60 : 100]

Correlation 1 : 82 [60 : 100]

Width X(1-0) : 85.737
[0.000 : 511.000]

Width Y(1-0) : 62.239
[0.000 : 483.000]

Distance : 109.737
[0.000 : 704.556]

End

2. Make the settings for each item.

SeeAlso Refer to page 29 for details on inputting values.

3. Select **End**.
The settings will be registered and the screen in (1.) will return.

3-14-3 STEP 3: Changing Detailed Conditions

Search-related settings can be changed under *Detailed conditions*. Change the detailed conditions when the measurement results are unstable and to increase processing speed. Normally, these conditions can be left at the default settings.

After changing the settings, perform an object measurement to check that measurement can still be performed correctly.

SeeAlso Refer to page 110 for information on each setting item.

1. Select **Detailed conditions**.

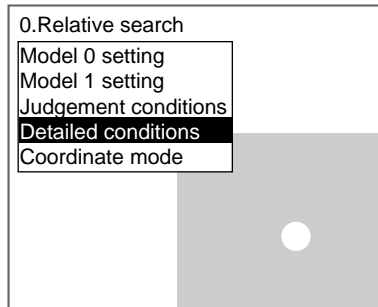

The Detailed Conditions Settings Screen will be displayed.
Use the **Down** Key to scroll through the setting items.

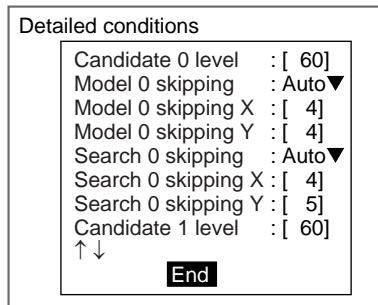

2. Change the settings.
3. Select **End**.
The settings will be registered and the screen in (1.) will return.

SeeAlso Refer to page 29 for details on inputting values.

3-14-4 STEP 4: Setting the Coordinate Mode

Select the type of coordinates.

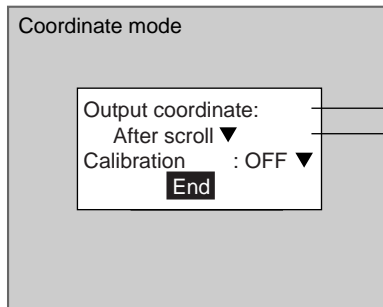

Before scroll: Output made using the coordinate values before position displacement compensation.
 After scroll*: Output made using the coordinate values after position displacement compensation.
 Refer to page 205 for position compensation.
 Refer to page 330 for differences between output coordinates.
 ON : Output made using coordinate values set using calibration.
 OFF*: Output made using Camera coordinate values.
 Refer to page 193 for information on calibration.

The default settings are marked with asterisks.*

CHECK If the coordinate mode is changed after the judgement conditions have been set, the measurement results will change also. Change the judgement conditions to enable correct measurement.

1. Select **Coordinate mode**.

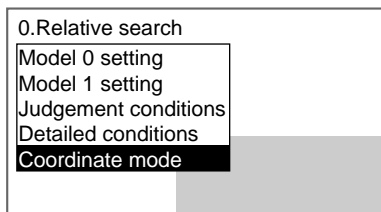

The Coordinate Mode Settings Screen will be displayed.

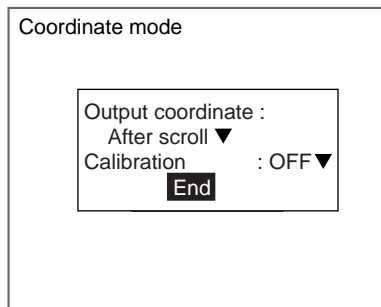

2. Make the settings for each item.
3. Select **End**.

The settings will be registered and the screen in (1.) will return.

3-15 Rotation Search

Image patterns (called a model) that will serve as references are registered beforehand. The area that is most similar to the model is found in the input image, the angle and position calculated and the correlation with the model displayed.

The images read by the Camera are processed as is, i.e., as density images.

SeeAlso Refer to page 13.

Operational Flow



3-15-1 STEP 1: Setting Measurement Conditions

Set the conditions for searches.

The F160 rotates the image by the skipping angle (See note 1.) within the rotation range (See note 2.) to search.

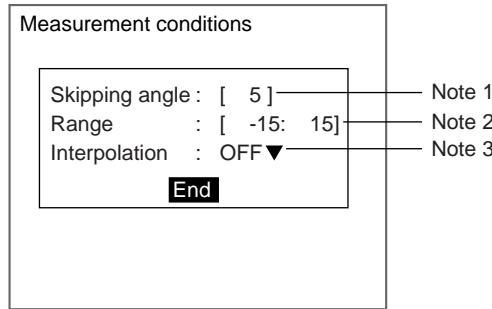

Note 1. Skipping Angle

The angle that the image will be rotated during the search can be set between 1° and 99°. The default setting is 5°. The lower the angle the higher the accuracy, however the processing time is also longer.

Example: When skipping angle set to 15° and rotation range to -45° to 45°. The search will be performed by rotating the image by 15° each time, between -45° and 45°.

Note 2. Rotation Range

Set two values (angles) as the range for image rotation. The two values can be set between -360° and 360°. Always set the value to the right higher than the left value. The default range is -15° to 15°.

Example: Setting the range for A in the following diagram

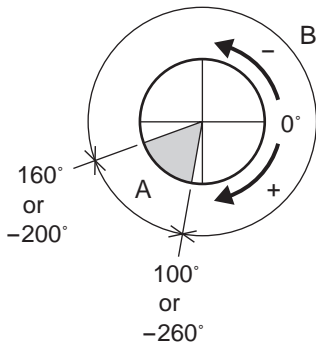

- Rotation range:[-260 : -200] OK
- [100 : 160] OK (Same result given)
- [100 : -200] NG Right value is smaller
- [-200 : 100] NG Falls in range set for B

Note 3. Interpolation

Set the unit for the angle to be calculated. The default setting is none.

No: The angle is calculated in skipping angle units.

Yes: The angle is calculated up to 3 decimal places, based on the correlation obtained in skipping angle units. The processing time is longer.

CHECK

Coordinates and Rotation Angle Direction

Depending on whether a right-handed or left-handed coordinate system has been set for the F160, the rotation angle direction changes. Check the rotation angle direction before making rotation search settings.

- When *Coordinate mode/Calibration* is set to OFF, the coordinate system becomes a left-handed system.
- When *Coordinate mode/Calibration* is set to ON, the coordinate system is determined by the *Calibration* setting.

SeeAlso

Refer to page 202 for information on checking and changing the coordinate system.

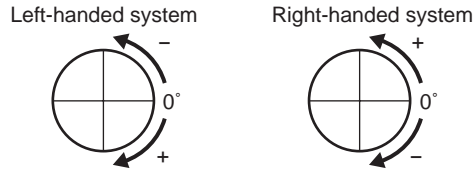

Example: When using a left-handed coordinate system

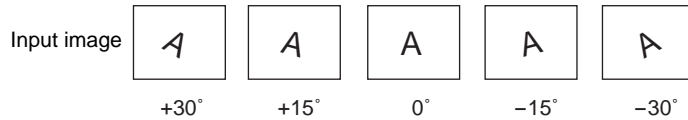

1. Select **Measurement**/**<Region number>/Rotation search**.

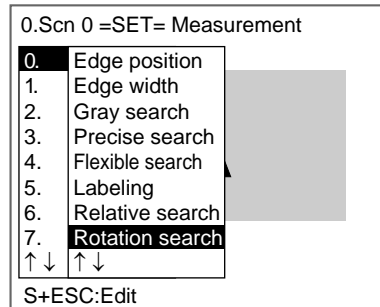

The initial screen for Rotation search will be displayed.

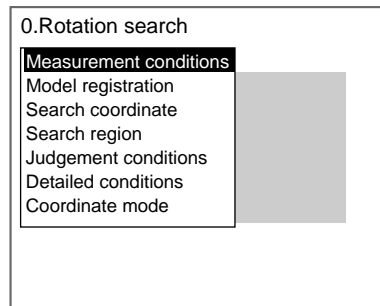

2. Select **Measurement conditions**.

The Measurement Conditions Settings Screen will be displayed.

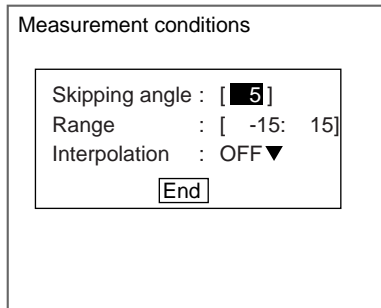

3. Change the settings.

SeeAlso

Refer to page 29 for details on inputting values.

4. Select **End**.

The settings will be registered and the screen in (2.) will return.

3-15-2 STEP 2: Registering a Model

The area of the image to be inspected is registered as a model. The model can be of any size.

When a model is registered, that orientation becomes 0° and the center position of the model is registered as the search coordinates. When several figures have been combined in the drawing, the center coordinates of the circumscribing rectangle become the search coordinates. This position becomes the reference position for position compensation, so be sure to place the measurement object in the correct position before drawing the measurement region.

CHECK

Models can be created by combining up to 3 different figures. Regions with difficult shapes can be drawn and sections not to be measured can be left out of the region by combining different figures.

1. Select **Model registration**.

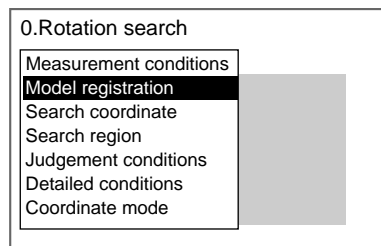

The Model Registration Screen will be displayed.

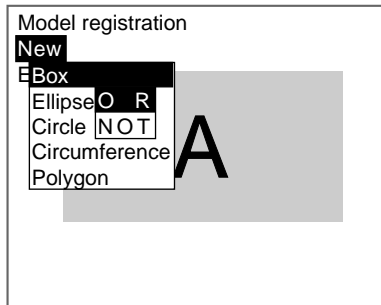

2. Select **New**.
3. Select the shape of the desired figure.
4. Select the desired drawing mode (**OR/NOT**).

SeeAlso

Refer to page 28 for methods for drawing regions.
An arrow cursor will appear.

Up to three figures (0, 1, and 2) can be drawn.

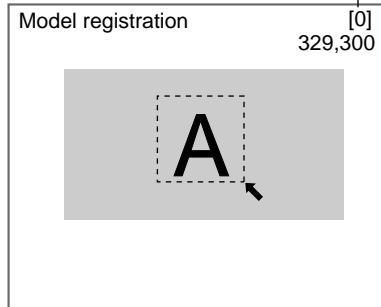

5. With the shape selected, draw the region to be registered as the model.
The figure will be registered.

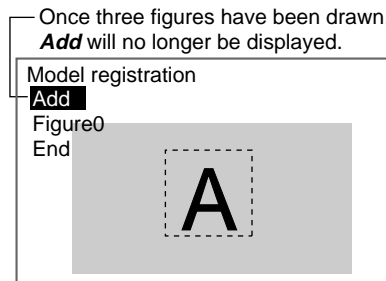

6. If additional figures are to be drawn, select **Add**.
7. Repeat steps 3 to 5 as necessary to create the desired shape.
8. After drawing is completed, select **End**.

The measurement region will be registered and the screen in (1.) will return.

The search coordinates (display cursor) and model region will be displayed.

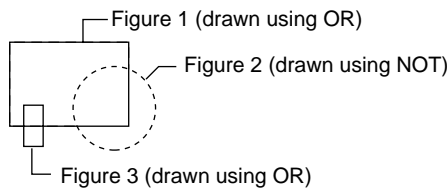

CHECK

Figures drawn using OR mode are displayed with solid lines and figures drawn using NOT mode are displayed with dotted lines.

Correcting or Clearing Figures

1. In the screen for step 6 above, select the figure to be changed or cleared using the **Up** and **Down** Keys and press the **ENT** Key.

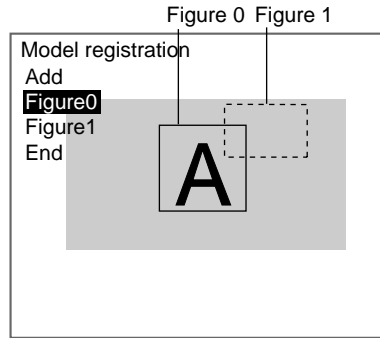

The figure for the figure number selected using the cursor will be displayed with solid lines. The selections **Correct** and **Clear** will be displayed.



2. Select either **Correct** or **Clear** and press the **ENT** Key.
 If **Correct** is selected, the cursor will be displayed. Correct the size and position of the figure as desired.
 If **Clear** is selected, the selected figure will be cleared.

CHECK

To re-register models, repeat from step 1 under *Step 2: Registering Models*.

3-15-3 STEP 3: Changing the Search Coordinates

Use this function to change the search coordinates only.

When a model is registered, the center position of the model is registered as the search coordinates. However, this function can be used to register a point other than the center of the model as the search coordinates.

CHECK

The search coordinates are used for the point output as the measurement value. This point can be changed to any suitable point.

Changing the Point Output as the Measurement Value

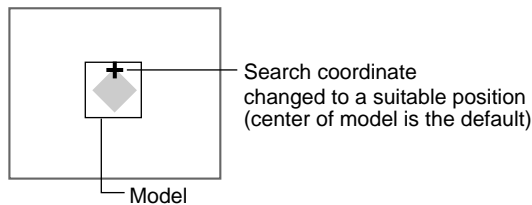

CHECK

If the model is re-registered, the search coordinates are changed to the center position of the new model.

1. Select **Search coordinates**.

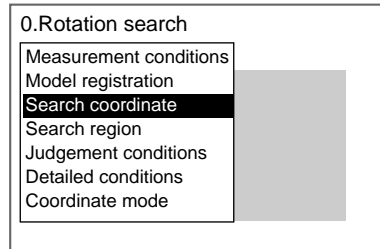

A display cursor will appear in the center position.

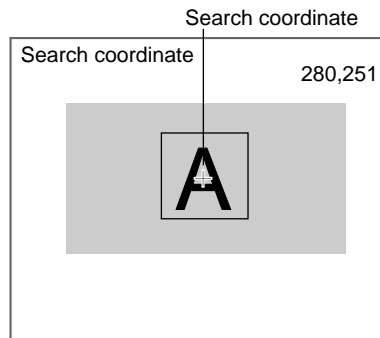

2. To change the position, use the **Up/Down** and **Right/Left** Keys to move the cursor.
3. Press the **ENT** Key to confirm the setting.
The settings will be saved and the screen in (1.) will return.

3-15-4 STEP 4: Setting Search Regions

Set the region to search for the model. The whole region of the input image can be searched, however processing time can be reduced and accuracy improved by limiting the search region.

1. Select **Search region**.

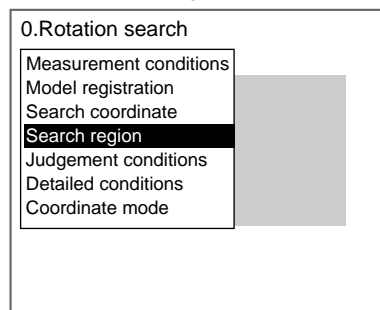

An arrow cursor will appear.

The model will be displayed with solid lines.

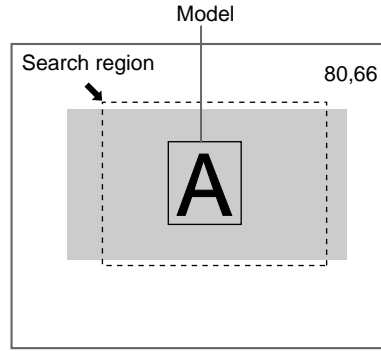

2. Draw a box-shaped search region.

CHECK

The only figure that can be drawn is a box.

SeeAlso

Refer to page 28 for methods for drawing regions.

The search region will be set and the screen in (1.) will return.

3-15-5 STEP 5: Setting Judgement Conditions

Set the judgement conditions for the correlation between the measurement object and the models, the position (X, Y) where the object was detected, and the angle.

Judgement conditions

Correlation : 79 60 : 100

Position X : -180.000

[0.000 : 511.000]

Position Y : 250.000

[0.000 : 483.000]

Angle : 15.000

[-180.000 : 180.000]

[End]

● Range for an OK judgement

— Correlation range (0 to 100)

— Range of movement of the measurement object in the X direction (-9,999.999 to 9,999.999)

— Range of movement of the measurement object in the Y direction (-9,999.999 to 9,999.999)

— Range of angles for the measurement object (-360.000 to 360.000)

○ : Measurement results for the displayed image.
Use these values as references for setting upper and lower limits.

CHECK

Correlation

When OK condition for correlation is set between 60 and 100:

	Image 0	Image 1	Image 2	Image 3
	A	A	C	A
Correlation:	96	55	50	65
Judgement:	OK	NG	NG	OK

CHECK

Position X and Position Y

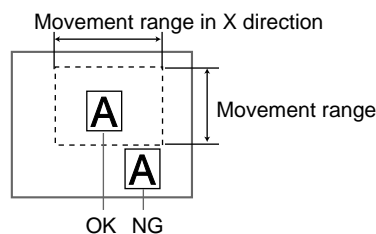

1. Select **Judgement conditions**.

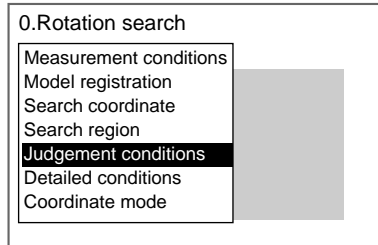

The Judgement Conditions Settings Screen will be displayed.

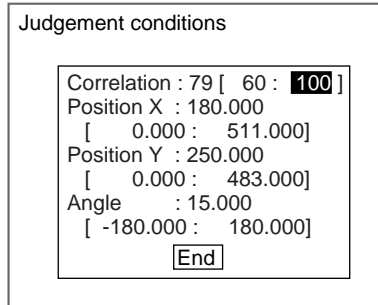

2. Change the settings.

SeeAlso

Refer to page 29 for details on inputting values.

3. Select **End**.

The settings will be registered and the screen in (1.) will return.

3-15-6 STEP 6: Changing Detailed Conditions

Search-related settings can be changed under *Detailed conditions*. Change the detailed conditions when the measurement results are unstable and to increase processing speed. Normally, these conditions can be left at the default settings. After changing the settings, perform an object measurement to check that measurement can still be performed correctly.

SeeAlso

Refer to page 110 for information on each setting item.

1. Select **Detailed conditions**.

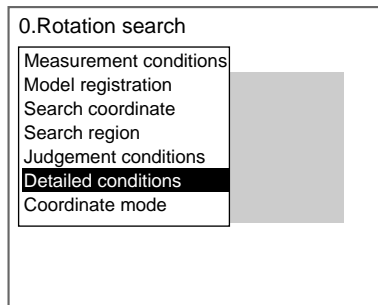

The Detailed Conditions Settings Screen will be displayed.

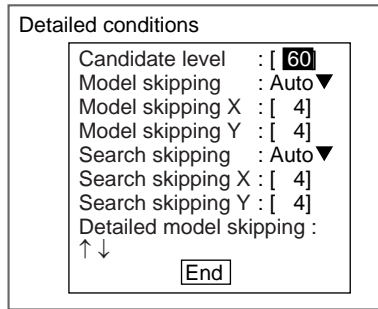

2. Change the settings.
Use the **Down** Key to scroll through the setting items.

SeeAlso

Refer to page 29 for details on inputting values.

3. Select **End**.
The settings will be registered and the screen in (1.) will return.

3-15-7 STEP 7: Setting the Coordinate Mode

Select the type of coordinates.

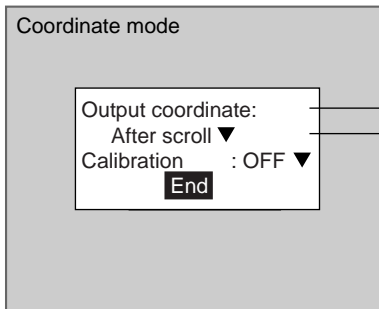

Before scroll: Output made using the coordinate values before position displacement compensation.
 After scroll*: Output made using the coordinate values after position displacement compensation.
 Refer to page 205 for position compensation.
 Refer to page 330 for differences between output coordinates.
 ON : Output made using coordinate values set using calibration.
 OFF*: Output made using Camera coordinate values.
 Refer to page 193 for information on calibration.

The default settings are marked with asterisks.*

CHECK

If the coordinate mode is changed after the judgement conditions have been set, the measurement results will change also. Change the judgement conditions to enable correct measurement.

1. Select **Coordinate mode**.

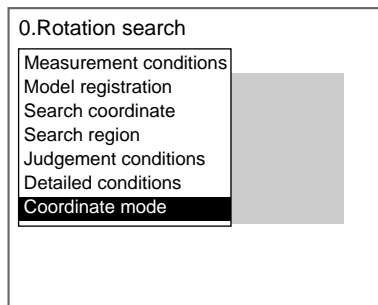

The Coordinate Mode Settings Screen will be displayed.

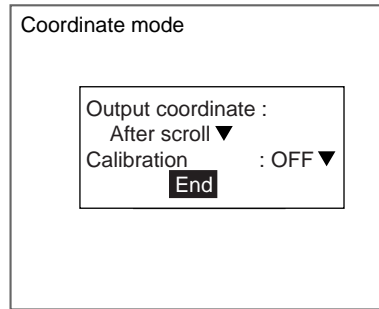

2. Make the settings for each item.
3. Select **End**.

The settings will be registered and the screen in (1.) will return.

SECTION 4

Detailed Setting Operations

This section explains in more detail the basic setting operations for the Expert Menus that were explained in *Section 2 Basic Operations: Setting Inspection Conditions*.

4-1	Calibration	193
4-1-1	Sampling	193
4-1-2	Specifying Points.	198
4-1-3	Specifying Coordinate Axis	200
4-1-4	Parameter Input	202
4-1-5	Reference Parameters	204
4-2	Position Displacement Compensation	205
4-2-1	Setting Position Displacement Compensation Regions and Directions	206
4-3	Details on Expressions.	219
4-3-1	Setting Expressions	220
4-4	Display Details.	233
4-5	Display Strings.	235
4-5-1	STEP 1: Setting Display Characters	236
4-5-2	STEP 2: Setting Display Conditions	237
4-5-3	STEP 3: Setting Display Position	237
4-6	Displaying Measurements	238
4-6-1	STEP 1: Setting Measurement Conditions	238
4-6-2	STEP 2: Setting Display Conditions	240
4-6-3	STEP 3: Setting Display Position	241
4-7	Displaying Judgements	241
4-7-1	STEP 1: Setting Judgement Criteria	241
4-7-2	STEP 2: Setting Display Characters for OK and NG Judgements	243
4-7-3	STEP 3: Setting Display Conditions	244
4-7-4	STEP 4: Setting Display Position	244
4-8	Displaying Measurement Region Names	245
4-8-1	STEP 1: Selecting Measurement Regions.	245
4-8-2	STEP 2: Setting Display Conditions	246
4-8-3	STEP 3: Setting Display Position	246
4-9	Displaying Measurement Time	246
4-9-1	STEP 1: Selecting the Display Data	247
4-9-2	STEP 2: Setting Display Conditions	247
4-9-3	STEP 3: Setting Display Position	247

4-10	Displaying Fixed Figures	248
4-10-1	STEP 1: Setting Display Conditions	248
4-10-2	STEP 2: Drawing Figures	249
4-11	Displaying Results (Lines, Boxes, Circles, and Cursors)	250
4-11-1	STEP 1: Setting Display Conditions	251
4-11-2	STEP 2: Drawing Figures	252
4-12	Editing Measurement Regions and Position Compensation Regions	253
4-12-1	Copying Regions	253
4-12-2	Clearing Regions	255
4-12-3	Changing Region Names (Inputting Comments)	256

4-1 Calibration

Calibration can be set to output the measurement results in physical units.

There are four settings for calibration: Sampling, Specifying point, Specifying coordinate axis, and Parameter input.

TwoCamera Calibration can be set separately for each Camera. The setting for Camera 0 is in *Adjust 0/Calibration 0* and the setting for Camera 1 is in *Adjust 1/Calibration 1*.

HELP Refer to page 330 for information on calibration.

CHECK To output measurement results in physical units, set *Coordinate mode/Calibration* to *ON* for each measurement item.

If *Calibration* remains set to *OFF*, the default settings will remain, and measurements using the Camera coordinates will be output.

4-1-1 Sampling

The sampling function is used to set calibration based on measurement results. Register a model, and perform a sample measurement to obtain the position. (The position will be obtained in sub-pixel units.) Enter the physical coordinates of the position of the model. The calibration will be calculated automatically. Sample measurements can be made in up to 3 places.

- When the magnifications are the same for the X and the Y directions, make sample measurements in 2 places only.

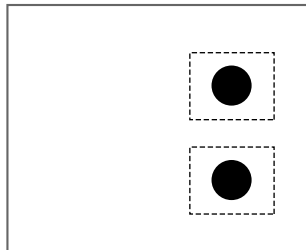

- When the magnifications in the X and Y directions are different, perform sampling measurement in 3 places.

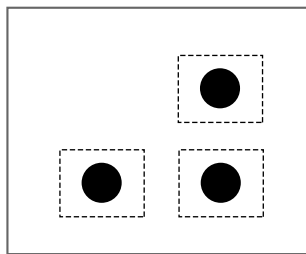

CHECK The point measured by the F160 becomes the specified point for calibration, giving a higher degree of accuracy than the when using *Point specification*.

1. Select **Adjust/Calibration**.

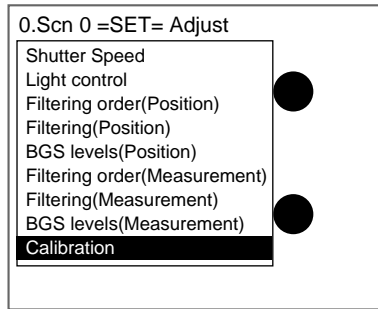

The initial screen for Calibration will be displayed.

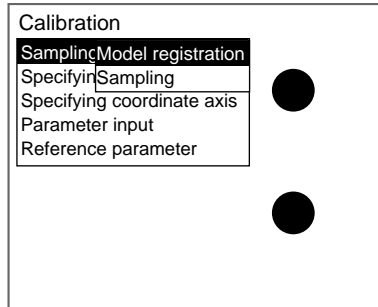

2. Select **Sampling**.
3. Select **Model registration**.

The Model Registration Settings Screen will be displayed.

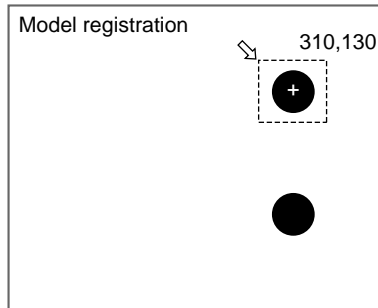

4. Circumscribe one figure with a box and register the model image to be used for sampling.

The screen for selecting the reference position settings for the model will be displayed.

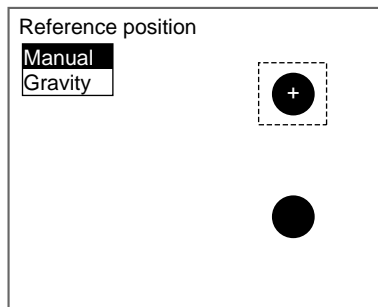

5. Select **Manual** or **Gravity**.

Manual: Any reference position can be set.

Gravity: The image is converted to binary and the center of gravity is set as the reference position.

When **Manual** is selected, the Reference Position Settings Screen will be displayed. A display cursor will appear at the center of the model, as the default position.

When **Gravity** is selected, the Gravity Settings Screen will be displayed.

- Set the reference position.

Manual:

Use the **Up/Down** and **Right/Left** Keys to move the cursor to the reference position and press the **ENT** Key.

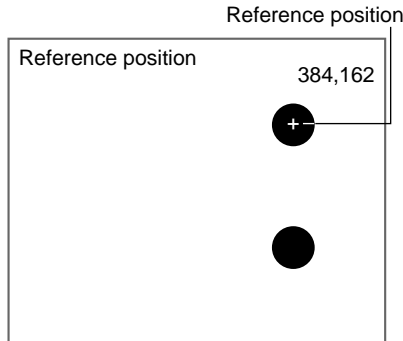

Gravity:

Specify the binary level so that the reference figure will be white and select **OK**.

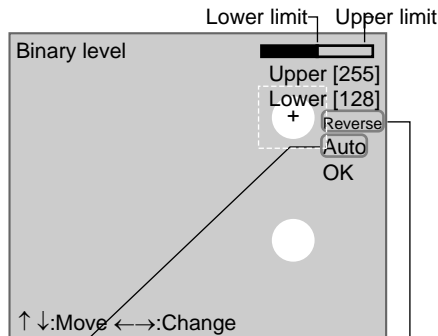

Auto

The F160 automatically sets the binary level

Reverse

Reverses black and white in the display

SeeAlso

Refer to page 50 for information on setting binary levels.

The model will be registered and the screen in (3.) will return.

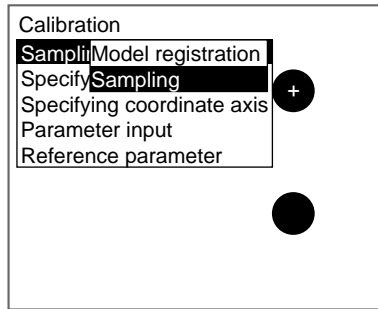

7. Select **Sampling**.

The first Sampling Screen will be displayed.

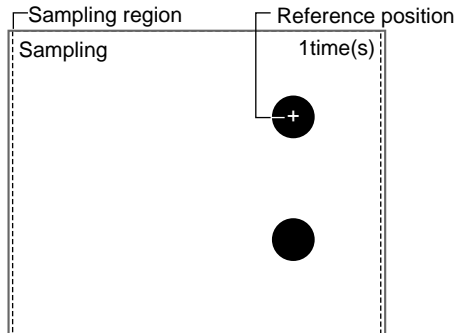

8. Decide whether or not to change the sampling region.

When there are 2 or more figures with the same shape on the screen, press the **SHIFT+ENT** Keys. Go to step 9.

When there are no similar shaped objects on the screen, go to step 10.

The Change Sampling Region Settings Screen will be displayed.

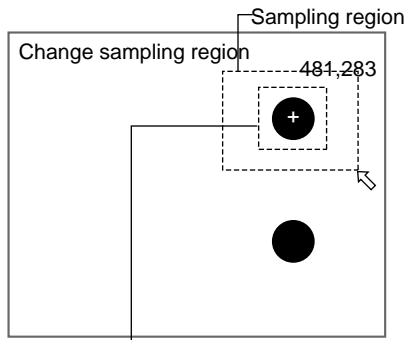

Registered model
(The boundaries of the region will not actually be displayed.)

9. Change the region.

CHECK

Draw the region so that there will not be 2 or more similar figures within the sampling region.

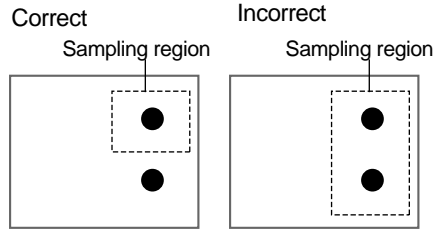

The region will be set and the Sampling Screen will return.

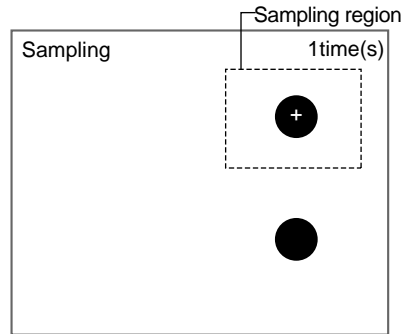

10. Press the **TRIG** Key to execute the first sampling.

A frame and display cursor will appear where the model was found and the screen for inputting physical coordinates will be displayed.

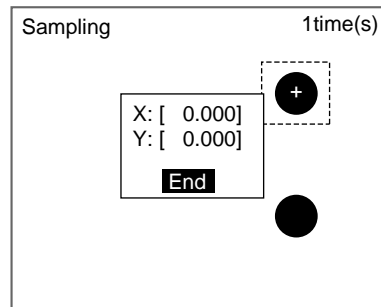

11. Input the coordinates for the model position (display cursor) and select **End**.

CHECK

Correcting Mistakes

Press the SHIFT+ESC Keys. The previous sampling can be corrected and re-executed.

The first sampling will be confirmed, and the second screen will be displayed.

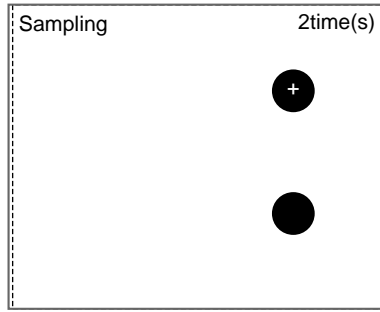

12. Repeat steps 8 to 11 and perform sampling for at least two locations. Once sampling has been completed, a confirmation message will be displayed.

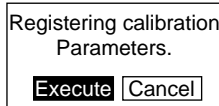

13. Select **Execute**.
The settings will be registered and the screen in (2.) will return.

4-1-2 Specifying Points

This function is used to specify and set any point in pixel units.

If the coordinates of the specified position are input, the calibration data is automatically calculated. Up to 3 points can be specified.

- When the magnifications are the same for the X and the Y directions, make sample measurements in 2 places only.

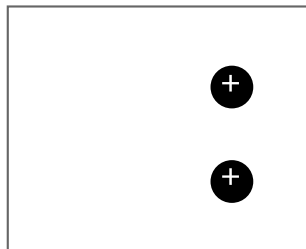

- When the magnifications in the X and Y directions are different, perform sampling measurement in 3 places.

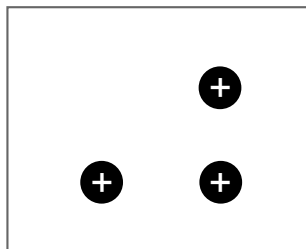

1. Select **Adjust/Calibration**.

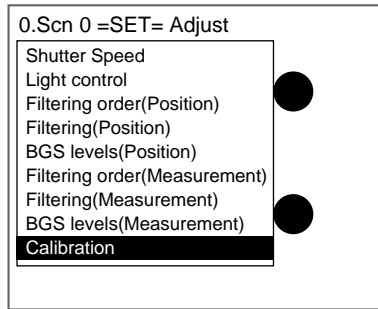

The initial screen for Calibration will be displayed.

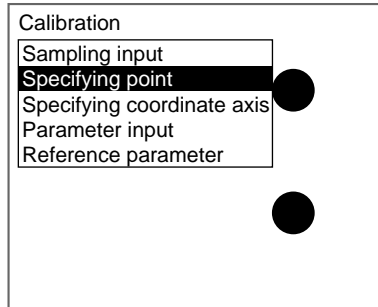

2. Select **Specifying point**.

The Specifying Point Screen for the 1st point will be displayed.

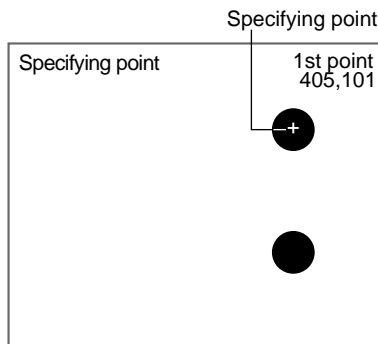

3. Use the **Up/Down** and **Right/Left** Keys to move the cursor to the position to be specified and press the **ENT** Key.

The screen for inputting coordinates will be displayed.

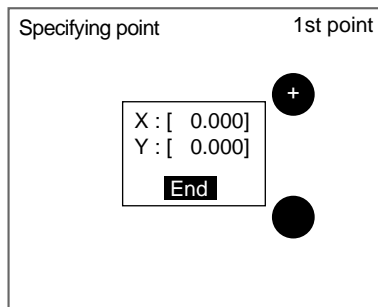

4. Input the coordinates for the point to be specified and select **End**.

The coordinates for the 1st point will be set and the Specifying Point Screen for the 2nd point will be displayed.

5. Repeat steps 3 and 4 and specify 2 or more points.

Once point specification has been completed, a confirmation message will be displayed.

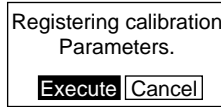

6. Select **Execute**.

The settings will be registered and the screen in (2.) will return.

4-1-3 Specifying Coordinate Axis

This method is used to specify the coordinate axis while monitoring the messages displayed on the screen. The coordinate system, the origin, the rotation angle, and the magnification, are set in that order. The magnification for X and Y directions is the same setting when specifying the coordinate axis.

Coordinate System

Select the coordinate system.

Left-handed system

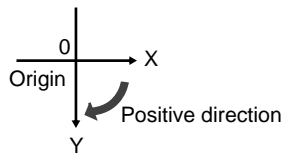

Right-handed system

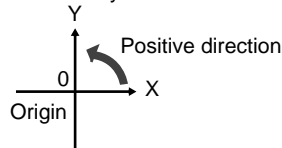

1. Select **Adjust/Calibration**.

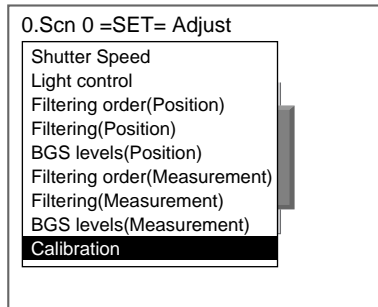

The initial screen for Calibration will be displayed.

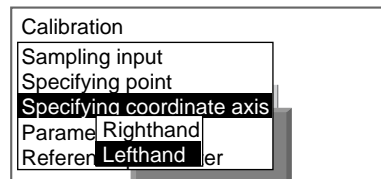

2. Select **Specifying coordinate axis**.
3. Select **Righthand** or **Lefthand**.

The screen for specifying the origin will be displayed.

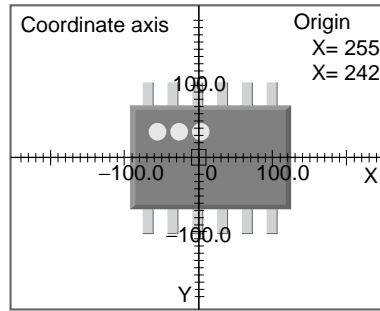

4. Use the **Up/Down** and **Right/Left** Keys to move the cursor to the position to be specified and press the **ENT** Key.

Up/Down and Right/Left Keys: Moves the position one pixel at a time.

SHIFT+Up/Down and Right/Left Keys: Moves the position 10 pixels at a time.

The origin will be set and the screen for setting the rotation angle will be displayed.

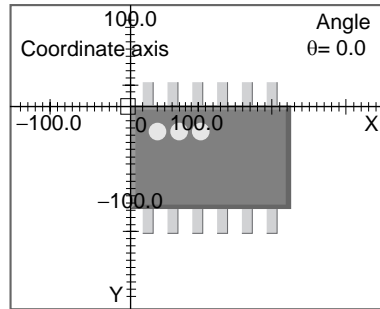

5. Specify the angle for the axis and press the **ENT** Key.

Right and Down Keys: Rotates the angle by 0.5° in the clockwise direction.

SHIFT+Right and Down Keys: Rotates the angle by 5° in the clockwise direction.

Left and Up Keys: Rotates the angle by 0.5° in the counterclockwise direction.

SHIFT+Left and Up Keys: Rotates the angle by 5° in the counterclockwise direction.

The angle will be set and the screen for specifying magnification will be displayed.

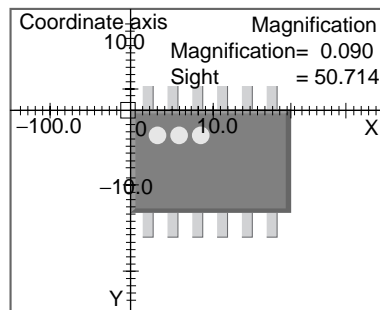

6. Specify the magnification.

Use the following procedure to specify the actual dimensions that correspond to one pixel.

Right and Down Keys: Enlarges the image 10 gradations at a time.

SHIFT+Right and Down Keys: Enlarges the image 100 gradations at a time.

Left and Up Keys: Reduces the image 10 gradations at a time.

SHIFT+Left and Up Keys: Reduces the image 100 gradations at a time.

CHECK

Example: For a measurement object with actual length of 20 mm

Align the origin with the upper-left corner of the measurement object and align the 20.0 gradation line with the upper-right corner of the measurement object.

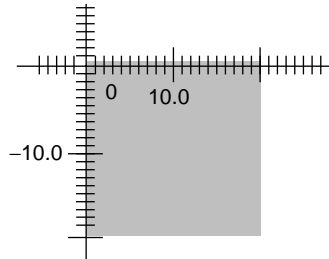

7. Press the **ENT** Key.

The settings will be registered and the screen in (2.) will return.

4-1-4 Parameter Input

Use the following procedure to directly input parameters to be used for calibration.

Origin

Specify the physical coordinates for the position of the origin as desired.

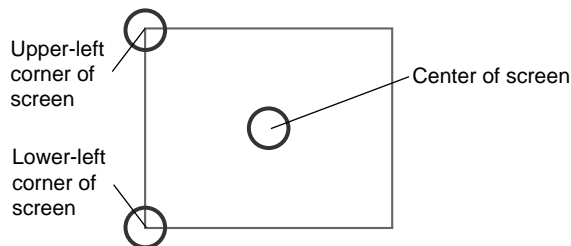

Coordinate System

Select the coordinate system for the physical coordinates.

Left-handed System

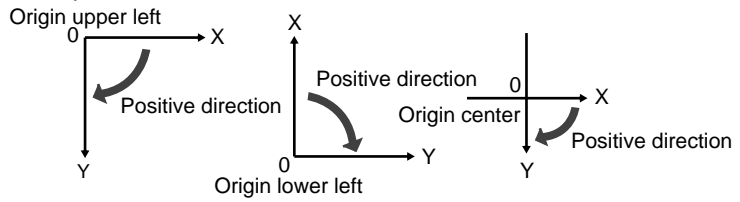

Right-handed System

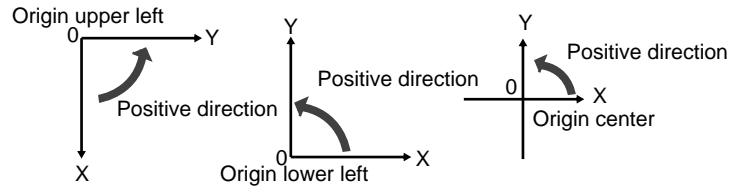

Magnification and Units

Set the physical unit that will correspond to one pixel. Set a value in the range 0.010 to 9.999 for the magnification.

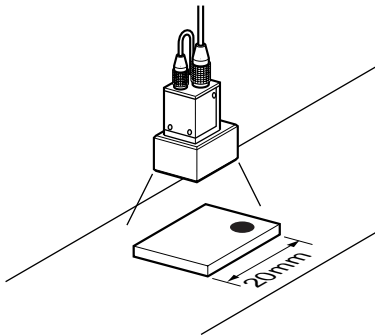

F160 screen

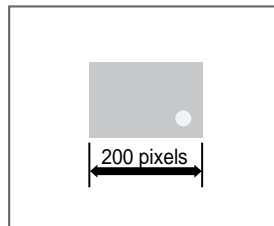

The magnification is $20(\text{mm}) / 200(\text{pixels}) = 0.1(\text{mm}/\text{pix})$.
 In other words, 1 pixel in camera coordinates will correspond to 0.1 mm in physical units.
 In the menu, pixel is denoted as "pix."

1. Select **Adjust/Calibration**.

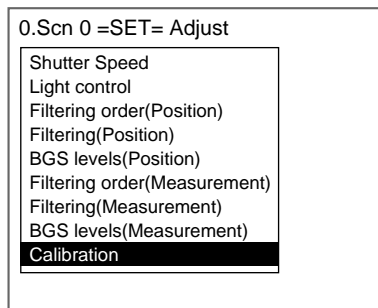

The initial screen for Calibration will be displayed.

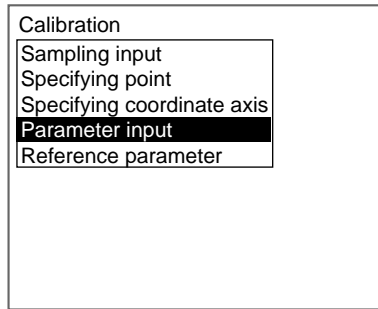

2. Select **Parameter input**.

The Parameter Input Screen will be displayed.

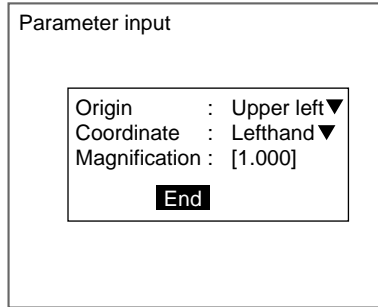

3. Make the settings for each item.

SeeAlso Refer to page 29 for details on inputting values.

4. Select **End**.

The settings will be registered and the screen in (2.) will return.

4-1-5 Reference Parameters

This screen is used to check data settings.

A= 1.000 D= 0.000
 B= 0.000 E= 1.000
 C=255.000 F=241.000

Sight= 512.000mm ▼

OK

- A to F represent the calibration conversion values. The camera coordinates are converted to physical coordinates based on these calibration conversion values. The formulae for conversion to physical coordinates are as follows:
 $X' = A \times X + B \times Y + C$
 $Y' = D \times X + E \times Y + F$
 (X,Y): measurement position (camera coordinates), unit: pixels
 (X',Y'): conversion position (physical coordinates), units: mm
- The physical coordinates for X direction on the screen can be selected from μ m, mm, cm, and m.

1. Select **Adjust/Calibration**.

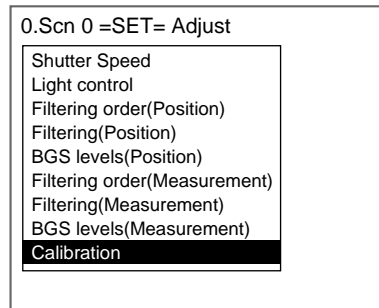

The initial settings screen for Calibration will be displayed.

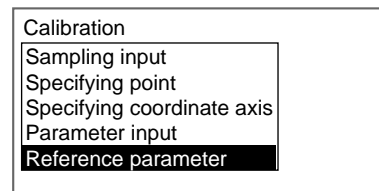

2. Select **Reference parameter**.

The parameters will be displayed.

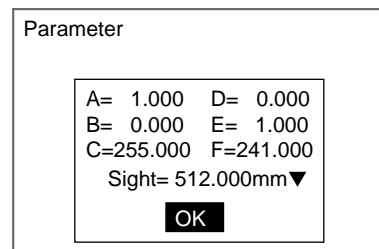

3. Select **OK** to exit this screen.

The screen in (2.) will return.

4-2 Position Displacement Compensation

The position displacement compensation function is used when the position and orientation of measurement objects are not consistent. There are 6 types of measurement that can be used for position compensation. By using this function, the displacement between the reference position and the current position is obtained, and this displacement is compensated for in measurements. Refer to page 47.

TwoCamera Position compensation 0 for Camera 0 and Position compensation 1 for Camera 1 are displayed.

CHECK Judgement of Position Displacement Compensation and Measurement
Position compensation will be performed, regardless of the judgement result of the position compensation. Also, you can select whether or not to use the position compensation judgement result in the overall judgement result. The default is to use the result (ON). Refer to page 323.

CHECK Adjusting Position Compensation Screens
A screen adjustment different to measurement can be set for position compensation. Adjust the screen beforehand in Set Mode. Refer to page 38.

4-2-1 Setting Position Displacement Compensation Regions and Directions

The F160 has two position compensation regions. Normally, only one position compensation is required. To ensure accurate position compensation or to reduce processing time, perform two-stage compensation.

Processing Order for Position Compensation

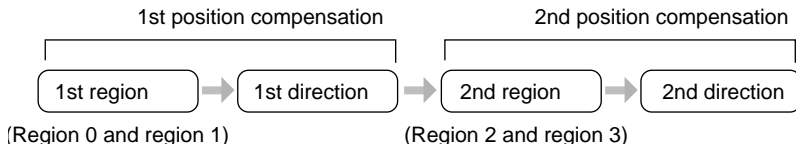

SeeAlso Refer to page 218 for information on two-stage position compensation.

1. Select **Position** in Set Mode.

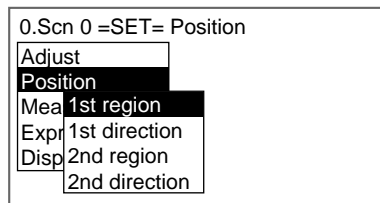

2. Select **1st region**.

The region selections will be displayed.

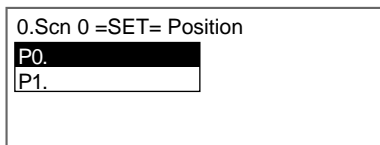

3. Select the region number.

The selection for position compensation will be displayed.

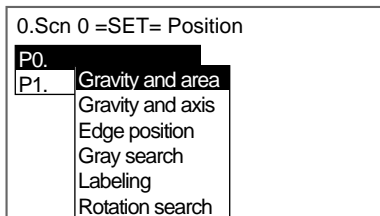

4. Select the measurement method for position compensation.
The settings screen for the selected method will be displayed.
5. Set the measurement conditions.

CHECK

There are 6 measurement methods that can be used. Refer to the examples when selecting a measurement method. The procedures for the various measurement methods are given separately. Refer to the appropriate explanation. Refer to the following pages for details on the various measurement methods:

Gravity and area, page 50

Gravity and axis angle, page 92

Labeling, page 163

- Gray search, page 147
- Edge position, page 128
- Rotation search, page 180

When the settings have been completed for the measurement conditions, the screen in (3.) will return.

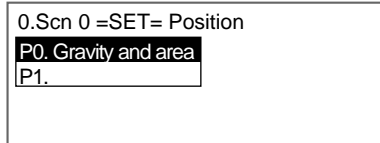

6. Press the **ESC** Key.
The screen in (2.) will return.

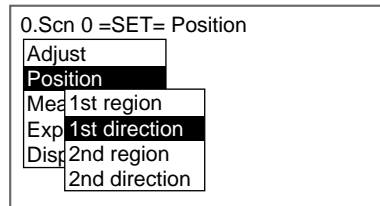

7. Select **1st direction**.

CHECK

Be sure to set the compensation direction after drawing the position displacement compensation region. Position displacement compensation will not be executed just by drawing the region.

The screen for setting the compensation direction will be displayed.

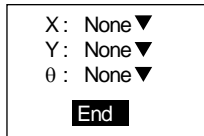

8. Make the settings for each item.

CHECK

The method for setting compensation direction changes, depending on the settings for the position displacement compensation region. Refer to the examples when making the settings.

9. Select **End**.
The settings will be registered and the screen in (2.) will return.
Repeat steps 2 to 9 to set **2nd region** and **2nd direction**.

Setting Measurement Conditions and Compensation Directions: Examples

The following table shows the 6 measurement methods supporting position compensation.

Measurement method	Measurement value used for position compensation
Gravity and area	Center of gravity coordinates
Gravity and axis angle	Center of gravity coordinates, axis angle
Labeling	Center of gravity coordinates for specified label
Gray search	Search coordinates
Edge position	X or Y coordinates for edge
Rotation search	Search coordinates and angle

Two regions each can be set for *1st region* and *2nd region*. The number of regions to be set depends on the position compensation settings. Refer to the following examples when making the settings.

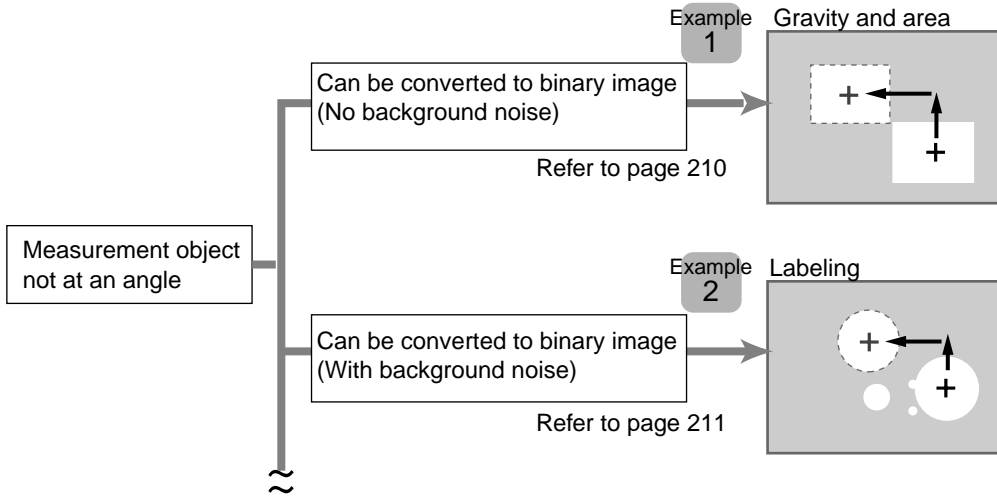

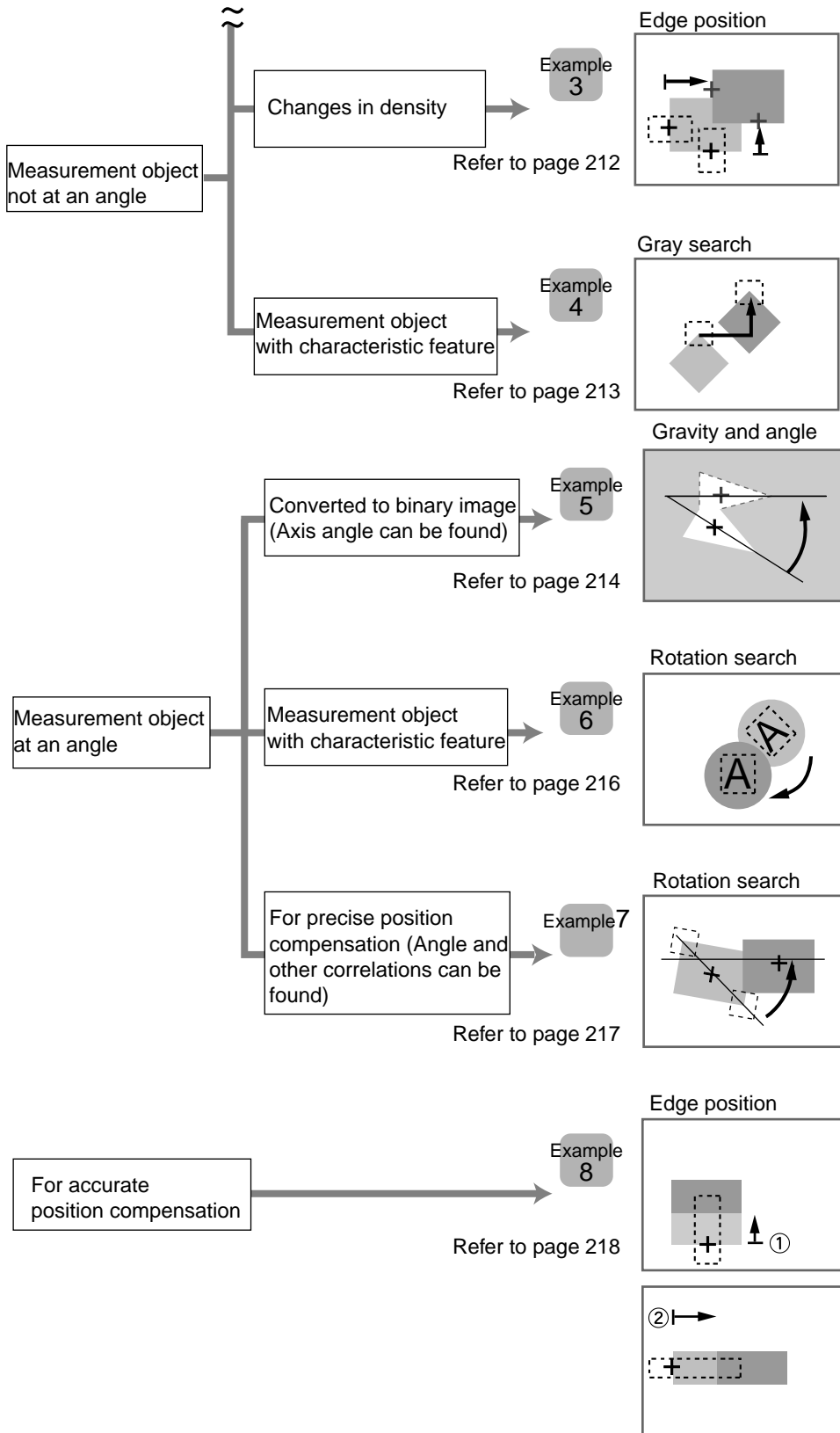

4-2-1-1 Objects Not at an Angle and Converted to Binary (No Noise)

Measurement method: Gravity and area. Refer to page 50.

Position displacement compensation region: 1st region (Region 0)

Compensation direction: 1st direction.

1. Setting the Binary Level

Set the level for converting 256-gradation images into binary images. The F160 performs measurement for the white pixels. Therefore, make the settings so that the areas for which the measurement is desired are white.

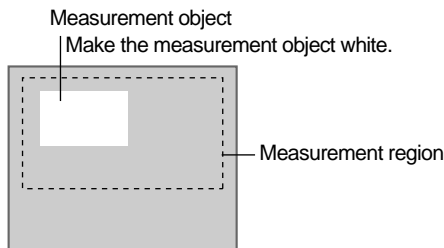

2. Drawing the Region

The area and center of gravity for the white area contained inside the measurement region are obtained. Make a region of a size and position that allows for movement of the range of the measurement object. When drawing of the region has been completed, the area and center of gravity are registered. This position will be taken as the reference. Therefore, draw the region after putting the measurement object in the correct position.

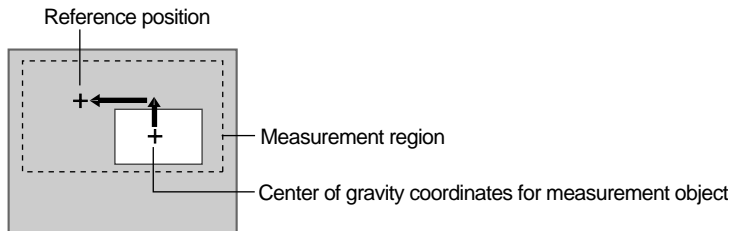

CHECK

Scroll the center of gravity coordinates of the measurement object to this reference position.

3. Setting the Judgement Conditions

It is necessary to set judgement conditions for position displacement compensation in order to evaluate whether the measurement object is contained within the field of view at the time of measurement. Set the range for an OK judgement.

Example: NG judgement

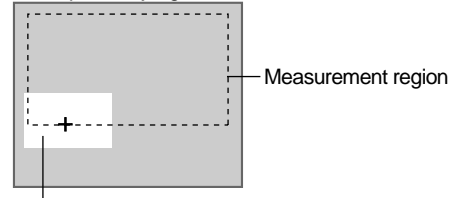

The area within the measurement region is too small.

Once steps 1 to 3 have been completed, the measurement conditions have been set.

4. Setting Compensation Direction
 - The X and Y coordinates measured for region 0 are used, so specify **Region 0** for X and Y.
 - Angle compensation is not supported, so leave θ set to **None**.

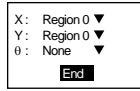

4-2-1-2 Objects Not at an Angle and Converted to Binary (With Noise)

Measurement method: Labeling. Refer to page 163.

Position displacement compensation region: 1st region (Region 0)

Compensation direction: 1st direction.

1. Setting the Binary Level

Set the level for converting 256-gradation images into binary images. The F160 performs measurement for the white pixels. Therefore, make the settings so that the areas to be counted as labels are white.

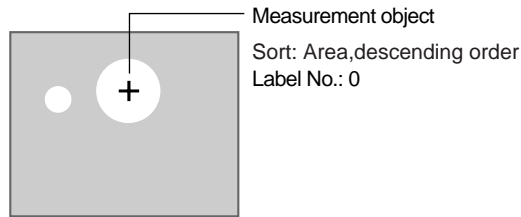

2. Setting Labeling Conditions

Set the conditions for measuring labels. The center of gravity of the label with the largest area is set here for use in position compensation.

3. Drawing the Region

The area and center of gravity are obtained for the white area contained inside the measurement region with the label number specified in (2.). Make a region of a size and position that allows for movement of the range of the measurement object. When drawing of the region has been completed, the area and center of gravity of the specified label are registered. This position will be taken as the reference. Therefore, draw the region after putting the measurement object in the correct position.

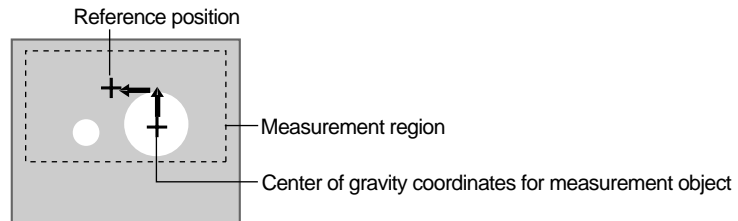

CHECK

Scroll the center of gravity coordinates for the specified label number to this position.

4. Setting the Judgement Conditions

Set the conditions for judging labels. Set the range for an OK judgement.

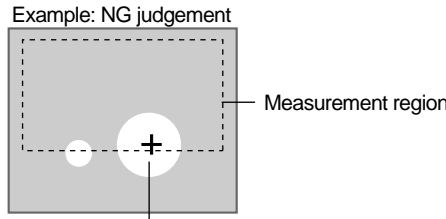

The area of the specified label within the measurement region is too small.

Once steps 1 to 4 have been completed, the measurement conditions have been set.

5. Setting Compensation Direction

- The X and Y coordinates measured for region 0 are used, so specify **Region 0** for X and Y.
- Angle compensation is not supported, so leave θ set to **None**.

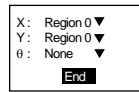

4-2-1-3 Objects Not at an Angle but with Density Changes

Measurement method: Edge position. Refer to page 128.

Position displacement compensation region: 1st region (Regions 0 and 1)

Compensation direction: 1st direction.

CHECK

Position compensation is performed simultaneously in the X and Y directions. When the displacement is large, use the position compensation method outlined in example 8 for a more accurate position compensation.

1. Setting the Edge Detection Conditions for Region 0.

Set the direction to search for the edge and the change in density.

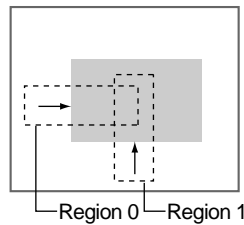

2. Drawing the Measurement Region for Region 0

Draw the position displacement compensation region to include the edge. Draw one box for each region. When drawing of the regions has been completed, the edge positions will be measured. These positions will be taken as the reference positions. Therefore, draw the regions after putting the

measurement object in the correct position.

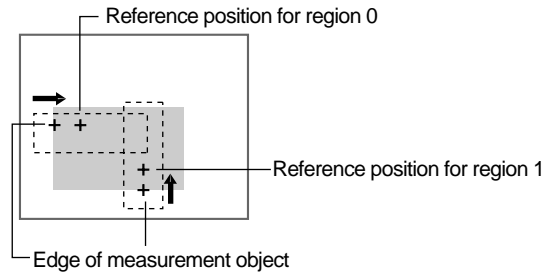

CHECK

Scroll the edge position of the measurement object to this reference position.

3. Setting the Judgement Conditions for Region 0

It is necessary to set judgement conditions for position displacement compensation in order to evaluate whether the measurement object is contained within the field of view at the time of measurement. Set the range for an OK judgement.

Example: NG judgement

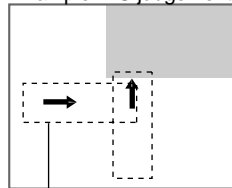

4. Registering Region 1

Repeat steps 1 to 3 and register region 1.

The measurement conditions for position compensation have now been set.

5. Setting Compensation Direction

- The X coordinate measured for region 0 and the Y coordinate measured for region 1 are used and so make the settings shown below.

Angle compensation is not supported, so leave θ set to **None**.

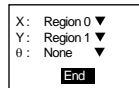

4-2-1-4 Objects Not at an Angle and with Characteristic Features

Measurement method: Gray search. Refer to page 147.

Position displacement compensation region: 1st region (Region 0)

Compensation direction: 1st direction.

1. Registering the Model

A characteristic part of the measurement image, such as a corner, is registered as a model. The model can be of any size.

When a model is registered, the center position of the model is registered as the search coordinates. Draw the model after putting the measurement

object in the correct position.

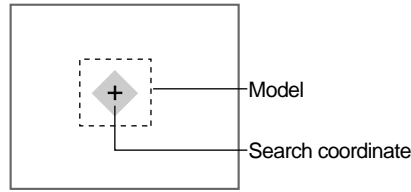

CHECK

Scroll the search coordinates for the measurement object to this position.

2. Setting the Search Region

Set the region for which the model is to be searched. It is possible to perform a search for the entire input image but processing time can be reduced and accuracy can be increased by setting limits on the search range.

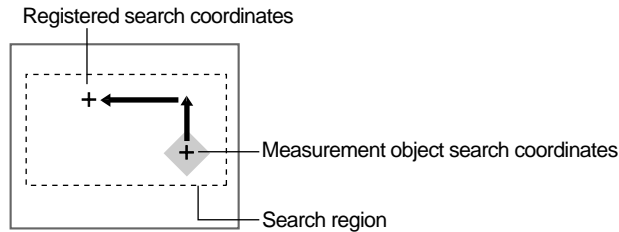

3. Setting the Judgement Conditions

If the correlation value with the model is low, the wrong place may be found. In order to judge whether the model for position displacement compensation has been correctly identified, it is necessary to set judgement conditions.

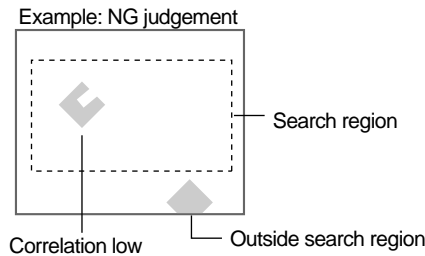

When steps 1 to 3 have been completed, the measurement conditions for position compensation have been completed.

4. Setting Compensation Direction

- The X and Y coordinates measured for region 0 are used, so specify **Region 0** for X and Y.
- Angle compensation is not supported, so leave θ set to **None**.

X:	Region 0	▼
Y:	Region 0	▼
θ :	None	▼
End		

4-2-1-5 Objects at an Angle and Converted to Binary

Measurement method: Gravity and axis. Refer to page 92.

Position displacement compensation region: 1st region (Region 0)

Compensation direction: 1st direction.

1. Setting the Binary Level

Set the level for converting 256-gradation images into binary images. The F160 performs measurement for the white pixels. Therefore, make the settings so that the areas to be measured are white.

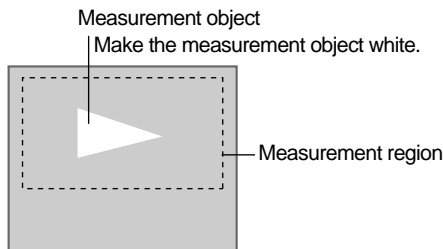

2. Drawing the Region

The area, center of gravity, and inclination for the white area contained inside the measurement region are obtained. Make a region of a size and position that allows for movement of the range of the measurement object. When drawing of the region has been completed, the area and center of gravity are registered. This position will be taken as the reference. Therefore, draw the region after putting the measurement object in the correct position.

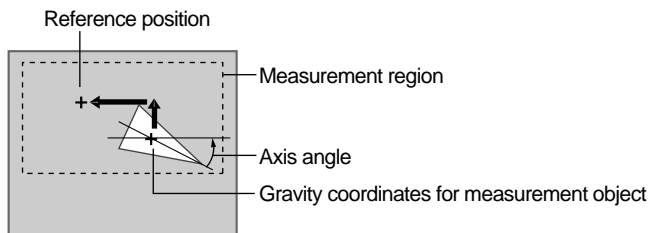

CHECK

Scroll the center of gravity coordinates of the measurement object to this reference position.

3. Setting the Judgement Conditions

It is necessary to set judgement conditions for position displacement compensation in order to evaluate whether the measurement object is contained within the field of view at the time of measurement. Set the range for an OK judgement.

Example: NG judgement

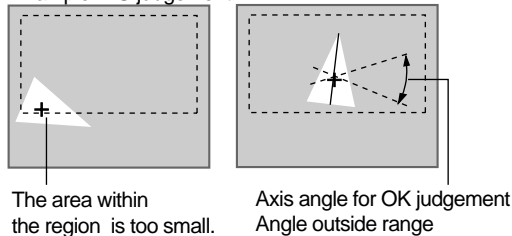

Once steps 1 to 3 have been completed, the measurement conditions have been set.

4. Setting Compensation Direction

- The X and Y coordinates measured for region 0 are used, so specify **Region 0** for X, Y, and θ .

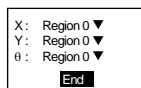

4-2-1-6 Objects at an Angle with Characteristic Features

Measurement method: Rotation search. Refer to page 180.

Position displacement compensation region: 1st region (Region 0)

Compensation direction: 1st direction.

1. Setting the Measurement Conditions

Set the conditions for the search.

2. Registering the Model

A characteristic part of the measurement image, is registered as a model. The model can be of any size.

When a model is registered, the registered status becomes 0° and the center position of the model is registered as the search coordinates. Therefore, draw the model after putting the measurement object in the correct position.

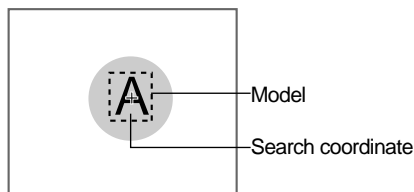

CHECK

Scroll the search coordinates for the measurement object to this position.

3. Setting the Search Region

Set the region for which the model is to be searched. It is possible to perform a search for the entire input image but processing time can be reduced and accuracy can be increased by setting limits on the search range.

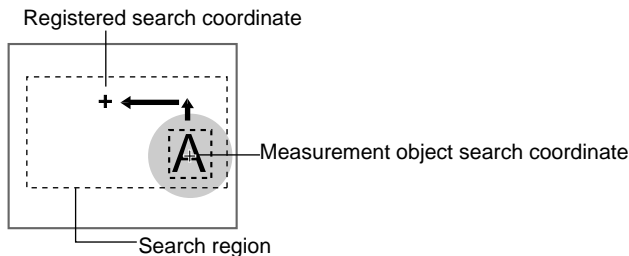

4. Setting the Judgement Conditions

If the correlation value with the model is low, the wrong place may be found. In order to judge whether the model for position displacement compensation has been correctly identified, it is necessary to set judgement conditions.

Example: NG judgement

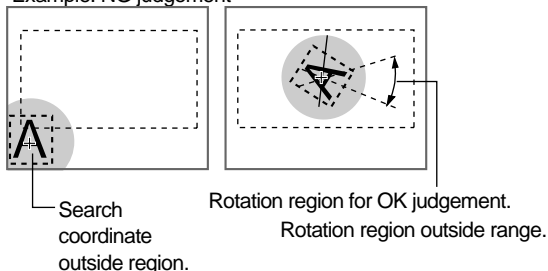

When steps 1 to 4 have been completed, the measurement conditions for position compensation have been completed.

5. Setting Compensation Direction

The X and Y coordinates measured for region 0 are used, so specify **Region 0** for X, Y, and θ .

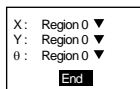

4-2-1-7 Precise Position Compensation of Measurement Objects at an Angle

Measurement method: Rotation search. Refer to page 180.

Position displacement compensation region: 1st region (Region 0, region 1)

Compensation direction: 1st direction.

CHECK

The measurement time will be increased due to the second position compensation.

1. Setting the Search Conditions for Region 0.

Model and search coordinates for region 0

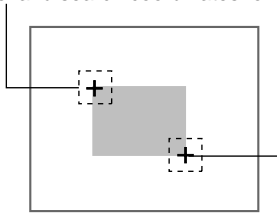

Model and search coordinates for region 1

2. Setting the Search Conditions for Region 1.

When steps 1 and 2 have been completed, the measurement conditions for position compensation have been completed.

3. Setting Compensation Direction

Make the settings shown in the following diagram.

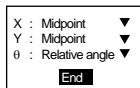

HELP

Midpoints and Relative Angles

The center coordinates and angle of the line connecting two measurement regions are used for position compensation.

The relative angle is displayed between 0° and 360°, with the X direction 0° and movement from the X axis to the Y axis being the positive direction.

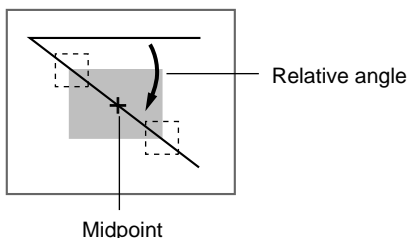

4-2-1-8 Accurate Position Compensation

Measurement method: Edge position. Refer to page 128.

Region and direction used: 1st region (Region 0), 1st direction

2nd region (Region 3), 2nd direction

The displacement for the 1st region is scrolled and then the displacement for the 2nd region is scrolled, so accurate position compensation can be ensured.

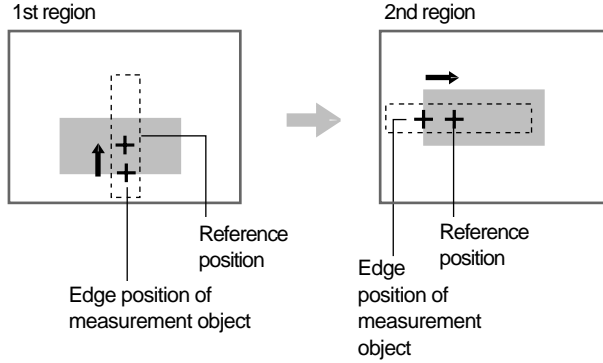

CHECK

Set the 1st region so that the longest edge is used for position compensation. The greater width enables the edge to be detected even if the measurement object is displaced somewhat.

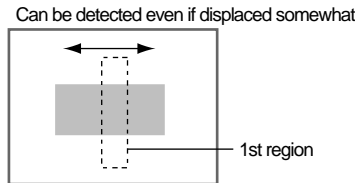

1. Setting the Conditions for 1st Region

In this example, the edge position conditions for the Y direction will be set.

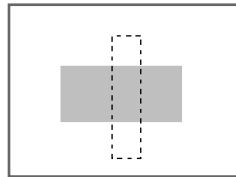

2. Setting 1st Direction

The displacement in the Y direction will be compensated, so make the settings shown in the following diagram.

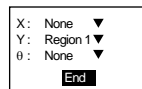

3. Setting the Conditions for 2nd Region

Set the edge position conditions for the X direction.

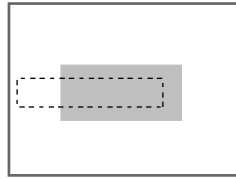

4. Setting 2nd Direction

The displacement in the X direction will be compensated, so make the settings shown in the following diagram

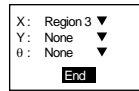

4-3 Details on Expressions

Expressions are used to set the data to be output to external devices or Memory Cards.

Only measurement commands executed in Run Mode are output. The measurement commands executed in Monitor Mode are not output to external devices. Even if expressions are not set, the overall judgement for the measurement region will be output to the OR signal of the parallel interface.

CHECK Set the data output destination under *System/Output Settings*. Refer to page 294.

CHECK Select whether or not to reflect expression results in the overall judgement. Refer to page 323.

Variables

Expressions can be set that are not to be output to external devices. It is useful to set long expressions as variables when they cannot fit within the square brackets [] or are used frequently.

Variable0

R0.X-R1.X

Measurement : 578908.965

Upper : [550000.000]

Lower : [600000.000]

ENT:Change

Expression number
32 expressions can be set in variables 0 to 31.

Expression

Measurement result for displayed image
Use as reference for judgement conditions.

Judgement conditions
Set the judgement conditions for the expression.
(-9,999,999.999 to 9,999,999.999)

Data

The measurement result for each region can be output. Calculated values can be output.

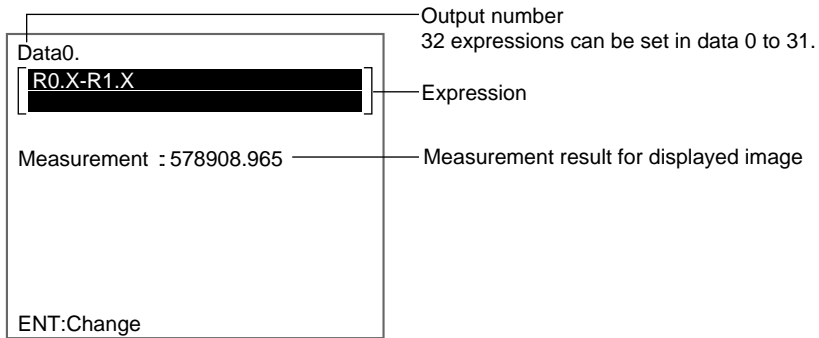

Judgements

The judgement result for each region can be output. The measurement result for each region can be calculated and an OK/NG judgement made for the result of each calculation.

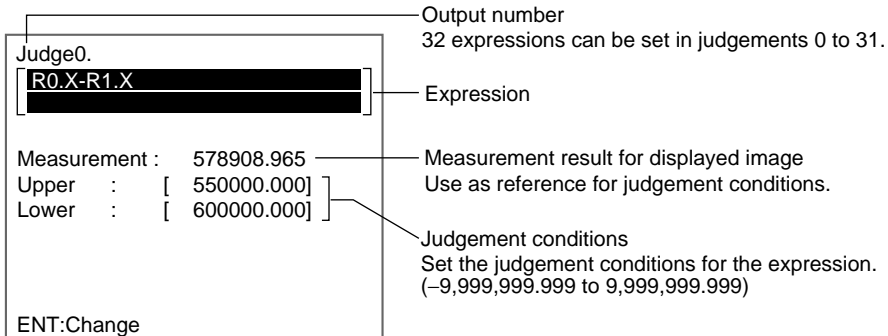

4-3-1 Setting Expressions

In this explanation of how to set expressions, *Variable* will be selected as an example.

1. Select **Expression** in Set Mode.

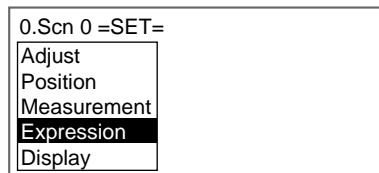

The setting options will be displayed.

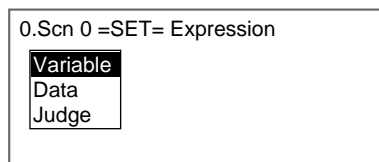

2. Select **Variable**.

A list of the expression numbers will be displayed.

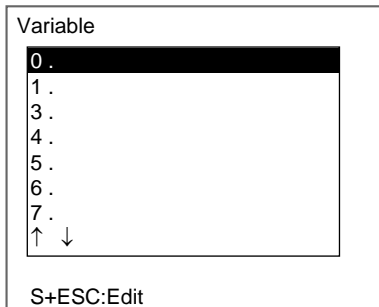

3. Select the number of the expression to be set.
The screen for making expression settings will be displayed.

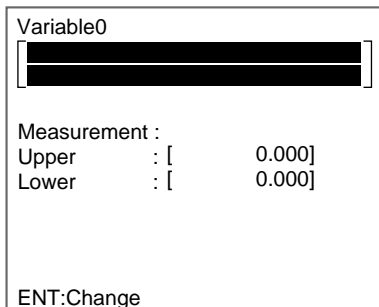

4. Move the cursor to within the square brackets [] of the expression and press the **ENT** Key.

A list of setting items will be displayed.

SeeAlso

Refer to page 223 for the list of setting items.

5. Select the item to be set. (Here, **Measurement** is selected as an example.)

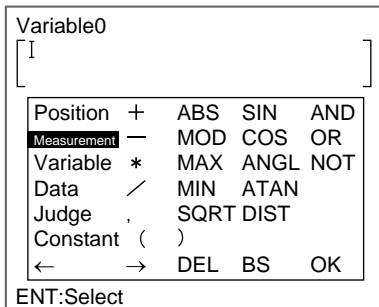

The region numbers will be displayed.

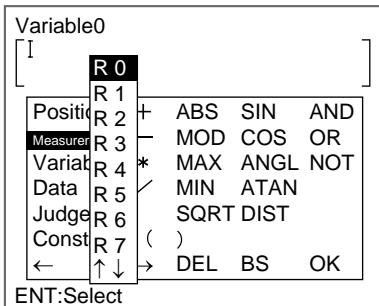

6. Select the region number to be set.
A submenu will be displayed.
The displayed submenu will depend on the measurement conditions set for the region.

SeeAlso

Refer to page 225 for a list of submenus.

7. Select the setting item from the submenu.

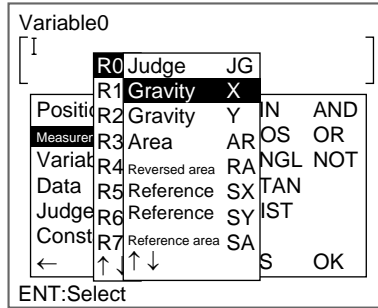

The selected items will be set to the expression.

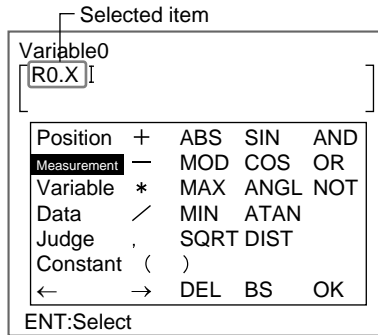

8. Combine the functions to create an expression.
9. Once the expression has been set, select **OK**.
If **Data** was selected in (2.), go to step 11.

The expression will be set.

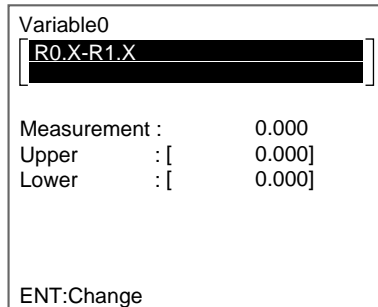

10. If **Variable** or **Judge** were selected, set the judgement conditions for an OK/NG judgement.

SeeAlso

Refer to page 29 for details on inputting values.

11. Press the **ESC** Key.

The settings will be registered.

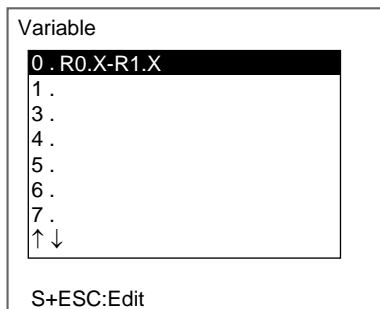

CHECK

Press the SHIFT + ESC Keys at this screen to copy or clear the expression. The correlation information will be copied for expressions with correlation information.

12. Press the **ESC** Key again.
The screen in (2.) will return.

List of Items that Can Be Set at Step 5

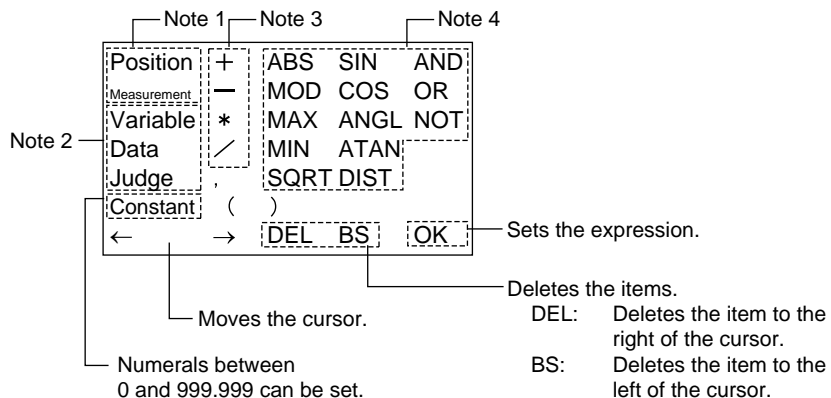

Note 1. Regions

When this item is selected, a list of region numbers will be displayed and the calculation can be performed using the measurement result set for the region.

A submenu will be displayed when the region number is selected.

	Region No.
Position compensation	P0 to P.3
Measurement region	R0 to R31

The contents of the submenu will differ depending on what measurement items have been set for the region.

2. Types of Expressions

When this item is selected, a list of expression numbers will be displayed and calculation can be performed using values for other expressions.

SeeAlso

Refer to page 231.

Type of expression	Expression No.	
	Measurement	Judgement result
Variable	VR.0 to VR.31	VJ.0 to VJ.31
Data	RS.0 to RS.31	---
Judge	PR.0 to PR.31	PJ.0 to PJ.31

3. Arithmetic Operators

Operators	Meaning
+	Addition
-	Subtraction
*	Multiplication
/	Real number division

4. Functions

Function	Meaning
ABS	Calculates the absolute value. ABS(argument)
MOD	Calculates the remainder when a number is divided by an ordinal number. MOD(dividend, ordinal number) When multiplication and division are performed and real numbers are used, the real numbers are rounded off to the nearest integer. The result is the remainder from the division of the integer. Examples MOD(13, 4) = 1 (Remainder when 13 is divided by 4.) MOD(25.68, 6.99) = 5 (Remainder when 26 is divided by 7.)
MAX	Gives the larger of two arguments. MAX(argument 1, argument 2)
MIN	Gives the smaller of two arguments. MIN(argument 1, argument 2)
SQRT	Calculates the square root. If the argument is negative, the calculation result will be 0 and the judgement will be NG. SQRT(argument)
SIN	Calculates the sine. The result will be given between -1 and 1. The angle in the expression is specified in degrees. SIN(expression)
COS	Calculates the cosine. The result will be given between -1 and 1. The angle in the expression is specified in degrees. COS(expression)

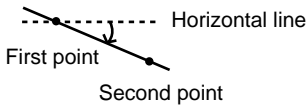
Function	Meaning
ANGL	<p>Calculates the angle between a straight line joining two points, such as the center of gravity or the center of a model, and a horizontal line. The result will be in the range -180 to 180°.</p> <p>ANGL(Y component, X component)</p> <p>Example: Set the following to calculate the angle between the straight line joining the center of gravity for region 0 and the center of gravity for region 1 and a horizontal line.</p> <p style="text-align: center;">ANGL(R1.Y-R0.Y,R1.X-R0.X)</p>  <p style="text-align: center;">If both arguments are 0, the result will also be 0 and the judgement will be NG.</p>
ATAN	<p>Calculates the arc tangent for the Y component/X component. The result is given as a radian of -pi to pi.</p> <p>ATAN(Y component, X component)</p> <p>Example: Set the following to calculate the angle between a straight line joining the center of gravity for region 0 and the center of gravity for region 1 and a horizontal line.</p> <p>ATAN(R1.Y-R0.Y,R1.X-R0.X)</p> <p>If both arguments are 0, the calculation result will also be 0 and the judgement will be NG.</p>
DIST	<p>Calculates the distance between two points, such as the center of gravity and the center of the model.</p> <p>DIST(X coordinate of first point, Y coordinate of first point, X coordinate of second point, Y coordinate of second point)</p> <p>Example: Set the following to calculate the distance between the center of gravity for region 0 and center of gravity for region 1.</p> <p>DIST(R0.X,R0.Y,R1.X,R1.Y)</p> <p>The following calculation is performed internally.</p> $\sqrt{(R1.X - R0.X)^2 + (R1.Y - R0.Y)^2}$
AND	<p>Calculates the LOGICAL AND.</p> <p>If one of the arguments is 0, the calculation result will be 0. Other arguments will give -1.</p> <p>AND(argument 1, argument 2)</p>
OR	<p>Calculates the LOGICAL OR.</p> <p>If one of the arguments is 0, the calculation result will be 0. Other arguments will give -1.</p> <p>OR(argument 1, argument 2)</p>
NOT	<p>Calculates the LOGICAL NOT.</p> <p>If the argument is 0, the calculation result will be -1. Otherwise it will be 0.</p> <p>NOT(argument)</p>

List of Submenus for Step 7

Area (Variable Box)

Measurement item	Meaning
Judge JG	Judgement result
Measurement X1	X coordinate for upper-left corner of measurement region
Measurement Y1	Y coordinate for upper-left corner of measurement region
Measurement X2	X coordinate for lower-right corner of measurement region

Measurement item	Meaning
Measurement Y2	Y coordinate for lower-right corner of measurement region
Gravity X	X coordinate for center of gravity of measurement result
Gravity Y	Y coordinate for center of gravity of measurement result
Area AR	Area of measurement result
Reversed area RA	Difference between area of measurement region and area measurement
Reference SX	X coordinate when measurement region drawn
Reference SY	Y coordinate when measurement region drawn
Reference area SA	Area when measurement region drawn
Displacement DX	Difference between measurement and reference X coordinate
Displacement DY	Difference between measurement and reference Y coordinate
Diff. area DA	Difference between measurement and area of reference value

Defect (Variable Box)

Measurement item	Meaning
Judge JG	Judgement result
Measurement X1	X coordinate for upper-left corner of measurement region
Measurement Y1	Y coordinate for upper-left corner of measurement region
Measurement X2	X coordinate for lower-right corner of measurement region
Measurement Y2	Y coordinate for lower-right corner of measurement region
Defect position X	X coordinate of the measured defect position
Defect position Y	Y coordinate of the measured defect position
Defect F	Measured defect
Max. density GA	Maximum density within measurement region
Min. density GI	Minimum density within measurement region
Reference SX	X coordinate when measurement region drawn
Reference SY	Y coordinate when measurement region drawn
Displacement DX	Difference between measurement and reference X coordinate
Displacement DY	Difference between measurement and reference Y coordinate

Gravity and area/Gravity and axis

Measurement item	Meaning
Judge JG	Judgement result
Gravity X	X coordinate for center of gravity of measurement result
Gravity Y	Y coordinate for center of gravity of measurement result
Axis angle TH (See note.)	Axis angle of measurement result
Area AR	Area of measurement result
Reversed area RA	Difference between area of measurement region and area measurement
Reference SX	X coordinate when measurement region drawn
Reference SY	Y coordinate when measurement region drawn
Reference axis ST (See note.)	Axis angle when measurement region drawn
Reference area SA	Area when measurement region drawn
Displacement DX	Difference between measurement and reference X coordinate

Measurement item	Meaning
Displacement DY	Difference between measurement and reference Y coordinate
Axis displacement DT (See note.)	Difference between measurement and reference axis angle.
Diff. area DA	Difference between area of measurement and area of reference value

Note TH, ST, and DT appear only when the region for gravity and axis is selected.

OCR for 1 character

Measurement item	Meaning
Judge JG	Judgement result
1st candidate C1	Character code for 1st candidate
2nd candidate C2	Character code for 2nd candidate
Similarity level SM	Similarity level of 1st candidate
Diff. level DS	Similarity level of 1st candidate - similarity level of 2nd candidate
Density deviation DV	Density deviation within the measurement region

Classification

Measurement item	Meaning
Judge JG	Judgement result
Search position X	X coordinate of position where model found
Search position Y	Y coordinate of position where model found
Correlation CR	Correlation with model
Index IN	Number of model with highest correlation

Defect

Measurement item	Meaning
Judge JG	Judgement result
Defect F	Measured defect
Max. density GA	Maximum density within measurement region
Min. density GI	Minimum density within measurement region
Defect position X	X coordinate of the measured defect position
Defect position Y	Y coordinate of the measured defect position
Reference SX	X coordinate when measurement region drawn
Reference SY	Y coordinate when measurement region drawn
Displacement DX	Difference between measurement and reference X coordinate
Displacement DY	Difference between measurement and reference Y coordinate

Density Average

Measurement item	Meaning
Judge JG	Judgement result
Dens average AV	Density average for measurement result
Dens deviation DV	Density deviation for measurement region
Ref. average SA	Density average when measurement region drawn
Ref. deviation SD	Density deviation when measurement region drawn
Diff. average DA	Difference between measurement and reference density average
Diff. deviation DD	Difference between measurement and reference density deviation

SeeAlso Refer to page 230 for information on *Judge JG*.

Edge Pitch

Measurement item	Meaning
Judge JG	Judgement result
No. of edges N	Number of detected edges
Average pitch P	Average detected edge pitch
Max. pitch PH	Maximum detected edge pitch
Min. pitch PL	Minimum detected edge pitch
Average width W	Average detected edge width
Max. width WH	Maximum detected edge width
Min. width WL	Minimum detected edge width

Edge Position

Measurement item	Meaning
Judge JG	Judgement result
Edge position X	X coordinate of measured edge position
Edge position Y	Y coordinate of measured edge position
Reference SX	X coordinate of edge when measurement region drawn
Reference SY	Y coordinate of edge when measurement region drawn
Displacement DX	Difference between measurement and reference X coordinate
Displacement DY	Difference between measurement and reference Y coordinate

Edge Width

Measurement item	Meaning
Judge JG	Judgement result
Width WD	Edge width of measurement result
Reference SW	Edge width when region drawn
Diff. width	Difference between measurement and reference edge widths

Gray Search/Precise Search/Flexible Search

Measurement item	Meaning
Judge JG	Judgement result
Search position X	X coordinate of position where model found
Search position Y	Y coordinate of position where model found
Correlation CR	Correlation with model
Reference SX	X coordinate when measurement region drawn

Measurement item	Meaning
Reference SY	Y coordinate when measurement region drawn
Displacement DX	Difference between measurement and reference X coordinate
Displacement DY	Difference between measurement and reference Y coordinate

Labeling

Measurement item	Meaning
Judge JG	Judgement result
No. of labels L	Number of labels measured
Search position X	X coordinate of center of gravity of position where model found
Search position Y	Y coordinate of center of gravity of position where model found
Area AR	Area of measurement result
Reference SX	X coordinate when measurement region drawn
Reference SY	Y coordinate when measurement region drawn
Reference area SA	Area when measurement region drawn
Displacement DX	Difference between measurement and reference X coordinate
Displacement DY	Difference between measurement and reference Y coordinate
Diff. area DA	Difference between area of measurement and area of reference value

Rotation Search

Measurement item	Meaning
Judge JG	Judgement result
Search position X	X coordinate of position where model found
Search position Y	Y coordinate of position where model found
Search angle TH	Angle of position where model found
Correlation CR	Correlation with model
Reference SX	X coordinate when measurement region drawn
Reference SY	Y coordinate when measurement region drawn
Reference axis ST	Axis angle when measurement region drawn
Displacement DX	Difference between measurement and reference X coordinate
Displacement DY	Difference between measurement and reference Y coordinate
Axis displacement DT	Difference between measurement and reference axis angle.

Relative Search

Measurement item	Meaning
Judge JG	Judgement result
Width X	Difference in X coordinates of positions where models found (model 1 - model 0)
Width Y	Difference in Y coordinates of positions where models found (model 1 - model 0)
Distance D	Distance between positions where models found
Correlation 0 C0	Correlation with model 0
Correlation 1 C1	Correlation with model 1

Measurement item	Meaning
Reference SX	Difference in X coordinates of positions where models registered (model 1 - model 0)
Reference SY	Difference in Y coordinates of positions where models registered (model 1 - model 0)
Ref. distance SD	Distance between positions where models registered
Displacement DX	Difference between width X and reference SX
Displacement DY	Difference between width Y and reference SY
Diff. deviation DD	Difference between measured distance and reference distance

SeeAlso Refer to page 230 for information on *Judge JG*.

Judge JG

When Judge JG Is Set for *Expression/Variable* or *Expression/Judge*

Judgement is performed using the following two steps.

1. Judgement based on judgement conditions set for each region, giving a result of "0.000"(OK) or "-1.000"(NG) for measurement.
2. Measurement evaluated for 1. based on upper and lower judgement limits for that screen.

When *Expression/Judge* is selected, the judgement result is output to an external device.

Example 1: Outputting Judgement Result for Region 0 to Judge 0.

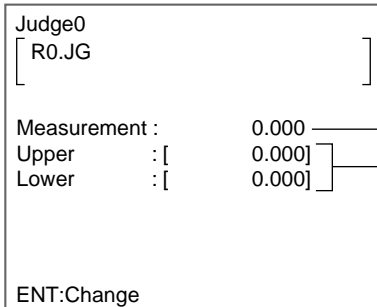

0.000 : OK -1.000:NG
Judgement output based on judgement conditions for measurement region 0.
Judgement conditions for R0.JG
For an OK judgement for 0.000 only, set both the upper and lower limits to 0.000.

Example 2: Outputting Judgement Result for Regions 0 and 1 to Judge 0.

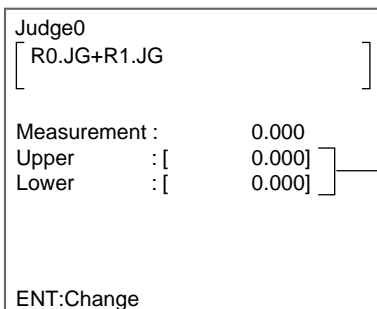

When set to 0.000, the judgements are made as follows:

- | | Measurement | Judgement |
|---|-------------------|-------------|
| • | When both are OK: | 0.000 → OK |
| • | When one is NG: | -1.000 → NG |
| • | When both are NG: | -2.000 → NG |

When Judge JG Is Set for *Expression/Data*

Only the first judgement step outlined above will be performed. The following results will be output to an external device:

For an OK judgment: 0.000

For an NG judgement: -1.000

When not measured: -2.000

Calculating Using Other Expression Values

When *Variable*, *Data*, or *Judge* are selected from the list of setting items, calculations can be performed using values from other expressions.

Example 1: Calculating Reference and Measurement Distances to Output the Difference

Measurement region 0

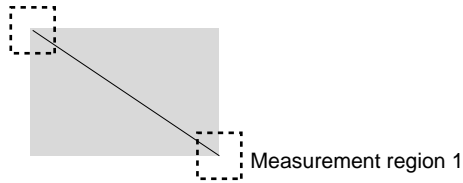

Make the settings for Variable 0, Variable 1, and Judge 1.

Variable0
[DIST(R0.SX,R0.SY,R1.SX,R1.SY)]

Measurement : 158.121
Upper : [180.000]
Lower : [130.000]

ENT:Change

Set the expression for calculating the distance between the two points of the reference position.

Variable1
[DIST(R0.X,R0.Y,R1.X,R1.Y)]

Measurement : 158.121
Upper : [180.000]
Lower : [130.000]

ENT:Change

Set the expression for calculating the distance between the two points of the measurement position.

Judge1
[VR.1-VR.0]

Insert the calculation result for Variable 0.

ENT:Change

Calculate the difference between Variable 0 and Variable 1.

CHECK Use higher output numbers for VR.□, RS.□, and PR.□. The calculations are performed in the order shown to the right below. Therefore, if smaller output

numbers are used for VR.□, RS.□, and PR.□, the previous calculation result will be inserted.

When the distance between the two points in the measurement region in example 1 is calculated and 120.25 added to that value.

Variable0	
[DIST(R0.X,R0.Y,R1.X,R1.Y)]	
Measurement :	158.121
Upper :	[180.000]
Lower :	[120.000]

The distance between the two points is calculated.

Variable1	
[VR.0+120.25]	
Measurement :	158.121
Upper :	[180.000]
Lower :	[120.000]

120.25 is added to the result for Variable 0.

When expression set in the opposite order:

Variable0	
[VR.1+120.25]	
Measurement :	158.121
Upper :	[180.000]
Lower :	[120.000]

Variable 0 is calculated before Variable 1, so the previous calculation result is inserted to VR.1.

Variable1	
[DIST(R0.X,R0.Y,R1.X,R1.Y)]	
Measurement :	158.121
Upper :	[180.000]
Lower :	[120.000]

Order for Calculation

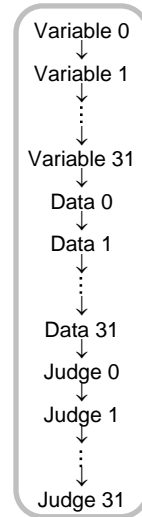

Example 2: Outputting the number of measurements

The value is to be output, so set the expression under *Expression/Data*.

Data0	
[RS.0+1]	
Measurement :	0.000
ENT:Change	

CHECK If you input the RESET signal or turn OFF the power supply, RS.0 will return to “0” and the number of measurements will also be reset.

4-4 Display Details

Figures, characters, data, and other information can be added to the screen display in Monitor and Run Modes. Up to 32 pieces of information can be

added for each scene. This section gives information on the settings possible under *Display* in Set Mode.

CHECK The data set here will be displayed when *None* or *All positions of regions* are selected under *System/Conditions/Display settings/Display results*. Only fixed figures are always displayed, even if other items are selected.

CHECK The settings are the same for Camera 0 and Camera 1 and cannot be made separately for each Camera.

Characters can be added and the display position can be changed.

The screenshot shows a measurement display interface with the following elements and callouts:

- Top status bar: 0.Scen 0, MON (dropdown), OK, 67ms. Callout: "Suitable characters are displayed. Refer to page 236."
- Measurement value: Diff. from ref: 20. Callout: "Displays the measurement at a suitable position. Refer to page 238."
- Product name: OK product. Callout: "Displays suitable characters based on measurement result. Refer to page 241."
- Search status: 0.Gray search. Callout: "Displays the measurement region name in a suitable position. Refer to page 245."
- Date and time: 10/01 01:23:45. Callout: "Displays the measurement time and date. Refer to page 246."
- Freeze button: Freeze. Callout: "Refer to page 246."

Visibility of measurement result improved.

The screenshot shows a measurement display interface with the following elements and callouts:

- Top status bar: 0.LABEL, MON (dropdown), OK, 67ms. Callout: "Always displays straight lines and other fixed figures (can be used as guide for measurement object position) Refer to page 248."
- Measurement area: A bottle with a label "OMRON" is shown. A vertical line and a horizontal line intersect at the center of the label. Callout: "(Displays figure in detection position. Display cursor appears at label detection position in this example) Refer to page 250."
- Freeze button: Freeze.

CHECK The following customize functions are supported in addition to *Display*.

- Messages can be changed to words normally used.

Change scene name to detection target
Refer to page 264.

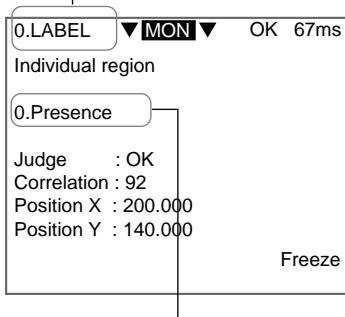

- Unnecessary information can be omitted from the display.
(This setting is applied to all scenes.)

Omit this section from display.
Refer to page 298.

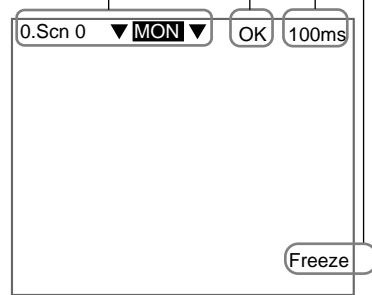

Change region name to measurement target
Refer to page 256.

CHECK The screens in Set Mode can also be customized. These settings will be applied to all scenes.

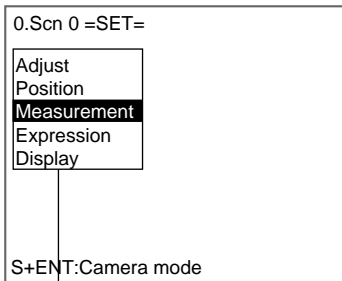

Can select whether or not to display the menus displayed when entering Set mode.

Refer to page 314.

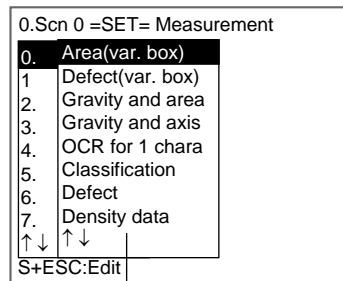

Can select whether or not to display the processing items displayed under the measurement region.

Refer to page 315.

4-5 Display Strings

Use this function to display any alphanumeric characters in Run and Monitor Modes.

CHECK The data set here will be enabled when *None* or *All positions of regions* are selected under *System/Conditions/Display settings/Display results*.

CHECK Even when the display image is set to be displayed as a reduced image under *System settings/Set disp*, the characters will always be displayed in the specified position.

Operational Flow

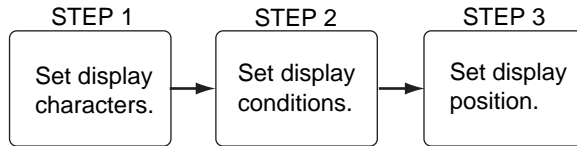

4-5-1 STEP 1: Setting Display Characters

Up to 29 standard size alphanumeric characters can be set. The characters can be selected from the list of characters on the displayed software keyboard.

1. Select **Display**/**<Region number>**/**Display string**.

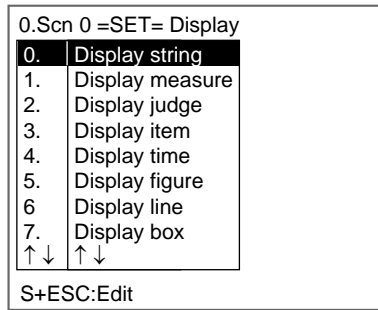

The setting selections will be displayed.

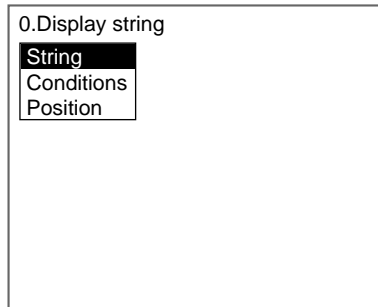

2. Select **String**.

The software keyboard screen will be displayed.

SeeAlso

Refer to page 31 for details on inputting characters.

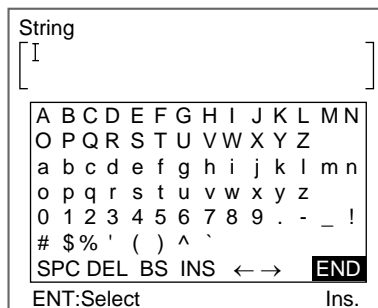

3. Select a character and press the **ENT** Key.
The selected character will be set.
4. Repeat step 3 and set all characters to be displayed.

- Once all characters have been selected, select **END**.
The settings will be registered and the screen in (2.) will return.

4-5-2 STEP 2: Setting Display Conditions

Set the conditions for display. The font cannot be specified. The display font will be the same as the menu font.

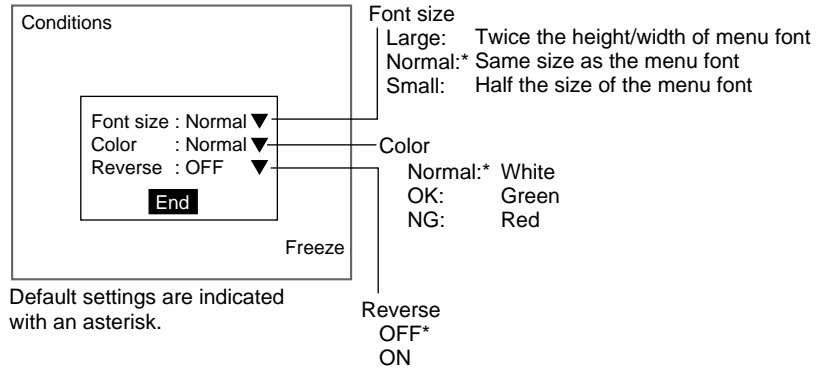

CHECK The font colors can be changed. Refer to page 306.

- Select **Conditions**.

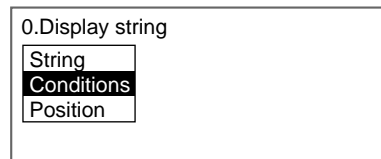

The Conditions Settings Screen will be displayed.

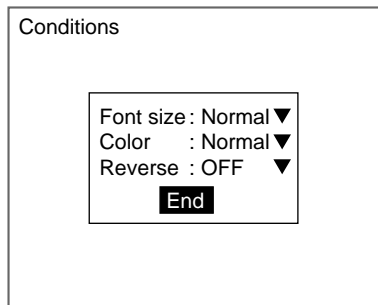

- Make the settings for each item.
- Select **END**.
The settings will be registered and the screen in (1.) will return.

4-5-3 STEP 3: Setting Display Position

Set the position for character display. The size of the display region shown on the screen is the same as the actual size when displayed. Use this as a reference for deciding positions.

1. Select **Position**.

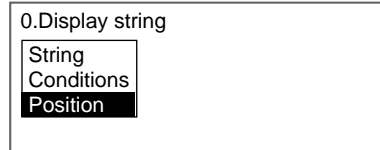

The cursor for setting position and the display region will be displayed.

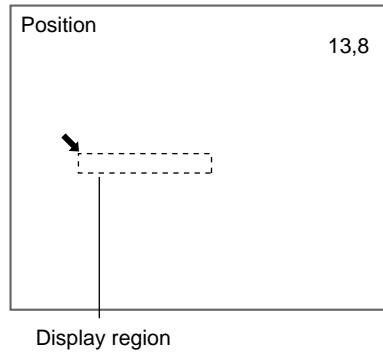

TwoCamera

Press the SHIFT+ENT Keys to switch between Camera 0 and Camera 1 images.

2. Use the **Up/Down** and **Right/Left** Keys to move the display region.
3. Press the **ENT** Key to set the position.

The settings will be registered and the screen in (1.) will return.

4-6 Displaying Measurements

Use this function to display any measurement data on the screens in Run and Monitor Modes. The display is set using expression, so region measurements or operands using measurement values can be used.

CHECK The data set here will be enabled when *None* or *All positions of regions* are selected under *System/Conditions/Display settings/Display results*.

CHECK Even when the display image is set to be displayed as a reduced image, the characters will always be displayed in the specified position.

Operational Flow

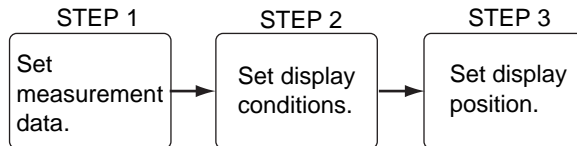

4-6-1 STEP 1: Setting Measurement Conditions

Use expressions to set the measurement data to be displayed.

SeeAlso Refer to page 219 for methods for setting expressions.

1. Select **Display**/*<Region number>/Display measure*.

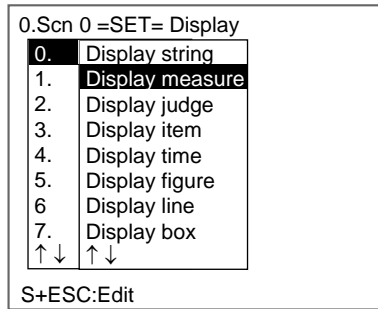

The setting selections will be displayed.

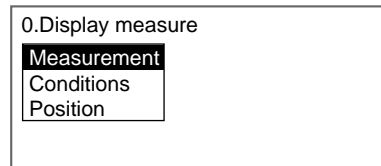

2. Select **Measurement**.

The Measurement Settings Screen will be displayed.

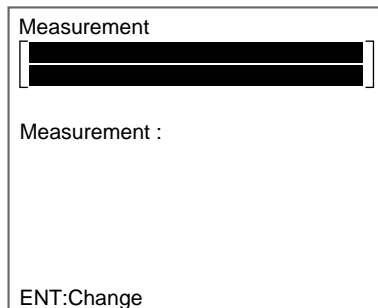

3. Move the cursor to the square brackets [] for the measurement data and press the **ENT** Key.

A list of setting items will be displayed.

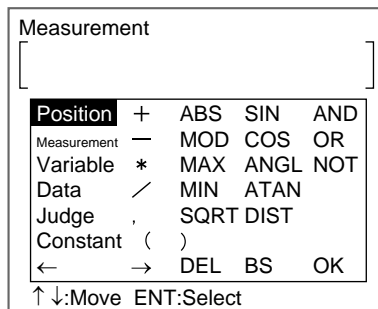

4. Select the items to be set and set the expressions.

SeeAlso

Refer to page 223 for a list of setting items.

5. Once the expression has been set, select **OK**.

The expression will be set and the screen in (3.) will return.

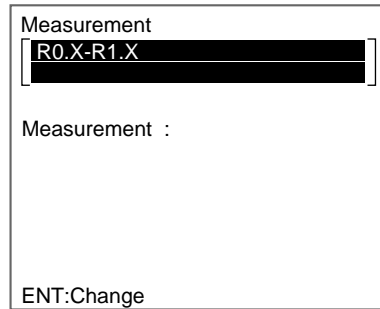

6. Press the **ESC** Key.

The settings will be registered and the screen in (2.) will return.

4-6-2 STEP 2: Setting Display Conditions

Set the conditions for display. The font cannot be specified. The display font will be the same as the menu font.

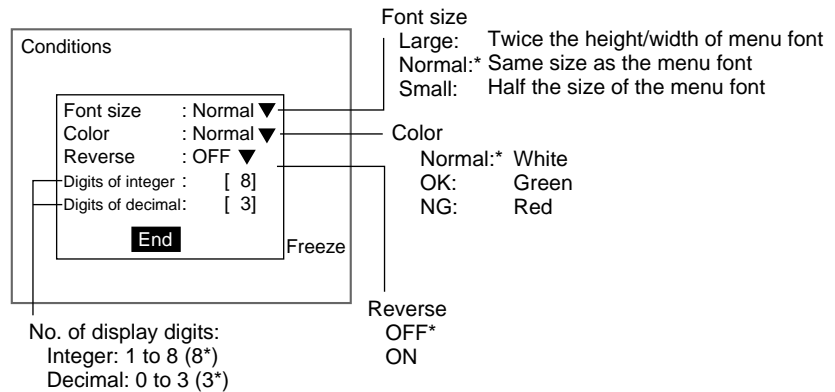

*Default settings are indicated with an asterisk.

CHECK The font colors can be changed. Refer to page 306.

1. Select **Conditions**.

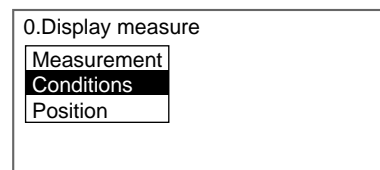

The Conditions Settings Screen will be displayed.

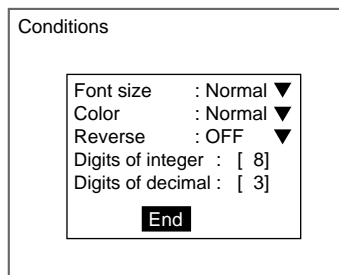

2. Make the settings for each item.
3. Select **End**.

The settings will be registered and the screen in (1.) will return.

4-6-3 STEP 3: Setting Display Position

Set the position for character display. The size of the display region shown on the screen is the same as the actual size when displayed. Use this as a reference for deciding positions.

The settings are the same as for *Display string*.

SeeAlso Refer to page 237.

4-7 Displaying Judgements

Use this function to display suitable characters in Run and Monitor Modes based on expression results. Set the expressions for display and set the characters to be displayed for the different judgement results (OK, NG).

CHECK The data set here will be enabled when *None* or *All positions of regions* are selected under *System/Conditions/Display settings/Display results*.

CHECK Even when the display image is set to be displayed as a reduced image, the characters will always be displayed in the specified position.

Operational Flow

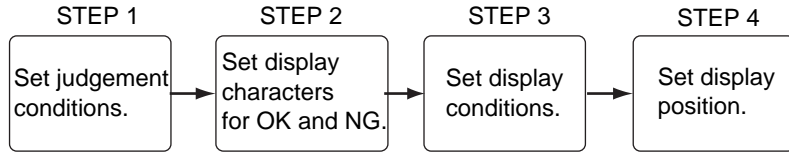

4-7-1 STEP 1: Setting Judgement Criteria

Use expressions to set the judgement criteria.

SeeAlso Refer to page 219 for methods for setting expressions.

1. Select **Display**/*<Region number>*/**Display judge**.

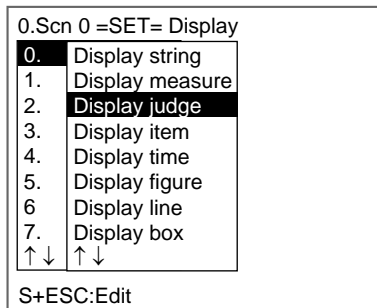

The setting selections will be displayed.

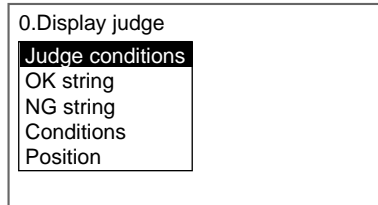

2. Select **Judge conditions**.

The Judge Conditions Settings Screen will be displayed.

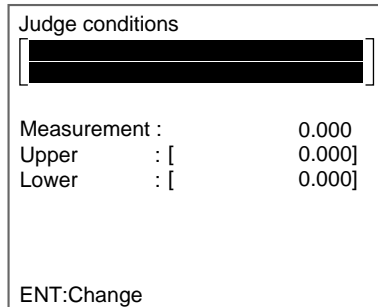

3. Move the cursor to the square brackets [] for the expression and press the **ENT** Key.

A list of setting items will be displayed.

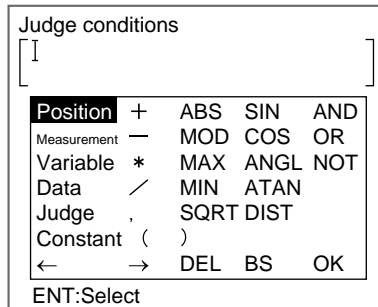

4. Select the items to be set and set the expression.

SeeAlso

Refer to page 223 for a list of setting items.

5. Once the expression has been set, select **OK**.

The expression will be set and the screen in (3.) will return.

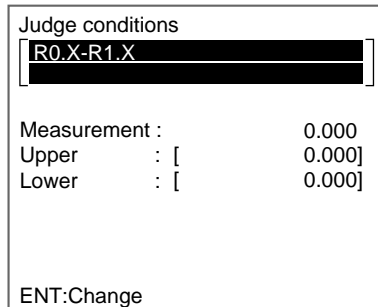

6. Set the conditions for OK and NG judgements.

SeeAlso

Refer to page 29 for details on inputting values.

7. Press the **ESC** Key.
The settings will be registered and the screen in (2.) will return.

4-7-2 STEP 2: Setting Display Characters for OK and NG Judgements

When the judgement result for the expression set in STEP 1: Setting Judgement Criteria is OK, set the characters to be displayed for a NG judgement. Up to 29 standard size alphanumeric characters can be set.

The characters can be selected from the list of characters on the displayed software keyboard.

1. Select either **OK string** or **NG string**.

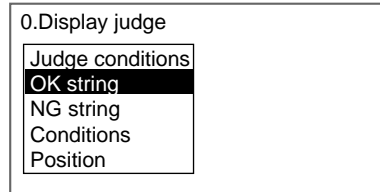

The software keyboard screen will be displayed.

SeeAlso

Refer to page 31 for details on inputting characters.

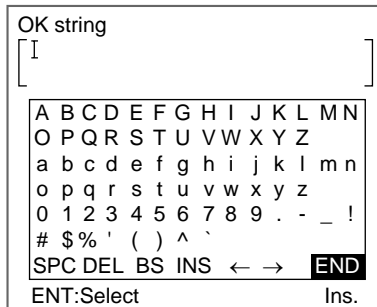

2. Select a character and press the **ENT** Key.
The selected character will be set.
3. Repeat step 2 and set all characters to be displayed.
4. Once all characters have been selected, select **END**.
The settings will be registered and the screen in (1.) will return.

4-7-3 STEP 3: Setting Display Conditions

Set the conditions for display. The font cannot be specified. The display font will be the same as the menu font.

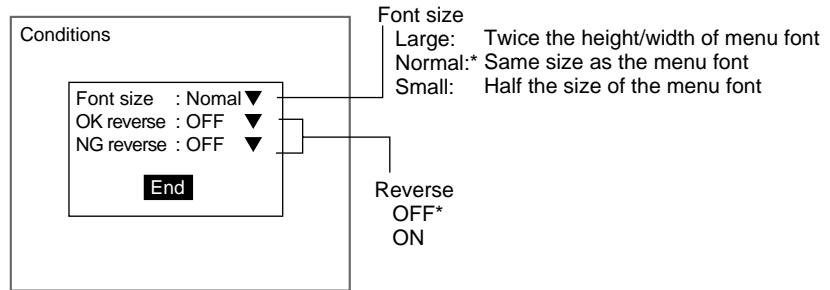

*Default settings are indicated with an asterisk.

1. Select **Conditions**.

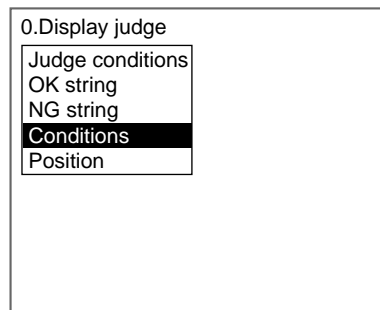

The Conditions Settings Screen will be displayed.

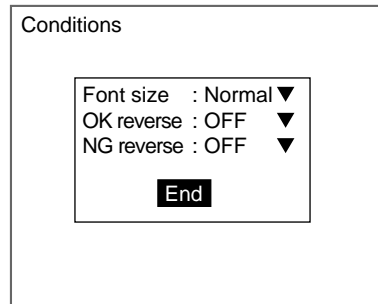

2. Make the settings for each item.
3. Select **End**.

The settings will be registered and the screen in (1.) will return.

4-7-4 STEP 4: Setting Display Position

Set the position for character display. The size of the display region shown on the screen is the same as the actual size when displayed. Use this as a reference for deciding positions.

The settings are the same as for *Display string*.

SeeAlso Refer to page 237.

4-8 Displaying Measurement Region Names

Use this function to display in Run and Monitor Modes one measurement region name set to the scene.

SeeAlso Refer to page 256 for information on inputting comments.

CHECK The data set here will be enabled when *None* or *All positions of regions* is selected under *System/Conditions/Display settings/Display results*.

CHECK Even when the display image is set to be displayed as a reduced image, the characters will always be displayed in the specified position.

Operational Flow

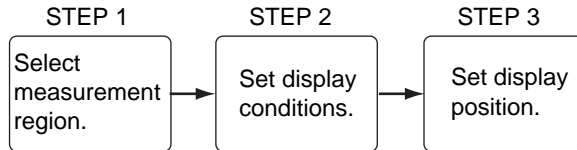

4-8-1 STEP 1: Selecting Measurement Regions

Select the name of the measurement region to be displayed.

1. Select **Display/Display item**.

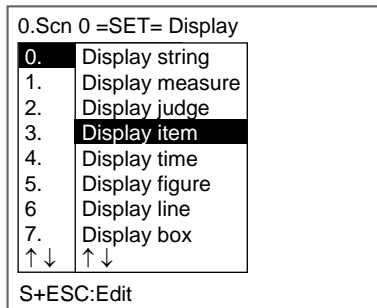

The setting selections will be displayed.

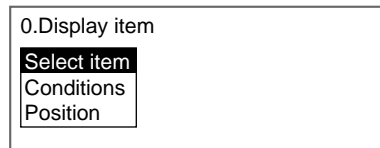

2. Select **Select item**.

A list of measurement regions set for the scene will be displayed.

If a comment has been input for the measurement region, the comment will be displayed.

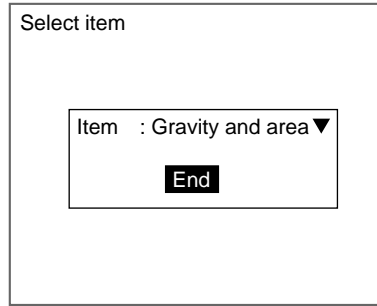

3. Select the region and select **End**.
The settings will be registered and the screen in (2.) will return.

4-8-2 STEP 2: Setting Display Conditions

Set the conditions for display. The font cannot be specified. The display font will be the same as the menu font.

The settings are the same as for *Display string*.

SeeAlso Refer to page 237.

4-8-3 STEP 3: Setting Display Position

Set the position for character display. The size of the display region shown on the screen is the same as the actual size when displayed. Use this as a reference for deciding position.

The settings are the same as for *Display string*.

SeeAlso Refer to page 237.

4-9 Displaying Measurement Time

This function displays the date and time of the measurement on the screens in Run and Monitor Modes. The calendar in the F160 must be adjusted and set beforehand.

SeeAlso Refer to page 325.

CHECK The data set here will be enabled when *None* or *All positions of regions* are selected under *System/Conditions/Display settings/Display results*.

CHECK Even when the display image is set to be displayed as a reduced image, the characters will always be displayed in the specified position.

Operational Flow

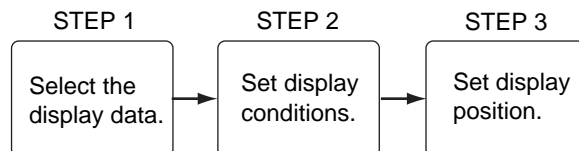

4-9-1 STEP 1: Selecting the Display Data

Select the format for the date and time display.

Format	Display
MMDD HHMMSS*	10/01 01:23:45
MMDDHHMM	10/01 01:23
HHMMSS	01:23:45
HHMM	01:23

Note *The default setting is marked with an asterisk.

1. Select **Display/Display time**.

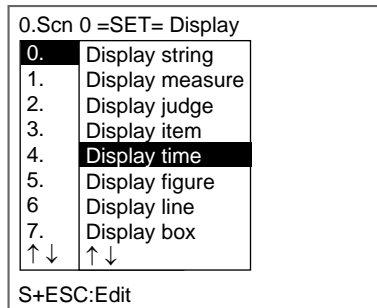

The setting selections will be displayed.

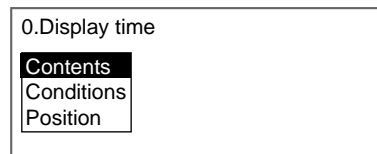

2. Select **Contents**.

The Contents Settings Screen will be displayed.

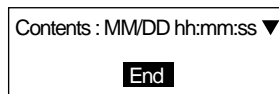

3. Select the display contents.
4. Select **End**.

The settings will be registered and the screen in (2.) will return.

4-9-2 STEP 2: Setting Display Conditions

Set the conditions for display. The font cannot be specified. The display font will be the same as the menu font.

The settings are the same as for *Display string*.

SeeAlso Refer to page 237.

4-9-3 STEP 3: Setting Display Position

Set the position for character display. The size of the display region shown on the screen is the same as the actual size when displayed. Use this as a reference for deciding positions.

The settings are the same as for *Display string*.

SeeAlso Refer to page 237.

4-10 Displaying Fixed Figures

Use this function to display lines, boxes, circles, and arcs at a fixed position on screens in Run and Monitor Modes.

CHECK If the image is reduced, the figure will also be reduced.

CHECK Select *Display results* to display figures using measurement results.

SeeAlso Refer to page 250.

Operational Flow

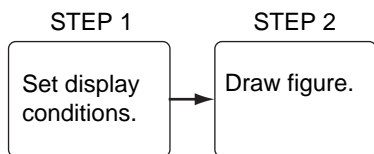

4-10-1 STEP 1: Setting Display Conditions

Set the conditions for display.

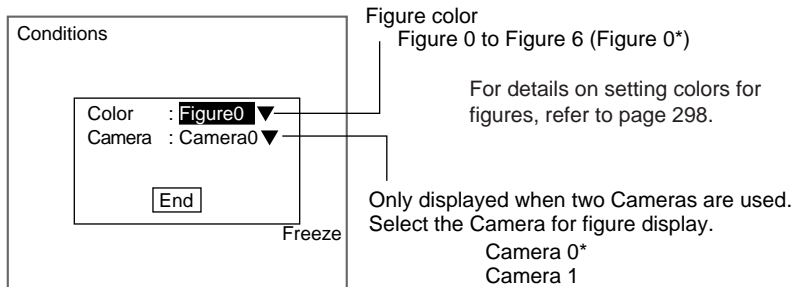

*Default settings are indicated with an asterisk.

1. Select **Display**/*<Region number>*/**Display figure**.

0.Sc0 =SET= Display	
0.	Display string
1.	Display measure
2.	Display judge
3.	Display item
4.	Display time
5.	Display figure
6.	Display line
7.	Display box
↑ ↓	↑ ↓
S+ESC:Edit	

The setting selections will be displayed.

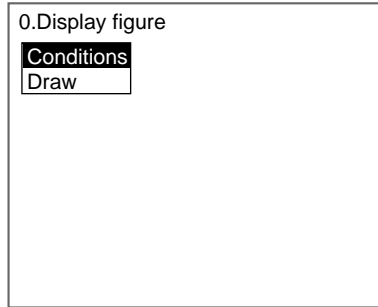

- 2. Select **Conditions**.

The Conditions Settings Screen will be displayed.

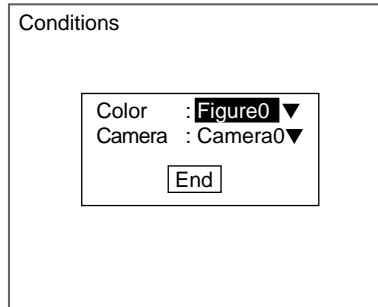

- 3. Make the settings for each item.
- 4. Select **End**.

The settings will be registered and the screen in (1.) will return.

4-10-2 STEP 2: Drawing Figures

Select a line, box, circle, circumference, or arc.

- 1. Select **Draw**.

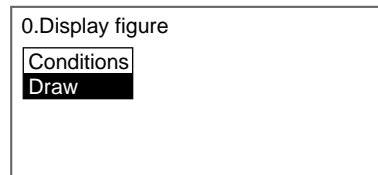

The setting selections will be displayed.

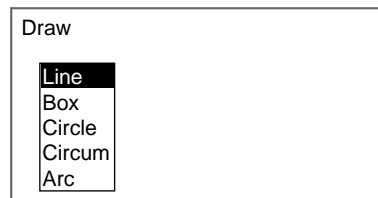

- 2. Select a figure.

The Draw Screen will be displayed.

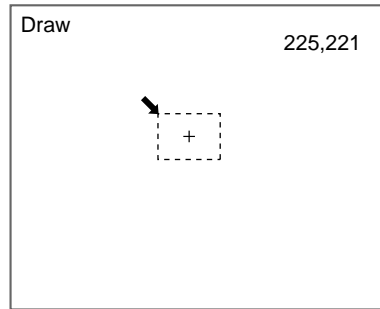

When **Line** has been selected, line options of **Solid line** and **Dash line** will be displayed. Choose one of these options.

3. Draw the figure in the desired position.

SeeAlso

Refer to page 28 for methods for drawing regions.

The setting will be registered and the screen in (1.) will return.

4-11 Displaying Results (Lines, Boxes, Circles, and Cursors)

Use this function to display on screens in Run and Monitor Modes the figures that used the calculation results.

CHECK The data set here will be enabled when *None* or *All positions of regions* are selected under *System/Conditions/Display settings/Display results*.

CHECK Even when the display image is set to be displayed as a reduced image, the figures will always be displayed in the specified position.

CHECK To display figures in a fixed position, select *Display figure*. Refer to page 248.

Operational Flow

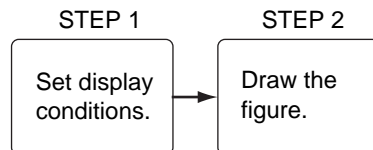

The operational flow will be described here using *Display box* as an example. Make adjustments as necessary when other options are selected.

4-11-1 STEP 1: Setting Display Conditions

Set the conditions for display.

Color
OK* : Green
NG : Red

Color : OK color ▼
Property : Solid line ▼
Camera : Camera0 ▼
End

Solid line*
Dash line
Fill profile

Only displayed when two Cameras are used.
Select the Camera for figure display.

Camera 0*
Camera 1
Camera 0+1

*Default settings are indicated with an asterisk.

CHECK

The font color can be changed. Refer to page 306.

1. Select **Display**/*<Region number>*/**Display box**.

0.Scen 0 =SET= Display

0. Display judge
1. Display item
2. Display time
3. Display figure
4. Display line
5. Display box
6. Display circle
7. Display cursor

↑ ↓ ↑ ↓

S+ESC>Edit

The setting selections will be displayed.

0.Display box

Conditions

1st point X
1st point Y
2nd point X
2nd point Y

2. Select **Conditions**.

The screen for setting display conditions will be displayed.

Color : OK color ▼
Property : Solid line ▼
Camera : Camera0 ▼
End





3. Make the settings for each item.
4. Select **End**.

The settings will be registered and the screen in (2.) will return.

4-11-2 STEP 2: Drawing Figures

The coordinates for the figure are set using expressions.

SeeAlso Refer to page 219 for methods for setting expressions.

Display	Coordinate specification method
Box result	Upper left coordinate (1st point X, 1st point Y)  Lower right coordinate (2nd point X, 2nd point Y)
Circle result	Center coordinate (Center X, Center Y)  Radius
Line result	Start point (1st point X, 1st point Y)  End point (2nd point X, 2nd point Y)
Cursor result	X coordinate, Y coordinate 

1. Select **1st point X**.

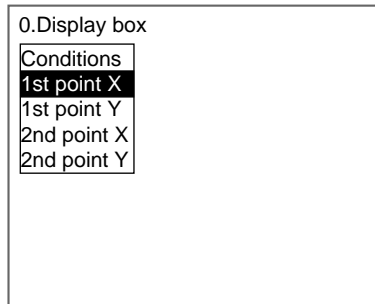

The 1st Point X Settings Screen will be displayed.

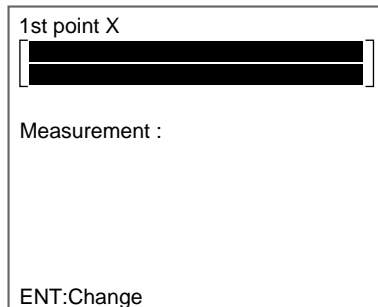

- Place the cursor in the square brackets [] for 1st point X and press the **ENT** Key.

The setting items will be displayed.

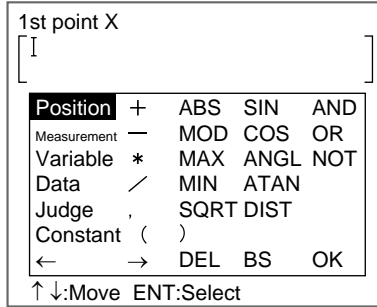

- Select the item to be set and set the expression.

SeeAlso

Refer to page 223 for information on the setting items.

- Once the expression has been set, select **OK**.

The expression will be registered and the screen in (2.) will return.

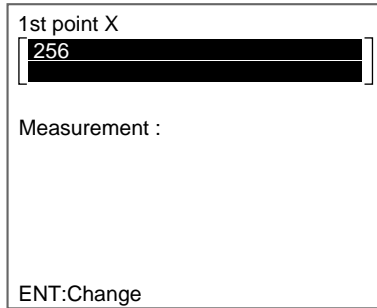

- Press the **ESC** Key.

The settings will be registered and the screen in (1.) will return.

Repeat the above steps to set the 1st point Y, 2nd point X, and 2nd point Y.

4-12 Editing Measurement Regions and Position Compensation Regions

This section explains the editing methods (copy, clear, set comment) used to regions set under *Measurement* and *Position*.

For this explanation, the editing methods for *Measurement* will be used as an example. Make adjustments as necessary to edit for *Position*.

4-12-1 Copying Regions

The copying function is useful for reusing set region data or changing only part of the data when setting measurement conditions.

The measurement method set for *Measurement* can be copied for *Position* (see note), and the measurement method set for *Position* can be copied for *Measurement*.

Note When copying from *Measurement* to *Position*, only the following six methods can be copied. The methods not listed here cannot be copied.

- Gravity and area
- Gravity and axis

- Labeling
- Gray search
- Edge position
- Rotation search

CHECK The copy function can be executed only within the same scene. When spanning scenes, copy the whole scene group.

SeeAlso Refer to page 262.

1. Enter Set Mode for the scene to be edited and select **Measurement**.

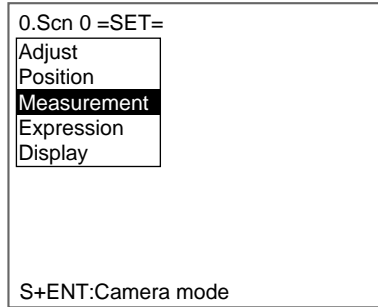

A list of regions will be displayed.

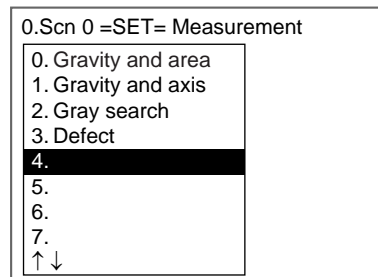

2. Move the cursor to the number for the region to be copied and press the **SHIFT + ESC** Keys.

The Copy/Clear/Comment Menu will be displayed.

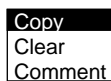

3. Select **Copy**.

The Original Region Screen for the region to be copied will be displayed.

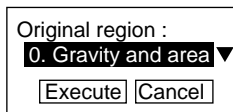

4. Move the cursor to the region and press the **ENT** Key.
All the regions set for the displayed scene will be displayed.

If there is a comment entered for a region, that comment will also be displayed.

Position compensation regions

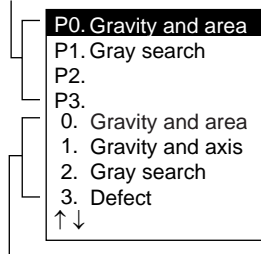

Measurement regions

5. Select the region number to be copied.
The screen in (4.) will return.
6. Select **Execute**.
The region data will be copied and the screen in (2.) will return.

4-12-2 Clearing Regions

This function clears the measurement method set for a region.

SeeAlso Refer to page 263 for information on how to clear entire scenes.

1. Enter Set Mode for the scene to be edited and select **Measurement**.

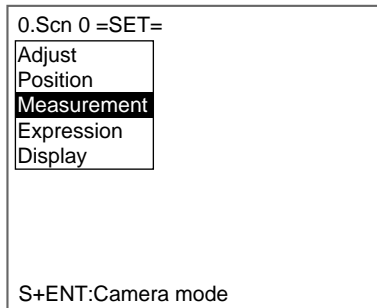

A list of regions will be displayed.

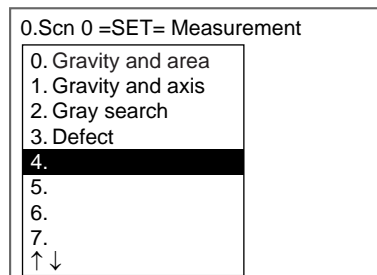

2. Move the cursor to the number for the region to be cleared and press the **SHIFT + ESC** Keys.

The Copy/Clear/Comment Menu will be displayed.

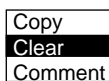

3. Select **Clear**.

A confirmation message will be displayed.

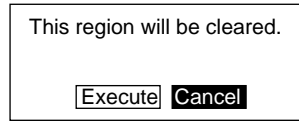

4. Select **Execute**.

The measurement data for the selected region number will be cleared and the screen in (2.) will return.

4-12-3 Changing Region Names (Inputting Comments)

Any comment can be added to any region. This is useful for understanding setting contents when many regions have been registered. Up to 16 standard characters can be set. The characters are selected and set from the software keyboard displayed on the screen.

1. Enter Set Mode for the scene to be edited and select **Measurement**.

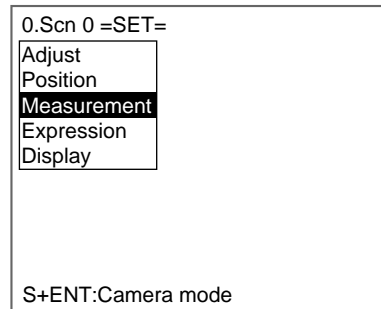

A list of regions will be displayed.

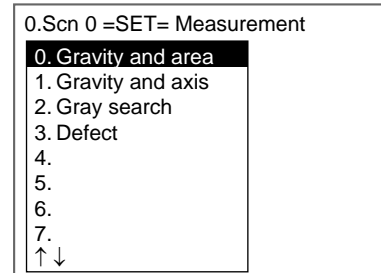

2. Move the cursor to the number for the region to be cleared and press the **SHIFT + ESC** Keys.

The Copy/Clear/Comment Menu will be displayed.



3. Select **Comment**.

The software keyboard will be displayed.

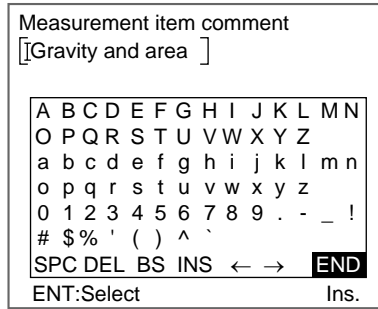

4. Set up to 16 standard characters.

SeeAlso

Refer to page 31 for details on inputting characters.

5. Once all characters have been set, select **END**.

The region name will be changed and the screen in (2.) will return.

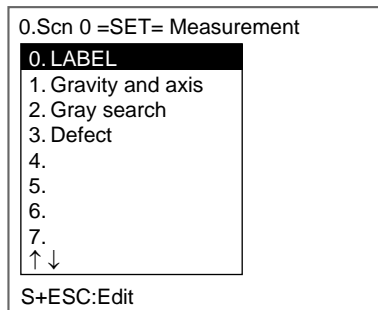

6. Press the **ESC** Key to exit this screen.

The screen in (1.) will return.

SECTION 5 Other Functions

This section describes additional functions such as changing the measurement setup or backing up data.

5-1	Changing Scenes and Scene Groups	260
5-1-1	Setting Measurement Conditions for Different Models: Changing Scenes	261
5-1-2	Copying Scene Data	262
5-1-3	Initializing Measurement Conditions: Clearing Scenes	263
5-1-4	Adding Comments to Scenes	264
5-1-5	Using Scene Group Function	265
5-2	Backing Up Data	266
5-2-1	Backing Up to a Personal Computer	266
5-2-2	Backing Up to Memory Cards	271
5-2-3	Backing Up to Flash Memory	275
5-3	Checking Image Density Distribution: Line Brightness	276
5-4	Checking I/O Status with External Devices	278
5-4-1	Serial Interface	278
5-4-2	Parallel Interface	280
5-5	Memory Card Operations	281
5-5-1	Creating Directories	282
5-5-2	Copying Files	284
5-5-3	Checking File Properties	285
5-5-4	Changing File Names	286
5-5-5	Deleting Files and Directories	287
5-5-6	Turning OFF the Power Supply to the Memory Card	288

5-1 Changing Scenes and Scene Groups

The different situations (types of measurement object and types of measurements required) in which measurements are performed are called "scenes" and the measurement conditions set in Set Mode are called "scene data." The scene function can be used to set 32 types of measurement conditions. If detection conditions change, simply switch scenes to change to a different measurement setup.

The normal limit of 32 scenes may not be possible for some settings if there is insufficient memory. A message will appear on the screen if there is insufficient memory. Make the region smaller or delete unnecessary regions or models.

CHECK

Up to 1,024 scenes can be stored if a 128-Mbyte Memory Card is inserted. Up to 32 scenes make up a scene group and up to 32 scene groups can be set, i.e., 32 scenes x 32 scene groups = 1,024.

Scene group 0 will be saved in the internal flash memory and scene groups 1 to 31 will be saved to the Memory Card.

If a Memory Card is not used, only Scene group 0 can be used.

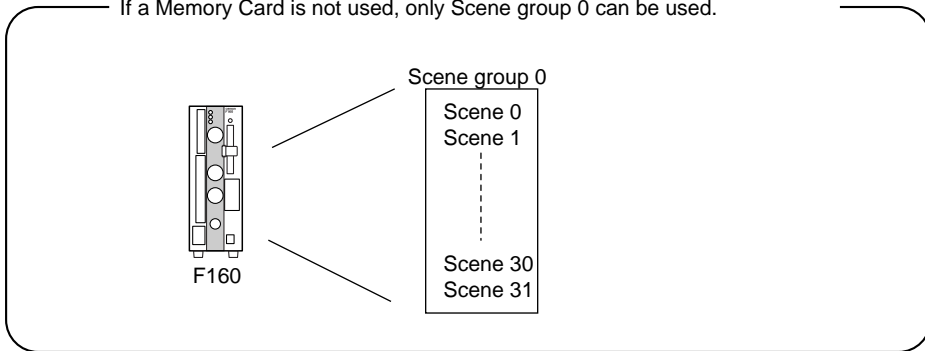

Scene groups 1 to 31 can be used if a Memory Card is mounted.

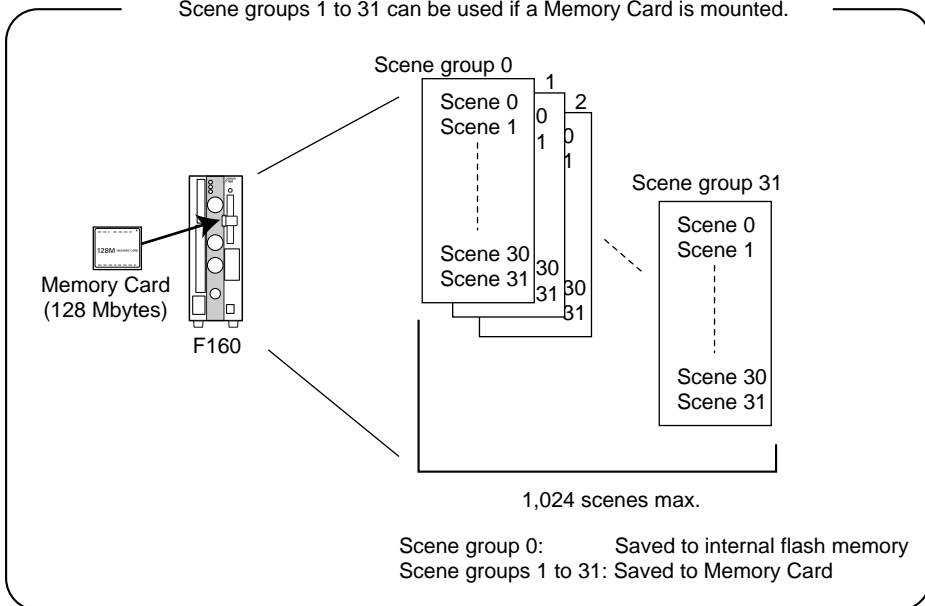

5-1-1 Setting Measurement Conditions for Different Models: Changing Scenes

Use the scene changing function to switch between different measurement conditions for different measurement setups or measurement objects. Scene 0 will be displayed by default when the power is turned ON, however, the F160 also accommodates scenes 1 to 31. If a Memory Card is inserted and the scene group function used, up to 1,024 scenes can be set.

The command for changing scenes or scene groups can be input from an external device via a parallel or serial interface.

1. Display the Basic Screen for Monitor Mode or Run Mode.

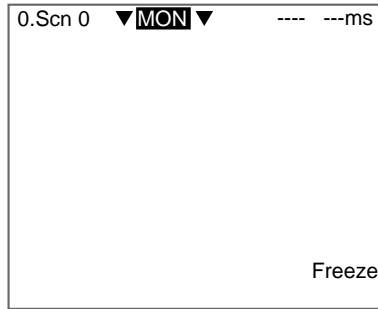

2. Move the cursor to **Scn** and press the **ENT** Key.

The Scn 0 to Scn 7 options will be displayed.

Use the **Down** Key to display scene numbers 8 to 31.

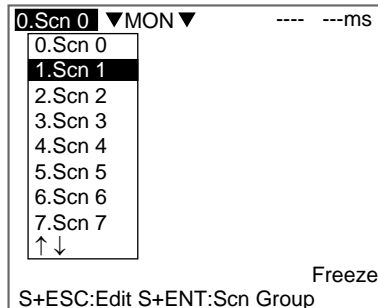

3. Move the cursor to the scene number to be switched to and press the **ENT** Key.

The selected scene will be displayed.

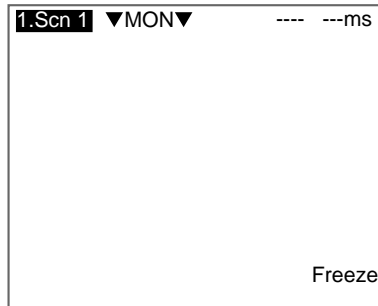

Using Scene Group Function

1. Insert a Memory Card.

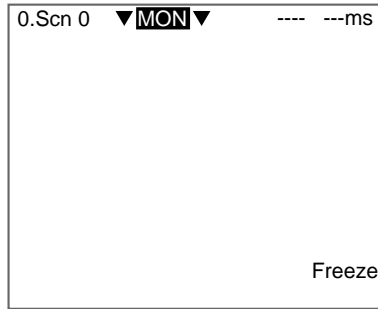

2. Display the Basic Screen for Monitor Mode or Run Mode.
3. Move the cursor to **Scn** and press the **ENT** Key.

The Scn 0 to Scn 7 options will be displayed.

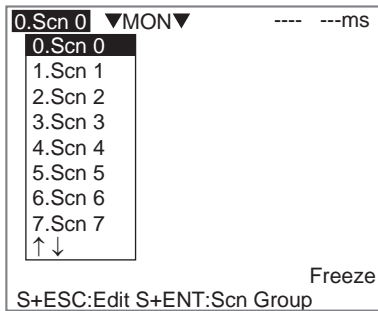

4. Press the **SHIFT+ENT** Keys.

The Scene Group 0 to Scene Group 7 options will be displayed. Use the **Down** Key to display scene group numbers 8 to 31.

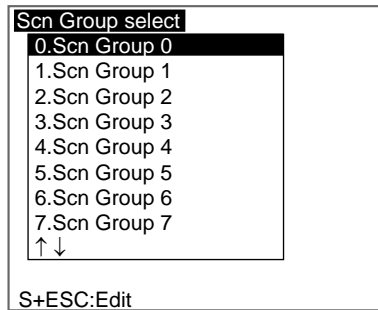

5. Move the cursor to the scene group number to be switched to and press the **ENT** Key.

The selected scene group will be displayed.

CHECK

When scene groups 1 to 31 are switched to, a directory called "DEFSCN-GR" will be automatically created in the root directory of the Memory Card. The scene group data will be saved in files called "SGR_00** .SGR." The asterisks (*) are the scene number.

5-1-2 Copying Scene Data

This function is useful for creating new scenes by copying scene data from another scene and changing some settings to suit the new requirements.

CHECK Scene data can be copied only within the same scene group. To copy data between scene groups, copy the whole scene group. Refer to page 265.

1. Move the cursor to **Scn** and press the **ENT** Key.

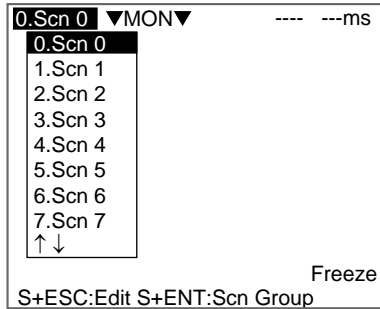

2. Move the cursor to the scene number to be copied.
3. Press the **SHIFT+ESC** Keys.

The Copy/Clear/Comment Menu will be displayed.

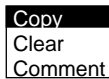

4. Select **Copy**.

The screen for copying will be displayed.

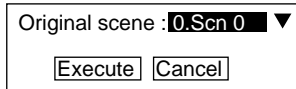

5. Enter the number of the scene to be copied (Original scene), and select **Execute**.

The data will be copied.

5-1-3 Initializing Measurement Conditions: Clearing Scenes

Use the following procedure to clear measurement conditions set in Set Mode, and to return scenes to their default settings. This section explains the procedure performed separately for each scene.

SeeAlso Refer to page 265 for information on initializing whole scene groups.

1. Move the cursor to **Scn** and press the **ENT** Key.

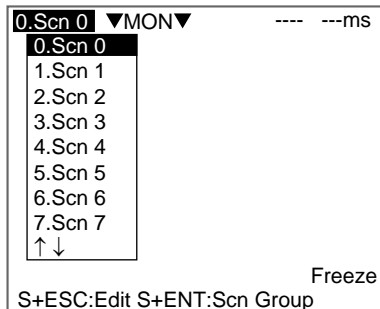

2. Move the cursor to the number of the scene to be cleared.
3. Press the **SHIFT+ESC** Keys.

The Copy/Clear/Comment Menu will be displayed.

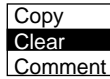

4. Select **Clear**.

A confirmation message will be displayed.

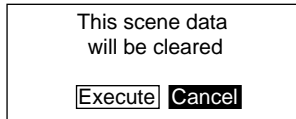

5. Select **Execute**.

The scene will be cleared.

5-1-4 Adding Comments to Scenes

Any comment can be added to each scene. This is useful for understanding settings when many regions have been registered.

1. Move the cursor to **Scn** and press the **ENT** Key.

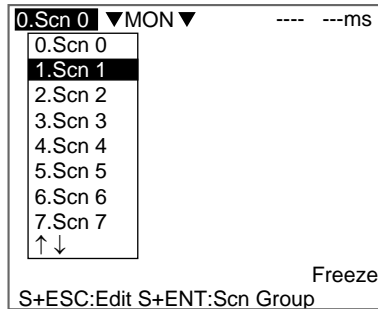

2. Move the cursor to the number of the scene for the name change.
3. Press the **SHIFT+ESC** Keys.

The Copy/Clear/Comment Menu will be displayed.



4. Select **Comment**.

A software keyboard will be displayed.

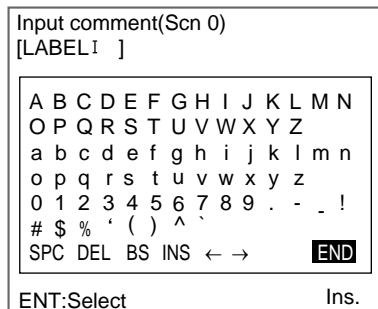

5. Set up to 8 characters.
6. Move the cursor to **END** and press the **ENT** Key.

The scene name will be changed.

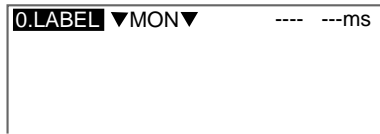

5-1-5 Using Scene Group Function

Use the scene group function to copy and clear whole scene groups and change the scene group name to any 11 standard characters.

1. Insert a Memory Card.

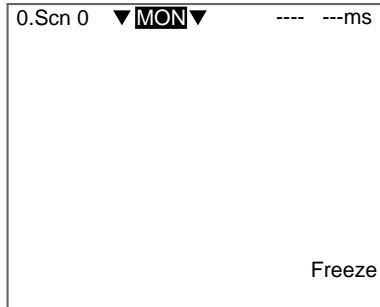

2. Display the Basic Screen for Monitor Mode or Run Mode.
3. Move the cursor to **Scn** and press the **ENT** Key.

The Scene 0 to Scene 7 options will be displayed.

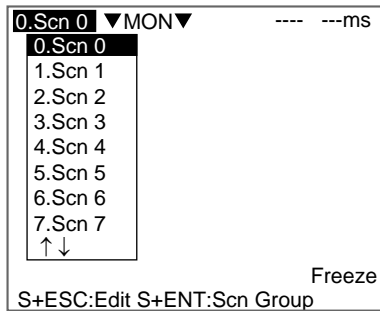

4. Press the **SHIFT+ENT** Keys.

The Scene Group 0 to Scene Group 7 options will be displayed.

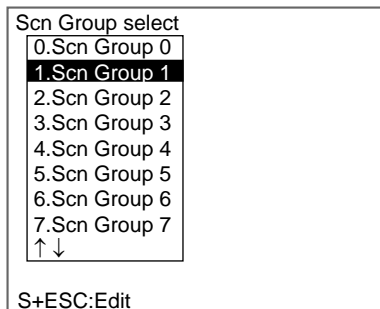

5. Move the cursor to the desired scene group number.
6. Press the **SHIFT + ENT** Keys.

The Copy/Clear/Comment Menu will be displayed.

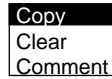

The rest of the operations are the same as when using the scene function.

5-2 Backing Up Data

This section explains how to make backup copies of data to flash memory or a computer.

When the power to the F160 is turned OFF, all data settings are cleared. The F160 loads data saved to flash memory at startup. Therefore, when settings are changed, in order not to lose these settings, be sure to save them to flash memory.

The 5 types of system and scene data listed below can be backed up on a computer or Memory Card. The same data can also be loaded from a computer to the F160. Saving and loading data enables using the same data on other F160 Controllers.

It is recommended that data is backed up in case data is lost or the F160 mal-functions.

Data	Contents
System data	Settings under <i>SYS</i> .
Scene group data	Scene data (scenes 0 to 31) for specified scene group.
Scene data	Settings under <i>SET</i> .
System data and scene group data	Both the system data and scene group data (for the scene group currently displayed) together.
Image data	Saved measurement images in BMP format. This is the basic image format for Windows and so the images can be displayed on a personal computer.

CHECK

Image data is saved as frame images. Even if *Field* is selected for the Camera mode, the images will be converted to frame images before being saved.

Precaution

Do not turn OFF the power or input a RESET signal while a message is being displayed in any save or load operation. Data in memory will be destroyed, and the F160 may not operate correctly the next time it is started.

5-2-1 Backing Up to a Personal Computer

This section describes data transfer procedures, using Hyper Terminal, a standard tool for Windows 98 and Windows NT4.0.

This example is based on the presumption that an RS-232C cable has been commented to the COM1 port on the personal computer. Make the necessary adjustments when the cable is connected to a different port. If using different communications software, refer to the relevant manual.

Data is transferred using XMODEM (-CRC or -SUM) or ZMODEM protocol. XMODEM (-1K) is not supported.

Saving Data to the Computer

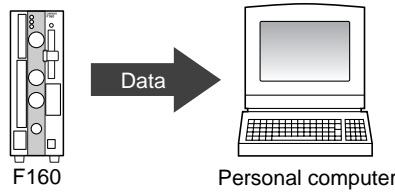

1. Connect the RS-232C cable to the COM1 port on the personal computer and the RS-232C/422 connector on the F160.
2. Make the F160 communications settings (serial).

The default communications settings are as shown in the following table. These settings can normally be used.

Item	Setting
Communications protocol	RS-232C
Baud rate	38,400 (bps)
Data length	8 (bits)
Parity bits	None
Stop bits	1 (bit)
Protocol	XMODEM (See note.)

Note Both XMODEM and ZMODEM transfer protocols are supported. Use the protocol that matches the computer settings.

3. Start the Hyper Terminal program on the computer and make the following communications settings. The same communications settings must be used on both the F160 and the modem on the computer.

Item	Setting
Baud rate	38,400 (bps)
Data length	8 (bits)
Parity bits	None
Stop bits	1 (bit)
Flow control	None (See note.)

Note XMODEM or ZMODEM protocol is used, so flow control is not performed.

4. Once the communications settings have been made on the computer, display the Basic Screen for Monitor Mode or Run Mode.

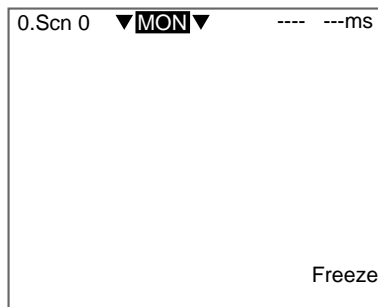

5. Move the cursor to **MON** (or **RUN**) and press the **ENT** Key.

The mode selections will be displayed.

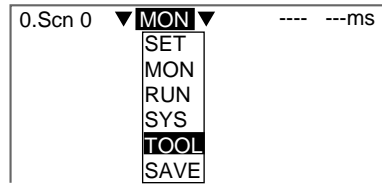

- 6. Select **TOOL**.

The data selections will be displayed.

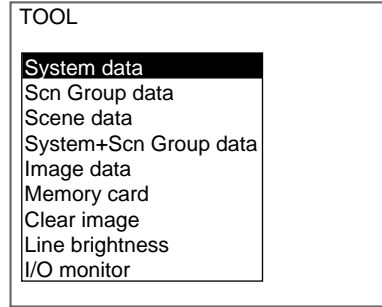

- 7. Select the data to be saved.

The destination selections for load and save will be displayed.

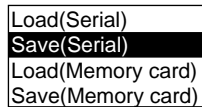

- 8. Select **Save (Serial)**.

- 9. Select the desired number for scene group, scene, or image data.

When using ZMODEM for communications, set a file name of 8 characters or less after inputting the desired number.

Scene group No.	Scene No.	Image data No.
Scn Group 0	Scn 0	Memory 0
Scn Group 1	Scn 1	Memory 1
Scn Group 2	Scn 2	Memory 2
Scn Group 3	Scn 3	Memory 3
Scn Group 4	Scn 4	Memory 4
Scn Group 5	Scn 5	Memory 5
Scn Group 6	Scn 6	Memory 6
Scn Group 7	Scn 7	Memory 7
↑ ↓	↑ ↓	↑ ↓
(0 to 31)	(0 to 31)	(0 to 35)

CHECK

When backing up system and scene group data, the currently displayed scene group will be saved.

A confirmation message will be displayed.

10. Select **Execute**.

Example:
Confirmation message when saving system data.

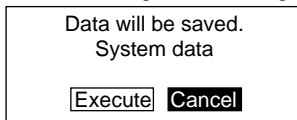

A screen showing the transfer progress will be displayed.

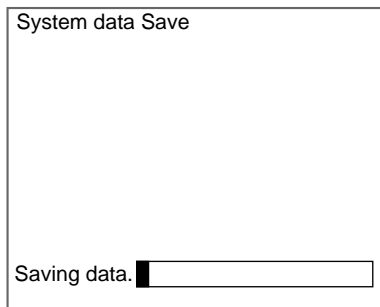

11. Select **Transfer/Receive File** from the Hyper Terminal menu on the computer.
12. Specify where the file is to be saved.
13. Set the protocol to **XMODEM** or **ZMODEM**.
14. Select **Receive**. When using XMODEM, input a file name.
The data will be transferred from the F160 to the computer.
When the transfer has been completed, the screen in (8.) will return.

Loading Data from the Computer

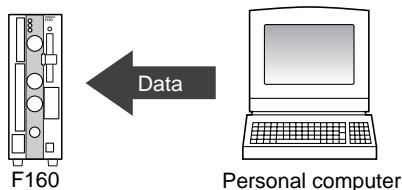

1. Follow steps 1 to 3 in the above procedure to connect the F160 and the computer.

SeeAlso

Refer to page 266.

2. Select **Transfer/Send File** from the Hyper Terminal menu.
3. Select the file to be sent.
4. Set the protocol to **XMODEM** or **ZMODEM**.
5. Select **Send**.
The data transfer screen will be displayed.

- 6. Once the preparations have been completed on the computer, display the Basic Screen for Monitor Mode or Run Mode.



- 7. Move the cursor to **MON** (or **RUN**) and press the **ENT** Key. The mode selections will be displayed.

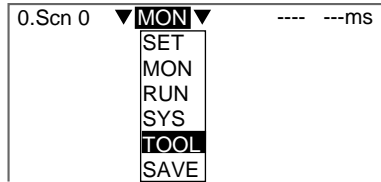

- 8. Select **TOOL**. The data selections will be displayed.

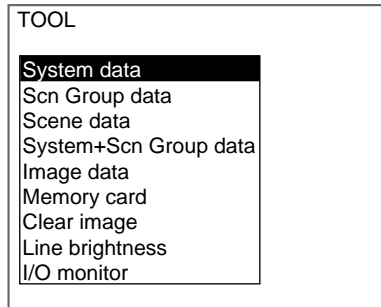

- 9. Select the data to be loaded. The destination selections for load and save will be displayed.

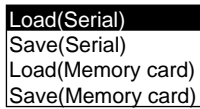

- 10. Select **Load (Serial)**.

11. Select the desired number for scene group, scene, or image data.

Scene group No.	Scene No.	Image data No.
Scn Group 0	Scn 0	Memory 0
Scn Group 1	Scn 1	Memory 1
Scn Group 2	Scn 2	Memory 2
Scn Group 3	Scn 3	Memory 3
Scn Group 4	Scn 4	Memory 4
Scn Group 5	Scn 5	Memory 5
Scn Group 6	Scn 6	Memory 6
Scn Group 7	Scn 7	Memory 7
↑↓	↑↓	↑↓
(0 to 31)	(0 to 31)	(0 to 35)

CHECK

When backing up system and scene group data, the currently displayed scene group will be loaded.

A confirmation message will be displayed.

Example:

Confirmation message when loading system data.

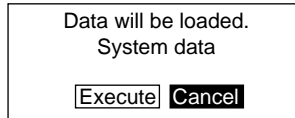

12. Select **Execute**.

The data will be transferred from the computer to the F160.

When loading has been completed, the screen in (1.) will return.

5-2-2 Backing Up to Memory Cards

This section describes inserting a Memory Card and backing up settings data to the Memory Card.

CHECK

Data can be backed up to Memory Cards inserted for screen group data.

Data for scene groups 1 to 31 will be saved in the files listed below. Do not overwrite these files.

```
[DEFSCNGR] ----- Directory for saving scene group data
├── SGR_0001.SGR -- Scene group 1 file
├── SGR_0002.SGR -- Scene group 2 file
│   │
│   │
│   │
└── SGR_0031.SGR -- Scene group 31 file
```

Precaution

Turn OFF the power supply to the Memory Card before removing the Memory Card. Refer to page 288.

Saving from the F160 to the Memory Card

1. Insert the Memory Card.

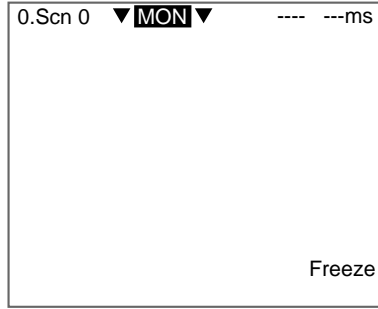

2. Display the Basic Screen for Monitor Mode or Run Mode.
3. Move the cursor to **MON** (or **RUN**) and press the **ENT** Key.

The mode selections will be displayed.

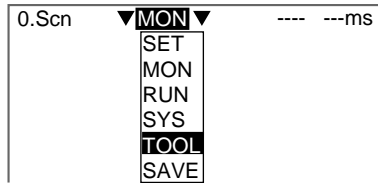

4. Select **TOOL**.

The data selections will be displayed.

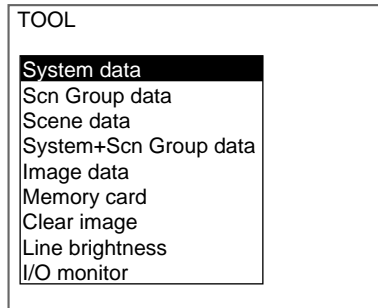

5. Select the data to be saved.

The destination selections for load and save will be displayed.

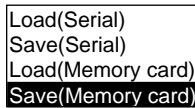

6. Select **Save (Memory card)**.

- Select the desired number for scene group, scene, or image data.

Scene group No.	Scene No.	Image data No.
Scn Group 0	Scn 0	Memory 0
Scn Group 1	Scn 1	Memory 1
Scn Group 2	Scn 2	Memory 2
Scn Group 3	Scn 3	Memory 3
Scn Group 4	Scn 4	Memory 4
Scn Group 5	Scn 5	Memory 5
Scn Group 6	Scn 6	Memory 6
Scn Group 7	Scn 7	Memory 7
↑ ↓	↑ ↓	↑ ↓
(0 to 31)	(0 to 31)	(0 to 35)

CHECK

When backing up system and scene group data, the currently displayed scene group will be saved.

A list of files in the Memory Card root directory will be displayed.

System data Save		
/C0		
[.]	00/11/01
SYSDAT1	SYD	00/11/01
SYSDAT2	SYD	00/11/01
SYSDAT3	SYD	00/11/01

CHECK

To overwrite existing files, select the file by pressing the ENT Key and then go to step 12.

To specify a new file name, perform steps 8 to 11.

- Press the **SHIFT+ESC** Keys.

The edit menu will be displayed.

Property
Make directory
New file
Change name
Delete

- Select **New file**.

CHECK

If *Make directory* is selected, the screen for creating new directories will be displayed. Files can be saved in the newly created directory.

The software keyboard will be displayed.

New file(System data)																																																																																																			
[SYSDAT4I].SYD																																																																																																			
<table border="1"> <tbody> <tr> <td>A</td><td>B</td><td>C</td><td>D</td><td>E</td><td>F</td><td>G</td><td>H</td><td>I</td><td>J</td><td>K</td><td>L</td><td>M</td><td>N</td> </tr> <tr> <td>O</td><td>P</td><td>Q</td><td>R</td><td>S</td><td>T</td><td>U</td><td>V</td><td>W</td><td>X</td><td>Y</td><td>Z</td><td></td><td></td> </tr> <tr> <td>a</td><td>b</td><td>c</td><td>d</td><td>e</td><td>f</td><td>g</td><td>h</td><td>i</td><td>j</td><td>k</td><td>l</td><td>m</td><td>n</td> </tr> <tr> <td>o</td><td>p</td><td>q</td><td>r</td><td>s</td><td>t</td><td>u</td><td>v</td><td>w</td><td>x</td><td>y</td><td>z</td><td></td><td></td> </tr> <tr> <td>0</td><td>1</td><td>2</td><td>3</td><td>4</td><td>5</td><td>6</td><td>7</td><td>8</td><td>9</td><td>.</td><td>-</td><td>_</td><td>!</td> </tr> <tr> <td>#</td><td>\$</td><td>%</td><td>'</td><td>(</td><td>)</td><td>^</td><td>`</td><td></td><td></td><td></td><td></td><td></td><td></td> </tr> <tr> <td>SPC</td><td>DEL</td><td>BS</td><td>INS</td><td>←</td><td>→</td><td></td><td></td><td></td><td></td><td></td><td></td><td></td><td>END</td> </tr> </tbody> </table>		A	B	C	D	E	F	G	H	I	J	K	L	M	N	O	P	Q	R	S	T	U	V	W	X	Y	Z			a	b	c	d	e	f	g	h	i	j	k	l	m	n	o	p	q	r	s	t	u	v	w	x	y	z			0	1	2	3	4	5	6	7	8	9	.	-	_	!	#	\$	%	'	()	^	`							SPC	DEL	BS	INS	←	→								END
A	B	C	D	E	F	G	H	I	J	K	L	M	N																																																																																						
O	P	Q	R	S	T	U	V	W	X	Y	Z																																																																																								
a	b	c	d	e	f	g	h	i	j	k	l	m	n																																																																																						
o	p	q	r	s	t	u	v	w	x	y	z																																																																																								
0	1	2	3	4	5	6	7	8	9	.	-	_	!																																																																																						
#	\$	%	'	()	^	`																																																																																												
SPC	DEL	BS	INS	←	→								END																																																																																						
ENT>Select	Ins.																																																																																																		

SeeAlso

Refer to page 31 for details on inputting characters.

- Set the file name with up to 8 characters.

CHECK

Periods (.) cannot be used in file names.

11. Move the cursor to **END** and press the **ENT** Key.

A confirmation message will be displayed.

Example:

Confirmation message when saving system data.

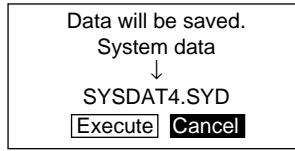

12. Select **Execute**.

When saving has been completed, the screen in (6.) will return.

Loading from the Memory Card to the F160

1. Follow steps 1 to 5 for *Saving from the F160 to the Memory Card* and move to the screen for selecting load destinations.

SeeAlso

Refer to page 271.

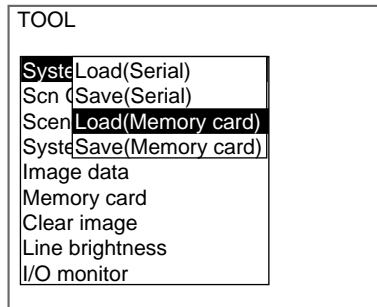

2. Select **Load (Memory card)**.
3. Select the desired number for scene group, scene, or image data.

Scene group No.	Scene No.	Image data No.
Scn Group 0	Scn 0	Memory 0
Scn Group 1	Scn 1	Memory 1
Scn Group 2	Scn 2	Memory 2
Scn Group 3	Scn 3	Memory 3
Scn Group 4	Scn 4	Memory 4
Scn Group 5	Scn 5	Memory 5
Scn Group 6	Scn 6	Memory 6
Scn Group 7	Scn 7	Memory 7
↑ ↓	↑ ↓	↑ ↓
(0 to 31)	(0 to 31)	(0 to 35)

CHECK

When backing up system and scene group data, the currently displayed scene group will be loaded.

The screen for selecting files will be displayed.

Example:

Screen for loading system data

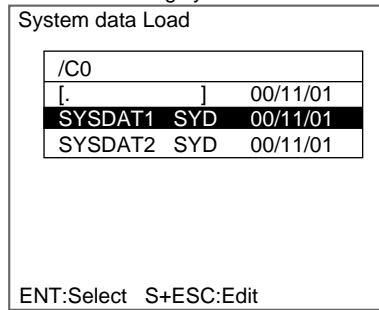

4. Select the file to be loaded.

A confirmation message will be displayed.

Example:

Screen when loading system data

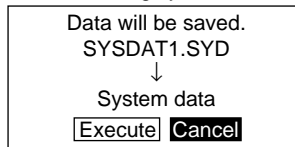

5. Select **Execute**.

When the loading has been completed, the screen in (1.) will return.

5-2-3 Backing Up to Flash Memory

The scene data set to scene group 0 and system data will be saved to the F160 internal flash memory. If this save operation is performed for scene groups 1 to 31, the data will overwrite the contents of the files on the Memory Card.

Precaution

Flash memory and Memory Card data is loaded each time the F160 is started up. Therefore, when settings have been changed, be sure to save to flash memory before turning the power OFF. If the power is turned OFF without saving, all of the setting changes will be lost.

1. Display the Basic Screen for Monitor Mode or Run Mode.

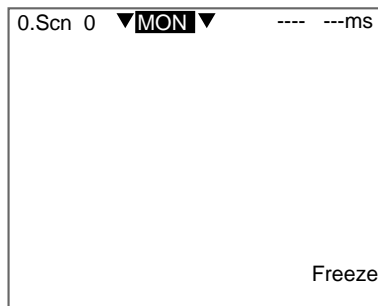

2. Move the cursor to **MON** or **RUN** and press the **ENT** Key.

A list of mode selections will be displayed.

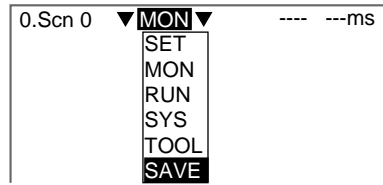

3. Select **SAVE**.

A confirmation message will be displayed.

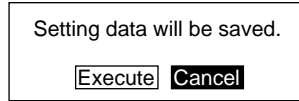

4. Select **Execute**.

Precaution

Do not turn OFF the power or input a RESET signal while a message is being displayed in any save or load operation. Data in memory will be destroyed, and the F160 may not operate correctly the next time it is started. When saving has been completed, the screen for step 1 will return.

5-3 Checking Image Density Distribution: Line Brightness

The graph showing the density distribution for 1 line in an image is called the line brightness graph. The line brightness can be shown for any line in a horizontal or vertical direction.

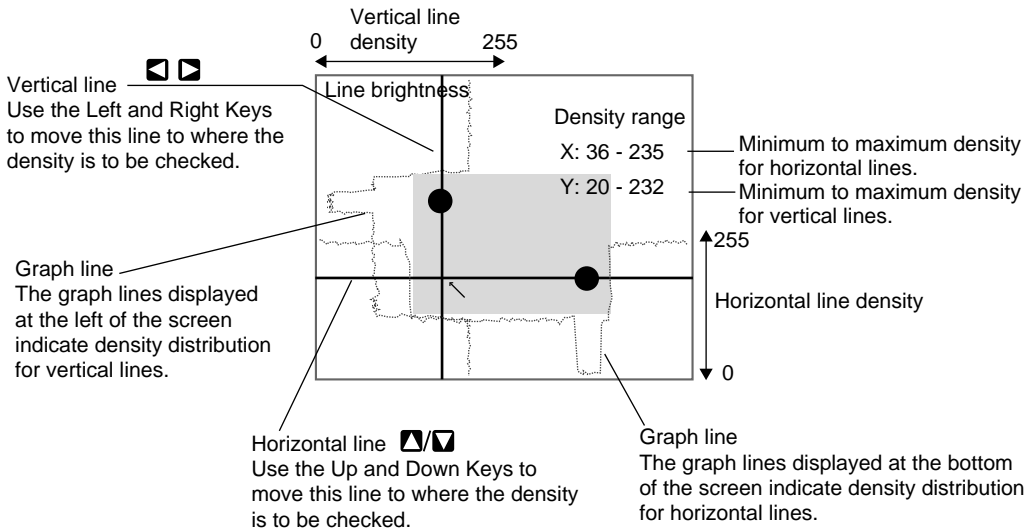

CHECK The line brightness cannot be displayed when *Display image* is set to *Last NG*, *Reduction freeze*, *Reduction through*, or *Reduction last NG*. Select *Freeze* or *Through* for image display. Refer to page 298.

CHECK Using Line Brightness

- Use to check if the light distribution is uneven.

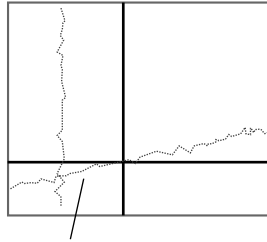

If a homogeneous color is being displayed but the graph has an incline, it indicates that the lighting is uneven.

- Use to find how great the density difference is between the location to be measured and the background.

Example: Defect detection

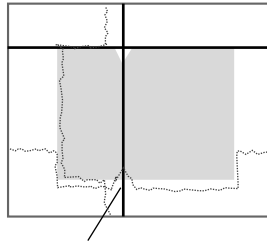

Observe the bumps in the graph line to determine how much difference in density can be detected in what areas.

1. Display the Basic Screen for Monitor Mode or Run Mode.

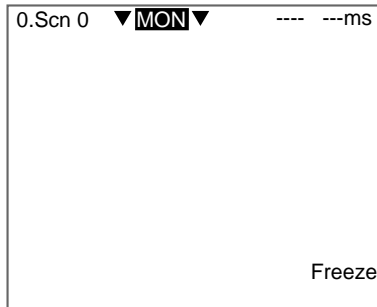

2. Move the cursor to **MON** (or **RUN**) and press the **ENT** Key. The mode selections will be displayed.

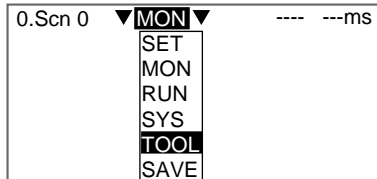

3. Select **TOOL**.

The tool selections will be displayed.

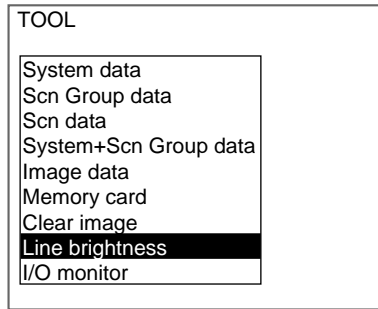

4. Select **Line brightness**.

The Line Brightness screen will be displayed.

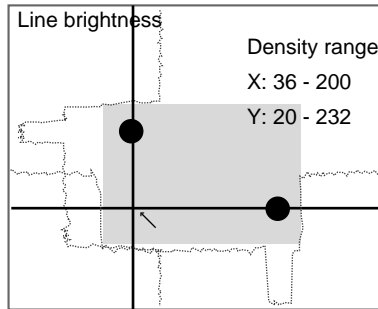

5. Move the solid line to the desired position for observing density distribution.
Use the **Up/Down** Keys to move the horizontal line.
Use the **Right/Left** Keys to move the vertical line.
6. Press the **ESC** Key to exit this screen.
The screen in (4.) will return.

5-4 Checking I/O Status with External Devices

Use the I/O monitor function to check the communications status via serial or parallel interfaces. Wiring and communications settings can be checked.

5-4-1 Serial Interface

The communications status via the serial interface can be checked.

1. Display the Basic Screen for Monitor Mode or Run Mode.

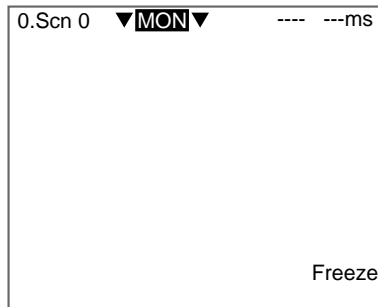

2. Move the cursor to **MON** (or **RUN**) and press the **ENT** Key.

The mode selections will be displayed.

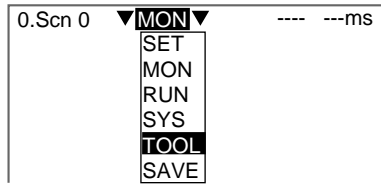

3. Select **TOOL**.

The tool selections will be displayed.

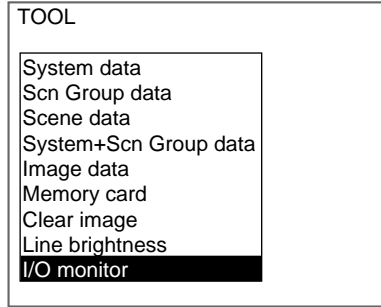

4. Select **I/O monitor**.

The interface selections will be displayed.



5. Select **Serial**.

The Serial I/O Monitor Screen will be displayed.

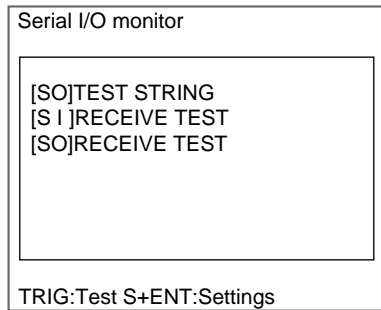

CHECK

Display Details

Display	Meaning
SO	Output to external device. Press the TRIG Key once to send a test character string "TEST STRING" from the F160 to the external device. The contents of the test character string can be changed. Refer to page 280.
SI	Input from external device. If more than 26 characters are received, only the first 26 characters will be displayed. If <i>Echo back</i> is set to ON, the received data will be returned as is to the external device. Refer to page 280.

6. Press the **ESC** Key to exit this screen.

The screen in (5.) will return.

Changing Test Character String and Echo Back

1. Display the Serial I/O Monitor Screen and press the **SHIFT+ENT** Keys.
The screen for making detailed settings will be displayed.

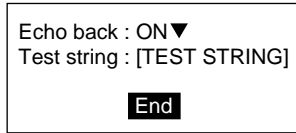

2. Select **ON** or **OFF** for **Echo back**.
3. Move the cursor to the square brackets [] and press the **ENT** Key.
The software keyboard will be displayed.

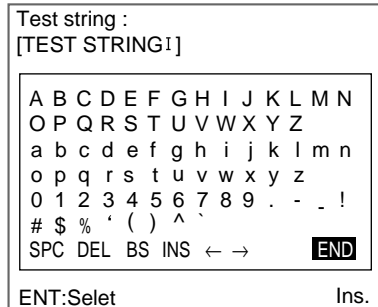

SeeAlso Refer to page 31 for details on inputting characters.

4. Change the test string. Up to 12 characters can be inserted.
5. Select **END** and the screen in (2.) will return.
6. Move the cursor to **End** and press the **ENT** Key.
The Serial I/O Monitor Screen will return.

5-4-2 Parallel Interface

The communications status via the parallel interface can be checked.

1. Display the Basic Screen for Monitor Mode or Run Mode.

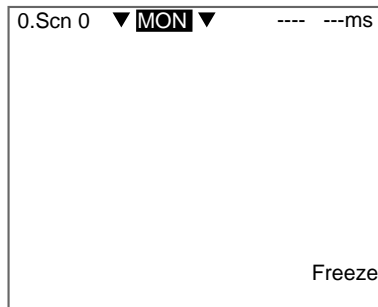

2. Move the cursor to **MON** (or **RUN**) and press the **ENT** Key.
The mode selections will be displayed.

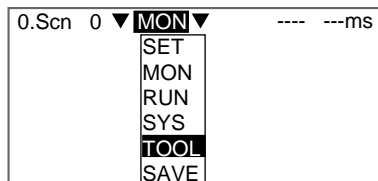

3. Select **TOOL**.

The tool selections will be displayed.

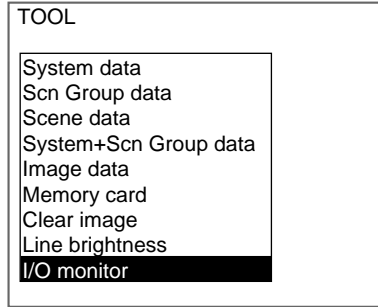

4. Select **I/O monitor**.

The interface selections will be displayed.



5. Select **Parallel**.

The Parallel I/O Monitor Screen will be displayed.

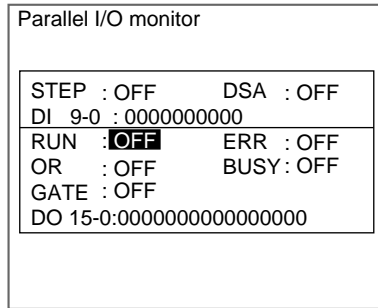

CHECK

Display Details

Display	Meaning
STEP	Displays the input status for each signal from the external device to the F160.
DSA	
DI	
RUN	Displays the output status for each signal from the F160 to the external device.
ERR	
OR	These displays can be changed to ON/OFF or 0/1 even if measurements are not executed.
BUSY	
GATE	Move the cursor to the display item. The display will change each time the ENT Key is pressed.
DO	

6. Press the **ESC** Key to exit this screen.

The screen in (5.) will return.

5-5 Memory Card Operations

Data settings and measurement images can be saved from the F160 to a Memory Card. The files on the Memory Card can be copied and the file names changed. This section explains these operations for Memory Cards.

Precaution Turn OFF the power supply to the Memory Card before removing the Memory Card. If the power is not turned OFF before the Memory Card is removed, the Memory Card and the F160 may be damaged. Refer to page 288.

5-5-1 Creating Directories

Directories can be created in the Memory Card and files can be stored in those directories. It is easier to find files if separate directories are created for related files.

1. Insert the Memory Card.
2. Display the Basic Screen for Monitor Mode or Run Mode.

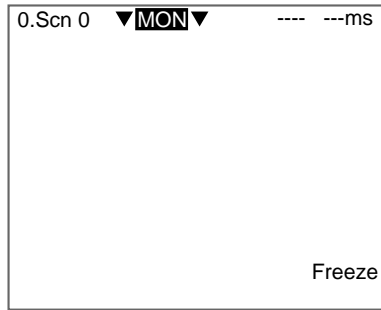

3. Move the cursor to **MON** (or **RUN**) and press the **ENT** Key. The mode selections will be displayed.

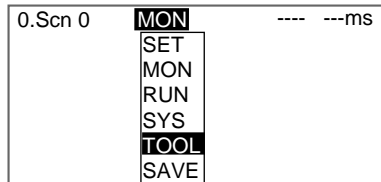

4. Select **TOOL**. The tool selections will be displayed.

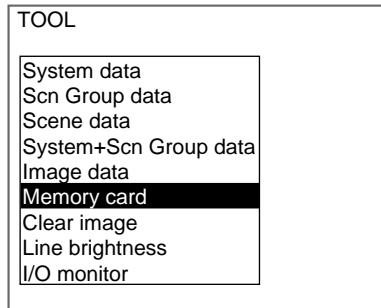

5. Select **Memory card**. The Copy file/File operation/Drive status Menu will be displayed.

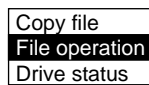

6. Select **File operation**.

A list of files in the Memory Card root directory will be displayed.

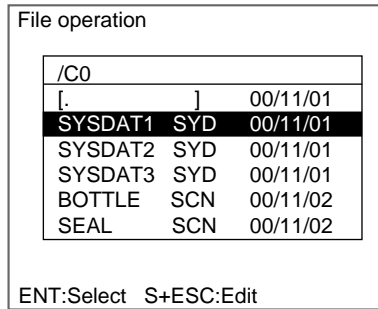

7. Press the **SHIFT+ESC** Keys.
The edit menu will be displayed.

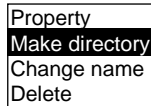

8. Select **Make directory**.
A software keyboard will be displayed.

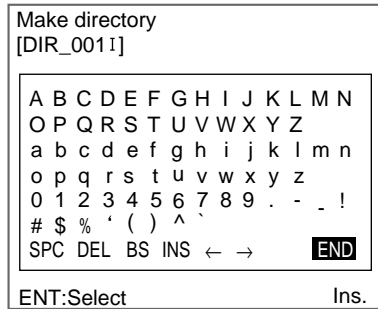

SeeAlso Refer to page 31 for details on inputting characters.

9. Input the directory name, using up to 8 characters.

CHECK Periods (.) cannot be used in file names.

10. Move the cursor to **END** and press the **ENT** Key.
A confirmation message will be displayed.

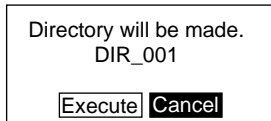

11. Select **Execute**.
The directory will be created and the screen in (7.) will return.

CHECK

The directory is displayed in the list of files, encased in square brackets []. Move the cursor to the directory and press the **ENT** Key to display a list of files in that directory.

Example

When directory [DIC_1] is selected.

The files in [DIC_1] will be displayed.

/C0		
[.]	[]	00/11/01
[DIC_1]	[]	00/11/01
SYSDAT1	SYD	00/11/01
SYSDAT2	SYD	00/11/01
SYSDAT3	SYD	00/11/01
SEAL	SCN	00/11/02



/C0/DIC_1		
[.]	[]	00/11/01
[.]	[]	00/11/01
MARK-B	SCN	00/11/01
MARK-C	SCN	00/11/01
MARK-D	SCN	00/11/02

Select [.] to move up a level.

5-5-2 Copying Files

1. Perform steps 1 to 5 for *Creating Directories* and display the Copy file/File operation/Drive status Menu.

SeeAlso

Refer to page 282.

2. Select **Copy file**.

Copy file
File operation
Drive status

A list of files in the Memory Card root directory will be displayed.

Original		
/C0		
[.]	[]	00/11/01
SYSDAT1	SYD	00/11/01
SYSDAT2	SYD	00/11/01
SYSDAT3	SYD	00/11/01
BOTTLE	SCN	00/11/02
SEAL	SCN	00/11/02
ENT:Select S+ESC>Edit		

3. Move the cursor to the file to be copied and press the **ENT** Key. A screen for specifying the copy destination will be displayed.

Copy (Original: SYSDAT1.SYD)		
/C0		
[.]	[]	00/11/01
SYSDAT1	SYD	00/11/01
SYSDAT2	SYD	00/11/01

CHECK

To overwrite existing files, select the file by pressing the **ENT** Key and then go to step 8.

To specify a new file name, perform steps 4 to 8.

4. Press the **SHIFT+ESC** Keys.

The edit menu will be displayed.

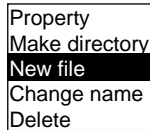

- 5. Select **New file**.

CHECK

If *Make directory* is selected, the screen for creating new directories will be displayed. Files can be saved in the newly created directory.

The software keyboard will be displayed.

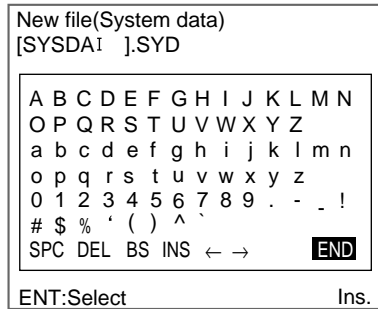

SeeAlso

Refer to page 31 for details on inputting characters.

- 6. Set the file name with up to 8 characters.

CHECK

Periods (.) cannot be used in file names.

- 7. Move the cursor to **END** and press the **ENT** Key.

A confirmation message will be displayed.

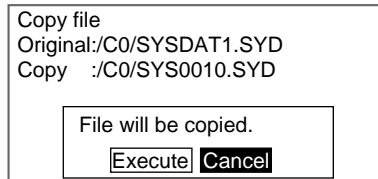

- 8. Select **Execute**.

The file will be copied and the screen in (2.) will return.

5-5-3 Checking File Properties

The size, type, or date a file was created can be checked.

- 1. Perform steps 1 to 6 for *Creating Directories* and display the list of file names.

SeeAlso

Refer to page 282.

2. Move the cursor to the file for which the information is to be checked and press the **SHIFT + ENT** Keys.

File operation		
/C0		
[.]		00/11/01
SYSDAT1	SYD	00/11/01
SYSDAT2	SYD	00/11/01
SYSDAT3	SYD	00/11/01
BOTTLE	SCN	00/11/02
SEAL	SCN	00/11/02

ENT:Select S+ESC>Edit

The edit menu will be displayed.

Property
Make directory
Change name
Delete

3. Select **Property**.

The properties of the selected file will be displayed.

File name	:SYSDAT1.SYD
Type	:System data
Path	:/C0
Size	: 2KB
Creation	:00/11/01 12:30:24
End	

4. Select **End**.

The screen in (2.) will return.

5-5-4 Changing File Names

CHECK Only the file name can be changed. The directory name cannot be changed.

1. Perform steps 1 to 6 for *Creating Directories* and display the list of file names.

SeeAlso Refer to page 282.

2. Move the cursor to the file for which the name is to be changed and press the **SHIFT + ESC** Keys.

File operation		
/C0		
[.]		00/11/01
SYSDAT1	SYD	00/11/01
SYSDAT2	SYD	00/11/01
SYSDAT3	SYD	00/11/01
BOTTLE	SCN	00/11/02
SEAL	SCN	00/11/02

ENT:Select S+ESC>Edit

The edit menu will be displayed.

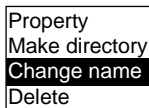

3. Select **Change name**.

A software keyboard will be displayed.

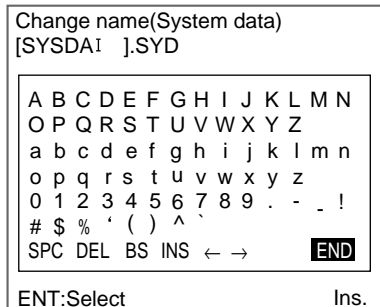

SeeAlso

Refer to page 31 for details on inputting characters.

4. Set the file name with up to 8 characters.

CHECK

Periods (.) cannot be used in file names.

5. Move the cursor to **END** and press the **ENT** Key.

A confirmation message will be displayed.

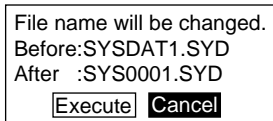

6. Select **Execute**.

The file name will be changed and the screen in (2.) will return.

CHECK

When the scene group function is used, scene groups 1 to 31 are saved in the root directory of the Memory Card under the file names shown below.

Do not change these file names. If these file names are changed, measurement setups will no longer be able to be changed by switching scene groups.

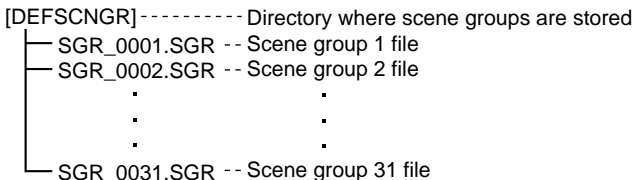

5-5-5 Deleting Files and Directories

1. Perform steps 1 to 6 for *Creating Directories* and display the list of file names.

SeeAlso

Refer to page 282.

2. Move the cursor to the file or directory to be deleted and press the **SHIFT + ESC** Keys.

File operation		
/C0		
[.]	00/11/01
SYSDAT1	SYD	00/11/01
SYSDAT2	SYD	00/11/01
SYSDAT3	SYD	00/11/01
BOTTLE	SCN	00/11/02
SEAL	SCN	00/11/02

ENT:Select S+ESC>Edit

CHECK

A directory can be deleted only when there are no files in that directory. The edit menu will be displayed.

Property
Make directory
Change name
Delete

3. Select **Delete**.
A confirmation message will be displayed.

SYSDAT1.SYD will be deleted.
<input type="button" value="Execute"/> <input type="button" value="Cancel"/>

4. Select **Execute**.
The file or directory will be deleted and the screen in (2.) will return.

5-5-6 Turning OFF the Power Supply to the Memory Card

Turn OFF the power supply to the Memory Card before removing the Memory Card. If the power is not turned OFF before the Memory Card is removed, the Memory Card and the F160 may be damaged.

CHECK

The total space and free space on the Memory Card will be displayed on this screen.

1. Perform steps 1 to 5 for *Creating Directories* and display the Copy file/File operation/Drive status Menu.

SeeAlso

Refer to page 282.

Copy file
File operation
Drive status

2. Select **Drive status**.

The Drive Status Screen will be displayed.

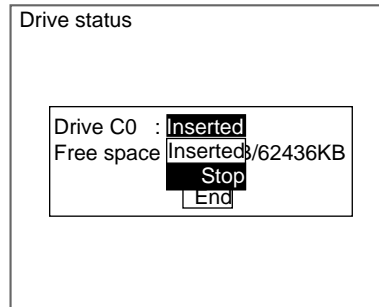

3. If a Memory Card is inserted, "Inserted" will be highlighted. Change the display to **Stop**.

CHECK

If a Memory Card is not inserted, the display will be "Not inserted."

4. Select **End**.

A confirmation message will be displayed.

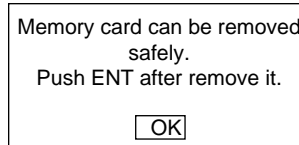

5. Remove the Memory Card and press the **ENT** Key.
The screen in (2.) will return.

SECTION 6 System Settings

This section describes how to set conditions related to the system environment. Refer to the *Communications Reference Manual* for information on communications specifications.

6-1	Entering System Mode	292
6-2	Camera Settings	293
6-3	Measurement Result Output Destinations	294
6-3-1	Selecting Serial Interface as the Output Destination	295
6-3-2	Selecting the Memory Card as the Output Destination	296
6-4	Screen Display and Monitor	298
6-4-1	Measurement Screen Settings	298
6-4-2	Selecting Color or Monochrome Monitors	305
6-4-3	Changing Character or Figure Colors	306
6-4-4	Creating Original Colors	307
6-5	Customizing Operations	309
6-5-1	Changing Console Key Allocations	309
6-5-2	Capturing and Saving Images	312
6-5-3	Masking Display of Setting Items	314
6-5-4	Masking Display of Processing Items	315
6-5-5	Shortening Scene Group Switching Time	315
6-5-6	Setting Passwords	316
6-6	Setting Conditions for Saving Measurement Images	318
6-6-1	Displaying Stored Images	319
6-6-2	Clearing All Stored Images	321
6-7	Using BUSY Signals	322
6-8	Selecting Items to be Shown in Overall Judgements	323
6-9	Setting Startup Conditions	324
6-10	Setting the Calendar Date and Time (Date/Time)	325
6-11	Checking System Information	325
6-11-1	Checking Remaining Memory Space and Battery Status	325
6-11-2	Checking the Software Version	326
6-12	Changing to Conversational Menus	327

6-1 Entering System Mode

To set conditions related to the system environment it is necessary to enter System Mode.

1. Display the Basic Screen for Monitor Mode or Run Mode.

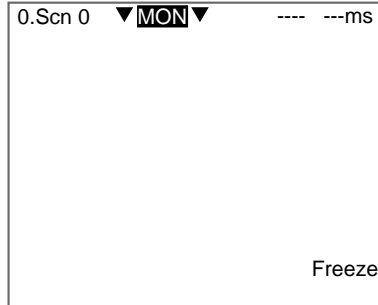

2. Move the cursor to **MON** and press the **ENT** Key.

The mode selections will be displayed.

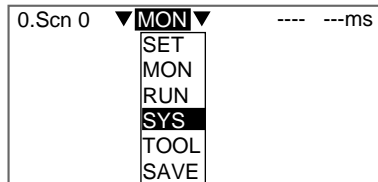

3. Select **SYS**.

The System Settings Screen will be displayed.

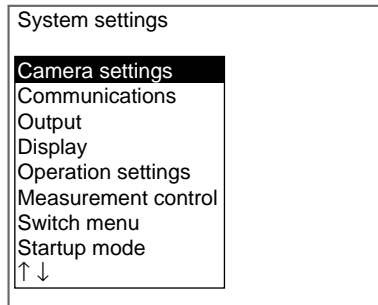

6-2 Camera Settings

Specify the model of the connected Camera and Intelligent Lighting (if using any). The model is written on each Unit.

Menu item	Models	Details
Camera	F150-S1A F160-S1* F160-S2 Other	Select the model of the connected Camera.
Intelligent Lighting 0 Intelligent Lighting 1	Out of use* LTC20 LTC50	If a Camera with Intelligent Lighting is connected, select the model of the Intelligent Lighting. Always set the DIP switch on the Intelligent Lighting to 0, regardless of the Camera number. Refer to <i>Setup Manual</i> .

Note The default setting is marked with an asterisk.

1. Enter System mode and select **Camera settings**.

SeeAlso

Refer to page 292.

The Camera Settings Screen will be displayed.

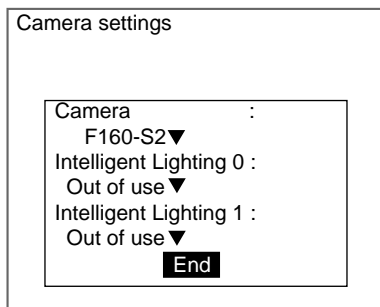

2. Select the model of the connected Camera.
3. If using Intelligent Lighting, select the model.
4. Select **End**.

The settings will be registered and the System Settings Screen will return.

CHECK

If *Other* is selected under *Camera*, the Camera Settings (Detail) Screen will be displayed.

The settings for F200/F300 Cameras are listed in the *Setup Manual*.

SeeAlso

Refer to *Setup Manual*.

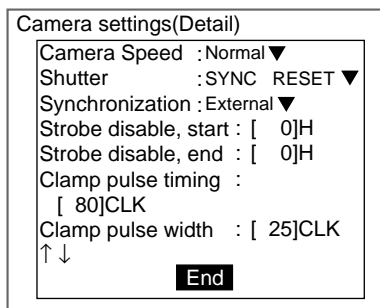

Precaution

When changing the Camera model, save settings data in flash memory. Set the measurement conditions after starting the F160 again.

6-3 Measurement Result Output Destinations

The F150 can output judgements and data for measured objects to an external device. Use the following procedure to make destination settings for judgment output and data output.

Output item	Output destination
Data	Serial interface*
	Parallel interface
	Memory Card
	Serial interface + Memory Card
	Parallel interface + Memory Card
Judgement	Parallel interface (fixed)

Note *The default setting is marked with an asterisk.

HELP

Judgements

The calculation results of the expression set under *Expression/Judge* is judged based on the judgement conditions. A judgement of OK or NG is output.

HELP

Data

Data is the calculations result of the expression set under *Expression/Data*. Numerical values such as area and position coordinates are output.

1. Enter System mode and select **Output**.

SeeAlso

Refer to page 292.

The Output Device/Serial/Memory Card Menu will be displayed.

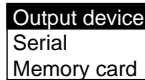

2. Select **Output device**.

The Output (Output Device) Settings Screen will be displayed.

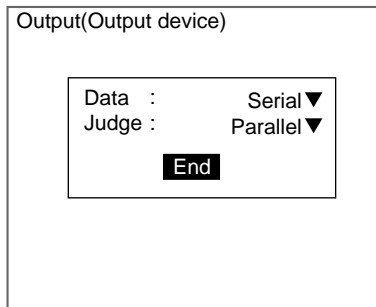

3. Select the output destinations.
4. Select **End**.

The settings will be registered and the screen in (2.) will return.

6-3-1 Selecting Serial Interface as the Output Destination

Select the format for the outputting data via the serial interface.

ASCII Format

The following items can be set.

Item	Details
Output form	Select <i>ASCII</i> *.
Digits of integer	Set the number of digits for integer output. When 0 is selected, all digits of data are output without leading zeros. Select a value between 0 and 8*. If the data has more digits than the number set, 9 will be output for each digit. Example: If 4 digits have been set and the data is "15619," the output will be "9999."
Digits of decimal	Set the number of digits for decimal output. When 0 is selected, the decimal places are rounded off. Select a value between 0 and 3*.
Minus	Select what sign will be displayed for negative values. Select either - * or 8.
Field separator	Select the separator between data. Select none, comma*, tab, space, or delimiter.
Record separator	Select the separator between data. Select none, comma, tab, space, or delimiter*.
0 Suppress	Select how to adjust any empty digits to the left of output data. Select either 0 or space: 0: Inserts a 0 into empty digits. Space: Inserts a space into empty digits. Example: If "4" been set for <i>Digits of integer</i> and "3" for <i>Digits of decimal</i> , and the data is 100.000, the following output will be made. When 0 is set: 00100.000 When Space is set: (space)100.000 (i.e., a space is inserted.)

Note *The default settings are marked with an asterisk.

Binary Format

The measurement result multiplied by 1,000 is output as 4 consecutive digits.

Item	Details
Output form	Select <i>Binary</i> .
Digits of integer	These settings are only for ASCII format. No settings are required for binary format.
Digits of decimal	
Minus	
Field separator	
Record separator	
0 Suppress	

1. Enter System mode and select **Output**.

SeeAlso

Refer to page 292.

The Output Device/Serial/Memory Card Menu will be displayed.

Output device
Serial
Memory card

2. Select **Serial**.

The Output (Serial) Settings Screen will be displayed.

Output(Serial)

Output form	: ASCII	▼
Digits of integer	: [8]	
Digits of decimal	: [3]	
Minus	:	▼
Field separator	: Comma	▼
Record separator	: Delimiter	▼
0 Suppress	: OFF	▼

End

SeeAlso

Refer to page 29 for details on inputting values.

3. Change the settings for each item.
4. Select **End**.

The settings will be registered and the screen in (2.) will return.

6-3-2 Selecting the Memory Card as the Output Destination

Select the format for outputting data to the Memory Card.

ASCII Format

The following items can be set.

Item	Details
Output form	Select <i>ASCII</i> *.
Digits of integer	Set the number of digits for integer output. When 0 is selected, all digits of data are output without leading zeros. Select a value between 0 and 8*. If the data has more digits than the number set, 9 will be output for each digit. Example: If 4 digits have been set and the data is "15619," the output will be "9999."
Digits of decimal	Set the number of digits for decimal output. When 0 is selected, the decimal places are rounded off. Select a value between 0 and 3*.
Minus	Select what sign will be displayed for negative values. Select either - * or 8.
Field separator	Select the separator between data. Select none, comma*, tab, space, or CR+LF.
Record separator	Select the separator between data. Select none, comma, tab, space, or CR+LF*.
0 Suppress	Select how to adjust any empty digits to the left of output data. Select either 0 or space: 0: Inserts a 0 into empty digits. Space: Inserts a space into empty digits. Example: If "4" been set for <i>Digits of integer</i> and "3" for <i>Digits of decimal</i> , and the data is 100.000, the following output will be made. When 0 is set: 00100.000 When Space is set: (space)100.000 (i.e., a space is inserted.)
File name	Set the name of the file that will store the measurement results.

Note *The default settings are marked with an asterisk.

Binary Format

The measurement result multiplied by 1,000 is output as 4 consecutive digits.

Item	Details
Output form	Select <i>Binary</i> .
Digits of integer	These settings are only for ASCII format. No settings are required for binary format.
Digits of decimal	
Minus	
Field separator	
Record separator	
0 Suppress	
File name	Set the name of the file that will store the measurement results.

1. Enter System mode and select *Output*.

SeeAlso

Refer to page 292.

The Output Device/Serial/Memory Card Menu will be displayed.

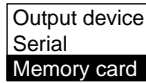

2. Select *Memory card*.

The Output (Memory Card) Settings Screen will be displayed.

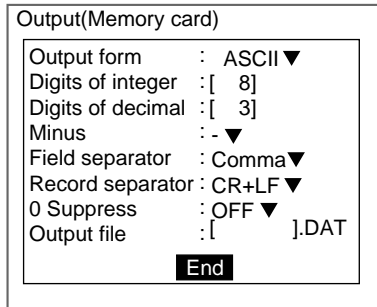

SeeAlso

Refer to page 29 for details on inputting values.

3. Change the settings for each item.
4. Move the cursor to the square brackets [] for the output file name and press the **ENT** Key.

The software keyboard will be displayed.

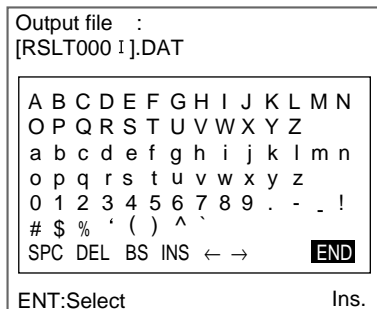

SeeAlso

Refer to page 31 for details on inputting characters.

5. Set up to 8 characters.
6. Move the cursor to **END** and press the **ENT** Key.

- CHECK** The output file will be saved in the OUTFILE directory in the root directory.
 The screen in (3.) will return.
7. Select **End**.
 The settings will be saved and the screen in (2.) will return.

6-4 Screen Display and Monitor

6-4-1 Measurement Screen Settings

Set the items below to determine the information displayed in Run Mode and Monitor Mode. The display settings made here will be reflected in all scenes.

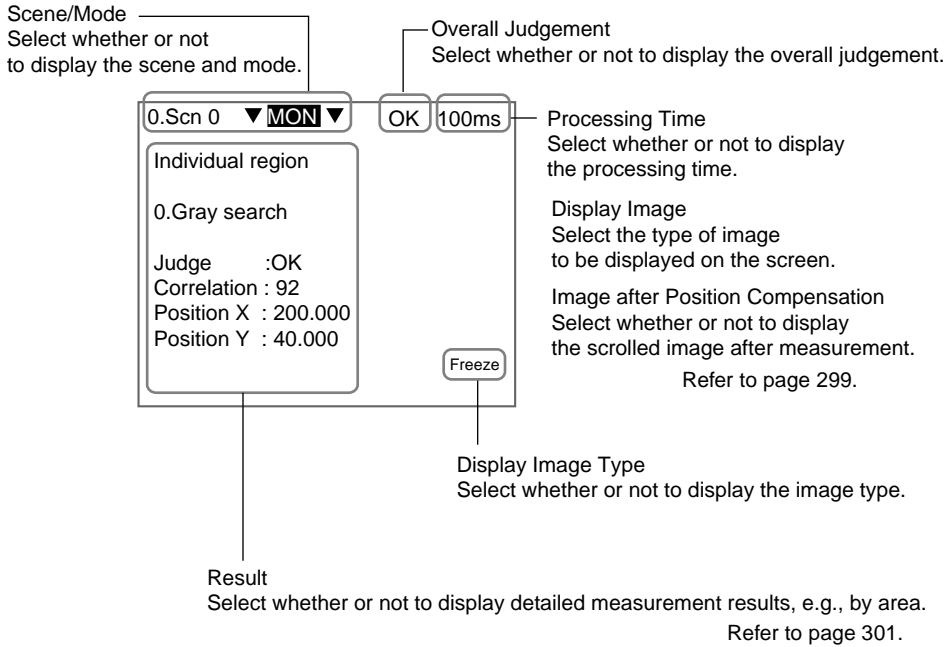

- CHECK** Scene/Mode
 Even if Scene/Mode is set to not be displayed, the scene or mode can be displayed temporarily by press the ENT Key. However, measurement cannot be performed while the scene or mode is being displayed this way. Press the ESC Key again to turn OFF the display.
1. Enter System mode and select **Display**.

SeeAlso Refer to page 292.
 The Display Settings/Monitor/Designate Colors/Make Colors Menu will be displayed.

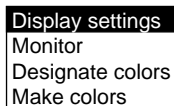

2. Select **Display settings**.

The Display Settings Screen will be displayed.

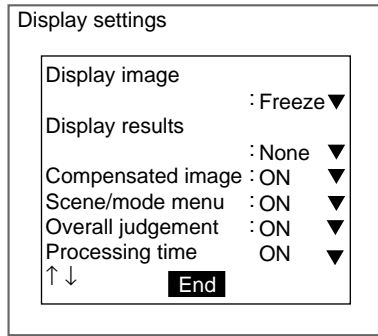

3. Change the settings for each item.
4. Select **End**.

The settings will be registered and the screen in (2.) will return.

Image after Position Compensation

Select the image display after measurement if position displacement compensation has been specified.

If the *Display Image Type* setting is *Through* or *Reduction Through*, the setting made here will be ignored.

Selection	Details
Display*	The image scrolled the position compensation amount will be displayed. Be careful, however, because the following restrictions apply. If the BUSY signal is set to remain ON until <i>Display end</i> , the measurement time will be extended (by up to 16.7 ms.) Refer to page 322. If the BUSY signal is set to remain ON until <i>Image input end</i> or <i>Measurement end</i> , the display may become disrupted if the STEP input interval is short, because the next image will be read before the image display has been completed. Refer to page 322.
Not display	Displays an image that has not been scrolled, i.e., the image as read by the Camera.

Note *The default setting is marked with an asterisk.

Display Image

Select the type of image to be displayed in the background.

Selection	Details
Freeze*	A still of the image taken by the Camera is displayed. This image is updated when measurement is performed. Select <i>Freeze</i> when measuring moving objects.
Through	The latest image taken by the Camera is displayed directly. If measurement is performed using <i>Through</i> display, the measurement time will be increased by the amount of time from when the measurement command is input until the image input starts. This delay is included in the measurement time shown on the Monitor and Run Mode screens.

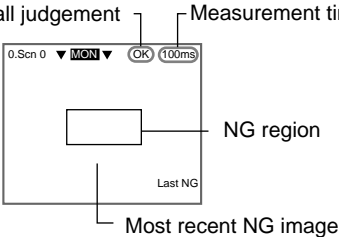
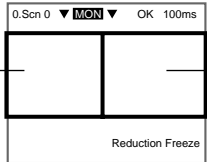
Selection	Details
Last NG	<p>The image of the latest image to receive an overall judgement of NG is displayed.</p> <p>The latest measurement results are always displayed for overall judgement and measurement time.</p> <p>Be careful, because the display image and the overall judgement will not match when this image type is selected if the latest measurement gave an OK judgement.</p> <p>Overall judgement Measurement time</p>  <p>Regardless of the NG region, the camera image will be displayed according to the display setting.</p> <p>The following operations cannot be performed, while the latest NG image is being displayed.</p> <ul style="list-style-type: none"> • Re-measurement • Display capture • Line Brightness display • Stored image display <p>When the following operations are performed, the latest NG image will be cleared and the display will remain clear until the next NG result is returned.</p> <ul style="list-style-type: none"> • When the scene or scene group changed • When moved to Set, System or Tool modes. • When switching to Monitor or Run Mode. • When switching the display image. • When performing operations such as displaying menus for key allocations. • When executing commands other than measurement commands (no-protocol, parallel, or Host Link commands).
Reduction Freeze Reduction Through	<p>The images read by the two Cameras are reduced and displayed side-by-side.</p> <p>If only one Camera is connected, the image will still be reduced and it will be displayed on the right half of the screen.</p>  <p>The following operations cannot be performed when <i>Reduction Freeze</i> or <i>Reduction Through</i> have been selected.</p> <p>Display capture Line Brightness Display</p>
Reduction Last NG	<p>The image of the latest image to receive an overall judgement of NG is displayed. As for <i>Reduction Freeze</i>, the image is reduced to half. The rest of the operations are the same as for <i>Last NG</i>.</p>

Note *The default setting is marked with an asterisk.

Results

Detailed measurement results can be displayed on the screen. Judgement conditions can also be set while monitoring measurement values.

CHECK

The description given here is based on default key allocations. Be careful if the key allocations have been changed.

None (default)

Only the overall judgement will be displayed.

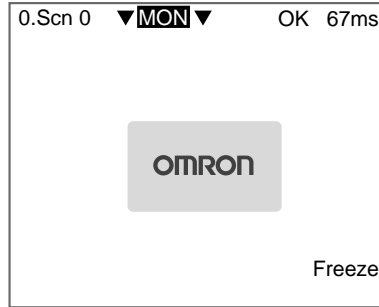

Position Compensation

The position displacement compensation result will be displayed. One screen displays the measurement result by region and the other displays the amount of movement. Use the Up/Down Keys to switch between these screens.

• Measurement value by region

• Amount of movement
(reference position - measurement position)

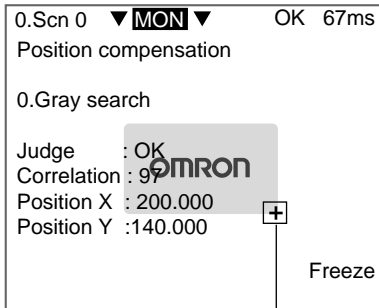

The position compensation region is displayed.

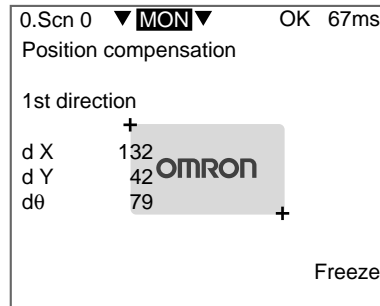

CHECK

Press the SHIFT+ENT Keys in the measurement value by region screen to display the menu for changing settings. The measurement conditions can be changed while still in Monitor or Run Mode. While the screen for changing settings is displayed, however, measurement cannot be performed even if the measurement command is input.

All Result of Regions The judgement results for the set measurement regions will be displayed.

0.ScN 0 ▼MON▼ NG 67ms
All result of regions

P0	0	8
P1	1	9
	2	
	3	
	4	
	5	
	6	
	7	

P0 to P7: Position displacement compensation regions
0 to 31: Measurement regions
Regions with NG results will be highlighted.
For monochrome monitors
Press the **SHIFT+ Left/Right** Keys to switch backgrounds between filled and clear.

Freeze

TwoCamera Use the Up/Down Keys to switch Cameras. This operation is disabled for reduction displays.

All Positions of Regions The set measurement regions and position displacement compensation regions are displayed in solid lines.

0.ScN 0 ▼MON▼ OK 67ms
All positions of regions

Freeze

TwoCamera Use the Up/Down Keys to switch Cameras. This operation is disabled for reduction displays.

Individual Regions The measurement values for each region are displayed. Use the Up/Down and Left/Right Keys to change the displayed region.

0.ScN 0 ▼MON▼ OK 67ms
Individual region

0.Gray search

Judge : OK
Correlation : 92
Position X : 200.000
Position Y : 140.000

Freeze

CHECK Press the SHIFT+ENT Keys to display the menu for changing settings. The measurement conditions can be changed while still in Monitor or Run Mode. While the screen for changing settings is displayed, however, measurement cannot be performed even if the measurement command is input.

All Variables The measurement values for the set expressions (variables) are displayed in a list. Use the Up/Down Keys to change the display number. The judgement results for the remaining variables are displayed in the box to the right of the screen.

0.ScN 0 ▼ MON ▼ NG 67ms

All Variables

Value0	1234567.890	8 16 24
Value1	2345678.901	9 17 25
Value2	124569.236	10 18
Value3	569.123	11 19
Value4	6543241.239	12 20
Value5	53982.256	13 21
Value6	321.567	14 22
Value7	556987.165	15 23

NG numbers are highlighted.

For monochrome monitors
Press the **SHIF +Left/Right**
Keys to switch backgrounds
between filled and clear.

TwoCamera

Once the Camera 0 image has been displayed and variables 0 to 31 changed, the display will move to the Camera 1 image for the switching of Camera 1 variables 0 to 31. This operation is disabled for reduction displays.

CHECK

The variable names and judgement conditions can be adjusted. Press the SHIFT + ENT Keys in the variable screen shown above and the screen for selecting variables will be displayed. Move the cursor to the variable to be adjusted and press the ENT Key. The screen for changing conditions will be displayed. However, measurement cannot be performed while in the screens for selecting variables and changing conditions, even if the measurement command is input.

Screen for changing variables

All Variables

Value0	1234567.890	NG
Value1	2345678.901	OK
Value2	124569.236	OK
Value3	569.123	OK
Value4	6543241.239	OK
Value5	53982.256	OK
Value6	321.567	OK
Value7	556987.165	OK

↑ ↓:Move ENT:Conditions

Screen for changing conditions

[Value0]

Measurement : 2345678.901

Upper : [2500000.000]

Lower : [2200000.000]

[End]

All Data

A list of measurement values for expressions (data) will be displayed. Use the Up/Down Keys to switch the display number.

0.ScN 0 ▼ MON ▼ OK 67ms

All data

0.	123.245
1.	-28.483
2.	
3.	
4.	
5.	
6.	
7.	

OMRON

Freeze

For monochrome monitors
Press the **SHIFT+Left/Right** Keys
to switch backgrounds
between filled and clear.

TwoCamera

Once the Camera 0 image has been displayed and variables 0 to 31 changed, the display will move to the Camera 1 image and the switching of Camera 1 variables 0 to 31. This operation is disabled for reduction displays.

All Judgements

A list of the measurement values for the set expressions (judgements) will be displayed.

TwoCamera

Use the Up/Down Keys to switch between Cameras.

Individual Variable, Individual Data, and Individual Judgements

The measurement values for an expression are displayed. Use the Up/Down Keys to switch between expressions.

CHECK

Press the SHIFT + ENT Keys while in this screen to display the screen for changing conditions. The judgement conditions can be changed while monitoring the measurement values. However, measurement cannot be performed while in the screens for changing conditions even if the measurement command is input.

TwoCamera

Once the Camera 0 image has been displayed and variables 0 to 31 changed, the display will move to the Camera 1 image and the switching of Camera 1 variables 0 to 31. This operation is disabled for reduction displays.

Browsing in Order

The *Region*, *Variable*, *Data*, *Judge*, and *All* displays are each a combination of a number of display items. The combinations and display order are shown below. Use the Up or Down Key to switch between displays and to browse the displays in order.

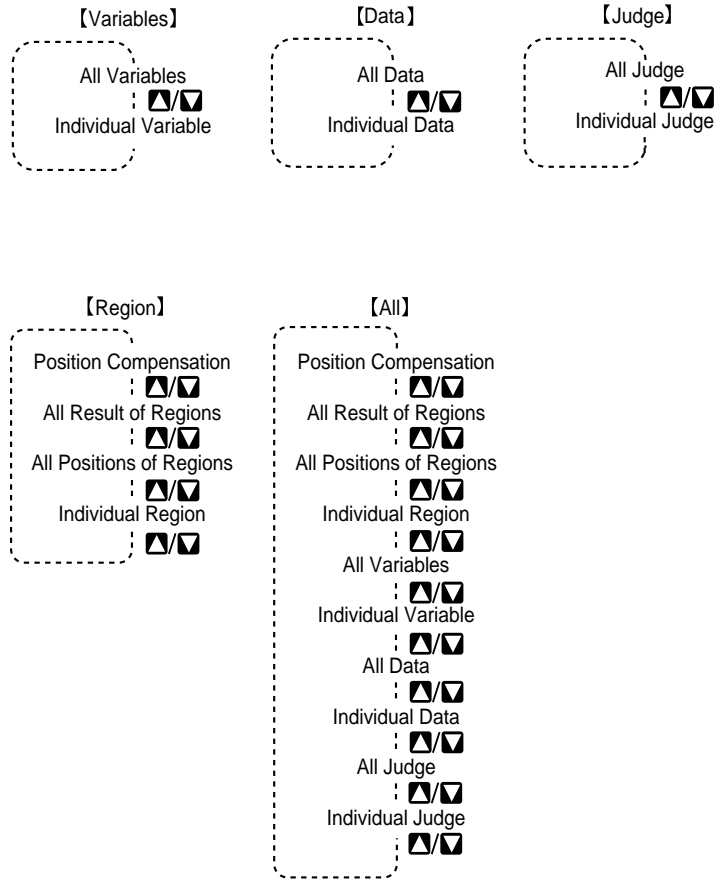

6-4-2 Selecting Color or Monochrome Monitors

Select the type of monitor to be connected. When color monitors are used, characters and figures can be color-coded and displayed in color.

1. Enter System mode and select **Display**.

SeeAlso

Refer to page 292.

The Display Settings/Monitor/Designate Colors/Make Colors Menu will be displayed.

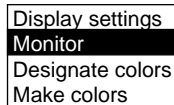

2. Select **Monitor**.

The Monitor Settings Screen will be displayed.

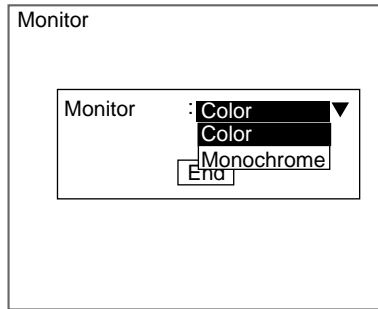

- 3. Select the monitor type.
- 4. Select **End**.

The settings will be registered and the screen in (2.) will return.

6-4-3 Changing Character or Figure Colors

The color for characters or added figures can be set. Change the color when it is difficult to see the character or figure on the image. The display color set here, however, will be reflected in all scenes.

For color monitors, select white, black, red, green, blue, yellow, or original (a combination of up to any 7 colors can be set.)

For monochrome monitors, select white or black.

SeeAlso Refer to page 307 for information on creating original colors.

The positions where color can be changed are described below.

Normal and Background Colors

Messages displayed on the screen will be appear in the color set under *Normal*. Menu boxes will shaded in the color set under *Background*.

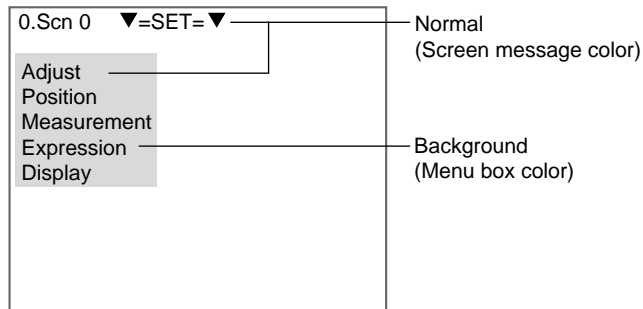

OK and NG Colors

The judgement display, all measurement values, and the measurement region will be displayed in the color set under *OK color* or *NG color*, depending on the measurement result.

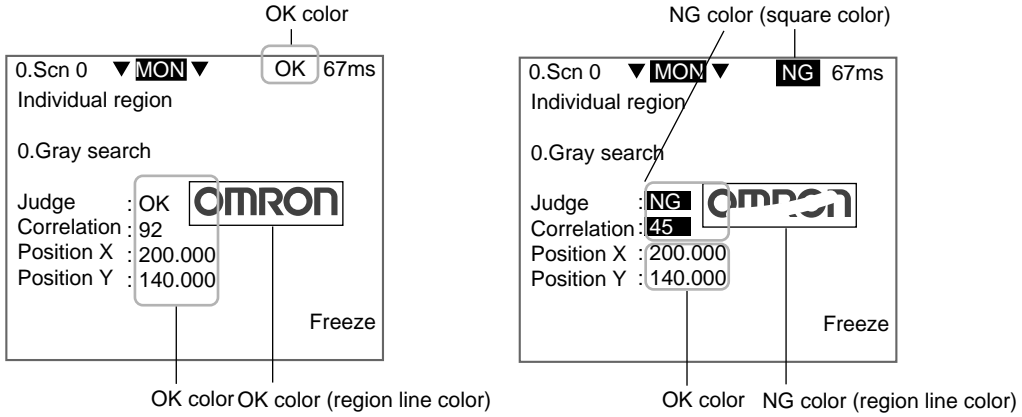

Figure Colors 0 to 6

The figure color is the color for figures or characters displayed on the screen using the display function.

SeeAlso Refer to page 233.

1. Enter System mode and select **Display**.

SeeAlso Refer to page 292.

The Display Settings/Monitor/Designate Colors/Make Colors Menu will be displayed.

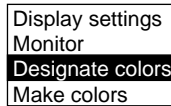

2. Select **Designate colors**.

The Designate Colors Screen will be displayed.

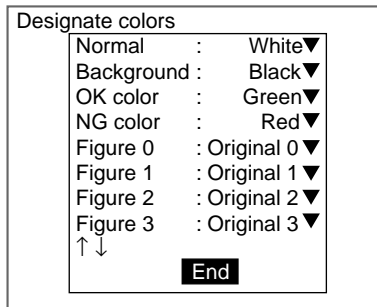

3. Make the settings for each item.
4. Select **End**.

The settings will be registered and the screen in (2.) will return.

6-4-4 Creating Original Colors

Up to 7 original colors can be created for displaying characters or figures, using a combination of red, green, and blue.

SeeAlso Refer to page 306 for information on how to display the original color. The default settings are shown below.

Display item	R (red)	G (green)	B (blue)
Original 0	32	32	32
Original 1	64	64	64
Original 2	96	96	96
Original 3	128	128	128
Original 4	160	160	160
Original 5	196	196	196
Original 6	224	224	224

1. Enter System mode and select **Display**.

SeeAlso Refer to page 292.

The Display Settings/Monitor/Designate Colors/Make Colors Menu will be displayed.

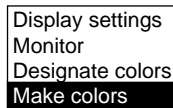

2. Select **Make colors**.

The menu for selecting color numbers will be displayed.

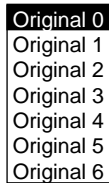

3. Select a color number to set for the new color.

The Make Color Screen will be displayed.

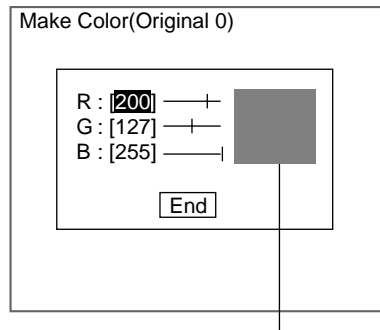

The set color will be displayed here.

4. Make the settings for each item.
Up and Down Keys: Moves the cursor
Left and Right Keys: Reduces the color at the cursor position by one.
SHIFT+Left/Right Keys: Reduces the color at the cursor position by ten.
5. Select **End**.
The settings will be saved and the screen in (3.) will return.

6-5 Customizing Operations

6-5-1 Changing Console Key Allocations

It is possible to change the allocations for Console key operations.

CHECK The set allocations are only enabled in Monitor Mode or Run Mode.

Default Key Allocations

Key	Allocation
ESC	None
SHIFT + ENT	Change measurement conditions
SHIFT + ESC	Display settings
SHIFT + ◀	Change background
SHIFT + ▶	Change background
SHIFT + ▲	Previous image
SHIFT + ▼	Next image
F1 to F8 (See note 1.)	None



Allocatable functions
None
Measurement screen
Previous image
Next image
Change background
Judgement conditions
Previous scene
Next scene
Previous scene group
Next scene group
Clear image
Erase characters
Save
Through/Freeze
Measurement control
Monitor
Color
Thumbnail display
Drive status
Scene/mode menu
Line Brightness
Display capture (Note 2.)

Note 1 Function keys are supported only for F160-KP.
If the F150-KP is being used, input will not be possible using these keys, even if key allocations are made.

Note 2 Changing display capture key allocations
Any key allocation for the display capture function will be disabled if *SYS/Operation settings/Display capture* is set to OFF.
Refer to page 312.

Refer to page 310 for information on the role of each function.

Function of Allocated Functions

Item	Function
None	Nothing allocated.
Display settings	Displays the <i>SYS/Conditions/Display settings</i> screen.
Previous image (See note 1.)	Displays the previous memory image.
Next image (See note 1.)	Displays the next memory image.
Change back- ground	Changes the brightness of the background (dark e clear) for screens displaying lists of results. (Can only be used for All results of regions, All judges, All data, and I/O monitor for monochrome monitors only.)
Judge conditions	Displays the screen for setting evaluation criteria.
Previous scene	Displays the previous scene.
Next scene	Displays the next scene.
Previous scene group	Displays the previous scene group.
Next scene group	Displays the next scene group.
Clear image	A message confirming whether all stored images are to be cleared is displayed. Images stored in memory are cleared when power is turned OFF. By allocating this function to a Console Key, stored images can be cleared without turning power OFF.
Erase characters	Displays the menu for character display settings. To prevent scorching of the monitor screen, it is possible to delete screen characters.
Save	Displays a confirmation message for saving to flash memory or Memory Card.
Through/Freeze (See note 1.)	Switches to Freeze display if currently on Through display. Switches to Through display if currently on Freeze display.
Measurement control	Displays the <i>SYS/Measurement control</i> screen.
Monitor	Displays the <i>SYS/Display/Monitor</i> screen.
Designate colors	Displays the <i>SYS/Display/Designate colors</i> screen.
Thumbnail display (See note 2.)	The saved measurement images are displayed 4 at a time.
Drive status	Displays the <i>Tool/Memory card/Drive status</i> screen.
Scene/mode menu	The scene number and mode display shown at the top left corner of the Basic Screen in Monitor and Run Modes is deleted. Press the ENT Key to display the scene number and mode display temporarily. Measurement cannot be performed, however, during this display. Press the ESC Key to make the display disappear.
Line Brightness	Displays the <i>Tool/Line brightness</i> screen. Line brightness cannot be displayed, however, when <i>Reduction freeze</i> , <i>Reduction through</i> , or <i>Reduction NG</i> are set for <i>Image display</i> .
Display capture	Saves the displayed image to the Memory Card. Refer to page 313.

- Note**
1. Previous image, Next image, and Through/Freeze
When the image display is set to *Last NG* or *Reduction last NG*, the display will not switch even if this allocated key is input.

- Thumbnail Display
Stored images are displayed 4 at a time, making it faster to find a particular measurement image.

Last (Mem 0)	Last 1 (Mem 1)
Last 2 (Mem 2)	Last 3 (Mem 3)

SHIFT+Up/Down Keys: Switches to the last four or next four images.

Up/Down and Left/Right Keys: Moves the thick frame for selecting images.

ENT Key: Selects the image inside the thick frame and returns to the previous screen.

CHECK

Measurement cannot be performed during thumbnail display.

If two Cameras are used, the images are saved two at a time. Therefore, the display moves forward and back two images at a time.

Last 0 (Mem 0)	Last 0 1 (Mem 1)
Last 1 0 (Mem 2)	Last 1 1 (Mem 3)

- Enter System mode and select **Operation settings**.

SeeAlso

Refer to page 292.

The menu will be displayed.

Set key operation
Display capture
Setting menu masking
Processing item masking
Save at switch Scn Group
Password

- Select **Set key operation**.

The Set Key Operation Screen will be displayed.

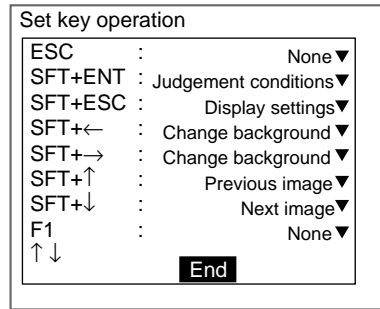

3. Make the settings for each item.
4. Select **End**.

The settings will be registered and the screen in (2.) will return.

6-5-2 Capturing and Saving Images

Enabling the display capture function allows images displayed on the monitor screen to be captured and saved to the Memory Card.

Stored images can be pasted to documents on a personal computer or loaded to the F160 and re-measured.

The default setting is OFF.

CHECK

- The capture operation takes several seconds, during which measurement cannot be performed. To prevent incorrect operation, set this function to OFF.
- When the image display is set to *Last NG*, *Reduction freeze*, *Reduction through*, or *Reduction last NG*, captured images are not accepted.

1. Enter System mode and select **Operation settings**.

SeeAlso

Refer to page 292.

The Menu will be displayed.

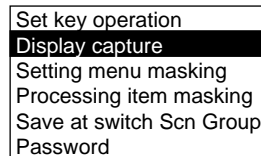

2. Select **Display capture**.

The Display Capture Screen will be displayed.

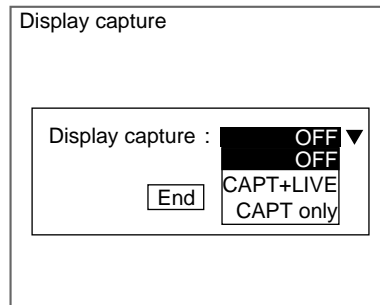

3. Change the settings.

OFF: Images are not captured.

CAPT+LIVE: Two types of image are captured (CAPT***.BMP and LIVE***.BMP).

CAPT only: Only CAPT***.BMP images are captured.

4. Select **End**.

The settings will be registered and the screen in (2.) will return.

Execution Keys

The following keys execute display capture when the display capture function is enabled.

- For F160-KP: F9 Key
- For F150-KP: SHIFT+Left+Right Keys (press 3 keys at the same time.)

CHECK

In Monitor and Run Modes only, the display capture function can be allocated to another key. For example, the key allocation can be changed when the F150-KP is being used to enable one-touch operation, rather than having to press three keys at the same time. If, however, after allocating the display capture function to another key, *Display capture* is set to OFF in the Display Capture Screen, the key allocation is disabled. Refer to page 309.

Display Capture Results

When display capture is executed, a directory called IMAGE will automatically be created in the root directory of the Memory Card and the following two types of files will be stored in that directory.

When two Cameras are used, images from Camera 0 and Camera 1 are saved in LIVE***.BMP.

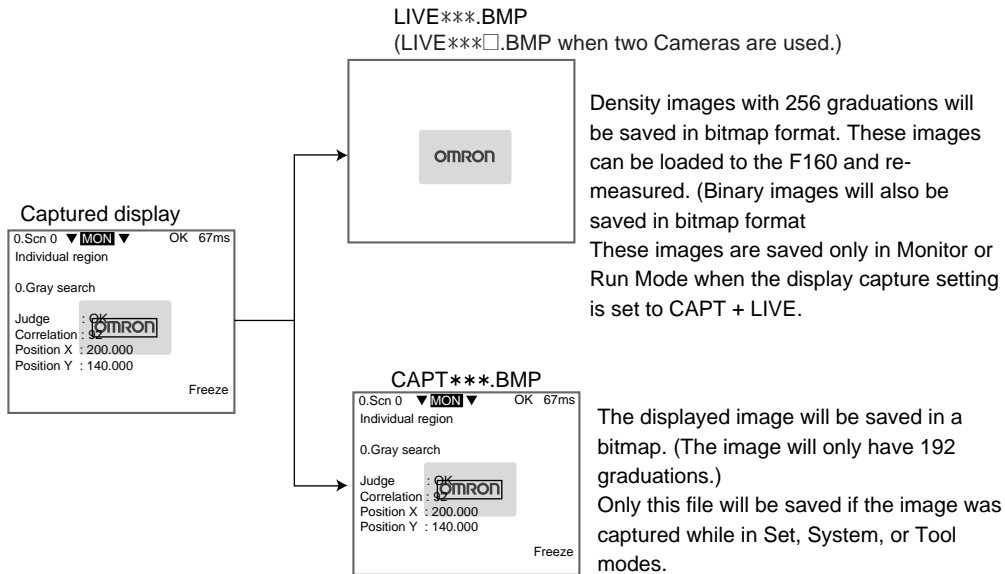

A serial number starting from 000 will be automatically allocated to ***. The same number is used for both files. When two Cameras are used, only LIVE***.BMP files are saved, and the letter A (Camera 0) or B (Camera 1) is added after *** to indicate the Camera number.

6-5-3 Masking Display of Setting Items

The following menu selections are displayed when you enter Set Mode. Menu items that will not be used can be set to not be displayed.

Example:

Default Set mode menu



Position and Display set to not appear.

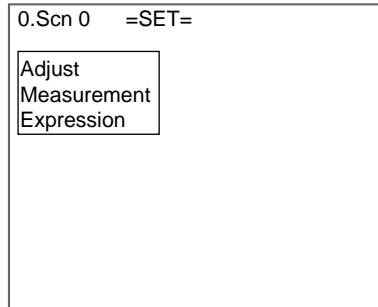

1. Enter System mode and select **Operation settings**.

SeeAlso

Refer to page 292.

The Menu will be displayed.

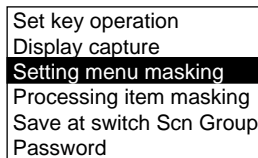

2. Select **Setting menu masking**.

The Setting Menu Masking Settings Screen will be displayed.

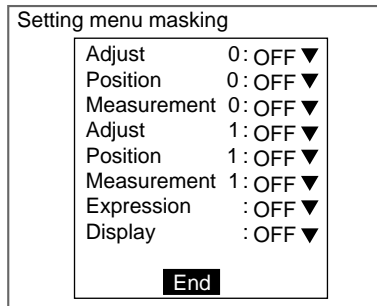

When only one Camera is used, settings can be made for Adjust 0, Position 0, and Measurement 0.

3. Turn ON masking for the items that are not to be displayed.
ON: Not displayed (masked)
OFF: Displayed (not masked)
4. Select **End**.

The settings will be saved and the screen in (2.) will return.

6-5-4 Masking Display of Processing Items

The F160 has multiple processing items and these are displayed when measurement regions are being set. Each item can be set to be displayed or not displayed.

Example:

The default display items set under measurement regions.

Area (var. box) and Defect (var. box) set to not appear.

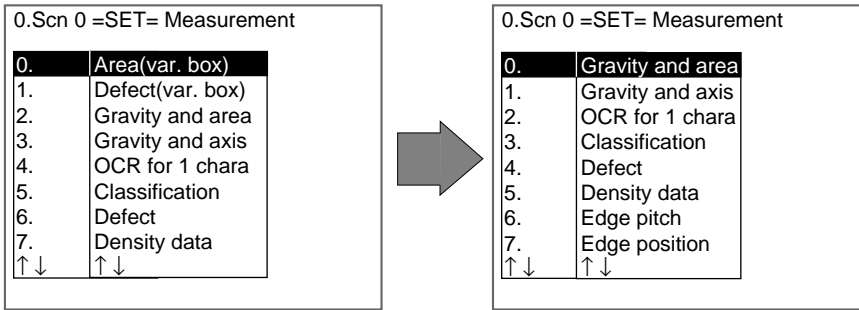

1. Enter System mode and select **Operation settings**.

SeeAlso

Refer to page 292.

The Menu will be displayed.

Set key operation
Display capture
Setting menu masking
Processing item masking
Save at switch Sc Group
Password

2. Select **Processing item masking**.

The Processing Item Masking Settings Screen will be displayed.

Processing item masking	
Area(var. box)	: OFF ▼
Defect(var. box)	: OFF ▼
Gravity and area	: OFF ▼
Gravity and axis	: OFF ▼
OCR for 1 chara	: OFF ▼
Classification	: OFF ▼
Defect	: OFF ▼
Density data	: OFF ▼
↑ ↓	
End	

3. Turn ON masking for the items that are not to be displayed.
ON: Not displayed (masked)
OFF: Displayed (not masked)
4. Select **End**.
The settings will be saved and the screen in (2.) will return.

6-5-5 Shortening Scene Group Switching Time

Normally, settings data is saved to flash memory and the Memory Card when scene groups are changed. The time taken to save is, therefore, added to the time taken to change scene groups. The time to change scene for changes in measurement setups can be reduced by omitting the save process.

Precaution If this function is set to OFF and settings data changed, always save the data before changing scene groups. When scene groups are changed, data from the flash memory or the Memory Card is loaded. So if the changed settings data is not saved, the data will be replaced by the loaded data. Refer to page 275.

1. Enter System mode and select **Operation settings**.

SeeAlso

Refer to page 292.
The Menu will be displayed.

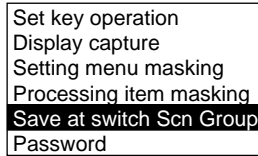

2. Select **Save at switch Scn Group**.

The Saving at Switch Scn Group Settings Screen will be displayed.

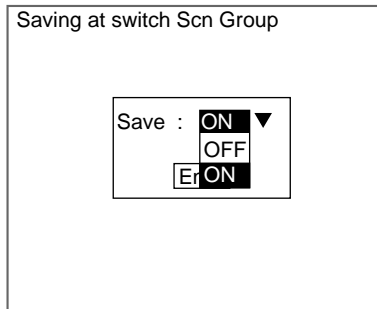

3. Select **ON** or **OFF**.
ON: Saves the data (default)
OFF: Does not save the data
4. Select **End**.
The setting will be saved and the screen in (2.) will return.

6-5-6 Setting Passwords

Passwords can be set to prevent settings being changed through incorrect operation. Set whether or not a password is required for the following two operations.

- When moving from Run Mode to Set, Monitor, or other modes.
- When changing scenes in Run Mode.

1. Enter System mode and select **Operation settings**.

SeeAlso

Refer to page 292.
The Menu will be displayed.

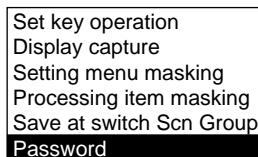

2. Select **Password**.

The Password Settings Screen will be displayed.

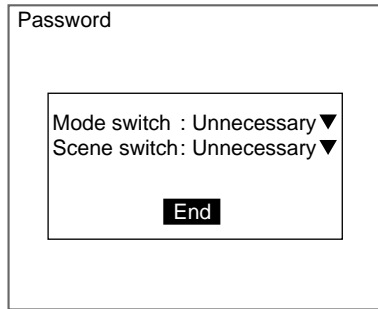

3. Set **Necessary** or **Unnecessary**.
4. Select **End**.

If **Necessary** has been selected, the Input Password Settings Screen will be displayed.

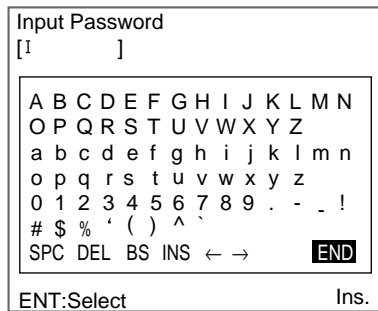

SeeAlso

Refer to page 31 for details on inputting characters.

5. Set a password of 6 to 8 characters.
6. Select **END**.

The settings will be registered and the screen in (2.) will return.

Example: Password Set for Mode Switching

1. Move the cursor to the mode and press the **ENT** Key.



The Input Password Settings Screen will be displayed.

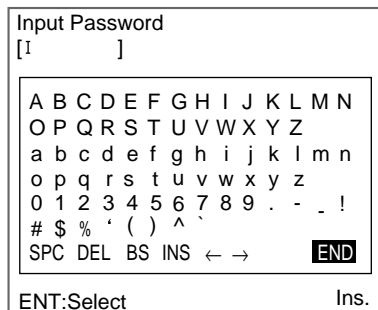

2. Enter the password.
3. Select **END**.

If the entered password is correct, the mode selections will be displayed.

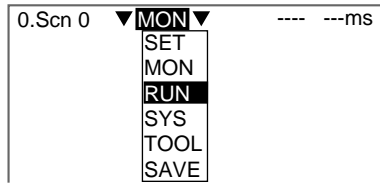

If the entered password is incorrect, an error message will be displayed.

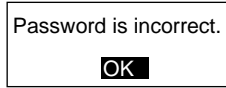

CHECK

Forgotten Passwords

The password can be checked by inputting a password confirmation command from the serial interface. Refer to the *Communications Reference Manual*.

6-6 Setting Conditions for Saving Measurement Images

The F160 can save up to 35 measured images. These 35 images are shared by 32 scenes. The condition for saving the images can be selected from saving only when the measurement result is NG or saving all images regardless of the measurement result. When 35 images have been stored, new images will be stored by overwriting old images, starting with the oldest.

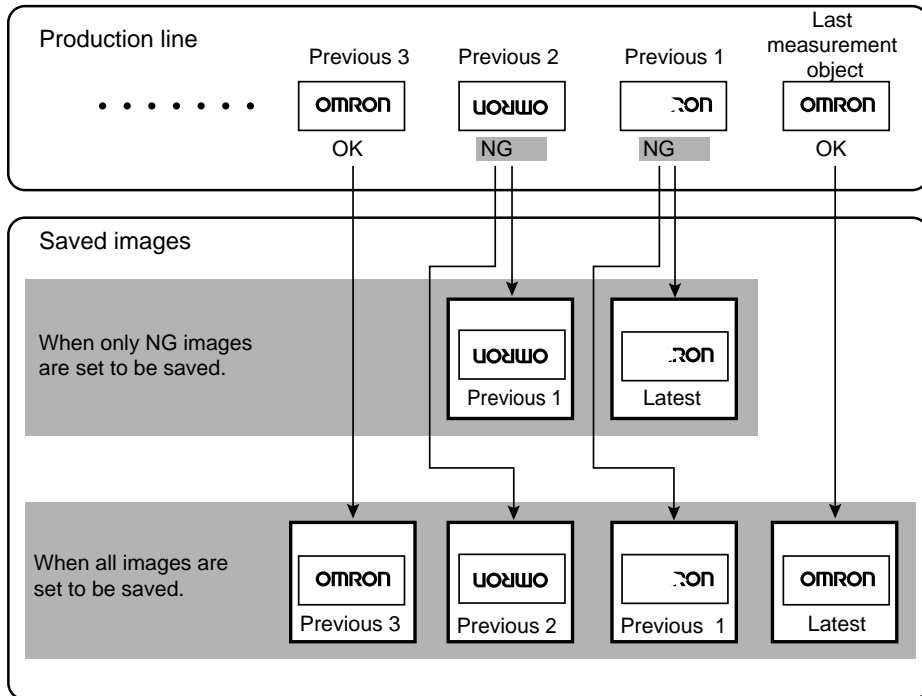

Precaution

Stored images will be cleared when the power is turned OFF. Images to be kept must be backed up to a personal computer or Memory Card. Refer to page 266.

1. Enter System mode and select **Measurement control**.

SeeAlso

Refer to page 292.

The Measurement Control Settings Screen will be displayed.

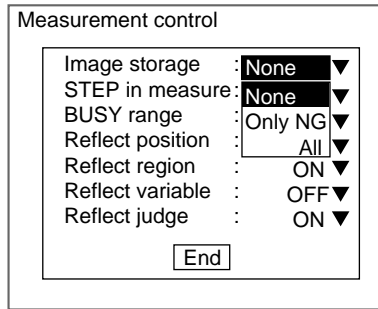

2. Change the conditions under **Image storage**.
3. Select **End**.

The settings will be recorded and the System Mode Screen will return.

6-6-1 Displaying Stored Images

By displaying a stored image on the screen, the reason for a previous NG judgement can be checked. Also, measurement can be re-performed on the stored image with different evaluation criteria.

The current image is displayed in the lower-right corner of the screen. However, the current image will not be displayed if *Display image type* is set under *Conditions*.

SeeAlso Refer to page 298.

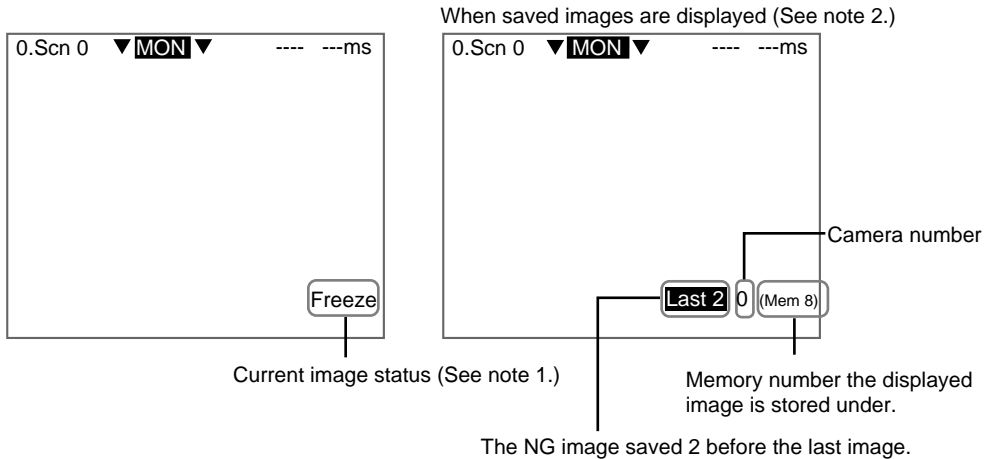

Display	Details	
Freeze	The image that has just been measured is displayed. The type of image displayed depends on the settings in <i>SYS/Display</i> . Refer to page 298.	Note 1
Through		
Last NG		
Reduction freeze		
Reduction through		
Reduction last NG		
△ (Memory □)	A previously stored image is displayed. The Camera number (0 or 1) is inserted at △. Nothing is inserted if there is only one Camera connected. Up to 35 images are stored in accordance with the conditions for storage of measured images (only NG or All). When the image is to be backed up to a personal computer, specify a memory number in □.	Note 2
Types of saved images		
→ Last	The measured image most recently stored is displayed. If this image had an NG judgement, "Last" will be highlighted.	
Last *	The * after "Last" contains the number of screens stored before the image. Up to 35 previous images can be displayed. "Last *" will be highlighted for NG images.	
-----	Either no image is stored in memory, or an image other than a measurement image (an image loaded from a personal computer) is displayed.	

Switching Method

In Monitor Mode or Run Mode, press the SHIFT+Up/Down Keys to switch between images.

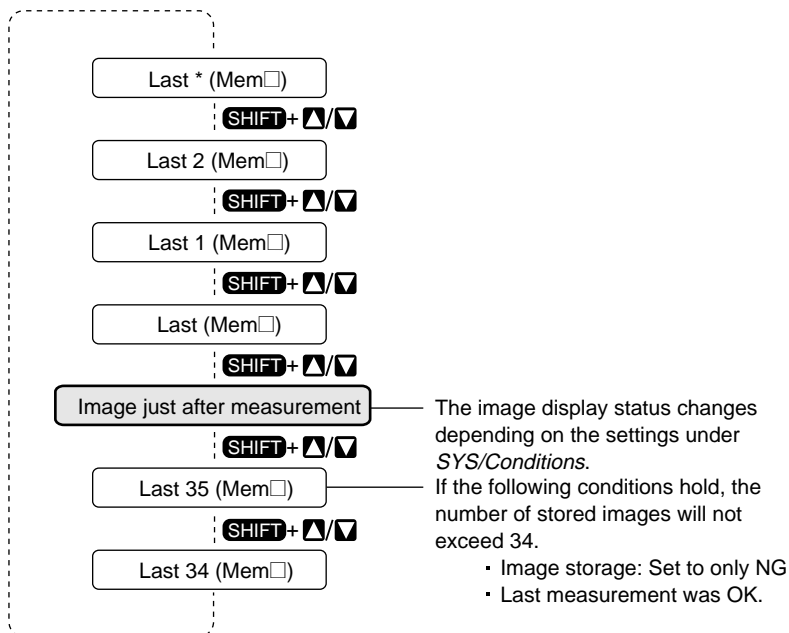

CHECK When *Display* is set to *Last NG* or *Reduction last NG*, the display cannot be switched to stored images. Change the display to *Freeze* or another display mode and then use the SHIFT+Up/Down Keys to switch between images.

6-6-2 Clearing All Stored Images

All images are automatically cleared when the power is turned OFF, but the images can also be cleared without turning OFF the power.

1. Display the Basic Screen in Monitor or Run Modes.

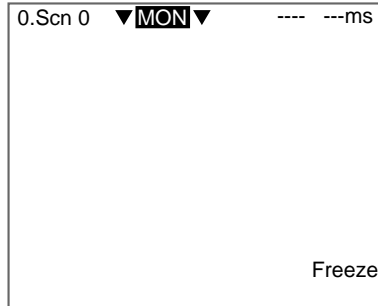

2. Move the cursor to **MON** (or **RUN**) and press the **ENT** Key. The mode selections will be displayed.

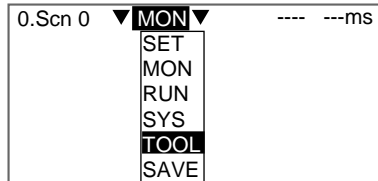

3. Select **TOOL**. The data selections will be displayed.

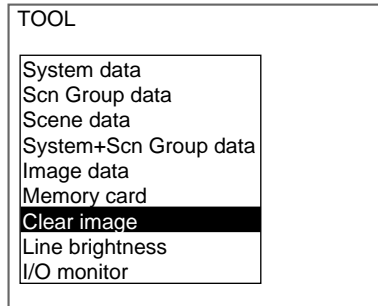

4. Select **Clear image**. A confirmation message will be displayed.

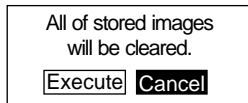

5. Select **Execute**. The stored images will be cleared and the screen in (4.) will return.

CHECK Change the Console Key allocations to clear the stored images with a one-touch key operation. Refer to page 309.

6-7 Using *BUSY* Signals

The *BUSY* signal is a control signal used to show that the F160 is busy processing. The ON/OFF timing of this *BUSY* signal is monitored at the external device to time communications. The handling of the *BUSY* signal can be changed to create a smoother system.

STEP in Measure

Measurement will not be performed by the F160 during another measurement, even if the *STEP* signal turns ON. Set whether or not the *ERR* signal will turn ON to notify the external device that the *STEP* signal was not accepted.

Selection	Details
ERR ON (See note.)	Measurement will not be performed and the <i>ERR</i> signal will turn ON if the <i>STEP</i> signal turns ON during processing. The <i>ERR</i> signal will turn OFF when the next <i>STEP</i> signal is input at the correct timing.
OFF	The <i>ERR</i> signal will not turn ON even if the <i>STEP</i> signal turns ON during processing. Measurement will not be performed.

Note *The default setting is marked with an asterisk.

BUSY Range

Select at what point in the F160 processing that the *BUSY* signal will turn OFF.

Selection	Details
Image input completed	<p>The <i>BUSY</i> signal turns OFF when the image input has been completed. This can be used as a guide as to whether or not the work piece can be moved.</p> <p>When this selection is made, do not enter the next command until measurement has been completed, even if the <i>BUSY</i> signal has turned OFF. If the next command is input before the measurement has been completed, the current processing and the input command may not be executed correctly.</p>
Measurement completed*	<p>The <i>BUSY</i> signal turns OFF when the measurement has been completed.</p>
Display completed	<p>The <i>BUSY</i> signal turns OFF when the display of the measurement result has been completed. The F160 remains busy until the display has been completed.</p>

Note *The default setting is marked with an asterisk.

1. Enter System mode and select **Measurement control**.

SeeAlso

Refer to page 292.

The Measurement Control Settings Screen will be displayed.

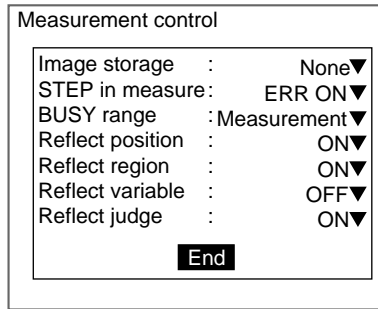

2. Change the **STEP in measure** and **BUSY range** settings.
3. Select **End**.

The settings are registered and the System Mode Screen will return.

6-8 Selecting Items to be Shown in Overall Judgements

Select which of the following four items will be shown in the overall judgement output to the OR signal of the parallel interface.

- Position compensation judgement result
- Judgement result for each region
- *Expression/Variable* judgement result
- *Expression/Judge* judgement result

CHECK

The overall judgement is displayed at the top of the Monitor and Run Mode screens. The display conditions can be changed so that the overall judgement will not be displayed. Refer to page 298.

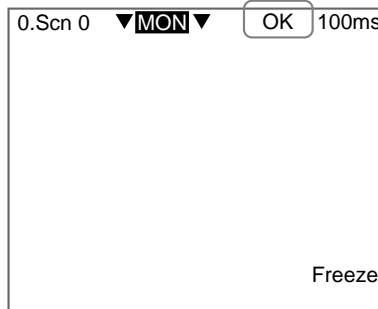

1. Enter System mode and select **Measurement control**.

SeeAlso

Refer to page 292.

The Measurement Control Settings Screen will be displayed.

Measurement control	
Image storage	: None▼
STEP in measure	: ERR ON▼
BUSY range	: Measurement▼
Reflect position	: ON▼
Reflect region	: ON▼
Reflect variable	: OFF▼
Reflect judge	: ON▼
End	

2. Change the settings.
3. Select **End**.

The settings will be registered and the System Mode Screen will return.

6-9 Setting Startup Conditions

Use the following procedure to set the status when the power is turned ON. If the F160 is set to start in Run Mode for the scene where the desired measurement conditions are registered, measurement of objects can be started by simply turning the power ON.

Also, unnecessary menu selection screens and Camera setting screens that are always displayed at startup can be set to not be displayed.

Item	Details
Startup scene group	Selections: 0 to 31* When a scene group between 1 and 31 is selected, make sure the Memory Card where that scene group is stored is inserted.
Startup scene	Selections: 0* to 31, OFF(scene number when saved to flash memory)
Startup mode	Selections: Set, Monitor*, Run, OFF(mode when saved to flash memory)
Startup language	Select the language for screen messages. Selections: Japanese*, English
Menu selection at startup	The F160 has a Conversational Menu and an Expert Menu. Select whether or not to display the Select Menus Screen at startup. Refer to page 22 Selections: ON* (display), OFF (no display)
Camera settings at startup	Select whether or not to display the Camera Settings Screen. Refer to page 23 Selections: ON* (display), OFF (no display)

Note *The default setting is marked with an asterisk.

1. Enter System mode and select **Startup mode**.

SeeAlso

Refer to page 292.

The Startup Mode Settings Screen will be displayed.

2. Change the settings.
3. Select **End**.

The settings will be saved and the System Mode Screen will return.

6-10 Setting the Calendar Date and Time (Date/Time)

Check if the internal calendar is set to the correct date and time and adjust if necessary.

1. Enter System mode and select **Date/Time**.

SeeAlso

Refer to page 292.

The Date/Time Settings Screen will be displayed.

SeeAlso

Refer to page 29 for details on inputting values.

2. Check if the date and time is correct. Adjust if necessary.
3. If the settings do not require adjustment, select **Cancel** to exit this screen. Select **Update** to save changes to the date and time.

The settings will be registered and the System Mode Screen will return.

6-11 Checking System Information

6-11-1 Checking Remaining Memory Space and Battery Status

Use the following procedure to check the remaining work memory and internal flash memory and the status of the battery mounted for date and time data backup.

1. Enter System mode and select **System information**.

SeeAlso

Refer to page 292.

The Memory capacity/Version Menu will be displayed.

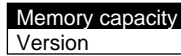

2. Select **Memory capacity**.

The memory capacity will be displayed.

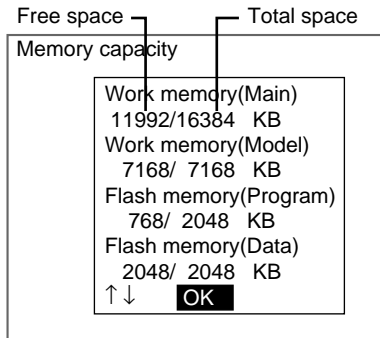

Press the **Down** Key to scroll down and display the rest of the information. The battery status will be displayed at the bottom of the list.

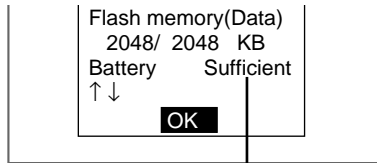

If *Replace* is displayed here, replace the battery. Refer to p. 43 in the *Setup Manual*

3. Select **OK** to exit this screen. The screen in (2.) will return.

6-11-2 Checking the Software Version

Use the following procedure to check the software system version.

1. Enter System mode and select **System information**.

SeeAlso

Refer to page 292.

The Memory Capacity/Version Menu will be displayed.

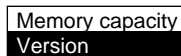

2. Select **Version**.

The version information will be displayed.

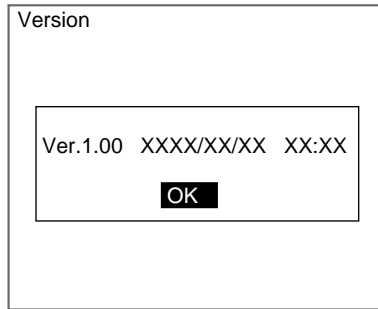

3. Select **OK** to exit this screen.
The screen in (2.) will return.

6-12 Changing to Conversational Menus

The F160 has Conversational Menus and Expert Menus. The data items that are held when switching from the Expert Menus to the Conversational Menus are given below.

Data	Compatibility																	
Scene data	The scene data can be used as is. However, settings made using the Expert Menus for measurement regions and two Camera use cannot be changed using the Conversational Menus.																	
System data	<p>Items that exist in the Conversational Menu system data can be used as is from the Expert Menu.</p> <p>The <i>Operation settings/Set key operation</i> settings will be disabled.</p> <p>The <i>Conditions/Display settings</i> settings will change as shown below.</p> <div style="border: 1px solid black; padding: 5px; margin: 10px 0;"> <p>(Conditions/Display screen)</p> <table style="width: 100%; border-collapse: collapse;"> <tr> <td style="width: 50%;">Display image : Freeze ▼</td> <td style="width: 20%;">Freeze</td> <td rowspan="4" style="width: 10%; vertical-align: middle;">) Will change to Freeze.</td> </tr> <tr> <td>Display results : None ▼</td> <td>Last NG</td> </tr> <tr> <td>Compensated image ON ▼</td> <td>Reduction freeze</td> </tr> <tr> <td>Scene/mode menus ON ▼</td> <td>Reduction last NG</td> </tr> <tr> <td>Overall judgement ON ▼</td> <td>Through</td> <td rowspan="2">) Will change to Through.</td> </tr> <tr> <td>Processing time: ON ▼</td> <td>Reduction through</td> </tr> <tr> <td>Display image type ON ▼</td> <td colspan="2">Will always be None (See note.)</td> </tr> </table> <p style="text-align: center; margin-top: 5px;">End</p> </div> <p>Will always be effective even if set to OFF (See note.)</p> <p>Note: <i>Display results, Compensate image, Scene mode menus, Overall judgement, Processing time, and Display image type</i> will not be displayed under <i>Conditions/Display screen</i> for the Conversational Menu. These settings are fixed for the conversational menu.</p>	Display image : Freeze ▼	Freeze) Will change to Freeze.	Display results : None ▼	Last NG	Compensated image ON ▼	Reduction freeze	Scene/mode menus ON ▼	Reduction last NG	Overall judgement ON ▼	Through) Will change to Through.	Processing time: ON ▼	Reduction through	Display image type ON ▼	Will always be None (See note.)	
Display image : Freeze ▼	Freeze) Will change to Freeze.																
Display results : None ▼	Last NG																	
Compensated image ON ▼	Reduction freeze																	
Scene/mode menus ON ▼	Reduction last NG																	
Overall judgement ON ▼	Through) Will change to Through.																
Processing time: ON ▼	Reduction through																	
Display image type ON ▼	Will always be None (See note.)																	

CHECK Even if the menus are switched to Conversational Menus at on the selection screen at startup, the data hold status for data set using the Expert Menus will be the same as outlined above.

1. Enter System mode and select **Switch menu**.

SeeAlso Refer to page 292.

The Switch Menu Screen will be displayed.

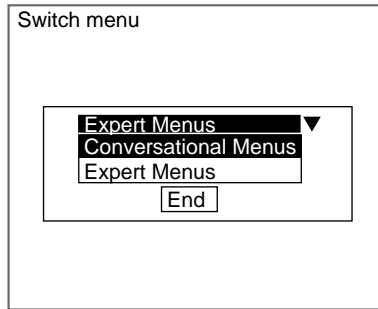

- 2. Switch from **Expert Menus** to **Conversational Menus**.
- 3. Select **End**.

A save confirmation message will be displayed.

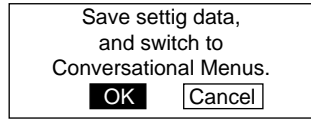

- 4. Select **OK**.

CHECK

If scene group 0 is displayed, the data will be saved to the F160 internal flash memory.

If scene groups 1 to 31 are displayed, the data will be saved (overwritten) to the Memory Card.

The Conversational Menus will start up.

SECTION 7

Appendix

7-1	Terminology.....	330
7-2	Character Codes.....	331
7-3	Troubleshooting.....	332
7-4	FAQ	336

7-1 Terminology

HELP This section explains terms listed beside the HELP icons. Terms explained in the main body of the manual are not listed here.

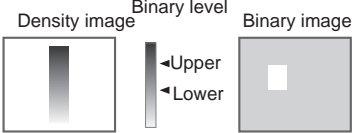
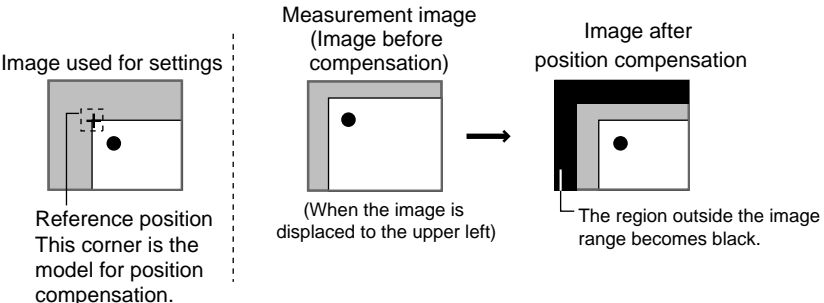
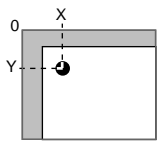
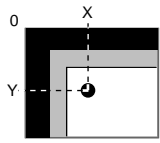
Term	Explanation
Binary	<p>Binary refers to the separation of the density images with 256 gradations read by the Camera into black pixels and white pixels. Upper and lower threshold values (binary levels) are set and the parts of the density image that fall within that gradation range are converted to white pixels and the rest are converted to black pixels. The F160 uses the white pixels to measure the object.</p> 
Calibration	<p>Calibration is the conversion of measurement results from pixels to physical units, such as μm, mm, cm, or m. Set the relationship between the physical coordinates and the camera coordinates to convert the measurement results from pixels to physical units. To output calibrated measurement results to an external device, set <i>Coordinate mode/Calibration</i> to <i>ON</i> for each measurement item.</p>
Output coordinates	<p>Select the type of coordinates to be output to external devices.</p> 
Before scroll	<p>Refer to page 298.</p> <p>Outputs the coordinates before position compensation.</p> <p>The screen display will be the display set under <i>SYS/Conditions/Display settings</i>.</p> 
After scroll	<p>Refer to page 298.</p> <p>Outputs the coordinates after position compensation.</p> <p>The screen display will be the display set under <i>SYS/Conditions/Display settings</i>.</p> 
Center of gravity	<p>The center of gravity is calculated by regarding the white pixels as a sheet of thick paper of uniform thickness. The center of gravity is the point at which the sheet of paper would balance when placed on a sharp point. For example, the center of gravity for a circular object would be the center of the circle. The center of gravity of a rectangular object would be the intersection of lines drawn from diagonally opposite corners.</p>
Correlation	<p>The extent of conformity with the model is expressed as a correlation value. A correlation value between 0 and 100 is displayed. The higher the correlation value, the more similar the input image is to the model.</p>
Density image	<p>Density images are the gray images of 256 gradations read by the Camera.</p>

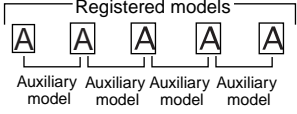
Term	Explanation
Auxiliary model	Auxiliary models are models created between the registered models. Auxiliary models are automatically created by the F160 when multiple models have been registered to the same index number. 
Model	The model is the image pattern used for detection.

7-2 Character Codes

Characters recognized under *OCR for 1 character* are output to external devices as decimal character codes. When no pattern is detected, an underscore (`_`) is output.

Method for Calculating Decimal Outputs

(Numeric value of the leftmost byte of the recognized character) x 16 +
 (Numeric value of the rightmost byte) = output value

Example: When the recognized character is “2”, the output will be “50.”
 When the recognized character is “C”, the output will be “67.”

		Leftmost byte							
		0	1	2	3	4	5	6	7
Rightmost byte	0		D _E		0	@	P	`	p
	1	S _H	D ₁	!	1	A	Q	a	q
	2	S _X	D ₂	”	2	B	R	b	r
	3	E _X	D ₃	#	3	C	S	c	s
	4	E _T	D ₄	\$	4	D	T	d	t
	5	E _Q	N _K	%	5	E	U	e	u
	6	A _K	S _N	&	6	F	V	f	v
	7	B _L	E _B	'	7	G	W	g	w
	8	B _S	C _N	(8	H	X	h	x
	9	H _T	E _M)	9	I	Y	i	y
	A	L _F	S _B	*	:	J	Z	j	z
	B	H _M	E _C	+	;	K	[k	{
	C	C _L	→	,	<	L	\	l	!
	D	C _R	←	-	=	M]	m	}
	E	S _O	↑	.	>	N	^	n	~
	F	S _I	↓	/	?	O	_	o	

7-3 Troubleshooting

This section lists the errors that may occur during F160 operation, along with their probable causes and remedies.

The letters used in the reference page column represent the following reference materials:

Setup: Setup Manual

Expert: Expert Menu Operation Manual (this manual)

Comm.: Communications Reference Manual

When the error messages marked with an asterisk are displayed, the ERR signal will come ON at the parallel interface.

Error message	Causes and remedies	References
Draw at least one OR figure.	Draw diagrams in OR mode. Reason: NOT mode is used to delete part of a drawn diagram.	Expert: page 28
Programmable Controller is not in MONITOR Mode.	Change the mode of the Programmable Controller to MONITOR Mode.	-
Select midpoint between 2 regions for X and Y.	Either set midpoint of 2 regions for X and Y, or change the θ setting. Reason: If the relative angle of the 2 regions is set for the θ , position compensation is not possible unless the midpoint of the 2 regions is set for X and Y.	Expert: page 217
Select same region number for θ , X and Y.	Either set the same region numbers for X and Y, or change the θ setting. Reason: If position compensation regions 0 and 1 are set for θ , position compensation is not possible unless the same regions are set for X and Y.	Expert: page 205
This camera cannot use with Intelligent Lighting.	Check the settings under <i>SYS/Camera settings</i> . Reason: Cameras other than F160-S2, and F150-S1A cannot use Intelligent Lighting.	Expert: page 293
Illegal syntax in expression.	Check the following for the expression: - There are the same number of right and left parentheses. - There is not more than one operator in a row without a variable in between them. - There is not more than one function in a row without a variable in between them. - There is not more than one region number in a row. - There is not more than one constant in a row. - There are not too many, or too few arguments for a function.	-
Detailed settings of camera is incorrect.	Correct the settings.	Expert: page 293
Camera is not connected properly.*	Check the following: - Are the Camera Cables connected to the F160? - Is the Camera Cable disconnected from the Camera? - Check the settings under <i>SYS/Camera settings</i> then cycle the power.	Setup Expert: page 293
Calibration failed.	Perform sampling in at least 2 places. Reason: Sampling has only been performed once.	Expert: page 193
	Perform sampling in 3 places, including X and Y directions or specify a point. Reason: 3 places are specified in a solid line in one direction, X or Y.	Expert: page 193
Output file cannot be written in.*	Specify a different file. Change the file attributes so that it is write enabled.	-
Cannot access this file.	Check the following points and re-select a file. - Is the file read-only? - Is Japanese used in the file name? - Does the Memory Card have sufficient space to save the file?	-
Cannot operate display capture during last NG display.* (See note.)	Check the settings for <i>Display image</i> under <i>SYS/Conditions/Display settings</i> . Reason: <i>Last NG</i> or <i>Reduction Last NG</i> is selected for <i>Display image</i> .	Expert: page 298
Cannot write to scene group file* (See note.)	Change the file attributes so that it is write enabled.	-

Error message	Causes and remedies	References
This region is not drawn.	Either draw the region, or select a region that has been drawn. Reason: A region that has not been drawn is selected as a displacement direction setting.	Expert: page 205
Cannot measure the angle from this region.	Select a region for which Gravity and axis or Rotation search has been set as the measurement method.	Expert: page 92 page 180
Cannot operate display capture during reduction image display.*	Check the settings for <i>Display image</i> under <i>SYS/Conditions/Display settings</i> .	Expert: page 298
Cannot operate line brightness during reduction image display.	Reason: <i>Reduction freeze</i> , <i>Reduction through</i> , or <i>Reduction last NG</i> has been selected under <i>Conditions</i> .	
The Camera shutter speed is fixed and cannot be changed.	Check the <i>Camera</i> settings under <i>SYS/Camera settings</i> . Reason: Only F150-S1A, and F160-S2 Camera shutter speeds can be adjusted from the menu.	Expert: page 293
The number of input lines is fixed. The whole screen is always captured.	Check the <i>Camera</i> settings under <i>SYS/Camera settings</i> . Reason: The number of input lines can be changed for the F160-S2 Camera only.	Expert: page 34
Host Link error. Change to normal mode.*	After checking for the following items, either change the communications mode under <i>SYS/Communications/Serial</i> to Host Link mode (See note.), or restart the F160: - The cable is connected properly. - The communications specifications for the Programmable Controller and the F160 are the same. - The Programmable Controller is ON. Note: The communications mode will automatically return to normal mode when this error occurs.	Comm., Setup
This figure cannot be applied to model registration.	Part of the drawn circle or circumference is outside the region. Draw the figure again, making sure all the figure is displayed on the monitor.	-
No items to display in setting menu. Returning to Monitor Mode.	Check the settings under <i>Setting menu masking</i> under <i>SYS/Operation settings</i> . Reason: Masking has been turned ON for all setting items, i.e, all items are set to not be displayed.	Expert: page 314
Chosen processing item cannot be used for position compensation	Select processing items that can be used for position compensation. Reason: Items that cannot be used for position compensation have tried to be copied to the position compensation region.	Expert: page 205
Cannot select this direction.	Combine upper, lower, left, and right edge search directions that will surround the area to be measured. Reason: The selected directions do not surround the region to be searched.	Expert: page 72 page 137
Background must not be same color as Normal	Change one of the colors.	-
Communications error (Data transfer) (See note.)*	Turn OFF the power to the F160, and check for the following items before restarting the F150. - The cable is connected properly. - The communications specifications for the external device and the F160 are the same. - The external device is operating properly. Reason: Data transfer has been interrupted due to a communications error in communications between the F160 and an external device. If the same error message appears after restart, it may mean that the F160 is faulty. Contact your OMRON representative.	Comm., Setup
Communications error. (Normal)		
Communications error. (Host Link)		

Error message	Causes and remedies	References
Timeout error. (Data transmission)(See note.)*	Turn OFF the power to the F160, and check for the following items before restarting the F150.	Comm., Setup
Timeout error (Normal)	- The cable is connected properly.	
Timeout error. (Host Link)	- The communications specifications for the external device and the F160 are the same. - The external device is operating properly. Reason: Data transfer has been interrupted due to a timeout error in communications between the F160 and an external device. If the same error message appears after restart, it may mean that the F160 is faulty. Contact your OMRON representative.	
Incorrect data format received. (see note.)*	Select the correct transfer file and re-execute the data transfer. Reason: The wrong file has been selected.	-
Data are too large. Cannot save by serial communication.	Save the data to a Memory Card or delete surplus data and then save. Reason: Data 2MB and over cannot be saved via serial communications.	Expert: page 271
Cannot delete directory having files.	Delete the files in the directory to be deleted or move the files to another directory. Reason: Only empty directories can be deleted.	Expert: page 281
Directory name is not specified.	Specify the directory name and press the ENT Key.	-
Directory name contains unusable character.	Check the directory name. The following characters cannot be used: ¥ / , ; * ? " < > ! & .	-
Same directory name has already existed	Specify a directory name that is not being used.	-
Same file name has already existed.	Specify a file name that is not being used.	-
Calculated magnification higher. Correct magnification range: 0.01 to 9.999	Check for the following items, set the magnification again, and re-execute calibration: - The point or sampling width is too wide.	Expert: page 193
Calculated magnification lower. Correct magnification range: 0.01 to 9.999	- The length of the actual coordinates is too short. Reason: The Camera magnification is not between 0.01 and 9.999.	
Password is incorrect.	Enter the correct password.	Expert: page 316
Password must be inputted from 6 to 8 characters or numbers.	Password must be input from 6 to 8 characters or numbers.	Expert: page 316
Date/time settings error.	Set the correct date and time. Reason: A date not in the calendar or an invalid time has been input.	Expert: page 325
File name is not specified.	Specify the file name and then press the ENT Key.	-
File name contains unusable character.	Check the directory name. The following characters cannot be used: ¥ / , ; * ? " < > ! & .	-
Cannot set up comment with unset regions.	Set the region and then input the comment. Reason: An attempt has been made to enter a comment into an unset region.	Expert: page 48
Memory card access error (see note.)*	Check for the following items: - The recommended Memory Card has not been inserted. Use another Memory Card. - The Memory Card has not been formatted.	Setup

Error message	Causes and remedies	References
Memory card is not inserted (See note.)*	Insert the recommended Memory Card.	Setup
Insufficient free space of memory card (See note.)*	- Delete unnecessary files to create free space. - Replace the Memory Card with a bigger capacity card.	Expert: page 287
Insufficient flash memory.*	- Make the region to be registered smaller. - Delete unnecessary scenes and detection items.	Expert: page 255 page 263
Insufficient model memory.*	- Make the region to be registered smaller. - Delete unnecessary scenes and detection items.	-
Insufficient work memory.*	- Make the region to be registered smaller. - Delete unnecessary scenes and detection items.	Expert: page 255 page 263
Incorrect region settings.	The region is not drawn correctly. Draw the region again.	-
Loaded file error.*	Specify the correct file and reload. Reason: - A formatting error may have occurred during data or program file load. - Data 2MG or greater cannot be loaded using serial communications. Load the data using the Memory Card.	Expert: page 266

Note *The ERR signal will turn ON for the items marked with an asterisk in the above table, in Monitor Mode or Run Mode.

7-4 FAQ

I/O

Question	Answer
Will the RUN signal be output during scene switching?	- The RUN signal will remain ON during scene switching in Run Mode. - The RUN signal will remain OFF during scene switching in Monitor Mode.
Will the RUN signal turn OFF when the ERROR signal turns ON with Camera or other errors in Run Mode?	The RUN signal will remain ON even if the ERROR signal turns ON.
Why does the ERR signal turn ON when no error message has been displayed?	The ERR signal turns ON when STEP is input while the BUSY signal is ON. Select whether or not the ERR signal will turn ON under <i>SYS/Measurement control</i> . Refer to page 322.

Controller Operation

Question	Answer
What happens to expressions used in measurement region data when a measurement region is cleared?	The expression settings will remain the same. The result of the expression will be 0.000.
How do I set a formulae with more than 64 characters in an output expression?	Set long expressions under <i>Variable</i> and set an output expression that will browse multiple expressions. Refer to page 219.
What data is saved to flash memory or the Memory Card when the save operation is executed?	System data and the scene data for scene group 0 is saved to flash memory. Scene data for scene groups 1 to 31 is overwritten to the Memory Card.
Why are the Camera coordinates output to the external device when calibration is set?	Check that <i>Calibration</i> under <i>Coordinate mode</i> for each measurement item is set to ON. If <i>Calibration</i> is set to OFF for a measurement item, the Camera coordinates will be output.

Index

A

- area (variable box)
 - See also* measurement methods
 - procedure, 70
- auxiliary models
 - classification, 111

B

- background suppression. *See* BGS, 42
- backing up data, 266
- BGS, 45
- BGS levels
 - processing order, 42
- binary level
 - area (variable box), 70
 - gravity and area, 50
 - gravity and axis, 92
 - labeling, 163
 - setting, 50
- BUSY signal, 322

C

- calendar, 325
- calibration, 47, 193
 - checking data setting, 204
 - coordinate axis, 200
 - input parameters, 202
 - sampling, 193
 - specifying points, 198
- camera modes, 33, 293
 - changing, 34, 38
- Cameras
 - settings, 293
- candidate levels
 - classification, 111
- character codes, 331
- classification
 - See also* measurement methods
 - procedure, 104
- colors
 - customizing, 307
- commands, inputting, 64
- communications, 64
- computer
 - data backup, 266

- conditions
 - See* inspection conditions
 - See* judgement conditions
- Console, 24
- Console keys
 - customizing, 309
- conversational menus, 327
 - compatibility, 14
- coordinate mode
 - area (variable box), 81
 - classification, 113
 - defect, 119
 - defect (variable box), 91
 - edge pitch, 128
 - edge position, 136
 - edge width, 145
 - flexible search, 162
 - gravity and area, 59
 - gravity and axis, 99
 - gray/precision search, 154
 - labeling, 171
 - relative search, 180
 - rotation search, 189
- customizing
 - Console keys, 309
 - display items, 314
 - screen messages, 3

D

- data
 - backup, 266
- data files
 - Memory Cards, 281
- date, 325
- defect
 - See also* measurement methods
 - procedure, 114
- defect (variable box)
 - See also* measurement methods
 - procedure, 82
- density data
 - See also* measurement methods
 - procedure, 119
- density distribution, 276

Detailed Conditions Settings Screen

- classification, 110
 - edge pitch, 127
 - edge position, 134
 - edge width, 143
 - flexible search, 161
 - gray/precision search, 153
 - relative search, 179
 - rotation search, 189
- detection conditions
- defect, 118
 - defect (variable box), 90
 - edge pitch, 123
 - edge position, 129
 - edge width, 138
- dilation, 43
- displays, 25
- calculation results displayed as figures, 250
 - colors, 306
 - customizing, 233
 - figures, 248
 - images, 23
 - judgements, 241
 - masking display items, 314
 - measurement regions names, 245
 - measurement results, 62, 238
 - measurement screen, 298
 - measurement time, 246
 - setting characters, 236
 - setting display conditions, 237
 - setting display positions, 237
 - setting judgement displays, 323
- drawing
- measurement region, 53
- drawing modes, 29, 55
- drawing regions, 28

E

- edge enhancement, 43
- edge extraction, 43
- edge level
 - area (variable box), 76
- edge pitch
 - See also* measurement methods
 - procedure, 123
- edge position
 - See also* measurement methods
 - procedure, 128

- edge width
 - See also* measurement methods
 - procedure, 137
- erosion, 43
- errors, 332
- examples, 33
- expert menus
 - See also* menus
 - starting, 22
- expressions, 59, 219
- external devices, 278

F

- F150-KP, 24
- F180-KP, 24
- fill profile, 52
- filtering
 - processing order, 42
 - types, 43
- flash memory, 65, 266
 - data backup, 275
- flexible search
 - See also* measurement methods
 - procedure, 155
- focussing, 23
- freeze images, 299

G

- gravity and area
 - See also* measurement methods
 - procedure, 50
- gravity and axis
 - See also* measurement methods
 - procedure, 92
- gray search
 - See also* measurement methods
 - procedure, 147

H

- help, 330
- horizontal edge extraction, 43

I

- I/O status
 - monitoring, 278

images
 adjusting, 38
 capturing, 312
 clearing, 321
 display type, 299
 displaying stored images, 319
input commands, 64
input devices, 24
inputting
 characters, 31
 numeric values, 29
inspection conditions
 setting, 34
installation, 22
Intelligent Lighting
 light control, 39

J

judgement conditions
 area (variable box), 71, 79
 changing conditions while monitoring, 62
 classification, 109
 defect, 117
 defect (variable box), 89
 density data, 122
 edge pitch, 126
 edge position, 132
 edge width, 142
 flexible search, 160
 gravity and area, 52, 57
 gravity and axis, 97
 gray/precision search, 151
 labeling, 170
 OCR for 1 character, 103
 relative search, 178
 rotation search, 187
 setting, 57
 setting with fill profile function, 52
judgement results
 displaying, 301

K

keys, Console, 24

L

labeling
 See also measurement methods
 procedure, 163

last NG image, 300
light interference, 32
light level
 adjusting, 39
lighting patterns, 40
line brightness, 276

M

manuals
 F160 manuals, xi
measured images
 conditions for saving, 318
measurement conditions
 defect (variable box), 82
 labeling, 165
 OCR for 1 character, 101
 relative search, 172
 rotation search, 181
measurement methods, 2
 features, 6
 area (variable box), 6
 classification, 8
 defect, 9
 defect (variable box), 6
 density data, 9
 edge pitch, 10
 edge position, 10
 edge width, 11
 flexible search, 11
 gravity and area, 6
 gravity and axis, 7
 gray search, 11
 labeling, 12
 OCR for 1 character, 8
 precise search, 11
 relative search, 13
 rotation search, 13
 selecting, 5
 types and features, 4
measurement object
 positioning, 47

- measurement regions, 48
 - area (variable box), 72
 - defect, 114
 - defect (variable box), 84
 - density data, 120
 - displaying, 302
 - drawing, 53
 - edge pitch, 124
 - edge position, 130
 - edge width, 139
 - editing, 253
 - gravity and area, 53
 - gravity and axis, 94
 - labeling, 166
 - numbers, 48
 - OCR for 1 character, 102
- measurement results
 - displaying, 300
 - outputting, 294
 - outputting to external devices, 2
- measurement time, 64
 - reducing with pixel skipping, 57
- measurement values
 - displaying, 302
- measurements
 - executing, 63
- median filtering, 43
- Memory Card, 281
 - outputting results, 296
- menus
 - menu tree, 26
 - overview, 16
 - two-camera operation, 19, 33
- models
 - flexible search, 156
 - gray/precision search, 147
 - rotation search, 183
- monitor color, 305
- Monitor Mode, 60

N

- noise level
 - area (variable box), 77
- noise width
 - area (variable box), 77

O

- OCR for 1 character
 - See also* measurement methods
 - character codes, 331
 - procedure, 100
- offset width
 - area (variable box), 78
- operating modes, 26
- operational flow, 15
- operations
 - basic, 21
 - menu, 24
 - Run Mode, 60
- outputting
 - formats, 64
 - measurement results, 294
- outputting data
 - external devices, 2
 - using expressions, 59, 219
- overall judgement, 64

P

- parallel interface, 64
 - checking I/O status, 280
- passwords, 316
- physical units, 47
- pixel skipping, 57
 - area (variable box), 80
 - classification, 111
 - gravity and area, 57
 - gravity and axis, 98
- position compensation, 47, 205
 - displayed images, 299
 - displaying, 301
 - regions and directions, 206
- position compensation regions
 - See also* regions
 - displaying, 302
- precise search
 - See also* measurement methods
 - procedure, 147

R

- reduction images, 300
- reference point
 - offsetting, 56
- reference position, 47

reference values
 area (variable box), 78
 defect (variable box), 88
 edge position, 131
 edge width, 140
 gravity and area, 55
 gravity and axis, 96
 labeling, 169

regions
 drawing, 28
 editing, 253

registering models
 classification, 104

relative search
 See also measurement methods
 procedure, 172

rotation search
 See also measurement methods
 procedure, 180

Run Mode, 60, 63

S

saving
 settings, 65

scene data
 compatibility with conversation menus, 14

scene groups
 changing, 260
 reducing switching time, 315

Scene/Mode, 298

scenes
 adding comments, 264
 changing, 260
 clearing, 263
 copying, 262
 using scene groups, 265

screen displays, 25

screen settings, 298

screens, 3

search coordinates
 gray/precision search, 149
 rotation search, 185

search regions
 classification, 108
 flexible search, 159
 gray/precision search, 150
 rotation search, 186

serial interface, 64
 checking I/O status, 278
 outputting results, 295

shutter speed, 38

smoothing, 43

software system version, 326

starting, 22

startup conditions, 324

synchronizing Cameras, 32

system environment, 291

system information, 325

System Mode, 292

T

terminology, 330

testing
 Monitor Mode, 60

through images, 299

time, 325

two-camera operation, 2
 menus, 19

Two-camera Unit, 32

V

variables, 219

vertical edge extraction, 43

Version Information (Ver. 1.□□ → 2.0)

Controller

Item	Details
The number of types of Camera that can be connected has increased.	The F160-S2 Camera can now be connected. Refer to the <i>Setup Manual</i> for details.

Menu

Item	Details
The display capture selections have changed.	The selections have changed from ON/OFF to OFF/CAPT only/ CAPT+LIVE. Refer to page 312.

Revision History

A manual revision code appears as a suffix to the catalog number on the front cover of the manual.

Cat. No. Z173-E1-02A



The following table outlines the changes made to the manual during each revision. Page numbers refer to the previous version.

Revision code	Date	Revised content
01	February 2003	Original production
01A	July 2004	Information on warranty and limitations of liability added to the front of the manual. Page xi: Suffixes removed from catalog numbers in table.
02	May 2005	Information on warranty and liability at the front of the manual updated. Pages 38, 39, 333, 334: Reference to F160-S1 removed. Page 300: Information changed and added for Last NG in table. Page 334: "F160-S1A" corrected to "F150-S1A" in table.
02A	June 2006	Page 22: Illustration updated.

OMRON

OMRON Corporation
Industrial Automation Company

Sensing Devices Division H.Q.
Application Sensors Division
Shiokoji Horikawa, Shimogyo-ku,
Kyoto, 600-8530 Japan
Tel: (81)75-344-7068/Fax: (81)75-344-7107

Regional Headquarters

OMRON EUROPE B.V.
Sensor Business Unit,
Carl-Benz-Str. 4, D-71154 Nufringen,
Germany
Tel: (49)7032-811-0/Fax: (49)7032-811-199

OMRON ELECTRONICS LLC
1 East Commerce Drive, Schaumburg, IL 60173
U.S.A.
Tel: (1)847-843-7900/Fax: (1)847-843-8568

OMRON ASIA PACIFIC PTE. LTD.
83 Clemenceau Avenue,
#11-01, UE Square,
239920 Singapore
Tel: (65)6835-3011/Fax: (65)6835-2711

OMRON (CHINA) CO., LTD.
Room 2211, Bank of China Tower,
200 Yin Cheng Road (M),
Shanghai, 200120 China
Tel: (86)21-5037-2222/Fax: (86)21-5037-2200

Authorized Distributor: