

# **DeviceNet Communications Unit for EJ1 Temperature Controllers**

## **OPERATION MANUAL**

**OMRON**

# **DeviceNet Communications Unit for EJ1 Temperature Controllers**

## **Operation Manual**

*Revised March 2008*



## ***Preface:***

OMRON products are manufactured for use according to proper procedures by a qualified operator and only for the purposes described in this manual.

This manual contains information on the functions, performance, and operating procedure for the DeviceNet Communications Unit. Be sure to heed the following points when using the DeviceNet Communications Unit.

- The DeviceNet Communications Unit must be handled by personnel who have a sufficient knowledge of electrical systems.
- Please read this manual carefully and be sure that you understand the information provided before attempting to operate the DeviceNet Communications Unit.
- Keep this manual close at hand for reference during operation.

## ***Visual Aids***

The following headings appear in the left column of the manual to help you locate different types of information.

**Note** Indicates information of particular interest for efficient and convenient operation of the product.

**1,2,3...** 1. Indicates lists of one sort or another, such as procedures, checklists, etc.

## **© OMRON, 2008**

All rights reserved. No part of this publication may be reproduced, stored in a retrieval system, or transmitted, in any form, or by any means, mechanical, electronic, photocopying, recording, or otherwise, without the prior written permission of OMRON.

No patent liability is assumed with respect to the use of the information contained herein. Moreover, because OMRON is constantly striving to improve its high-quality products, the information contained in this manual is subject to change without notice. Every precaution has been taken in the preparation of this manual. Nevertheless, OMRON assumes no responsibility for errors or omissions. Neither is any liability assumed for damages resulting from the use of the information contained in this publication.

## Read and Understand this Manual

Please read and understand this manual before using the product. Please consult your OMRON representative if you have any questions or comments.

## Warranty and Limitations of Liability

### WARRANTY

OMRON's exclusive warranty is that the products are free from defects in materials and workmanship for a period of one year (or other period if specified) from date of sale by OMRON.

OMRON MAKES NO WARRANTY OR REPRESENTATION, EXPRESS OR IMPLIED, REGARDING NON-INFRINGEMENT, MERCHANTABILITY, OR FITNESS FOR PARTICULAR PURPOSE OF THE PRODUCTS. ANY BUYER OR USER ACKNOWLEDGES THAT THE BUYER OR USER ALONE HAS DETERMINED THAT THE PRODUCTS WILL SUITABLY MEET THE REQUIREMENTS OF THEIR INTENDED USE. OMRON DISCLAIMS ALL OTHER WARRANTIES, EXPRESS OR IMPLIED.

### LIMITATIONS OF LIABILITY

OMRON SHALL NOT BE RESPONSIBLE FOR SPECIAL, INDIRECT, OR CONSEQUENTIAL DAMAGES, LOSS OF PROFITS OR COMMERCIAL LOSS IN ANY WAY CONNECTED WITH THE PRODUCTS, WHETHER SUCH CLAIM IS BASED ON CONTRACT, WARRANTY, NEGLIGENCE, OR STRICT LIABILITY.

In no event shall the responsibility of OMRON for any act exceed the individual price of the product on which liability is asserted.

IN NO EVENT SHALL OMRON BE RESPONSIBLE FOR WARRANTY, REPAIR, OR OTHER CLAIMS REGARDING THE PRODUCTS UNLESS OMRON'S ANALYSIS CONFIRMS THAT THE PRODUCTS WERE PROPERLY HANDLED, STORED, INSTALLED, AND MAINTAINED AND NOT SUBJECT TO CONTAMINATION, ABUSE, MISUSE, OR INAPPROPRIATE MODIFICATION OR REPAIR.

## Application Considerations

### SUITABILITY FOR USE

OMRON shall not be responsible for conformity with any standards, codes, or regulations that apply to the combination of products in the customer's application or use of the products.

At the customer's request, OMRON will provide applicable third party certification documents identifying ratings and limitations of use that apply to the products. This information by itself is not sufficient for a complete determination of the suitability of the products in combination with the end product, machine, system, or other application or use.

The following are some examples of applications for which particular attention must be given. This is not intended to be an exhaustive list of all possible uses of the products, nor is it intended to imply that the uses listed may be suitable for the products:

- Outdoor use, uses involving potential chemical contamination or electrical interference, or conditions or uses not described in this manual.
- Nuclear energy control systems, combustion systems, railroad systems, aviation systems, medical equipment, amusement machines, vehicles, safety equipment, and installations subject to separate industry or government regulations.
- Systems, machines, and equipment that could present a risk to life or property.

Please know and observe all prohibitions of use applicable to the products.

NEVER USE THE PRODUCTS FOR AN APPLICATION INVOLVING SERIOUS RISK TO LIFE OR PROPERTY WITHOUT ENSURING THAT THE SYSTEM AS A WHOLE HAS BEEN DESIGNED TO ADDRESS THE RISKS, AND THAT THE OMRON PRODUCTS ARE PROPERLY RATED AND INSTALLED FOR THE INTENDED USE WITHIN THE OVERALL EQUIPMENT OR SYSTEM.

### PROGRAMMABLE PRODUCTS

OMRON shall not be responsible for the user's programming of a programmable product, or any consequence thereof.

## Disclaimers

### **CHANGE IN SPECIFICATIONS**

Product specifications and accessories may be changed at any time based on improvements and other reasons.

It is our practice to change model numbers when published ratings or features are changed, or when significant construction changes are made. However, some specifications of the products may be changed without any notice. When in doubt, special model numbers may be assigned to fix or establish key specifications for your application on your request. Please consult with your OMRON representative at any time to confirm actual specifications of purchased products.

### **DIMENSIONS AND WEIGHTS**

Dimensions and weights are nominal and are not to be used for manufacturing purposes, even when tolerances are shown.

### **PERFORMANCE DATA**

Performance data given in this manual is provided as a guide for the user in determining suitability and does not constitute a warranty. It may represent the result of OMRON's test conditions, and the users must correlate it to actual application requirements. Actual performance is subject to the OMRON Warranty and Limitations of Liability.

### **ERRORS AND OMISSIONS**

The information in this document has been carefully checked and is believed to be accurate; however, no responsibility is assumed for clerical, typographical, or proofreading errors, or omissions.

# Safety Precautions

## ■ Notation and Definitions for Precautionary Information

The following notation is used in this manual to provide precautions required to ensure safe usage of the DeviceNet Communications Unit. The safety precautions that are provided here are extremely important to safety. Always read and heed information provided in all safety precautions.

The following notation is used.

### Definitions of Warning and Caution







Indicates a potentially hazardous situation which, if not avoided, is likely to result in slight or moderate injury or occasionally, death or serious injury. And serious property damage may occur as well.









Indicates a potentially hazardous situation which, if not avoided, is likely to result in minor or moderate injury or property damage.

## ■ Symbols

Symbol		Meaning
Caution		<b>General Caution</b> Indicates non-specific general cautions, warnings, and dangers.
		<b>Electrical Shock Caution</b> Indicates possibility of electric shock under specific conditions.
Prohibition		<b>General Prohibition</b> Indicates non-specific general prohibitions.
Mandatory Caution		<b>General Caution</b> Indicates non-specific general cautions, warnings, and dangers.

## Warnings and Cautions

 <b>WARNING</b>	
<p>Never use the product without installing protective circuit in network. Doing so may possibly cause abnormal operation, and result in serious injury, property damage, or accident. To operate your total system safely even if any equipment failure occurs, or any trouble is caused by an external element, be sure to configure an external-control-circuit that consists of emergency stop, interlock and limit circuits to provide double or triple safeguard.</p>	

 <b>CAUTION</b>	
<p>Do not touch the terminals while power is being supplied. Doing so may occasionally result in minor injury due to electric shock.</p>	
<p>Use a power supply unit that complies with the reinforced insulation specified in IEC 60604 for the EJ1. If non-compliant power supply units are used, electric shock may occasionally result in minor injury.</p>	
<p>Do not allow pieces of metal, wire clippings, or fine metallic chips generated during installation to enter the product. Doing so may occasionally result in electric shock, fire, or malfunction.</p>	
<p>Do not use the product where subject to flammable or explosive gas. Otherwise, minor injury from explosion may occasionally occur.</p>	
<p>Never disassemble, modify, or repair the product or touch any of the internal parts. Minor electric shock, fire, or malfunction may occasionally occur.</p>	
<p>If screws are loosened, fire may occasionally occur. Tighten the fixing screws for connector with the torque of 0.25 to 0.30 N·m as specified.</p>	
<p>When changing the program by using online edit, an unexpected actuation may occasionally result in minor or moderate injury or property damage. Make sure that the product is not affected by prolonged cycle time on DeviceNet before using online edit.</p>	
<p>When transferring a program to another node, or changing I/O memory, an unexpected actuation may occasionally result in minor or moderate injury or property damage. Before doing these operations, make sure that the node to be changed is in appropriate status.</p>	



## Precautions for Safe Use

- 1) The product is designed for indoor use only. Do not use the product outdoors or in any of the following locations.
  - Places directly subject to heat radiated from heating equipment.
  - Places subject to splashing liquid or oil atmosphere.
  - Places subject to direct sunlight.
  - Places subject to dust or corrosive gas (in particular, sulfide or ammonia gas)
  - Places subject to intense temperature change.
  - Places subject to icing or condensation.
  - Places subject to vibration or strong shocks.
- 2) Use and store the product within the rated temperature and humidity ranges. Provide forced-cooling if required.
- 3) To allow heat to escape, do not block the area around the temperature controller. Also, do not block its ventilation holes.
- 4) Be sure to wire properly with correct polarity of terminals.
- 5) Use crimped terminals of specified sizes (M3, width: 5.8 mm or less) for wiring. To connect bare wires to the terminal block, use wires with a gage of AWG22 to AWG14 (cross-sectional area: 0.326 mm<sup>2</sup> to 2.081 mm<sup>2</sup>). For wirings other than power supply, use wires with a gage of AWG28 to AWG14 (cross-sectional area: 0.081 mm<sup>2</sup> to 1.309 mm<sup>2</sup>). (The stripping length: 6 to 8 mm).
- 6) Do not wire terminals that do not have an identified use.
- 7) Secure as much space as possible between the product and devices that generates a strong high-frequency or surge. Separate the high-voltage or large-current power lines from other lines, and avoid parallel or common wiring with the power lines when you are wiring to the terminals.
- 8) Use the product within the rated load and power supply voltage.
- 9) Make sure that the rated voltage is attained within 2 s of turning ON the power.
- 10) The switch or circuit breaker must be located within an easy reach of the operator, and must be marked as a disconnecting means for this unit.
- 11) Do not use paint thinner or similar chemical to clean with. Use standard grade alcohol.
- 12) Never touch the electric components, connectors, or patterns in the product with bare hands. Always hold the product by its enclosure. Inappropriate handling of the product may occasionally damage internal components due to static electricity.
- 13) Use a switch, relay, or other device for turning OFF the power supply quickly. Gradually lowering the voltage of the power supply may result in incorrect outputs or memory errors.
- 14) Connect only the specified number of products in only a specified configuration.
- 15) Mount the product to a DIN Rail mounted vertically to the ground.
- 16) Always turn OFF the power before wiring, replacing the product, or changing the configuration.
- 17) Before installing the product, attach the enclosed cover seal to the connector opening on the left end of the product.
- 18) Make sure that the data transfer distance for DeviceNet is within the specified range, and use the specified cable only. Also, refer to this manual for specifications including appropriate data transfer distance and cable.
- 19) Do not bend or pull data transfer cable for DeviceNet forcibly.
- 20) Turn OFF the DeviceNet before connecting/disconnecting connectors. Not doing so may result in equipment failure or malfunction.

## Precautions for Correct Use

### ● Installation

- 1) Connect the DeviceNet Communications Unit to the left side of a Basic Unit or an End Unit.
- 2) The EJ1 cannot be used linked to a CJ-series PLC.

### ● Service Life

- 1) Use the product within the following temperature and humidity ranges.  
Temperature:  $-10$  to  $55^{\circ}\text{C}$  (with no icing or condensation)  
Humidity: 25% to 85%

When the Temperature Controller is incorporated in a control panel, make sure that the controller's ambient temperature and not the panel's ambient temperature does not exceed  $55^{\circ}\text{C}$ .

- 2) The service life of electronic devices like the Temperature Controller is determined by the service life of internal electronic components. Component service life is affected by the ambient temperature: the higher the temperature, the shorter the service life and the lower the temperature, the longer the service life. Therefore, the service life can be extended by lowering the temperature of the Temperature Controller.
- 3) Mounting two or more Temperature Controllers side by side, or mounting Temperature Controllers above each other may cause heat to build up inside the Temperature Controllers, which will shorten their service life. If the Temperature Controllers are mounted above each other or side by side, use forced cooling by fans or other means of air ventilation to cool down the Temperature Controllers. However, be sure not to cool only the terminals. Doing so will result in measurement errors.

### ● Precautions for Operation

- 1) It takes a certain amount of time for the outputs to turn ON from after the power supply is turned ON. Due consideration must be given to this time when designing control panels, etc.
- 2) It takes 30 minutes from the time the product is turned ON until the correct temperature is indicated. Always turn ON the power supply at least 30 minutes before starting temperature control.
- 3) Avoid using the Temperature Controller near a radio, television set, or other wireless device. Its use would result in reception disturbance.

## Preparations for Use

Be sure to thoroughly read and understand the manual provided with the product, and check the following points.

Timing	Check point	Details
Purchasing the product	Product appearance	After purchase, check that the product and packaging are not dented or otherwise damaged. Damaged internal parts may prevent optimum control.
	Product model and specifications	Make sure that the purchased product meets the required specifications.
Setting the Unit	Product installation location	Provide sufficient space around the product for heat dissipation. Do not block the vents on the product.
Wiring	Terminal wiring	Do not subject the terminal screws to excessive stress (force) when tightening them. Make sure that there are no loose screws after tightening terminal screws to the specified torque of 0.25 to 0.30 N·m. Be sure to confirm the polarity for each terminal before wiring the terminal block and connectors.
	Power supply inputs	Wire the power supply inputs correctly. Incorrect wiring will result in damage to the internal circuits.
Operating environment	Ambient temperature	The ambient operating temperature for the product is –10 to 55°C (with no condensation or icing). To extend the service life of the product, install it in a location with an ambient temperature as low as possible. In locations exposed to high temperatures, if necessary, cool the products using a fan or other cooling method.
	Vibration and shock	Check whether the standards related to shock and vibration are satisfied at the installation environment. (Install the product in locations where the conductors will not be subject to vibration or shock.)
	Foreign particles	Install the product in a location that is not subject to liquid or foreign particles entering the product. If sulfide, chlorine, or other corrosive gases are present, remove the source of the gas, install a fan, or use other countermeasures to protect the product.

### ■ EC Directives

- EMC Directives
- Low Voltage Directive

### Concepts

#### **EMC Directives**

OMRON devices that comply with EC Directives also conform to the related EMC standards so that they can be more easily built into other devices or the overall machine. The actual products have been checked for conformity to EMC standards. Whether the products conform to the standards in the system used by the customer, however, must be checked by the customer.

EMC-related performance of the OMRON devices that comply with EC Directives will vary depending on the configuration, wiring, and other conditions of the equipment or control panel on which the OMRON devices are installed. The customer must, therefore, perform the final check to confirm that devices and the overall machine conform to EMC standards.

## Conformance to EC Directives

The EJ1 DeviceNet Communications Unit complies with EC Directives. To ensure that the machine or device in which the Unit is used complies with EC Directives, the Unit must be installed as follows:

- 1,2,3...**
1. The Unit must be installed within a control panel.
  2. You must use reinforced insulation or double insulation for the DC power supplies used for the communications power supply, internal power supply, and I/O power supplies.
  3. Units complying with EC Directives also conform to the Common Emission Standard (EN50081-2). Radiated emission characteristics (10-m regulations) may vary depending on the configuration of the control panel used, other devices connected to the control panel, wiring, and other conditions. You must therefore confirm that the overall machine or equipment complies with EC Directives.
  4. The Unit is a Class A product (products for industrial environments). In residential environment areas it may cause radio interference, in which case the user may be required to take adequate measures to reduce interference.

The following example shows one means of reducing noise.

- 1,2,3...**
1. Noise from the communications cable can be reduced by installing a ferrite core on the communications cable within 10 cm of the DeviceNet Unit.

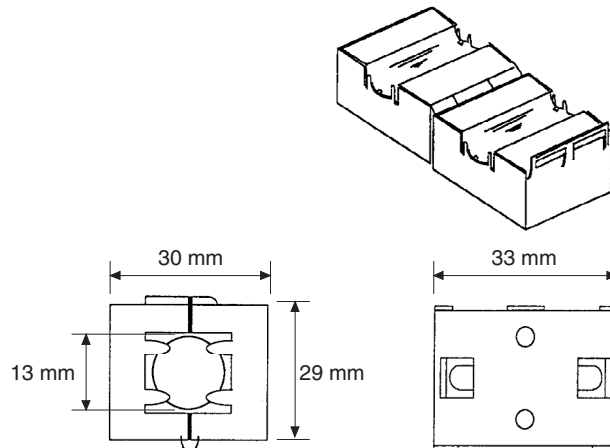

Ferrite Core (Data Line Filter): 0443-164151 (manufactured by Fair-Rite Products Co., Ltd.)

Impedance specifications

25 MHz: 105  $\Omega$

100 MHz: 190  $\Omega$

30 mm

13 mm

29 mm

33 mm

2. Wire the control panel with as thick and short electric lines as possible and ground to 100  $\Omega$  min.
3. Keep DeviceNet communications cables as short as possible and ground to 100  $\Omega$  min.

## Related Manuals

The manuals related to the EJ1 DeviceNet Communications Unit are configured as shown in the following tables. Refer to these manuals as required.

### ■ EJ1

Name	Cat. No.	Contents
EJ1 EJ1N-HFU□-DRT DeviceNet Communications Unit Operation Manual	H155 (This manual)	Describes the following information on the DeviceNet Communications Unit. <ul style="list-style-type: none"> <li>• Overview and features</li> <li>• System configuration</li> <li>• Mounting and wiring</li> <li>• Troubleshooting</li> </ul>
EJ1 EJ1N-TC2□ EJ1N-TC4□ EJ1C-EDU□ Modular Temperature Controller User's Manual	H142	Describes the following information on the EJ1. <ul style="list-style-type: none"> <li>• Overview and features</li> <li>• System configuration</li> <li>• Mounting and wiring</li> <li>• Troubleshooting</li> </ul>
CX-Thermo Ver. 4.□ (online help) EST2-2C-MV4	--- (Available only as online help.)	Describes how to set parameters and adjust devices (i.e., components such as Temperature Controllers) using the CX-Thermo.

### ■ DeviceNet Master Unit

Name	Cat. No.	Contents
DeviceNet Operation Manual	W267	Describes the configuration and construction of a DeviceNet network, including installation procedures and specifications for cables, connectors, and other connection devices, as well as information on the communications power supply.
DeviceNet Master Units Operation Manual	W379	Describes the models, specifications, functions, and application methods of C200HX/HG/HE, CVM1, and CV-series DeviceNet Master Units.
CS1 Series DeviceNet Unit Operation Manual	W380	Describes the models, specifications, functions, and application methods of the CS1-series DeviceNet Unit.

### ■ G3ZA Multi-channel Power Controller Manual

Name	Cat. No.	Contents
G3ZA G3ZA-4H203-FLK-UTU G3ZA-4H403-FLK-UTU G3ZA-8H203-FLK-UTU G3ZA-8H403-FLK-UTU Multi-channel Power Controller User's Manual	Z200	Provides an outline of and describes the features, installation, wiring, RS-485 serial communications settings, and basic function for the G3ZA Multi-channel Power Controller.

## ■ CS/CJ-series PLC Manuals

Name	Cat. No.	Contents
SYSMAC CS Series CS1G/H-CPU□□-EV1, CS1G/H-CPU□□H Programmable Controllers Operation Manual	W339	Provides an outlines of and describes the design, installation, maintenance, and other basic operations for the CS-series PLCs.
SYSMAC CJ Series CJ1G-CPU□□, CJ1M-CPU□□, CJ1G-CPU□□P, CJ1G/H-CPU□□H, NSJ□-□□□□(B)-G5D, NSJ□-□□□□(B)-M3D Programmable Controllers Operation Manual	W393	Provides an outlines of and describes the design, installation, maintenance, and other basic operations for the CJ-series PLCs.
SYSMAC CS/CJ Series CS1G/H-CPU□□-EV1, CS1G/H-CPU□□H, CS1D- CPU□□H, CS1D-CPU□□S, CJ1G-CPU□□, CJ1M- CPU□□, CJ1G-CPU□□P, CJ1G/H-CPU□□H, NSJ□-□□□□(B)-G5D, NSJ□-□□□□(B)-M3D Programmable Controllers Programming Manual	W394	Describes programming and other methods to use the functions of the CS/CJ-series PLCs.
SYSMAC CS/CJ Series CS1G/H-CPU□□-EV1, CS1G/H-CPU□□H, CS1D- CPU□□H, CS1D-CPU□□S, CJ1G-CPU□□, CJ1M- CPU□□, CJ1G-CPU□□P, CJ1G/H-CPU□□H, NSJ□-□□□□(B)-G5D, NSJ□-□□□□(B)-M3D Programmable Controllers Instructions Reference Manual	W340	Describes the ladder diagram programming instructions supported by CS/CJ-series PLCs.

## ■ Support Software Manuals

Name	Cat. No.	Contents
DeviceNet Configurator Ver. 2.□ Operation Manual	W382	Describes the operating procedures of the DeviceNet Configurator.
CXONE-AL□□C-EV3/AL□□D-EV3 CX-One Ver. 3.0 FA Integrated Tool Package Setup Manual	W463	Installation and overview of CX-One FA Integrated Tool Package.
CXONE-AL□□C-EV3/ CXONE-AL□□D-EV3 CX-Integrator Ver. 3.0 Operation Manual	W464	Describes operating procedures for the CX-Integrator Network Configuration Tool for CS-, CJ-, CP-, and NSJ-series Controllers.
SYSMAC WS02-CXPC1-E-V70 CX-Programmer Operation Manual	W446	Provides information on how to use the CX-Programmer for all functionality except for function blocks.

# Meanings of Abbreviations and Terms

The following abbreviations and terms are used in this manual.

Abbreviation or term	Meaning
AT	Autotuning
EDU	EJ1 End Unit
EU	Engineering unit (See note.)
HB	Heater burnout
HS	Heater short
LBA	Loop burn alarm
LSP	Local SP
OC	Heater overcurrent
PV	Process value
RSP	Remote SP
SP	Set point
TC4/TC2	EJ1 Basic Unit <ul style="list-style-type: none"> <li>• TC4: Four-channel Basic Unit</li> <li>• TC2: Two-channel Basic Unit</li> </ul>
Temperature Controller	EJ1 Basic Unit listed above (TC4 or TC2)
Configurator	Device to perform system setup and other functions. Includes functions for reading ID data, reading and writing parameters, and displaying network configurations. The DeviceNet Configurator and the CX-Integrator (with the same screen configuration as the DeviceNet Configurator) are available for Units manufactured by OMRON.
word (CIO)	Words allocated in the CIO Areas of the CPU Unit of the PLC.
channel (ch)	Number of control loops for a Temperature Controller.
communications unit number	An identification number for a Temperature Controller connected to a DeviceNet Communications Unit. (Set using both rotary switch 1 and DIP switch pin 2.)
unit number as a CPU Bus Unit	The unit number of a DeviceNet Master Unit in the PLC. (Unit numbers are used as identification numbers for CPU Bus Units.)

**Note** “EU” stands for Engineering Unit. EU is used as the minimum unit for engineering units such as °C, m, and g. The size of EU varies according to the input type. For example, when the input temperature setting range is –200 to +1300°C, 1 EU is 1°C, and when the input temperature setting range is –20.0 to +500.0°C, 1 EU is 0.1°C. For analog inputs, the size of EU varies according to the decimal point position of the scaling setting, and 1 EU becomes the minimum scaling unit.

# TABLE OF CONTENTS

## SECTION 1

<b>Overview</b> .....	<b>1</b>
1-1 Features and System Configuration .....	2
1-2 Specifications .....	9
1-3 Connecting Temperature Controllers .....	11
1-4 Initial Temperature Controller Settings .....	13

## SECTION 2

<b>Operating Procedures</b> .....	<b>15</b>
2-1 Setup Procedure .....	16
2-2 Startup Procedure .....	17

## SECTION 3

<b>Parts, Installation, and Wiring</b> .....	<b>21</b>
3-1 Part Names and Functions .....	22
3-2 Installation .....	27
3-3 DeviceNet Communications Cables Wiring .....	30
3-4 Wiring the Temperature Controllers .....	33

## SECTION 4

<b>Remote I/O Communications</b> .....	<b>35</b>
4-1 Allocation Method Overview .....	36
4-2 Simple I/O Allocation .....	40
4-3 Allocating I/O from the Configurator .....	45
4-4 Expansion Remote I/O .....	68
4-5 Allocating Data in the Master .....	73
4-6 Ladder Programming Examples .....	78

## SECTION 5

<b>Operations from the Configurator</b> .....	<b>83</b>
5-1 List of Operations from the Configurator .....	84
5-2 Operations from the Edit Device Parameters Window .....	85
5-3 Maintenance Mode Window .....	97
5-4 DeviceNet Communications Unit Monitor .....	102

## SECTION 6

<b>Explicit Message Communications</b> .....	<b>103</b>
6-1 Overview of Explicit Message Communications .....	104
6-2 Sending CompoWay/F Commands to a Temperature Controller .....	108
6-3 Examples Using CompoWay/F Commands .....	112
6-4 Example of Sending Explicit Messages .....	118
6-5 Sending Explicit Messages .....	119



# TABLE OF CONTENTS

## SECTION 7

<b>Communications Performance</b> .....	<b>125</b>
7-1 Remote I/O Communications Characteristics .....	126
7-2 Message Communications Characteristics .....	134

## SECTION 8

<b>Troubleshooting and Maintenance</b> .....	<b>137</b>
8-1 Indicators and Error Processing .....	138
8-2 Maintenance .....	139

## Appendices

A Connecting to a Master from Another Company .....	145
B Allocation Numbers for Configurators Manufactured by Other Companies .....	151
C List of Connectable Devices .....	169

<b>Index</b> .....	<b>173</b>
--------------------	------------

<b>Revision History</b> .....	<b>177</b>
-------------------------------	------------

## About this Manual:

This manual describes the installation and operation of the EJ1 DeviceNet Communications Unit for EJ1 Temperature Controllers and includes the sections described below.

Please read this manual carefully and be sure you understand the information provided before attempting to install or operate the EJ1 DeviceNet Communications Unit. Be sure to read the precautions provided in the following section.

**Precautions** provides general precautions for using the EJ1 DeviceNet Communications Unit, Programmable Controller, and related devices.

**Section 1** introduces the features and system configuration of the EJ1 DeviceNet Communications Unit, the types of EJ1 Temperature Controller that can be used, and other basic information.

**Section 2** outlines the basic operating procedures of the EJ1 DeviceNet Communications Unit.

**Section 3** describes the methods used to install and wire the EJ1 DeviceNet Communications Unit and the EJ1 Temperature Controller. The settings of DeviceNet Communications Unit switches are also described.

**Section 4** describes the input (IN) areas and output (OUT) areas that EJ1 DeviceNet Communications Units can use for remote I/O communications. The methods to allocate data for master communications are also described.

**Section 5** describes the DeviceNet Configurator operations that can be used for the EJ1 DeviceNet Communications Unit except for allocation procedures, which are described in *SECTION 4 Remote I/O Communications*.

**Section 6** describes how to send explicit messages to the EJ1 DeviceNet Communications Unit, including how to send CompoWay/F commands using explicit messages. CompoWay/F commands are supported by the EJ1 Temperature Controller.

**Section 7** provides information on the time required for a complete communications cycle, for an output response to be made to an input, to start the system, and to send messages.

**Section 8** describes error processing, periodic maintenance operations, and troubleshooting procedures needed to keep the DeviceNet Network operating properly. Details on resetting replaced Units are also provided. Read through the error processing procedures in both this manual and the operation manual for the DeviceNet master being used before operation so that operating errors can be identified and corrected more quickly.

The **Appendices** provide the handling methods for EDS setting files required for multivendor environments, the device profile of the EJ1 DeviceNet Communications Unit, and information on related products.

 **WARNING** Failure to read and understand the information provided in this manual may result in personal injury or death, damage to the product, or product failure. Please read each section in its entirety and be sure you understand the information provided in the section and related sections before attempting any of the procedures or operations given.



# SECTION 1

## Overview

This section introduces the features and system configuration of the EJ1 DeviceNet Communications Unit, the types of EJ1 Temperature Controller that can be used, and other basic information.

1-1	Features and System Configuration .....	2
1-1-1	Features .....	2
1-1-2	Overview of Unit Communications Functions .....	4
1-1-3	System Configuration .....	7
1-2	Specifications .....	9
1-2-1	DeviceNet Communications Specifications .....	9
1-2-2	Function and Performance Specifications .....	10
1-2-3	General Specifications .....	11
1-3	Connecting Temperature Controllers .....	11
1-3-1	Temperature Controller ID and Number of Connectable Units .....	11
1-3-2	Temperature Controller Communications .....	12
1-3-3	Temperature Controller Models .....	12
1-3-4	Temperature Controller Power Supply .....	12
1-3-5	Temperature Controller Registration .....	12
1-4	Initial Temperature Controller Settings .....	13

## 1-1 Features and System Configuration

### 1-1-1 Features

The DeviceNet Communications Unit enables a DeviceNet master to communicate with multiple EJ1 Temperature Controllers through the DeviceNet to monitor their process values, write parameters, and control operation.

#### Using DeviceNet Functions

##### **Simultaneously Managing Multiple Temperature Controllers from the Master**

Up to 16 Temperature Controllers can be connected to a single DeviceNet Communications Unit. The DeviceNet Communications Unit is connected to the master as a DeviceNet slave. Up to 63 slaves can be connected to a single master, so multiple DeviceNet Communications Units and other types of slaves can be managed as part of the same system.

##### **Remote I/O Communications**

The master and DeviceNet Communications Units can share I/O by using remote I/O communications. Data in the EJ1 Temperature Controllers, such as process values (PVs) and set points (SPs), can be allocated for communications with the master to enable sending and receiving the allocated data via remote I/O communications, without requiring special programming.

- Remote I/O Communications without a Configurator  
Using the DeviceNet Communications Unit, basic Temperature Controller data can be allocated for communications with the master, such as process values (PVs) and set points (SPs), without requiring a Configurator. This is called "simple I/O allocation." Simple I/O allocation can be easily set from the DIP switch of the DeviceNet Communications Unit.
- User-set Data Allocations with a Configurator  
The specific data required for communications with the master can also be allocated by using I/O allocations from the Configurator.

##### **Expansion Remote I/O to Enable Using More Than 100 Words of Parameters**

Expansion remote I/O can be used to read and write parameters. Specific parameters allocated in I/O memory of the master can be switched to a variety of parameters by using memory operations. This function enables manipulating more than 100 words of parameters. Even if the number of parameters to be read and written increases, modifications can be handled simply by changing operations in the memory of the master.

##### **Explicit Message Communications**

By executing commands from the PLC, various operations can be performed, including reading/writing specific parameters, such as reading process values or writing set points, and performing operations using operation commands. CompoWay/F communications commands can also be executed using explicit message communications.

##### **Setting, Monitoring, and Operating the Temperature Controller from the Configurator**

The Configurator (Ver. 2.2 or higher) or CX-Integrator (Ver. 2.2 or higher) can be used to create the device parameters for the DeviceNet Communications Unit, including settings for the DeviceNet Communications Unit and setting for the Temperature Controllers. The Configurator can then be used to download the parameters together to the DeviceNet Communications Unit and Temperature Controllers. (See note.)

The Configurator can also be used to monitor Temperature Controller process values, and execute operation commands for the Temperature Controllers. The Configurator can be used to copy parameters between Temperature Controller channels, allowing the initial parameters of Temperature Controllers requiring the same or similar parameters to be easily set.

**Automatically Detects Baud Rate**

Previously, the baud rate had to be set for each slave, but the DeviceNet Communications Unit automatically detects and matches the baud rate of the master, so this setting is not required. (If the master's baud rate is changed, turn OFF the communications power supply to the DeviceNet Communications Unit and then turn it ON again.)

**Wide Range of Maintenance Functions****Copy Function (Uploading or Downloading Temperature Controller Parameters)**

Parameters for all Temperature Controllers connected to the DeviceNet Communications Unit can be uploaded or downloaded together. (The parameters that have been read are stored in the DeviceNet Communications Unit except for bank parameters and G3ZA parameters.) When Temperature Controllers are replaced, the new Controllers can be easily reset onsite without using a Configurator.

**Monitoring Network Power Voltage**

The DeviceNet network communications power voltage values (present value, peak value, and bottom value) can be stored in the DeviceNet Communications Unit, and the recorded voltages can be read from the Configurator. By setting the voltage monitor value in the DeviceNet Communications Unit, notification will be sent to the master if the voltage level drops below the monitor value.

**Monitoring the Unit Conduction Time**

The conduction time of the DeviceNet Communications Unit's internal circuit power supply can be recorded. The recorded conduction time can be read from the Configurator or using explicit messages. By setting a monitor value for the conduction time in the DeviceNet Communications Unit, notification will be sent to the master when the total time exceeds the monitor value.

**Unit Comments**

Any name can be set for a DeviceNet Communications Unit and recorded in the Unit. Specifying names enables the user to easily differentiate the applications of the DeviceNet Communications Units when setting and monitoring them from the Configurator.

**Setting Temperature Controller Comments**

A name can be set for each Temperature Controller channel connected to the DeviceNet Communications Unit and recorded in the DeviceNet Communications Unit. Specifying names enables the user to easily differentiate the function of each channel when setting and monitoring them from the Configurator.

**Monitoring Communications Error History**

The error status for the last four communications errors (the causes and communications power voltage when the communications error occurred) can be recorded in the DeviceNet Communications Unit. The recorded communications error history can be read from the Configurator.

**Monitoring Temperature Controller Power Status**

The power supply to the Temperature Controllers can be monitored to confirm that power is ON and send notification of the status to the master. (The power status can be checked for Temperature Controllers connected to the DeviceNet Communications Unit only.) The power status of the Temperature Controllers can be read from the Configurator or using explicit messages.

**Monitor Temperature Controller Conduction Time and RUN Time**

The conduction time of the Temperature Controller's internal circuit power supply or the RUN time of the Temperature Controller can be totaled and recorded. (Select whether to total the conduction time or RUN time by setting the monitor mode.) The recorded total time can be read using the Configurator or explicit messages. By setting a monitor value in the DeviceNet Communications Unit, notification will be sent to the master if the Unit conduction time exceeds the monitor value.

### 1-1-2 Overview of Unit Communications Functions

#### Remote I/O Communications

DeviceNet Communications Unit data is shared with the master's IN Area and OUT Area through DeviceNet. Up to 100 words (200 bytes) each can be used as the IN Area and OUT Area for the DeviceNet Communications Unit. (The first word (two bytes) of the OUT Area is always allocated for the OUT Enable Bit).

The IN Area is allocated for data such as the communications status and the process values of the Temperature Controller channels and the OUT Area is allocated for the set points of the channels and other data.

When using a CS/CJ-series DeviceNet Unit as the master, the IN Area can be divided into two areas. One is normally used for input data (such as Temperature Controller process values), and the other can be used for reading status (such as Temperature Controller status). Even when the IN Area is divided into two areas, however, the total number of words that can be used for the IN Area is still 100 words (200 bytes).

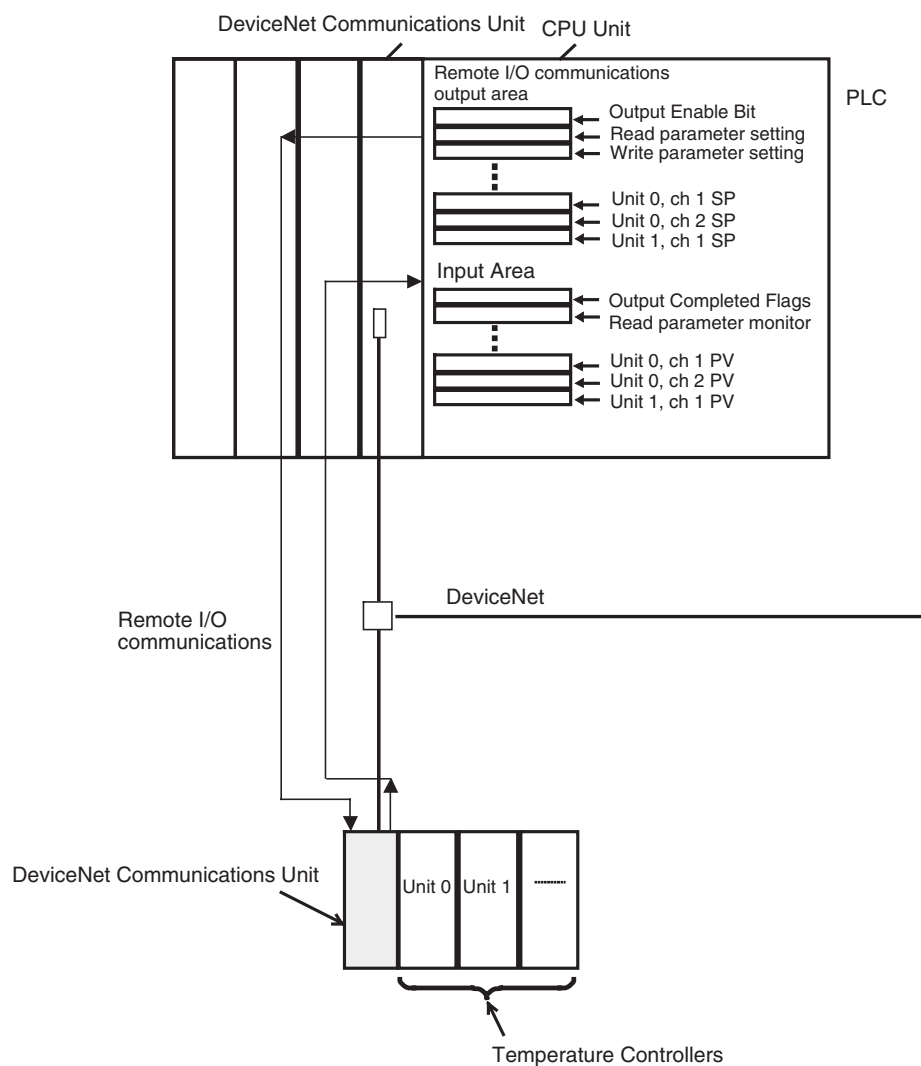

**Explicit Message Communications**

Explicit message commands can be sent from the master to the DeviceNet Communications Unit to read or write the parameters of the connected Temperature Controllers. CompoWay/F communications commands that were previously used for Temperature Controllers can also be sent (in explicit message format).

The DeviceNet Communications Unit's own parameters can also be read or written.

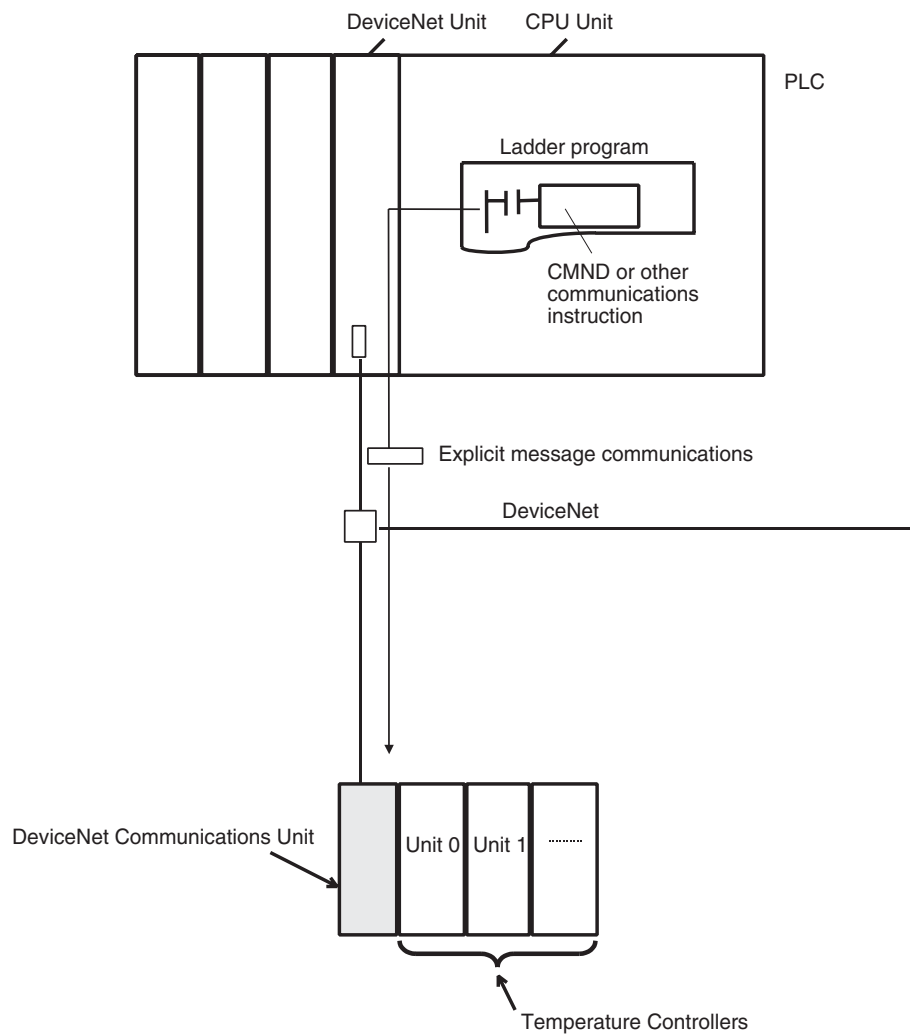



### Transferring, Monitoring, and Operating from the Configurator

Any of the Temperature Controller parameters can be read or written from a personal computer using the Configurator (Ver. 2.44 or higher) or CX-Integrator (Ver. 2.2 or higher) and then saved as a file.

The setup parameters for each Temperature Controller channel can be copied, allowing the same or similar settings to be easily set for multiple Temperature Controllers.

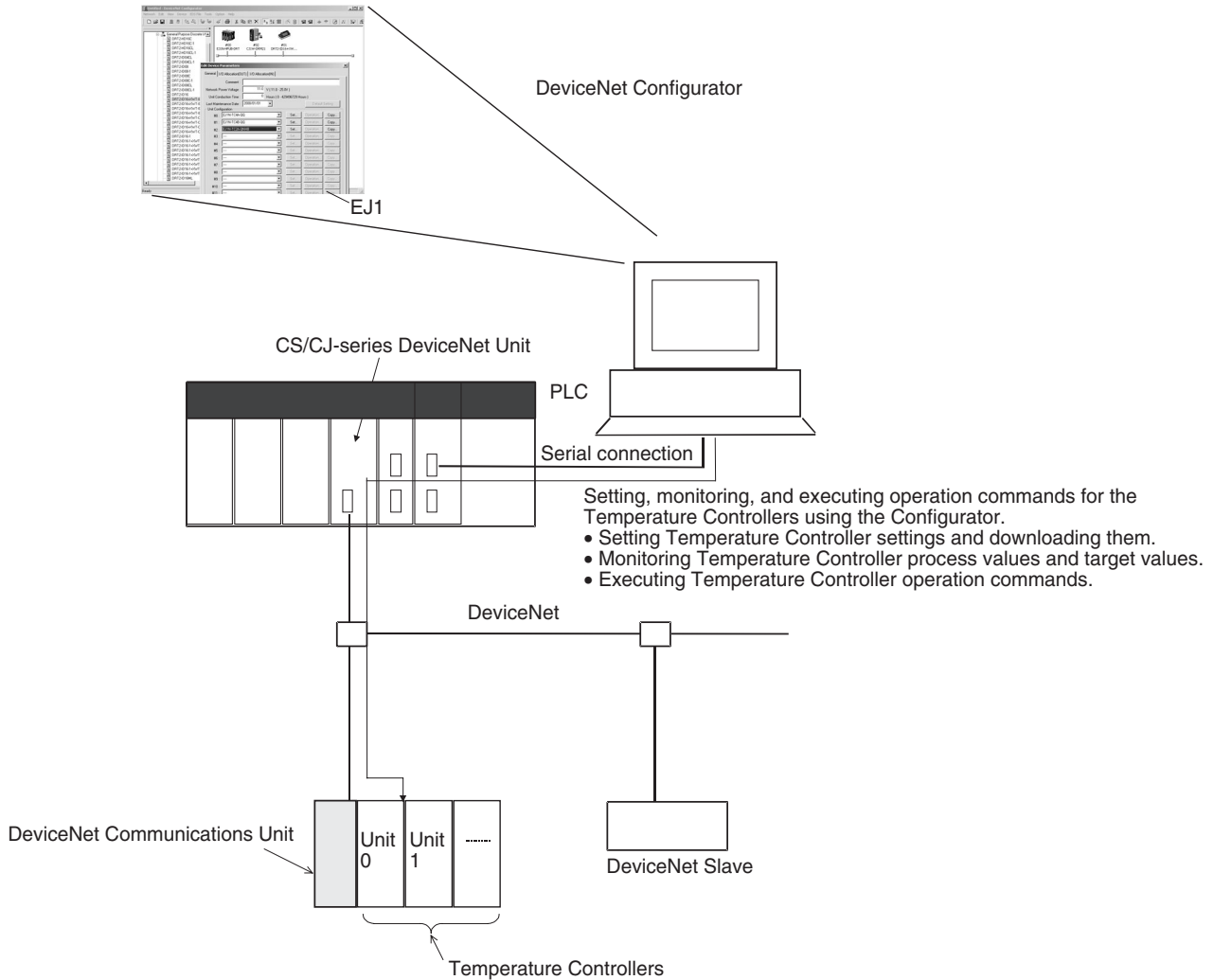

### 1-1-3 System Configuration

#### Basic Configuration

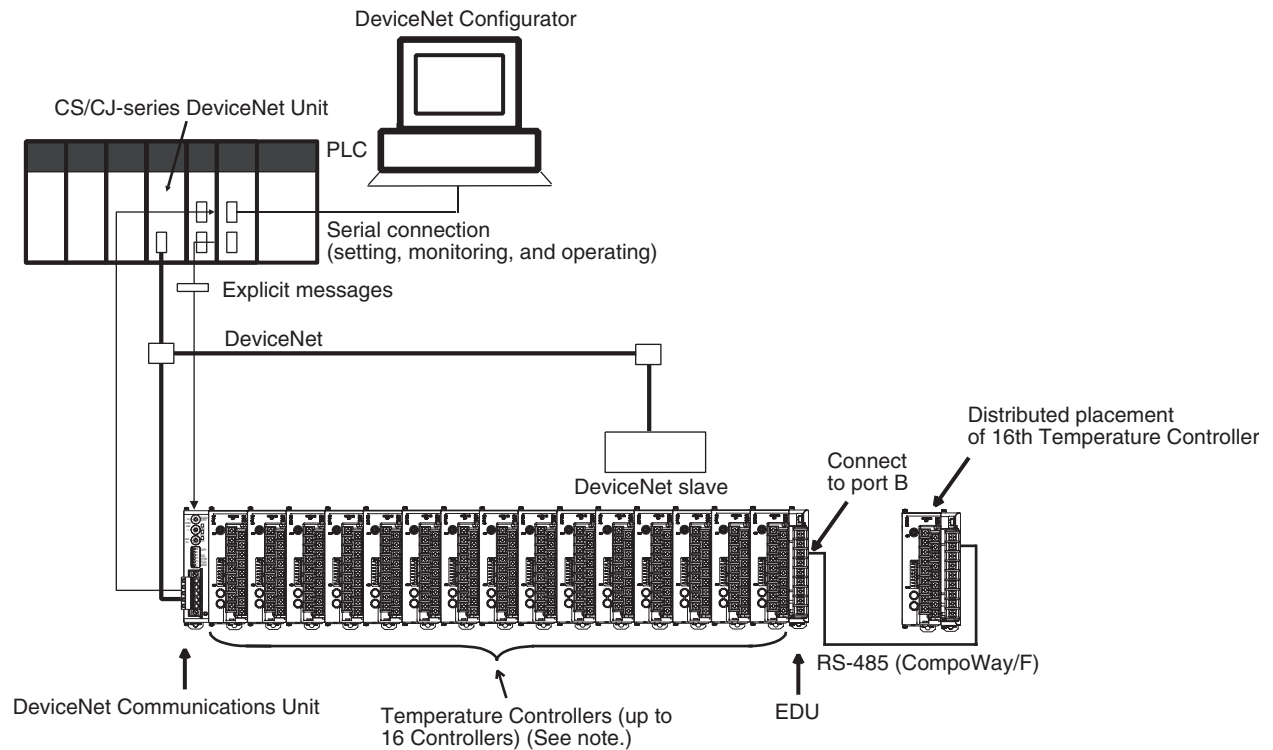

Note: Up to 16 Temperature Controllers can be connected to one DeviceNet Communications Unit. Use distributed placement via RS-485 for the 16th Temperature Controller.

Connect the master to the DeviceNet Communications Unit, and connect the DeviceNet Communications Unit to the Temperature Controllers.

The DeviceNet Communications Unit shares I/O with the master as a DeviceNet slave, and can send data to and receive data from the master using explicit messages.

Up to 63 slaves can be connected to a single master. Up to 16 Temperature Controllers can be connected to a single DeviceNet Communications Unit.

**Note** Always connect the DeviceNet Communications Unit to the Temperature Controllers on the left end of the block.

**Distributed Placement**

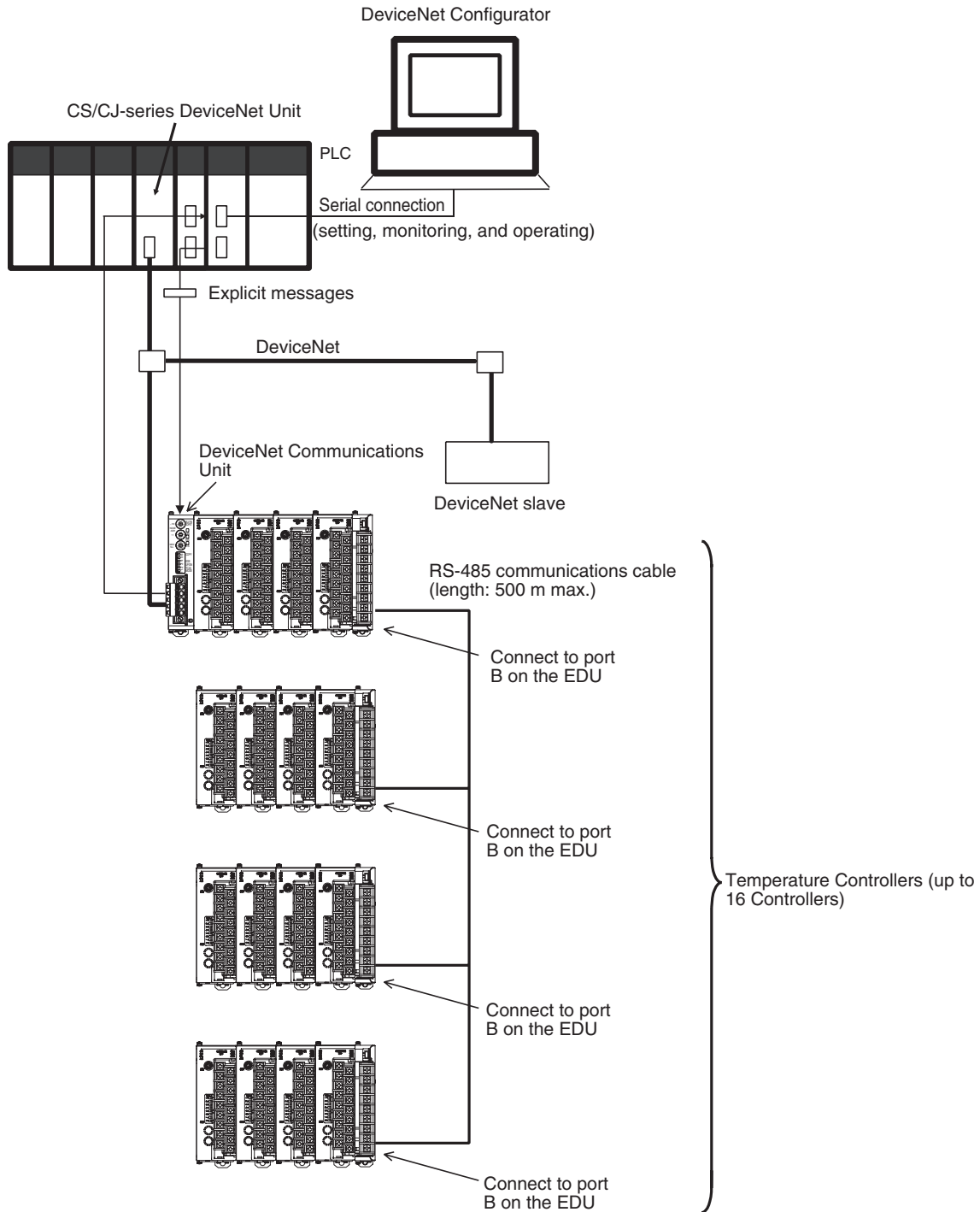

Connect the master and DeviceNet Communications Unit to port B (RS-485) of each End Unit.

The total cable length for RS-485 communications can be up to 500 m, so Temperature Controllers located at a distance can be operated using a single DeviceNet Communications Unit.

Up to 63 slaves can be connected to a single master. Up to 16 Temperature Controllers total for all blocks can be connected to a single DeviceNet Communications Unit.

Terminating resistance of 100 to 125 Ω (1/2 W) must be connected to both ends of the RS-485 communications transmission path.

**Note** Connect the DeviceNet Communications Unit to the Temperature Controllers on the left end of any one of the blocks.

## 1-2 Specifications

### 1-2-1 DeviceNet Communications Specifications

Item		Specifications			
Communications protocol		Conforms to DeviceNet			
Communications functions	Remote I/O communications	<ul style="list-style-type: none"> <li>• Master-slave connections (polling, COS, or cyclic)</li> <li>• Conform to DeviceNet specifications.</li> </ul>			
	Simple I/O allocation	<ul style="list-style-type: none"> <li>• Allocates I/O data using switch settings only, without a Configurator.</li> <li>• I/O is allocated for Temperature Controller status, process values, set points, alarm output status, and other basic data only.</li> <li>• One block for IN Area, up to 86 words (words are allocated through the unit number set in the highest communications unit number setting)</li> <li>• One block for OUT Area, up to 74 words (words are allocated through the unit number set in the highest communications unit number setting)</li> </ul>			
	I/O allocations from the Configurator	<ul style="list-style-type: none"> <li>• Can be used to allocate any I/O data from the Configurator.</li> <li>• Can be used to allocate any data, such as parameters specific to the DeviceNet Communications Unit and the Temperature Controller variable area.</li> <li>• Up to 2 blocks for the IN Area, up to a total of 100 words. (See note 1.)</li> <li>• One block for OUT Area 1 block, up to 100 words (the first word is always allocated to the OUT Enable Bit). (See note 2.)</li> </ul>			
	Message communications	<ul style="list-style-type: none"> <li>• Explicit message communications</li> <li>• CompoWay/F communications commands can be sent (commands are sent in explicit message format).</li> </ul>			
	Setting, monitoring and controlling operations from the Configurator	<p>Supported by DeviceNet Configurator (using the Edit Parameters and Device Monitor functions of the DeviceNet Communications Unit and Temperature Controllers).</p> <ul style="list-style-type: none"> <li>• Used to set and monitor the DeviceNet Communications Unit.</li> <li>• Used to register connection configurations, make initial settings (see note 3), change settings, and monitor the Temperature Controllers.</li> <li>• Use to allocates data for master communications.</li> <li>• Used to allocates word in the IN and OUT Areas for specific data.</li> <li>• Used to sends operation commands to the Temperature Controllers.</li> </ul>			
Connection format		Combination of multidrop and T-branch connections (for trunk and drop lines)			
Baud rate		DeviceNet: 500, 250, or 125 kbps, or automatic detection of master baud rate			
Communications media		Special 5-wire cable (2 signal lines, 2 power lines, and 1 shield line)			
Communications distance		Baud rate	Network length	Drop line length	Total drop line length
		500 kbps	100 m max. (100 m max.)	6 m max.	39 m max.
		250 kbps	250 m max. (100 m max.)	6 m max.	78 m max.
		125 kbps	500 m max. (100 m max.)	6 m max.	156 m max.
		The values in parentheses apply when Thin Cables are used.			
Communications power supply		11 to 25 VDC			
Maximum number of nodes that can be connected		64 (includes Configurator when used.)			
Maximum number of slaves that can be connected		63			

Item	Specifications
Error control	CRC error detection
Power supply	Power supplied from DeviceNet communications connector (DeviceNet communications power supply and DeviceNet Communications Unit internal circuit power supply)

- Note**
1. When a CS/CJ-series DeviceNet Unit is used as the master, two blocks can be used for the IN Area (the connections can also be set). When a CVM1, CV-series, or C200HX/HG/HE DeviceNet Master Unit is used, the IN Area must be in 1 block, and up to 100 words (200 bytes) are allocated. (Only polling connections can be used.)
  2. When a CVM1, CV-series, or C200HX/HG/HE DeviceNet Master Unit is used, up to 32 words can be allocated in the master for a single node.
  3. The set points, alarm setting values, PID constants, and other Temperature Controller parameters can be set together.

### 1-2-2 Function and Performance Specifications

Item	Specifications
Maximum number of Temperature Controllers that can be connected	16 <b>Note</b> Up to 15 Units can be connected side by side. The 16th Unit is connected using distributed placement by using an End Unit.
Applicable Temperature Controllers	(TC4) <ul style="list-style-type: none"> <li>• EJ1N-TC4A-QQ</li> <li>• EJ1N-TC4B-QQ</li> </ul> (TC2) <ul style="list-style-type: none"> <li>• EJ1N-TC2A-QNHB</li> <li>• EJ1N-TC2B-QNHB</li> <li>• EJ1N-TC2A-CNB</li> <li>• EJ1N-TC2B-CNB</li> </ul>
Power supply	Power is supplied via the terminal block of the End Unit (power supply for communications between the DeviceNet Communications Unit and Temperature Controllers and power supply for internal circuits of the Temperature Controllers).
Copying	The parameters of a connected Temperature Controller can be uploaded or downloaded as a batch by using the DeviceNet Communications Unit's DIP switch or an explicit message. The bank parameters and G3ZA parameters are not copied. The uploaded parameters are stored in the DeviceNet Communications Unit.

### 1-2-3 General Specifications

Item		Specifications
Supply voltage	DeviceNet power supply	24 VDC (internal circuit)
	External input power supply	24 VDC (for RS-485 communications circuit/ Temperature Controllers)
Allowable voltage range	DeviceNet power supply	11 to 25 VDC
	External input power supply	20.4 to 26.4 VDC
Power consumption (at maximum load)		1 W max.
Current consumption (DeviceNet power supply)		45 mA max. (24 VDC)
Vibration resistance		10 to 55 Hz, 10m/s <sup>2</sup> for 2 hours each in X, Y, and Z directions
Shock resistance		150m/s <sup>2</sup> max. 3 times each in 3 axes, 6 directions
Dielectric strength		600 VAC 50 or 60 Hz 1min
Insulation resistance		20 MΩ min. (at 100 VDC)
Ambient temperature		-10 to 55°C (with no condensation or icing)
Ambient humidity		25% to 85%
Storage temperature		-25 to 65°C (with no condensation or icing)
Enclosure rating		IP20
Dimensions		20 × 90 × 65 mm (W × H × D)
Memory protection		EEPROM, 100,000 write operations (backup data)
Weight		70 g max.

## 1-3 Connecting Temperature Controllers

### 1-3-1 Temperature Controller ID and Number of Connectable Units

A DeviceNet Communications Unit is connected as shown in the following diagram.

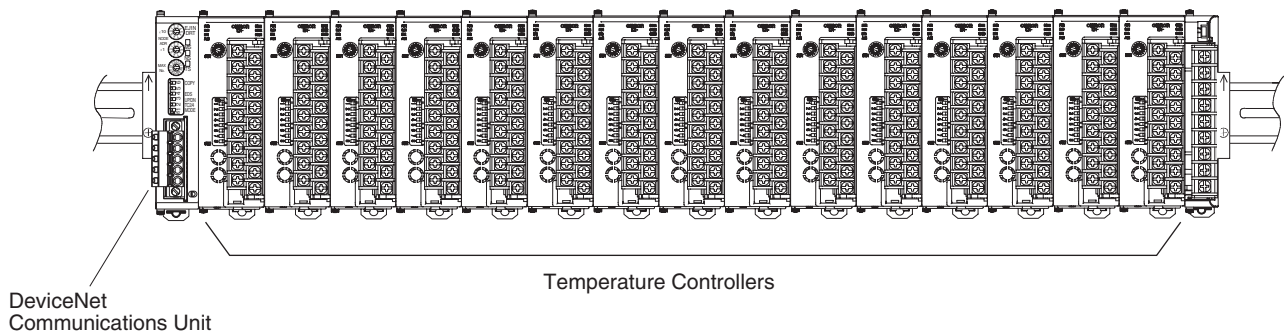

The DeviceNet Communications Unit differentiates each of the connected Temperature Controllers according to communications unit numbers (0 to F: 0 to 15 decimal). The Temperature Controllers can be connected in any order. The communications unit number of each Temperature Controller is set using the rotary switch on the front panel of the Temperature Controller. Always set a unique communications unit number for each Temperature Controller.

Up to 15 Temperature Controllers can be connected side by side. By using an End Unit, however, up to 16 Temperature Controller can be connected using distributed placement.

**Note** There is no priority between operation commands and settings for DeviceNet communications from the master, and operation commands and settings from the Configurator. Do not change the same data or send different operation commands more than one source at the same time.

## 1-3-2 Temperature Controller Communications

The DeviceNet Communications Unit communicates through port B on the Temperature Controllers. The DeviceNet Communications Unit will automatically set the communications settings. You do not need to set them. If you mistakenly change the settings, use the CX-Thermo to restore the default settings and then reset the DeviceNet Communications Unit.

## 1-3-3 Temperature Controller Models

Refer to *EJ1 Temperature Controllers* on page 169 for information on the Temperature Controller models.

## 1-3-4 Temperature Controller Power Supply

Power is supplied to the Temperature Controllers through the End Unit. For details, refer to the *EJ1 Modular Temperature Controller User's Manual* (Cat. No. H142).

## 1-3-5 Temperature Controller Registration

The connected Temperature Controllers must be registered in the configuration in the DeviceNet Communications Unit. The DeviceNet Communications Unit automatically verifies that the registered the Temperature Controllers match the Temperature Controllers currently able to communicate. If the unit numbers do not match in the verification process, the Temperature Controllers will be determined to have an error, causing the following status.

- The TS indicator will flash red.
- The Communicating Flag will turn OFF and the Communications Error Flag will turn ON for each Temperature Controller that is not communicating but is registered as being connected to the DeviceNet Communications Unit.

The method used to register the connection configuration depends on the method of remote I/O allocation.

- 1,2,3...**
1. Allocation from the Configurator  
With DIP switch pin 1 set to OFF, turn ON the power supply, and register the configuration using the Configurator or an explicit message.
  2. Allocation Using Simple Allocation  
Turn DIP switch pin 1 to ON, set DIP switch pin 2 to the model to be connected, and set the highest communications unit number setting to the highest communications unit number of the Temperature Controllers that are connected.

# 1-4 Initial Temperature Controller Settings

The following four methods are provided for setting the EJ1 Temperature Controllers.

## Transferring Temperature Controller Parameters Together

Set each of the Temperature Controller parameters in the Edit Device Parameters Window from the DeviceNet Configurator, and then transfer them together via the DeviceNet network.

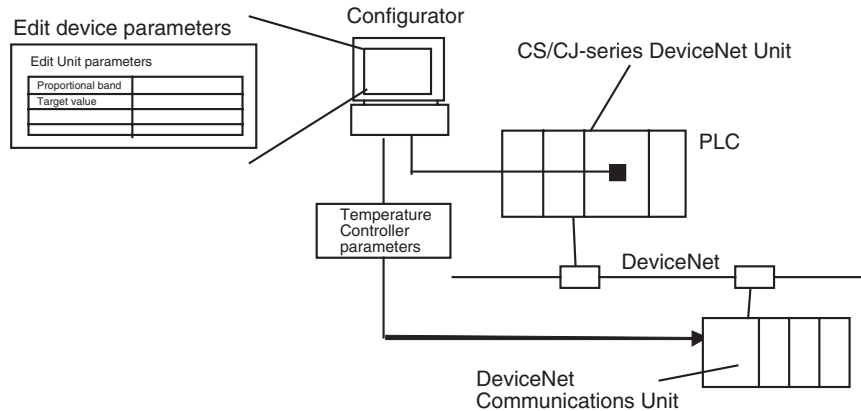

## Setting with Explicit Messages

Set the initial settings from the PLC with the master by sending an explicit message.

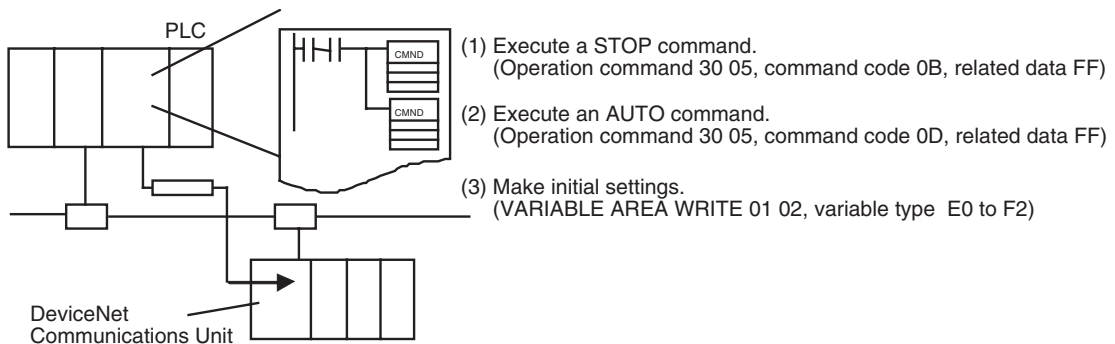





# SECTION 2

## Operating Procedures

This section outlines the basic operating procedures of the EJ1 DeviceNet Communications Unit.

- 2-1 Setup Procedure ..... 16
- 2-2 Startup Procedure ..... 17
  - 2-2-1 Simple I/O Allocation..... 17
  - 2-2-2 I/O Allocation Using the Configurator..... 18

## 2-1 Setup Procedure

Use the following procedure to prepare the DeviceNet Communications Unit for use. Refer to the reference pages provided for detailed information on each step.

Step	Item	Details	Reference page
1	Connect the DeviceNet Communications Unit and the Temperature Controllers.	Connect the DeviceNet Communications Unit to the Temperature Controllers. Attach the seal supplied with the End Unit to the hole on the side of the DeviceNet Communications Unit.	28
2	Mount the connected DeviceNet Communications Unit and the Temperature Controllers to the DIN Rail.	Mount the joined DeviceNet Communications Unit and the Temperature Controllers to the DIN Rail. To ensure secure mounting, always attach an End Plate to each end.	28
3	Connect the RS-485 communications cable (only for distributed placement).	When using a multiblock configuration for the Temperature Controllers connected to the DeviceNet Communications Unit, connect the RS-485 communications cable to port B on the End Unit for each block.	8
4	Connect the power supply	Connect a 24-VDC power supply to the power supply terminals of the End Unit. <b>Note</b> Do not turn ON the power supply at this time. This power supply is used as the internal circuit power supply of the Temperature Controllers and the communications power supply between the DeviceNet Communications Unit and the Temperature Controllers.	---
5	Wire the Temperature Controllers.	Wire the Temperature Controller temperature inputs and control outputs. <b>Note</b> Do not turn ON the power supply at this time.	---
6	Set the communications unit numbers of the Temperature Controllers.	Set the communications unit number of each Temperature Controller using the rotary switch and DIP switch on the Temperature Controller. Set a unique communications unit number for each Temperature Controller.	---
7	Set the DeviceNet node address.	Set the DeviceNet node address (0 to 63) of the DeviceNet Communications Unit. Set the ten's digit using the $\times 10$ rotary switch, and the one's digit using the $\times 1$ rotary switch. Set a unique node address for each slave connected to the same master.	24

## 2-2 Startup Procedure

### 2-2-1 Simple I/O Allocation

Use this method in the following situations.

- To allocate words in the master only for basic data, such as the set points (SPs), process values (PVs), and alarm outputs for each Temperature Controller.
- To use the DeviceNet Communications Unit without a Configurator (when allocating only fixed I/O in the master).

Step	Item	Details	Reference page
8	Set the I/O allocation method.	Set simple I/O allocation as the method for allocating I/O data in the IN and OUT Areas used by the DeviceNet Communications Unit. Turn ON pin 1 of the DIP switch. Set DIP switch pin 2 to the model of the Temperature Controller connected.	25
9	Set the highest unit number of the connected Temperature Controllers.	Set the highest communications unit number of the Temperature Controllers connected to the DeviceNet Communications Unit using the rotary switch (Max. No.) of the Unit. This setting will determine the size of the IN and OUT Areas.	26
10	Connect the DeviceNet communications connectors.	Connect the DeviceNet communications connector to the DeviceNet Communications Unit. <b>Note</b> Do not turn ON the communications power supply at this time. This power supply is also used as the internal circuit power supply of the DeviceNet Communications Unit.	32
11	Turn ON the power to the End Unit.	Turn ON the power connected to the End Unit. <b>Note</b> The Temperature Controllers will start.	---
12	Turn ON the DeviceNet communications power (V+, V-).	Turn ON the communications power supply to the DeviceNet Communications Unit. (See note.) <b>Note</b> The DeviceNet Communications Unit will start.	---
13	Check the indicators on the DeviceNet Communications Unit.	Check that the status of each indicator on the DeviceNet Communications Unit is as follows: MS: Operating normally when lit green. NS: Operating normally when lit green. (DeviceNet online or communications connected) TS: Communicating with Temperature Controllers when lit green.	23
14	Operate from the Configurator (if user-set allocation is used at the master). <b>Note</b> This also applies if 11 or more TC4 Units are connected.	With the Configurator online, open the master's Edit Device Parameters Window and allocate the IN and OUT Areas used by DeviceNet in the master. Click the Master I/O Allocations Tab, specify the first words for allocation input 1 and allocation output 1, and download the parameters to the master. <b>Note</b> When fixed allocations are used, I/O is allocated automatically.	73

Step	Item	Details	Reference page
15	Start remote I/O communications.	Enable the master's scan list and change the PLC to RUN Mode. Remote I/O communications will start, and the contents of the IN and OUT Areas in the master and DeviceNet Communications Unit will be synchronized.	---
	Using explicit message communications	Send explicit messages from the master. Explicit messages can be used to perform control and monitoring that cannot be achieved using the IN and OUT Areas alone, by sending explicit messages to the DeviceNet Communications Unit.	104
16	Set the initial settings or monitor the Temperature Controller.	With the Configurator online, perform Temperature Controller initial settings or monitoring from the Edit Device Parameters Window for the DeviceNet Communications Unit.	93
17	Upload the parameters of the Temperature Controller to the DeviceNet Communications Unit.	When the system has started normally, upload (backup) all the parameters to the DeviceNet Communications Unit in case of Temperature Controller malfunction. Creating a backup copy of the parameters will allow parameters to be easily reset onsite after a Temperature Controller has been replaced, without requiring a Configurator.  Procedure: Turn OFF pin 3 of the DIP switch of the DeviceNet Communications Unit, turn ON pin 6 (1 to 5 s), and then turn it OFF again.	25 and 141

**Note** When changing the baud rate of the master after starting the DeviceNet Communications Unit, turn ON the communications power supply of the DeviceNet Communications Unit again, and restart the Unit.

## 2-2-2 I/O Allocation Using the Configurator

Use this method for any of the following situations.

- To select any parameters (such as PID constants) or status information, apart from the Temperature Controller set points (SPs), process values (PVs), or alarm outputs, and allocate words for them in the master (up to 100 words each in the IN Area and OUT Area).
- To allocate data in any order.
- To use remote I/O communications to allocate only data that is always required in the master and not allocate unnecessary data.

**Note** Up to 100 words each can be allocated in the IN Area and OUT Area for remote I/O communications. To read and write larger amounts of data, use the following procedure.

- Use expansion remote I/O.
- Use explicit message communications. Also write data using explicit message communications for data that is written only when required.
- Use multiple DeviceNet Communications Units and distribute the number of Temperature Controllers connected to each DeviceNet Communications Unit.

Step	Item	Details	Reference page
8	Set the method for allocating I/O.	Set to the Configurator as the method for allocating I/O data in the IN and OUT Areas used by the DeviceNet Communications Unit. Turn OFF pin 1 of the DIP switch of the Unit.	25
9	Connect the DeviceNet communications connector.	Connect the DeviceNet communications connector to the DeviceNet Communications Unit. <b>Note</b> Do not turn ON the communications power at this time. This power supply is also used as the internal circuit power supply of the DeviceNet Communications Unit.	32
10	Turn ON the power to the End Unit.	Turn ON the power supply connected to the End Unit. <b>Note</b> The Temperature Controller will start.	---
11	Turn ON the DeviceNet communications power supply (+V, -V)	Turn ON the communications power supply to the DeviceNet Communications Unit. (See note.) <b>Note</b> The DeviceNet Communications Unit will start.	---
12	Check the indicators on the DeviceNet Communications Unit.	Check that the status of each indicator on the DeviceNet Communications Unit is as follows: MS: Operating normally when lit green. (When the power is turned ON for the first time when allocating I/O from the Configurator, the connection configuration of the Temperature Controllers will not be registered, so the indicator will flash green.) NS: Operating normally when lit green. (DeviceNet online or communications connected.) TS: Not lit.	23
13	Operate from the Configurator.	(1) With the Configurator online, register the connection configuration of the Temperature Controllers in the Edit Device Parameters Window for the DeviceNet Communications Unit. (2) Use the following method to allocate I/O in the IN and OUT Areas from the Parameters Window for the DeviceNet Communications Unit. a. Select the data to be allocated from the available allocation data. b. With the Configurator online, download the data to the DeviceNet Communications Unit. (3) To divide the IN Area used by the DeviceNet Communications Unit into two blocks, select the DeviceNet Communications Unit in the Edit Device Parameters Window for the master, and click Advanced to set the connections. Dividing the IN Area into two blocks allows, for example, RUN parameters such as set points (SP) and process values (PV) to be allocated as DM words in IN Area 1 and status information to be allocated as CIO words in IN Area 2. (4) When using the Configurator to allocate user-set I/O, allocate the IN and OUT Areas used by DeviceNet in the master from the Edit Device Parameters Window for the master. Click the Master I/O Allocations Tab, specify the first words of the IN Area 1, IN Area 2, and OUT Area 1, and download the parameters to the master. <b>Note</b> When fixed allocations are used, I/O is allocated automatically.	35

Step	Item	Details	Reference page
14	Start remote I/O communications.	Enable the master's scan list and change the PLC to RUN Mode. Remote I/O communications will start, and the contents of the IN and OUT Areas in the master and DeviceNet Communications Unit will be synchronized.	---
	When using explicit message communications	Send explicit messages from the master. Explicit messages can be used to perform control and monitoring that cannot be achieved using the IN and OUT Areas alone by sending explicit messages to the DeviceNet Communications Unit.	104
15	Set the initial settings or monitor the Temperature Controller.	With the Configurator online, execute Temperature Controller operation commands or perform monitoring from the Edit Device Parameters Window for the DeviceNet Communications Unit.	93
16	Upload the Temperature Controller parameters to the DeviceNet Communications Unit.	When the system has started normally, upload (backup) all the parameters to the DeviceNet Communications Unit in case of Temperature Controller malfunction. This will allow parameters to be easily reset onsite without using a Configurator after replacing a Temperature Controller.  Procedure: Turn OFF pin 3 of the DIP switch on the front panel of the DeviceNet Communications Unit, turn ON pin 6 (1 to 5 s), and then turn it OFF again.	25 and 141

**Note** When changing the baud rate of the master after starting the DeviceNet Communications Unit, turn ON the communications power supply of the DeviceNet Communications Unit again, and restart the Unit.

# SECTION 3

## Parts, Installation, and Wiring

This section describes the methods used to install and wire the EJ1 DeviceNet Communications Unit and the EJ1 Temperature Controller. The settings of DeviceNet Communications Unit switches are also described.

3-1	Part Names and Functions. . . . .	22
3-1-1	Part Names . . . . .	22
3-1-2	Indicators . . . . .	23
3-1-3	Switch Settings . . . . .	24
3-2	Installation. . . . .	27
3-2-1	Installing the DeviceNet Communications Unit and Temperature Controllers . . . . .	28
3-2-2	Mounting to DIN Rail. . . . .	28
3-3	DeviceNet Communications Cables Wiring . . . . .	30
3-3-1	Preparing DeviceNet Communications Cables. . . . .	30
3-3-2	Attaching the DeviceNet Communications Unit Connector. . . . .	32
3-4	Wiring the Temperature Controllers . . . . .	33



### 3-1 Part Names and Functions

#### 3-1-1 Part Names

**Node Address**  
Set the node address for the DeviceNet slave.

**Highest Communications Unit Number**  
When using simple I/O allocation, set the highest communication unit number that is used by the connected Temperature Controllers.

**Setting DIP Switches**

DIP Switches	Descriptions
6 (COPY) ---	Executes UpLoad/DownLoad OFF → ON (For 1 to 5 sec) → OFF
5 ---	Not in use
4 (EDS) OFF	OMRON Configurator is used.
ON	Other manufacturer's configurator is used.
3 (UP/DN) OFF	UpLoad (from Temperature Controller to EJ1-DRT)
ON	DownLoad (from EJ1-DRT to Temperature Controller)
2 (TC2/4) OFF	Simple assignment of I/O for TC2
ON	Simple assignment of I/O for TC4
1 (MODE) OFF	Simple assignment of I/O given by Configurator
ON	Simple assignment of I/O

**Front Panel**

**DeviceNet Communications Connector**  
This connector connects the DeviceNet network communications cable.  
The DeviceNet communications power is also supplied through this connector.  
The required FCK2.5/5-STF-5.08AU connector (Phoenix Contact) is provided with the Unit.

#### External Dimensions

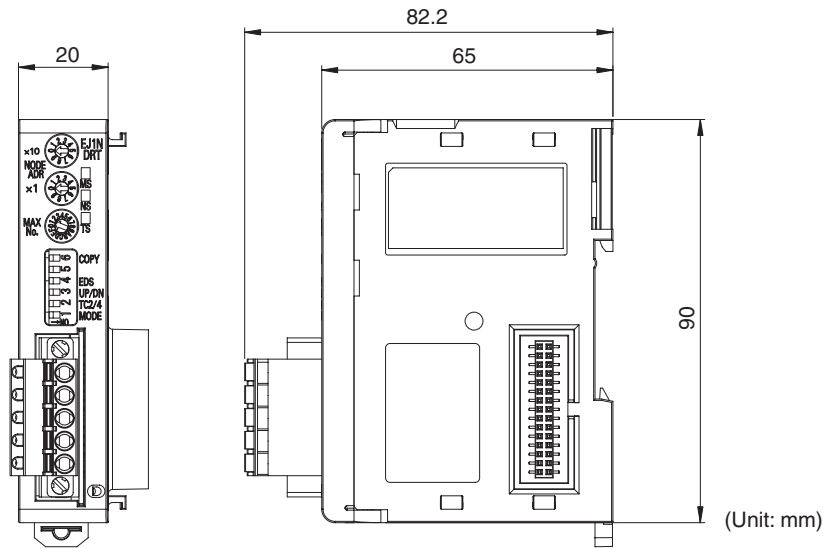

### 3-1-2 Indicators

The indicators show the status of the DeviceNet Communications Unit, the DeviceNet Network, and the status of communications with the Temperature Controllers.

Indicator	Name	Color	Status	Meaning (main errors)
MS	Module status	Green	ON	The Unit condition is normal. (DeviceNet Communications Unit is normal.)
			Flashing	The Unit is not set (when I/O allocation is set from the Configurator). <ul style="list-style-type: none"> <li>• The connection configuration has not been set.</li> <li>• I/O allocations have not been set.</li> </ul>
		Red	ON	Fatal error <ul style="list-style-type: none"> <li>• Watchdog timer error</li> <li>• RAM error</li> </ul>
			Flashing	Non-fatal error <ul style="list-style-type: none"> <li>• EEPROM sum error</li> <li>• EEPROM hardware error</li> </ul>
		---	OFF	No power is being supplied. <ul style="list-style-type: none"> <li>• Power is not being supplied to the DeviceNet Communications Unit.</li> <li>• The Unit is being reset.</li> <li>• Waiting for initialization to start.</li> </ul>
NS	Network status (DeviceNet)	Green	ON	Online/communications established (normal network status)
			Flashing	Online/communications established (waiting for communications to be established with master)
		Red	ON	Fatal communications error (The Unit has detected an error that does not allow communications through the network.) <ul style="list-style-type: none"> <li>• Node address duplication error</li> <li>• Bus Off error detected</li> </ul>
			Flashing	Non-fatal communications error <ul style="list-style-type: none"> <li>• Communications timeout</li> </ul>
		---	OFF	Offline or power supply is OFF <ul style="list-style-type: none"> <li>• Waiting for completion of the master's node address duplication check.</li> <li>• Power is not being supplied to the DeviceNet Communications Unit.</li> </ul>

Indicator	Name	Color	Status	Meaning (main errors)
TS	Temperature Controller communications status	Green	ON	Communicating with the Temperature Controllers
			Flashing	The copy operation is being performed.
		Red	Flashing	<ul style="list-style-type: none"> <li>Communications error with a Temperature Controller (a communications error has occurred with at least one of the Temperature Controllers registered in the DeviceNet Communications Unit)</li> <li>The copy operation failed. (Flashes for 10 s, then returns to prior status.)</li> </ul>
			---	OFF

**Normal Indicator Display**

The MS, NS, and TS indicators are all lit green when the status of all Units and the Network are normal.

**3-1-3 Switch Settings**

**Note** The DeviceNet Communications Unit automatically detects and matches the baud rate of the master, so the baud rate does not require setting.

**Front Rotary Switches**

Use these switches to set the node address as a slave in the DeviceNet network between 00 and 63 (node addresses 64 to 99 cannot be used).

Set the ten's digit with the upper rotary switch, and the one's digit with the lower rotary switch.

Any node address within the specified range can be set, as long as each node in the Network (master, slaves, Configurator) has a different node address.

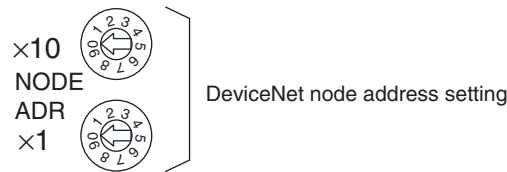

- Note**
1. Always turn OFF the DeviceNet communications power supply and EDU power supply before setting the Unit.
  2. The factory setting is 00.
  3. If two or more nodes are set with the same node address, a node address duplication will occur and the nodes will not be able to participate in communications.

**Copy Function**

The DeviceNet Communications Unit can read and save the parameters of the connected Temperature Controllers, allowing the parameters to be copied to the Temperature Controllers when required.

Use the following procedure to operate the front panel DIP switch and perform copy operations. For details on the copy mode, refer to *Reading/Writing Temperature Controller Settings Using Copy Mode* in 8-2-3 Replacing Units.

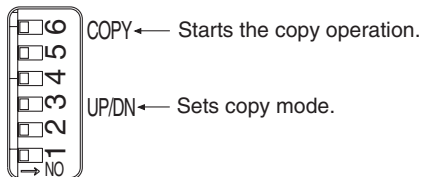

**Copy Mode Setting (Pin 3)**

Specify the copy mode operation according to the following table.

Pin 3	Copy mode operation setting
OFF	Upload (from Temperature Controller to DeviceNet Communications Unit)
ON	Download (from DeviceNet Communications Unit to Temperature Controller)

**Note** Pins 3 and 6 of the DIP switch are OFF as the factory setting.

**Copy Start (Pin 6)**

The copy operation is performed according to the copy mode set using pin 3, by operating this pin as follows:

OFF → ON (1 s min., 5 s max.) → OFF

**Note** Pins 3 and 6 of the DIP switch are OFF as the factory setting.

**I/O Allocations**

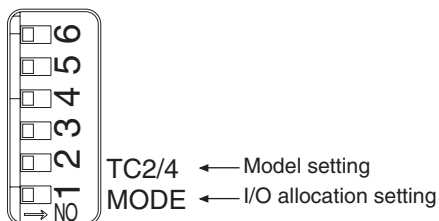

The Temperature Controller connection configuration and I/O allocations can be set using simple I/O allocations or I/O allocations from the Configurator.

**I/O Allocation Setting Switch (DIP Switch Pin 1)**

DIP switch pin 1	I/O allocation setting switch
OFF	Setting I/O Allocation from the Configurator. Use the Configurator to set the DeviceNet Communications Unit connection configuration and I/O allocation. The settings are saved in the non-volatile memory in the DeviceNet Communications Unit, so the same settings can be used once they have been made. (By default, the connection configuration and I/O allocation are not set.)
ON	Simple I/O Allocation Setting Connection configuration is made and I/O allocation is automatically performed according to the settings made on the highest communications unit number switch (rotary switch) and the model switch (DIP switch pin 2). With the simple I/O allocation setting, the system checks the communications status of Temperature Controllers up to the communications unit number set as the highest communications unit number when the DeviceNet Communications Unit is started. (Power must also be supplied to the End Unit). As a result, the Temperature Controllers with which communications can be performed normally are registered to the connection configuration. Also, input and output areas are obtained for Temperature Controllers up to the highest communications unit number.

For details on setting I/O allocations from the Configurator and simple I/O allocations, refer to *SECTION 4 Remote I/O Communications*.

**Model Setting (DIP Switch Pin 2)**

Set the model of the Temperature Controllers to be connected to the DeviceNet Communications Unit. This setting is enabled if DIP switch pin 1 is set to ON (simple I/O allocations).

DIP switch pin 2	Model setting
OFF	TC2 connected.
ON	TC4 connected.

- Note**
1. Refer to page 64 and page 68 for information on data allocations when both TC2 and TC4 Units are connected to a DeviceNet Communications Unit.
  2. Always turn OFF the DeviceNet communications power supply and turn OFF the End Unit power supply before making this setting.
  3. When DIP switch pin 1 is set to OFF (I/O allocations with Configurator), the MS indicator will flash green if the connection configuration is not registered. When the connection configuration is set from the Configurator, the DeviceNet Communications Unit will automatically be reset, and after starting normally, the MS indicator will be lit green.
  4. By default, DIP switch pins 1 and 2 are set to OFF.

**Setting the Highest Communications Unit Number**

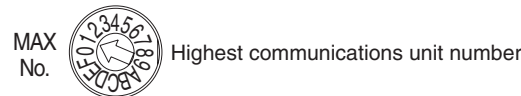

Use this switch to set the highest communications unit number (0 to F: 0 to 15 decimal) of the connected Temperature Controllers. This setting is enabled only when DIP switch pin 1 is set to ON (simple I/O allocations). Set the communications unit numbers on the other Temperature Controllers using the following settings 0 to F (0 to 15 decimal).

**■ Setting Communications Unit Number Switch for Temperature Controllers**

SW2		SW1															
1	2	0	1	2	3	4	5	6	7	8	9	A	B	C	D	E	F
OFF	OFF	00	01	02	03	04	05	06	07	08	09	10	11	12	13	14	15

- Note**
1. Refer to the *EJ1 Modular Temperature Controller User's Manual* (Cat. No. H142) for details.
  2. Always turn OFF the DeviceNet communications power supply and turn OFF the End Unit power supply before making this setting.
  3. Always set the communications unit number for each Temperature Controller to between 0 and F (0 and 15 decimal).
  4. If simple I/O allocations are used, do not use a Temperature Controller that has a communications number higher than the highest communications number set here.
  5. I/O data is also allocated automatically according to this setting.
  6. The default setting is 1.

### Setting the Support Software

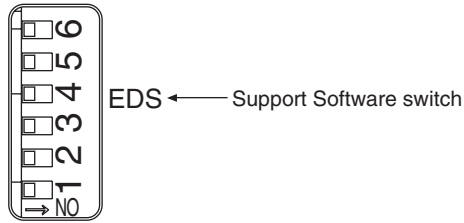

Use this pin to select the Support Software to be used.

DIP switch pin 4	Details
OFF	Use the OMRON Configurator.
ON	Use another company's configurator.

### Other Settings

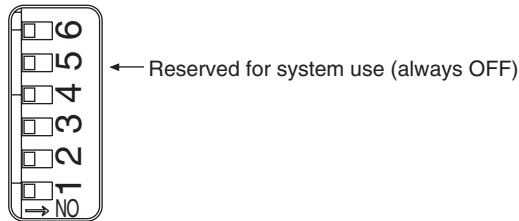

DIP switch pin 5 is reserved for the system. Keep it set to OFF.

## 3-2 Installation

Connect the Temperature Controllers to the right side of the DeviceNet Communications Unit. If distributed placement is used, connect the End Units of each block to each other using communications cables.

Up to 16 Temperature Controllers can be connected to a single DeviceNet Communications Unit.

**Note** Do not connect DeviceNet Communications Units to communications cables or disconnect them from the cables while the DeviceNet Network is operating. Abnormal communications may result from short-circuited DeviceNet cables, loose contacts, or from changing the location of terminating resistance (DeviceNet) due to changes in the node configuration.

### 3-2-1 Installing the DeviceNet Communications Unit and Temperature Controllers

- 1,2,3... 1. Align the connectors and connect the Units to each other.

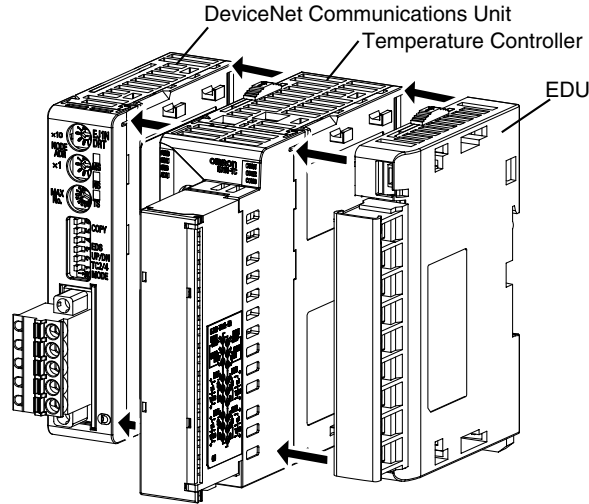

Connect the End Unit to the right end and connect the DeviceNet Communications Unit to the left end.

2. Slide the yellow sliders on the top and bottom of the Units until they click into place.

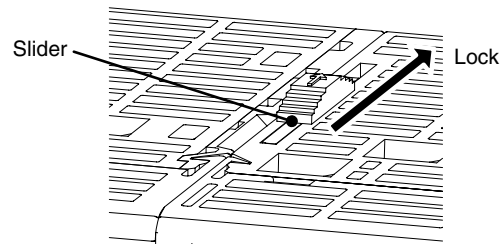

3. Attach the cover seal to the connector on the Unit on the left end of the EJ1.

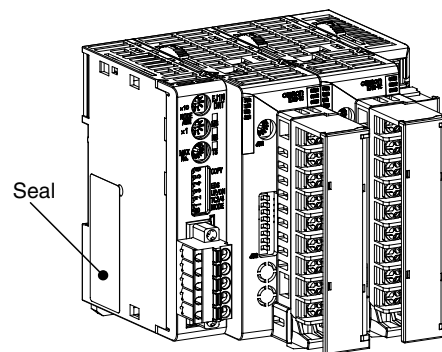

### 3-2-2 Mounting to DIN Rail

#### Mounting Bracket

Mount the DeviceNet Communications Unit and Temperature Controllers to the DIN Rail.

Use screws to attach the DIN Rail to the control panel in at least three places.

PFP-50N (50 cm)/PFP-100N (100 cm) DIN Rail

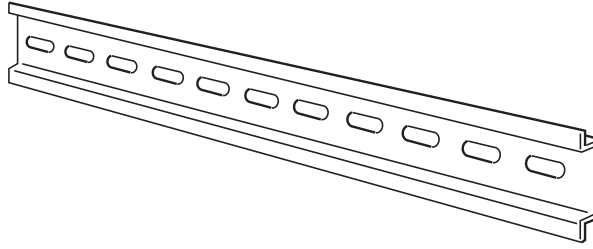

PFP-M End Plates (x2)

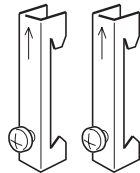

Mounting Direction

The mounting direction of the Temperature Controllers is fixed. Position the DIN Rail vertical to the ground, as shown in the following diagram.

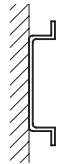

Vertical: OK



Horizontal: NG

Mounting the Unit

Pull down the hooks on the bottoms of the Units, and then catch the hooks on the tops of the Units onto the DIN Rail and press the Units onto the DIN Rail until they lock into place.

2. Catch the upper hooks onto the DIN Rail.

3. Press in on the Units.

1. Pull down the hooks.

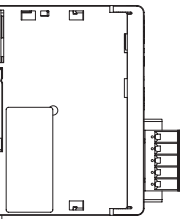

4. Make sure the Units are locked into place.



**Removing the Unit**

Use a flat-blade screwdriver to pull down the DIN Rail mounting hooks, and then lift up the Units.

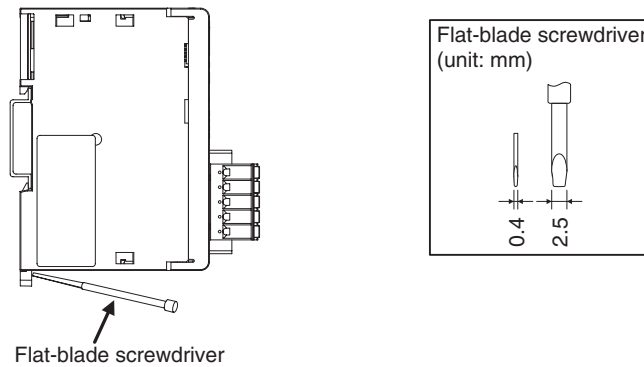

**Mounting End Plates**

Always mount end plates to both ends to keep the Units connected together. Hook the bottom of the end plate onto the DIN Rail (1), hook the top, and then pull down (2). Secure the end plate screws.

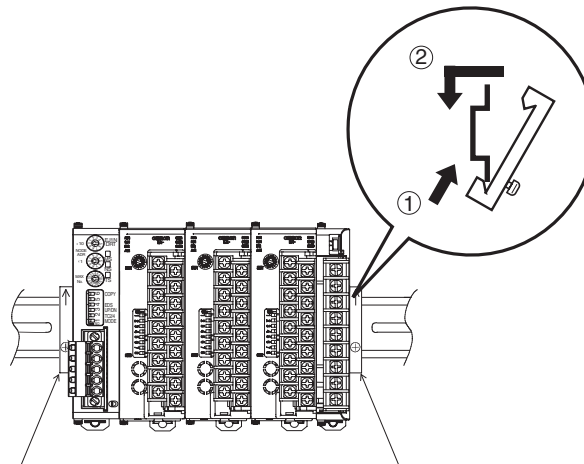

**Note** Always use two End Plates to clamp the Units together from both ends.

**3-3 DeviceNet Communications Cables Wiring**

The methods for preparing DeviceNet communications cables connected to the DeviceNet Communications Unit, and attaching communications connectors are explained here.

For details on supplying the DeviceNet communications power and grounding the DeviceNet Network, refer to the *DeviceNet Operation Manual* (Cat. No. W267).

**3-3-1 Preparing DeviceNet Communications Cables**

Use the following procedure to prepare and connect the communications cables to the connectors.

- 1,2,3... 1. Remove about 30 to 80 mm of the cable covering, being careful not to damage the shield mesh underneath. Do not remove too much covering or a

short circuit may result.

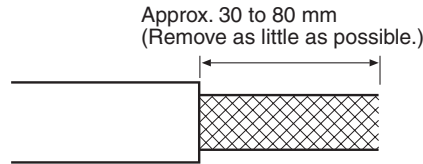

- Carefully peel back the shield mesh to reveal the signal lines, power lines, and the shield wire. The shield wire is slightly harder to the touch than the mesh.

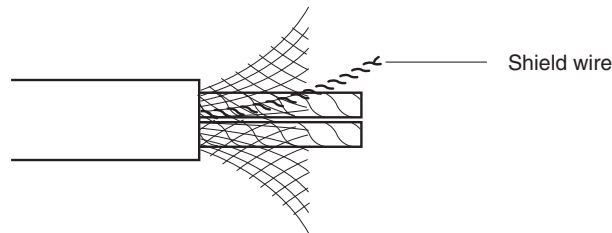

- Remove the exposed mesh and the aluminum tape from the signal and power lines. Strip the covering from the signal and power lines to the proper length for the crimp terminals. Twist together the wires of each of the signal and power lines.

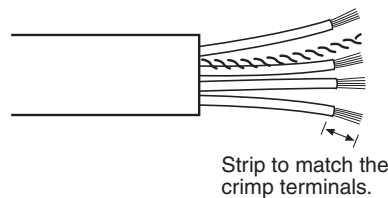

- Attach crimp terminals to the lines and then cover any exposed areas with vinyl tape or heat-shrink tubing.

Orient the connector properly, then insert each of the signal lines, power supply lines, and the shield wire into the connector holes from the top in the order red, white, shield, blue, black, as shown in the following diagram. The DeviceNet Communications Unit is equipped with screwless connectors, so the cables do not need to be secured with screws as with previous DeviceNet communications connectors. With the orange tab pushed down, insert each of the lines into the back of the holes. Release the orange tab and gently tug on each line to check that it is connected properly.

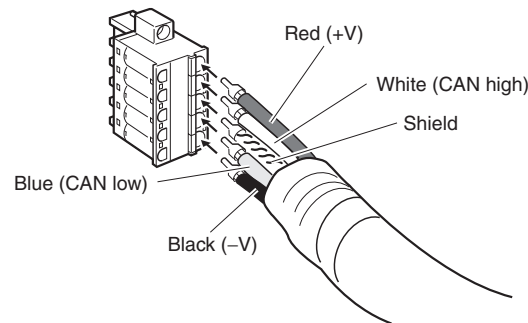

Colored stickers that match the colors of the lines to be inserted are provided on the Master Unit and slaves. Use these stickers to check that the lines are wired correctly. The colors correspond to the signal lines as follows:

Color	Signal
Red	Power line, positive voltage (+V)
White	Communications line, high (CAN high)
---	Shield
Blue	Communications line, low (CAN low)
Black	Communications cable, negative voltage (-V)

- We recommend the following crimp terminals.  
Phoenix Contact AI-series Crimp Terminals: AI-0.5-8WH-B (product code 3201369)

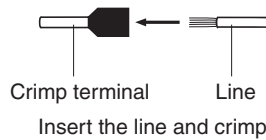

The following crimp tool is also available.  
Phoenix Contact ZA3 Crimp Tool

Note For the DeviceNet power supply, always use an EN/IEC-approved power supply with reinforced or double insulation.

### 3-3-2 Attaching the DeviceNet Communications Unit Connector

Align the DeviceNet Communications Unit connector with the cable connector, and insert the cable connector fully into the DeviceNet Communications Unit connector.

Tighten the set screws to a torque between 0.25 and 0.30 N·m to secure the connector.

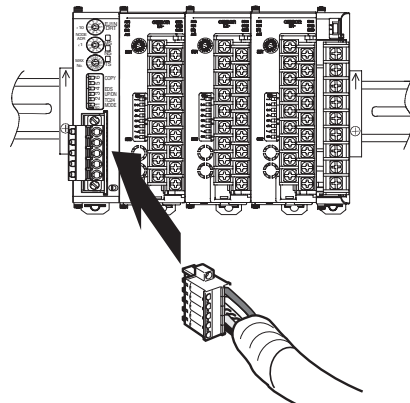

- Using the Connector Provided with the DeviceNet Communications Unit for a Multidrop Connection (Using Thin Cables)  
When using Thin Cables for a multidrop connection, two wires of the same color can be inserted into the one hole.

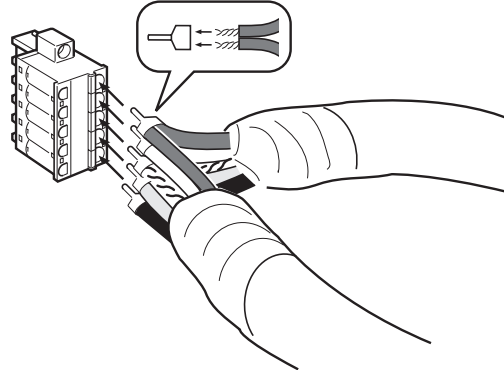

Crimp the two lines together that are to be inserted into the same hole using a special crimp terminal, as shown in the following diagram.

**Crimp Terminal for Two Lines**

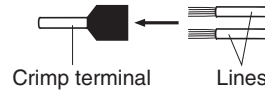

We recommend the following crimp terminals and crimp tools.

Crimp terminal	Crimp tool
Phoenix Contact	Phoenix Contact
Model: AI-TWIN2×0.5-8WH (product code 3200933)	Model: UD6 (product code 1204436)

### 3-4 Wiring the Temperature Controllers

For information on wiring the Temperature Controllers, refer to the *EJ1 Modular Temperature Controller User's Manual* (Cat. No. H142).

Insert a noise filter (MXB-1206-33 manufactured by Densai-Lamda or equivalent product) on the End Unit power supply line within 25 cm of the Unit in order to satisfy standards for EN 61326 Class A noise terminal voltage and electromagnetic radiation interference.



# SECTION 4

## Remote I/O Communications

This section describes the IN Area and OUT Area that a EJ1 DeviceNet Communications Unit can use for remote I/O communications. The methods to allocate data for master communications are also described.

4-1	Allocation Method Overview . . . . .	36
4-1-1	Overview . . . . .	36
4-1-2	Allocation Procedure . . . . .	39
4-2	Simple I/O Allocation . . . . .	40
4-2-1	Setting Allocation Data . . . . .	40
4-2-2	Simple I/O Allocation Area Configuration . . . . .	41
4-2-3	Allocating Data in the Master . . . . .	44
4-3	Allocating I/O from the Configurator . . . . .	45
4-3-1	Setting Allocation Data . . . . .	45
4-3-2	Creating Allocation Data . . . . .	45
4-3-3	Parameters for Which Allocation Is Possible . . . . .	54
4-3-4	Input Data . . . . .	59
4-3-5	Output Data Details . . . . .	65
4-4	Expansion Remote I/O . . . . .	68
4-4-1	What Is Expansion Remote I/O? . . . . .	68
4-4-2	Procedure for Reading Parameters . . . . .	69
4-4-3	Procedure for Writing Parameters . . . . .	71
4-5	Allocating Data in the Master . . . . .	73
4-5-1	Fixed Allocations . . . . .	73
4-5-2	User-set Allocations . . . . .	73
4-6	Ladder Programming Examples . . . . .	78
4-6-1	RUN/STOP Programming Examples . . . . .	78
4-6-2	Change SP Programming Example . . . . .	79
4-6-3	Change MV Upper Limit/Lower Limit Programming Example . . . . .	80

## 4-1 Allocation Method Overview

This section provides an overview of allocation methods for performing remote I/O communications from the master through the DeviceNet Communications Unit.

### 4-1-1 Overview

The DeviceNet Communications Unit can be used to allocate I/O memory in the master to the following Temperature Controller parameters.

- Operation command/status parameters
- Monitor parameters
- Parameters that can be changed during operation

The DeviceNet Communications Unit can be used to select data from the Temperature Controllers and DeviceNet Communications Unit and specify the words to allocate to that data.

Data is automatically exchanged between the master and DeviceNet Communications Unit, allowing Temperature Controllers to be controlled and monitored from the master without requiring special communications programming.

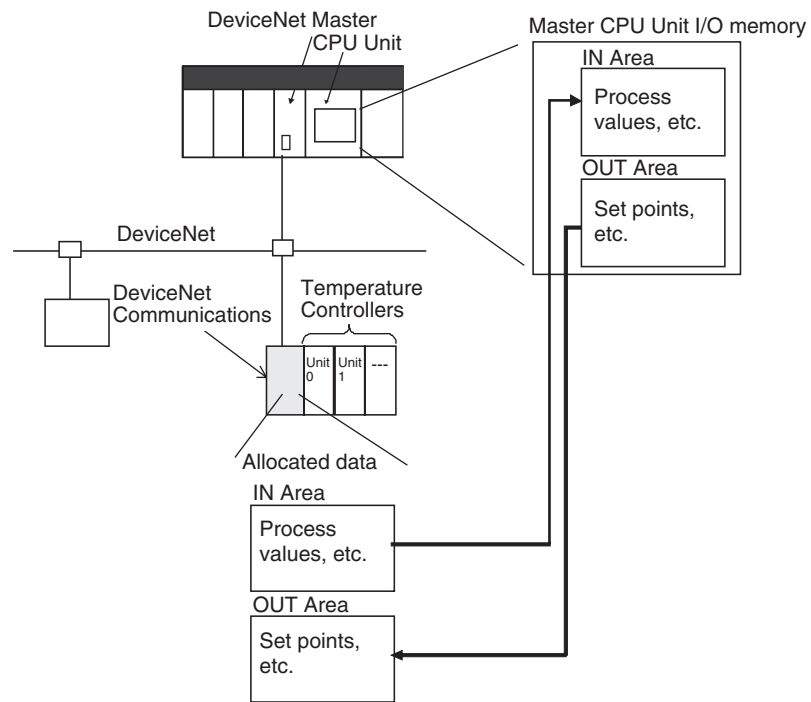

Use either of the following two methods to allocate DeviceNet Communications Unit I/O in the master.

**1. Simple I/O Allocation**

I/O can be allocated simply by setting the highest communications unit number of Temperature Controllers connected to the DeviceNet Communications Unit using the rotary switch. Basic data only, such as Temperature Controller set points (SPs) and process values (PVs), will be allocated consistently and automatically in unit number/channel order according to the configuration of connected Temperature Controllers.

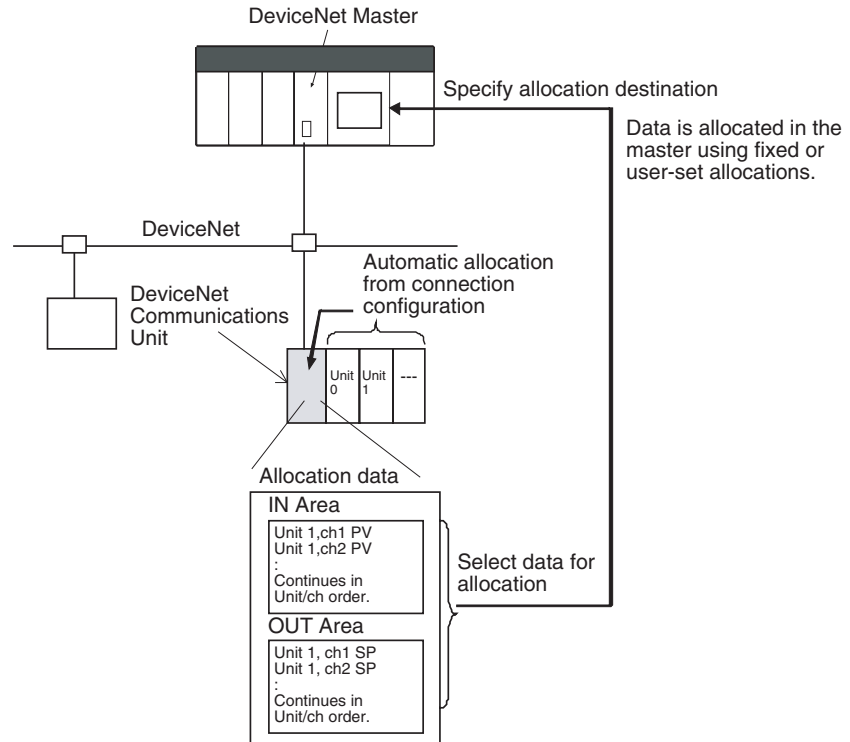

**Note:** The above allocation data is automatically allocated according to the connection configuration.



**2. User-set Allocations from the Configurator**

The Configurator can be used to edit the device parameters and select any data from the list of allocation parameters for the Temperature Controller and DeviceNet Communications Unit, and then allocate the data in a user-set destination.

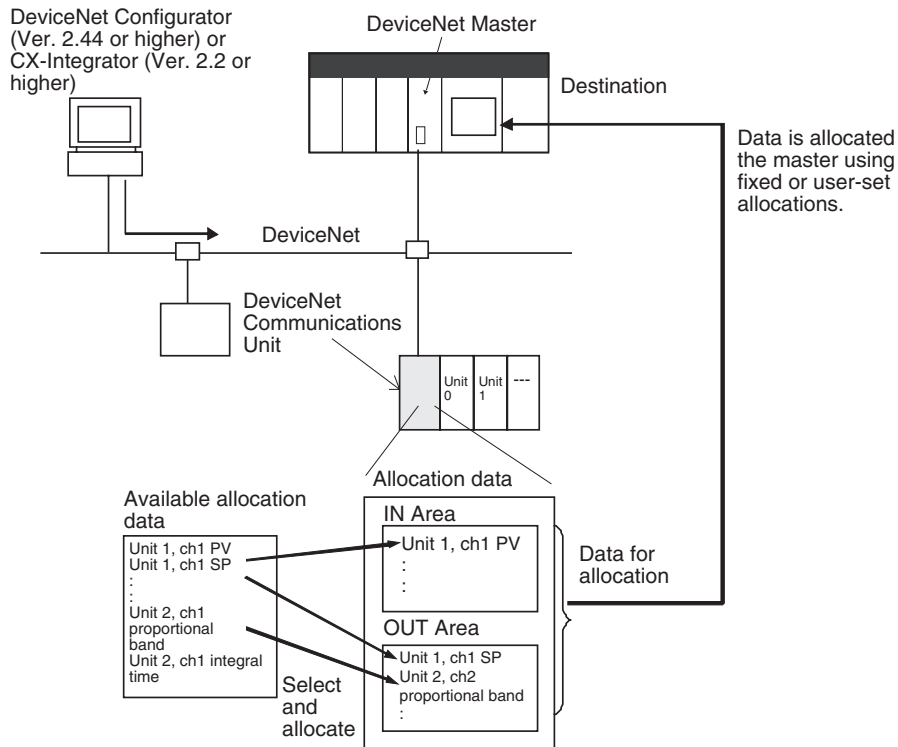

**Note:** Create the above allocation data using the Configurator's Edit Device Parameters and then download to the DeviceNet Communications Unit.

## 4-1-2 Allocation Procedure

Follow the two steps below to allocate I/O for remote communications between the master and DeviceNet Communications Unit.

### Step 1: Set the Slaves

Set in the DeviceNet Communications Unit which Temperature Controller data or DeviceNet Communications Unit data to allocate in the Master. Use either of the following two methods (1 or 2) to set the data allocation method.

Method for setting allocation data	DIP switch pin 1	Contents	Applications
1) Simple I/O allocation	ON	The predetermined set of parameters is automatically set.	Used to allocate in the master basic data only, such as the Temperature Controller SPs, PVs, and alarm outputs.
2) I/O allocations from the Configurator	OFF	The Configurator is used to select any data for allocating in the master from the list of parameters.	<ul style="list-style-type: none"> <li>Used to allocate parameters and statuses in the master other than the Temperature Controller SPs, PVs, and alarm outputs.</li> <li>Used to allocate data in any order.</li> <li>Used to allocate in the master only the data that is always required for remote I/O communications, without allocating data that is not required.</li> <li>To divide the IN Area into two areas for allocating data (see note 1).</li> </ul>

- Note**
- When a CS/CJ-series DeviceNet Unit is used, the IN Area can be divided into two areas (IN Area 1 and IN Area 2). Any allocation data from the list of parameters can be selected and allocated in each area. (For example, operation data and status data can be separated and allocated into different locations.) To use this function, however, set two connection methods between the master and DeviceNet Communications Unit under User Setup in the Edit Device Parameters Window for the master. For details, refer to *Setting Connections when Dividing IN Area in Two* on page 75.
  - The size of allocated data is determined according to the allocation method used, as shown in the following table.

Setting method	Number of allocated blocks	Size of allocated data
Simple I/O allocation	IN Area: 1 block OUT Area: 1 block	<ul style="list-style-type: none"> <li>TC2 Selected (DIP switch pin 2 OFF): IN Area: 16 to 46 words (32 to 92 bytes) (= 16 + n × 2 words) OUT Area: 8 to 38 words (16 to 76 bytes) (= 8 + n × 2 words)</li> <li>TC4 Selected (DIP switch pin 2 ON): IN Area: 26 to 86 words (52 to 172 bytes) (= 26 + n × 4 words) OUT Area: 14 to 74 words (28 to 148 bytes) (= 14 + n × 4 words)</li> </ul> n: The value set as the highest communications unit number (0 to F hex: 0 to 15 decimal).
I/O allocations from the Configurator	IN Area: 1 or 2 blocks OUT Area: 1 block	IN Area: 0 to 100 words (0 to 200 bytes) OUT Area: 0 to 100 words (0 to 200 bytes) (Depends on the quantity of allocation data selected.)

### Step 2: Allocate Data in the Master

Specify the I/O memory of the master (CPU Unit) to allocate for the data determined in step 1. Whether the setting for allocating data in the master is set to simple I/O allocation or allocation from the Configurator, either of the following two methods can be used.

- Fixed allocations

- User-set allocations

**Procedure Overview**

Steps		Simple I/O allocation		I/O allocations from the Configurator	
Step 1	Set the allocation data.	<ul style="list-style-type: none"> <li>• Turn ON pin 1 of the DIP switch.</li> <li>• Use DIP switch pin 2 to set the model of the Temperature Controller to be connected.</li> <li>• Set the highest communications unit number.</li> </ul>		Turn OFF pin 1 of the DIP switch.	
				IN Area: 1 block	IN Area: 2 blocks
				OUT Area: 1 block	OUT Area: 1 block
				Using the Configurator, create the allocation data in the Edit Device Parameters Window for the DeviceNet Communications Unit.	
				---	Using the Configurator, set the connections using user definitions in the Edit Device Parameters Window for the Master Unit.
Step 2	Allocate the data in the master.	Fixed allocations Fixed allocations cannot be used if 11 or more TC4 Units are used.	User-set allocations Using the Configurator, allocate I/O from the Edit Device Parameters Window for the Master Unit under <i>I/O Allocations</i> , or <i>I/O Allocations through Allocated DM words</i> .	Fixed allocations	User-set allocations Using the Configurator, allocate I/O from the Edit Device Parameters Window for the Master Unit under <i>I/O Allocations</i> , or <i>I/O Allocations through Allocated DM words</i> .

**Note** The sizes of slave I/O data allocated in the master is listed below. Allocate I/O correctly within the maximum allocation sizes.

DeviceNet Communications Unit allocation sizes:

IN Area: Up to 200 bytes (100 words)

OUT Area: Up to 200 bytes (100 words)

CS/CJ-series Master Unit allocation sizes:

IN Area: Up to 200 bytes (100 words)

OUT Area: Up to 200 bytes (100 words)

CVM1/CV-series, C200H, C200HX/HG/HE Master Unit allocation sizes:

IN Area: Up to 64 bytes (32 words)

OUT Area: Up to 64 bytes (32 words)

## 4-2 Simple I/O Allocation

### 4-2-1 Setting Allocation Data

Simple I/O allocation is used to allocate I/O in the master without using a Configurator, and to allocate in the master the Temperature Controller set points (SP), process values (PV), alarm output status, and other basic data only.

Set simple I/O allocation by turning ON pin 1 of the DIP switch of the DeviceNet Communications Unit.

Memory is allocated to data, such as SP and SV, in the order of unit numbers and channels of the Temperature Controllers up to the Temperature Controller with the highest communications unit number set on the front of the Unit (MAX No.). It is assumed that there are no Temperature Controllers with communications unit numbers higher than this value.

- TC2 Selected (DIP switch pin 2 OFF):
  - IN Area: 16 to 46 words (= 16 + n × 2 words)
  - OUT Area: 8 to 38 words (= 8 + n × 2 words)

- TC4 Selected (DIP switch pin 2 ON):  
IN Area: 26 to 86 words (= 26 + n × 4 words)  
OUT Area: 14 to 74 words (= 14 + n × 4 words)

- Note**
1. Data that is not included in the allocation data can be controlled and monitored using explicit messages.
  2. When simple I/O allocation is used, the type of data allocated and the allocation order cannot be changed. To add or change types of data, or to specify the allocation order, allocate I/O from the Configurator.

## 4-2-2 Simple I/O Allocation Area Configuration

The configuration of the IN Area and OUT Areas for simple I/O allocations is shown here for the TC2 and TC4. (The process values (PVs) and set points (SPs) have the same contents as the PV and SP settings in the Temperature Controller variable area.)

### Simple I/O Allocations with TC2 Selected (DIP switch pin 2 OFF)

Address	OUT Area		IN Area	
First word + 0	OUT Enable Bit	(See note 1.)	Communications Status	---
First word + 1	Not used.	(See note 1.)	Communications Error Status	---
First word + 2	RUN/STOP (TC2: #00–#07)	(See note 1.)	RUN/STOP (TC2: #00–#07)	(See note 1.)
First word + 3	RUN/STOP (TC2: #08–#15)	(See note 1.)	RUN/STOP (TC2: #08–#15)	(See note 1.)
First word + 4	AT Execute/Cancel (TC2: #00–#07)	(See note 1.)	AT Execute/Cancel (TC2: #00–#07)	(See note 1.)
First word + 5	AT Execute/Cancel (TC2: #08–#15)	(See note 1.)	AT Execute/Cancel (TC2: #08–#15)	(See note 1.)
First word + 6	#0 ch1 Present Bank Set Point	(See note 2.)	Alarm 1 (TC2: #00–#07)	(See note 1.)
First word + 7	#0 ch2 Present Bank Set Point	(See note 2.)	Alarm 1 (TC2: #08–#15)	(See note 1.)
First word + 8	#1 ch1 Present Bank Set Point	(See note 2.)	Alarm 2 (TC2: #00–#07)	(See note 1.)
First word + 9	#1 ch2 Present Bank Set Point	(See note 2.)	Alarm 2 (TC2: #08–#15)	(See note 1.)
First word + 10	#2 ch1 Present Bank Set Point	(See note 2.)	Alarm 3 (TC2: #00–#07)	(See note 1.)
First word + 11	#2 ch2 Present Bank Set Point	(See note 2.)	Alarm 3 (TC2: #08–#15)	(See note 1.)
First word + 12	#3 ch1 Present Bank Set Point	(See note 2.)	HB Alarm (TC2: #00–#07)	(See note 1.)
First word + 13	#3 ch2 Present Bank Set Point	(See note 2.)	HB Alarm (TC2: #08–#15)	(See note 1.)
First word + 14	#4 ch1 Present Bank Set Point	(See note 2.)	#0 ch1 Process Value	(See note 2.)
First word + 15	#4 ch2 Present Bank Set Point	(See note 2.)	#0 ch2 Process Value	(See note 2.)
First word + 16	#5 ch1 Present Bank Set Point	(See note 2.)	#1 ch1 Process Value	(See note 2.)
First word + 17	#5 ch2 Present Bank Set Point	(See note 2.)	#1 ch2 Process Value	(See note 2.)
First word + 18	#6 ch1 Present Bank Set Point	(See note 2.)	#2 ch1 Process Value	(See note 2.)
First word + 19	#6 ch2 Present Bank Set Point	(See note 2.)	#2 ch2 Process Value	(See note 2.)
First word + 20	#7 ch1 Present Bank Set Point	(See note 2.)	#3 ch1 Process Value	(See note 2.)
First word + 21	#7 ch2 Present Bank Set Point	(See note 2.)	#3 ch2 Process Value	(See note 2.)
First word + 22	#8 ch1 Present Bank Set Point	(See note 2.)	#4 ch1 Process Value	(See note 2.)
First word + 23	#8 ch2 Present Bank Set Point	(See note 2.)	#4 ch2 Process Value	(See note 2.)
First word + 24	#9 ch1 Present Bank Set Point	(See note 2.)	#5 ch1 Process Value	(See note 2.)
First word + 25	#9 ch2 Present Bank Set Point	(See note 2.)	#5 ch2 Process Value	(See note 2.)
First word + 26	#10 ch1 Present Bank Set Point	(See note 2.)	#6 ch1 Process Value	(See note 2.)
First word + 27	#10 ch2 Present Bank Set Point	(See note 2.)	#6 ch2 Process Value	(See note 2.)
First word + 28	#11 ch1 Present Bank Set Point	(See note 2.)	#7 ch1 Process Value	(See note 2.)
First word + 29	#11 ch2 Present Bank Set Point	(See note 2.)	#7 ch2 Process Value	(See note 2.)
First word + 30	#12 ch1 Present Bank Set Point	(See note 2.)	#8 ch1 Process Value	(See note 2.)

Address	OUT Area		IN Area	
First word + 31	#12 ch2 Present Bank Set Point	(See note 2.)	#8 ch2 Process Value	(See note 2.)
First word + 32	#13 ch1 Present Bank Set Point	(See note 2.)	#9 ch1 Process Value	(See note 2.)
First word + 33	#13 ch2 Present Bank Set Point	(See note 2.)	#9 ch2 Process Value	(See note 2.)
First word + 34	#14 ch1 Present Bank Set Point	(See note 2.)	#10 ch1 Process Value	(See note 2.)
First word + 35	#14 ch2 Present Bank Set Point	(See note 2.)	#10 ch2 Process Value	(See note 2.)
First word + 36	#15 ch1 Present Bank Set Point	(See note 2.)	#11 ch1 Process Value	(See note 2.)
First word + 37	#15 ch2 Present Bank Set Point	(See note 2.)	#11 ch2 Process Value	(See note 2.)
First word + 38	---	---	#12 ch1 Process Value	(See note 2.)
First word + 39	---	---	#12 ch2 Process Value	(See note 2.)
First word + 40	---	---	#13 ch1 Process Value	(See note 2.)
First word + 41	---	---	#13 ch2 Process Value	(See note 2.)
First word + 42	---	---	#14 ch1 Process Value	(See note 2.)
First word + 43	---	---	#14 ch2 Process Value	(See note 2.)
First word + 44	---	---	#15 ch1 Process Value	(See note 2.)
First word + 45	---	---	#15 ch2 Process Value	(See note 2.)

- Note**
1. Individual bits will be enabled only through those allocated to the highest communications unit number.
  2. Words will be allocated only through those for the highest communications unit number.

Example:

If the highest communications unit number is set to 10, then the OUT Area will be the 28 words, i.e., from the first word to the first word + 27.

### **Simple I/O Allocation with TC4 Selected (DIP switch pin 2 ON)**

Address	OUT Area		IN Area	
First word + 0	OUT Enable Bit	---	Communications Status	(See note 1.)
First word + 1	Not used.	---	Communications Error Status	(See note 1.)
First word + 2	RUN/STOP (TC4: #00–#03)	(See note 1.)	RUN/STOP (TC2: #00–#03)	(See note 1.)
First word + 3	RUN/STOP (TC4: #04–#07)	(See note 1.)	RUN/STOP (TC2: #04–#07)	(See note 1.)
First word + 4	RUN/STOP (TC4: #08–#11)	(See note 1.)	RUN/STOP (TC2: #08–#11)	(See note 1.)
First word + 5	RUN/STOP (TC4: #12–#15)	(See note 1.)	RUN/STOP (TC2: #12–#15)	(See note 1.)
First word + 6	AT Execute/Cancel (TC4: #00–#03)	(See note 1.)	AT Execute/Cancel (TC4: #00–#03)	(See note 1.)
First word + 7	AT Execute/Cancel (TC4: #04–#07)	(See note 1.)	AT Execute/Cancel (TC4: #04–#07)	(See note 1.)
First word + 8	AT Execute/Cancel (TC4: #08–#11)	(See note 1.)	AT Execute/Cancel (TC4: #08–#11)	(See note 1.)
First word + 9	AT Execute/Cancel (TC4: #12–#15)	(See note 1.)	AT Execute/Cancel (TC4: #12–#15)	(See note 1.)
First word + 10	#0 ch1 Present Bank Set Point	(See note 2.)	Alarm 1 (TC4: #00–#03)	(See note 1.)
First word + 11	#0 ch2 Present Bank Set Point	(See note 2.)	Alarm 1 (TC4: #04–#07)	(See note 1.)
First word + 12	#0 ch3 Present Bank Set Point	(See note 2.)	Alarm 1 (TC4: #08–#11)	(See note 1.)
First word + 13	#0 ch4 Present Bank Set Point	(See note 2.)	Alarm 1 (TC4: #12–#15)	(See note 1.)
First word + 14	#1 ch1 Present Bank Set Point	(See note 2.)	Alarm 2 (TC4: #00–#03)	(See note 1.)
First word + 15	#1 ch2 Present Bank Set Point	(See note 2.)	Alarm 2 (TC4: #04–#07)	(See note 1.)
First word + 16	#1 ch3 Present Bank Set Point	(See note 2.)	Alarm 2 (TC4: #08–#11)	(See note 1.)
First word + 17	#1 ch4 Present Bank Set Point	(See note 2.)	Alarm 2 (TC4: #12–#15)	(See note 1.)
First word + 18	#2 ch1 Present Bank Set Point	(See note 2.)	Alarm 3 (TC4: #00–#03)	(See note 1.)
First word + 19	#2 ch2 Present Bank Set Point	(See note 2.)	Alarm 3 (TC4: #04–#07)	(See note 1.)



Address	OUT Area		IN Area	
First word + 69	#14 ch4 Present Bank Set Point	(See note 2.)	#11 ch4 Process Value	(See note 2.)
First word + 70	#15 ch1 Present Bank Set Point	(See note 2.)	#12 ch1 Process Value	(See note 2.)
First word + 71	#15 ch2 Present Bank Set Point	(See note 2.)	#12 ch2 Process Value	(See note 2.)
First word + 72	#15 ch3 Present Bank Set Point	(See note 2.)	#12 ch3 Process Value	(See note 2.)
First word + 73	#15 ch4 Present Bank Set Point	(See note 2.)	#12 ch4 Process Value	(See note 2.)
First word + 74	---	---	#13 ch1 Process Value	(See note 2.)
First word + 75	---	---	#13 ch2 Process Value	(See note 2.)
First word + 76	---	---	#13 ch3 Process Value	(See note 2.)
First word + 77	---	---	#13 ch4 Process Value	(See note 2.)
First word + 78	---	---	#14 ch1 Process Value	(See note 2.)
First word + 79	---	---	#14 ch2 Process Value	(See note 2.)
First word + 80	---	---	#14 ch3 Process Value	(See note 2.)
First word + 81	---	---	#14 ch4 Process Value	(See note 2.)
First word + 82	---	---	#15 ch1 Process Value	(See note 2.)
First word + 83	---	---	#15 ch2 Process Value	(See note 2.)
First word + 84	---	---	#15 ch3 Process Value	(See note 2.)
First word + 85	---	---	#15 ch4 Process Value	(See note 2.)

- Note**
1. Individual bits will be enabled only through those allocated to the highest communications unit number.
  2. Words will be allocated only through the highest communications unit number.

Example:

If the highest communications unit number is set to 10, then the IN Area will be the 66 words, i.e., from the first word to the first word + 65.

### 4-2-3 Allocating Data in the Master

Data is allocated in the master in the same way as other slaves using either fixed allocations or user-set allocations.

- Note** The sizes of the IN and OUT Areas allocated to the DeviceNet Communications Unit are larger than for other slaves, so make sure that the allocated words are within the DeviceNet Area and do not overlap with words used by other slaves.

#### Fixed Allocations

When fixed allocations are used, the location for allocated data is automatically determined according to the node address of the DeviceNet Communications Unit. Fixed allocations can be set without the Configurator.

With fixed allocations, however, each node address is allocated one word. Therefore, the node addresses allocated to the DeviceNet Communications Unit cannot be used by other nodes, as shown below.

TC2	IN Area	Allocated 16 to 46 words, therefore, uses 16 to 46 node addresses.
	OUT Area	Allocated 8 to 38 words, therefore, uses 8 to 38 node addresses.
TC4 (See note.)	IN Area	Allocated 26 to 86 words, therefore, uses 26 to 86 node addresses.
	OUT Area	Allocated 14 to 74 words, therefore, uses 14 to 74 node addresses.

**Note** Fixed allocations cannot be used if 11 or more TC4 Units are used. Use user-set allocations.

### **User-set Allocations**

With user-set allocations, the Configurator can be used to allocate I/O to the DeviceNet Communications Unit in any location of the CPU Unit's I/O memory area.

The configuration of the DeviceNet Communications Unit's allocation data is fixed, so the data can be used by merely allocating it in the master. For actual allocating methods, refer to *4-5 Allocating Data in the Master*.

- Note**
1. When performing user-set allocations from a DeviceNet Configurator, use Ver. 2.44 or higher. When using the CX-Integrator, use Ver. 2.2 or higher.
  2. When using a CS/CJ-series DeviceNet Unit as the master, the location and size of the DeviceNet Area can be specified through the allocated DM Area words, without using the Configurator. For slaves, however, I/O is allocated in the DeviceNet Area in node-address order. For details, refer to the *CS/CJ-series DeviceNet Unit Operation Manual* (Cat. No. W380).

## **4-3 Allocating I/O from the Configurator**

### **4-3-1 Setting Allocation Data**

Use the Configurator to allocate data other than the process values and set points (such as PID constants), or to allocate only that data that is required.

Turn OFF pin 1 of the DIP switch of the DeviceNet Communications Unit to enable I/O to be allocated from the Configurator.

Create the allocation data by selecting any data from the list of parameters using the Configurator. Download the allocation data that has been edited using the Configurator to the DeviceNet Communications Unit.

Any allocation size can be set within the following range according to the number of allocation parameters that have been selected.

- IN Area: 0 to 100 words
- OUT Area: 0 to 100 words

**Note** If too many allocation data parameters are selected, the area available for other slaves may not be sufficient, or the Network may become overloaded. Therefore, restrict the data to those parameters that require relatively frequent reading or writing, and use explicit messages to read and write other data.

### **4-3-2 Creating Allocation Data**

Allocation data is specified using the Configurator and then downloaded to the DeviceNet Communications Unit. Any data can be selected from the list of parameters, and then allocated freely in the IN Area (up to 100 words) and OUT Area (up to 100 words).



When a CS/CJ-series DeviceNet Unit is used, the IN Area can be divided into two separate blocks by using two connection methods. This function is used to allocate IN data in different areas.

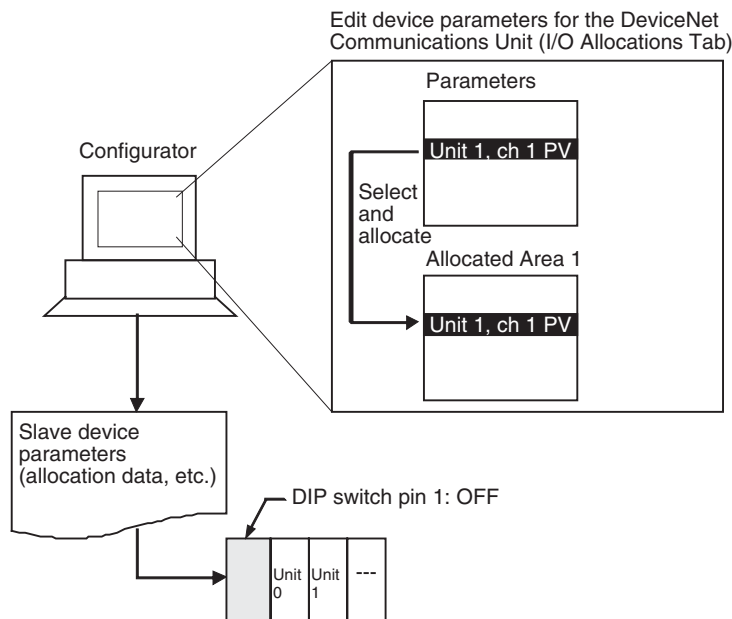

**Note** The maximum allocation size for the IN and OUT Areas (100 words) applies to the DeviceNet Communications Unit, and does not apply to the size of allocations in the Master Unit. For details on allocation sizes in the Master Unit, refer to the operation manual for the Master Unit being used.

### Creating Data from the DeviceNet Configurator (Ver. 2.44 or Higher) (or CX-Integrator Ver. 2.2 or higher)

If problems occur in the connection with the Configurator, change the master settings. Problems will occur if the master's message timeout time is too short or the I/O size allocated in the master is different from that allocated in the DeviceNet Communications Unit. For details on setting methods, refer to 5-2-1 *Preparing the Configurator Connection*.

- 1,2,3...**
1. Select the DeviceNet Communications Unit in the Network Configuration Window, and double-click, or right-click and select **Parameters** and **Edit** to display the Edit Device Parameters Window.

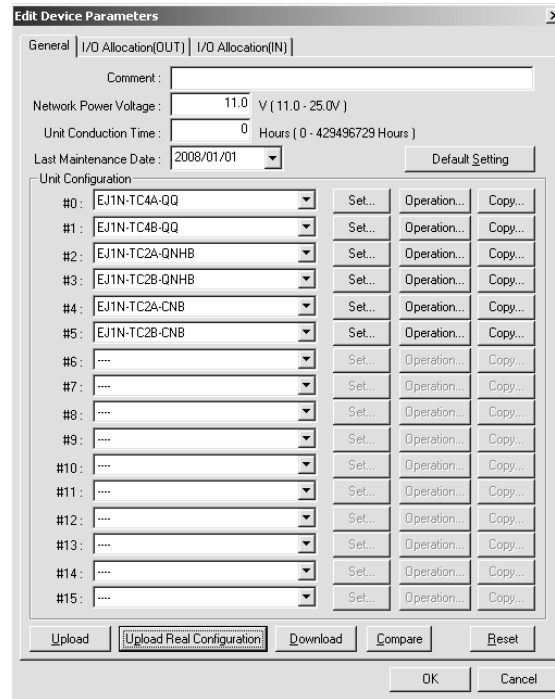
2. Select the **General** Tab.

### ■ **Uploading the Real Configuration Online**

3. With the Configurator online, click the **Upload Real Configuration** Button. The real configuration will be uploaded, and the configuration of the Temperature Controllers that are currently connected to the DeviceNet Communications Unit and all the parameters for these Temperature Controllers will be read.

- Note a) Click the **Upload** Button to read the connection configuration recorded in the DeviceNet Communications Unit and all the parameters for the Temperature Controllers that are registered in the configuration. The window display will refresh at the same time.
- b) Click the **Download** Button to instantly write all the settings that have been set using the Configurator to the DeviceNet Communications Unit and the Temperature Controllers. The Temperature Controllers that have been written to will be reset automatically to enable the settings. (The status of the Temperature Controllers will be the same as if the power had been turned OFF and ON again.)
- c) Click the **Compare** Button to compare the parameters set from the Configurator with the parameters set in the DeviceNet Communications Unit and in all the Temperature Controllers.

### ■ **Editing the Connection Configuration Offline**

Edit the Temperature Controller connection configuration (Unit configuration) in the General Tab Page. Click the ▼ Button beside the communications unit number under *Unit Configuration*, and specify the type of Temperature Controller for the selected communications unit number.

Leave the field blank for unit numbers that are not allocated to Temperature Controller.

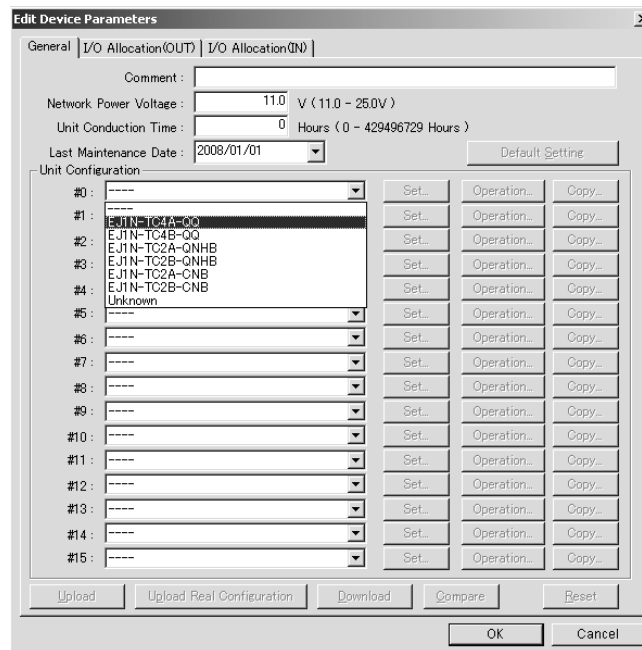

**Note** Click the Set Button to display the Edit Unit Parameters Window and then edit the parameters of the corresponding Temperature Controller (refer to page 93). Click the Operation Button to display the Operation Commands for Units Window, and control the corresponding Temperature Controller (refer to page 91). Click the Copy Button to copy parameters between Temperature Controllers simply by specifying the copy source and destination. (refer to page 89).

4. Create Allocation Data for the OUT Area  
Create the allocation data for the OUT Area in the I/O Allocations (OUT) Tab Page. Select the data to be allocated from the list in the *Parameters* field (top half of window), and drag the corresponding word to one of the Allocation Areas (bottom half of window). Alternatively, select the parameter to be allocated and click the **Allocate** Button to display the I/O Allocations Dialog Box. Specify the allocation destination and click the **OK** Button.

**Note** a) The number of words from the first word is shown as +□, where the box indicates the number.

- b) To delete an allocated parameter, select the parameter in the Allocation Area field, and click the **Release** Button. To delete all the allocated items, click the **Release All** Button. The Allocated Area field will become blank.

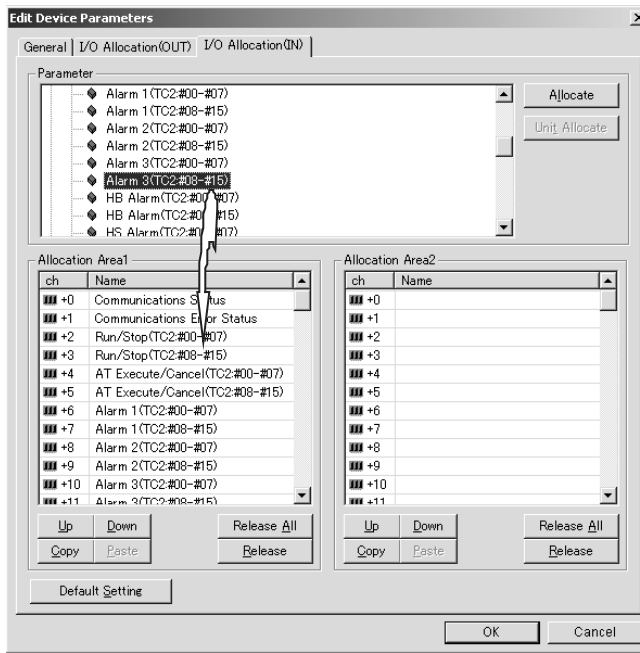





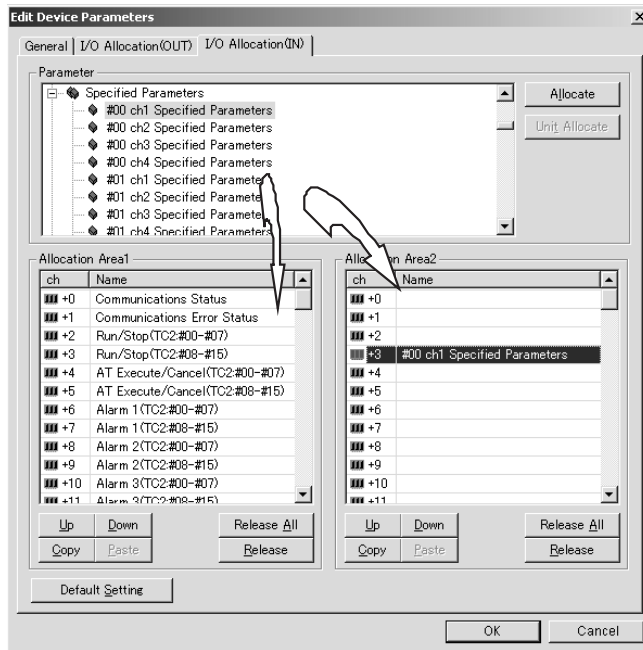

Icon	Description
(Gray)	Allocation not possible (parameter for unit number not in configuration or OUT Enable Bit).
(Pink)	Allocation possible (parameter for unit number in configuration).
	Reserved (for OUT Enable Bit).
(Green)	Parameter for unit number in configuration and not yet assigned.
(Blue)	Parameter for unit number not in configuration.

- Note a) The first word of the allocation area is for the OUT Enable Bit. This allocation cannot be changed. If any data is assigned to the second word or higher, the OUT Enable Bit will be assigned automatically.
- b) Do not assign the same parameter more than once.
  - c) No processing will be performed for parameters for unit numbers that are not in the configuration.

5. Create Allocation Data for the IN Area

Create the allocation data for the IN Area in the IN Allocations Tab Page. Select the parameters to be allocated from the list in the *Parameters* field (top half of window), and drag to the corresponding word in the Allocation area areas (bottom half of window). Allocations can also be performed using the **Allocate** Button in the same way as for the OUT Area.



Icon	Description
 (Gray)	Allocation not possible (parameter for unit number not in configuration or OUT Enable Bit).
 (Pink)	Allocation possible (parameter for unit number in configuration).
	Reserved (for OUT Enable Bit).
 (Green)	Parameter for unit number in configuration and not yet assigned.
 (Blue)	Parameter for unit number not in configuration.

Note a) When using a CS/CJ-series DeviceNet Unit as the master, the IN Area can be divided into two separate areas. When allocating data, drag the parameter to either the IN Area field on the left or right (Allocation Area 1 or Allocation Area 2). To create these two areas, however, two connections must be defined by the user between the master and DeviceNet Communications Unit on the Edit Device Parameters Window for the master. For details, refer to *Setting Connections when Dividing IN Area in Two* under 4-5-2 *User-set Allocations*.

- b) Do not assign the same parameter more than once.
  - c) No processing will be performed for parameters for unit numbers that are not in the configuration.
6. Return to the **General** Tab, and click the **Download** Button. The device parameters (connection configuration, allocation data) will be registered in the DeviceNet Communications Unit.
  7. Always click the **OK** Button to exit the Edit Device Parameters Window.

**Description of Windows: Edit DeviceNet Parameter Window**

**General Tab Page**

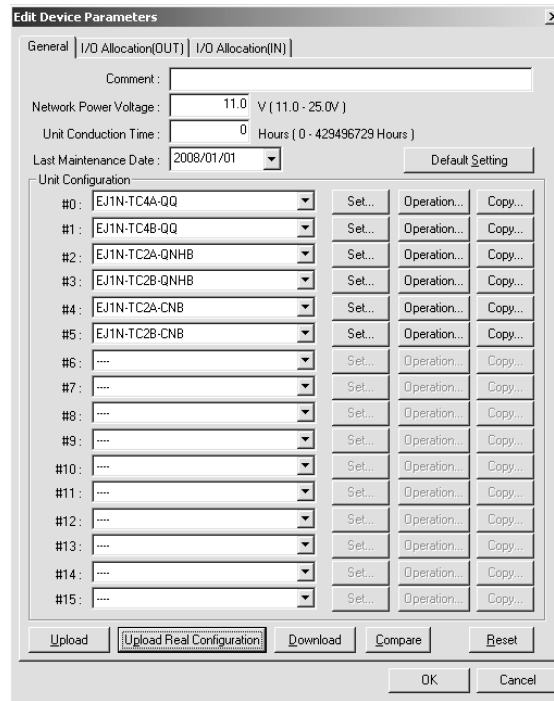

Item	Description
Comment	Input a comment for the Temperature Controller.
Network Power Voltage	Input the monitor value for the power supply voltage. Input a value from 11.0 to 25.0 VDC.
Unit Conduction Time Monitor Value	Input the monitor value for the unit conduction time (i.e., the time that communications power is supplied).
Last Maintenance Time	Use the pull-down menu to specify the last date on which maintenance was performed.
Default Setting Button	Click the <b>Default Setting</b> Button to initialize all settings in the DeviceNet Communications Unit to the defaults. The Configurator display, however, will not return to the defaults. Press the <b>Upload</b> Button to read the settings again. <b>Note</b> The message monitor timer must be changed to use this function. Refer to page 107 for details.
Unit Configuration	Set the models of Temperature Controllers connected to the DeviceNet Communications Unit.

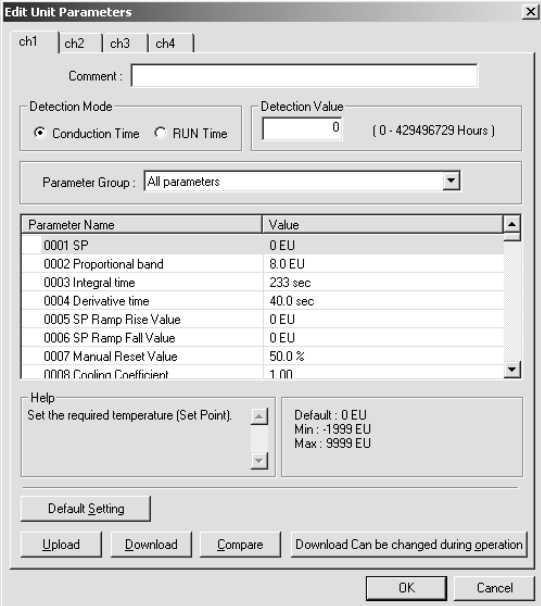
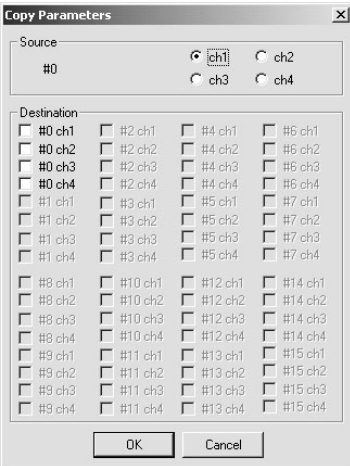
Item	Description
Set Buttons	<p>Click a <b>Set</b> Button to display the Edit Unit Parameters Menu, and then set the Temperature Controller parameters. Double-click the parameter name to set a value.</p> 
Operation Buttons	<p>Click an <b>Operation</b> Button to send an operation command to the Temperature Controller. The Temperature Controller can be controlled in the <i>Operation Commands for Units Window</i>. For details, refer to <i>5-2-8 Sending Operation Commands to the Temperature Controllers</i>.</p>
Copy Buttons	<p>Click a <b>Copy</b> Button to copy parameters from one Temperature Controller to another. Select the channel number to be copied from and then select the channel of the unit number to be copied to.</p> 
Upload Button	<p>Click the <b>Upload</b> Button to read the DeviceNet Communications Unit settings, registered unit configuration, and Temperature Controller parameter settings.</p>
Upload Real Configuration Button	<p>Click the <b>Upload Real Configuration</b> Button to read the DeviceNet Communications Unit settings, real unit configuration, and Temperature Controller parameter settings.</p>
Download Button	<p>Click the <b>Download</b> Button to write the settings in the Configurator to the DeviceNet Communications Unit and Temperature Controllers.</p>

Item	Description
Compare Button	Click the <b>Compare</b> Button to compare the settings in the Configurator with the settings in the Units.
Reset Button	Click the <b>Reset</b> Button to reset the DeviceNet Communications Unit and the Temperature Controllers (in the same way as when the power is cycled). Temperature Controllers, however, will not be reset during operation.

**I/O Allocation (OUT) Tab Page and I/O Allocation (IN) Tab Page**

**Note** The I/O Allocation (OUT) Tab Page and I/O Allocation (IN) Tab Page have the same format.

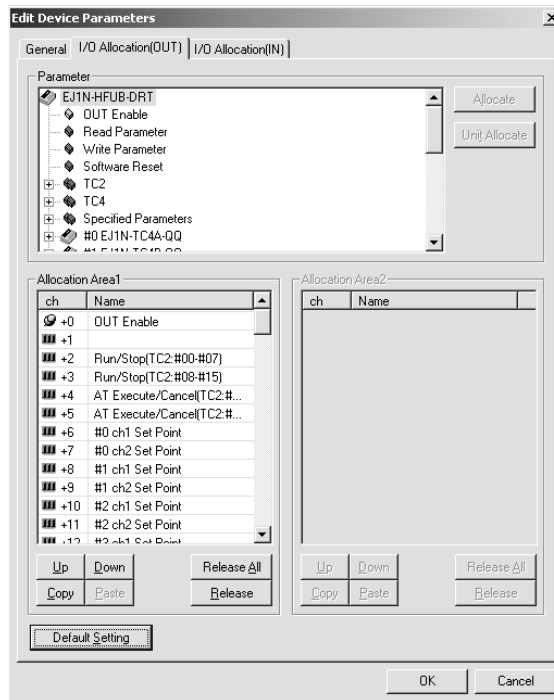

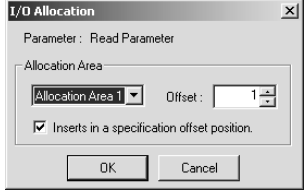
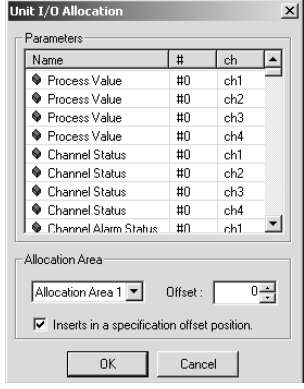

Item	Description
Allocate Button	<p>Select the parameter and click the <b>Allocate</b> Button. The following I/O Allocation Window will be displayed. Select the allocation area and allocation position.</p> 
Unit Allocate Button	<p>Select the unit number icon of the Temperature Controller and click the <b>Unit Allocate</b> Button. The Unit I/O Allocation Window will be displayed. Select the parameter to be allocated and the allocation position.</p> 
Up Button	Moves the selected parameter up.
Down Button	Moves the selected parameter down.
Copy Button	Copies the selected parameter.
Paste Button	Pastes the copied parameter.
Release All Button	Clears all allocations.
Release	Clears the selected parameter.
Default setting Button	Returns allocations to the defaults.

**Note** Individual parameters can be selected by pressing the Ctrl Key while selecting the parameters. Ranges of parameters can be selected by pressing the Shift Key while selecting a second parameter.

### 4-3-3 Parameters for Which Allocation Is Possible

Broadly speaking, there are three types of parameters that can be assigned to memory: operation command and status parameters, monitor parameters, and parameters that can be changed during operation. The numbers given in the tables for monitor parameters and parameters that can be changed during operation are allocation numbers, and are used when operating with expansion remote I/O. For information on how to use each parameter, refer to the *EJ1 Modular Temperature Controller User's Manual* (Cat. No. H142).

#### Operation Command and Status Parameters

These parameters are for write processing, operation commands, reading status, and expansion remote I/O for Temperature Controllers. These parameters are managed by the DeviceNet Communications Unit and are not in the variable area of the Temperature Controllers.

TC2

Assigned to IN Area	Assigned to OUT Area	Parameter name
Yes	No	Output Completed Flags
Yes	No	Read Parameter Monitor (See note 2.)
No	Yes	OUT Enable Bit (See note 1.)
No	Yes	OUT Enable Bit 2
No	Yes	Read Parameter (See note 2.)
No	Yes	Write Parameter (See note 2.)
Yes	No	Communications Status
Yes	No	Communications Error Status
Yes	No	Unit Status
Yes	No	Alarm 1 (TC2: #00–#07)
Yes	No	Alarm 1 (TC2: #08–#15)
Yes	No	Alarm 2 (TC2: #00–#07)
Yes	No	Alarm 2 (TC2: #08–#15)
Yes	No	Alarm 3 (TC2: #00–#07)
Yes	No	Alarm 3 (TC2: #08–#15)
Yes	No	HB Alarm (TC2: #00–#07)
Yes	No	HB Alarm (TC2: #08–#15)
Yes	No	HS Alarm (TC2: #00–#07)
Yes	No	HS Alarm (TC2: #08–#15)
Yes	No	OC Alarm (TC2: #00–#07)
Yes	No	OC Alarm (TC2: #08–#15)
Yes	No	Input Error (TC2: #00–#07)
Yes	No	Input Error (TC2: #08–#15)
Yes	Yes	Run/Stop (TC2: #00–#07)
Yes	Yes	Run/Stop (TC2: #08–#15)
Yes	Yes	AT Execute/Cancel (TC2: #00–#07)
Yes	Yes	AT Execute/Cancel (TC2: #08–#15)
Yes	Yes	Auto/Manual (TC2: #00–#07)
Yes	Yes	Auto/Manual (TC2: #08–#15)
No	Yes	Software Reset
Yes	Yes	#0 ch1 Specified Parameters (See note 2.)
Yes	Yes	#0 ch2 Specified Parameters (See note 2.)
Yes	Yes	#1 ch1 Specified Parameters (See note 2.)
Yes	Yes	---
Yes	Yes	#15 ch2 Specified Parameters (See note 2.)

- Note**
1. Always allocate the first word of the OUT Area to the OUT Enable Bit.
  2. These parameters are for expansion remote I/O.

TC4

Allocated in IN Area	Allocated in OUT Area	Parameter name
Yes	No	Output Completed Flags
Yes	No	Read Parameter Monitor (See note 2.)
No	Yes	OUT Enable Bit (See note 1.)
No	Yes	OUT Enable Bit 2
No	Yes	Read Parameter (See note 2.)
No	Yes	Write Parameter (See note 2.)

Allocated in IN Area	Allocated in OUT Area	Parameter name
Yes	No	Communications Status
Yes	No	Communications Error Status
Yes	No	Unit Status
Yes	No	Alarm 1 (TC4: #00–#03)
Yes	No	Alarm 1 (TC4: #04–#07)
Yes	No	Alarm 1 (TC4: #08–#11)
Yes	No	Alarm 1 (TC4: #12–#15)
Yes	No	Alarm 2 (TC4: #00–#03)
Yes	No	Alarm 2 (TC4: #04–#07)
Yes	No	Alarm 2 (TC4: #08–#11)
Yes	No	Alarm 2 (TC4: #012–#15)
Yes	No	Alarm 3 (TC4: #00–#03)
Yes	No	Alarm 3 (TC4: #04–#07)
Yes	No	Alarm 3 (TC4: #08–#011)
Yes	No	Alarm 3 (TC4: #012–#15)
Yes	No	Input Error (TC4: #00–#03)
Yes	No	Input Error (TC4: #04–#07)
Yes	No	Input Error (TC4: #08–#11)
Yes	No	Input Error (TC4: #12–#15)
Yes	Yes	Run/Stop (TC4: #00–#03)
Yes	Yes	Run/Stop (TC4: #04–#07)
Yes	Yes	Run/Stop (TC4: #08–#11)
Yes	Yes	Run/Stop (TC4: #12–#15)
Yes	Yes	AT Execute/Cancel (TC4: #00–#03)
Yes	Yes	AT Execute/Cancel (TC4: #04–#07)
Yes	Yes	AT Execute/Cancel (TC4: #08–#11)
Yes	Yes	AT Execute/Cancel (TC4: #12–#15)
Yes	Yes	Auto/Manual (TC2: #00–#03)
Yes	Yes	Auto/Manual (TC2: #04–#07)
Yes	Yes	Auto/Manual (TC2: #08–#11)
Yes	Yes	Auto/Manual (TC2: #12–#15)
No	Yes	Software Reset
Yes	Yes	#0 ch1 Specified Parameters (See note 2.)
Yes	Yes	#0 ch2 Specified Parameters (See note 2.)
Yes	Yes	#0 ch3 Specified Parameters (See note 2.)
Yes	Yes	#0 ch4 Specified Parameters (See note 2.)
Yes	Yes	#1 ch1 Specified Parameters (See note 2.)
Yes	Yes	---
Yes	Yes	#15 ch4 Specified Parameters (See note 2.)

- Note**
1. Always allocate the first word of the OUT Area to the OUT Enable Bit.
  2. These parameters are for expansion remote I/O.

**Monitor Parameters  
(TC4 and TC2)**

These parameters are for monitoring PV, SP, and other data of the Temperature Controller.

Allocated in IN Area	Allocated in OUT Area	Parameter name	Allocation number for expansion remote I/O
Yes	No	Device A Status	1 (1 hex)
Yes	No	Configuration Error A Status	3 (3 hex)
Yes	No	Configuration Error B Status	4 (4 hex)
Yes	No	Internal Communications Error Status	5 (5 hex)
Yes	No	I/O Error Status	6 (6 hex)
Yes	No	I/O Alarm A Status (See note 1.)	7 (7 hex)
Yes	No	I/O Alarm B Status (See note 1.)	8 (8 hex)
Yes	No	I/O Notification A Status (See note 1.)	9 (9 hex)
Yes	No	Error Channel A Status	10 (A hex)
Yes	No	Basic Unit/Expand Unit Error	11 (B hex)
Yes	No	Basic Unit/Expand Unit Alarm	12 (C hex)
Yes	No	Output Status	13 (D hex)
Yes	No	Device B Status	14 (E hex)
Yes	No	Process Value	15 (F hex)
Yes	No	Channel Status	16 (10 hex)
Yes	No	Channel Alarm Status	17 (11 hex)
Yes	No	Internal SP	18 (12 hex)
Yes	No	Local SP Monitor	19 (13 hex)
Yes	No	Remote SP Monitor	20 (14 hex)
Yes	No	Bank No. Monitor	21 (15 hex)
Yes	No	MV Monitor (Heating)	22 (16 hex)
Yes	No	MV Monitor (Cooling)	23 (17 hex)
Yes	No	Decimal Point Monitor	24 (18 hex)
Yes	No	Heater Current Value Monitor (See note 1.)	25 (19 hex)
Yes	No	Leakage Current Value Monitor (See note 1.)	26 (1A hex)
Yes	No	G3ZA CH1 Control Variable Monitor (See note 2.)	67 (43 hex)
Yes	No	G3ZA CH2 Control Variable Monitor (See note 2.)	68 (44 hex)
Yes	No	G3ZA CH3 Control Variable Monitor (See note 2.)	69 (45 hex)
Yes	No	G3ZA CH4 Control Variable Monitor (See note 2.)	70 (46 hex)
Yes	No	G3ZA CH5 Control Variable Monitor (See note 2.)	71 (47 hex)
Yes	No	G3ZA CH6 Control Variable Monitor (See note 2.)	72 (48 hex)
Yes	No	G3ZA CH7 Control Variable Monitor (See note 2.)	73 (49 hex)
Yes	No	G3ZA CH8 Control Variable Monitor (See note 2.)	74 (4A hex)
Yes	No	G3ZA CH1 Status (See note 2.)	75 (4B hex)
Yes	No	G3ZA CH2 Status (See note 2.)	76 (4C hex)
Yes	No	G3ZA CH3 Status (See note 2.)	77 (4D hex)
Yes	No	G3ZA CH4 Status (See note 2.)	78 (4E hex)

Allocated in IN Area	Allocated in OUT Area	Parameter name	Allocation number for expansion remote I/O
Yes	No	G3ZA CH5 Status (See note 2.)	79 (4F hex)
Yes	No	G3ZA CH6 Status (See note 2.)	80 (50 hex)
Yes	No	G3ZA CH7 Status (See note 2.)	81 (51 hex)
Yes	No	G3ZA CH8 Status (See note 2.)	82 (52 hex)
Yes	No	G3ZA CH1 Heater ON Current Monitor (See note 2.)	83 (53 hex)
Yes	No	G3ZA CH2 Heater ON Current Monitor (See note 2.)	84 (54 hex)
Yes	No	G3ZA CH3 Heater ON Current Monitor (See note 2.)	85 (55 hex)
Yes	No	G3ZA CH4 Heater ON Current Monitor (See note 2.)	86 (56 hex)
Yes	No	G3ZA CH1 Heater OFF Current Monitor (See note 2.)	87 (57 hex)
Yes	No	G3ZA CH2 Heater OFF Current Monitor (See note 2.)	88 (58 hex)
Yes	No	G3ZA CH3 Heater OFF Current Monitor (See note 2.)	89 (59 hex)
Yes	No	G3ZA CH4 Heater OFF Current Monitor (See note 2.)	90 (5A hex)

- Note**
1. Can be used with TC2, but not with TC4.
  2. Monitoring can be performed for up to four G3ZA Power Controllers per Temperature Controller. Each channel of the Temperature Controller corresponds to one G3ZA Power Controller. (Example: ch1 → G3ZA1)

**Parameters That Can Be Changed during Operation (TC4 and TC2)**

These parameters, such as the SP, PID, and alarm values, can be changed during operation of the Temperature Controller.

Allocated in IN Area	Allocated in OUT Area	Parameter name	Allocation number for expansion remote I/O
Yes	Yes	Present Bank Set Point	27 (1B hex)
Yes	Yes	Present Bank Proportional Band	28 (1C hex)
Yes	Yes	Present Bank Integral Time	29 (1D hex)
Yes	Yes	Present Bank Derivative Time	30 (1E hex)
Yes	Yes	Present Bank SP Ramp Rise Value	31 (1F hex)
Yes	Yes	Present Bank SP Ramp Fall Value	32 (20 hex)
Yes	Yes	Present Bank Manual Reset Value	33 (21 hex)
Yes	Yes	Present Bank Cooling Coefficient	34 (22 hex)
Yes	Yes	Present Bank Dead Band	35 (23 hex)
Yes	Yes	Present Bank Alarm Value	36 (24 hex)
Yes	Yes	Present Bank Alarm Upper Limit Value 1	37 (25 hex)
Yes	Yes	Present Bank Alarm Lower Limit Value 1	38 (26 hex)
Yes	Yes	Present Bank Alarm Value 2	39 (27 hex)
Yes	Yes	Present Bank Alarm Upper Limit Value 2	40 (28 hex)
Yes	Yes	Present Bank Alarm Lower Limit Value 2	41 (29 hex)
Yes	Yes	Present Bank Alarm Value 3	42 (2A hex)
Yes	Yes	Present Bank Alarm Upper Limit Value 3	43 (2B hex)
Yes	Yes	Present Bank Alarm Lower Limit Value 3	44 (2C hex)

Allocated in IN Area	Allocated in OUT Area	Parameter name	Allocation number for expansion remote I/O
Yes	Yes	Input Digital Filter	45 (2D hex)
Yes	Yes	Input Value for Input Correction	46 (2Ehex)
Yes	Yes	Input Shift 1	47 (2F hex)
Yes	Yes	Input Value 2 for Input Correction	48 (30 hex)
Yes	Yes	Input Shift 2	49 (31 hex)
Yes	Yes	MV at PV Error	50 (32 hex)
Yes	Yes	MV at Stop	51 (33 hex)
Yes	Yes	MV Upper Limit	52 (34 hex)
Yes	Yes	MV Lower Limit	53 (35 hex)
Yes	Yes	Hysteresis (Heating)	54 (36 hex)
Yes	Yes	Hysteresis (Cooling)	55 (37 hex)
Yes	Yes	Alpha	56 (38 hex)
Yes	Yes	Manual MV	57 (39 hex)
Yes	Yes	SP Upper Limit	58 (3A hex)
Yes	Yes	SP Lower Limit	59 (3B hex)
Yes	Yes	Disturbance Gain	60 (3C hex)
Yes	Yes	Disturbance Time Constant	61 (3D hex)
Yes	Yes	Disturbance Rectification Band	62 (3E hex)
Yes	Yes	Disturbance Judgement Width	63 (3F hex)
Yes	Yes	Heater Burnout 1 Detection (See note.)	64 (40 hex)
Yes	Yes	HS Alarm 1 (See note.)	65 (41 hex)
Yes	Yes	Heater Overcurrent 1 Detection (See note.)	66 (42 hex)

**Note** Can be used with TC2, but not with TC4.

### 4-3-4 Input Data

Input data that is specific to the DeviceNet Communications Unit and that is not allocated in the Temperature Controller variable area is described here.

#### TC4 and TC2

#### Output Completed Flags

15	14	13	12	11	10	9	8	7	6	5	4	3	2	1	0	Bit
(2)	0	0	0	0	0	0	0	0	0	0	0	0	0	0	0	(1)

Number	Description
(1)	ON: Writing to the OUT Area has been completed. (After the OUT Enable Bit is turned ON, this flag (bit 00) turns ON when writing is completed, even if an error occurs during writing.) OFF: Writing to OUT Area is stopped. (After the OUT Enable Bit turns OFF and the OFF status is received, this flag (bit 00) turns OFF. This flag (bit 00) also turns OFF when the power supply is turned OFF.)
(2)	ON: An error occurred during writing to the OUT Area. (This flag (bit 15) turns OFF when the Output Enable Bit turns OFF.) OFF: Writing to the OUT Area has completed normally.

**Note** The word containing the Output Completed Flags will be 0001 hex if writing is ends normally or 8001 hex if writing ends in an error.

**Read Parameter Monitor**

15 14 13 12 11 10 9 8 7 6 5 4 3 2 1 0 Bit

--	--	--	--	--	--	--	--	--	--	--	--	--	--	--	--

When the Read Parameter is designated for expansion remote I/O, the allocation number set for the Read Parameter is stored here after the specified parameter has been read. The Read Parameter Monitor cannot be used with simple I/O allocations.

**Communications Status**

15 14 13 12 11 10 9 8 7 6 5 4 3 2 1 0 Bit

Unit	Unit	Unit	Unit	Unit	Unit	Unit	Unit	Unit	Unit	Unit	Unit	Unit	Unit	Unit	Unit
15	14	13	12	11	10	9	8	7	6	5	4	3	2	1	0

ON: The DeviceNet Communications Unit is communicating with the Temperature Controller registered in the connection configuration for the specified communication unit number.

OFF: A communications error has occurred in communications with the Temperature Controller registered in the connection configuration, or the communications unit number belongs to a Temperature Controller that is not registered in the connection configuration.

These bit always show the status of communications with the Temperature Controllers registered in the connection configuration. When a Temperature Controller with a communications error returns to normal communications, the corresponding bit will automatically turn ON.

**Communications Error Status**

15 14 13 12 11 10 9 8 7 6 5 4 3 2 1 0 Bit

Unit	Unit	Unit	Unit	Unit	Unit	Unit	Unit	Unit	Unit	Unit	Unit	Unit	Unit	Unit	Unit
15	14	13	12	11	10	9	8	7	6	5	4	3	2	1	0

ON: A communications error has occurred in communications with the Temperature Controller registered in the connection configuration for the specified communication unit number.

OFF: The DeviceNet Communications Unit is communicating with the Temperature Controller registered in the connection configuration for the specified communication unit number or the communications unit number belongs to a Temperature Controller that is not registered in the connection configuration.

These bits always show the status of communications with the Temperature Controllers registered in the connection configuration. When an error occurs in communications with a Temperature Controller registered in the connection configuration, the corresponding bit will turn ON. The bit will automatically turn OFF when communications return to normal.

**Unit Status**

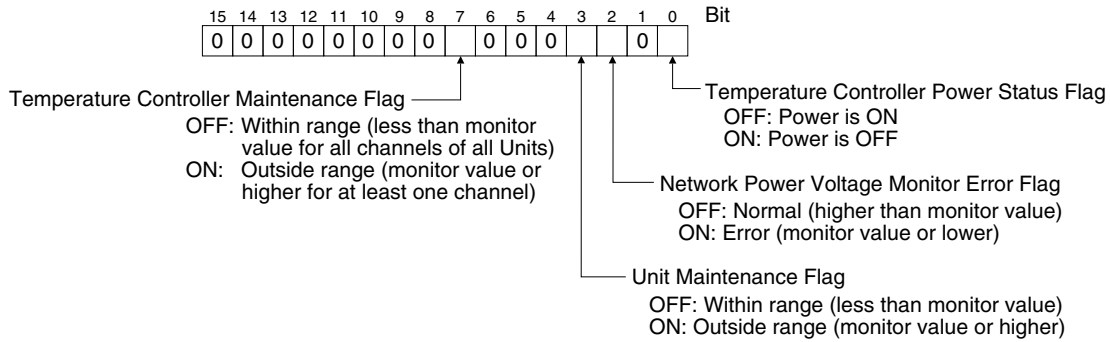

- The Temperature Controller Power Status Flag indicates the status of the power supplied to the End Unit.
- The Communications Power Voltage Monitor Error Flag indicates the status of the power being supplied through the DeviceNet communications cables. For details, refer to 5-2-4 *Setting Network Power Voltage Monitor*.
- The Unit Maintenance Flag turns ON when the conduction time for the DeviceNet Communications Unit exceeds the specified monitor value. For details, refer to 5-2-5 *Setting the Unit Conduction Time Monitor*.
- The Temperature Controller Maintenance Flag turns ON when the Unit conduction time or total RUN time of one or more channel of the Temperature Controllers registered in the connection configuration exceeds the specified monitor value. For details, refer to 5-2-11 *Setting Temperature Controller Monitor Mode and Monitor Values*.

**TC2**

**Alarms 1, 2, and 3 and HB, HS, and OC Alarms**

Bit	15	14	13	12	11	10	9	8	7	6	5	4	3	2	1	0
Units 00 to 07	Unit 7		Unit 6		Unit 5		Unit 4		Unit 3		Unit 2		Unit 1		Unit 0	
	ch2	ch1	ch2	ch1	ch2	ch1	ch2	ch1	ch2	ch1	ch2	ch1	ch2	ch1	ch2	ch1
Units 08 to 15	Unit 15		Unit 14		Unit 13		Unit 12		Unit 11		Unit 10		Unit 9		Unit 8	
	ch2	ch1	ch2	ch1	ch2	ch1	ch2	ch1	ch2	ch1	ch2	ch1	ch2	ch1	ch2	ch1

- ON: There is an alarm and the Temperature Controller is communicating normally.
- OFF: There is no alarm and the Temperature Controller is communicating normally, or the communications unit number belongs to a Temperature Controller that is not communicating normally.

**Input Error**

Bit	15	14	13	12	11	10	9	8	7	6	5	4	3	2	1	0
Units 00 to 07	Unit 7		Unit 6		Unit 5		Unit 4		Unit 3		Unit 1		Unit 1		Unit 0	
	ch2	ch1	ch2	ch1	ch2	ch1	ch2	ch1	ch2	ch1	ch2	ch1	ch2	ch1	ch2	ch1
Units 08 to 15	Unit 15		Unit 14		Unit 13		Unit 12		Unit 11		Unit 10		Unit 9		Unit 8	
	ch2	ch1	ch2	ch1	ch2	ch1	ch2	ch1	ch2	ch1	ch2	ch1	ch2	ch1	ch2	ch1

- ON: An input error has occurred and the Temperature Controller is communicating normally.



OFF: No input error has occurred and the Temperature Controller is communicating normally, or the communications unit number belongs to a Temperature Controller that is not communicating normally.

**RUN/STOP**

Bit	15	14	13	12	11	10	9	8	7	6	5	4	3	2	1	0
Units 00 to 07	Unit 7		Unit 6		Unit 5		Unit 4		Unit 3		Unit 1		Unit 1		Unit 0	
	ch2	ch1	ch2	ch1	ch2	ch1	ch2	ch1	ch2	ch1	ch2	ch1	ch2	ch1	ch2	ch1
Units 08 to 15	Unit 15		Unit 14		Unit 13		Unit 12		Unit 11		Unit 10		Unit 9		Unit 8	
	ch2	ch1	ch2	ch1	ch2	ch1	ch2	ch1	ch2	ch1	ch2	ch1	ch2	ch1	ch2	ch1

ON: The corresponding Temperature Controller is communicating normally and is running.

OFF: The corresponding Temperature Controller is communicating normally and is stopped, or the communications unit number belongs to a Temperature Controller that is not communicating normally.

**AT Execute/Cancel**

Bit	15	14	13	12	11	10	9	8	7	6	5	4	3	2	1	0
Units 00 to 07	Unit 7		Unit 6		Unit 5		Unit 4		Unit 3		Unit 1		Unit 1		Unit 0	
	ch2	ch1	ch2	ch1	ch2	ch1	ch2	ch1	ch2	ch1	ch2	ch1	ch2	ch1	ch2	ch1
Units 08 to 15	Unit 15		Unit 14		Unit 13		Unit 12		Unit 11		Unit 10		Unit 9		Unit 8	
	ch2	ch1	ch2	ch1	ch2	ch1	ch2	ch1	ch2	ch1	ch2	ch1	ch2	ch1	ch2	ch1

ON: Autotuning is being executed for the corresponding Temperature Controller and the corresponding Temperature Controller is communicating normally.

OFF: Autotuning is stopped for the corresponding Temperature Controller and the corresponding Temperature Controller is communicating normally, or the communications unit number belongs to a Temperature Controller that is not communicating normally.

**Auto/Manual**

Bit	15	14	13	12	11	10	9	8	7	6	5	4	3	2	1	0
Units 00 to 07	Unit 7		Unit 6		Unit 5		Unit 4		Unit 3		Unit 1		Unit 1		Unit 0	
	ch2	ch1	ch2	ch1	ch2	ch1	ch2	ch1	ch2	ch1	ch2	ch1	ch2	ch1	ch2	ch1
Units 08 to 15	Unit 15		Unit 14		Unit 13		Unit 12		Unit 11		Unit 10		Unit 9		Unit 8	
	ch2	ch1	ch2	ch1	ch2	ch1	ch2	ch1	ch2	ch1	ch2	ch1	ch2	ch1	ch2	ch1

ON: The corresponding Temperature Controller is communicating normally and is being operated manually.

OFF: The corresponding Temperature Controller is communicating normally and is being operated automatically, or the communications unit number belongs to a Temperature Controller that is not communicating normally.

**TC4**

**Alarms 1, 2, and 3**

Bit	15	14	13	12	11	10	9	8	7	6	5	4	3	2	1	0
Units 0 to 3	Unit 3				Unit 2				Unit 1				Unit 0			
	ch4	ch3	ch2	ch1	ch4	ch3	ch2	ch1	ch4	ch3	ch2	ch1	ch4	ch3	ch2	ch1

Units 4 to 7	Unit 7				Unit 6				Unit 5				Unit 4			
	ch4	ch3	ch2	ch1	ch4	ch3	ch2	ch1	ch4	ch3	ch2	ch1	ch4	ch3	ch2	ch1
Units 8 to 11	Unit 11				Unit 10				Unit 9				Unit 8			
	ch4	ch3	ch2	ch1	ch4	ch3	ch2	ch1	ch4	ch3	ch2	ch1	ch4	ch3	ch2	ch1
Units 12 to 15	Unit 15				Unit 14				Unit 13				Unit 12			
	ch4	ch3	ch2	ch1	ch4	ch3	ch2	ch1	ch4	ch3	ch2	ch1	ch4	ch3	ch2	ch1

ON: One of the specified alarms has occurred and the corresponding Temperature Controller is communicating normally.

OFF: The specified alarms have not occurred and the corresponding Temperature Controller is communicating normally, or the communications unit number belongs to a Temperature Controller that is not communicating normally.

**Input Error**

Bit	<b>15</b>	<b>14</b>	<b>13</b>	<b>12</b>	<b>11</b>	<b>10</b>	<b>9</b>	<b>8</b>	<b>7</b>	<b>6</b>	<b>5</b>	<b>4</b>	<b>3</b>	<b>2</b>	<b>1</b>	<b>0</b>
Units 0 to 3	Unit 3				Unit 2				Unit 1				Unit 0			
	ch4	ch3	ch2	ch1	ch4	ch3	ch2	ch1	ch4	ch3	ch2	ch1	ch4	ch3	ch2	ch1
Units 4 to 7	Unit 7				Unit 6				Unit 5				Unit 4			
	ch4	ch3	ch2	ch1	ch4	ch3	ch2	ch1	ch4	ch3	ch2	ch1	ch4	ch3	ch2	ch1
Units 8 to 11	Unit 11				Unit 10				Unit 9				Unit 8			
	ch4	ch3	ch2	ch1	ch4	ch3	ch2	ch1	ch4	ch3	ch2	ch1	ch4	ch3	ch2	ch1
Units 12 to 15	Unit 15				Unit 14				Unit 13				Unit 12			
	ch4	ch3	ch2	ch1	ch4	ch3	ch2	ch1	ch4	ch3	ch2	ch1	ch4	ch3	ch2	ch1

ON: There is an alarm and the Temperature Controller is communicating normally.

OFF: There is no alarm and the Temperature Controller is communicating normally, or the communications unit number belongs to a Temperature Controller that is not communicating normally.

**RUN/STOP**

Bit	<b>15</b>	<b>14</b>	<b>13</b>	<b>12</b>	<b>11</b>	<b>10</b>	<b>9</b>	<b>8</b>	<b>7</b>	<b>6</b>	<b>5</b>	<b>4</b>	<b>3</b>	<b>2</b>	<b>1</b>	<b>0</b>
Units 0 to 3	Unit 3				Unit 2				Unit 1				Unit 0			
	ch4	ch3	ch2	ch1	ch4	ch3	ch2	ch1	ch4	ch3	ch2	ch1	ch4	ch3	ch2	ch1
Units 4 to 7	Unit 7				Unit 6				Unit 5				Unit 4			
	ch4	ch3	ch2	ch1	ch4	ch3	ch2	ch1	ch4	ch3	ch2	ch1	ch4	ch3	ch2	ch1
Units 8 to 11	Unit 11				Unit 10				Unit 9				Unit 8			
	ch4	ch3	ch2	ch1	ch4	ch3	ch2	ch1	ch4	ch3	ch2	ch1	ch4	ch3	ch2	ch1
Units 12 to 15	Unit 15				Unit 14				Unit 13				Unit 12			
	ch4	ch3	ch2	ch1	ch4	ch3	ch2	ch1	ch4	ch3	ch2	ch1	ch4	ch3	ch2	ch1

ON: The corresponding Temperature Controller is communicating normally and is running.

OFF: The corresponding Temperature Controller is communicating normally and is stopped, or the communications unit number belongs to a Temperature Controller that is not communicating normally.

**AT Execute/Cancel**

Bit	15	14	13	12	11	10	9	8	7	6	5	4	3	2	1	0
Units 0 to 3	Unit 3				Unit 2				Unit 1				Unit 0			
	ch4	ch3	ch2	ch1	ch4	ch3	ch2	ch1	ch4	ch3	ch2	ch1	ch4	ch3	ch2	ch1
Units 4 to 7	Unit 7				Unit 6				Unit 5				Unit 4			
	ch4	ch3	ch2	ch1	ch4	ch3	ch2	ch1	ch4	ch3	ch2	ch1	ch4	ch3	ch2	ch1
Units 8 to 11	Unit 11				Unit 10				Unit 9				Unit 8			
	ch4	ch3	ch2	ch1	ch4	ch3	ch2	ch1	ch4	ch3	ch2	ch1	ch4	ch3	ch2	ch1
Units 12 to 15	Unit 15				Unit 14				Unit 13				Unit 12			
	ch4	ch3	ch2	ch1	ch4	ch3	ch2	ch1	ch4	ch3	ch2	ch1	ch4	ch3	ch2	ch1

ON: Autotuning is being executed for the corresponding Temperature Controller and the corresponding Temperature Controller is communicating normally.

OFF: Autotuning is stopped for the corresponding Temperature Controller and the corresponding Temperature Controller is communicating normally, or the communications unit number belongs to a Temperature Controller that is not communicating normally.

**Auto/Manual**

Bit	15	14	13	12	11	10	9	8	7	6	5	4	3	2	1	0
Units 0 to 3	Unit 3				Unit 2				Unit 1				Unit 0			
	ch4	ch3	ch2	ch1	ch4	ch3	ch2	ch1	ch4	ch3	ch2	ch1	ch4	ch3	ch2	ch1
Units 4 to 7	Unit 7				Unit 6				Unit 5				Unit 4			
	ch4	ch3	ch2	ch1	ch4	ch3	ch2	ch1	ch4	ch3	ch2	ch1	ch4	ch3	ch2	ch1
Units 8 to 11	Unit 11				Unit 10				Unit 9				Unit 8			
	ch4	ch3	ch2	ch1	ch4	ch3	ch2	ch1	ch4	ch3	ch2	ch1	ch4	ch3	ch2	ch1
Units 12 to 15	Unit 15				Unit 14				Unit 13				Unit 12			
	ch4	ch3	ch2	ch1	ch4	ch3	ch2	ch1	ch4	ch3	ch2	ch1	ch4	ch3	ch2	ch1

ON: The corresponding Temperature Controller is communicating normally and is being operated manually.

OFF: The corresponding Temperature Controller is communicating normally and is being operated automatically, or the communications unit number belongs to a Temperature Controller that is not communicating normally.

**Combining TC2 and TC4 Units**

Operation will be as follows if simple I/O allocation is used and both TC2 and TC4 Units are connected to a DeviceNet Communications Unit or if the Configurator is used to allocate I/O for both TC2 and TC4 Units.

**Simple I/O Allocation**

- If a TC4 Unit is used and simple I/O allocation is performed for TC2 Units (i.e., with DIP switch pin 2 turned OFF), channel 1 and channel 2 data will be used for channel 1 and channel 2 of the TC4 Unit.
- If a TC2 Unit is used and simple I/O allocation is performed for TC4 Units (i.e., with DIP switch pin 2 turned ON), channel 1 and channel 2 data will be used for channel 1 and channel 2 of the TC2 Unit.

**Allocating I/O from the Configurator**

If data is allocated for both TC2 and TC4 Units, the data will be allocated according to unit number in each allocated area, regardless of whether the

Units are TC2 or TC4 Units. This may result in the same data in two different places for the same unit numbers for the channels that are available.

Example: The data in the shaded areas of the following table will be used if a TC2 Unit set as unit 0 and a TC4 Unit set as unit 1 are connected to a DeviceNet Communications Unit.

TC2 data	Unit 7		Unit 6		Unit 5		Unit 4		Unit 3		Unit 2		Unit 1		Unit 0	
	ch2	ch1	ch2	ch1	ch2	ch1	ch2	ch1	ch2	ch1	ch2	ch1	ch2	ch1	ch2	ch1
TC4 data	Unit 3				Unit 2				Unit 1				Unit 0			
	ch4	ch3	ch2	ch1	ch4	ch3	ch2	ch1	ch4	ch3	ch2	ch1	ch4	ch3	ch2	ch1

### 4-3-5 Output Data Details

The output data is divided into the OUT Enable Bit, operation commands, setting data, and expansion remote I/O. This section describes the OUT Enable Bit and operation commands specific to DeviceNet communications that are not allocated in the variable areas of the Temperature Controller.

- Note**
1. The output data will not be valid for Temperature Controllers with which a communications error has occurred, or which have a communications unit number that is not registered in the connection configuration.
  2. Depending on the Temperature Controller status (e.g., RUN/STOP), some data may not be valid even if it is written to the OUT Area. For details, refer to the *EJ1 Modular Temperature Controller User's Manual* (Cat. No. H142).
  3. Operation commands are executed only after sending the setting data. The setting data and operation commands are sent or executed in the order that they are allocated in the OUT Area.

### TC2 and TC4

#### OUT Enable Bit

15	14	13	12	11	10	9	8	7	6	5	4	3	2	1	0	Bit
0	0	0	0	0	0	0	0	0	0	0	0	0	0	0	(1)	

Number	Description
(1)	OFF to ON: All parameters in the OUT Area are transferred to the Temperature Controller. (They are transferred only once each time the bit is turned ON). ON: Only parameters that are changed in the OUT Area are transferred to the Temperature Controller. OFF: Parameters in the OUT Area are not transferred to the Temperature Controller.

**Note** The Output Completed Flags will show the results of processing for the OUT Enable Bit.

The OUT Enable Bit must be turned ON to enable the output data set in the output area. If the OUT Enable Bit is OFF, no data will be transferred to the Temperature Controller even if the output data is written to the OUT Area.

- Note**
1. The first word of the OUT Area is allocated to the OUT Enable Bit. If the Configurator is used to allocate I/O and the second or higher words in the OUT Area are allocated to parameters, the first word will automatically be allocated for the OUT Enable Bit.
  2. Always turn OFF the OUT Enable Bit when downloading setting parameters to the Temperature Controllers using the Configurator. If the OUT Enable Bit is not turned OFF before downloading data, the set values allocated as I/O and the set values downloaded using the Configurator will

compete with each other, causing the set values allocated as I/O to be enabled. For details on downloading set values to the Temperature Controllers using the Configurator, refer to *SECTION 5 Operations from the Configurator*.

- Even when the OUT Enable Bit is turned OFF, data can be written using explicit messages.

**Read Parameter**

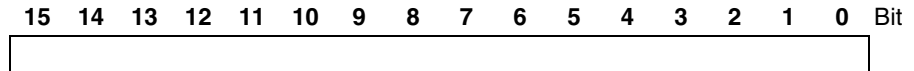

- This parameter is used for expansion remote I/O.
- Allocate the Read Parameter in the OUT Area, and then specify the allocation number of the parameter to be read, e.g., using the ladder program. For the allocation numbers, refer to *4-3-3 Parameters for Which Allocation Is Possible*.

**Write Parameter**

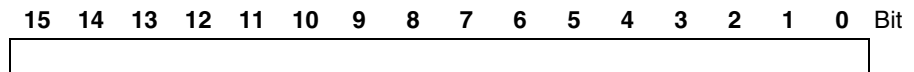

- This parameter is used for expansion remote I/O.
- Allocating the Write Parameter in the OUT Area, and then specify the allocation number of the parameter to be written, e.g., using the ladder program. For the allocation numbers, refer to *4-3-3 Parameters for Which Allocation Is Possible*.

**Software Reset**

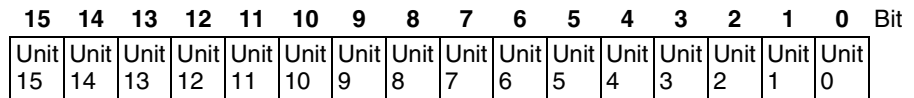

OFF to ON: Software reset command. (Executed only once when the bit is turned ON.)

ON to OFF: No processing is performed.

**TC2**

**RUN/STOP**

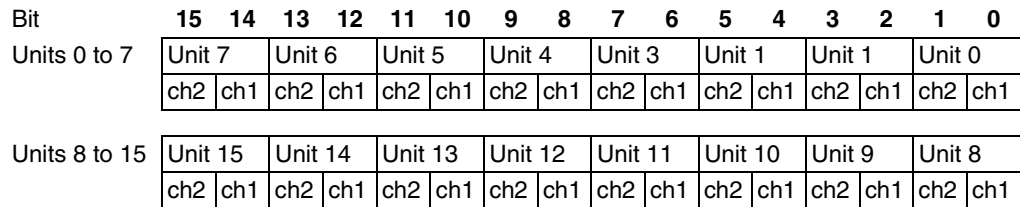

ON: Run command (starts control). (Executed while the bit is ON.)

OFF: Stop command (stops control). (Executed while the bit is OFF.)

**AT Execute/Cancel**

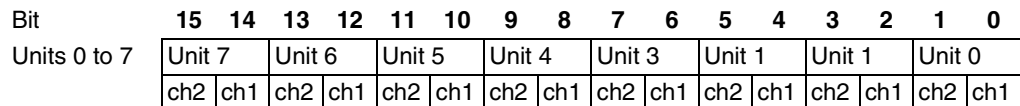

Units 8 to 15	Unit 15		Unit 14		Unit 13		Unit 12		Unit 11		Unit 10		Unit 9		Unit 8	
	ch2	ch1	ch2	ch1	ch2	ch1	ch2	ch1	ch2	ch1	ch2	ch1	ch2	ch1	ch2	ch1

OFF to ON: 100% autotuning execution command. (Executed only once each time the bit is turned ON.)

OFF: Autotuning cancel command (Executed while the bit is OFF.)

**Note** Always allocate AT Execute/Cancel after RUN/STOP or Auto/Manual. If it is allocated before, AT execution and RUN or Auto will not be performed at the same time.

**Auto/Manual**

Units 0 to 7	Unit 7		Unit 6		Unit 5		Unit 4		Unit 3		Unit 1		Unit 1		Unit 0	
	ch2	ch1	ch2	ch1	ch2	ch1	ch2	ch1	ch2	ch1	ch2	ch1	ch2	ch1	ch2	ch1

Units 8 to 15	Unit 15		Unit 14		Unit 13		Unit 12		Unit 11		Unit 10		Unit 9		Unit 8	
	ch2	ch1	ch2	ch1	ch2	ch1	ch2	ch1	ch2	ch1	ch2	ch1	ch2	ch1	ch2	ch1

ON: Manual mode command. (Executed while the bit is ON.)

OFF: Auto mode command. (Executed while the bit is OFF.)

**TC4**

**RUN/STOP**

Units 0 to 3	Unit 3				Unit 2				Unit 1				Unit 0			
	ch4	ch3	ch2	ch1	ch4	ch3	ch2	ch1	ch4	ch3	ch2	ch1	ch4	ch3	ch2	ch1

Units 4 to 7	Unit 7				Unit 6				Unit 5				Unit 4			
	ch4	ch3	ch2	ch1	ch4	ch3	ch2	ch1	ch4	ch3	ch2	ch1	ch4	ch3	ch2	ch1

Units 8 to 11	Unit 11				Unit 10				Unit 9				Unit 8			
	ch4	ch3	ch2	ch1	ch4	ch3	ch2	ch1	ch4	ch3	ch2	ch1	ch4	ch3	ch2	ch1

Units 12 to 15	Unit 15				Unit 14				Unit 13				Unit 12			
	ch4	ch3	ch2	ch1	ch4	ch3	ch2	ch1	ch4	ch3	ch2	ch1	ch4	ch3	ch2	ch1

ON: RUN command (starts control). (Executed while the bit is ON.)

OFF: Stop command (stops control). (Executed while the bit is OFF.)

**AT Execute/Cancel**

Units 0 to 3	Unit 3				Unit 2				Unit 1				Unit 0			
	ch4	ch3	ch2	ch1	ch4	ch3	ch2	ch1	ch4	ch3	ch2	ch1	ch4	ch3	ch2	ch1

Units 4 to 7	Unit 7				Unit 6				Unit 5				Unit 4			
	ch4	ch3	ch2	ch1	ch4	ch3	ch2	ch1	ch4	ch3	ch2	ch1	ch4	ch3	ch2	ch1

Units 8 to 11	Unit 11				Unit 10				Unit 9				Unit 8			
	ch4	ch3	ch2	ch1	ch4	ch3	ch2	ch1	ch4	ch3	ch2	ch1	ch4	ch3	ch2	ch1

Units 12 to 15	Unit 15				Unit 14				Unit 13				Unit 12			
	ch4	ch3	ch2	ch1	ch4	ch3	ch2	ch1	ch4	ch3	ch2	ch1	ch4	ch3	ch2	ch1

OFF to ON: 100% autotuning execution command. (Executed only once each time the bit is turned ON.)

OFF: Autotuning cancel command. (Executed while the bit is OFF.)

**Note** Always allocate AT Execute/Cancel after RUN/STOP or Auto/Manual. If it is allocated before, AT execution and RUN or Auto will not be performed at the same time.

**Auto/Manual**

Bit	15	14	13	12	11	10	9	8	7	6	5	4	3	2	1	0
Units 0 to 3	Unit 3				Unit 2				Unit 1				Unit 0			
	ch4	ch3	ch2	ch1	ch4	ch3	ch2	ch1	ch4	ch3	ch2	ch1	ch4	ch3	ch2	ch1
Units 4 to 7	Unit 7				Unit 6				Unit 5				Unit 4			
	ch4	ch3	ch2	ch1	ch4	ch3	ch2	ch1	ch4	ch3	ch2	ch1	ch4	ch3	ch2	ch1
Units 8 to 11	Unit 11				Unit 10				Unit 9				Unit 8			
	ch4	ch3	ch2	ch1	ch4	ch3	ch2	ch1	ch4	ch3	ch2	ch1	ch4	ch3	ch2	ch1
Units 12 to 15	Unit 15				Unit 14				Unit 13				Unit 12			
	ch4	ch3	ch2	ch1	ch4	ch3	ch2	ch1	ch4	ch3	ch2	ch1	ch4	ch3	ch2	ch1

ON: Manual mode command. (Executed while the bit is ON.)

OFF: Auto mode command. (Executed while the bit is OFF.)

**Combining TC2 and TC4 Units**

Operation will be as follows if simple I/O allocation is used and both TC2 and TC4 Units are connected to a DeviceNet Communications Unit or if the Configurator is used to allocate I/O for both TC2 and TC4 Units.

**Simple I/O Allocation**

- If a TC4 Unit is used and simple I/O allocation is performed for TC2 Units (i.e., with DIP switch pin 2 turned OFF), channel 1 and channel 2 data will be used for channel 1 and channel 2 of the TC4 Unit.
- If a TC2 Unit is used and simple I/O allocation is performed for TC4 Units (i.e., with DIP switch pin 2 turned ON), channel 1 and channel 2 data will be used for channel 1 and channel 2 of the TC2 Unit.

**Allocating I/O from the Configurator**

If data is allocated for both TC2 and TC4 Units, the data will be allocated according to unit number in each allocated area, regardless of whether the Units are TC2 or TC4 Units. This may result in the same data in two different places for the same unit numbers for the channels that are available.

Example: The data in the shaded areas of the following table will be used if a TC2 Unit set as unit 0 and a TC4 Unit set as unit 1 are connected to a DeviceNet Communications Unit.

TC2 data	Unit 7	Unit 6	Unit 5	Unit 4	Unit 3	Unit 2	Unit 1	Unit 0								
	ch2	ch1	ch2	ch1	ch2	ch1	ch2	ch1								
TC4 data	Unit 3				Unit 2				Unit 1				Unit 0			
	ch4	ch3	ch2	ch1	ch4	ch3	ch2	ch1	ch4	ch3	ch2	ch1	ch4	ch3	ch2	ch1

**4-4 Expansion Remote I/O**

**4-4-1 What Is Expansion Remote I/O?**

Expansion remote I/O is a function reading and writing parameters. Specific parameters allocated in I/O memory of the master can be switched to a variety of parameters by using memory operations. This function enables manipu-

lating more than 100 parameters. Even if the number of parameters to be read and written increases, modifications can be handled simply by changing operations in the memory of the master.

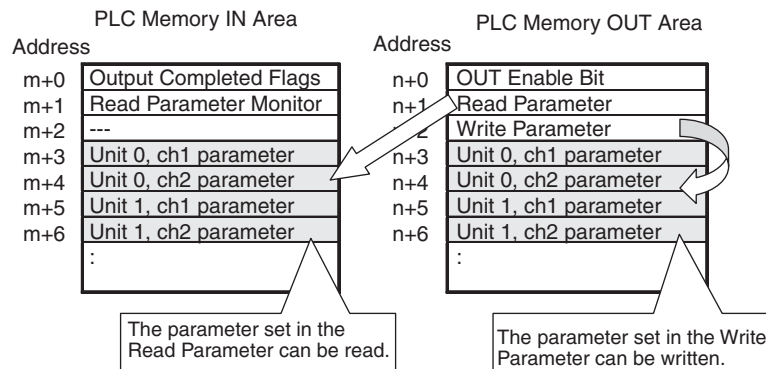

- Note a) The parameters that can be specified are the ones that can be changed during operation.
- b) Expansion remote I/O cannot be used with simple I/O allocations.

### 4-4-2 Procedure for Reading Parameters

This section describes how to read parameters using expansion remote I/O.

#### Allocating Expansion Remote I/O Parameters

Allocate the following parameters in I/O memory by using the Configurator. For information on allocation methods, refer to 4-3-2 *Creating Allocation Data*.

Area	Parameter	Description
OUT Area	Read Parameter	Used to the allocation number of the parameter to be read. Always allocate memory to this parameter.
IN Area	Read Parameter Monitor	Used to confirm that reading has been completed. Always allocate memory to this parameter.
	Parameters for specified unit numbers and channels	The values of the parameters corresponding to the specified allocation number will be set. Allocate memory for the required unit numbers and channels.

Note There are no restrictions on the locations for allocations.

#### Reading Parameters by Using Memory Operations

Use the following procedure to read parameters by using ladder programming.

- 1,2,3...
1. Set the Read Parameter to the allocation number of the parameter to be read. For the allocation numbers, refer to the *Allocation number for expansion remote I/O* column in the table in 4-3-3 *Parameters for Which Allocation Is Possible*.  
Example: Allocation number for the set point = 18 (0012 hex)
  2. Check that the allocation number specified in step 1 is set in the Read Parameter Monitor. If the same allocation number is set as in step 1, then the specified parameter has been read normally. FFFF hex will be set in the following cases.
    - The Read Parameter is 0 at startup.
    - There is no parameter that corresponds to the allocation number.



- Communications cannot be performed with the unit number registered in the configuration.

Note No processing will be performed and reading will be completed normally if a parameter is allocated for a unit number that is not registered in the configuration.

3. Check the parameters that were read. The parameter specified in step 1 will be read for each unit number and channel that has been allocated. If the Read Parameter Monitor is set to FFFF hex, the parameters for individual unit numbers and channels will maintain the previous values.

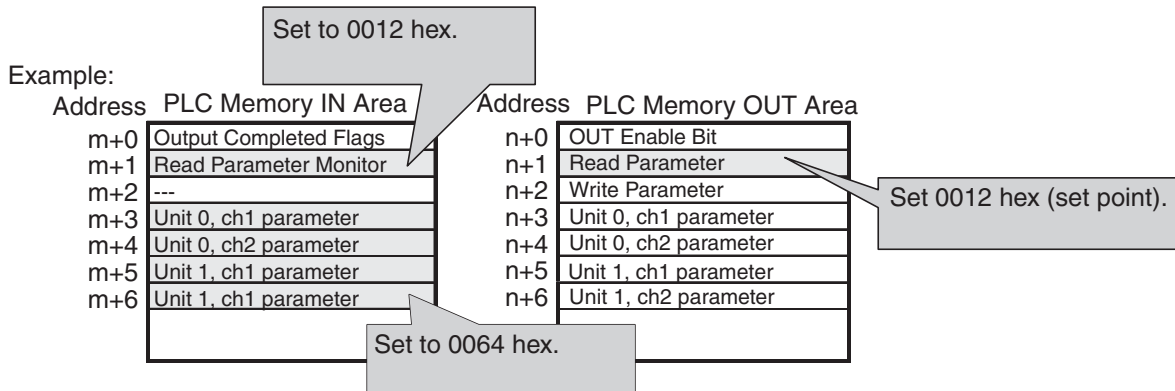

**Programming Example for Reading Parameters**

The program uses CIO 3200 to CIO 3263 as the OUT Area and CIO 3300 to CIO 3363 as the IN Area for an OMRON CS/CJ-series DeviceNet Unit.

**Operation**

- The set point of a TC2 Unit (unit number 0, ch1) is read.
- The allocation number of the set point (18 (0012 hex)) is set in the Read Parameter allocated in CIO 3201.
- If reading is completed normally, allocation number of the set point (18 (0012 hex)) is set in the Read Parameter Monitor allocated in CIO 3301.
- The set point is stored in the Unit 0 Ch1 Parameter allocated in CIO 3302 and then the value is transferred to D0100.

**Example of Ladder Programming**

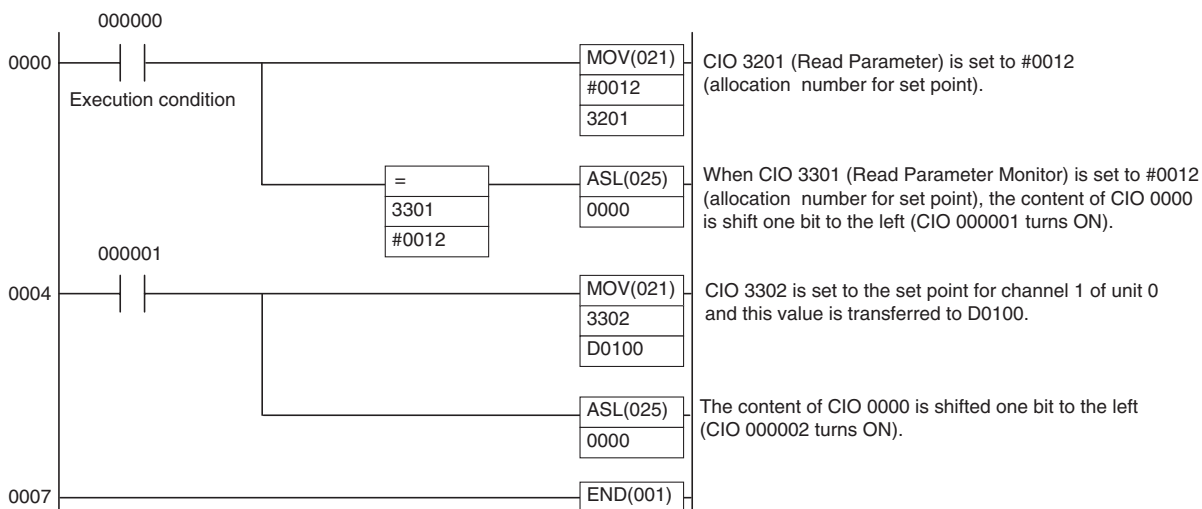

### 4-4-3 Procedure for Writing Parameters

This section describes how to write parameters using expansion remote I/O.

#### Allocating Expansion Remote I/O Parameters

Allocate memory to the following parameters to I/O by using the Configurator. For information on allocation methods, refer to 4-3-2 Creating Allocation Data.

Area	Parameter	Description
OUT Area	OUT Enable Bit	Used to enable writing. Always allocate the first word of the OUT Area to this parameter.
	Write Parameter	Used to set the allocation number of the parameter to be written. Always allocate memory to this parameter.
	Parameters for specified unit numbers and channels	Set the values to write to the parameters corresponding to the specified allocation number. Allocate memory for the required unit numbers and channels.
IN Area	Output Completed Flags	Used to check that writing has been completed. Always allocate memory to this parameter.

**Note** There are no restrictions on the locations for allocations except for the OUT Enable Bit.

#### Writing Parameters by Using Memory Operations

Use the following procedure to write parameters by using ladder programming.

**1,2,3...**

- Turn OFF the OUT Enable Bit.  
First, always turn OFF the OUT Enable Bit. After the OUT Enable Bit is turned OFF, the word that contains the Output Completed Flags will be 0000 hex.
- Check that the word that contains the Output Completed Flags is 0000 hex.
- Set the Write Parameter to the allocation number of the parameter to be written. For the allocation numbers, refer to the *Allocation number for expansion remote I/O* column in the table in 4-3-3 *Parameters for Which Allocation Is Possible*.  
Example: Allocation number for the set point = 27 (001B hex)
- Set the values to write in the parameters for the unit numbers and channels for the allocation number specified in step 3.
- Turn ON the OUT Enable Bit. Writing will be performed when this bit turns ON.
- Check that the word containing the OUT Completed Flags is 0001 hex. If the word is 0001 hex, then writing has been completed normally, and if it is 8001 hex, an error has occurred in writing. If an error occurs, check the following points.
  - There are no parameters that corresponds to the allocation number.
  - The write value in step 4 is outside the setting range.
  - Communications cannot be performed with a unit number registered in the configuration.

**Note** If memory is allocated to the parameter for a unit number that is not registered in the configuration, no processing will be performed, and writing will completed normally.

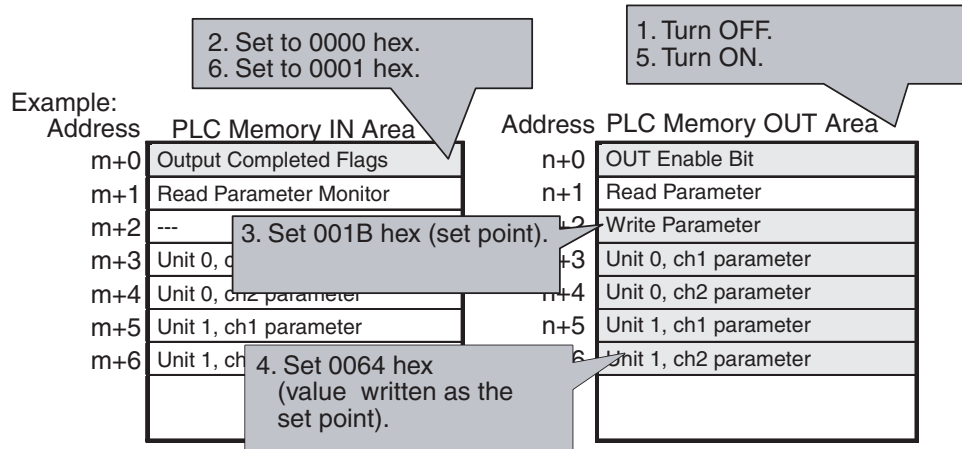

**Note** Always turn OFF the OUT Enable Bit before attempting to write parameters using expansion remote I/O. If writing is attempted while the bit is ON, writing may be performed while the allocation number or write values are being set, and unintended values may be written.

**Programming**  
**Example for Writing**  
**Parameters**

The program uses CIO 3200 to CIO 3263 as the OUT Area and CIO 3300 to CIO 3363 as the IN Area for an OMRON CS/CJ-series DeviceNet Unit.

**Operation**

- The set point of a TC2 Unit (unit number 0, ch1) is written.
- The OUT Enable Bit (bit 320000) to which CIO 3200 is allocated is turned OFF.
- When bit 00 of the Output Completed Flags, to which CIO 3300 is allocated, is reset, the Write Parameter, to which CIO 3202 is allocated, is set to allocation number 27 (001B hex) to specify the set point, and the unit number and channel parameter, to which CIO 3203 is allocated, is set to 100°C (0064 hex).
- The OUT Enable Bit is turned ON (CIO 320000).
- Writing is performed. When writing has been completed normally, the word that contains the OUT Enable Bit will be 0001 hex (bit 00 ON, bit 15 OFF).

**Example of Ladder Programming**

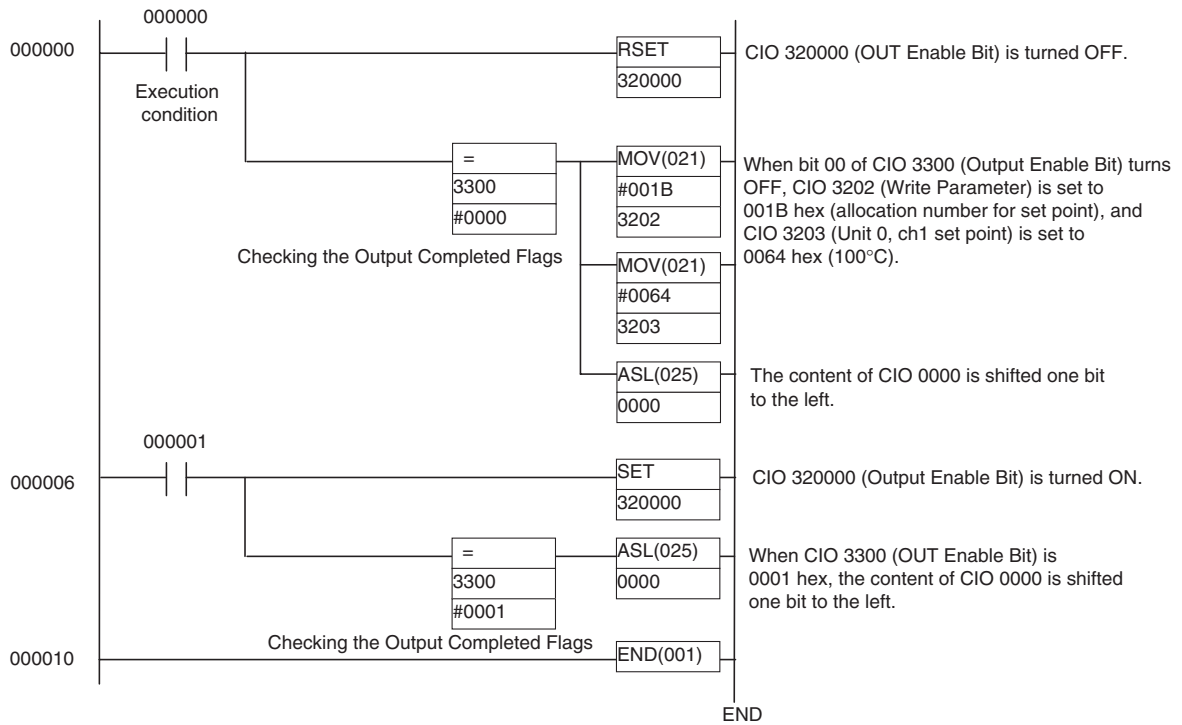

**4-5 Allocating Data in the Master**

The created allocation data can be allocated in the master using fixed or user-set allocations.

**4-5-1 Fixed Allocations**

When fixed allocations are used, the location for allocated data is automatically determined according to the node address of the DeviceNet Communications Unit.

- Note**
1. When I/O is allocated from the Configurator, up to 100 words can be allocated in the IN Area and OUT Area, but only up to 64 words can be used for the IN Area and OUT Area if fixed allocations are used (the maximum number of words may be even less depending on the DeviceNet Unit and PLC being used). Consider the number of words that can be used before allocating data.
  2. When fixed allocations are used, each node address is allocated one word. The node addresses allocated in the words that are allocated to the DeviceNet Communications Unit cannot be used by other nodes.

**4-5-2 User-set Allocations**

With user-set allocations, the Configurator can be used to allocate DeviceNet Communications Unit data anywhere within the specified DeviceNet area.

- Note**
1. When performing user-set allocations from a DeviceNet Configurator, use Ver. 2.44 or higher.
  2. When the IN Area is divided into two blocks, the total number of words that can be used for allocating data in the IN Area is still 100 words.

- When using a CS/CJ-series DeviceNet Unit as the master, the location and size of the DeviceNet Area can be specified through the allocated DM Area words, without using the Configurator. For slaves, however, I/O is allocated in the DeviceNet Area in node-address order. For details, refer to the *CS/CJ-series DeviceNet Unit Operation Manual* (Cat. No. W380).

### Allocating Data in the Master

#### Setting from the DeviceNet Configurator

- 1,2,3... 1. Double-click the icon of the Master Unit in the Network Configuration Window, or select **Device, Parameters**, and **Edit** to display the Edit Device Parameters Window for the master.
2. Click the **Register Device** Button in the master's **General** Tab Page, and register the DeviceNet Communications Unit. Alternatively, in the Network Configuration Window, drag and drop the DeviceNet Communications Unit icon in the Master Unit icon to register it. Once registered, the DeviceNet Communications Unit will be added to the *Register Device List* field. By registering the DeviceNet Communications Unit, the allocation data created in the slave's Edit Device Parameters Window will be registered in the master.

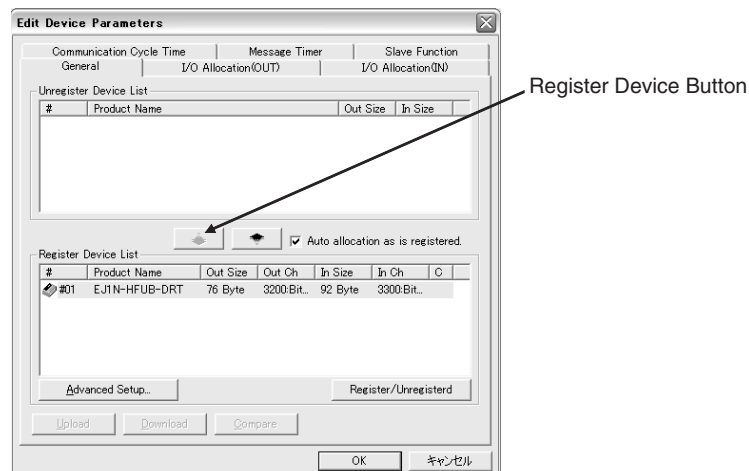

3. Select the **I/O Allocation (OUT)** and **I/O Allocation (IN)** Tab, and check that the allocation data created in the Edit Device Parameters Window for the DeviceNet Communications Unit parameters is registered in the master's allocated area (memory block 1 or 2).

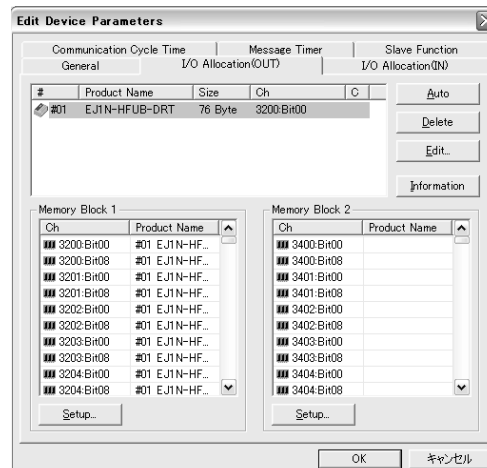

- Click the **Edit** Button, and edit any of the I/O allocations. Set where to allocate the master's IN and OUT Areas in the *Allocated* field. When the master's IN and OUT Areas consist of two blocks, specify in which block to allocate the data.

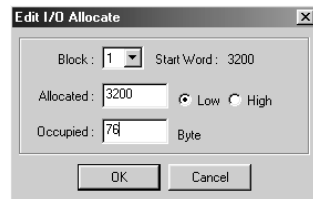

- Click the **OK** Button, and return to the master's Edit Device Parameters Window. The DeviceNet Communications Unit data can be registered anywhere in the memory block fields in the lower half of the window.
- Return to the **General** Tab for the master, click the **Download** Button, and write the set I/O memory allocations to the master.

**Note** Always click the **OK** Button to exit the master's Edit Device Parameters Window. If the **Cancel** Button or **X** Button are pressed, the setting contents will be invalid.

### Setting Connections when Dividing IN Area in Two

When a CS/CJ-series DeviceNet Unit is used as the master, the IN Area can be divided into two areas by setting connections. This function is enabled by setting two connection types at the same time for a single DeviceNet Communications Unit using the user-defined settings.

When a DeviceNet Communications Unit is used, one connection type can be used to exchange data from IN Area 1 and OUT Area 1, and another connection can be used to exchange data from IN Area 2.

The default connections and connection paths are shown in the following table.

Allocated Area	Connection type used	Connection path used
IN Area 1	Poll	IN Area 1
OUT Area 1	Poll	OUT Area 1
IN Area 2	None	None

By setting the following connections as user-defined settings, the IN Area can be divided into two areas.

Allocated Area	Connection type used	Connection path used
IN Area 1	Poll	IN Area 1
OUT Area 1	Poll	OUT Area 1
IN Area 2	COS or Cyclic	IN Area 2

### Setting from the DeviceNet Configurator

- 1,2,3... 1. Right-click the icon for the DeviceNet Communications Unit and select **Properties**. The EJ1N-HFUB-DRT Property Window will be displayed.

- Click the **I/O Information** Tab and click the **Edit** Button. The Change I/O Size Window will be displayed.

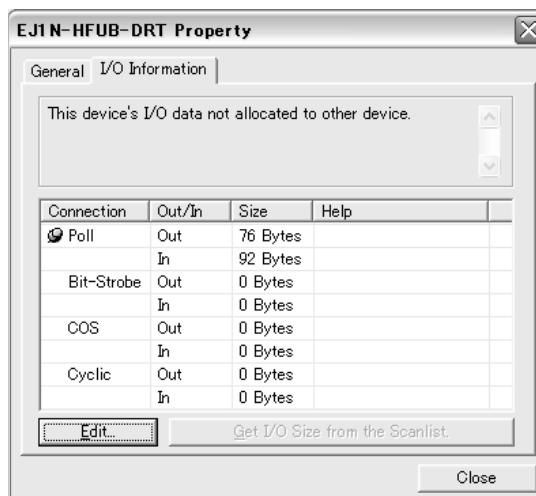

- Change the output size and input size for the COS or Cyclic connection to be used. Set the output size to the same value as the output size of the Poll connection and set the input size to the size used for allocation area 2 of on the I/O Allocation (IN) Tab Page for the DeviceNet Communications Unit.

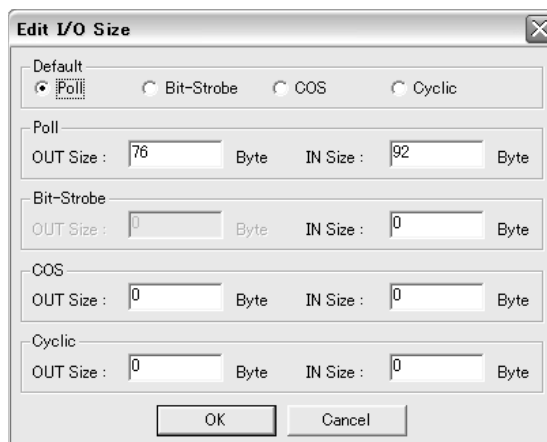

- Select the Unit from the General Tab Page for the master in the Edit Device Parameters Window of the master, and then click the **Advanced Setup** Button. The Connection Tab Page will be displayed.

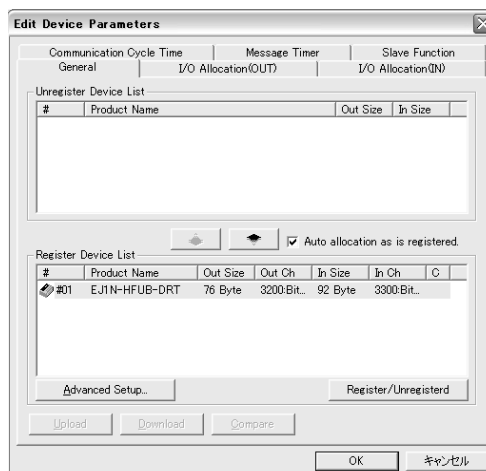

5. Select **User Setup**, and select **Use Poll Connection** for one connection, the same as the default setting. Then select the connection path from the pull-down menu as **OUT area 1** for the OUT side, and **IN area 1** for the IN side.

For the second connection, select either **Use COS Connection** or **Use Cyclic Connection**, then select **IN area 2** as from the pull-down menu on the IN side as the connection path. For the connection path on the OUT side, always set the same connection path as specified for the Poll connection.

Example: When **Use COS Connection** is selected.

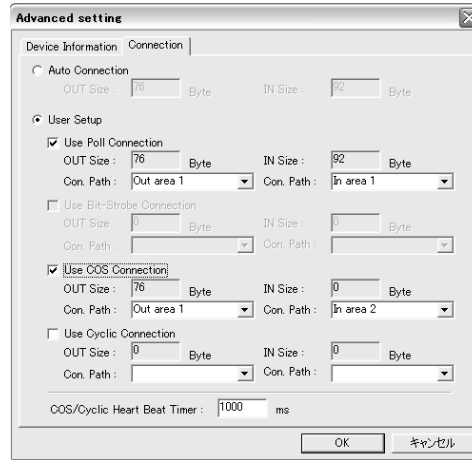

**Note** The output for the Poll connection and the output for the COS or Cyclic connection are sent in the same frame. Therefore, the same output size must be set for both connections when using a Poll and COS combination, or a Poll and Cyclic combination. When a COS or Cyclic connection are used, always set a dummy output size, and set the same connection path that is used for the Poll connection.

6. Click the **OK** Button, and return to the master's Edit Device Parameters Window. The following dialog box will be displayed when master I/O allocation is performed before the connection is set.

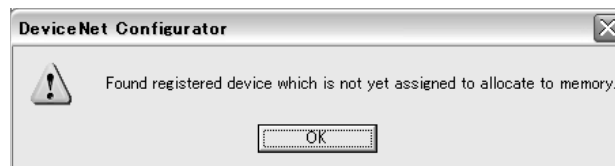

Edit the I/O allocation on the master's I/O Allocation (IN) Tab Page. Allocation words can be set for each connection in the Edit I/O Allocation Window.



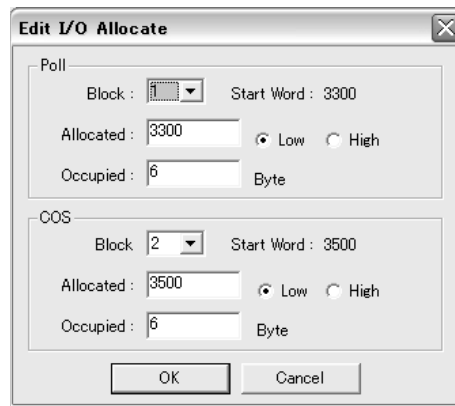

7. Click the **OK** Button, and return to the master's Edit Device Parameters Window.
8. Select the **General** Tab, and click the **Download** Button to write the set I/O memory allocations to the master.

**Note** Always click the **OK** Button to exit the master's Edit Device Parameters Window. If the **Cancel** Button or the  Button is clicked, the settings will be invalid.

## 4-6 Ladder Programming Examples

### 4-6-1 RUN/STOP Programming Examples

The ladder programming example here is for the following execution conditions.

- Using simple I/O allocation to allocate data in the fixed allocation area 1 of a CS/CJ-series DeviceNet Unit (OUT Area = CIO 3200 to CIO 3263, IN Area = CIO 3300 to CIO 3363).

#### Operation

- Executes RUN or STOP for the TC2 (Unit 0, ch1).
- The bit in the first word + 2 words of the OUT Area is allocated by default to the RUN/STOP Bit (CIO 320200).
- RUN is executed when the RUN/STOP Bit (CIO 320200) turns ON for the execution condition 000000, after which the OUT Enable Bit turns ON. When the RUN/STOP Confirmation Flag (CIO 330200) turns ON, the OUT Enable Bit turns OFF.
- STOP is executed when the RUN/STOP Bit (CIO 320200) turns OFF for the execution condition 000100, after which the OUT Enable Bit turns ON. Then, when the RUN/STOP Confirmation Flag (CIO 330200) turns OFF, the OUT Enable Bit turns OFF.

**Programming Example**

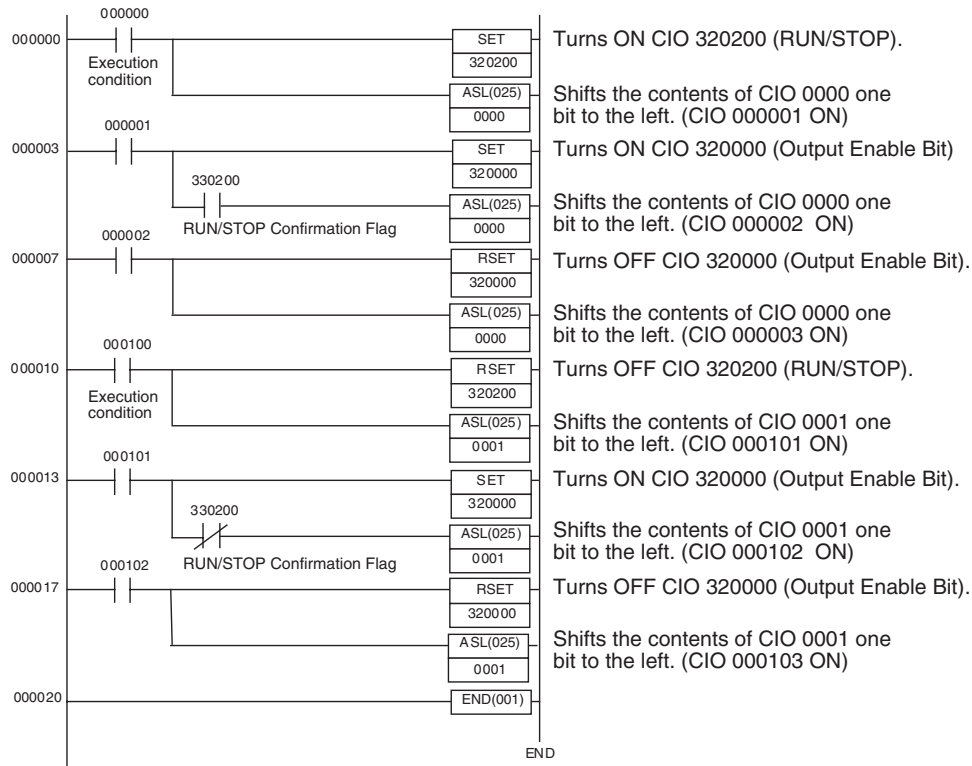

**4-6-2 Change SP Programming Example**

The ladder programming example here is for the following execution conditions.

- Using simple I/O allocation to allocate data in the fixed allocation area 1 of a CS/CJ-series DeviceNet Unit of CS/CJ-series DeviceNet Unit (OUT Area = CIO 3200 to CIO 3263, IN Area = CIO 3300 to CIO 3363).

**Operation**

- Writes the SP to the TC2 (SP = 150 hex, destination = Unit 0, ch1).
- Writes the SP to the first word + 6 words of the default allocated OUT Area (CIO 3206).
- The SP is first set in D1000, and then transferred to CIO 3206 at the start of the ladder program when the execution condition (CIO 000000) turns ON. The OUT Enable Bit will then turn ON, and the SP will be refreshed.

**Programming Example**

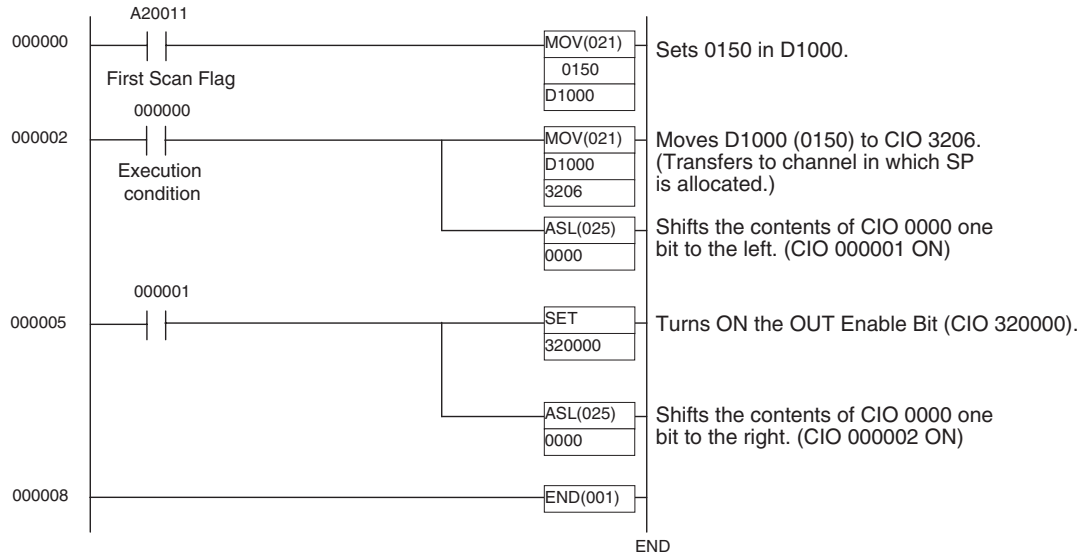

**4-6-3 Change MV Upper Limit/Lower Limit Programming Example**

The ladder programming example here is for the following execution conditions.

- Using the Configurator to allocate I/O in the fixed allocation area 1 of a CS/CJ-series DeviceNet Unit (OUT Area = CIO 3200 to CIO 3263, IN Area = CIO 3300 to CIO 3363).

**Operation**

- This programming example writes the MV upper limit/lower limit to the TC2 (Unit 0, ch1) (upper limit: 50 hex, lower limit 20 hex).
- MV upper limit/lower limit cannot be used with simple I/O allocations, so the Configurator is used to allocate memory. In this programming example, the MV upper limit is allocated in CIO 3218, the MV lower limit in CIO 3219, and the Output Completed Flags in CIO 3300.
- The MV upper limit is set in D1000 and the MV lower limit is set in D1001 at the start of the ladder program, and then they are transferred to CIO 3218 and CIO 3219 when the execution condition, CIO 000000, turns ON. Next, the upper and lower limits are refreshed when the OUT Enable Bit turns ON. If the data is transferred normally, the Output Completed Flags turn ON, and then OUT Enable Bit turns OFF.

Programming Example

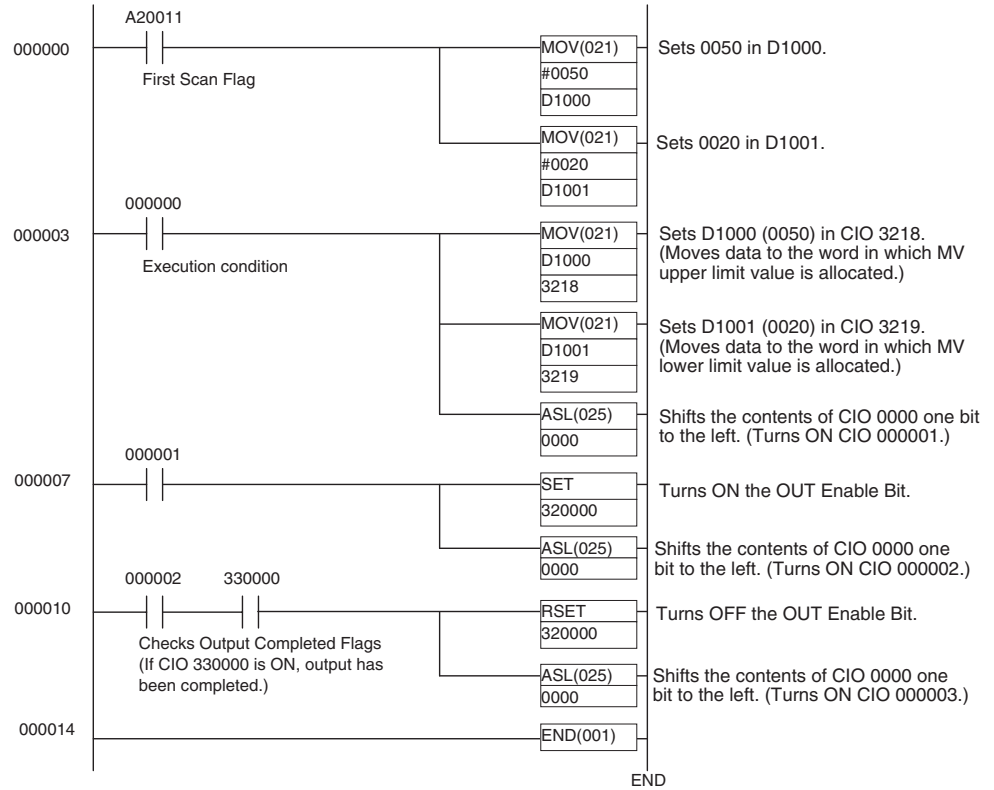



# SECTION 5

## Operations from the Configurator

This section describes the DeviceNet Configurator operations that can be used for the EJ1 DeviceNet Communications Unit except for allocation procedures, which are described in *SECTION 4 Remote I/O Communications*.

5-1	List of Operations from the Configurator . . . . .	84
5-2	Operations from the Edit Device Parameters Window . . . . .	85
5-2-1	Preparing the Configurator Connection . . . . .	85
5-2-2	Edit Device Parameters Window . . . . .	85
5-2-3	Setting DeviceNet Communications Unit Comment . . . . .	86
5-2-4	Setting Network Power Voltage Monitor . . . . .	87
5-2-5	Setting the Unit Conduction Time Monitor . . . . .	88
5-2-6	Setting Last Maintenance Date . . . . .	89
5-2-7	Copying Temperature Controller Parameters . . . . .	90
5-2-8	Sending Operation Commands to the Temperature Controllers . . . . .	91
5-2-9	Editing Temperature Controller Parameters . . . . .	93
5-2-10	Setting Temperature Controller Comment . . . . .	95
5-2-11	Setting Temperature Controller Monitor Mode and Monitor Values . . . . .	95
5-3	Maintenance Mode Window . . . . .	97
5-3-1	Maintenance Mode Window . . . . .	97
5-3-2	Maintenance Information Window . . . . .	99
5-4	DeviceNet Communications Unit Monitor . . . . .	102

## 5-1 List of Operations from the Configurator

This section describes the settings and operations performed by the Configurator apart from those operations explained in *SECTION 4 Remote I/O Communications*. Various setting and operation procedures are possible from the Configurator, and only examples are provided here.

**Note** Always use Ver. 2.44 or higher of the Configurator or CX-Integrator Ver. 2.2 or higher for setting and monitoring the DeviceNet Communications Unit.

Item	Reference page
Master's Edit Device Parameters Window	---
Registering DeviceNet Communications Unit in the master	74
Setting DeviceNet Communications Unit connections	75
Allocating data in the master	74
DeviceNet Communications Unit's Edit Device Parameters Window	---
General Tab	---
Setting details of DeviceNet Communications Unit	86
Setting Network power voltage monitor value	87
Setting DeviceNet Communications Unit conduction time monitor value	88
Setting last maintenance date	89
Operation commands	91
Setting details of Temperature Controllers	95
Setting Temperature Controller monitor mode (Total ON or RUN time)	95
Setting Temperature Controller monitor value (Total ON or RUN time monitor value)	95
Editing Temperature Controller parameters	93
I/O Allocations (OUT) Tab	---
Allocating allocation data in the OUT Area	48
I/O Allocations (IN) Tab	---
Allocating allocation data in the IN Area	50
Monitor Device Window	
Maintenance Information Window (accessed from the Maintenance Mode Window)	97
General Tab	---
Displaying DeviceNet Communications Unit comment	99
Displaying last maintenance date	99
Displaying DeviceNet Communications Unit Conduction Time	99
Displaying Network power voltage PV	99
Displaying Network power voltage peak value	99
Displaying Network power voltage bottom value	99
Displaying Unit status (Temperature Controller power voltage status, communications power voltage monitor status, DeviceNet Communications Unit Conduction time monitor status, Temperature Controller total ON/RUN time monitor status)	99
Unit Tab	---
Displaying the Temperature Controller comment	100
Displaying the Temperature Controller total ON/RUN time	100
Temperature Controller total ON/RUN time monitor value status	100
Error History Tab	---
Displaying the communications error history	100

## 5-2 Operations from the Edit Device Parameters Window

### 5-2-1 Preparing the Configurator Connection

If problems occur in the connection with the Configurator, change the settings for the master. Problems will occur if the master's message timeout time is too short or the I/O size allocated in the master is different from that allocated in the DeviceNet Communications Unit.

#### Configurator Connected Using a DeviceNet Interface Board (Card)

- 1,2,3... 1. Right-click the icon for the master, then select **Monitor** to display the Monitor Device Window.
2. Click the **Stop Remote I/O Communication** Button to stop remote I/O communications with the DeviceNet Communications Unit.

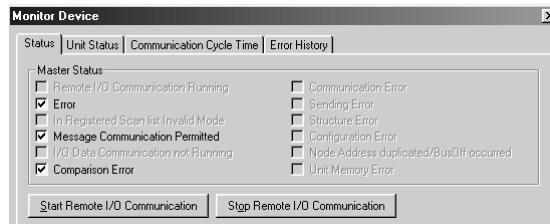

**Note** This operation is not required if no error has occurred in the master node.

#### Master Connected using Serial Line

- 1,2,3... 1. Double-click the icon for the master to display the Edit Device Parameters Window and click the **Message Timer** Tab.
2. Double-click the unit number of the DeviceNet Communications Unit, set 5,000 ms in the Setup Message Timer Window, and click the **OK** Button.

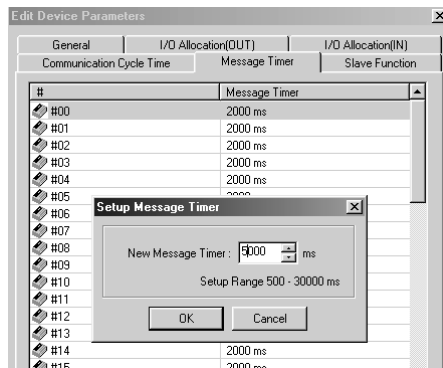

3. Click the **Download** Button on the General Tab Page in the Edit Device Parameters Window to execute the download.

### 5-2-2 Edit Device Parameters Window

- 1,2,3... 1. Turn ON the power to the DeviceNet Communications Unit and master, and then put the Configurator online, and select **Upload** from the *Network* Menu.  
The configuration of Units connected in the Network will be read and displayed in the Network Configuration Window.



2. Double-click the icon for the DeviceNet Communications Unit in the Network Configuration Window, or right-click and select **Parameter** and **Edit** to display the Edit Device Parameters Window for the DeviceNet Communications Unit.

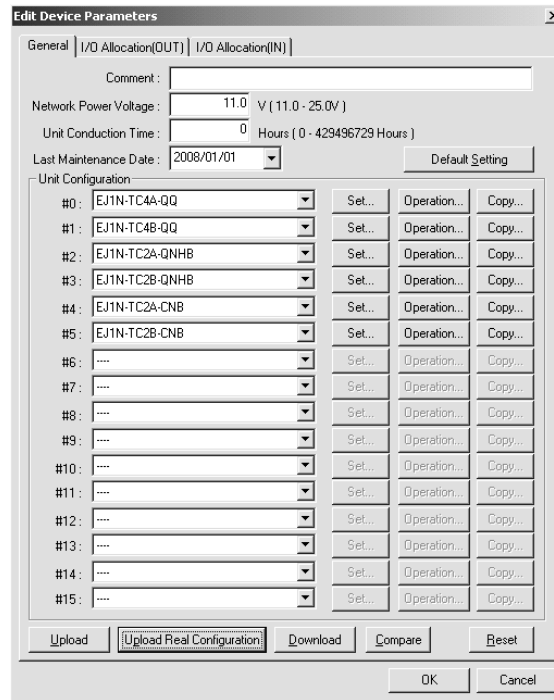

- Note**
1. Click the Upload Button to read the Unit configuration registered in the DeviceNet Communications Unit.
  2. Click the Upload Real Configuration Button to read the configuration of the Temperature Controllers currently connected to the DeviceNet Communications Unit at that time.
  3. Click the Reset Button to reset the DeviceNet Communications Unit. The status of the Unit will be the same as if the power had been turned OFF and ON again. Temperature Controllers, however, will not be reset during operation.
  4. Click the Default Setting Button to initialize all the DeviceNet Communications Unit settings, and return them to the factory setting status. The Configurator screen will not return to factory setting status, however, so click the Upload Button to read the settings again. The message monitor timer must be changed to use this function. For details, refer to page 107.

**Caution** Always turn OFF the OUT Enable Bit when using the Configurator to download the parameters set in the Temperature Controller. If the OUT Enable Bit are not OFF when downloading, the set values allocated with I/O and the set values downloaded with the Configurator will compete, causing the set values allocated using I/O to be enabled. For details on OUT Enable Bit, refer to *OUT Enable Bit* on page 65.

### 5-2-3 Setting DeviceNet Communications Unit Comment

A name can be assigned to the DeviceNet Communications Unit and recorded in the Unit. The name can be entered using up to 32 standard characters. The comment for the registered DeviceNet Communications Unit is

used in the Configurator display, such as in the Maintenance Mode Window (refer to page 97).

**Note** The DeviceNet Communications Unit comment is stored even when the power is turned OFF.

**Setting Method**

**1,2,3...** In the DeviceNet Communications Unit's Edit Device Parameters Window, click the **General** Tab, and enter a comment in the *Comment* field at the top of the Tab Page.

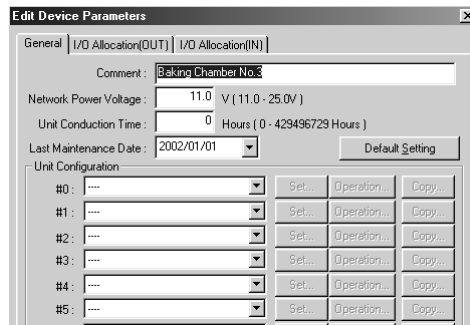

**Note** Comments can also be set by right-clicking the DeviceNet Communications Unit in the Network Configuration Window and selecting **Change Device Comment**.

After setting a comment, right-click and select **Parameter** and **Download** to write the comment to the DeviceNet Communications Unit.

**5-2-4 Setting Network Power Voltage Monitor**

With the Network power voltage monitor, the present value, bottom (minimum) value, and peak (maximum) value are recorded in the DeviceNet Communications Unit, and when the voltage drops below the set monitor value, the Network Power Voltage Error Flag in the Unit Status Area will be turned ON.

The PV, bottom value, and peak value of the network power supply, and the Unit Status Area can be checked from the Maintenance Mode Window.

- Note**
1. The range of the network power voltage for the DeviceNet Communications Unit is 11 to 25 V, so if the network power voltage drops below 11 V, the operation for reading the measured voltage value may not function properly.
    - The default monitor value for the network power voltage is set to 11.0 V.
    - The network power supply monitor value is held even when the power is turned OFF.
  2. The present, bottom, and peak values for the network power voltage are cleared when the network power is turned OFF.

**Setting Method**

- 1,2,3... Open the Edit Device Parameters Window for the DeviceNet Communications Unit, select the **General** Tab, and enter the desired value in the *Network Power Voltage* field.

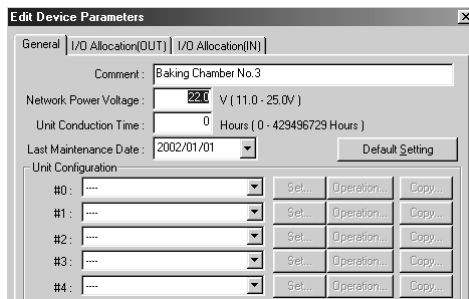

**5-2-5 Setting the Unit Conduction Time Monitor**

The DeviceNet Communications Unit can record the conduction time (time that communications power is supplied to the Unit), and when the value exceeds the set monitor value, the Unit Maintenance Bit in the Unit Status Area will be turned ON.

This function provides a guideline for when to replace the Unit.

Measuring unit: 0.1 h (On the Configurator, however, the display unit will be 1 h.)

Measured time: 0 to 429496729.5 h  
(stored data: 00000000 to FFFFFFFF hex)

Monitor value setting range: 0 to 429496729 hours (specify as an integer)

The present value for conduction time and the Unit Status Area can be checked in the Maintenance Information Window when using Maintenance Mode.

**Note** The present value and monitor value for the conduction time are held even when the power is turned OFF.

**Setting Method**

- 1,2,3... Open the Edit Device Parameters Window for the DeviceNet Communications Unit, select the **General** Tab, and enter the desired value in the *Unit Conduction Time* field.

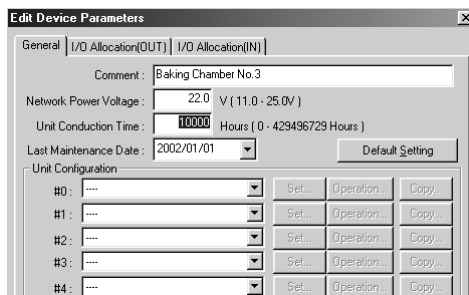

### 5-2-6 Setting Last Maintenance Date

With DeviceNet Communications Units, the last date on which maintenance was last performed can be written to the Unit. This means that the timing for future maintenance can be judged more easily. The recorded date can be checked from the Maintenance Mode Window.

**Note** The present value and monitor value for the conduction time are held even when the power is turned OFF.

#### Setting Method

- 1,2,3... Open the Edit Device Parameters Window for the DeviceNet Communications Unit, click the **General** Tab, and select the applicable date from the calendar in the pull-down menu in the *Last Maintenance Date* field.

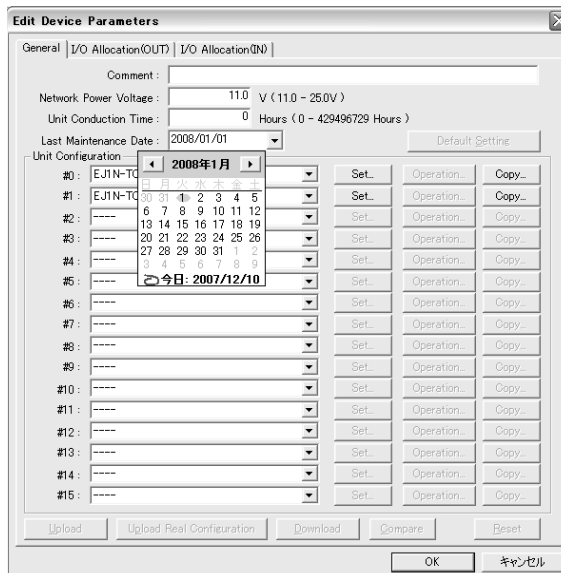

### 5-2-7 Copying Temperature Controller Parameters

Parameters of the Temperature Controllers connected to the DeviceNet Communications Unit can be easily copied between Temperature Controllers by simply specifying the copy source and destination. The all the parameters for one channel of the Temperature Controller are copied, so multiple Temperature Controllers requiring the same settings can be easily set.

#### Setting Method

- 1,2,3...
1. Open the Edit Device Parameters Window for the DeviceNet Communications Unit, select the **General** Tab, and click the **Copy** Button of the Temperature Controller unit number under *Unit Configuration* from which the parameters are to be copied.

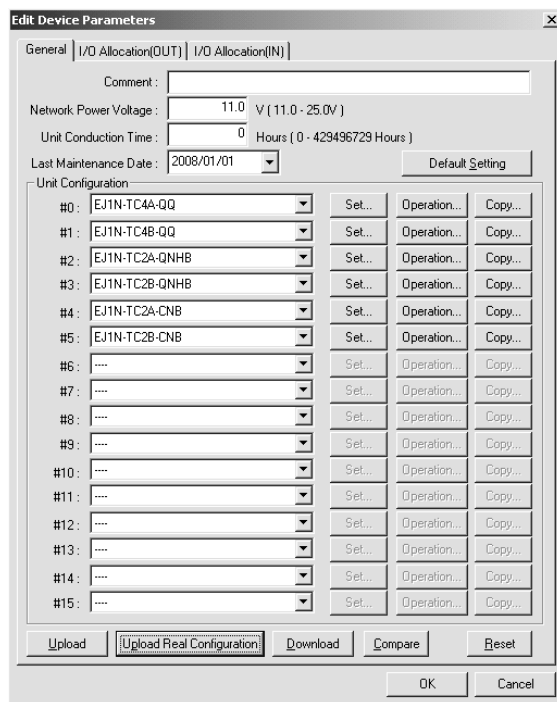

2. The Copy Parameters Window will be displayed.

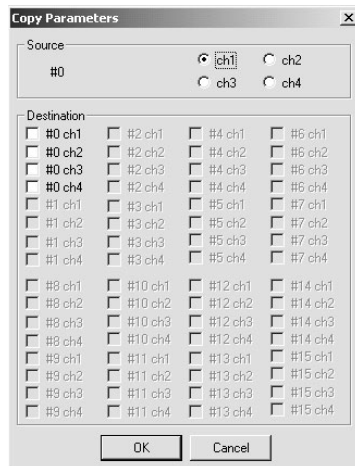

3. Select the channel from which to copy, specify the unit number and channel as the copy destination, and then click the **OK** Button. The parameters will be copied and the display will return to the Edit Device Parameters Window for the DeviceNet Communications Unit.
4. From the Edit Device Parameters Window, select the **General** Tab, and click the **Download** Button to write all the parameters copied from the Temperature Controller.

### 5-2-8 Sending Operation Commands to the Temperature Controllers

The Configurator can be used to send operation commands to each of the Temperature Controllers through the DeviceNet Communications Unit.

The following operation commands can be executed from the Configurator.

- RUN/STOP
- Alarm latch cancel
- Auto/manual
- Initialize settings
- AT execute/cancel
- Software reset
- LSP/RSP switching
- Clear error
- Write mode

### Operating Method

- 1,2,3... 1. Open the Edit Device Parameters Window for the DeviceNet Communications Unit, select the **General** Tab, and click the **Operation** Button for the Temperature Controller unit number in the *Unit Configuration* field.

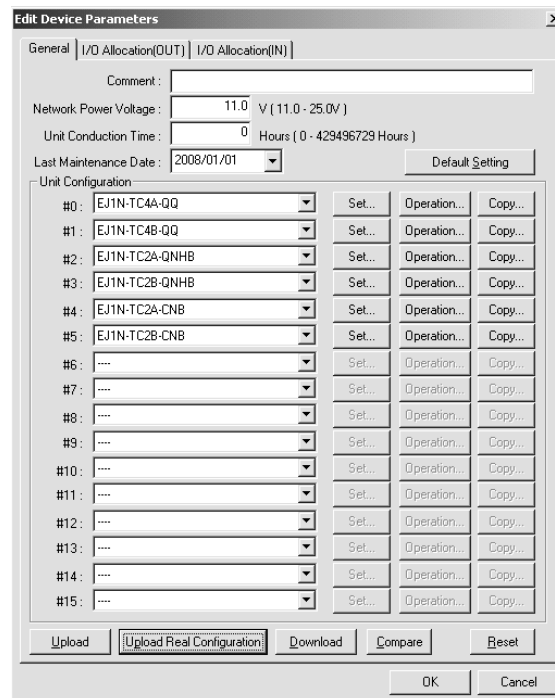

- The window for sending operation commands to the specified Temperature Controller will be displayed.

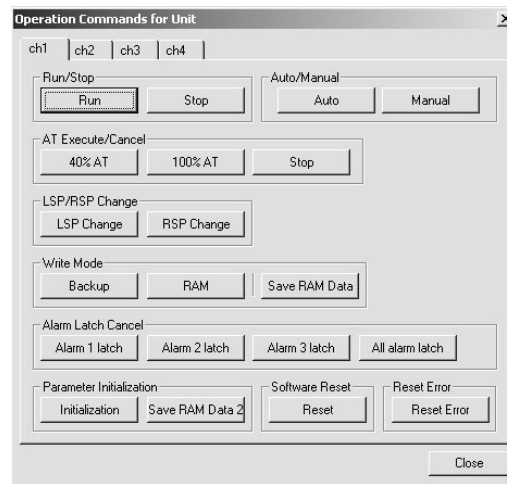

- Select the Tab Page for the channel that will be sent the command, and click the button of the operation to be executed.

**Note** The message monitor timer must be changed to initialize settings. For details, refer to page 107.

- After the operation command is executed, click the **Close** Button. The display will return to the Edit Device Parameters Window for the DeviceNet Communications Unit.

**Note** Use the following procedure to change a manual manipulated variable.

- 1,2,3...**
- Click the **Manual** Button.
  - Change the manipulated variable in the Edit Unit Parameters Window, and click the **Download can be changed during operation** Button.

**Note** Use the following procedure to initialize the Temperature Controller.

- 1,2,3...**
- Click the **Parameter Initialization** Button and then the **Save RAM Data 2** Button.
  - Click the **Reset** Button in the Edit Device Parameters Window.

### 5-2-9 Editing Temperature Controller Parameters

The Configurator can be used to edit the parameters of each connected Temperature Controller through the DeviceNet Communications Unit.

- 1,2,3... 1. Open the Edit Device Parameters Window for the DeviceNet Communications Unit, click the **General** Tab and click the **Set** Button next to the Temperature Controller unit number under *Unit Configuration*.

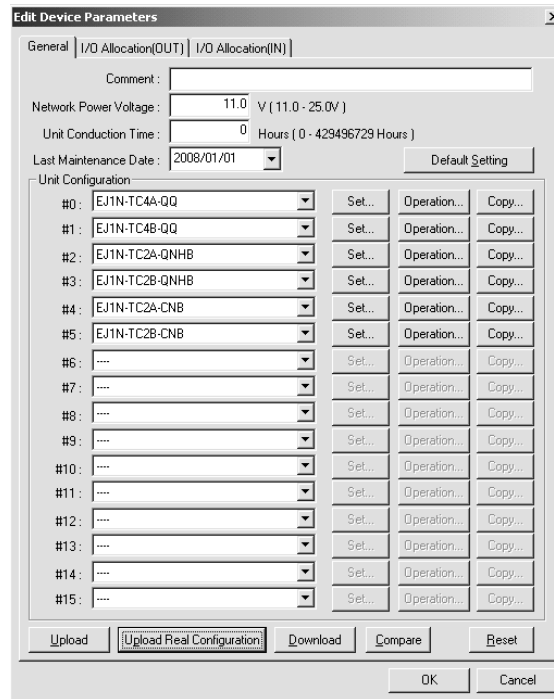

2. A window for editing the unit parameters of the corresponding Temperature Controller will be displayed.

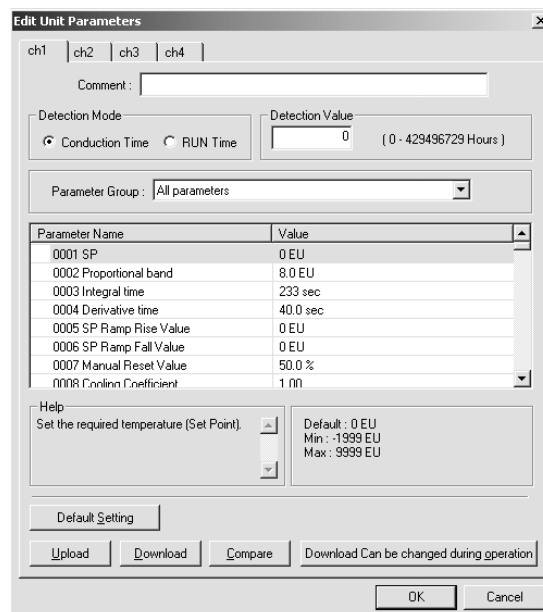

Note a)  This icon indicates parameters that are shared by ch1 to ch4. If a value for any channel is changed, the other value will also change.



 This icon indicates a parameter that is read only.

- b) The Temperature Controller parameters are stored even if the power is turned OFF.
3. Select the tab page of the channel for which the parameters are to be edited, and edit the parameters.
4. Click the parameter to be edited, and change the contents.

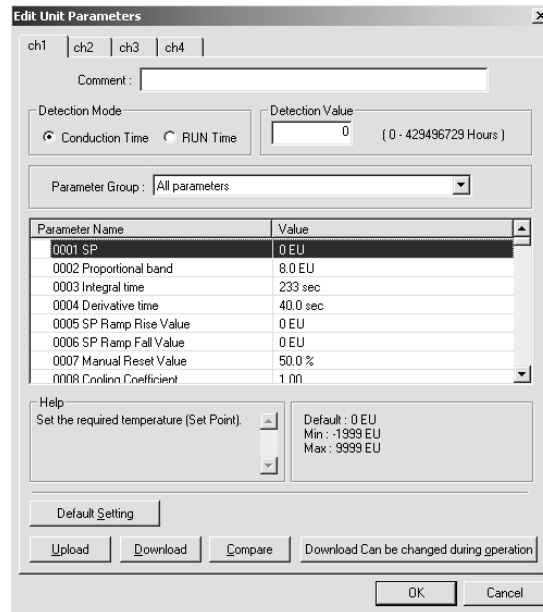

Note a) Click the **Download** Button to download all parameters. When this operation is performed, the Unit will be reset, so do not use this operation while the Unit is in RUN mode.

b) By clicking the ▼ Button in the *Parameter Group* field, the displayed parameters can be changed as follows:

- All parameters
- Parameters that can be changed during operation
- Parameters that can be changed when operation is stopped.

c) Click the **Default Setting** Button to return parameters to the factory settings.

d) Click the Upload, Download, Compare, and Default Setting Buttons in the Edit Unit Parameters Window to perform operations on the parameters for the specified channel only.

e) Use the **Download can be changed during operation** Button to download parameters that can be changed during operation. The Unit will not be reset.

5. Click the **OK** Button.

The display will return to the Edit Device Parameters Window for the DeviceNet Communications Unit.

Note All the new settings will be canceled if the **Cancel** Button or  Button is clicked to exit the window. Always exit the window by clicking the **OK** Button.

6. To continue editing the parameters of other Temperature Controllers, repeat the procedure from step 1.

- After editing the parameters of each Temperature Controller, return to the **General** Tab Page and click the **Download** Button to download the set parameters to the DeviceNet Communications Unit in a batch.

### 5-2-10 Setting Temperature Controller Comment

Names can be assigned to each of the Temperature Controllers, and recorded in the DeviceNet Communications Unit. Each name can be entered using up to 32 standard characters.

The registered Temperature Controller comments are used in the Configurator, such as in the Monitor Window and Maintenance Mode Window.

**Note** The comments set for Temperature Controllers are stored even when the power is turned OFF.

#### Setting Method

- 1,2,3... 1. Open the Edit Device Parameters Window for the DeviceNet Communications Unit, select the **General** Tab Page, and click the **Set** Button. The Edit Unit Parameters Window will be displayed.

The screenshot shows the 'Edit Unit Parameters' window for a Temperature Controller. The window has tabs for 'ch1', 'ch2', 'ch3', and 'ch4'. The 'Comment' field is set to 'Heater No.1'. The 'Detection Mode' is set to 'Conduction Time' (selected) and 'RUN Time'. The 'Detection Value' is set to '0' (0 - 429496729 Hours). The 'Parameter Group' is set to 'All parameters'. A table lists parameters and their values:

Parameter Name	Value
0001 SP	0 EU
0002 Proportional band	8.0 EU
0003 Integral time	233 sec
0004 Derivative time	40.0 sec
0005 SP Ramp Rise Value	0 EU
0006 SP Ramp Fall Value	0 EU
0007 Manual Reset Value	50.0 %
0008 On/Off Coefficient	1.00

The 'Help' section shows 'Set the required temperature (Set Point)' with a dropdown menu. The 'Default Setting' section shows 'Default : 0 EU', 'Min : -1999 EU', and 'Max : 9999 EU'. At the bottom, there are buttons for 'Default Setting', 'Upload', 'Download', 'Compare', 'Download Can be changed during operation', 'OK', and 'Cancel'.

- Enter the name or other comment in the *Comment* field.
  - Click the **OK** Button to return to the Edit Device Parameters Window.
- Note** If the window is exited by clicking the Cancel Button or **X** Button, all the new settings will be canceled. Always click the **OK** Button to exit the window.
- To continue setting comments for other Temperature Controllers, repeat the procedure from step 1.
  - After entering comments for each Temperature Controller, return to the **General** Tab Page and click the **Download** Button to write the comments to the DeviceNet Communications Unit in a batch.

### 5-2-11 Setting Temperature Controller Monitor Mode and Monitor Values

A conduction time monitor and total RUN time monitor can be used to calculate the conduction time or RUN (control) time of connected Temperature Controllers and record the time in the DeviceNet Communications Unit. When

the total time exceeds the set monitor value, the Temperature Controller Maintenance Bit in the Unit Status Area will be turned ON.

These monitors provide a guideline for when to replace the Temperature Controllers.

Set whether to total the Unit conduction time or RUN time using the MONITOR mode.

Measuring unit: 0.1 h (The Configurator display is in 1-h units.)

Measured time: 0 to 429496729 h

(stored data: 00000000 to FFFFFFFF hex)

Monitor value setting range: 0 to 429496729 hours

The present values for the conduction time or RUN time, and the Unit status can be checked from the Maintenance Mode Window.

- Note**
1. The present values and monitor values for conduction time or RUN time are stored even when the power is turned OFF.
  2. The conduction time monitor and total RUN time monitor cannot be used at the same time for a single channel.
  3. The total time is not calculated when the communications power to the DeviceNet Communications Unit is turned OFF.
  4. The DeviceNet Communications Unit checks the ON/RUN status of the specified Temperature Controller approximately every 0.1 hour (6 minutes). Depending on the measurement timing, the accurate may not be obtained due to the timing interval, as shown in the following examples.

**Example 1: Using the Unit conduction time monitor when communications power is turned ON and OFF for three minutes each (A)**

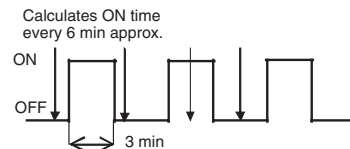

In the above diagram, the actual conduction time is 3 minutes  $\times$  3 = 9 minutes, but the status is ON only once at the time the measurement is taken, so the conduction time is calculated as 6 minutes.

**Example 2: Using the Unit conduction time monitor when communications power is turned ON and OFF for three minutes each (B)**

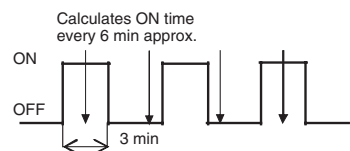

In the above diagram, the actual conduction time is 3 minutes  $\times$  3 = 9 minutes, but the status is ON only twice at the time the measurement is taken, so the conduction time is calculated as 12 minutes.

**Example 3: Using the Unit conduction time monitor when communications power is turned ON for 9 minutes, OFF for 3 minutes, and ON for 9 minutes**

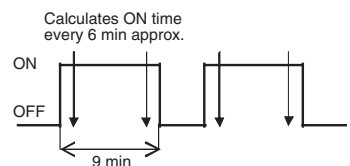

In the above diagram, the actual conduction time is 9 minutes  $\times$  2 = 18 minutes, but the status is ON four times when the measurement is taken, so the conduction time is calculated as 24 minutes.

## Setting Method

- 1,2,3...
1. Open the Edit Unit Parameters Window, select the monitor mode to be used, *Conduction Time* or *RUN Time*, under the *Detection Mode*, and enter the monitoring time in the *Value* field.

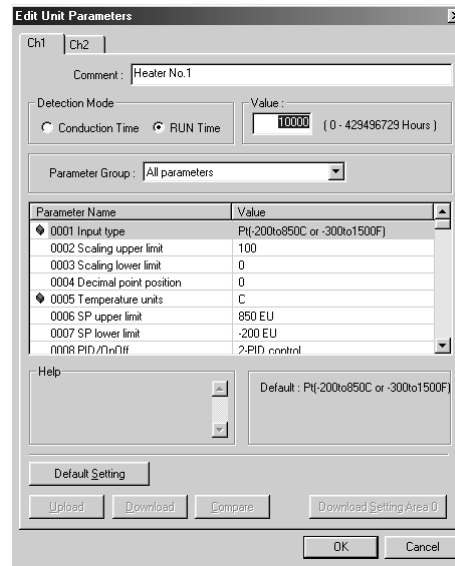

2. Click the **OK** Button to return to the Edit Device Parameters Window.
 

**Note** All the settings will be cleared if the **Cancel** Button or **X** Button is used to exit the window. Always click the **OK** Button to exit the window.
3. To continue setting monitor values for other Temperature Controllers, repeat the procedure from step 1.
4. After setting monitor values for each Temperature Controller, return to the **General** Tab Page and click the **Download** Button to write the monitor values for all the Temperature Controllers to the DeviceNet Communications Unit in a batch.

## 5-3 Maintenance Mode Window

### 5-3-1 Maintenance Mode Window

The Maintenance Mode Window is different from the Main Window and is used to easily monitor the Network status and the status of each node.

In the Network Configuration Window of the Maintenance Mode Window, when an error is detected in a node, a yellow warning icon is displayed next to the corresponding node icon, enabling errors to be checked immediately.



By double-clicking on a node in the Network Configuration Window of the Maintenance Mode Window, the Maintenance Information Window is displayed, and the status of the node can be checked.

The Maintenance Mode Window is displayed with a pale blue background.

### Maintenance Mode Window Display

Use either of the following two procedures to switch between the Main Window and the Maintenance Mode Window.



## Switching from the Icons in the Toolbar

- 1,2,3...
1. From the Main Window, click the  icon in the Configurator Toolbar to switch to the Maintenance Mode Window.
  2. Click the  icon to return to the Main Window.

## Switching from the View Menu

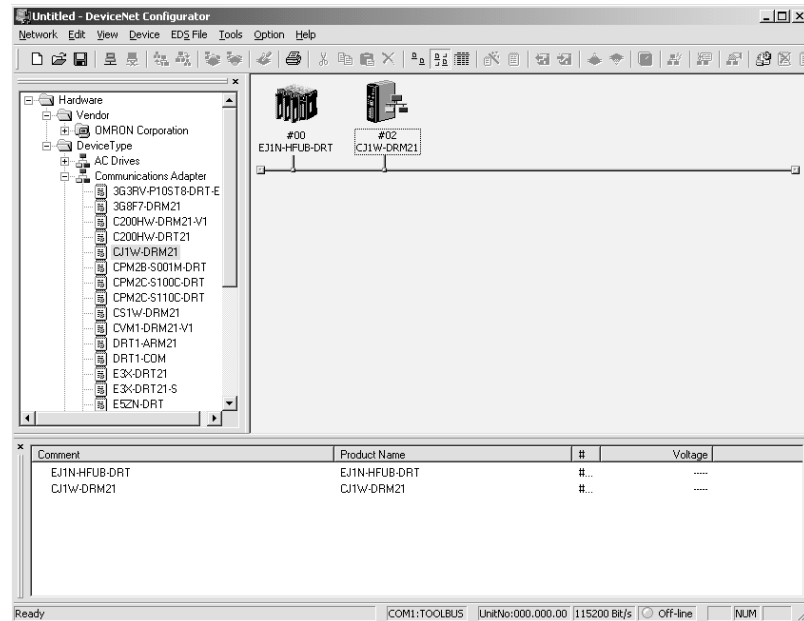
- 1,2,3...
1. From the menu bar, select **View** and **Large Icons (Maintenance Mode)** to switch to the Maintenance Mode Window.
  2. From the menu bar, select **View** and **Large Icons** to return to the Main Window.



- Note**
1.  This icon indicates that the Network power supply is low.
  2.  This icon indicates that the Maintenance Bit is ON.

### 5-3-2 Maintenance Information Window

#### General Tab Page

**1,2,3...** From the Maintenance Mode Window, double-click the icon for the DeviceNet Communications Unit in the Network Configuration Window. The following Maintenance Information Window for the DeviceNet Communications Unit will be displayed.

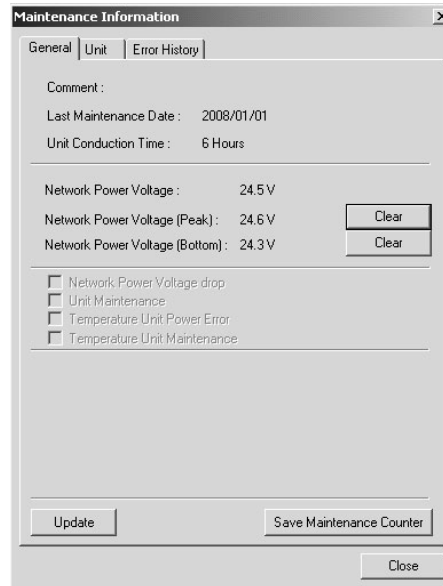

The following information can be checked from the General Tab Page.

Item	Description
Comment	Displays the comment set using the comment setting function of the DeviceNet Communications Unit.
Last Maintenance Date	Displays the last maintenance date set in the DeviceNet Communications Unit.
Unit Conduction Time	Displays the present value for the conduction time of the DeviceNet Communications Unit.
Network Power Voltage	Displays the present value for the communications power voltage being supplied to the DeviceNet Communications Unit.
Network Peak Power Voltage	Displays the peak communications power voltage supplied to the DeviceNet Communications Unit since start-up.
Network Bottom Power Voltage	Displays the bottom communications power voltage supplied to the DeviceNet Communications Unit since start-up.
Unit Status (See note 1.)	
Network Power Voltage Drop	Selected if the power supply for the Temperature Controller is OFF (Temperature Controller Power Status Flag).
Unit Maintenance Time	Selected if the conduction time of the DeviceNet Communications Unit exceeds the setting (Maintenance Flag).
Temperature Controller Power Error	Selected if the power supply for the Temperature Controller is OFF (Temperature Controller Power Status Flag).
Temperature Controller Maintenance Time	Selected if the total ON/RUN time exceeds the setting.

**Note** 1. The content of Unit Status is the same as that for Unit Status in allocation data. (For information, refer to *Unit Status* in 4-3-4 Input Data.

2. Click the Refresh Button to read the maintenance information, error history, and Temperature Controller maintenance information from the DeviceNet Communications Unit and display the most recent values.
3. Click the Save Maintenance Counter Button to save the Unit conduction time and Temperature Controller maintenance counter values in the DeviceNet Communications Unit's internal non-volatile memory.
4. Even if the Save Maintenance Counter Button is not clicked, the values will normally be saved in the non-volatile memory once every six minutes.

**Unit Tab Page**

1,2,3...

1. From the Maintenance Mode Window, double-click the icon for the DeviceNet Communications Unit in the Network Configuration Window.
2. The Maintenance Information Window for the DeviceNet Communications Unit will be displayed. Select the **Unit** Tab.
3. When the present values for the Unit conduction time or total RUN time exceed the monitor value set in the total ON/RUN time monitor, a warning icon will be displayed beside the corresponding unit number in the #ch column.

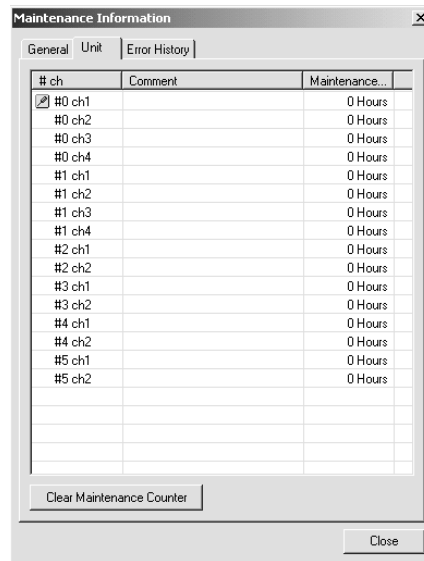

The following information can be confirmed for each of the Temperature Controllers connected to the DeviceNet Communications Unit.

Item	Details
Comment	Displays the Temperature Controller comment set using the comment function.
Maintenance Counter	Displays the present value for the Unit conduction time or total RUN time measured using the total ON/RUN time monitor.

**Note** Click the **Clear Maintenance Counter** Button to clear the contents of the maintenance counter.

**Error History Tab Page**

1,2,3...

1. From the Maintenance Mode Window, double-click the icon for the DeviceNet Communications Unit in the Network Configuration Window.
2. The Maintenance Information Window for the DeviceNet Communications Unit will be displayed. Select the **Error History** Tab.

- 3. The Error History Tab Page displays the error status information (communications error code, communications power voltage when the error occurred) that is recorded in the DeviceNet Communications Unit for the last four communications errors that occurred.

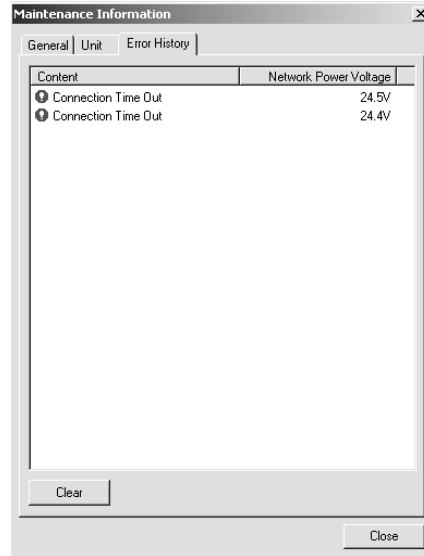

- Note**
- 1. When four communications errors are already recorded in the error history and a new communications error occurs, the earliest error will be deleted and the most recent communications error will be recorded.
  - 2. Click the **Clear** Button to clear the communications error history in the DeviceNet Communications Unit. The display in the Error History Tab Page will also be cleared.



## 5-4 DeviceNet Communications Unit Monitor

The monitor lists various status information for the DeviceNet Communications Unit.

### Displaying the Monitor

- 1,2,3... 1. Select **Network** and **Connection**, and put the Configurator online.
2. Right-click the icon of the DeviceNet Communications Unit, and select **Monitor**. The following Monitor Device Window will be displayed.

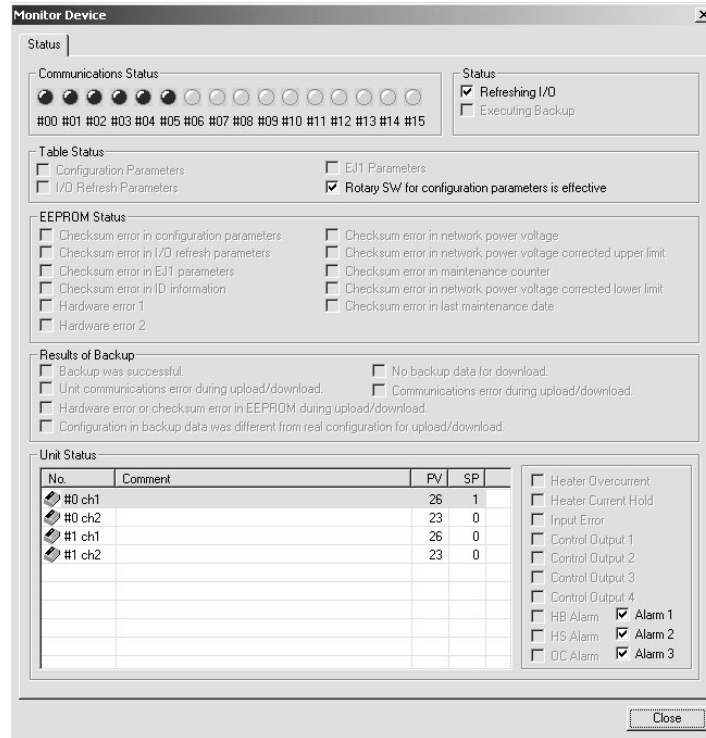

Item	Details
Communications Status	Displays the communications status of the Temperature Controllers connected to the Communications Unit. (Blue) Communicating normally. (Red) A communications error has occurred.
Status	Displays the Communications Unit's present operating status.
Table Status	Displays the status of the Communications Unit's setup table.
EEPROM Status	Displays the status of the Communications Unit's non-volatile memory (EEPROM).
Results of Backup	Displays the results of the backup operation.
Unit Status	Displays the Temperature Controller process value (PV), and set value (SP). The details for the Temperature Controller that is positioned under the cursor are displayed on the right of the Tab Page.

**Note** The Monitor Device Window will respond slowly if many Temperature Controllers are connected. Operation can be improved by selecting *Setup Monitor Refresh Timer* in the Options Menu and setting a value of 3 s or higher.

# SECTION 6

## Explicit Message Communications

This section describes how to send explicit messages to the EJ1 DeviceNet Communications Unit, including how to send CompoWay/F commands using explicit messages. CompoWay/F commands are supported by the EJ1 Temperature Controller.

6-1	Overview of Explicit Message Communications . . . . .	104
6-1-1	Explicit Message Communications . . . . .	104
6-1-2	Explicit Messages Types. . . . .	105
6-1-3	Explicit Messages Basic Format. . . . .	105
6-1-4	Initializing the DeviceNet Communications Unit or Temperature Controllers. . . . .	107
6-2	Sending CompoWay/F Commands to a Temperature Controller . . . . .	108
6-2-1	CompoWay/F Binary Commands. . . . .	109
6-2-2	CompoWay/F ASCII Commands . . . . .	110
6-2-3	List of FINS-mini Commands . . . . .	111
6-3	Examples Using CompoWay/F Commands . . . . .	112
6-4	Example of Sending Explicit Messages . . . . .	118
6-5	Sending Explicit Messages . . . . .	119
6-5-1	Reading General Status. . . . .	120
6-5-2	Setting and Monitoring the Unit Conduction Time . . . . .	120
6-5-3	Writing Maintenance Mode Information . . . . .	120
6-5-4	Setting and Monitoring Temperature Controller Channels . . . . .	121
6-5-5	Copy Function . . . . .	123

## 6-1 Overview of Explicit Message Communications

### 6-1-1 Explicit Message Communications

Explicit message communications is a communications protocol for sending commands from the master as explicit messages, and receiving explicit messages as responses from the nodes that receive the commands.

Explicit messages can be sent from the master to the DeviceNet Communications Unit to read and write the Temperature Controller variable area, send operation commands, and read and write various other functions supported by the DeviceNet Communications Unit.

Explicit message communications can be used to send and receive data that is not allocated in the IN and OUT Areas due to word size restrictions, and data that does not require the frequent refreshing used by the IN Area and OUT Area.

Use either of the following two methods depending on the application.

#### Reading/Writing Temperature Controller Variable Area Data and Sending Operation Commands

Send Compoway/F communications commands to Temperature Controllers by embedding them in explicit messages.

#### Reading/Writing Maintenance Information for the DeviceNet Communications Unit and Temperature Controllers

Send explicit messages to the DeviceNet Communications Unit.

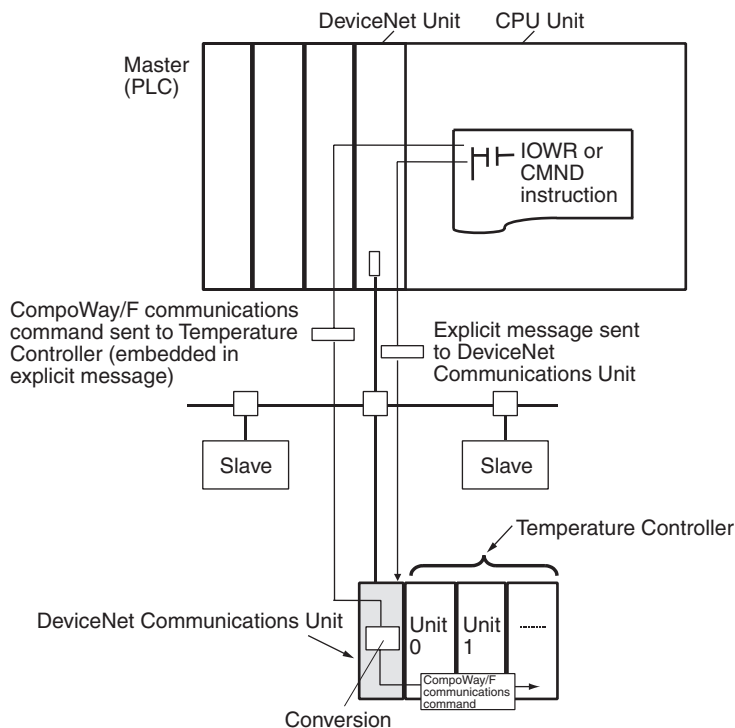

**Note** This manual describes the contents of explicit messages that can be sent to DeviceNet Communications Units. For details on the methods of sending explicit messages, refer to the operation manual for the DeviceNet Unit being used as the master.

## 6-1-2 Explicit Messages Types

The explicit messages sent to the DeviceNet Communications Unit can be divided into two types, as follows:

### Sending CompoWay/F Communications Commands to Temperature Controllers

The master can send CompoWay/F communications commands to the Temperature Controllers by sending to the DeviceNet Communications Unit as explicit messages data.

The DeviceNet Communications Unit automatically converts the explicit messages to CompoWay/F communications commands and sends them to the Temperature Controllers. The responses from the Temperature Controllers are converted into explicit messages and returned to the master. CompoWay/F commands are used to read from and write to the Temperature Controller variable area and to execute operation commands.

CompoWay/F commands consist of binary commands and ASCII commands.

#### **CompoWay/F Binary Commands**

CompoWay/F binary commands are CompoWay/F communications commands expressed in hexadecimal, and are easy to execute from ladder programs. CompoWay/F communications commands that include ASCII data, however, cannot be sent or received. Therefore, Read Controller Attribute (05 03) and broadcasting (communications unit number = XX) cannot be used.

#### **CompoWay/F ASCII Commands**

CompoWay/F ASCII commands are CompoWay/F communications commands expressed in ASCII, so numerical values must be converted to ASCII when executing these commands from a ladder program. All CompoWay/F communications commands can be sent and received, including Read Controller Attribute (05 03) and broadcasting (unit number = XX), which cannot be used with CompoWay/F binary commands.

### Sending Explicit Messages to the DeviceNet Communications Unit

The master can send explicit messages to the DeviceNet Communications Unit to control various operations supported by the DeviceNet Communications Unit and to read settings and status information.

Explicit messages are used to read and write various maintenance data for the DeviceNet Communications Unit and Temperature Controllers.

## 6-1-3 Explicit Messages Basic Format

The basic format of explicit message commands and responses is as follows:

### **Command Block**

Destination node address	Service code	Class ID	Instance ID	Attribute ID	Data
--------------------------	--------------	----------	-------------	--------------	------

#### **Destination Node Address**

This parameter specifies the node address of the DeviceNet Communications Unit to which the explicit messages (commands) will be sent in single-byte (2-digit) hexadecimal.

#### **Service Code, Class ID, Instance ID, Attribute ID**

These parameters specify the command type, processing target, and processing details.

When sending explicit messages to the DeviceNet Communications Unit, specify the target Temperature Controller in the Instance ID. (Specify the Temperature Controller's communications unit number and channel number).

The Attribute ID does not need to be specified for some commands.

**Data** Specifies the details of the commands and set values. The data section is not required for read commands.

**Note** The number of digits used for the Class ID, Instance ID, and Attribute ID depends on the master used. When sending parameters from an OMRON Master Unit, the values are expressed as follows:

- Class ID: 4-digit (2-byte) hexadecimal
- Instance ID: 4-digit (2-byte) hexadecimal
- Attribute ID: 2-digit (1-byte) hexadecimal

**Response Block**

- The following format is used when a normal response is returned for the sent explicit message.

No. of bytes received	Source node address	Service code	Data
-----------------------	---------------------	--------------	------

- The following format is used when an error response is returned for the sent explicit message.

No. of bytes received 0004 hex, fixed	Source node address	Service code	Error code (2 bytes, fixed)
--	---------------------	--------------	--------------------------------

**Number of Bytes Received** The number of data bytes received from the source node address is returned in hexadecimal. When an error response is returned for the explicit message, the contents is always 0004 hex.

**Source Node Address** The address of the node that sent the response is returned in hexadecimal.

**Service Code** For normal responses, the value for when the most significant bit (bit 07) of the service code specified in the command turns ON is returned. (When the service code of the command is 0E hex, the service code of the response will be 8E hex.) When an error response is returned for the explicit message, the contents is always 94 hex.

**Data** Read data is included only when a read command is executed.

**Error Code**

The following table shows the error codes for explicit messages.

<b>Error code</b>	<b>Error name</b>	<b>Cause</b>
08FF	Service not supported	The service code is incorrect.
09FF	Invalid Attribute Value	The specified attribute value is not supported. The data written is out of the data range.
0CFF	Object State Conflict	There is a error in the communications between the DeviceNet Communications Unit and the Temperature Controller. Another explicit message was received while a previous explicit message was being processed. The copy function is being executed.
0EFF	Attribute Cannot Be Set	A write service code was sent for a read-only attribute ID.
10FF	Device State Conflict	An attempt was made to access a Temperature Controller that does not exist. There is an error in the EEPROM.
13FF	Not Enough Data	The data string is shorter than the specified size.
14FF	Attribute Not Supported	The specified attribute is not supported.
15FF	Too Much Data	The data string is longer than the specified size.
16FF	Object Does Not Exist	The specified instance ID is not supported.
19FF	Store Operation Failure	There is an error in the EEPROM of the DeviceNet Communications Unit.

#### 6-1-4 Initializing the DeviceNet Communications Unit or Temperature Controllers

To initialize the DeviceNet Communications Unit or a Temperature Controller, set the DeviceNet message monitor timer to 5 s or longer using the following procedure.

##### **CS/CJ-series DeviceNet Unit**

- 1,2,3...**
1. Using the Configurator, select **Connection** from the Network Menu to switch to online operation.
  2. Double-click the icon for the master, and then click the **Message Timer** Tab in the Edit Device Parameters Window.
  3. Double-click the icon for the DeviceNet Communications Unit, set the timer to 5000 ms in the Setup Message Timer Dialog Box, and then click the **OK** Button. (In this example, the node address of the DeviceNet Communications Unit is 00.)

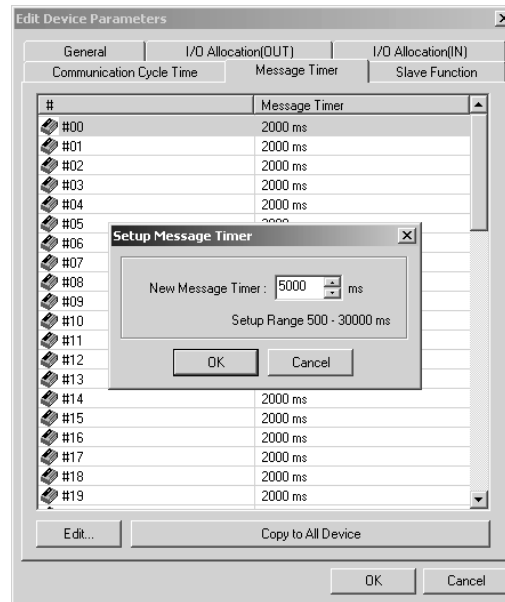

4. Click the **General** Tab in the Edit Device Parameters Window, and then click the **Download** Button. The parameters will be downloaded and the value for the message monitor timer of the DeviceNet Communications Unit will be changed.

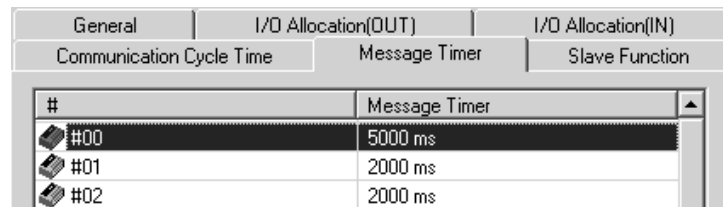

**C2000HE/HG/HX, CVM1, or CV-series DeviceNet Master Unit**

Set the response monitoring time to 5,000 ms when sending the explicit message using an IOWR instruction. (The message timer cannot be set from the Configurator.)

## 6-2 Sending CompoWay/F Commands to a Temperature Controller

The master can send CompoWay/F command frames to the DeviceNet Communications Unit by embedding them in explicit message commands, and receive CompoWay/F response frames that are embedded in explicit messages responses.

When the DeviceNet Communications Unit receives the explicit message command, a CompoWay/F command frame is created by adding STX, ETX, and BCC to the command frame data, from the communications unit number to the FINS-mini command text, after which it is sent to the Temperature Controller. The Temperature Controller returns a CompoWay/F response.

When the DeviceNet Communications Unit receives the CompoWay/F response returned from the Temperature Controller, the STX, ETX, and BCC values are deleted, and then the data is converted to an explicit message response in either hexadecimal or ASCII format, before it is sent to the master. (The DeviceNet Communications Unit performs a BCC check.)

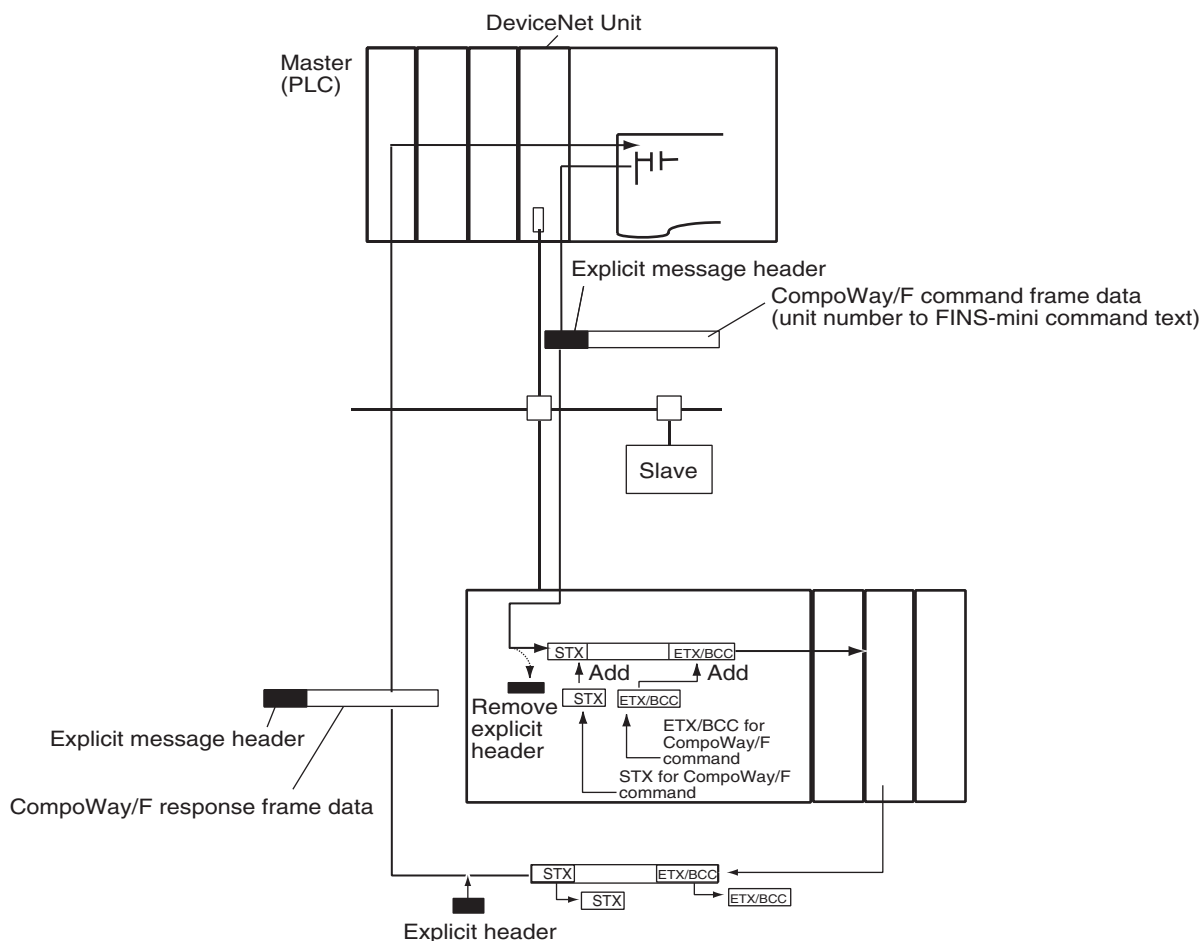

**Note** The CompoWay/F frames can be expressed in binary (hexadecimal) (CompoWay/F binary commands) or ASCII (CompoWay/F ASCII commands). Generally, CompoWay/F binary commands are used to minimize the number of operations. Always use CompoWay/F ASCII commands, however, when broadcasting or executing using a Read Controller Attribute (05 03).

The format of explicit messages used for CompoWay/F commands is explained here. For details on CompoWay/F frames, refer to the *EJ1 Temperature Controller User's Manual* (Cat. No. H142).

### 6-2-1 CompoWay/F Binary Commands

CompoWay/F binary commands use hexadecimal values for the CompoWay/F frames, and not ASCII. Therefore, the data volume is about half of CompoWay/F ASCII commands. The following restrictions apply.

- Read Controller Attribute (05 03), which includes ASCII in the CompoWay/F frame, cannot be used.
- The "XX" used for the communications unit number when broadcasting is ASCII, and therefore cannot be specified.

The following command and response formats are used when executing CompoWay/F binary commands from an OMRON Master.



**Command Block**

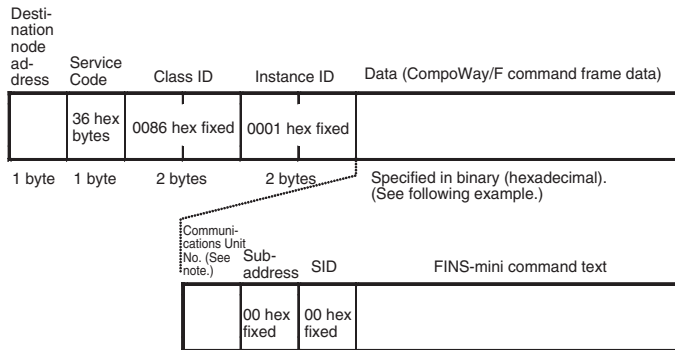

**Note** Broadcasting cannot be specified.

Example: Communications Unit number = 01, FINS-mini command text = 01 01 C0 0000 00 0001 (Executes Read from Variable Area (01 01), to read one element for ch1 PV (C0 0000))

Communications Unit number	Sub-address	SID	FINS-mini command text								
01 hex	00 hex	00 hex	01 hex	01 hex	C0 hex	00 hex	00 hex	00 hex	00 hex	00 hex	01 hex

**Response Block**

**Normal Response**

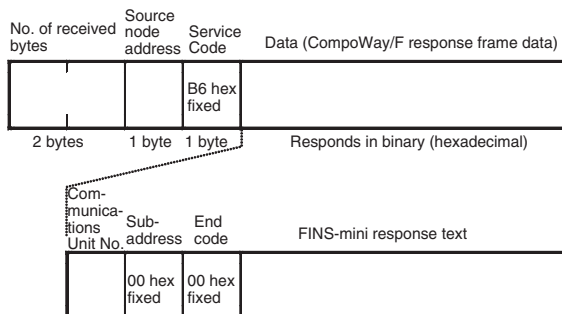

**6-2-2 CompoWay/F ASCII Commands**

When CompoWay/F ASCII commands are used, the CompoWay/F frames are expressed in ASCII (each digit in a specified numerical value is also converted to ASCII, so 52 is specified as 3532 in ASCII). When CompoWay/F ASCII commands are used, all CompoWay/F communications commands supported by Temperature Controllers can be used. (Read Controller Attribute (0503) and broadcasting can be specified.)

The following command and response formats are used when the commands are executed from an OMRON Master Unit.

**Command Block**

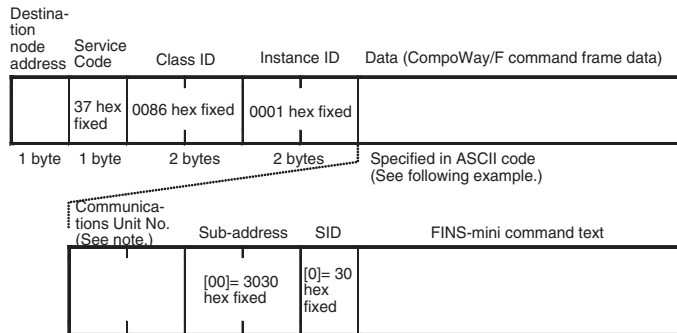

**Note** Note: For broadcasting, specify XX (58 hex 58 hex ASCII)

Example: Unit number = 01, FINS-mini command text = 01 01 C0 0000 00 0001 (Executes Read from Variable Area (01 01), to read one element for ch1 PV (C0 0000).)

Communications Unit No.		Sub-address		SID	FINS-mini command text					
30 hex	31 hex	30 hex	30 hex	30 hex	30 hex	31 hex	30 hex	31 hex	43 hex	30 hex
FINS-mini command text										
30 hex	30 hex	30 hex	30 hex	30 hex	30 hex	30 hex	30 hex	30 hex	30 hex	31 hex

**Response Block**

**Normal Response**

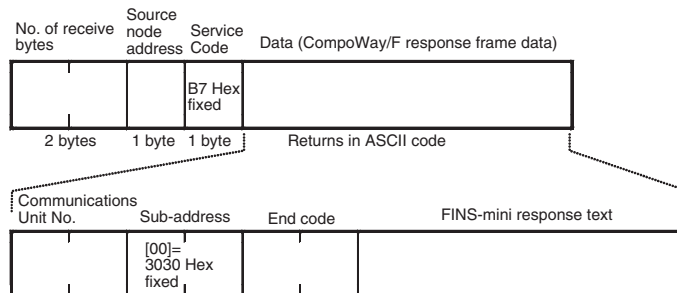

**6-2-3 List of FINS-mini Commands**

The following table lists the FINS-mini commands that can be sent to the Temperature Controllers. For details on commands and the variable area, refer to the *EJ1 Temperature Controller User's Manual* (Cat. No. H142).

MRC	SRC	Service name	Description	MRC, SRC notation	
				CompoWay/F binary commands	CompoWay/F ASCII commands
01	01	Read from Variable Area	Reads a set value.	01 hex 01 hex	30 hex 31 hex 30 hex 31 hex
01	02	Write to Variable Area	Writes a set value.	01 hex 02 hex	30 hex 31 hex 30 hex 32 hex
01	04	Composite Read from Variable Area	Reads more than one non-consecutive set value.	01 hex 04 hex	30 hex 31 hex 30 hex 34 hex
01	13	Composite Write to Variable Area	Writes more than one non-consecutive set value.	01 hex 13 hex	30 hex 31 hex 31 hex 33 hex
01	10	Composite Registration Read	Reads in order the contents of addresses specified for composite read registration of set values.	01 hex 10 hex	30 hex 31 hex 31 hex 30 hex

MRC	SRC	Service name	Description	MRC, SRC notation	
				CompoWay/F binary commands	CompoWay/F ASCII commands
01	11	Composite Read Registration	Specifies the addresses to be read for a composite read of set values.	01 hex 11 hex	30 hex 31 hex 31 hex 31 hex
01	12	Composite Read Registration Confirmation	Reads the contents of the registration for composite read of set values.	01 hex 12 hex	30 hex 31 hex 31 hex 32 hex
05	03	Controller Attribute Read	Reads the model and communications buffer size.	05 hex 03 hex	30 hex 35 hex 30 hex 33 hex
06	01	Controller Status Read	Reads the operating status.	06 hex 01 hex	30 hex 36 hex 30 hex 31 hex
08	01	Echoback Test	Performs an echoback test.	08 hex 01 hex	30 hex 38 hex 30 hex 31 hex
30	05	Operation Command	Executes RUN/STOP, AT execute/AT cancel, and other operations.	30 hex 05 hex	33 hex 30 hex 30 hex 35 hex

- Note**
1. Read Controller Attribute (05 03) cannot be executed using CompoWay/F binary commands. Use CompoWay/F ASCII commands to execute this service.
  2. To write setting data to the variable area for initial settings (variable type C3) when using EJ1 Temperature Controllers (Write to Variable Area 01 02, variable type C3), first execute Move to Setting Area 1 (Operation Commands 30 05, command code 07).

## 6-3 Examples Using CompoWay/F Commands

The following example shows the FINS-mini commands, Write to Variable Area and Read from Variable Area, executed from a CS1W-DRM21 using CompoWay/F binary commands (embedded in explicit messages).

### Operation 1 (Writing SP)

- This example writes the SP to TC2 (unit number 0, ch1). (The SP is 240.) The FINS-mini command writes 000240 hex as the SP data for ch1 with the write start address = 0003 hex, MRC = 01 hex, SRC = 02 hex (Write to Variable Area), variable type = C1 hex, and write start address = 0003 hex.
- The data is written using the EXPLICIT MESSAGE SEND command (2801).
- The command data is written in words starting from D01000 in the CPU Unit's memory, and the response data is stored in DM words starting from D01200.
- If the command does not end normally, the end code is stored in D01106 and the send command is re-executed.

### Explicit Message Command

Destination node address	Service code	Class ID	Instance ID	Communications Unit No.	Sub-address	SID	FINS-mini command text						
							MRC	SRC	Variable type	Address	Bit position	No. of elements	Write data
00 hex	36 hex	0086 hex	0001 hex	00 hex	00 hex	00 hex	01 hex	02 hex	94 hex	0100 hex	00 hex	0001 hex	0240 hex

### Explicit Message Response

No. of bytes received	Source node address	Service code	Communications Unit No.	Sub-address	End code	FINS-mini command text		
						MRC	SRC	Response code
09 hex	00 hex	B6 hex	00 hex	00 hex	00 hex	01 hex	02 hex	0000 hex

## Command Details

[CMND S D C]

S	D01000+0:	2801 hex	Command code
	+1:	0036 hex	DeviceNet Communications Unit node address = 00 Service code = 36 hex
	+2:	0086 hex	Class ID = 0086 hex
	+3:	0001 hex	Instance ID = 01 hex
	+4:	0000 hex	TC2 communications unit number = 00 hex, sub- address (fixed) = 00 hex
	+5:	0001 hex	SID (fixed) = 00 hex MRC = 01 Hex
	+6:	02C1 hex	SRC = 02 hex, variable type = 94 hex
	+7:	0003 hex	Write start address = 0100 hex (2 bytes)
	+8:	0000 hex	Bit position (fixed) = 00 hex, No. of elements = 00 hex (2 bytes)
	+9:	0100 hex	No. of elements = 01 hex, Data = 02 hex (4 bytes)
	+10:	4000 hex	Data = 04 hex (lower byte (00 hex) is not relevant.)
D	D01200:		First response storage word
C	D01100+0:	0015 hex	No. of command data bytes
	+1:	000F hex	No. of response data bytes
	+2:	0000 hex	Remote (destination) network address = 0
	+3:	3FFE hex	Remote (destination) node address = 3F hex Remote (destination) Unit address = FE hex (10 hex also possible)
	+4:	0000 hex	Response required, communications port No.0, No. of retries = 0 hex
	+5:	0064 hex	Response monitoring time

## Response (Operation1)

D01200+0:	2801 hex	Command code
+1:	0000 hex	End code (FINS)
+2:	0009 hex	No. of bytes received
+3:	00B6 hex	Node address = 00 hex, Service code = B6 hex
+4:	0000 hex	TC2 communications unit number = 00 hex, Sub-address (fixed) = 00 hex
+5:	0001 hex	End code (CompoWay/F) = 00 hex, MRC = 01 hex
+6:	0200 hex	SRC = 02 hex, End code (FINS-mini) = 00 hex (2 bytes)
+7:	0000 hex	End code (FINS-mini) = 00 hex (Lower byte (00 hex) is not relevant.)

Program Example (Operation 1)

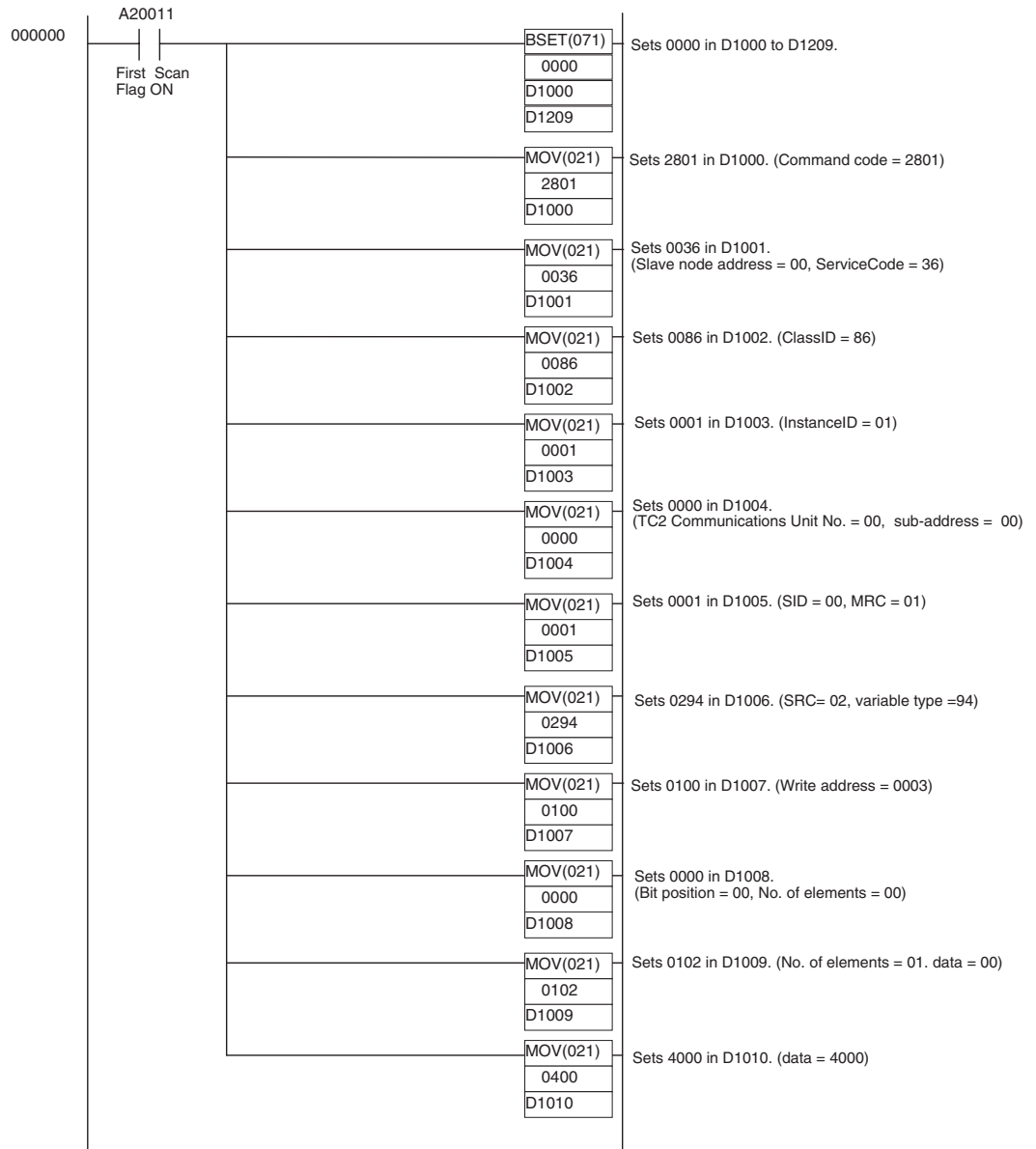

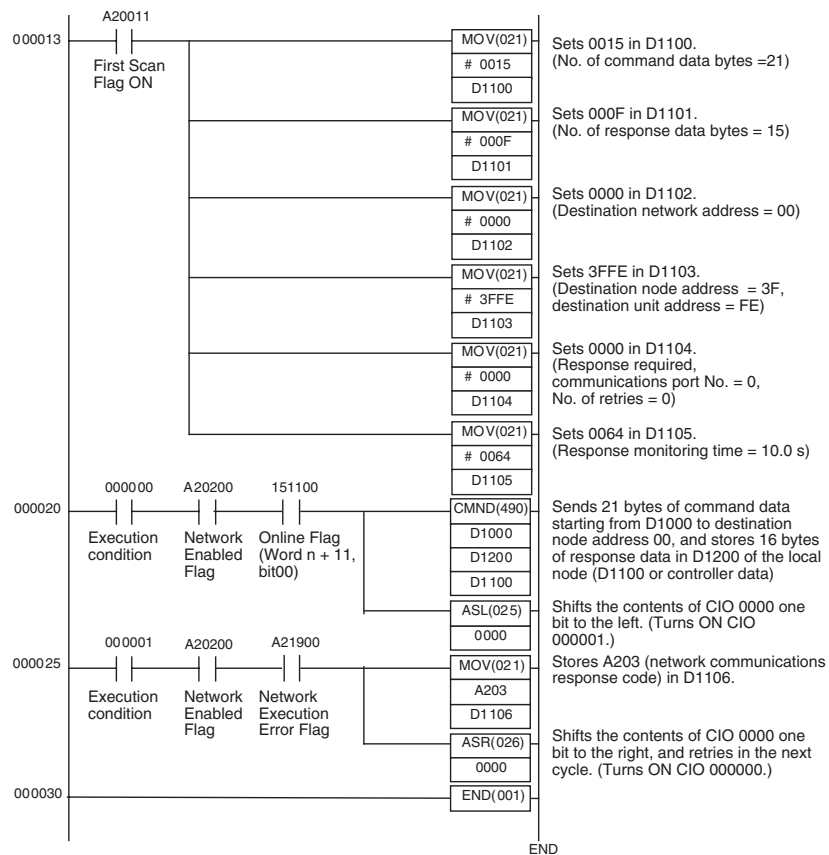

**Operation 2 (Reading PV)**

- Reads the PV for TC2 unit number 0, ch1.  
FINS-mini command: Reads the PV of ch1. MRC = 01 hex, SRC = 01 hex (Read from Variable Area), variable type 00 hex, and read start address = 0000 hex.
- The data is read using the EXPLICIT MESSAGE SEND command (2801).
- The command data is written in DM words starting from D01020 in the CPU Unit's memory, and the response data is stored in DM words starting from D01220.
- If the command does not end normally, the end code is stored in D01126 and the send command is re-executed.

**Explicit Messages Command**

Destination node address	Service code	Class ID	Instance ID	Communica-tions Unit No.	Sub-address	SID	FINS-mini command text					
							MRC	SRC	Variable type	Address	Bit position	No. of elements
00 hex	36 hex	0086 hex	0001 hex	00 hex	00 hex	00 hex	01 hex	01 hex	84 hex	0000 hex	00 hex	0001 hex

**Explicit Messages Response**

No. of bytes received	Source node address	Service code	Communica-tions Unit No.	Sub-address	End code	FINS-mini command text			
						MRC	SRC	Re-sponse code	Read data
0B hex	00 hex	B6 hex	00 hex	00 hex	00 hex	01 hex	01 hex	0000 hex	(Example) 000240 hex

**Command Details  
(Operation 2)**

[CMND S D C]

S	D01020+0:	2801 hex	Command code
	+1:	0036 hex	DeviceNet Communications Unit node address = 00 hex Service code = 36 hex
	+2:	0086 hex	Class ID = 0086 hex
	+3:	0001 hex	Instance ID = 01 hex
	+4:	0000 hex	TC2 communications unit number = 00 hex, sub-address (fixed) = 00 hex
	+5:	0001 hex	SID (fixed) = 00 hex, MRC = 01 hex
	+6:	01C0 hex	SRC = 01 hex, variable type = C0 hex
	+7:	0003 hex	Read address = 0000 hex (2 bytes)
	+8:	0000 hex	Bit position (fixed) = 00 hex, No. of elements = 00 hex (2 bytes)
	+9:	0100 hex	No. of elements = 01 hex
D	D01220:		First response storage word
C	D01120+0:	0013 hex	No. of command data bytes
	+1:	0013 hex	No. of response data bytes
	+2:	0000 hex	Remote (destination) network address = 0
	+3:	3FFE hex	Remote (destination) node address = 3F hex Remote (destination) Unit address FE hex (10 hex is also possible)
	+4:	0000 hex	Response required, communications port No. = 0, No. of retries = 0 hex
	+5:	0064 hex	Response monitoring time

**Response Details (Operation 2)**

D01220+0:	2801 hex	Command code
+1:	0000 hex	End code (FINS)
+2:	000D hex	No. of bytes received
+3:	00B6 hex	Node address = 00 hex, service code = B6 hex
+4:	0000 hex	TC2 communications unit number = 00 hex, sub-address (fixed) = 00 hex
+5:	0001 hex	End code (CompoWay/F), MRC = 01 hex
+6:	0100 hex	SRC = 01 hex, end code (FINS-mini) = 00 hex (2 bytes)
+7:	0000 hex	End code (FINS-mini) = 00 hex, read data = 00 hex (4 bytes)
+8:	0002 hex	Read data = 0002 hex
+9:	4000 hex	Read data = 40 hex (rightmost 00 hex is ignored)

Program Example (Operation 2)

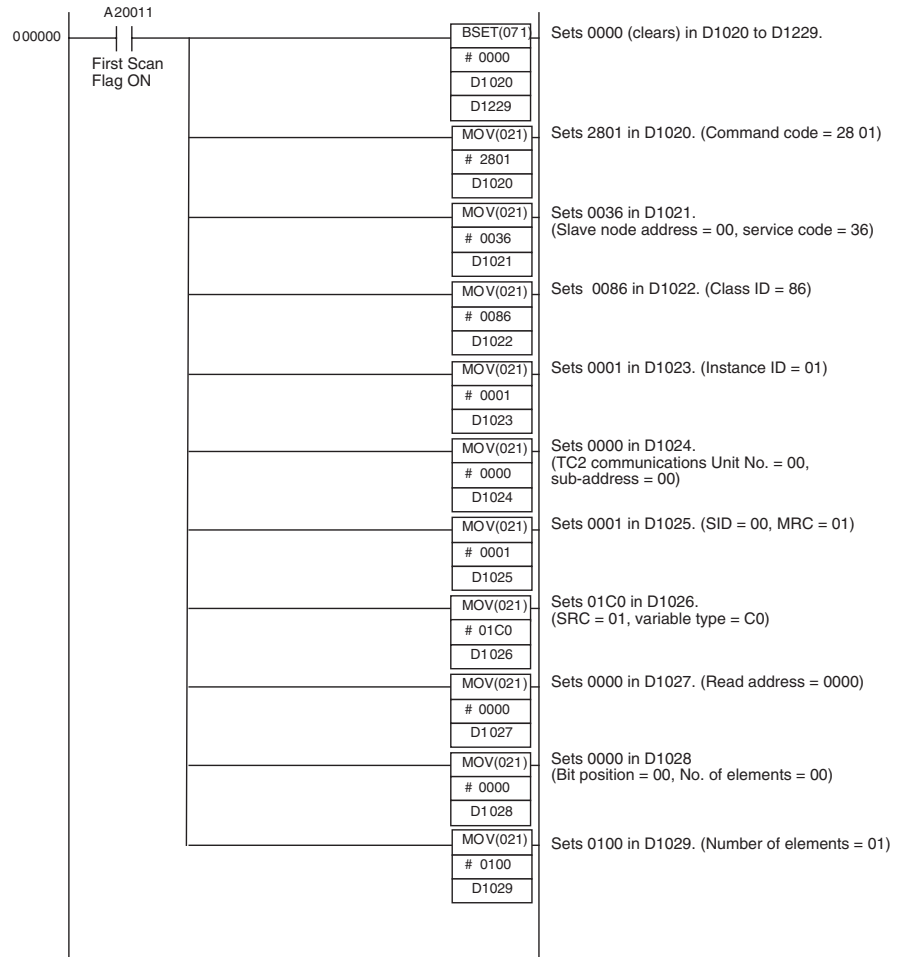



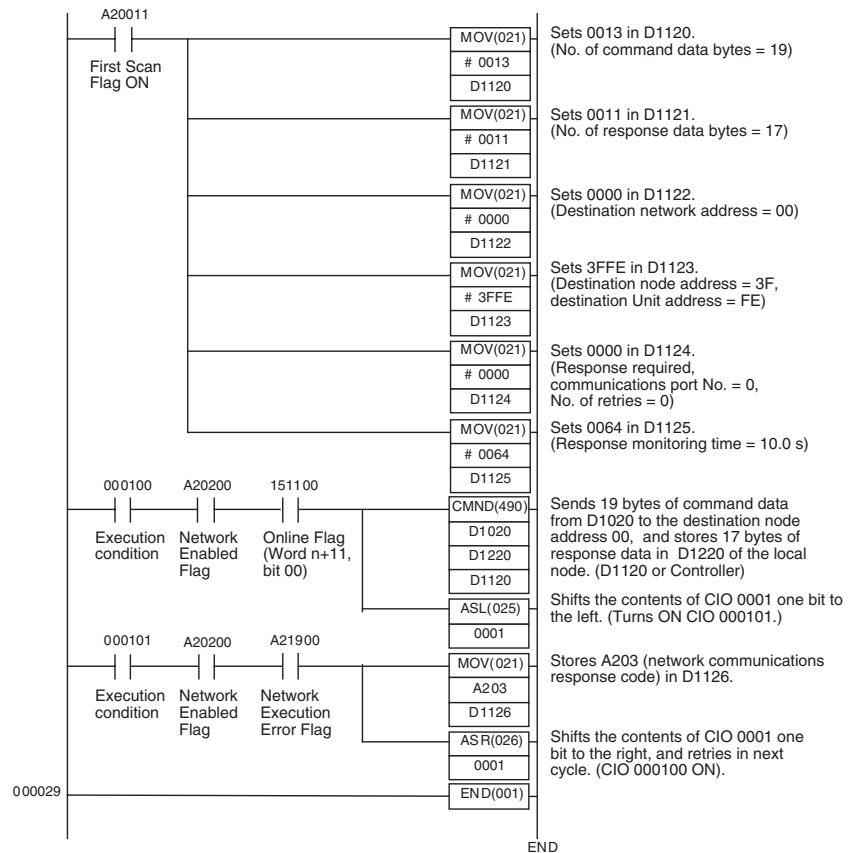

## 6-4 Example of Sending Explicit Messages

The following example shows when an explicit message is sent to the DeviceNet Communications Unit from a CS1W-DRM21 Master Unit to read general status information for the DeviceNet Communications Unit.

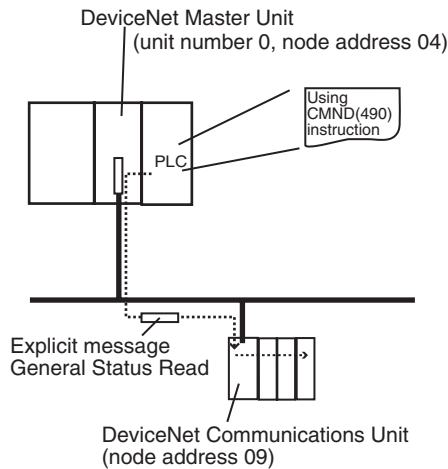

### Operation

- Reads the Unit status of the DeviceNet Communications Unit.
- Status information is read using the EXPLICIT MESSAGE SEND command (28 01).
- The information for the read results is as follows:  
Temperature Controller Power Voltage Status Flag (bit 00) = 1 (Power

OFF), Communications Power Voltage Monitor Error Flag (bit 01) = 0 (normal), Unit Maintenance Flag (bit 03) = 0 (within range), Temperature Controller Maintenance Flag (bit 07) = 0 (within range).

**Explicit Message Command**

Destination node address	Service code	Class ID	Instance ID	Attribute ID
09 hex	0E hex	0095 hex	0001 hex	65 hex

**Explicit Message Response**

No. of bytes received	Source node address	Service code	Data
03 hex	09 hex	8E hex	01 hex

- The command data is written in DM words starting from D01000 in the CPU Unit memory, and the response data is stored in DM words starting from D02000.
- If the command does not end normally, the end code is stored in DM words D00006, and the send command is re-executed.

**Command Details**

[CMND S D C]

- S D01000+0: 2801 hex Command code
- +1: 090E hex DeviceNet Communications Unit node address  
Service code = 0E hex
- +2: 0095 hex Class ID = 0095 hex
- +3: 0001 hex Instance ID = 0001 hex
- +4: 6500 hex Attribute ID = 65 hex
- D D02000: First response storage word
- C D00000+0: 0009 hex No. of command data bytes
- +1: 0009 hex No. of response data bytes
- +2: 0001 hex Remote (destination) network address = 1
- +3: 04FE hex Remote (destination) node address = 4  
Remote (destination) Unit address = FE hex (10 hex is also possible)
- +4: 0000 hex Response required, communications port No. = 0,  
No. of retries = 0 hex
- +5: 003C hex Response monitoring time = 6 s

**Response**

- D02000+0: 2801 hex Command code
- +1: 0000 hex End code (FINS)
- +2: 0003 hex No. of bytes received
- +3: 098E hex Node address = 09 hex, service code = 8E hex
- +4: 0100 hex Node address = 01 hex (rightmost 00 hex is ignored)

**6-5 Sending Explicit Messages**

The following list shows explicit messages that can be sent to the DeviceNet Communications Unit. These messages are used to read and write maintenance information (such as Unit conduction time or total RUN time) for the DeviceNet Communications Unit and Temperature Controllers.

For details on sending explicit messages from an OMRON Master PLC, refer to the corresponding DeviceNet Master Unit operation manual.

**Note** The number of digits used for Class ID, Instance ID, and Attribute ID depends on the master used. When sending parameters from an OMRON Master Unit, the values are expressed as follows:

Class ID: 4-digit (2-byte) hexadecimal  
 Instance ID: 4-digit (2-byte) hexadecimal  
 Attribute ID: 2-digit (1-byte) hexadecimal

### 6-5-1 Reading General Status

Explicit message	Read /write	Function	Command					Response
			Service code	Class ID	Instance ID	Attribute ID	Data size	
General Status Read	Read	Reads the Unit status bits of the DeviceNet Communications Unit (8 bits). (Refer to page 61).	0E hex	95 hex	01 hex	65 hex	---	1 byte

### 6-5-2 Setting and Monitoring the Unit Conduction Time

Explicit message	Read /write	Function	Command					Response
			Service code	Class ID	Instance ID	Attribute ID	Data size	
Unit Maintenance Set Value	Read	Reads the set value (monitor value) for the DeviceNet Communications Unit conduction time (unit: 0.1 h).	0E hex	95 hex	01 hex	73 hex	---	4 bytes 00000000 to FFFFFFFF hex (0 to 4294967295)
	Write	Writes the set value (monitor value) for the DeviceNet Communications Unit conduction time (unit: 0.1 h).	10 hex	95 hex	01 hex	73 hex	4 bytes 00000000 to FFFFFFFF hex (0 to 4294967295)	---
Unit Maintenance Present Value	Read	Reads the PV for the DeviceNet Communications Unit conduction time (unit: 0.1 h).	0E hex	95 hex	01 hex	71 hex	---	4 bytes 00000000 to FFFFFFFF hex (0 to 4294967295)
Unit Maintenance Bit	Read	Reads the monitor status of the Communications Unit conduction time.	0E hex	95 hex	01 hex	72 hex	---	1 byte 00 hex: Within range 01 hex: Out of range (monitor value exceeded)

### 6-5-3 Writing Maintenance Mode Information

Explicit message	Read /write	Function	Command					Response
			Service code	Class ID	Instance ID	Attribute ID	Data size	
Maintenance Counter Save	Save	Records the maintenance counter (PV of total ON/RUN time for all Temperature Controllers) in the DeviceNet Communications Unit's memory.	16 hex	95 hex	01 hex	75 hex	---	---

### 6-5-4 Setting and Monitoring Temperature Controller Channels

Explicit message	Read /write	Function	Command					Response
			Service code	Class ID	Instance ID	Attribute ID	Data size	
Temperature Controller Channel Maintenance Information Monitor Mode	Read	Reads the monitor mode for maintenance information of the Temperature Controller unit number and channel (see note 1) specified by the Instance ID (1 to 64).	0E hex	7A hex	01 to 40 hex	65 hex	---	1 byte 00 hex: Unit conduction time mode 01 hex: Total RUN time mode
	Write	Writes the monitor mode for maintenance information of the Temperature Controller unit number and channel (see note 1) specified by the Instance ID (1 to 64).	10 hex	7A hex	01 to 40 hex	65 hex	1 byte 00 hex: Unit conduction time mode 01 hex: Total RUN time mode	---
Set Value for Unit Conduction Time or Total RUN Time	Read	Reads the set value (monitor value) for the Unit conduction time or total RUN time (unit: s) of the Temperature Controller unit number and channel (see note 1) specified by the Instance ID (1 to 64).	0E hex	7A hex	01 to 40 hex	68 hex	---	4 bytes 00000000 to FFFFFFFF hex (0 to 4294967295)
	Write	Writes the set value (monitor value) for the Unit conduction time or total RUN time (unit: s) of the Temperature Controller unit number and channel (see note 1) specified by the Instance ID (1 to 64).	10 hex	7A hex	01 to 40 hex	68 hex	4 bytes 00000000 to FFFFFFFF hex (0 to 4294967295)	---
Unit Conduction Time or Total RUN Time Read	Read	Reads the PV for the Unit conduction time or total RUN time (unit: s) of the Temperature Controller unit number and channel (see note 1) specified by the Instance ID (1 to 64).	0E hex	7A hex	01 to 40 hex	66 hex	---	4 bytes 00000000 to FFFFFFFF hex (0 to 4294967295)
Monitor Status of Unit Conduction Time or Total RUN Time Read	Read	Reads the monitor status for the Unit conduction time or total RUN time (unit: s) of the Temperature Controller unit number and channel (see note 1) specified by the Instance ID (1 to 64).	0E hex	7A hex	01 to 40 hex	67 hex	---	1 byte 00 hex: Within range 01 hex: Out of range (monitor value exceeded)

**Note** The following table shows the relationship between the Instance IDs (01 to 64) and the Temperature Controller communications unit numbers (0 to 15) and channels (1 to 4).

Instance ID	Unit No., channel	Instance ID	Unit No., channel
01 (01 hex)	Unit 0, ch1	33 (21 hex)	Unit 8, ch1
02 (02 hex)	Unit 0, ch2	34 (22 hex)	Unit 8, ch2
03 (03 hex)	Unit 0, ch3	35 (23 hex)	Unit 8, ch3
04 (04 hex)	Unit 0, ch4	36 (24 hex)	Unit 8, ch4
05 (05 hex)	Unit 1, ch1	37 (25 hex)	Unit 9, ch1
06 (06 hex)	Unit 1, ch2	38 (26 hex)	Unit 9, ch2
07 (07 hex)	Unit 1, ch3	39 (27 hex)	Unit 9, ch3
08 (08 hex)	Unit 1, ch4	40 (28 hex)	Unit 9, ch4
09 (09 hex)	Unit 2, ch1	41 (29 hex)	Unit 10, ch1
10 (0A hex)	Unit 2, ch2	42 (2A hex)	Unit 10, ch2
11 (0B hex)	Unit 2, ch3	43 (2B hex)	Unit 10, ch3
12 (0C hex)	Unit 2, ch4	44 (2C hex)	Unit 10, ch4
13 (0D hex)	Unit 3, ch1	45 (2D hex)	Unit 11, ch1
14 (0E hex)	Unit 3, ch2	46 (2E hex)	Unit 11, ch2
15 (0F hex)	Unit 3, ch3	47 (2F hex)	Unit 11, ch3
16 (10 hex)	Unit 3, ch4	48 (30 hex)	Unit 11, ch4
17 (11 hex)	Unit 4, ch1	49 (31 hex)	Unit 12, ch1
18 (12 hex)	Unit 4, ch2	50 (32 hex)	Unit 12, ch2
19 (13 hex)	Unit 4, ch3	51 (33 hex)	Unit 12, ch3
20 (14 hex)	Unit 4, ch4	52 (34 hex)	Unit 12, ch4
21 (15 hex)	Unit 5, ch1	53 (35 hex)	Unit 13, ch1
22 (16 hex)	Unit 5, ch2	54 (36 hex)	Unit 13, ch2
23 (17 hex)	Unit 5, ch3	55 (37 hex)	Unit 13, ch3
24 (18 hex)	Unit 5, ch4	56 (38 hex)	Unit 13, ch4
25 (19 hex)	Unit 6, ch1	57 (39 hex)	Unit 14, ch1
26 (1A hex)	Unit 6, ch2	58 (3A hex)	Unit 14, ch2
27 (1B hex)	Unit 6, ch3	59 (3B hex)	Unit 14, ch3
28 (1C hex)	Unit 6, ch4	60 (3C hex)	Unit 14, ch4
29 (1D hex)	Unit 7, ch1	61 (3D hex)	Unit 15, ch1
30 (1E hex)	Unit 7, ch2	62 (3E hex)	Unit 15, ch2
31 (1F hex)	Unit 7, ch3	63 (3F hex)	Unit 15, ch3
32 (20 hex)	Unit 7, ch4	64 (40 hex)	Unit 15, ch4

### 6-5-5 Copy Function

Explicit message	Read/write	Function	Command					Response
			Service code	Class ID	Instance ID	Attribute ID	Data size	
COPY	Write	Uploads or downloads settings of the Temperature Controller connected to the DeviceNet Communications Unit. (Refer to page 141.)	10 hex	95 hex	01 hex	C6 hex	1 byte 00 hex: Upload 01 hex: Download	---
STATUS	Read	Reads the operating status of the copy function.	0E hex	71 hex	01 hex	66 hex	---	6 bytes (Bit 1 of the leftmost byte is the operating status. The rightmost byte is the results.)

Use the following procedure to execute the copy function.

- 1,2,3...**
1. Send the COPY command.
  2. After receiving the response, wait for processing to be completed (approx. 10 s per Temperature Controller).
  3. Read the status to confirm that the copy function is stopped. If bit 1 of the leftmost byte is ON, the copy function is still being executed. If it is OFF, the copy function is stopped.
  4. Read the status again and confirm the results (rightmost byte). The meaning of each bit of the rightmost byte is as follows:
    - Bit 0: ON for a normal end. (OFF for an error end or when the copy function has not been executed.)
    - Bit 1: OFF
    - Bit 2: ON if a communications error occurred when starting the upload or download.
    - Bit 3: ON if an EEPROM hardware error or checksum error occurred when starting the upload or download.
    - Bit 4: ON if a communications error occurred when executing the upload or download.
    - Bit 5: ON if there was no backup data to download.
    - Bit 6: ON if the backup data configuration does not match the actual configuration for an upload or download.
    - Bit 7: OFF



# SECTION 7

## Communications Performance

This section provides information on the time required for a complete communications cycle, for an output response to be made to an input, to start the system, and to send messages.

7-1	Remote I/O Communications Characteristics . . . . .	126
7-1-1	I/O Response Time . . . . .	126
7-1-2	CompoWay/F Communications Cycle Time and Refresh Time . . .	131
7-1-3	More than One Master in Network . . . . .	132
7-1-4	System Startup Time . . . . .	133
7-2	Message Communications Characteristics . . . . .	134
7-2-1	Message Communications Time . . . . .	134



## 7-1 Remote I/O Communications Characteristics

This section describes the characteristics of DeviceNet remote I/O communications when OMRON Master and Slave Units are being used. Use this section for reference when planning operations that require precise I/O timing.

The equations provided here are valid under the following conditions:

- The Master Unit is operating with the scan list enabled.
- All of the required slaves are participating in communications.
- No errors are being indicated at the Master Unit.
- Messages are not being produced in the Network (from another company's configurator, for example).

**Note** The values provided by these equations may not be accurate if another company's master or slave is being used in the Network.

### 7-1-1 I/O Response Time

The I/O response time is the time it takes from the reception of an input signal at an Input Slave to the output of the corresponding output signal at an Output Slave after being processed by the ladder program at the master.

#### CVM1- and CV-series PLCs (Asynchronous Mode)

##### Minimum I/O Response Time

The minimum I/O response time occurs when the DeviceNet Master Unit refreshing is executed just after the input signal is received by the master and instruction execution is completed within one peripheral servicing cycle.

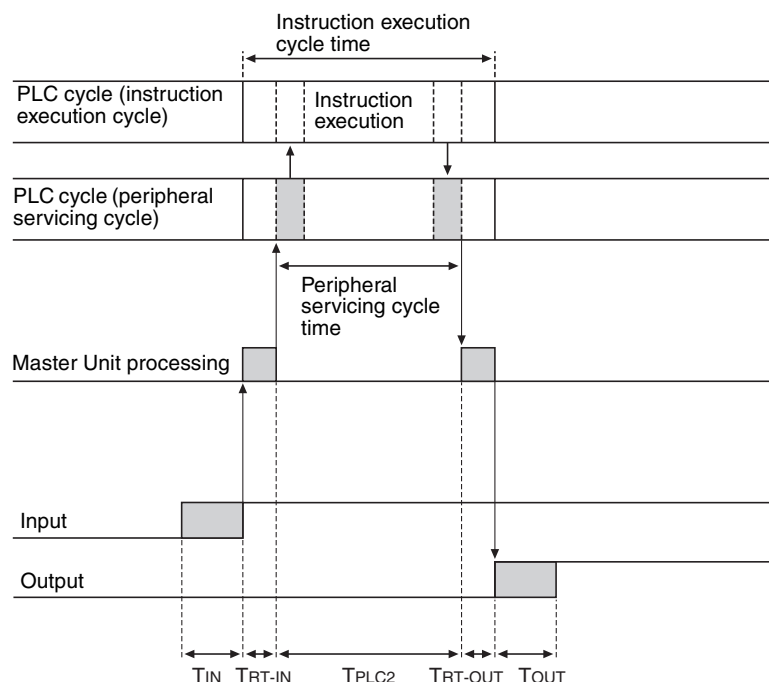

- $T_{IN}$ : The Input Slave's ON (OFF) delay (Minimum value: 0)
- $T_{OUT}$ : The Output Slave's ON (OFF) delay (Minimum value: 0)
- $T_{RT-IN}$ : The Input Slave's communications time/slave
- $T_{RT-OUT}$ : The Output Slave's communications time/slave
- $T_{PLC2}$ : The PLC's peripheral servicing cycle time

**Note** Refer to the information on each slave for details on Input and Output Slaves' ON and OFF delay times. Refer to 7-1-2 CompoWay/F Communications Cycle Time and Refresh Time and the Operation Manual for the PLC being used for details on the PLC's peripheral servicing cycle time.

The minimum I/O response time ( $T_{MIN}$ ) is the total of the following terms:

$$T_{MIN} = T_{IN} + T_{RT-IN} + T_{PLC2} + T_{RT-OUT} + T_{OUT}$$

**Maximum I/O Response Time**

The maximum I/O response time occurs with the I/O timing shown in the following diagram.

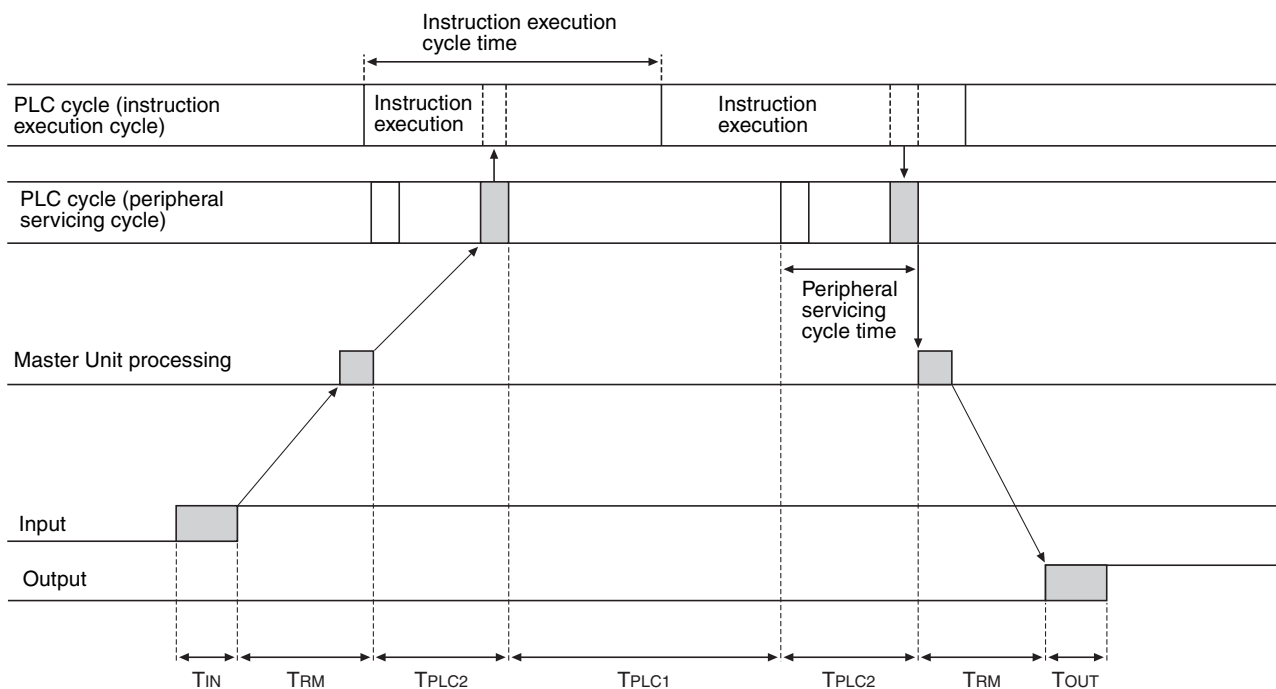

- $T_{IN}$ : The Input Slave's ON (OFF) delay
- $T_{OUT}$ : The Output Slave's ON (OFF) delay
- $T_{RM}$ : The whole Network's communications cycle time (Refer to page 131.)
- $T_{PLC1}$ : The PLC's instruction execution cycle time
- $T_{PLC2}$ : The PLC's peripheral servicing cycle time

**Note** Refer to the information on each slave for details on Input and Output Slaves' ON and OFF delay times. Refer to 7-1-2 CompoWay/F Communications Cycle Time and Refresh Time and the Operation Manual for the PLC being used for details on the PLC's peripheral servicing cycle time.

The maximum I/O response time ( $T_{MAX}$ ) is the total of the following terms:

$$T_{MAX} = T_{IN} + 2 \times T_{RM} + T_{PLC1} + 2 \times T_{PLC2} + T_{OUT}$$

**CVM1- and CV-series PLCs (Synchronous Mode)**

**Minimum I/O Response Time**

The minimum I/O response time occurs with the I/O timing shown in the following diagram.

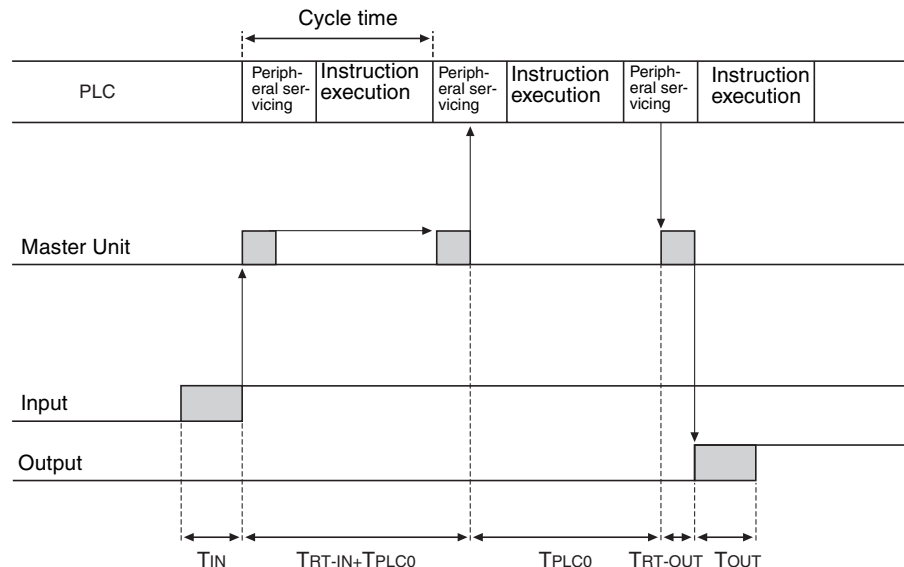

- $T_{IN}$ : The Input Slave's ON (OFF) delay (Minimum value: 0)
- $T_{OUT}$ : The Output Slave's ON (OFF) delay (Minimum value: 0)
- $T_{RT-IN}$ : The Input Slave's communications time/slave
- $T_{RT-OUT}$ : The Output Slave's communications time/slave
- $T_{PLC0}$ : The PLC's cycle time (instruction execution + peripheral servicing)

**Note** Refer to the information on each slave in *SECTION 5* to *SECTION 7* for details on Input and Output Slaves' ON and OFF delay times. Refer to *7-1-2 CompoWay/F Communications Cycle Time and Refresh Time* and the Operation Manual for the PLC being used for details on the PLC's cycle time.

The minimum I/O response time ( $T_{MIN}$ ) is the total of the following terms:

$$T_{MIN} = T_{IN} + T_{RT-IN} + 2 \times T_{PLC0} + T_{RT-OUT} + T_{OUT}$$

**Maximum I/O Response Time**

The maximum I/O response time occurs with the I/O timing shown in the following diagram.

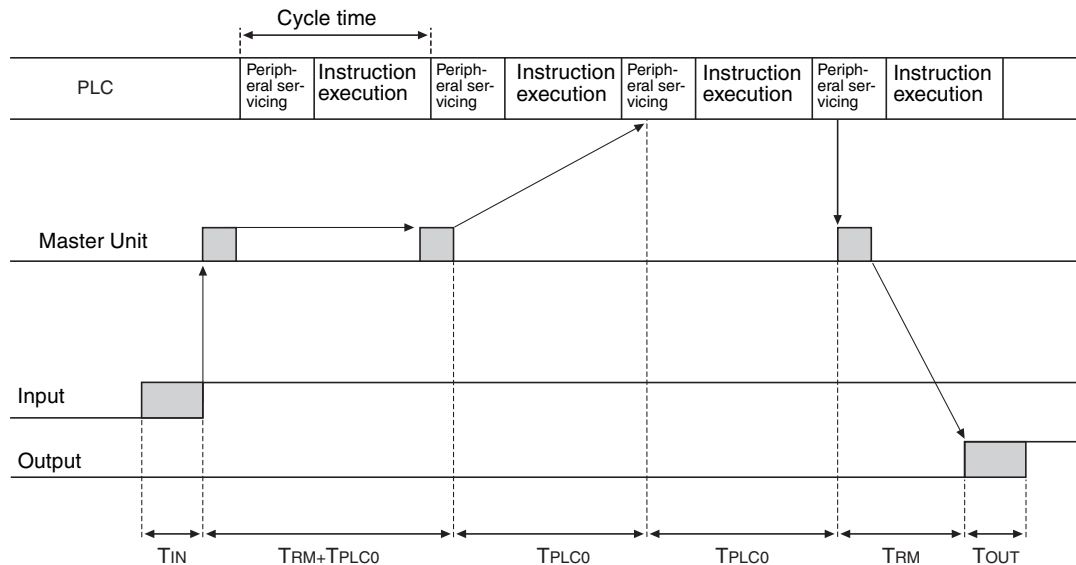

- T<sub>IN</sub>: The Input Slave's ON (OFF) delay
- T<sub>OUT</sub>: The Output Slave's ON (OFF) delay
- T<sub>RM</sub>: The whole Network's communications cycle time (Refer to page 131)
- T<sub>PLC0</sub>: The PLC's cycle time (instruction execution + peripheral servicing)

**Note** Refer to the information on each slave for details on Input and Output Slaves' ON and OFF delay times. Refer to 7-1-2 CompoWay/F Communications Cycle Time and Refresh Time and the Operation Manual for the PLC being used for details on the PLC's instruction execution and peripheral servicing cycle times.

The maximum I/O response time (T<sub>MAX</sub>) is the total of the following terms:

$$T_{MAX} = T_{IN} + 2 \times T_{RM} + 3 \times T_{PLC0} + T_{OUT}$$

**CS, CJ, C200HX/HG/HE (-Z), and C200HS PLCs**

**Minimum I/O Response Time**

The minimum I/O response time occurs when the DeviceNet Slave I/O refreshing is executed just after the input signal is received by the master and I/O is refreshed for the slave first in the next I/O refresh cycle.

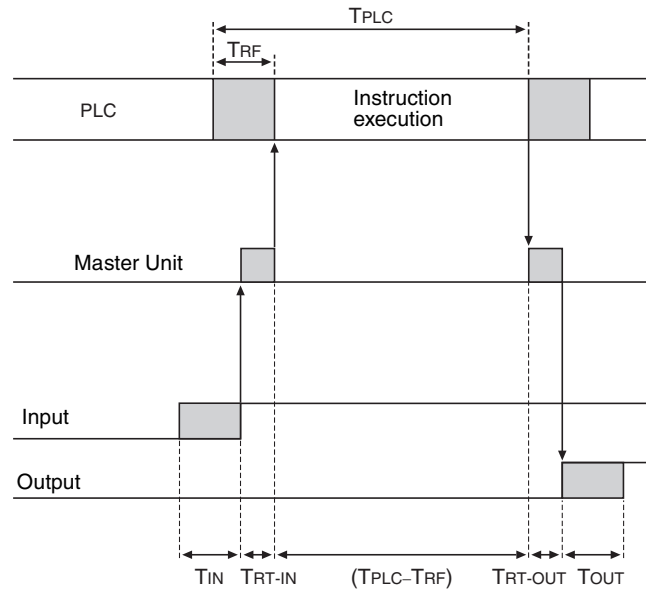

- $T_{IN}$ : The Input Slave's ON (OFF) delay (Minimum value: 0)
- $T_{OUT}$ : The Output Slave's ON (OFF) delay (Minimum value: 0)
- $T_{RT-IN}$ : The Input Slave's communications time/slave
- $T_{RT-OUT}$ : The Output Slave's communications time/slave
- $T_{PLC}$ : The PLC's cycle time
- $T_{RF}$ : The PLC's DeviceNet Unit refresh time

**Note** Refer to the information on each slave for details on Input and Output Slaves' ON and OFF delay times. Refer to 7-1-2 CompoWay/F Communications Cycle Time and Refresh Time and the Operation Manual for the PLC being used for details on the PLC's cycle time.

The minimum I/O response time ( $T_{MIN}$ ) is the total of the following terms:

$$T_{MIN} = T_{IN} + T_{RT-IN} + (T_{PLC} - T_{RF}) + T_{RT-OUT} + T_{OUT}$$

**Maximum I/O Response Time**

The maximum I/O response time occurs with the I/O timing shown in the following diagram.

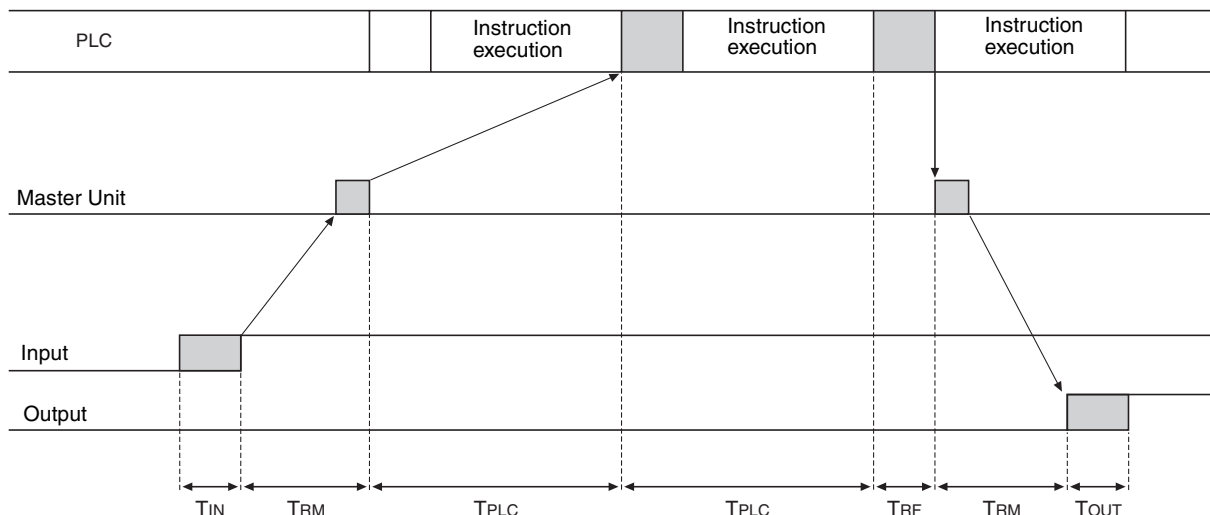

- $T_{IN}$ : The Input Slave's ON (OFF) delay
- $T_{OUT}$ : The Output Slave's ON (OFF) delay
- $T_{RM}$ : The whole Network's communications cycle time
- $T_{PL}$ : The PLC's cycle time
- $T_{RF}$ : The PLC's DeviceNet Unit refresh time

**Note** Refer to the information on each slave for details on Input and Output Slaves' ON and OFF delay times. Refer to 7-1-2 CompoWay/F Communications Cycle Time and Refresh Time and the Operation Manual for the PLC being used for details on the PLC's cycle time.

The maximum I/O response time ( $T_{MAX}$ ) is the total of the following terms:

$$T_{MAX} = T_{IN} + 2 \times T_{RM} + 2 \times T_{PL} + T_{RF} + T_{OUT}$$

**7-1-2 CompoWay/F Communications Cycle Time and Refresh Time**

This section explains the communications cycle time and refresh processing time required to calculate various processing times for DeviceNet.

**Communications Cycle Time**

The communications cycle time is the time from the completion of a slave's I/O communications processing until I/O communications with the same slave are processed again. The communications cycle time of the DeviceNet Communications Unit is the maximum CompoWay/F communications cycle time  $T_{IN} + T_{OUT}$ .

Reference values for CompoWay/F communications cycle time are given below.

**Communications Cycle Time Reference Values**

Total communications cycle time = IN communications cycle time + OUT communications cycle time.

No. of Temperature Controllers	TIN	TOUT
1	100 ms	100 ms
8	400 ms	700 ms
16	900 ms	1,200 ms

**Note** The measurement conditions are as follows:  
 Baud rate: 500 kbps  
 I/O allocation: Same as simple I/O allocation  
 Temperature Controller: TC2

The values above are reference values, not maximum values. The communications cycle time depends on the number of Temperature Controllers connected and the type or number of the parameters allocated to I/O.

**Refresh Time**

The refresh time is the time required for I/O data to be exchanged between the PLC's CPU Unit and the DeviceNet Master Unit. The PLC's cycle time is increased when a Master Unit is mounted, as shown below.

**Note** Refer to the PLC's Operation Manual for more details on the refresh time and the PLC's cycle time.

**Master Unit for CV-series PLCs**

The PLC's cycle time (CPU Bus Unit servicing) is increased by the amount shown in the following table when a Master Unit is mounted to the PLC.

Process	Processing time
CPU Bus Unit servicing	DeviceNet Unit refreshing: 1.1 ms

**Master Unit for CS/CJ-series, C200HX/HG/HE (-Z), and C200HS PLCs**

The PLC's cycle time (I/O refreshing) is increased by the amount shown in the following table when a Master Unit is mounted to the PLC.

Process	Processing time
I/O refreshing	DeviceNet Unit I/O refreshing: Using Master Unit for CS/CJ-series, and C200HX/HG/HE (-Z) PLCs $1.72 + 0.022 \times \text{number of words (ms)}$ (See note.) Using Master Unit for C200HS PLCs $2.27 + 0.077 \times \text{number of words (ms)}$ (See note.)

**Note** The number of words refreshed is the total number of words in the I/O Area that are allocated to the slaves, including any unused words between those words actually used by the slaves.

For example, if there are only two Input Slaves with node addresses 1 and 5, the 5 input words for nodes 1 through 5 would be refreshed even though the input words for nodes 2, 3, and 4 are unused.

If message communications are being performed, just add the number of words used in message communications to the above number of words for whenever messages are being processed.

**7-1-3 More than One Master in Network**

The following equation shows the communications cycle time ( $T_{RM}$ ) when there is more than one master in the Network.

An example for two Master Units is shown here.

First, the Network is divided into two groups: Master A and the slaves in remote I/O communications with it, and Master B and the slaves in remote I/O communications with it.

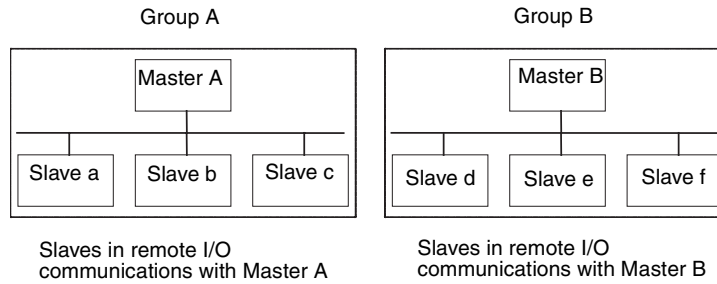

**Note** Although in the above diagram the slaves are separated into two separate groups for each master for convenience, the actual physical positions of the slaves in the Network are irrelevant.

Next, refer to 7-1-2 *CompoWay/F Communications Cycle Time and Refresh Time* and calculate the communications cycle time for each group as if they were separate Networks.

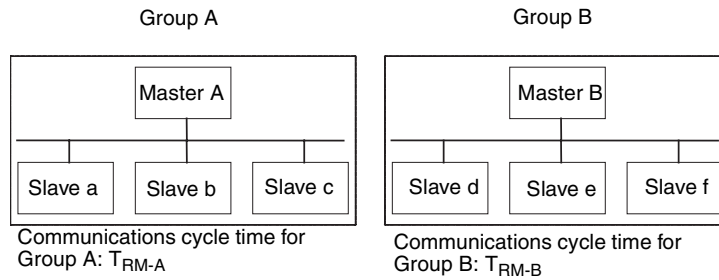

In Networks with two masters, the communications cycle time for the entire Network will be the sum of the communications cycle times for both groups.

$$T_{RM} = T_{RM-A} + T_{RM-B}$$

Although this example shows only two masters in the Network, the total communications cycle time for any Network with more than one master can be calculated by dividing it into groups performing remote I/O communications and adding the communications cycle times of all the groups.

### 7-1-4 System Startup Time

This section describes the system startup time for a Network, assuming that the scan list is enabled and that remote I/O communications are set to start automatically at startup. The system startup time is the delay from the time that the Master Unit is turned ON or restarted until the time remote I/O communications begin.

The system startup time when the Master Unit is set to start up immediately after power supplies of all the slaves' are turned ON is different from when the Master Unit is restarted while communications are in progress. The startup times are shown in the following table.

Condition	Slave's indicator status	System startup time
The master is started immediately after slave startup.	NS indicator is OFF or flashing green.	11 s



Condition	Slave's indicator status	System startup time
The master only is restarted.	NS indicator is flashing red or green while the master is OFF.	8 s
The slaves only are restarted.	-	11 s

**Program Example**

As shown in the preceding table, it takes time for DeviceNet communications to start up. This programming uses flags in the Master Status Area to prevent the slaves' I/O processing from being performed until the Master Unit and remote I/O communications have started up.

**Note** Refer to the operation manual of the Master Unit being used for details on the Master Unit Status Area.

The following program example is for a CS/CJ-series PLC and a Master Unit with a unit number of 00.

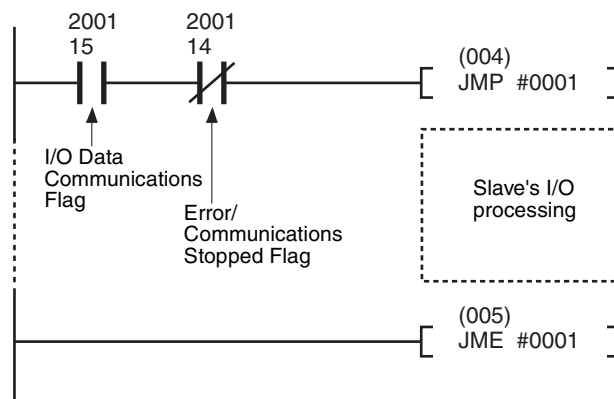

## 7-2 Message Communications Characteristics

### 7-2-1 Message Communications Time

The message communications time is the time required from the time a Master Unit starts to send a message over the Network to another node until the Master Unit completes sending the message (SEND/RECV instructions to send/receive data and CMND/IOWR instructions to execute FINS commands).

**Note** If the CPU Unit attempts to send another message or receives a message from another node before the message communications time has finished, the response message being sent or the message being received from another node may be destroyed. Always perform message communications at intervals longer than the message communications time and use message instructions (SEND, RECV, CMND, and IOWR). Never send messages to any one node at intervals less than the message communications time.

If send or receive messages are destroyed, the error record will be placed in the error history of the Master Unit. If an error occurs, read the error history using the FINS command or monitor the error history from the Configurator.

The following equation can be used to calculate the approximate message communications time.

$$\text{Message communications time} = \text{Communications cycle time} \times ((\text{No. of message bytes} + 15) \div 6 + 1)$$

The number of message bytes is the number of data bytes following the FINS command code. The communications cycle time depends on whether remote I/O communications are being used.

### **Message Communications Only (Remote I/O Communications Not Used)**

Message communications time = 2 (see note) +  $0.11 \times T_B$  + 0.6 (ms)

$T_B$ : Baud rate (500 kbps:  $T_B = 2$ ; 250 kbps:  $T_B = 4$ ; 125 kbps:  $T_B = 8$ )

**Note** The communications cycle when remote I/O communications are not being used is 2 ms.

### **Message Communications with Remote I/O Communications**

Communications cycle time = (Communications cycle time for remote I/O communications only) +  $0.11 \times T_B$  + 0.6 (ms)

$T_B$ : Baud rate (500 kbps:  $T_B = 2$ ; 250 kbps:  $T_B = 4$ ; 125 kbps:  $T_B = 8$ )

**Note** The above equations can be used to find the approximate message communications time, but not the maximum time. The message communications time will depend on the frequency of the message communications, the load on the remote node, the communications cycle time, and other factors. For any one Master Unit, the message communications time may be greatly increased due to heavy loads.



# SECTION 8

## Troubleshooting and Maintenance

This section describes error processing, periodic maintenance operations, and troubleshooting procedures needed to keep the DeviceNet Network operating properly. Details on resetting replaced Units are also provided. Read through the error processing procedures in both this manual and the operation manual for the DeviceNet master being used before operation so that operating errors can be identified and corrected more quickly.

8-1	Indicators and Error Processing .....	138
8-2	Maintenance .....	139
8-2-1	Cleaning .....	139
8-2-2	Inspection .....	140
8-2-3	Replacing Units .....	140

## 8-1 Indicators and Error Processing

The following table lists the indicator status when errors occur, the probable causes and processing.

Indicator status	Probable cause	Remedy
MS: OFF NS: OFF	The power is not being supplied to the Unit.	Supply communications power from the DeviceNet Communications connector.
	The power voltage is not within the permitted range.	Use a power supply voltage within the permitted range.
	The Unit is faulty.	Replace the Unit.
MS: Flashing green NS: No change	The Temperature Controller connection configuration is not registered.	If I/O allocations are to be set using the Configurator, register the Temperature Controller connection configuration. (Refer to pages 45 to 68).
MS: Flashing red NS: No change	A sum error has occurred in the parameters registered in EEPROM.	Use the Configurator's device monitor to check the parameters with the sum error or logic error, and reset the parameters.
	A EEPROM hardware error has occurred.	Replace the Unit.
MS: ON red NS: OFF	The Unit is faulty	Replace the Unit.
MS: ON green NS: Flashing green	Waiting to connect to DeviceNet communications.	Check the following items and restart the Unit. <ul style="list-style-type: none"> <li>• Are lengths of cables (trunk and branch lines) correct?</li> <li>• Are cables short-circuited, broken, or loose?</li> <li>• Are cables wired correctly?</li> <li>• Is terminating resistance connected to both ends of the trunk line only?</li> <li>• Is noise interference excessive?</li> <li>• Is the power to the master ON?</li> </ul>
	The Unit is faulty.	Replace the Unit.
MS: ON green NS: ON red	The DeviceNet is in Bus Off status.	Check the following items and restart the Unit. <ul style="list-style-type: none"> <li>• Are lengths of cables (trunk and branch lines) correct?</li> <li>• Are cables short-circuited, broken, or loose?</li> <li>• Is terminating resistance connected to both ends of the trunk line only?</li> <li>• Is noise interference excessive?</li> </ul>
	Node addresses duplicated.	Reset node addresses correctly.
	The Unit is faulty.	Replace the Unit.
MS: ON green NS: Flashing red	A communications timeout has occurred.	Check the following items and restart the Unit. <ul style="list-style-type: none"> <li>• Are lengths of cables (trunk and branch lines) correct?</li> <li>• Are cables short-circuited, broken, or loose?</li> <li>• Is terminating resistance connected to both ends of the trunk line only?</li> <li>• Is noise interference excessive?</li> </ul>
	The Unit is faulty.	Replace the Unit.

Indicator status	Probable cause	Remedy
TS: OFF	Communications with the Temperature Controllers have stopped.	Set the Temperature Controller connection configuration.
	The Unit is faulty.	Replace the Unit.
TS: Flashing red	One or more of the connected Temperature Controllers is faulty.	Replace the faulty Temperature Controllers. Check the communications status and communications error status to detect which Temperature Controller is faulty.
	One or more of the connected Temperature Controllers has been disconnected.	Connect the Temperature Controllers correctly. Check the communications status and communications error status to detect which Temperature Controller is disconnected.
	The communications unit number of one or more Temperature Controllers registered in the connection configuration is incorrect.	Change the communications unit number of the Temperature Controller or register the connection configuration correctly.
	Pin 1 of the DIP switch is set incorrectly.	Set correctly as follows: Pin 1 ON: Simple I/O allocation Pin 1 OFF: I/O allocation using the Configurator
	Power is not being supplied to the End Unit.	Supply 24-VDC power to the End Unit.
	The Unit is faulty.	Replace the Unit.
TS: Flashing red (Flashes for 10 s only.)	A communications error occurred with the Temperature Controller when copy was executed.	<ul style="list-style-type: none"> <li>• Check whether the Units are connected together properly. Refer to the <i>EJ1 User's Manual</i> (Cat. No. H142).</li> <li>• If distributed placement is used, check the connection of port B on the End Unit.</li> </ul>
	The settings downloaded for a Temperature Controller configuration that is different from that used when uploading.	Use the same Temperature Controller configuration for downloading that was used when uploading.

## 8-2 Maintenance

This section describes the routine cleaning and inspection recommended as regular maintenance. Handling methods when replacing Units are also explained here.

### 8-2-1 Cleaning

Clean the DeviceNet Units regularly as described below in order to keep the Network in its optimal operating condition.

- Wipe the Unit with a dry, soft cloth for regular cleaning.
- When dust or dirt cannot be removed with a dry cloth, dampen the cloth with a neutral cleanser (2%), wring out the cloth, and wipe the Unit.
- Smudges may remain on the Unit from gum, vinyl, or tape that was left on for a long time. Remove these smudges when cleaning.

**Note** Never use volatile solvents, such as paint thinner or benzene, or chemical wipes to clean the Unit. These substances may damage the surface of the Unit.

## 8-2-2 Inspection

Inspect the system periodically to keep it in its optimal operating condition.

In general, inspect the system once every 6 to 12 months, but inspect more frequently if the system is used in high-temperature, humid, or dusty conditions.

### Inspection Equipment

Prepare the following equipment before inspecting the system.

#### **Equipment Required for Regular Inspection**

A flat-blade and a Phillips screwdriver, a screwdriver for connecting communications connectors, a tester (or a digital voltmeter), industrial alcohol, and a clean cloth are required for routine inspection.

#### **Other Equipment that May Be Required**

A synchroscope, oscilloscope, thermometer, or hygrometer may be required.

### Inspection Procedure

Check the items in the following table and correct any condition that is below standard by adjusting the Unit or improving the environmental conditions.

Inspection item	Details	Standard	Equipment
Environmental conditions	Are ambient and cabinet temperatures correct?	-10 to +55°C	Thermometer
	Are ambient and cabinet humidity correct?	25% to 85%	Hygrometer
	Has dust or dirt accumulated?	No dust or dirt	Visual inspection
Installation conditions	Are the Units installed securely?	No looseness	Phillips screwdriver
	Are the connectors of the communications cables fully inserted?	No looseness	Phillips screwdriver
	Are the external wiring screws tight?	No looseness	Phillips screwdriver
	Are the connecting cables undamaged?	No external damage	Visual inspection

## 8-2-3 Replacing Units

The Network consists of the DeviceNet Master Unit and Slave Units. The entire network is affected when a Unit is faulty, so a faulty Unit must be repaired or replaced quickly. We recommend having spare Units available to restore Network operation as quickly as possible.

### Precautions

Observe the following precautions when replacing a faulty Unit.

- After replacement make sure that there are no errors with the new Unit.
- When a Unit is being returned for repair, attach a sheet of paper detailing the problem and return the Unit to your OMRON dealer
- If there is a faulty contact, try wiping the contact with a clean, lint-free cloth dampened with alcohol.

**Note** Before replacing a Unit, always stop Network communications and turn OFF the power to all the nodes in the Network.

### Settings after Replacing a Unit

After replacing a Unit, set the new Unit's switches to the same settings that were on the old Unit. Connect the same model of DeviceNet Communications Unit to the Temperature Controllers as the previous Unit.

- Note**
1. By backing up the settings of the DeviceNet Communications Unit and the Temperature Controllers, the settings can be reset in a batch. For details

on the device parameters upload and download functions, refer to the *DeviceNet Configurator Ver. 2□ Operation Manual* (Cat. No. W382).

- When replacing a Temperature Controller, the DeviceNet Communications Unit copy mode can be used to easily reset the Temperature Controller onsite without requiring the Configurator. For details, refer to *Reading/Writing Temperature Controller Settings Using Copy Mode* below.

### Reading/Writing Temperature Controller Settings Using Copy Mode

The DeviceNet Communications Unit has a copy function that can read or write the setting parameters of all the Temperature Controllers connected to the Unit in a batch (the read setting parameters are recorded in the DeviceNet Communications Unit).

When a Temperature Controller has been replaced, the copy function allows the Temperature Controller to be easily reset onsite without using a Configurator.

- Note**
- The parameters of the G3ZA are not backed up. If backup is required, use the CX-Thermo to back up the parameters.
  - Once a system using a DeviceNet Communications Unit is operating properly, it is recommended to read the Temperature Controller parameters using the copy function at the same time as the device parameters are saved using the Configurator.
  - The copy function can be used with explicit messages also. For details, refer to page 123.

### Read Setting Parameters (Upload)

Use this function to upload the setting parameters from the Temperature Controllers to the DeviceNet Communications Unit.

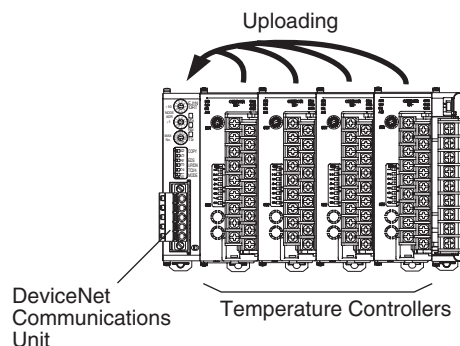

#### ■ Execution Condition

There can be no communications error (TS indicator is not flashing red).

#### ■ Procedure

- 1,2,3...**
- Turn OFF pin 3 (UP/DN) of the DIP switch of the DeviceNet Communications Unit.
  - Toggle pin 6 of the of the DIP switch of the DeviceNet Communications Unit from OFF to ON (leave ON for 1 to 5 seconds) and then turn OFF again (while pin 6 is ON, the TS indicator will be lit green). The data will start uploading and the TS indicator will flash green. (Approx. 10 s is required for each Temperature Controller.)



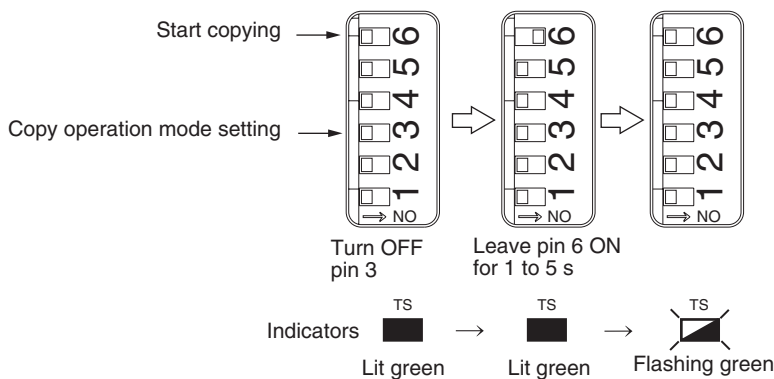

**Execution Results**

- If the uploading completes normally, the TS indicator status will return to be lit green.
- If the upload operation ends abnormally, after error completion, the TS indicator will flash red for 10 seconds.

- Note**
1. For the upload operation, when pin 6 (copy) is turned ON, and then OFF again, the TS indicator will flash green. Check that the TS indicator is flashing green during the upload operation.
  2. To cancel an upload operation, leave pin 6 (copy) ON for at least 5 seconds, and then turn OFF again.

**Write Setting Parameters (Download)**

Use this function to download the setting parameters from the DeviceNet Communications Unit to the Temperature Controllers.

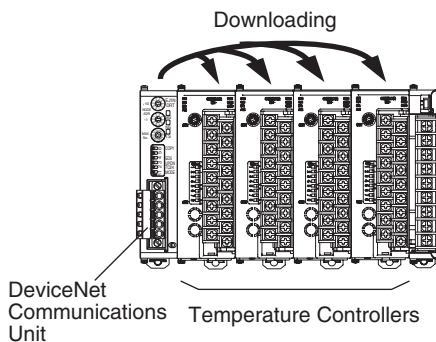

- Note**
- While downloading, refresh processing of I/O data will stop, and the data immediately before being copied will be held in the IN Area of the DeviceNet Communications Unit. Explicit message communications will stop, so a time-out error may occur.
- An error will occur for explicit message communications except for the STATUS explicit message.

**Execution Condition**

- Data for the same connection configuration (model, unit number) has been uploaded to the DeviceNet Communications Unit.
- There can be no communications error (TS indicator is not flashing red).

**Procedure**

- 1,2,3...
1. Turn ON pin 3 (UP/DN) of the DIP switch of the DeviceNet Communications Unit.

- Toggle pin 6 of the of the DIP switch of the DeviceNet Communications Unit from OFF to ON (leave ON for 1 to 5 seconds) and then turn OFF again (while pin 6 is ON, the TS indicator will be flashing green). The data will start downloading and the TS indicator will flash green. (Approx. 10 s is required for each Temperature Controller.)

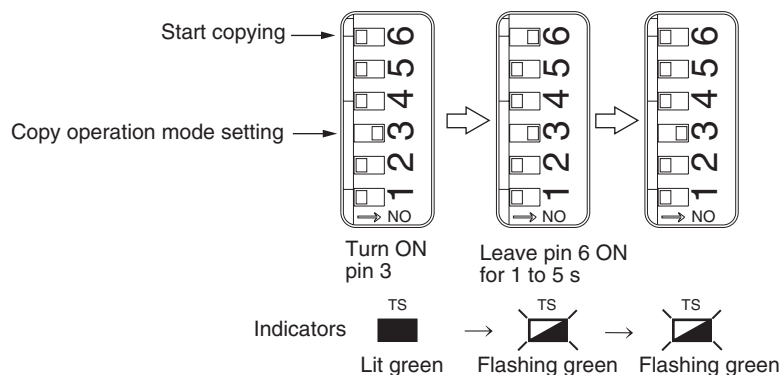

### ■ Execution Results

- When the download completes normally, the TS indicator status returns to be lit green.
- When the download operation ends abnormally, after error completion, the TS indicator will flash red for 10 s.

- Note**
- For the download operation, when pin 6 (copy) is turned ON, the TS indicator will flash green (indicating download standby). Check that the TS indicator is flashing green before turning OFF pin 6 (copy) again.
  - To cancel a download operation, leave pin 6 (copy) ON for at least 5 seconds, and then turn OFF again.
  - Check that data is downloading by confirming that the TS indicator flashes green after pin 6 (copy) is turned OFF.



# Appendix A

## Connecting to a Master from Another Company

This appendix explains how to operate the DeviceNet Communications Unit when it is connected to a master manufactured by another company.

### Using a Configurator Manufactured by Another Company

This section explains how to use an EDS file with a Configurator manufactured by another company.

#### Setting the DeviceNet Communications Unit

Set DIP switch pin 4 on the DeviceNet Communications Unit to ON (to use a Configurator manufactured by another company).

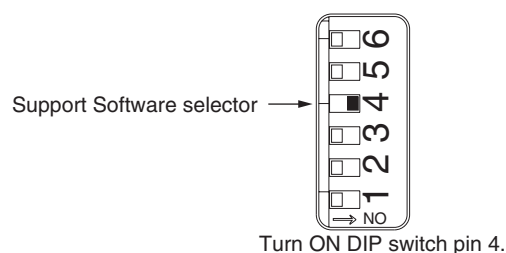

#### Installing an EDS File

Download the EDS file for the DeviceNet Communications Unit from the product guide on the following website and install it in the configurator manufactured by another company. For the installation procedure, refer to the manual of the configurator you are using.

<http://securesite.jp/ODVA/english/>

**Note** This EDS file cannot be used with the OMRON Configurator. For the OMRON Configurator, always install the expansion module.

#### Settings

Settings are divided into the following groups.

Group name	Description
Unit	Sets the model of Temperature Controller connected to the DeviceNet Communications Unit.
IN1 Area	Sets the allocation items for the IN1 Area. (See note 1.)
IN2 Area	Sets the allocation items for the IN2 Area. (See note 1.)
OUT Area	Sets the allocation items for the OUT Area. (See note 1.)
#00 ch1	Makes settings for Unit 0, channel 1
#00 ch2	Makes settings for Unit 0, channel 2.
---	---
#15 ch4	Makes settings for Unit 15, channel 4.
General setting	Makes settings for the DeviceNet Communications Unit.

**Note** 1. Allocation items are set using allocation numbers. For information on allocation numbers, refer to *Appendix B Allocation Numbers for Configurators Manufactured by Other Companies* on page 151. In the first word of OUT Area 1 (OUT Data 1) must always be allocated to 31998 (i.e., the OUT Enable Bit).

2. The default assignments is the 111 (ch3 Control Output (Heating)) for control output 3 and 143 (ch4 Control Output (Heating)) for control output 4. Change these assignments as required when using a TC2 Unit.
3. When settings are read, data read for non-existing Temperature Controllers are not dependable. Do not change the Temperature Controller configuration when reading or writing settings.

## Data Size and Connection Types

The DeviceNet Communications Unit supports both simple I/O allocation and I/O allocations set from the Configurator when the Unit is connected to another company's master, but the data size of the IN and OUT Areas of the DeviceNet Communications Unit must be set. The size of the DeviceNet Communications Unit's data areas will depend on the setting method used. For details, refer to *SECTION 4 Remote I/O Communications*.

If the connection type can be set when another company's configurator is being used, select a connection supported by the DeviceNet Communications Unit.

The following table shows the connection types and data sizes for OMRON DeviceNet Communications Units.

Model		Supported connections				Data size (bytes)	
		Poll	Bit strobe	Change of state (COS)	Cyclic	IN	OUT
DeviceNet Communications Unit	EJ1N-HFUB-DRT	Yes	No	Yes	Yes	1 to 200 (See note.)	1 to 200 (See note.)

**Note** The size of the IN/OUT Areas depends on the setting.

DeviceNet I/O communications support the following types of connections.

Connection type	Details	Remarks
Poll	Used to exchange data between the master and individual slaves by sending and receiving commands and responses. (Output data is allocated for commands and input data is allocated for responses).	---
Change of state (COS)	Normally, input and output data are sent by master and slaves at regular cycles, but with a COS connection, data is sent to the master or slave when the master or slave data changes.	By setting a long cycle interval, the Network will not be loaded with communications for minor data changes, thereby improving the overall efficiency of the Network.
Cyclic	Masters and slaves send output or input data at regular cycles.	

## More Detailed DeviceNet Specifications

The following device profiles contain more detailed DeviceNet specifications for the DeviceNet Communications Unit if more information needs to be registered in the scan list.

### Device Profiles

General data	Compatible DeviceNet Specifications	Volume I, Release 1.3 Volume II, Release 1.3	
	Vendor name	OMRON Corporation	Vendor ID = 47
	Device profile name	Slaves: Communications Adapter	Profile number = 12
	Manufacturer catalog number	H155	
	Manufacturer revision	1.01	

Physical conformance data	Network current consumption	80 mA max.
	Connector type	Open plug
	Physical layer insulation	No
	Supported indicators	Module, Network
	MAC ID setting	Rotary switch
	Default MAC ID	0
	Baud rate setting	None (automatic recognition)
	Supported baud rates	125 kbps, 250 kbps, and 500 kbps
Communications data	Predefined Master/Slave connection set	Group 2 only server
	Dynamic connection support (UCMM)	No
	Explicit message fragmentation support	Yes

## Object Mounting

### Identity Object (01 hex)

Object class	Attribute	Not supported
	Service	Not supported

Object instance	Attribute	ID	Contents	Get (read)	Set (write)	Value
		1	Vendor	Yes	No	47
2	Device type	Yes	No	12		
3	Product code	Yes	No	315		
4	Revision	Yes	No	1.1		
5	Status (bits supported)	Yes	No	Bit 00 only		
6	Serial number	Yes	No	Unique for each Unit		
7	Product name	Yes	No	EJ1N-HFUB-DRT		
8	State	No	No			
Service	DeviceNet service			Parameter option		
	05	Reset	No			
	0E	Get_Attribute_Single	No			

### Message Router Object (02 hex)

Object class	Attribute	Not supported
	Service	Not supported
Object instance	Attribute	Not supported
	Service	Not supported
Vendor specification addition		None

### DeviceNet Object (03 hex)

Object class	Attribute	Not supported
	Service	Not supported

Object instance	Attribute	ID	Contents	Get (read)	Set (write)	Value
		1	MAC ID	Yes	No	
		2	Baud rate	Yes	No	
		3	BOI	Yes	No	00 (hexadecimal)
		4	Bus Off counter	Yes	No	
		5	Allocation information	Yes	No	
		6	MAC ID switch changed	Yes	No	
		7	Baud rate switch changed	No	No	
		8	MAC ID switch value	Yes	No	
		9	Baud rate switch value	No	No	
	<b>Service</b>	<b>DeviceNet service</b>		<b>Parameter option</b>		
		0E	Get_Attribute_Single	None		
		4B	Allocate_Master/ Slave_Connection_Set	None		
		4C	Release_Master/ Slave_Connection_Set	None		

### Assembly Object (04 hex)

<b>Object class</b>	<b>Attribute</b>	Not supported
	<b>Service</b>	Not supported

Object instance	Attribute	ID	Contents	Get (read)	Set (write)	Value
100: IN Area 1		1	Number of members in list	No	No	
101: IN Area 2		2	Member list	No	No	
110: OUT Area 1		3	Data	Yes	Yes	
	<b>Service</b>	<b>DeviceNet service</b>		<b>Parameter option</b>		
		0E	Get_Attribute_Single	None		
		10	Set_Attribute_Single	None		

### Connection Object (05 hex)

<b>Object class</b>	<b>Attribute</b>	Not supported
	<b>Service</b>	Not supported
	<b>Maximum number of active connections</b>	1

<b>Object instance 1</b>	<b>Section</b>	<b>Information</b>		<b>Maximum number of instances</b>		
	<b>Instance type</b>	Explicit Message		1		
	<b>Production trigger</b>	Cyclic				
	<b>Transport type</b>	Server				
	<b>Transport class</b>	3				
	<b>Attribute</b>	<b>ID</b>	<b>Contents</b>	<b>Get (read)</b>	<b>Set (write)</b>	<b>Value</b>
		1	State	Yes	No	
		2	Instance type	Yes	No	00 (hexadecimal)
		3	Transport class trigger	Yes	No	83 (hexadecimal)
		4	Produced connection ID	Yes	No	
		5	Consumed connection ID	Yes	No	
		6	Initial comm. characteristics	Yes	No	21 (hexadecimal)
		7	Produced connection size	Yes	No	0176 (hexadecimal)
		8	Consumed connection size	Yes	No	
	9	Expected packet rate	Yes	Yes		
	<b>Service</b>	<b>DeviceNet service</b>		<b>Parameter option</b>		
	05	Reset	None			
	0E	Get_Attribute_Single	None			
	10	Set_Attribute_Single	None			
<b>Object instance 2</b>	<b>Section</b>	<b>Information</b>		<b>Maximum number of instances</b>		
	<b>Instance type</b>	Polled I/O		1		
	<b>Production trigger</b>	Cyclic				
	<b>Transport type</b>	Server				
	<b>Transport class</b>	2				
	<b>Attribute</b>	<b>ID</b>	<b>Contents</b>	<b>Get (read)</b>	<b>Set (write)</b>	<b>Value</b>
		1	State	Yes	No	
		2	Instance type	Yes	No	01 (hexadecimal)
		3	Transport class trigger	Yes	No	82 (hexadecimal)
		4	Produced connection ID	Yes	No	
		5	Consumed connection ID	Yes	No	
		6	Initial comm. characteristics	Yes	No	01 (hexadecimal)
		7	Produced connection size	Yes	No	
		8	Consumed connection size	Yes	No	
	9	Expected packet rate	Yes	Yes		
	<b>Service</b>	<b>DeviceNet service</b>		<b>Parameter option</b>		
	05	Reset	None			
	0E	Get_Attribute_Single	None			
	10	Set_Attribute_Single	None			

1. Produced Connection Path  
 IN Area 1: 20\_04\_24\_64\_30\_03  
 IN Area 2: 20\_04\_24\_65\_30\_03
2. Consumed Connection Path  
 OUT Area: 20\_04\_24\_6E\_30\_03



Object instance 4	Section	Information		Maximum number of instances			
		<b>Instance type</b>	COS Cyclic		1		
	<b>Production trigger</b>	Cyclic					
	<b>Transport type</b>	Server					
	<b>Transport class</b>	2					
	<b>Attribute</b>	<b>ID</b>	<b>Contents</b>	<b>Get (read)</b>	<b>Set (write)</b>	<b>Value</b>	
		1	State	Yes	No		
		2	Instance type	Yes	No	01 (hexadecimal)	
		3	Transport class trigger	Yes	No	12 (hexadecimal)	
		4	Produced connection ID	Yes	No		
		5	Consumed connection ID	Yes	No		
		6	Initial comm. characteristics	Yes	No	01 (hexadecimal)	
		7	Produced connection size	Yes	No		
		8	Consumed connection size	Yes	No		
	9	Expected packet rate	Yes	Yes			
	<b>Service</b>	<b>DeviceNet service</b>		<b>Parameter option</b>			
		05	Reset	None			
		0E	Get_Attribute_Single	None			
		10	Set_Attribute_Single	None			

**Note** Produced Connection Path  
 IN Area 1: 20\_04\_24\_64\_30\_03  
 IN Area 2: 20\_04\_24\_65\_30\_03

# Appendix B

## Allocation Numbers for Configurators Manufactured by Other Companies

### Operation Command/Status Parameters

#### TC2

Allocated in IN Area	Allocated in OUT Area	Parameter name	Allocation number for configurator manufactured by other company
Yes	No	Output Completed Flags	31486
Yes	No	Read Parameter Monitor (See note 2.)	31742
No	Yes	OUT Enable Bit (See note 1.)	31998
No	Yes	OUT Enable Bit 2	32254
No	Yes	Read Parameter (See note 2.)	32510
No	Yes	Write Parameter (See note 2.)	32766
Yes	No	Communications Status	33022
Yes	No	Communications Error Status	33278
Yes	No	Unit Status	33534
Yes	No	Alarm 1 (TC2: #00-#07)	34046
Yes	No	Alarm 1 (TC2: #08-#15)	34302
Yes	No	Alarm 2 (TC2: #00-#07)	35838
Yes	No	Alarm 2 (TC2: #08-#15)	36094
Yes	No	Alarm 3 (TC2: #00-#07)	37630
Yes	No	Alarm 3 (TC2: #08-#15)	37886
Yes	No	HB Alarm (TC2: #00-#07)	39166
Yes	No	HB Alarm (TC2: #08-#15)	39422
Yes	No	HS Alarm (TC2: #00-#07)	39678
Yes	No	HS Alarm (TC2: #08-#15)	39934
Yes	No	OC Alarm (TC2: #00-#07)	40190
Yes	No	OC Alarm (TC2: #08-#15)	40446
Yes	No	Input Error (TC2: #00-#07)	40958
Yes	No	Input Error (TC2: #08-#15)	41214
Yes	Yes	Run/Stop (TC2: #00-#07)	42750
Yes	Yes	Run/Stop (TC2: #08-#15)	43006
Yes	Yes	AT Execute/Cancel (TC2: #00-#07)	44542
Yes	Yes	AT Execute/Cancel (TC2: #08-#15)	44798
Yes	Yes	Auto/Manual (TC2: #00-#07)	46334
Yes	Yes	Auto/Manual (TC2: #08-#15)	46590
No	Yes	Software Reset	47870

- Note**
1. Always allocate the first word of the OUT Area to the OUT Enable Bit.
  2. These parameters are for expansion remote I/O.

## TC4

Allocated in IN Area	Allocated in OUT Area	Parameter name	Allocation number for configurator manufactured by other company
Yes	No	Output Completed Flags	31486
Yes	No	Read Parameter Monitor (See note 2.)	31742
No	Yes	OUT Enable Bit (See note 1.)	31998
No	Yes	OUT Enable Bit 2	32254
No	Yes	Read Parameter (See note 2.)	32510
No	Yes	Write Parameter (See note 2.)	32766
Yes	No	Communications Status	33022
Yes	No	Communications Error Status	33278
Yes	No	Unit Status	33534
Yes	No	Alarm 1 (TC4: #00-#03)	34558
Yes	No	Alarm 1 (TC4: #04-#07)	34814
Yes	No	Alarm 1 (TC4: #08-#11)	35070
Yes	No	Alarm 1 (TC4: #12-#15)	35326
Yes	No	Alarm 2 (TC4: #00-#03)	36350
Yes	No	Alarm 2 (TC4: #04-#07)	36606
Yes	No	Alarm 2 (TC4: #08-#11)	36862
Yes	No	Alarm 2 (TC4: #12-#15)	37118
Yes	No	Alarm 3 (TC4: #00-#03)	38142
Yes	No	Alarm 3 (TC4: #04-#07)	38398
Yes	No	Alarm 3 (TC4: #08-#11)	38654
Yes	No	Alarm 3 (TC4: #12-#15)	38910
Yes	No	Input Error (TC4: #00-#03)	41470
Yes	No	Input Error (TC4: #04-#07)	41726
Yes	No	Input Error (TC4: #08-#11)	41982
Yes	No	Input Error (TC4: #12-#15)	42238
Yes	Yes	Run/Stop (TC4: #00-#03)	43262
Yes	Yes	Run/Stop (TC4: #04-#07)	43518
Yes	Yes	Run/Stop (TC4: #08-#11)	43774
Yes	Yes	Run/Stop (TC4: #12- #15)	44030
Yes	Yes	AT Execute/Cancel (TC4: #00-#03)	45054
Yes	Yes	AT Execute/Cancel (TC4: #04-#17)	45310
Yes	Yes	AT Execute/Cancel (TC4: #08-#11)	45566
Yes	Yes	AT Execute/Cancel (TC4: #12-#15)	45822
Yes	Yes	Auto/Manual (TC4: #00-#03)	46846
Yes	Yes	Auto/Manual (TC4: #04-#07)	47102
Yes	Yes	Auto/Manual (TC4: #08-#11)	47358
Yes	Yes	Auto/Manual (TC4: #12-#15)	47614
No	Yes	Software Reset	47870

- Note**
1. Always allocate the first word of the OUT Area to the OUT Enable Bit.
  2. These parameters are for expansion remote I/O.

## Parameters for Expansion Remote I/O (for TC4 and TC2)

Parameter name	Unit 0				Unit 1				Unit 2				Unit 3			
	ch1	ch2	ch3	ch4	ch1	ch2	ch3	ch4	ch1	ch2	ch3	ch4	ch1	ch2	ch3	ch4
Parameter specification	47872	47873	47874	47875	47888	47889	47890	47891	47904	47905	47906	47907	47920	47921	47922	47923
	Unit 4				Unit 5				Unit 6				Unit 7			
	ch1	ch2	ch3	ch4	ch1	ch2	ch3	ch4	ch1	ch2	ch3	ch4	ch1	ch2	ch3	ch4
	47936	47937	47938	47939	47952	47953	47954	47955	47968	47969	47970	47971	47984	47985	47986	47987
	Unit 8				Unit 9				Unit 10				Unit 11			
	ch1	ch2	ch3	ch4	ch1	ch2	ch3	ch4	ch1	ch2	ch3	ch4	ch1	ch2	ch3	ch4
	48000	48001	48002	48003	48016	48017	48018	48019	48032	48033	48034	48035	48048	48049	48050	48051
	Unit 12				Unit 13				Unit 14				Unit 15			
	ch1	ch2	ch3	ch4	ch1	ch2	ch3	ch4	ch1	ch2	ch3	ch4	ch1	ch2	ch3	ch4
	48064	48065	48066	48067	48080	48081	48082	48083	48096	48097	48098	48099	48112	48113	48114	48115

## Monitor Parameters (for TC4 and TC2)

## Units 0 to 3

Parameter name	Unit 0				Unit 1				Unit 2				Unit 3			
	ch1	ch2	ch3	ch4	ch1	ch2	ch3	ch4	ch1	ch2	ch3	ch4	ch1	ch2	ch3	ch4
Device A Status	256				272				288				304			
Configuration Error A Status	768				784				800				816			
Configuration Error B Status	1024				1040				1056				1072			
Internal Communications Error Status	1280				1296				1312				1328			
I/O Error Status	1536				1552				1568				1584			
I/O Alarm A Status (See note 3.)	1792				1808				1824				1840			
I/O Alarm B Status (See note 3.)	2048				2064				2080				2096			
I/O Notification A Status (See note 3.)	2304				2320				2336				2352			
Error Channel A Status	2560				2576				2592				2608			
Basic Unit/Expand Unit Error	2816				2832				2848				2864			
Basic Unit/Expand Unit Alarm	3072				3088				3104				3120			
Output Monitor	3328				3344				3360				3376			
Device B Status	3584				3600				3616				3632			
Process Value	3840	3841	3842	3843	3856	3857	3858	3859	3872	3873	3874	3875	3888	3889	3890	3891
Channel Status	4096	4097	4098	4099	4112	4113	4114	4115	4128	4129	4130	4131	4144	4145	4146	4147
Channel Alarm Status	4352	4353	4354	4355	4368	4369	4370	4371	4384	4385	4386	4387	4400	4401	4402	4403
Internal SP	4608	4609	4610	4611	4624	4625	4626	4627	4640	4641	4642	4643	4656	4657	4658	4659
Local SP Monitor	4864	4865	4866	4867	4880	4881	4882	4883	4896	4897	4898	4899	4912	4913	4914	4915
Remote SP Monitor	5120	5121	5122	5123	5136	5137	5138	5139	5152	5153	5154	5155	5168	5169	5170	5171
Bank No. Monitor	5376	5377	5378	5379	5392	5393	5394	5395	5408	5409	5410	5411	5424	5425	5426	5427
MV Monitor (Heating)	5632	5633	5634	5635	5648	5649	5650	5651	5664	5665	5666	5667	5680	5681	5682	5683
MV Monitor (Cooling)	5888	5889	5890	5891	5904	5905	5906	5907	5920	5921	5922	5923	5936	5937	5938	5939
Decimal Point Monitor	6144	6145	6146	6147	6160	6161	6162	6163	6176	6177	6178	6179	6192	6193	6194	6195
Heater Current Value Monitor (See note 3.)	6400	6401	6402	6403	6416	6417	6418	6419	6432	6433	6434	6435	6448	6449	6450	6451
Leakage Current Value Monitor (See note 3.)	6656	6657	6658	6659	6672	6673	6674	6675	6688	6689	6690	6691	6704	6705	6706	6707
G3ZA1 CH1 Control Variable Monitor (See note 4.)	17152	17153	17154	17155	17168	17169	17170	17171	17184	17185	17186	17187	17200	17201	17202	17203

Parameter name	Unit 0				Unit 1				Unit 2				Unit 3			
	ch1	ch2	ch3	ch4	ch1	ch2	ch3	ch4	ch1	ch2	ch3	ch4	ch1	ch2	ch3	ch4
G3ZA1 CH2 Control Variable Monitor (See note 4.)	17408	17409	17410	17411	17424	17425	17426	17427	17440	17441	17442	17443	17456	17457	17458	17459
G3ZA1 CH3 Control Variable Monitor (See note 4.)	17664	17665	17666	17667	17680	17681	17682	17683	17696	17697	17698	17699	17712	17713	17714	17715
G3ZA1 CH4 Control Variable Monitor (See note 4.)	17920	17921	17922	17923	17936	17937	17938	17939	17952	17953	17954	17955	17968	17969	17970	17971
G3ZA1 CH5 Control Variable Monitor (See note 4.)	18176	18177	18178	18179	18192	18193	18194	18195	18208	18209	18210	18211	18224	18225	18226	18227
G3ZA1 CH6 Control Variable Monitor (See note 4.)	18432	18433	18434	18435	18448	18449	18450	18451	18464	18465	18466	18467	18480	18481	18482	18483
G3ZA1 CH7 Control Variable Monitor (See note 4.)	18688	18689	18690	18691	18704	18705	18706	18707	18720	18721	18722	18723	18736	18737	18738	18739
G3ZA1 CH8 Control Variable Monitor (See note 4.)	18944	18945	18946	18947	18960	18961	18962	18963	18976	18977	18978	18979	18992	18993	18994	18994
G3ZA1 CH1 Status (See note 4.)	19200	19201	19202	19203	19216	19217	19218	19219	19232	19233	19234	19235	19248	19249	19250	19251
G3ZA1 CH2 Status (See note 4.)	19456	19457	19458	19459	19472	19473	19474	19475	19488	19489	19490	19491	19504	19505	19506	19507
G3ZA1 CH3 Status (See note 4.)	19712	19713	19714	19715	19728	19729	19730	19731	19744	19745	19746	19747	19760	19761	19762	19763
G3ZA1 CH4 Status (See note 4.)	19968	19969	19970	19971	19984	19985	19986	19987	20000	20001	20002	20003	20016	20017	20018	20019
G3ZA1 CH5 Status (See note 4.)	20224	20225	20226	20227	20240	20241	20242	20243	20256	20257	20258	20259	20272	20273	20274	20275
G3ZA1 CH6 Status (See note 4.)	20480	20481	20482	20483	20496	20497	20498	20499	20512	20513	20514	20515	20528	20529	20530	20531
G3ZA1 CH7 Status (See note 4.)	20736	20737	20738	20739	20752	20753	20754	20755	20768	20769	20770	20771	20784	20785	20786	20787
G3ZA1 CH8 Status (See note 4.)	20992	20993	20994	20995	21008	21009	21010	21011	21024	21025	21026	21027	21040	21041	21042	21043
G3ZA1 CH1 Heater ON Current Monitor (See note 4.)	21248	21249	21250	21251	21264	21265	21266	21267	21280	21281	21282	21283	21296	21297	21298	21299
G3ZA1 CH2 Heater ON Current Monitor (See note 4.)	21504	21505	21506	21507	21520	21521	21522	21523	21536	21537	21538	21539	21552	21553	21554	21555
G3ZA1 CH3 Heater ON Current Monitor (See note 4.)	21760	21761	21762	21763	21776	21777	21778	21779	21792	21793	21794	21795	21808	21809	21810	21811
G3ZA1 CH4 Heater ON Current Monitor (See note 4.)	22016	22017	22018	22019	22032	22033	22034	22035	22048	22049	22050	22051	22064	22065	22066	22067
G3ZA1 CH1 Heater OFF Current Monitor (See note 4.)	22272	22273	22274	22275	22288	22289	22290	22291	22304	22305	22306	22307	22320	22321	22322	22323
G3ZA1 CH2 Heater OFF Current Monitor (See note 4.)	22528	22529	22530	22531	22544	22545	22546	22547	22560	22561	22562	22563	22576	22577	22578	22579
G3ZA1 CH3 Heater OFF Current Monitor (See note 4.)	22784	22785	22786	22787	22800	22801	22802	22803	22816	22817	22818	22819	22832	22833	22834	22835
G3ZA1 CH4 Heater OFF Current Monitor (See note 4.)	23040	23041	23042	23043	23056	23057	23058	23059	23072	23073	23074	23075	23088	23089	23090	23091

- Note**
1. Only the IN Area can be allocated to monitor parameters.
  2. TC2 Units cannot use allocations for channel 3 or channel 4.
  3. Can be used with TC2 Units, but not TC4 Units.
  4. Monitoring can be performed for up to four G3ZA Power Controllers for each Temperature Controller. Each channel of Temperature Controller corresponds to one G3ZA Power Controller. (Example: ch1 → G3ZA1)

## Units 4 to 7

Parameter name	Unit 4				Unit 5				Unit 6				Unit 7			
	ch1	ch2	ch3	ch4	ch1	ch2	ch3	ch4	ch1	ch2	ch3	ch4	ch1	ch2	ch3	ch4
Device A Status	320				336				352				368			
Configuration Error A Status	832				848				864				880			
Configuration Error B Status	1088				1104				1120				1136			
Internal Communications Error Status	1344				1360				1376				1392			
I/O Error Status	1600				1616				1632				1648			
I/O Alarm A Status (See note 3.)	1856				1872				1888				1904			
I/O Alarm B Status (See note 3.)	2112				2128				2144				2160			
I/O Notification A Status (See note 3.)	2368				2384				2400				2416			
Error Channel A Status	2624				2640				2656				2672			
Basic Unit/Expand Unit Error	2880				2896				2912				2928			
Basic Unit/Expand Unit Alarm	3136				3152				3168				3184			
Output Monitor	3392				3408				3424				3440			
Device B Status	3468				3664				3680				3696			
Process Value	3904	3905	3906	3907	3920	3921	3922	3923	3936	3937	3938	3939	3952	3953	3954	3955
Channel Status	4160	4161	4162	4163	4176	4177	4178	4179	4192	4193	4194	4195	4208	4209	4210	4211
Channel Alarm Status	4416	4417	4418	4419	4432	4433	4434	4435	4448	4449	4450	4451	4464	4465	4466	4467
Internal SP	4672	4673	4674	4675	4688	4689	4690	4691	4704	4705	4706	4707	4720	4721	4722	4723
Local SP Monitor	4928	4929	4930	4931	4944	4945	4946	4947	4960	4961	4962	4963	4976	4977	4978	4979
Remote SP Monitor	5184	5185	5186	5187	5200	5201	5202	5203	5216	5217	5218	5219	5232	5233	5234	5235
Bank No. Monitor	5440	5441	5442	5443	5456	5457	5458	5459	5472	5473	5474	5475	5488	5489	5490	5491
MV Monitor (Heating)	5696	5697	5698	5699	5712	5713	5714	5715	5728	5729	5730	5731	5744	5745	5746	5747
MV Monitor (Cooling)	5952	5953	5954	5955	5968	5969	5970	5971	5984	5985	5986	5987	6000	6001	6002	6003
Decimal Point Monitor	6208	6209	6210	6211	6224	6225	6226	6227	6240	6241	6242	6243	6256	6257	6258	6259
Heater Current Value Monitor (See note 3.)	6464	6465	6466	6467	6480	6481	6482	6483	6496	6497	6498	6499	6512	6513	6514	6515
Leakage Current Value Monitor (See note 3.)	6720	6721	6722	6723	6736	6737	6738	6739	6752	6753	6754	6755	6768	6769	6770	6771
G3ZA1 CH1 Control Variable Monitor (See note 4.)	17216	17217	17218	17219	17232	17233	17234	17235	17248	17249	17250	17251	17264	17265	17266	17267
G3ZA1 CH2 Control Variable Monitor (See note 4.)	17472	17473	17474	17475	17488	17489	17490	17491	17504	17505	17506	17507	17520	17521	17522	17523
G3ZA1 CH3 Control Variable Monitor (See note 4.)	17728	17729	17730	17731	17744	17745	17746	17747	17760	17761	17762	17763	17776	17777	17778	17779
G3ZA1 CH4 Control Variable Monitor (See note 4.)	17984	17985	17986	17987	18000	18001	18002	18003	18016	18017	18018	18019	18032	18033	18034	18035
G3ZA1 CH5 Control Variable Monitor (See note 4.)	18240	18241	18242	18243	18526	18527	18528	18529	18272	18273	18274	18275	18288	18289	18290	18291
G3ZA1 CH6 Control Variable Monitor (See note 4.)	18496	18497	18498	18499	18512	18513	18514	18515	18528	18529	18530	18531	18544	18545	18546	18547
G3ZA1 CH7 Control Variable Monitor (See note 4.)	18752	18753	18754	18755	18768	18769	18770	18771	18784	18785	18786	18787	18800	18801	18802	18803
G3ZA1 CH8 Control Variable Monitor (See note 4.)	19008	19009	19010	19011	19204	19205	19206	19207	19040	19041	19042	19043	19056	19057	19058	19059
G3ZA1 CH1 Status (See note 4.)	19264	19265	19266	19267	19280	19281	19282	19283	19296	19297	19298	19299	19312	19313	19314	19315
G3ZA1 CH2 Status (See note 4.)	19520	19521	19522	19523	19536	19537	19538	19539	19552	19553	19554	19555	19568	19569	19570	19571

Parameter name	Unit 4				Unit 5				Unit 6				Unit 7			
	ch1	ch2	ch3	ch4	ch1	ch2	ch3	ch4	ch1	ch2	ch3	ch4	ch1	ch2	ch3	ch4
G3ZA1 CH3 Status (See note 4.)	19776	19777	19778	19779	19792	19793	19794	19795	19808	19809	19810	19811	19824	19825	19826	19827
G3ZA1 CH4 Status (See note 4.)	20032	20033	20034	20035	20048	20049	20050	20051	20064	20065	20066	20067	20080	20081	20082	20083
G3ZA1 CH5 Status (See note 4.)	20288	20289	20290	20291	20304	20305	20306	20307	20320	20321	20322	20323	20336	20337	20338	20339
G3ZA1 CH6 Status (See note 4.)	20544	20545	20546	20547	20560	20561	20562	20563	20576	20577	20578	20579	20592	20593	20594	20595
G3ZA1 CH7 Status (See note 4.)	20800	20801	20802	20803	20816	20817	20818	20819	20832	20833	20834	20835	20848	20849	20850	20851
G3ZA1 CH8 Status (See note 4.)	21056	21057	21058	21059	21072	21073	21074	21075	21088	21089	21090	21091	21104	21105	21106	21107
G3ZA1 CH1 Heater ON Current Monitor (See note 4.)	21312	21313	21314	21315	21328	21329	21330	21331	21344	21345	21346	21347	21360	21361	21362	21363
G3ZA1 CH2 Heater ON Current Monitor (See note 4.)	21568	21569	21570	21571	21584	21585	21586	21587	21600	21601	21602	21603	21616	21617	21618	21619
G3ZA1 CH3 Heater ON Current Monitor (See note 4.)	21824	21825	21826	21827	21840	21841	21842	21843	21856	21857	21858	21859	21872	21873	21874	21875
G3ZA1 CH4 Heater ON Current Monitor (See note 4.)	22080	22081	22082	22083	22096	22097	22098	22099	22112	22113	22114	22115	22128	22129	22130	22131
G3ZA1 CH1 Heater OFF Current Monitor (See note 4.)	22336	22337	22338	22339	22352	22353	22354	22355	22368	22369	22370	22371	22384	22385	22386	22387
G3ZA1 CH2 Heater OFF Current Monitor (See note 4.)	22592	22593	22594	22595	22608	22609	22610	22611	22624	22625	22626	22627	22640	22641	22642	22643
G3ZA1 CH3 Heater OFF Current Monitor (See note 4.)	22848	22849	22850	22851	22864	22865	22866	22867	22880	22881	22882	22883	22896	22897	22898	22899
G3ZA1 CH4 Heater OFF Current Monitor (See note 4.)	23104	23105	23106	23107	23120	23121	23122	23123	23136	23137	23138	23139	23152	23153	23154	23155

- Note**
1. Only the IN Area can be allocated to monitor parameters.
  2. TC2 Units cannot use allocations for channel 3 or channel 4.
  3. Can be used with TC2 Units, but not TC4 Units.
  4. Monitoring can be performed for up to four G3ZA Power Controllers for each Temperature Controller. Each channel of Temperature Controller corresponds to one G3ZA Power Controller. (Example: ch1 → G3ZA1)

## Units 8 to 11

Parameter name	Unit 8				Unit 9				Unit 10				Unit 11			
	ch1	ch2	ch3	ch4	ch1	ch2	ch3	ch4	ch1	ch2	ch3	ch4	ch1	ch2	ch3	ch4
Device A Status	384				400				416				432			
Configuration Error A Status	896				912				928				944			
Configuration Error B Status	1152				1168				1184				1200			
Internal Communications Error Status	1408				1424				1440				1456			
I/O Error Status	1664				1680				1696				1712			
I/O Alarm A Status (See note 3.)	1920				1936				1952				1968			
I/O Alarm B Status (See note 3.)	2176				2192				2208				2224			
I/O Notification A Status (See note 3.)	2432				2448				2464				2480			
Error Channel A Status	2688				2704				2720				2736			
Basic Unit/Expand Unit Error	2944				2960				2976				2992			
Basic Unit/Expand Unit Alarm	3200				3216				3232				3248			
Output Monitor	3456				3472				3488				3504			
Device B Status	3712				3728				3744				3760			
Process Value	3968	3969	3970	3971	3984	3985	3986	3987	4000	4001	4002	4003	4016	4017	4018	4019
Channel Status	4224	4225	4226	4227	4240	4241	4242	4243	4256	4257	4258	4259	4272	4273	4274	4275
Channel Alarm Status	4480	4481	4482	4483	4496	4497	4498	4499	4512	4513	4514	4515	4528	4529	4530	4531
Internal SP	4736	4737	4738	4739	4752	4753	4754	4755	4768	4769	4770	4771	4784	4785	4786	4787
Local SP Monitor	4992	4993	4994	4995	5008	5009	5010	5011	5024	5025	5026	5027	5040	5041	5042	5043
Remote SP Monitor	5248	5249	5250	5251	5264	5265	5266	5267	5280	5281	5282	5283	5296	5297	5298	5299
Bank No. Monitor	5504	5505	5506	5507	5520	5521	5522	5523	5536	5537	5538	5539	5552	5553	5554	5555
MV Monitor (Heating)	5760	5761	5762	5763	5776	5777	5778	5779	5792	5793	5794	5795	5808	5809	5810	5811
MV Monitor (Cooling)	6016	6017	6018	6019	6032	6033	6034	6035	6048	6049	6050	6051	6064	6065	6066	6067
Decimal Point Monitor	6272	6273	6274	6275	6288	6289	6290	6291	6304	6305	6306	6307	6320	6321	6322	6323
Heater Current Value Monitor (See note 3.)	6528	6529	6530	6531	6544	6545	6546	6547	6560	6561	6562	6563	6576	6577	6578	6579
Leakage Current Value Monitor (See note 3.)	6784	6785	6786	6787	6800	6801	6802	6803	6816	6817	6818	6819	6832	6833	6834	6835
G3ZA1 CH1 Control Variable Monitor (See note 4.)	17280	17281	17282	17283	17296	17297	17298	17299	17312	17313	17314	17315	17328	17329	17330	17331
G3ZA1 CH2 Control Variable Monitor (See note 4.)	17536	17537	17538	17539	17552	17553	17554	17555	17568	17569	17570	17571	17584	17585	17586	17587
G3ZA1 CH3 Control Variable Monitor (See note 4.)	17792	17793	17794	17795	17808	17809	17810	17811	17824	17825	17826	17827	17840	17841	17842	17843
G3ZA1 CH4 Control Variable Monitor (See note 4.)	18048	18049	18050	18051	18064	18065	18066	18067	18080	18081	18082	18083	18096	18097	18098	18099
G3ZA1 CH5 Control Variable Monitor (See note 4.)	18304	18305	18306	18307	18320	18321	18322	18323	18336	18337	18338	18339	18352	18353	18354	18355
G3ZA1 CH6 Control Variable Monitor (See note 4.)	18560	18561	18562	18563	18576	18577	18578	18579	18592	18593	18594	18595	18608	18609	18610	18611
G3ZA1 CH7 Control Variable Monitor (See note 4.)	18816	18817	18818	18819	18832	18833	18834	18835	18848	18849	18850	18851	18864	18865	18866	18867
G3ZA1 CH8 Control Variable Monitor (See note 4.)	19072	19073	19074	19075	19088	19089	19090	19091	19104	19105	19106	19107	19120	19121	19122	19123
G3ZA1 CH1 Status (See note 4.)	19328	19329	19330	19331	19344	19345	19346	19347	19360	19361	19362	19363	19376	19377	19378	19379
G3ZA1 CH2 Status (See note 4.)	19584	19585	19586	19587	19600	19601	19602	19603	19616	19617	19618	19619	19632	19633	19634	19635



Parameter name	Unit 8				Unit 9				Unit 10				Unit 11			
	ch1	ch2	ch3	ch4	ch1	ch2	ch3	ch4	ch1	ch2	ch3	ch4	ch1	ch2	ch3	ch4
G3ZA1 CH3 Status (See note 4.)	19840	19841	19842	19843	19856	19857	19858	19859	19872	19873	19874	19875	19888	19889	19890	19891
G3ZA1 CH4 Status (See note 4.)	20096	20097	20098	20099	20112	20113	20114	20115	20128	20129	20130	20131	20144	20145	20146	20147
G3ZA1 CH5 Status (See note 4.)	20352	20353	20354	20355	20368	20369	20370	20371	20384	20385	20386	20387	20400	20401	20402	20403
G3ZA1 CH6 Status (See note 4.)	20608	20609	20610	20611	20624	20625	20626	20627	20640	20641	20642	20643	20656	20657	20658	20659
G3ZA1 CH7 Status (See note 4.)	20864	20865	20866	20867	20880	20881	20882	20883	20896	20897	20898	20899	20912	20913	20914	20915
G3ZA1 CH8 Status (See note 4.)	21120	21121	21122	21123	21136	21137	21138	21139	21152	21153	21154	21155	21168	21169	21170	21171
G3ZA1 CH1 Heater ON Current Monitor (See note 4.)	21376	21377	21378	21379	21392	21393	21394	21395	21408	21409	21410	21411	21424	21425	21426	21427
G3ZA1 CH2 Heater ON Current Monitor (See note 4.)	21632	21633	21634	21635	21648	21649	21650	21651	21664	21665	21666	21667	21680	21681	21682	21683
G3ZA1 CH3 Heater ON Current Monitor (See note 4.)	21888	21889	21890	21891	21904	21905	21906	21907	21920	21921	21922	21923	21936	21937	21938	21939
G3ZA1 CH4 Heater ON Current Monitor (See note 4.)	22144	22145	22146	22147	22160	22161	22162	22163	22176	22177	22178	22179	22192	22193	22194	22195
G3ZA1 CH1 Heater OFF Current Monitor (See note 4.)	22400	22401	22402	22403	22416	22417	22418	22419	22432	22433	22434	22435	22448	22449	22450	22451
G3ZA1 CH2 Heater OFF Current Monitor (See note 4.)	22656	22657	22658	22659	22672	22673	22674	22675	22688	22689	22690	22691	22704	22705	22706	22707
G3ZA1 CH3 Heater OFF Current Monitor (See note 4.)	22912	22913	22914	22915	22928	22929	22930	22931	22944	22945	22946	22947	22960	22961	22962	22963
G3ZA1 CH4 Heater OFF Current Monitor (See note 4.)	23168	23169	23170	23171	23184	23185	23186	23187	23200	23201	23202	23203	23216	23217	23218	23219

- Note**
1. Only the IN Area can be allocated to monitor parameters.
  2. TC2 Units cannot use allocations for channel 3 or channel 4.
  3. Can be used with TC2 Units, but not TC4 Units.
  4. Monitoring can be performed for up to four G3ZA Power Controllers for each Temperature Controller. Each channel of Temperature Controller corresponds to one G3ZA Power Controller. (Example: ch1 → G3ZA1)

## Units 12 to 15

Parameter name	Unit 12				Unit 13				Unit 14				Unit 15			
	ch1	ch2	ch3	ch4	ch1	ch2	ch3	ch4	ch1	ch2	ch3	ch4	ch1	ch2	ch3	ch4
Device A Status	448				464				480				496			
Configuration Error A Status	960				976				992				1008			
Configuration Error B Status	1216				1232				1248				1264			
Internal Communications Error Status	1472				1488				1504				1520			
I/O Error Status	1728				1744				1760				1776			
I/O Alarm A Status (See note 3.)	1984				2000				2016				2032			
I/O Alarm B Status (See note 3.)	2240				2256				2272				2288			
I/O Notification A Status (See note 3.)	2496				2512				2528				2544			
Error Channel A Status	2752				2768				2784				2800			
Basic Unit/Expand Unit Error	3008				3024				3040				3056			
Basic Unit/Expand Unit Alarm	3264				3280				3296				3312			
Output Monitor	3520				3356				3552				3568			
Device B Status	3776				3792				3808				3824			
Process Value	4032	4033	4034	4035	4048	4049	4050	4051	4064	4065	4066	4067	4080	4081	4082	4083
Channel Status	4288	4289	4290	4291	4304	4305	4306	4307	4320	4321	4322	4323	4336	4337	4338	4339
Channel Alarm Status	4544	4545	4546	4547	4560	4561	4562	4563	4576	4577	4578	4579	4592	4593	4594	4595
Internal SP	4800	4801	4802	4803	4816	4817	4818	4819	4832	4833	4834	4835	4848	4849	4850	4851
Local SP Monitor	5056	5057	5058	5059	5072	5073	5074	5075	5088	5089	5090	5091	5104	5105	5106	5107
Remote SP Monitor	5312	5313	5314	5315	5328	5329	5330	5331	5344	5345	5346	5347	5360	5361	5362	5363
Bank No. Monitor	5568	5569	5570	5571	5584	5585	5586	5587	5600	5601	5602	5603	5616	5617	5618	5619
MV Monitor (Heating)	5824	5825	5826	5827	5840	5841	5842	5843	5856	5857	5858	5859	5872	5873	5874	5875
MV Monitor (Cooling)	6080	6081	6082	6083	6096	6097	6098	6099	6112	6113	6114	6115	6128	6129	6130	6131
Decimal Point Monitor	6336	6337	6338	6339	6352	6353	6354	6355	6368	6369	6370	6371	6384	6385	6386	6387
Heater Current Value Monitor (See note 3.)	6592	6593	6594	6595	6608	6609	6610	6611	6624	6625	6626	6627	6640	6641	6642	6643
Leakage Current Value Monitor (See note 3.)	6848	6849	6850	6851	6864	6865	6866	6867	6880	6881	6882	6883	6896	6897	6898	6899
G3ZA1 CH1 Control Variable Monitor (See note 4.)	17344	17345	17346	17347	17360	17361	17362	17363	17376	17377	17378	17379	17392	17393	17394	17395
G3ZA1 CH2 Control Variable Monitor (See note 4.)	17600	17601	17602	17603	17616	17617	17618	17619	17632	17633	17634	17635	17648	17649	17650	17651
G3ZA1 CH3 Control Variable Monitor (See note 4.)	17856	17857	17858	17859	17872	17873	17874	17875	17888	17889	17890	17891	17904	17905	17906	17907
G3ZA1 CH4 Control Variable Monitor (See note 4.)	18112	18113	18114	18115	18128	18129	18130	18131	18144	18145	18146	18147	18160	18161	18162	18163
G3ZA1 CH5 Control Variable Monitor (See note 4.)	18368	18369	18370	18371	18384	18385	18386	18387	18400	18401	18402	18403	18416	18417	18418	18419
G3ZA1 CH6 Control Variable Monitor (See note 4.)	18624	18625	18626	18627	18640	18641	18642	18643	18656	18657	18658	18659	18672	18673	18674	18675
G3ZA1 CH7 Control Variable Monitor (See note 4.)	18880	18881	18882	18883	18896	18897	18898	18899	18912	18913	18914	18915	18928	18929	18930	18931
G3ZA1 CH8 Control Variable Monitor (See note 4.)	19136	19137	19138	19139	19152	19153	19154	19155	19168	19169	19170	19171	19184	19185	19186	19187
G3ZA1 CH1 Status (See note 4.)	19392	19393	19394	19395	19408	19409	19410	19411	19424	19425	19426	19427	19440	19441	19442	19443
G3ZA1 CH2 Status (See note 4.)	19648	19649	19650	19651	19664	19665	19666	19667	19680	19681	19682	19683	19696	19697	19698	19699

Parameter name	Unit 12				Unit 13				Unit 14				Unit 15			
	ch1	ch2	ch3	ch4	ch1	ch2	ch3	ch4	ch1	ch2	ch3	ch4	ch1	ch2	ch3	ch4
G3ZA1 CH3 Status (See note 4.)	19904	19905	19906	19907	19920	19921	19922	19923	19936	19937	19938	19939	19952	19953	19954	19955
G3ZA1 CH4 Status (See note 4.)	20160	20161	20162	20163	20176	20177	20178	20179	20192	20193	20194	20195	20208	20209	20210	20211
G3ZA1 CH5 Status (See note 4.)	20416	20417	20418	20419	20432	20433	20434	20435	20448	20449	20450	20451	20464	20465	20466	20467
G3ZA1 CH6 Status (See note 4.)	20672	20673	20674	20675	20688	20689	20690	20691	20704	20705	20706	20707	20720	20721	20722	20723
G3ZA1 CH7 Status (See note 4.)	20928	20929	20930	20931	20944	20945	20946	20947	20960	20961	20962	20963	20976	20977	20978	20979
G3ZA1 CH8 Status (See note 4.)	21184	21185	21186	21187	21200	21201	21202	21203	21216	21217	21218	21219	21232	21233	21234	21235
G3ZA1 CH1 Heater ON Current Monitor (See note 4.)	21440	21441	21442	21443	21456	21457	21458	21459	21472	21473	21474	21475	21488	21489	21490	21491
G3ZA1 CH2 Heater ON Current Monitor (See note 4.)	21696	21697	21698	21699	21712	21713	21714	21715	21728	21729	21730	21731	21744	21745	21746	21747
G3ZA1 CH3 Heater ON Current Monitor (See note 4.)	21952	21953	21954	21955	21968	21969	21970	21971	21984	21985	21986	21987	22000	22001	22002	22003
G3ZA1 CH4 Heater ON Current Monitor (See note 4.)	22208	22209	22210	22211	22224	22225	22226	22227	22240	22241	22242	22243	22256	22257	22258	22259
G3ZA1 CH1 Heater OFF Current Monitor (See note 4.)	22464	22465	22466	22467	22480	22481	22482	22483	22496	22497	22498	22499	22512	22513	22514	22515
G3ZA1 CH2 Heater OFF Current Monitor (See note 4.)	22720	22721	22722	22723	22736	22737	22738	22739	22752	22753	22754	22755	22768	22769	22770	22771
G3ZA1 CH3 Heater OFF Current Monitor (See note 4.)	22976	22977	22978	22979	22992	22993	22994	22995	23008	23009	23010	23011	23024	23025	23026	23027
G3ZA1 CH4 Heater OFF Current Monitor (See note 4.)	23232	23233	23234	23235	23248	23249	23250	23251	23264	23265	23266	23267	23280	23281	23282	23283

- Note**
1. Only the IN Area can be allocated to monitor parameters.
  2. TC2 Units cannot use allocations for channel 3 or channel 4.
  3. Can be used with TC2 Units, but not TC4 Units.
  4. Monitoring can be performed for up to four G3ZA Power Controllers for each Temperature Controller. Each channel of Temperature Controller corresponds to one G3ZA Power Controller. (Example: ch1 → G3ZA1)

## Parameters That Can Be Changed during Operation (TC4 and TC2)

### Units 0 to 3

Parameter name	Unit 0				Unit 1				Unit 2				Unit 3			
	ch1	ch2	ch3	ch4	ch1	ch2	ch3	ch4	ch1	ch2	ch3	ch4	ch1	ch2	ch3	ch4
Present Bank Set Point	6912	6913	6914	6915	6928	6929	6930	6931	6944	6945	6946	6947	6960	6961	6962	6963
Present Bank Proportional Band	7168	7169	7170	7171	7184	7185	7186	7187	7200	7201	7202	7203	7216	7217	7218	7219
Present Bank Integral Time	7424	7425	7426	7427	7440	7441	7442	7443	7456	7457	7458	7459	7472	7473	7474	7475
Present Bank Derivative Time	7680	7681	7682	7683	7696	7697	7698	7699	7712	7713	7714	7715	7728	7729	7730	7731
Present Bank SP Ramp Rise Value	7936	7937	7938	7939	7952	7953	7954	7955	7968	7969	7970	7971	7984	7985	7986	7987
Present Bank SP Ramp Fall Value	8192	8193	8194	8195	8208	8209	8210	8211	8224	8225	8226	8227	8240	8241	8242	8243
Present Bank Manual Reset Value	8448	8449	8450	8451	8464	8465	8466	8467	8480	8481	8482	8483	8496	8497	8498	8499
Present Bank Cooling Coefficient	8704	8705	8706	8707	8720	8721	8722	8723	8736	8737	8738	8739	8752	8753	8754	8755
Present Bank Dead Band	8960	8961	8962	8963	8976	8977	8978	8979	8992	8993	8994	8995	9008	9009	9010	9011
Present Bank Alarm Value 1	9216	9217	9218	9219	9232	9233	9234	9235	9248	9249	9250	9251	9264	9265	9266	9267
Present Bank Alarm Upper Limit Value 1	9472	9473	9474	9475	9488	9489	9490	9491	9504	9505	9506	9507	9520	9521	9522	9523
Present Bank Alarm Lower Limit Value 1	9728	9729	9730	9731	9744	9745	9746	9747	9760	9761	9762	9763	9776	9777	9778	9779
Present Bank Alarm Value 2	9984	9985	9986	9987	10000	10001	10002	10003	10016	10017	10018	10019	10032	10033	10034	10035
Present Bank Alarm Upper Limit Value 2	10240	10241	10242	10243	10256	10257	10258	10259	10272	10273	10274	10275	10288	10289	10290	10291
Present Bank Alarm Lower Limit Value 2	10496	10497	10498	10499	10512	10513	10514	10515	10528	10529	10530	10531	10544	10545	10546	10547
Present Bank Alarm Value 3	10752	10753	10754	10755	10768	10769	10770	10771	10784	10785	10786	10787	10800	10801	10802	10803
Present Bank Alarm Upper Limit Value 3	11008	11009	11010	11011	11024	11025	11026	11027	11040	11041	11042	11043	11056	11057	11058	11059
Present Bank Alarm Lower Limit Value 3	11264	11265	11266	11267	11280	11281	11282	11283	11296	11297	11298	11299	11312	11313	11314	11315
Input Digital Filter	11520	11521	11522	11523	11536	11537	11538	11539	11552	11553	11554	11555	11568	11569	11570	11571
Input Value 1 for Input Correction	11776	11777	11778	11779	11792	11793	11794	11795	11808	11809	11810	11811	11824	11825	11826	11827
Input Shift 1	12032	12033	12034	12035	12048	12049	12050	12051	12064	12065	12066	12067	12080	12081	12082	12083
Input Value 2 for Input Correction	12288	12289	12290	12291	12304	12305	12306	12307	12320	12321	12322	12323	12336	12337	12338	12339
Input Shift 2	12544	12545	12546	12547	12560	12561	12562	12563	12576	12577	12578	12579	12592	12593	12594	12595
MV at PV Error	12800	12801	12802	12803	12816	12817	12818	12819	12832	12833	12834	12835	12848	12849	12850	12851
MV at Stop	13056	13057	13058	13059	13072	13073	13074	13075	13088	13089	13090	13091	13104	13105	13106	13107
MV Upper Limit	13312	13313	13314	13315	13328	13329	13330	13331	13344	13345	13346	13347	13360	13361	13362	13363
MV Lower Limit	13568	13569	13570	13571	13584	13585	13586	13587	13600	13601	13602	13603	13616	13617	13618	13619
Hysteresis (Heating)	13824	13825	13826	13827	13840	13841	13842	13843	13856	13857	13858	13859	13872	13873	13874	13875
Hysteresis (Cooling)	14080	14081	14082	14083	14096	14097	14098	14099	14112	14113	14114	14115	14128	14129	14130	14131
Alpha	14336	14337	14338	14339	14352	14353	14354	14355	14368	14369	14370	14371	14384	14385	14386	14387
Manual MV	14592	14593	14594	14595	14608	14609	14610	14611	14624	14625	14626	14627	14640	14641	14642	14643
SP Upper Limit	14848	14849	14850	14851	14864	14865	14866	14867	14880	14881	14882	14883	14896	14897	14898	14899
SP Lower Limit	15104	15105	15106	15107	15120	15121	15122	15123	15136	15137	15138	15139	15152	15153	15154	15155
Disturbance Gain	15360	15361	15362	15363	15376	15377	15378	15379	15392	15393	15394	15395	15408	15409	15410	15411
Disturbance Time Constant	15616	15617	15618	15619	15632	15633	15634	15635	15648	15649	15650	15651	15664	15665	15666	15667
Disturbance Rectification Band	15872	15873	15874	15875	15888	15889	15890	15891	15904	15905	15906	15907	15920	15921	15922	15923
Disturbance Judgement Width	16128	16129	16130	16131	16144	16145	16146	16147	16160	16161	16162	16163	16176	16177	16178	16179

Parameter name	Unit 0				Unit 1				Unit 2				Unit 3			
	ch1	ch2	ch3	ch4	ch1	ch2	ch3	ch4	ch1	ch2	ch3	ch4	ch1	ch2	ch3	ch4
Heater Burnout 1 Detection (See note 3.)	16384	16385	16386	16387	16400	16401	16402	16403	16416	16417	16418	16419	16432	16433	16434	16435
HS Alarm 1 (See note 3.)	16640	16641	16642	16643	16656	16657	16658	16659	16672	16673	16674	16675	16688	16689	16690	16691
Heater Overcurrent Detection (See note 3.)	16896	16897	16898	16899	16912	16913	16914	16915	16928	16929	16930	16931	16944	16945	16946	16947

- Note**
- Both the IN Area and the OUT Area can be allocated to parameters that can be changed during operation.
  - TC2 Units cannot use allocations for channel 3 or channel 4.
  - Can be used with TC2 Units, but not TC4 Units.

## Units 4 to 7

Parameter name	Unit 4				Unit 5				Unit 6				Unit 7			
	ch1	ch2	ch3	ch4	ch1	ch2	ch3	ch4	ch1	ch2	ch3	ch4	ch1	ch2	ch3	ch4
Present Bank Set Point	6976	6977	6978	6979	6992	6993	6994	6995	7008	7009	7010	7011	7024	7025	7026	7027
Present Bank Proportional Band	7232	7233	7234	7235	7248	7249	7250	7251	7264	7265	7266	7267	7280	7281	7282	7283
Present Bank Integral Time	7488	7489	7490	7491	7504	7505	7506	7507	7520	7521	7522	7523	7536	7537	7538	7539
Present Bank Derivative Time	7744	7745	7746	7747	7760	7761	7762	7763	7776	7777	7778	7779	7792	7793	7794	7795
Present Bank SP Ramp Rise Value	8000	8001	8002	8003	8016	8017	8018	8019	8032	8033	8034	8035	8048	8049	8050	8051
Present Bank SP Ramp Fall Value	8256	8257	8258	8259	8272	8273	8274	8275	8288	8289	8290	8291	8304	8305	8306	8307
Present Bank Manual Reset Value 1	8512	8513	8514	8515	8528	8529	8530	8531	8544	8545	8546	8547	8560	8561	8562	8563
Present Bank Cooling Coefficient	8768	8769	8770	8771	8784	8785	8786	8787	8800	8801	8802	8803	8816	8817	8818	8819
Present Bank Dead Band	9024	9025	9026	9027	9040	9041	9042	9043	9056	9057	9058	9059	9072	9073	9074	9075
Present Bank Alarm Value	9280	9281	9282	9283	9296	9297	9298	9299	9312	9313	9314	9315	9328	9329	9330	9331
Present Bank Alarm Upper Limit Value 1	9536	9537	9538	9539	9552	9553	9554	9555	9568	9569	9570	9571	9584	9585	9586	9587
Present Bank Alarm Lower Limit Value 1	9792	9793	9794	9795	9808	9809	9810	9811	9824	9825	9826	9827	9840	9841	9842	9843
Present Bank Alarm Value 2	10048	10049	10050	10051	10064	10065	10066	10067	10080	10081	10082	10083	10096	10097	10098	10099
Present Bank Alarm Upper Limit Value 2	10304	10305	10306	10307	10320	10321	10322	10323	10336	10337	10338	10339	10352	10353	10354	10355
Present Bank Alarm Lower Limit Value 2	10560	10561	10562	10563	10576	10577	10578	10579	10592	10593	10594	10595	10608	10609	10610	10611
Present Bank Alarm Value 3	10816	10817	10818	10819	10832	10833	10834	10835	10848	10849	10850	10851	10864	10865	10866	10867
Present Bank Alarm Upper Limit Value 3	11072	11073	11074	11075	11088	11089	11090	11091	11104	11105	11106	11107	11120	11121	11122	11123
Present Bank Alarm Lower Limit Value 3	11328	11329	11330	11331	11344	11345	11346	11347	11360	11361	11362	11363	11376	11377	11378	11379
Input Digital Filter	11584	11585	11586	11587	11600	11601	11602	11603	11616	11617	11618	11619	11632	11633	11634	11635
Input Value 1 for Input Correction	11840	11841	11842	11843	11856	11857	11858	11859	11872	11873	11874	11875	11888	11889	11890	11891
Input Shift 1	12096	12097	12098	12099	12112	12113	12114	12115	12128	12129	12130	12131	12144	12145	12146	12147
Input Value 2 for Input Correction	12352	12353	12354	12355	12368	12369	12370	12371	12384	12385	12386	12387	12400	12401	12402	12403
Input Shift 2	12608	12609	12610	12611	12624	12625	12626	12627	12640	12641	12642	12643	12656	12657	12658	12659
MV at PV Error	12864	12865	12866	12867	12880	12881	12882	12883	12896	12897	12898	12899	12912	12913	12914	12915
MV at Stop	13120	13121	13122	13123	13136	13137	13138	13139	13152	13153	13154	13155	13168	13169	13170	13171
MV Upper Limit	13376	13377	13378	13379	13392	13393	13394	13395	13408	13409	13410	13411	13424	13425	13426	13427
MV Lower Limit	13632	13633	13634	13635	13648	13649	13650	13651	13664	13665	13666	13667	13680	13681	13682	13683
Hysteresis (Heating)	13888	13889	13890	13891	13904	13905	13906	13907	13920	13921	13922	13923	13936	13937	13938	13939
Hysteresis (Cooling)	14144	14145	14146	14147	14160	14161	14162	14163	14176	14177	14178	14179	14192	14193	14194	14195
Alpha	14400	14401	14402	14403	14416	14417	14418	14419	14432	14433	14434	14435	14448	14449	14450	14451
Manual MV	14656	14657	14658	14659	14672	14673	14674	14675	14688	14689	14690	14691	14704	14705	14706	14707
SP Upper Limit	14912	14913	14914	14915	14928	14929	14930	14931	14944	14945	14946	14947	14960	14961	14962	14963
SP Lower Limit	15168	15169	15170	15171	15184	15185	15186	15187	15200	15201	15202	15203	15216	15217	15218	15219
Disturbance Gain	15424	15425	15426	15427	15440	15441	15442	15443	15456	15457	15458	15459	15472	15473	15474	15475
Disturbance Time Constant	15680	15681	15682	15683	15696	15697	15698	15699	15712	15713	15714	15715	15728	15729	15730	15731
Disturbance Rectification Band	15936	15937	15938	15939	15952	15953	15954	15955	15968	15969	15970	15971	15984	15985	15986	15987
Disturbance Judgement Width	16192	16193	16194	16195	16208	16209	16210	16211	16224	16225	16226	16227	16240	16241	16242	16243
Heater Burnout 1 Detection (See note 3.)	16448	16449	16450	16451	16464	16465	16466	16467	16480	16481	16482	16483	16496	16497	16498	16499

Parameter name	Unit 4				Unit 5				Unit 6				Unit 7			
	ch1	ch2	ch3	ch4	ch1	ch2	ch3	ch4	ch1	ch2	ch3	ch4	ch1	ch2	ch3	ch4
HS Alarm 1 (See note 3.)	16704	16705	16706	16707	16720	16721	16722	16723	16736	16737	16738	16739	16752	16753	16754	16755
Heater Overcurrent Detection (See note 3.)	16960	16961	16962	16963	16976	16977	16978	16979	16992	16993	16994	16995	17008	17009	17010	17011

- Note**
- Both the IN Area and the OUT Area can be allocated to parameters that can be changed during operation.
  - TC2 Units cannot use allocations for channel 3 or channel 4.
  - Can be used with TC2 Units, but not TC4 Units.

## Units 8 to 11

Parameter name	Unit 8				Unit 9				Unit 10				Unit 11			
	ch1	ch2	ch3	ch4	ch1	ch2	ch3	ch4	ch1	ch2	ch3	ch4	ch1	ch2	ch3	ch4
Present Bank Set Point	7040	7041	7042	7043	7056	7057	7058	7059	7072	7073	7074	7075	7088	7089	7090	7091
Present Bank Proportional Band	7296	7297	7298	7299	7312	7313	7314	7315	7328	7329	7330	7331	7344	7345	7346	7347
Present Bank Integral Time	7552	7553	7554	7555	7568	7569	7570	7571	7584	7585	7586	7587	7600	7601	7602	7603
Present Bank Derivative Time	7808	7809	7810	7811	7824	7825	7826	7827	7840	7841	7842	7843	7856	7857	7858	7859
Present Bank SP Ramp Rise Value	8064	8065	8066	8067	8080	8081	8082	8083	8096	8097	8098	8099	8112	8113	8114	8115
Present Bank SP Ramp Fall Value	8320	8321	8322	8323	8336	8337	8338	8339	8352	8353	8354	8355	8368	8369	8370	8371
Present Bank Manual Reset Value	8576	8577	8578	8579	8592	8593	8594	8595	8608	8609	8610	8611	8624	8625	8626	8627
Present Bank Cooling Coefficient	8832	8833	8834	8835	8848	8849	8850	8851	8864	8865	8866	8867	8880	8881	8882	8883
Present Bank Dead Band	9088	9089	9090	9091	9104	9105	9106	9107	9120	9121	9122	9123	9136	9137	9138	9139
Present Bank Alarm Value 1	9344	9345	9346	9347	9360	9361	9362	9363	9376	9377	9378	9379	9392	9393	9394	9395
Present Bank Alarm Upper Limit Value 1	9600	9601	9602	9603	9616	9617	9618	9619	9632	9633	9634	9635	9648	9649	9650	9651
Present Bank Alarm Lower Limit Value 1	9856	9857	9858	9859	9872	9873	9874	9875	9888	9889	9890	9891	9904	9905	9906	9907
Present Bank Alarm Value 2	10112	10113	10114	10115	10128	10129	10130	10131	10144	10145	10146	10147	10160	10161	10162	10163
Present Bank Alarm Upper Limit Value 2	10368	10369	10370	10371	10384	10385	10386	10387	10400	10401	10402	10403	10416	10417	10418	10419
Present Bank Alarm Lower Limit Value 2	10624	10625	10626	10627	10640	10641	10642	10643	10656	10657	10658	10659	10672	10673	10674	10675
Present Bank Alarm Value 3	10880	10881	10882	10883	10896	10897	10898	10899	10912	10913	10914	10915	10928	10929	10930	10931
Present Bank Alarm Upper Limit Value 3	11136	11137	11138	11139	11152	11153	11154	11155	11168	11169	11170	11171	11184	11185	11186	11187
Present Bank Alarm Lower Limit Value 3	11392	11393	11394	11395	11408	11409	11410	11411	11424	11425	11426	11427	11440	11441	11442	11443
Input Digital Filter	11648	11649	11650	11651	11664	11665	11666	11667	11680	11681	11682	11683	11696	11697	11698	11699
Input Value 1 for Input Correction	11904	11905	11906	11907	11920	11921	11922	11923	11936	11937	11938	11939	11952	11953	11954	11955
Input Shift 1	12160	12161	12162	12163	12176	12177	12178	12179	12192	12193	12194	12195	12208	12209	12210	12211
Input Value 2 for Input Correction	12416	12417	12418	12419	12432	12433	12434	12435	12448	12449	12450	12451	12464	12465	12466	12467
Input Shift 2	12672	12673	12674	12675	12688	12689	12690	12691	12704	12705	12706	12707	12720	12721	12722	12723
MV at PV Error	12928	12929	12930	12931	12944	12945	12946	12947	12960	12961	12962	12963	12976	12977	12978	12979
MV at Stop	13184	13185	13186	13187	13200	13201	13202	13203	13216	13217	13218	13219	13232	13233	13234	13235
MV Upper Limit	13440	13441	13442	13443	13456	13457	13458	13459	13472	13473	13474	13475	13488	13489	13490	13491
MV Lower Limit	13696	13697	13698	13699	13712	13713	13714	13715	13728	13729	13730	13731	13744	13745	13746	13747
Hysteresis (Heating)	13952	13953	13954	13955	13968	13969	13970	13971	13984	13985	13986	13987	14000	14001	14002	14003
Hysteresis (Cooling)	14208	14209	14210	14211	14224	14225	14226	14227	14240	14241	14242	14243	14256	14257	14258	14259
Alpha	14464	14465	14466	14467	14480	14481	14482	14483	14496	14497	14498	14499	14512	14513	14514	14515
Manual MV	14720	14721	14722	14723	14736	14737	14738	14739	14752	14753	14754	14755	14768	14769	14770	14771
SP Upper Limit	14976	14977	14978	14979	14992	14993	14994	14995	15008	15009	15010	15011	15024	15025	15026	15027
SP Lower Limit	15232	15233	15234	15235	15248	15249	15250	15251	15264	15265	15266	15267	15280	15281	15282	15283
Disturbance Gain	15488	15489	15490	15491	15504	15505	15506	15507	15520	15521	15522	15523	15536	15537	15538	15539
Disturbance Time Constant	15744	15745	15746	15747	15760	15761	15762	15763	15776	15777	15778	15779	15792	15793	15794	15795
Disturbance Rectification Band	16000	16001	16002	16003	16016	16017	16018	16019	16032	16033	16034	16035	16048	16049	16050	16051
Disturbance Judgement Width	16256	16257	16258	16259	16272	16273	16274	16275	16288	16289	16290	16291	16304	16305	16306	16307
Heater Burnout 1 Detection (See note 3.)	16512	16513	16514	16515	16528	16529	16530	16531	16544	16545	16546	16547	16560	16561	16562	16563



Parameter name	Unit 8				Unit 9				Unit 10				Unit 11			
	ch1	ch2	ch3	ch4	ch1	ch2	ch3	ch4	ch1	ch2	ch3	ch4	ch1	ch2	ch3	ch4
HS Alarm 1 (See note 3.)	16768	16768	16769	16770	16784	16785	16786	16787	16800	16801	16802	16803	16816	16817	16818	16819
Heater Overcurrent Detection (See note 3.)	17024	17025	17026	17027	17040	17041	17042	17043	17056	17057	17058	17059	17072	17073	17074	17075

- Note**
- Both the IN Area and the OUT Area can be allocated to parameters that can be changed during operation
  - TC2 Units cannot use allocations for channel 3 or channel 4.
  - Can be used with TC2 Units, but not TC4 Units.

## Units 12 to 15

Parameter name	Unit 12				Unit 13				Unit 14				Unit 15			
	ch1	ch2	ch3	ch4	ch1	ch2	ch3	ch4	ch1	ch2	ch3	ch4	ch1	ch2	ch3	ch4
Present Bank Set Point	7104	7105	7106	7107	7120	7121	7122	7123	7136	7137	7138	7139	7152	7153	7154	7155
Present Bank Proportional Band	7360	7361	7362	7363	7376	7377	7378	7379	7392	7393	7394	7395	7408	7409	7410	7411
Present Bank Integral Time	7616	7617	7618	7619	7632	7633	7634	7635	7648	7649	7650	7651	7664	7665	7666	7667
Present Bank Derivative Time	7872	7873	7874	7875	7888	7889	7890	7891	7904	7905	7906	7907	7920	7921	7922	7923
Present Bank SP Ramp Rise Value	8128	8129	8130	8131	8144	8145	8146	8147	8160	8161	8162	8163	8176	8177	8178	8179
Present Bank SP Ramp Fall Value	8384	8385	8386	8387	8400	8401	8402	8403	8416	8417	8418	8419	8432	8433	8434	8435
Present Bank Manual Reset Value	8640	8641	8642	8643	8656	8657	8658	8659	8672	8673	8674	8675	8688	8689	8690	8691
Present Bank Cooling Coefficient	8896	8897	8898	8899	8912	8913	8914	8915	8928	8929	8930	8931	8944	8945	8946	8947
Present Bank Dead Band	9152	9153	9154	9155	9168	9169	9170	9171	9184	9185	9186	9187	9200	9201	9202	9203
Present Bank Alarm Value 1	9408	9409	9410	9411	9424	9425	9426	9427	9440	9441	9442	9443	9456	9457	9458	9459
Present Bank Alarm Upper Limit Value 1	9664	9665	9666	9667	9680	9681	9682	9683	9696	9697	9698	9699	9712	9713	9714	9715
Present Bank Alarm Lower Limit Value 1	9920	9921	9922	9923	9936	9937	9938	9939	9952	9953	9954	9955	9968	9969	9970	9971
Present Bank Alarm Value 2	10176	10177	10178	10179	10192	10193	10194	10195	10208	10209	10210	10211	10224	10225	10226	10227
Present Bank Alarm Upper Limit Value 2	10432	10433	10434	10435	10448	10449	10450	10451	10464	10465	10466	10467	10480	10481	10482	10483
Present Bank Alarm Lower Limit Value 2	10688	10689	10690	10691	10704	10705	10706	10707	10720	10721	10722	10723	10736	10737	10738	10739
Present Bank Alarm Value 3	10944	10945	10946	10947	10960	10961	10962	10963	10976	10977	10978	10979	10992	10993	10994	10995
Present Bank Alarm Upper Limit Value 3	11200	11201	11202	11203	11216	11217	11218	11219	11232	11233	11234	11235	11248	11249	11250	11251
Present Bank Alarm Lower Limit Value 3	11456	11457	11458	11459	11472	11473	11474	11475	11488	11489	11490	11491	11504	11505	11506	11507
Input Digital Filter	11712	11713	11714	11715	11728	11729	11730	11731	11744	11745	11746	11747	11760	11761	11762	11763
Input Value 1 for Input Correction	11968	11969	11970	11971	11984	11985	11986	11987	12000	12001	12002	12003	12016	12017	12018	12019
Input Shift 1	12224	12225	12226	12227	12240	12241	12242	12243	12256	12257	12258	12259	12272	12273	12274	12275
Input Value 2 for Input Correction	12480	12481	12482	12483	12496	12497	12498	12499	12512	12513	12514	12515	12528	12529	12530	12531
Input Shift 2	12736	12737	12738	12739	12752	12753	12754	12755	12768	12769	12770	12771	12784	12785	12786	12787
MV at PV Error	12992	12993	12994	12995	13008	13009	13010	13011	13024	13025	13026	13027	13040	13041	13042	13043
MV at Stop	13248	13249	13250	13251	13264	13265	13266	13267	13280	13281	13282	13283	13296	13297	13298	13299
MV Upper Limit	13504	13505	13506	13507	13520	13521	13522	13523	13536	13537	13538	13539	13552	13553	13554	13555
MV Lower Limit	13760	13761	13762	13763	13776	13777	13778	13779	13792	13793	13794	13795	13808	13809	13810	13811
Hysteresis (Heating)	14016	14017	14018	14019	14032	14033	14034	14035	14048	14049	14050	14051	14064	14065	14066	14067
Hysteresis (Cooling)	14272	14273	14274	14275	14288	14289	14290	14291	14304	14305	14306	14307	14320	14321	14322	14323
Alpha	14528	14529	14530	14531	14544	14545	14546	14547	14560	14561	14562	14563	14576	14577	14578	14579
Manual MV	14784	14785	14786	14787	14800	14801	14802	14803	14816	14817	14818	14819	14832	14833	14834	14835
SP Upper Limit	15040	15041	15042	15043	15056	15057	15058	15059	15072	15073	15074	15075	15088	15089	15090	15091
SP Lower Limit	15296	15297	15298	15299	15312	15313	15314	15315	15328	15329	15330	15331	15344	15345	15346	15347
Disturbance Gain	15552	15553	15554	15555	15568	15569	15570	15571	15584	15585	15586	15587	15600	15601	15602	15603
Disturbance Time Constant	15808	15809	15810	15811	15824	15825	15826	15827	15840	15841	15842	15843	15856	15857	15858	15859
Disturbance Rectification Band	16064	16065	16066	16067	16080	16081	16082	16083	16096	16097	16098	16099	16112	16113	16114	16115
Disturbance Judgement Width	16320	16321	16322	16323	16336	16337	16338	16339	16352	16353	16354	16355	16368	16369	16370	16371
Heater Burnout 1 Detection (See note 3.)	16576	16577	16578	16579	16592	16593	16594	16595	16608	16609	16610	16611	16624	16625	16626	16627

Parameter name	Unit 12				Unit 13				Unit 14				Unit 15			
	ch1	ch2	ch3	ch4	ch1	ch2	ch3	ch4	ch1	ch2	ch3	ch4	ch1	ch2	ch3	ch4
HS Alarm 1 (See note 3.)	16832	16833	16834	16835	16848	16849	16850	16851	16864	16865	16866	16867	16880	16881	16882	16883
Heater Overcurrent Detection (See note 3.)	17088	17089	17090	17091	17104	17105	17106	17107	17120	17121	17122	17123	17136	17137	17138	17139

- Note**
- Both the IN Area and the OUT Area can be allocated to parameters that can be changed during operation.
  - TC2 Units cannot use allocations for channel 3 or channel 4.
  - Can be used with TC2 Units, but not TC4 Units.

# Appendix C

## List of Connectable Devices

### DeviceNet Communications Unit

Model	Specifications	Manufacturer
EJ1N-HFUB-DRT	DeviceNet Communications Unit for EJ1 Temperature Controllers	OMRON

### EJ1 Temperature Controllers

Model	Specifications					Manufacturer
	Terminal form	Control outputs	Auxiliary outputs	Functions	Number of control points	
EJ1N-TC4A-QQ	M3 terminals	Voltage outputs (for driving SSR): 4	---	---	4	OMRON
EJ1N-TC4B-QQ	Screw-less clamp terminals					OMRON
EJ1N-TC2A-ONHB	M3 terminals	Voltage outputs (for driving SSR): 2 Transistor outputs: 2 (sinking)	---	Heater burnout alarms: 2 Event inputs: 2	2	OMRON
EJ1N-TC2B-QNHB	Screw-less clamp terminals					OMRON
EJ1N-TC2A-CNB	M3 terminals	Current outputs: 2 Transistor outputs: 2 (sinking)	---	Event inputs: 2		OMRON
EJ1N-TC2B-CNB	Screw-less clamp terminals					OMRON
EJ1C-EDUA-NFLK	M3 terminals	---	Transistor output: 2	---	---	OMRON
EJ1C-EDUC-NFLK	Connector					OMRON

### DeviceNet Communications Cables

Model	Specifications	Manufacturer
DCA2-5C10	Thick Cable: 5 wires, 100 m	OMRON
DCA1-5C10	Thin Cable: 5 wires, 100 m	OMRON
DVN18-10G	Thick Cable: 5 wires, 10 m	Nihon Wire & Cable (See note 1.)
DVN18-30G	Thick Cable: 5 wires, 30 m	Nihon Wire & Cable (See note 1.)
DVN18-50G	Thick Cable: 5 wires, 50 m	Nihon Wire & Cable (See note 1.)
DVN18-100G	Thick Cable: 5 wires, 100 m	Nihon Wire & Cable (See note 1.)
DVN18-300G	Thick Cable: 5 wires, 300 m	Nihon Wire & Cable (See note 1.)
DVN18-500G	Thick Cable: 5 wires, 500 m	Nihon Wire & Cable (See note 1.)
DVN24-10G	Thin Cable: 5 wires, 10 m	Nihon Wire & Cable (See note 1.)

Model	Specifications	Manufacturer
DVN24-30G	Thin Cable: 5 wires, 30 m	Nihon Wire & Cable (See note 1.)
DVN24-50G	Thin Cable: 5 wires, 50 m	Nihon Wire & Cable (See note 1.)
DVN24-100G	Thin Cable: 5 wires, 100 m	Nihon Wire & Cable (See note 1.)
DVN24-300G	Thin Cable: 5 wires, 300 m	Nihon Wire & Cable (See note 1.)
DVN24-500G	Thin Cable: 5 wires, 500 m	Nihon Wire & Cable (See note 1.)
1485C-P1-A50	Thick Cable: 5 wires, 50 m	Allen-Bradley (See note 2.)
1485C-P1-C150	Thin Cable: 5 wires, 150 m	Allen-Bradley (See note 2.)
DCA1-5CN□□W1	Cable with shielded micro-size (M12) connectors on both ends (female socket and male plug) Cable length: 0.5 m, 1 m, 2 m, 3 m, 5 m, and 10 m	OMRON
DCA1-5CN□□F1	Cable with shielded micro-size (M12) connector (female socket) on one end Cable length: 0.5 m, 1 m, 2 m, 3 m, 5 m, and 10 m	OMRON
DCA1-5CN□□H1	Cable with shielded micro-size (M12) connector (male plug) on one end Cable length: 0.5 m, 1 m, 2 m, 3 m, 5 m, and 10 m	OMRON
DCA1-5CN□□W5	Cable with shielded connector on both ends (male plug on mini-size end, female socket on micro-size end) Cable length: 1 m, 2 m, 5 m, and 10 m	OMRON
DCA2-5CN□□W1	Cable with shielded mini-size connectors on both ends (female socket and male plug) Cable length: 1 m, 2 m, 5 m, and 10 m	OMRON
DCA2-5CN□□F1	Cable with shielded mini-size connector on one end (female socket) Cable length: 1 m, 2 m, 5 m, and 10 m	OMRON
DCA1-5CN□□H1	Cable with shielded mini-size connector on one end (male plug) Cable length: 1 m, 2 m, 5 m, and 10 m	OMRON

- Note** 1. The cables made by Nihon Wire & Cable Company Ltd. are sold through the OMRON 24 Service Co., Ltd. The product specifications are identical to the OMRON cable specifications.
2. The cables made by Allen-Bradley are stiffer than the cables made by OMRON and Nihon Wire & Cable Company Ltd., so do not bend the Allen-Bradley cables as much as the others.

Other DeviceNet communications cables are available from the following manufacturers. For details, refer to the product catalogs on the ODVA web site (<http://www.odva.astem.or.jp/>) or contact the manufacturer directly.

## DeviceNet Communications Connector

Model	Specifications	Manufacturer
FCK2.5/5-STF-5.08AU	For node connection Screwless type, includes connector set screws	PHOENIX CONTACT

## Crimp Terminals for DeviceNet Communications Cables

Model	Crimper	Remarks	Manufacturer
AI series: AI-0.5-8WH-B for Thin Cable (product code: 3201369)	ZA3	For single-wire insertion	PHOENIX CONTACT
AI series: AI-TWIN2x0.5-8WH for Thin Cable (product code: 3200933)	UD6 (product code: 1204436)	For two-wire insertion (multi-drop wiring)	

## Terminating Resistors for DeviceNet Network

Model	Specifications	Manufacturer
DRS1-T	Terminal-block Terminating Resistor, 121 $\Omega$ $\pm$ 1% 1/4 W	OMRON
DRS2-1	Shielded Terminating Resistor (male plug), micro-size (M12)	
DRS2-2	Shielded Terminating Resistor (female socket), micro-size (M12)	
DRS3-1	Shielded Terminating Resistor (male plug), mini-size	

A Terminating Resistor can also be connected to a T-branch Tap or a one-branch Power Supply Tap.

## T-branch Taps

### One-branch Taps

Model	Specifications	Manufacturer
DCN1-1C	Includes three XW4B-05C1-H1-D parallel connectors with screws (When used on a trunk line, one branch line can be connected.) Connector insertion direction: Horizontal A Terminating Resistor (included as standard) can be connected.	OMRON
DCN1-2C	Includes three XW4B-05C1-H1-D parallel connectors with screws (When used on a trunk line, one branch line can be connected.) Connector insertion direction: Vertical A Terminating Resistor (included as standard) can be connected.	OMRON
DCN1-2R	Includes three XW4B-05C1-VIR-D orthogonal connectors with screws (When used on a trunk line, one branch line can be connected.) Connector insertion direction: Vertical A Terminating Resistor (included as standard) can be connected.	OMRON

### Three-branch Taps

Model	Specifications	Manufacturer
DCN1-3C	Includes five XW4B-05C1-H1-D parallel connectors with screws (When used on a trunk line, three branch lines can be connected.) Connector insertion direction: Horizontal A Terminating Resistor (included as standard) can be connected.	OMRON
DCN1-4C	Includes five XW4B-05C1-H1-D parallel connectors with screws (When used on a trunk line, three branch lines can be connected.) Connector insertion direction: Vertical A Terminating Resistor (included as standard) can be connected.	OMRON
DCN1-4R	Includes five XW4B-05C1-H1-D orthogonal connectors with screws (When used on a trunk line, three branch lines can be connected.) Connector insertion direction: Vertical A Terminating Resistor (included as standard) can be connected.	OMRON

## Shielded T-branch Connectors

Model	Specifications	Manufacturer
DCN2-1	One-branch shielded T-branch connectors, three micro-size (M12) connectors	OMRON
DCN3-11	One-branch shielded T-branch connectors, three mini-size connectors	
DCN3-12	One-branch shielded T-branch connectors, two mini-size connectors and one micro-size (M12) connector	

## One-branch Power Supply Tap

Model	Specifications	Manufacturer
DCN-1P	<p>One-branch tap for power supply. Use this tap when connecting a communications power supply.</p> <p>Includes two XW4B-05C1-H1-D parallel connectors with screws and two fuses as standard.</p> <p>A Terminating Resistor (included as standard) can be connected.</p>	OMRON

# Index

## A

attribute ID, 105

## B

baud rate, 9  
  automatic detection, 3

## C

cables  
  communications cables  
    models, 169  
class ID, 105  
cleaning, 139  
command block, 105  
commands  
  sending to Temperature Controllers, 91  
communications  
  cycle time, 131  
  DeviceNet remote I/O, 126  
  distance, 9  
  explicit messages, 5  
  functions, 4  
  media, 9  
  message communications time, 134  
  performance, 125  
  power supply, 9  
  refresh time, 132  
  specifications, 9  
  timing, 125  
Communications Cables, 169  
Communications Connectors, 170  
Communications Unit comment  
  setting, 86  
CompoWay/F, 2, 5, 105  
  command examples, 112  
  sending commands, 108  
Configurator, 2, 6  
  connecting, 85  
  I/O allocations, 18  
  procedures, 83  
connectors, 22  
  attaching, 32  
  models, 170  
copy operation  
  DIP switch, 25

crimp terminals, 32, 171  
  models, 171

## D

decimal point position, xvi  
destination node address, 105  
device profiles, 146  
DeviceNet Communications Unit, 169  
dimensions, 22  
DIN Rail  
  mounting, 28

## E

EMC Directives, xii  
End Plates  
  removing, 30  
error codes, 107  
error control, 10  
error history, 100  
explicit messages, 2, 5  
  basic format, 105  
  communications time, 134  
  error codes, 107  
  example, 118  
  General Status Read, 120  
  Maintenance Counter Save, 120  
  overview, 104  
  sending, 119  
  Set Value for Unit Conduction Time or Total RUN Time, 121  
  Temperature Controller Channel Maintenance Information Monitor Mode, 121  
  types, 105  
  Unit Conduction Time or Total RUN Time Read, 121  
  Unit Maintenance Bit, 120  
  Unit Maintenance Present Value, 120  
  Unit Maintenance Set Value, 120

## F

features, 2  
FINS-mini commands, 111  
fixed allocations, 44, 73



**I**

I/O allocations, 17  
  data configuration, 41  
  master, 44, 73  
  procedure, 39  
  remote I/O communications, 36  
  simple allocation, 40  
  simple allocations, 37  
  using the Configurator, 18, 38, 45  
I/O response time, 126  
IN area, 50  
  dividing in two, 75  
indicators, 22, 23  
  troubleshooting, 138  
input data, 59  
inspection, 140  
installation, 27  
instance ID, 105, 122

**L**

Last Maintenance Date  
  setting, 89  
Low Voltage Directive, xii

**M**

maintenance, 97, 137, 139  
  functions, 3  
  information, 99  
  replacing Units, 140  
Maintenance Counter, 100  
message communications time, 134  
model numbers, 169  
module status  
  indicator, 23  
Monitor Mode  
  setting, 95  
monitoring, 2, 102  
mounting, 29  
MS indicator, 23  
multivendor connections, 145  
MV Upper Limit/Lower Limit  
  changing, 80

**N**

Network Power Voltage Monitor  
  setting, 87  
network status  
  indicator, 23  
node address  
  setting, 24  
NS indicator, 23  
Number of Bytes Received, 106

**O**

One-branch Power Supply Taps, 172  
One-branch Taps, 171  
operation, 2  
  procedures, 15  
ordering information, 169  
OUT area, 48

**P**

parameters  
  copying, 90  
  editing, 85, 93  
  reading and writing, 5  
part names, 22  
PFP-100N, 29  
PFP-50N, 29  
PFP-M, 29  
power supply, 10, 12  
products, 169  
programming  
  examples, 78  
PV  
  reading, 115

**R**

refresh time, 132  
remote I/O communications, 2, 4, 35, 126  
replacing Units, 140  
response block, 106  
RUN/STOP Bits, 73

## S

- service code, 105, 106
- setup, 2
  - monitoring, 95
  - parameters, 6
  - procedure, 16
  - Temperature Controller Parameters, 13
  - using explicit messages, 13
- Shielded T-branch Connectors, 172
- Source Node Address, 106
- SP
  - changing, 79
  - writing, 112
- specifications, 9
  - DeviceNet, 146
- startup time, 133
- switches, 22
  - settings, 24
- system configuration, 7

## T

- T-branch Taps, 171
  - models, 171
- Temperature Controller Comments
  - setting, 95
- Temperature Controller IDs, 11
- Temperature Controllers, 169
  - communications status
    - indicator, 24
  - editing parameters, 93
  - initial settings, 13
  - number, 11
  - registration, 12
  - sending commands, 91
- Terminating Resistors, 171
  - models, 171
- Three-branch Taps, 171
- troubleshooting, 137
- TS indicator, 24

## U

- Unit Conduction Time Monitor
  - setting, 88
- Unit status, 61
- user-set allocations, 45, 73



## Revision History

A manual revision code appears as a suffix to the catalog number on the front cover of the manual.

Cat. No. H155-E1-01A



Revision code

The following table outlines the changes made to the manual during each revision. Page numbers refer to the previous version.

Revision code	Date	Revised content
01	January 2008	Original production
01A	March 2008	<b>Pages 2, 19, 37, and 39:</b> Removed reference to the rear panel in descriptions of the simple I/O allocation function. <b>Page 36:</b> Corrected missing lines in PLC illustration.