

OMRON



User's Manual

Cat. No. H078-E1-03D

Preface

Thank you for your purchase of your E5CK compact, intelligent digital controller. The E5CK allows the user to carry out the following:

- Select from many types of temperature and analog input (multiple input)
- Select output functions such as control output or alarm (output assignment)
- Use two setpoints (multi-SP function)
- Monitor the control loop by LBA (Loop Break Alarm)
- Use the communications function
- Calibrate input or transfer output
- It also features a watertight construction (NEMA4: equivalent to IP66)

This User's Manual describes how to use the E5CK compact, high-function digital controller.

Before using your E5CK, thoroughly read and understand this manual in order to ensure correct use.

About this manual

© OMRON, 1995

- (1) All rights reserved. No part of this publication may be reproduced, stored in a retrieval system, or transmitted, in any form, or by any means, mechanical, electronic, photocopying, recording, recording, or otherwise, without the prior written permission of OMRON.
- (2) No patent liability is assumed with respect to the use of the information contained herein.
- (3) Moreover, because OMRON is constantly striving to improve its high-quality products, the information in this manual is subject to change without notice. Every precaution has been taken in the preparation of this manual. Nevertheless, OMRON assumes no responsibility for errors or omissions. Neither is any liability assumed for damages resulting from the use of the information contained in this publication.

Conventions Used in This Manual

■ How to Read Display Symbols

The following tables show the correspondence between the symbols displayed on the displays and alphabet characters.

A	B	C	D	E	F	G	H	I	J	K	L	M
Ⓐ	Ⓑ	Ⓒ	Ⓓ	Ⓔ	Ⓕ	Ⓖ	Ⓗ	Ⓘ	⓵	⓶	⓷	⓸

N	O	P	Q	R	S	T	U	V	W	X	Y	Z
⓹	⓺	⓻	⓼	⓽	⓾	⓿	⓫	⓬	⓭	⓮	⓯	⓰

■ “Reference” mark

This mark indicates that extra, useful information follows, such as supplementary explanations and how to apply functions.



■ Notice:

OMRON products are manufactured for use according to proper procedures by a qualified operator and only for the purposes described in this manual.

The following conventions are used to indicate and classify precautions in this manual. Always heed the information provided with them. Failure to heed precautions can result in injury to people or damage to the product.

 **DANGER**

Indicates information that, if not heeded, is likely to result in loss of life or serious injury.

 **WARNING**

Indicates information that, if not heeded, could possibly result in loss of life or serious injury.

 **Caution**

Indicates information that, if not heeded, could result in relatively serious or minor injury, damage to the product, or faulty operation.

■ OMRON Product References

All OMRON products are capitalized in this manual. The word “Unit” is also capitalized when it refers to an OMRON product, regardless of whether or not it appears in the proper name of the product.

The abbreviation “Ch,” which appears in some displays and on some OMRON products, often means “word” and is abbreviated “Wd” in documentation in this sense.

The abbreviation “PC” means Programmable Controller and is not used as an abbreviation for anything else.

■ How this Manual is Organized

Purpose	Title	Description
Learning about the general features of the E5CK	Chapter 1 Introduction	This chapter describes the features of the E5CK, names of parts, and typical functions.
Setting up the E5CK	Chapter 2 Preparations	This chapter describes the operations that you must carry out (e.g. installation, wiring and switch settings) before you can use the E5CK.
Basic E5CK operations	Chapter 3 Basic Operation Chapter 5 Parameters	These chapters describe how to use the front panel keys and how to view the display when setting the parameters of the major functions for the E5CK.
Applied E5CK operations	Chapter 4 Applied Operation Chapter 5 Parameters	These chapters describe the important functions of the E5CK and how to use the parameters for making full use of the E5CK.
Communications with a host computer	Chapter 6 Using the Communications Function	This chapter mainly describes the communications commands, and gives program examples.
Calibration	Chapter 4 Applied Operation / 4.5 Calibration	This chapter describes how the user should calibrate the E5CK.
Troubleshooting	Chapter 7 Troubleshooting	This chapter describes what to do if any problems occur.

Pay Attention to the Following when Installing this Controller

- If you remove the controller from its case, never touch nor apply shock to the electronic parts inside.
- Do not cover the top and bottom of the controller. (Ensure sufficient space around the controller to allow heat to escape.)
- Use a voltage (AC100-240V \sim or AC/DC24V \approx at 50 to 60 Hz). At power ON, the prescribed voltage level must be attained within two seconds.
- When wiring input or output lines to your controller, keep the following points in mind to reduce the influence from inductive noise:
 - Allow adequate space between the high voltage/current power lines and the input/output lines.
 - Avoid parallel or common wiring with high voltage sources and power lines carrying large currents.
 - Using separating pipes, duct, and shielded line is also useful in protecting the controller, and its lines from inductive noise.
- Allow as much space as possible between the controller and devices that generate a powerful, high frequency (high-frequency welders, high-frequency sewing machines, and so forth) or surge. These devices may cause malfunctions.
- If there is a large power-generating peripheral device and any of its lines, attach a surge suppressor or noise filter to the device to stop the noise affecting the controller system. In particular, motors, transformers, solenoids and magnetic coils have an inductance component, and therefore can generate very strong noises.
- When mounting a noise filter, be sure to first check the filter's voltage and current capacity, then mount the filter as close as possible to the controller.
- Do not use the controller in places where icing, condensation, dust, corrosive gas (especially sulfurized gas or ammonia gas), shock, vibration, splashing liquid, or oil atmosphere occur. Also, avoid places where the controller can be subjected to intense heat radiation (like from a furnace) or sudden temperature changes.
- Ambient temperature must be kept between -10°C to 55°C . Ambient humidity must be kept between 35%RH to 85%RH (with no icing or condensation). If the controller is installed inside a control board, the ambient temperature must be kept under 55°C , including the temperature around the controller. If the controller is subjected to heat radiation, use a fan to cool the surface of the controller to under 55°C .
- Store the controller at an ambient temperature between -25°C to 65°C . The ambient humidity must be between 35%RH to 85%RH (with no icing or condensation).
- Never place heavy objects on, or apply pressure to the controller that may cause it to deform and deterioration during use or storage.
- Avoid using the controller in places near a radio, television set, or wireless installation. These devices can cause radio disturbances which adversely affect the performance of the controller.

Table of Contents

Preface	I
Conventions Used in This Manual	II
Pay Attention to the Following when Installing this Controller	IV

CHAPTER 1 INTRODUCTION 1-1

This chapter introduces the E5CK. First-time users should read this chapter without fail.
For details on how to use the controller and parameter settings, see Chapters 2 onwards.

1.1 Names of parts	1-2
1.2 Input and Output	1-4
1.3 Parameters and Menus	1-6
1.4 About the Communications Function	1-9
1.5 About Calibration	1-10

CHAPTER 2 PREPARATIONS 2-1

This chapter describes the operations you should carry out before turning the E5CK ON.

2.1 Setting up	2-2
2.2 Installation	2-4
2.3 Wiring Terminals	2-6

CHAPTER 3 BASIC OPERATION 3-1

This chapter describes an actual example for understanding the basic operation of the E5CK.

3.1 Control Example	3-2
3.2 Setting Input Specifications	3-3
3.3 Setting Output Specifications	3-5
3.4 Setting Alarm Type	3-7
3.5 Protect Mode	3-10
3.6 Starting and Stopping Operation	3-11
3.7 Adjusting Control Operation	3-12

CHAPTER 4 APPLIED OPERATION 4-1

This chapter describes each of the parameters required for making full use of the features of the E5CK. Read this chapter while referring to the parameter descriptions in chapter 5.

4.1 Selecting the Control Method	4-2
4.2 Operating Condition Restrictions	4-4
4.3 How to Use Option Functions	4-7
4.4 LBA	4-9
4.5 Calibration	4-11

CHAPTER 5 PARAMETERS 5-1

This chapter describes the parameters of the E5CK. Use this chapter as a reference guide.

Conventions Used in this Chapter	5-2
Protect Mode	5-3
Manual Mode	5-5
Level 0 Mode	5-6
Level 1 Mode	5-9
Level 2 Mode	5-15
Setup Mode	5-21
Expansion Mode	5-27
Option Mode	5-32
Calibration Mode	5-36

CHAPTER 6 USING THE COMMUNICATIONS FUNCTION . 6-1

This chapter mainly describes communications with a host computer and communications commands.

6.1 Outline of the Communications Function	6-2
6.2 Preparing for Communications	6-3
6.3 Command Configuration	6-5
6.4 Commands and Responses	6-6
6.5 How to Read Communications Error Information	6-10
6.6 Program Example	6-12

CHAPTER 7 TROUBLESHOOTING 7-1

This chapter describes how to find out and remedy the cause if the E5CK does not function properly.

7.1 Initial Checks	7-2
7.2 How to Use the Error Display	7-3
7.3 How to Use Error Output	7-5
7.4 Checking Operation Restrictions	7-6

APPENDIX

SPECIFICATIONS	A-2
CONTROL BLOCK DIAGRAM	A-5
SETTING LIST	A-6
PARAMETER OPERATIONS LIST	A-8
FUZZY SELF-TUNING	A-10
MODEL LIST	A-13
X FORMAT	A-14
ASCII CODE LIST	A-17

INDEX

REVISION HISTORY

K CHAPTER 1

INTRODUCTION

This chapter introduces the E5CK. First-time users should read this chapter without fail.

For details on how to use the controller and parameter settings, see Chapters 2 onwards.

1.1	Names of parts	1-2
	Main parts	1-2
	Front panel	1-2
	About the displays	1-3
	How to use keys	1-3
1.2	Input and Output	1-4
	Input	1-4
	Output	1-5
1.3	Parameters and Menus	1-6
	Parameter types	1-6
	Selecting modes	1-7
	Selecting parameters	1-8
	Fixing settings	1-8
1.4	About the Communications Function	1-9
1.5	About Calibration	1-10

1.1 Names of parts

■ Main parts

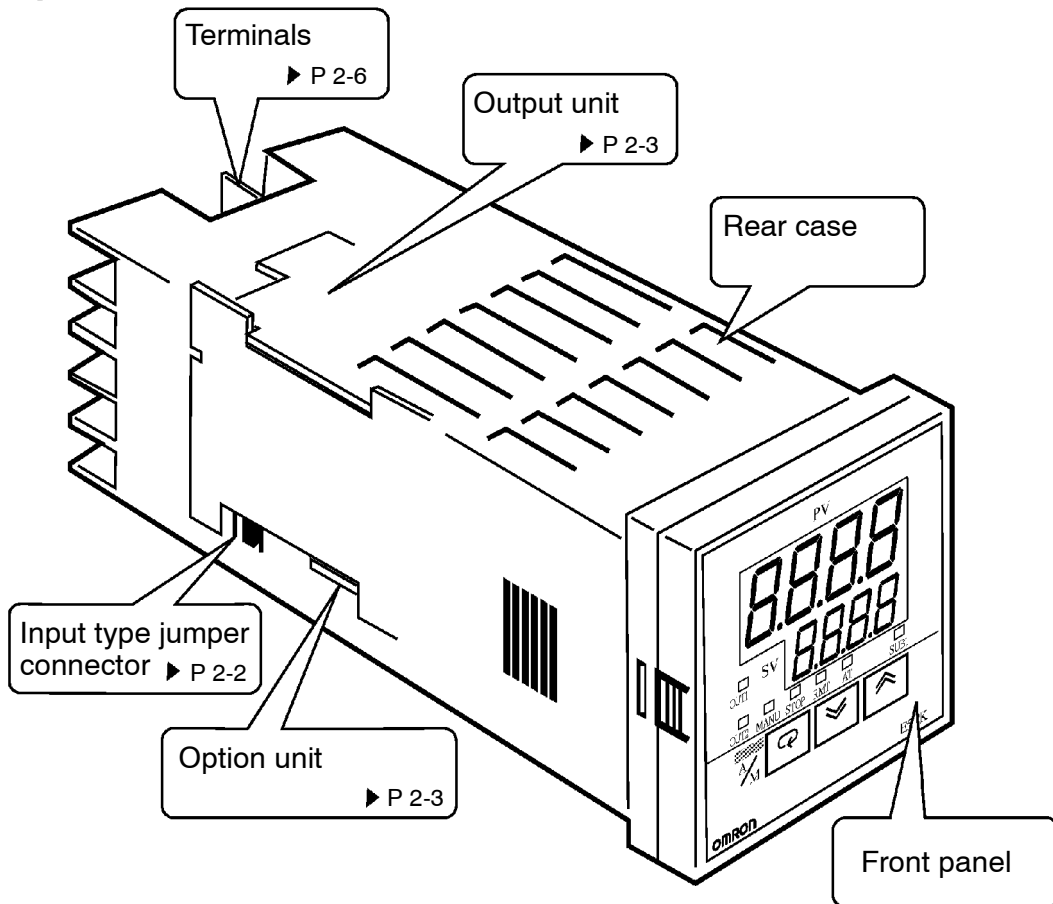

■ Front panel

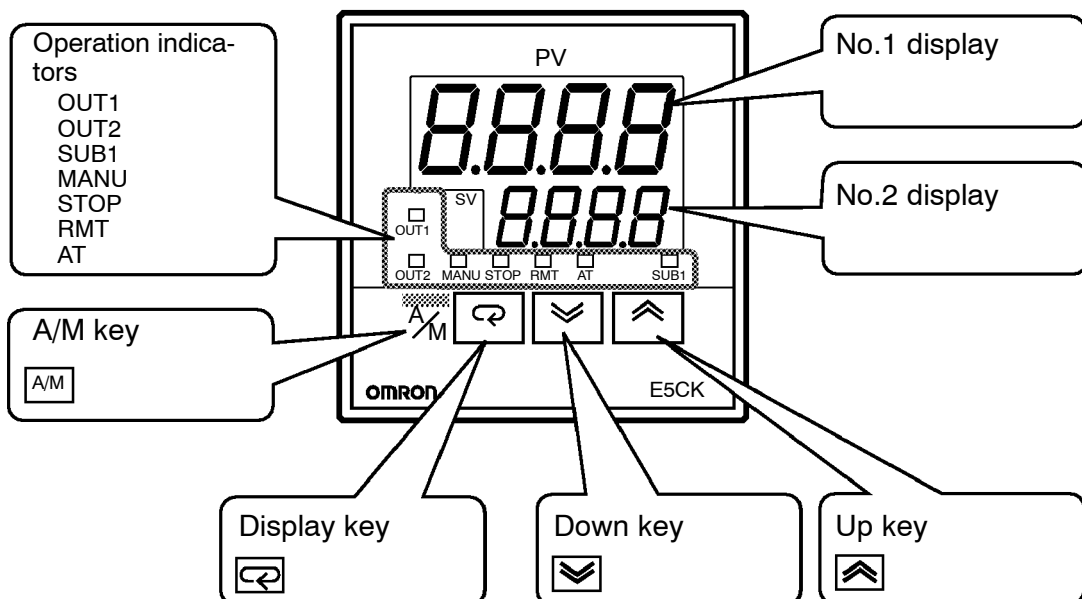







■ About the displays

- **No.1 display** Displays the process value or parameter symbols.
- **No.2 display** Displays the set point, manipulated variable or parameter settings.
- **Operation indicators**
 - OUT1 : Lits when the pulsed output function assigned to “control output 1” is ON.
 - OUT2 : Lits when the output function assigned to “control output 2” is ON.
 - SUB1 : Lits when the output function assigned to “auxiliary output 1” is ON.
 - MANU : Lits in the manual operation mode.
 - STOP : Lits when operation has stopped.
 - RMT : Lits during remote operation.
 - AT : Flashes during auto-tuning.

■ How to use keys

The following describes basic key operations.

-  **key** Each press of this key switches between the auto and manual operations.
-  **key** The functions of this key change according to how long it is pressed. If the key is pressed for less than one second, the parameters are switched. If the key is pressed for one second or more, the menu display appears. In key operations from here on, “press the key” refers to pressing the key for less than one second.
For details on parameter switching and menu display items, see page 1 – 7.
-   **key** Each press of the  key increments or advances the values or settings on the No.2 display, while each press of the  key decrements or returns the values or settings on the No.2 display.

Functions vary, for example, when the  key is held down simultaneously with the display key, or a key is held down continuously. For details, see page 1-7. Also, chapters 3 and 4 describe examples using various key combinations.

1.2 Input and Output

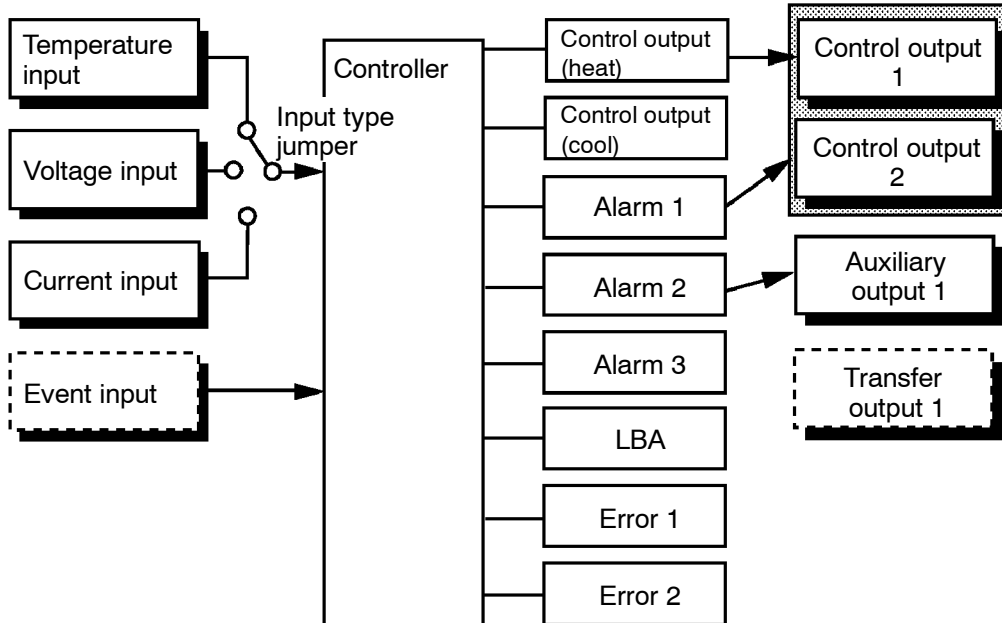

■ Input

The E5CK supports four inputs.

● Temperature input/Voltage input/Current input

- Only one of temperature input, voltage input and current input can be selected and connected to the controller. The above figure shows temperature input connected to the controller.
- The following input sensors can be connected for temperature input:
Thermocouple: K, J, T, E, L, U, N, R, S, B, W, PLII
Platinum resistance thermometer: JPt100, Pt100
- The following currents can be connected for current input:
4 to 20 mA, 0 to 20 mA
- The following voltages can be connected for voltage input:
1 to 5 VDC, 0 to 5 VDC, 0 to 10 VDC

● Event input

When using event input, add on the input unit (E53-CKB).

You can select from the following five event inputs:

Multi-SP
Run/Stop
Auto/Manual

■ Output

The E5CK supports the following four outputs.

- Control output 1
- Control output 2
- Auxiliary output 1
- Transfer output

When using control outputs 1 and 2, set the output unit (sold separately). Eight output units are available to suit the output circuit configuration. When using transfer output, add on the communication unit (E53–CKF).

Note: The output functions of the E5CK do not operate for five seconds after the E5CK is turned ON.

● Output assignments

The E5CK supports the following eight output functions.

- Control output (heat)
- Control output (cool)
- Alarms 1 to 3
- LBA
- Error 1 (input error)
- Error 2 (A/D converter error)

Assign these output functions to control outputs 1 and 2 and auxiliary output 1.

Only control output (heat), control output (cool), alarms 1 to 3, and LBA can be assigned to control outputs 1 and 2. Also, only alarms 1 to 3, LBA, and errors 1 and 2 can be assigned to auxiliary output 1.

In the example on the previous page, “control output (heat)” is assigned to “control output 1”, “alarm 1” is assigned to “control output 2”, and “alarm 2” is assigned to “auxiliary output 1”. Accordingly, the configuration is such that heating control output is connected to control output 1, and alarm output is connected to control output 2 and auxiliary output 1.

In a heating and cooling control, assign “control output (cool)” to either of “control output 1” or “control output 2”.

● Transfer output

The E5CK supports the following five transfer outputs.

- Set point
- Set point during SP ramp
- Process value
- Heating side manipulated variable
- Cooling side manipulated variable

These transfer outputs can be output after being scaled. Setting of an upper limit value smaller than the lower limit value is allowed, so reverse scaling can also be carried out.

1.3 Parameters and Menus

■ Parameter types

E5CK parameters are distributed between the following nine modes.

- Protect mode
- Manual mode
- Level 0 mode
- Level 1 mode
- Level 2 mode
- Setup mode
- Expansion mode
- Option mode
- Calibration mode

The settings of parameters in each of seven modes (excluding the protect mode and manual mode) can be checked and modified by selection on the menu display.

● Protect mode

This mode is used to limit use of the menu and $\boxed{A/M}$ keys. The protect function is for preventing unwanted modification of parameters and switching between the auto and manual operation.

● Manual mode

In this mode, the controller can be switched manual operation. The manipulated variable can be manipulated manually only in this mode.

● Level 0 mode

Set the controller to this mode during normal operation. In this mode, you may change the set point during operation, and stop and start operation. You can also monitor (not change) the process value, ramp SP and manipulated variable.

● Level 1 mode

This is the main mode for adjusting control. In this mode, you can execute AT (auto-tuning), and set alarm values, the control period and PID parameters.

● Level 2 mode

This is the auxiliary mode for adjusting control. In this mode, you can set the parameters for limiting the manipulated variable and set point, switch between the remote and local modes, and set the loop break alarm (LBA), alarm hysteresis and the digital filter value of inputs.

● Setup mode

This is the mode for setting the basic specifications. In this mode, you can set parameters that must be checked or set before operation such as the input type, scaling, output assignments and direct/reverse operation.

● Expansion mode

This is the mode for setting expanded functions. In this mode, you can set ST (self-tuning), SP setting limiter, selection of advanced PID or ON/OFF control, specification of the standby sequence resetting method, initialization of parameters, time for automatic return to the monitoring display.

● **Option mode** This is the mode for setting option functions. You can select this mode only when the option unit is set in the controller. In this mode, you can set the communications conditions, transfer output and event input parameters to match the type of option unit set in the controller.

● **Calibration mode** This mode is provided so that the user can calibrate inputs and transfer output.
When calibrating input, the selected input type is calibrated. Whereas, transfer output can be calibrated only when the communications unit (E53-CKF) is set in the controller.

■ **Selecting modes** The following diagram shows the order in which modes are selected.

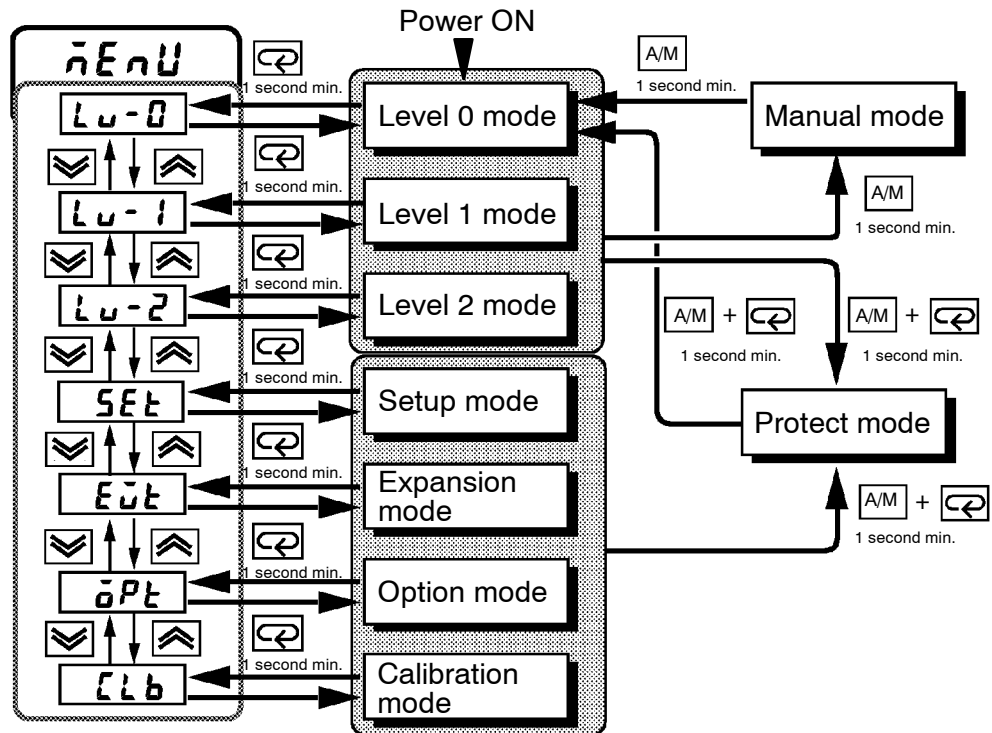

● **Menu display**

- To select the menu display in any of the above modes (excluding the protect mode and manual mode), press the key for 1 second minimum. If you select the desired mode using the or keys and press the key, the top parameter in the specified mode is displayed.
- When you have selected the menu display, the previous mode is selected. For example, if you selected the menu display while in the level 0 mode, the No.2 display changes to [Lu-0] as shown on the left.
- Protected modes cannot be selected. Also, the menu display does not appear when modes are protected up to the level 1 mode.





● **Level 0 to 2 modes**

- If you select [Lu-0] [Lu-1] or [Lu-2] in the menu display, the level 0, level 1 and level 2 modes, respectively, are selected.
- These modes are selected with control still continuing.



- **Setup mode**
- **Expansion mode**
- **Option mode**
- **Calibration mode**

- If you select [*SET*] [*EXT*] [*OPT*] or [*LIB*] in the menu display, the setup, expansion, option and calibration modes, respectively, are selected.
- When these modes are selected, the control is reset. So, control outputs and auxiliary output are turned OFF. When another mode is selected while in these modes, reset is canceled.



- **Protect mode**

- To set the controller to the protect mode or to return to the level 0 mode from the protect mode, press the  key and  key for 1 second minimum simultaneously.

- **Manual mode**





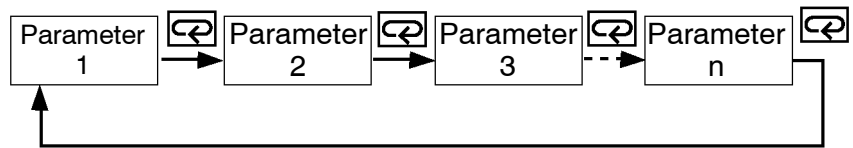

- To set the controller to the manual mode, press the  key for 1 second minimum in the level 0 to 2 mode. To return to the level 0 mode from the manual mode, press the  key for 1 second minimum.

■ Selecting parameters

- When not in the manual mode, each press of the  key switches the parameter.
- If you press the  key when at the final parameter, the display returns to the first parameter.



■ Fixing settings

- When you have changed a parameter setting, specify the parameter using the  or  keys, and either leave the setting for at least two seconds or press the  key. This fixes the setting.
- When another mode is selected, the content of the parameters before the mode was selected is fixed.
- When turning the power OFF, you must first fix the settings and parameter contents (by pressing the  key or selecting another mode). The settings and parameter contents are sometimes not changed by merely pressing the  or  keys.

1.4 About the Communications Function

The E5CK can be provided with a communications function that allows you to check and set controller parameters from a host computer. If the communications function is required, add on the communications unit. For details on the communications function, refer to Chapter 6.

- **RS-232C**

When using the communications function on the RS-232C interface, add on the communications unit (E53-CK01).

- **RS-485**

When using the communications function on the RS-485 interface, add on the communications unit (E53-CK03).

1.5 About Calibration

The E5CK controller is calibrated before shipment from the factory. So, the user need not calibrate the E5CK controller during regular use.

However, if the E5CK controller must be calibrated by the user, use the parameters provided for user to calibrate temperature input, analog input (voltage, current) and transfer output.

Also, note that calibration data is updated to the latest value each time the E5CK controller is calibrated. Calibration data set before shipment from the factory cannot be returned to after calibration by the user.

● Calibrating inputs

The input type selected in the parameter is the item to be calibrated. The E5CK is provided with the following four calibration parameters.

- Thermocouple
- Platinum resistance thermometer
- Current input
- Voltage input

Two parameters are provided for thermocouple and voltage input.

● Calibrating transfer output

Transfer output can be calibrated when the communications unit (E53-CKF) is added on.

● Registering calibration data

When calibrating each item, the calibration data is temporarily registered. This data can be registered as final calibration data only when all items have been newly calibrated. So, all items must be temporarily registered when calibrating the E5CK controller.

When registering data, information regarding whether or not calibration has been carried out is also registered.

To calibrate these items, the user must prepare separate measuring devices and equipment. For details on handling these measuring devices and equipment, refer to the respective manuals.

For details, see 4.5 Calibration (page 4–11).

K CHAPTER 2

PREPARATIONS

This chapter describes the operations you should carry out before turning the E5CK ON.

2.1	Setting up	2-2
	Draw-out	2-2
	Setting the input type	2-2
	Setting up the output unit	2-3
	Setting up the option unit	2-3
2.2	Installation	2-4
	Dimensions	2-4
	Panel cutout	2-4
	Mounting	2-5
2.3	Wiring Terminals	2-6
	Terminal arrangement	2-6
	Precautions when wiring	2-6
	Wiring	2-6

2.1 Setting up

This section describes how to set the input type jumper, and set up the output unit or option unit.

■ Draw-out

First, draw out the internal mechanism from the housing

- (1) Pull out the internal mechanism while pressing the hooks on the left and right sides of the front panel.
- (2) Draw out the internal mechanism towards you holding both sides of the front panel.

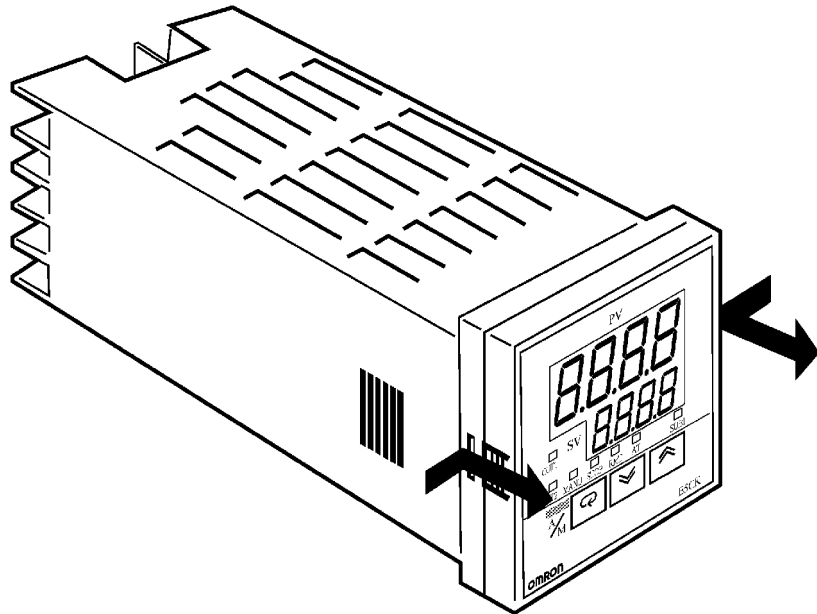

■ Setting the input type

- For details on the jumper connector position, see page 1-2.
- Set the input type jumper connector to one of temperature input, voltage input or current input matched to the sensor connected to the input terminal.

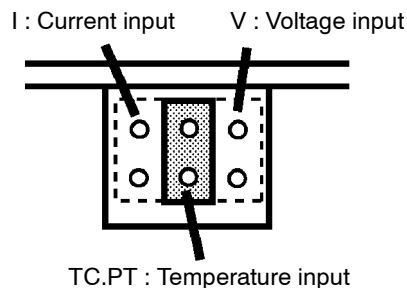

- The factory setting is “TC/PT (temperature input).”
- When removing or inserting the jumper connector, do not touch the pins directly with your fingers.
- When you have set the jumper connector, insert the internal mechanism into the rear case.
- When inserting the internal mechanism, push in until you hear the hooks on the front panel click into place.

■ Setting up the output unit

● Output unit list

The following table shows the output units that can be set in the E5CK controller.

Model	Specifications (control output 1/control output 2)
E53-R4R4	Relay/Relay
E53-Q4R4	Voltage (NPN)/Relay
E53-Q4HR4	Voltage (PNP)/Relay
E53-C4R4	4 to 20 mA/Relay
E53-C4DR4	0 to 20 mA/Relay
E53-V44R4	0 to 10 V/Relay
E53-Q4Q4	Voltage (NPN)/Voltage (NPN)
E53-Q4HQ4H	Voltage (PNP)/Voltage (PNP)

● Setup

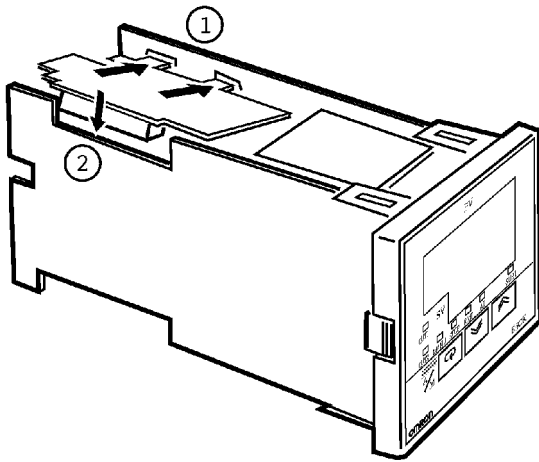

- (1) Two rectangular holes for slotting are provided on the power board (on right side of controller). Fit the two protrusions on the output unit into these two holes.
- (2) With the output unit fitted into the power board, fit the output unit into the connector on the control board (on left side of controller).

■ Setting up the option unit

● Option unit list

The following table shows the option units that can be connected to the E5CK controller.

Unit	Model	Specifications
Communications unit	E53-CK01	Communications (RS-232C)
Communications unit	E53-CK03	Communications (RS-485)
Input unit	E53-CKB	Event input: 1 input
Communications unit	E53-CKF	Transfer output: 4 to 20 mA

● Setup

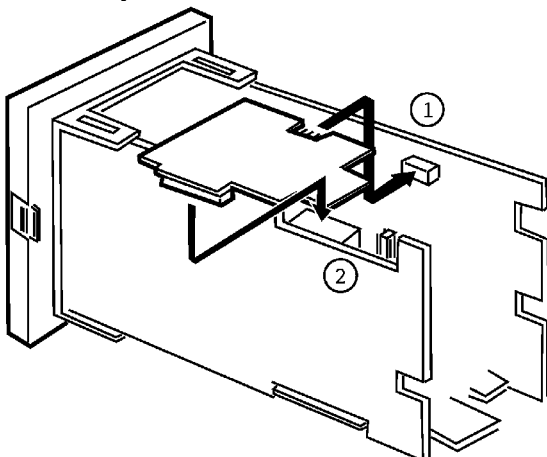

- (1) Place the controller with its bottom facing up, and fit the board horizontally into the connector on the power board (on right side of controller).
- (2) With the power board connected, fit the board vertically into the connector on the control board (on left side of controller).

2.2 Installation

■ Dimensions

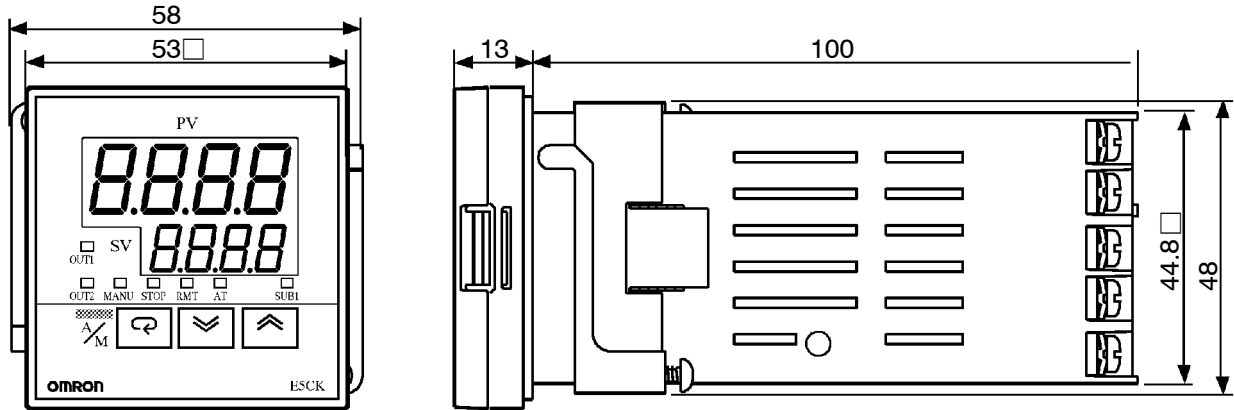

■ Panel cutout

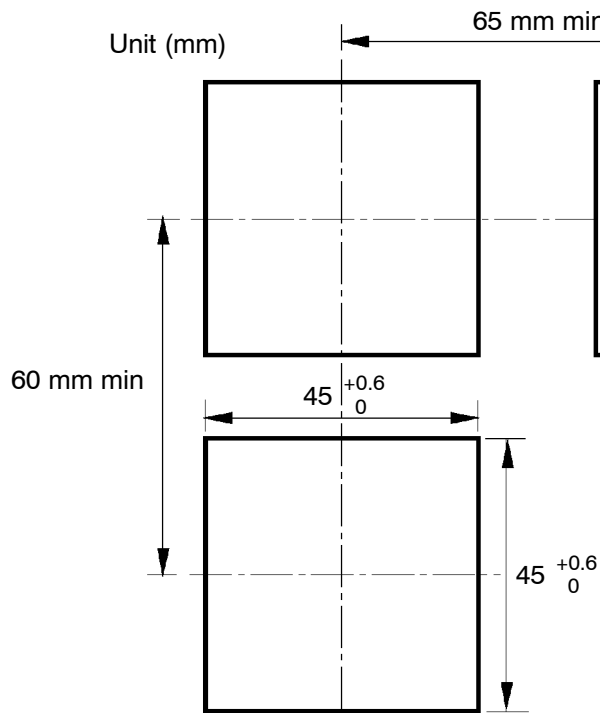

- Recommended panel thickness is 1 to 5 mm.
- Maintain the specified vertical and horizontal mounting space between each controller.
Controllers must not be closely mounted vertically or horizontally.

■ Mounting

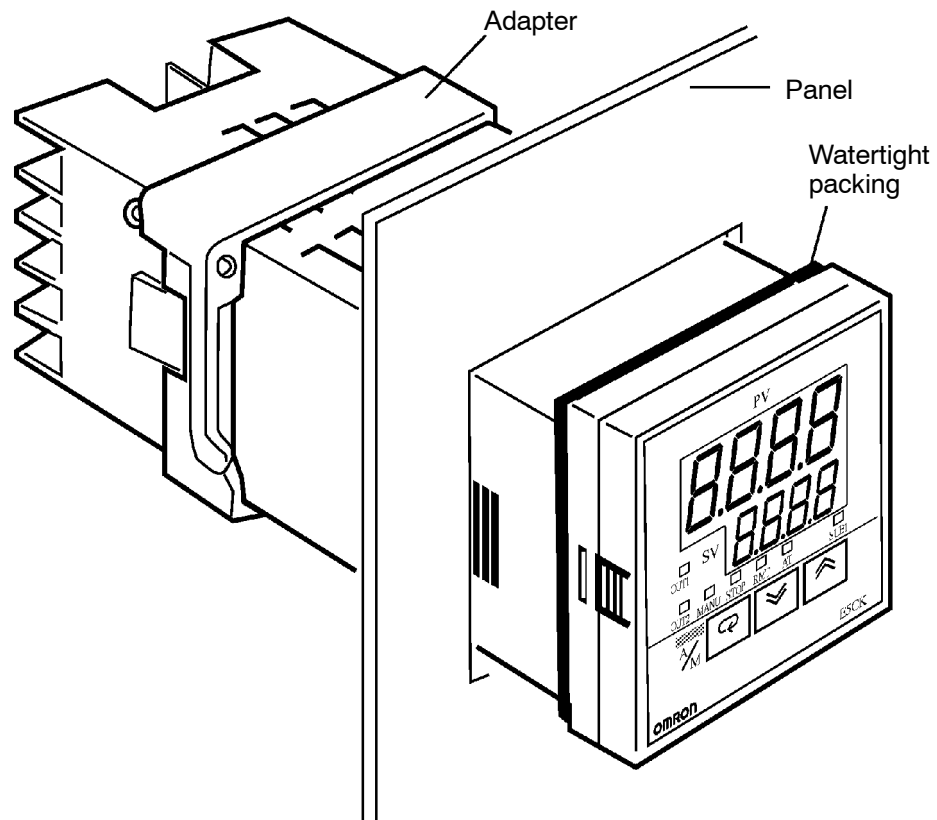

- (1) Insert the E5CK controller into the mounting hole in the panel at the position shown in the figure above.
- (2) Push the adapter along the controller body from the terminals up to the panel, and fasten temporarily.
- (3) Tighten the two fixing screws on the adapter. When tightening screws, tighten the two screws alternately keeping the torque to approximately 0.29 to 0.39 N·m, or 3 to 4 kgf·cm.



About the Terminal Cover

E5CK-AA1-500 controller is provided with a terminal cover (E53-COV07). Fasten the terminal cover as follows by using the snap pin.

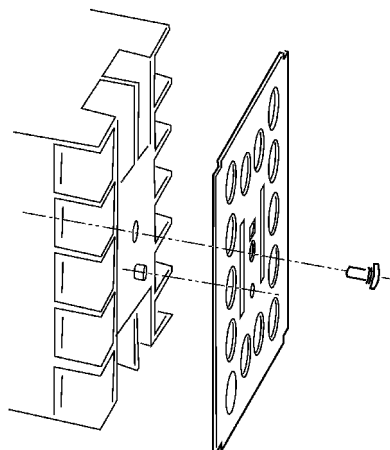

2.3 Wiring Terminals

Terminal arrangement

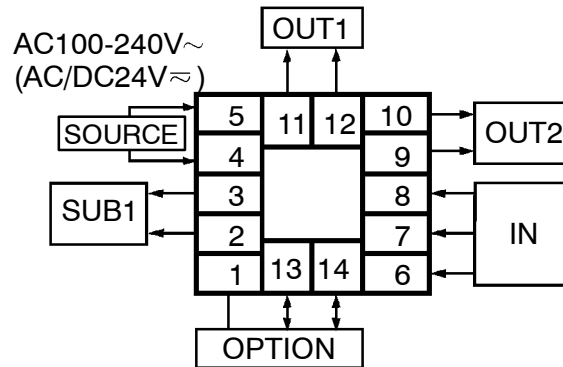

Precautions when wiring

- Use ducts to separate input leads and power lines in order to protect the controller and its lines from external noise.
- We recommend using solderless terminals when wiring the controller.
- Tighten the terminal screws using a torque no greater than 0.78 N·m, or 8 kgf·cm max. Take care not to tighten the terminal screws too tightly.
- Use the following type of solderless terminals for M3.5 screws.

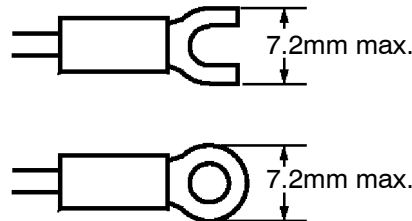

Wiring

Power supply

5	11	12	10
4			9
3			8
2			7
1	13	14	6

In the following wiring diagrams, the left side of the terminal Nos. indicates the inside of the controller

- Input power to terminal Nos. 4 and 5. Power specifications are as follows:
 AC100-240V~, 50/60Hz, 15VA
 (AC/DC24V~, 50/60Hz, 6VA, 3.5W)



About the power blocks

The E5CK has independent power supplies for each of the terminal blocks shown on the right. However, note that the power supplies for blocks C (exclude relay output) and D are shared for the following option unit.

- Option unit : E53-CKB or E53-CKF

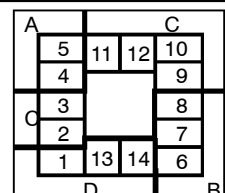

● Input

5	11	12	10
4			9
3			8
2			7
1	13	14	6

- Connect the input to terminal Nos. 6 to 8 as follows according to the input type.

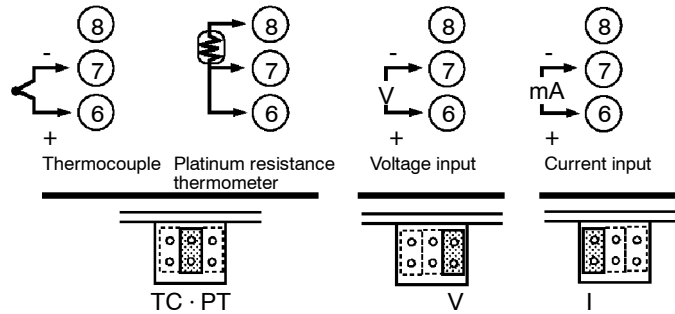

- Match the inputs with the internal jumper settings for each input type. For thermocouple or platinum resistance thermometer inputs, set the inputs to a common position (TC/PT) as the temperature input. For details on jumper connector positions, see page 2-2.

● Control output

5	11	12	10
4			9
3			8
2			7
1	13	14	6

- Terminal Nos. 11 and 12 are for control output 1 (OUT1). The five output types and internal equalizing circuits are available according to output unit:

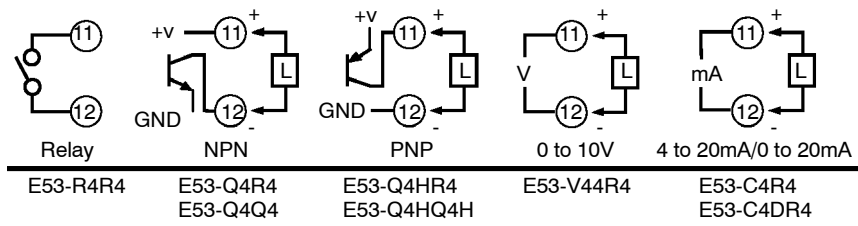

- Terminal Nos. 9 and 10 are for control output 2 (OUT2). The three output types and internal equalizing circuits are available according to output unit:

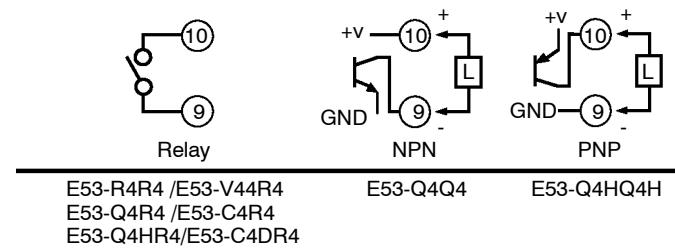

- The following table shows the specifications for each output type.

Output Type	Specifications
Relay	250VAC, 3 A
Voltage (NPN)	12VDC, 20 mA (with short-circuit protection)
Voltage (PNP)	12VDC, 20 mA (with short-circuit protection)
0 to 10V	0 to 10VDC, Permissible load impedance: 1 kΩ min., Resolution: Approx. 2600
4 to 20mA	4 to 20 mA, Permissible load impedance: 500 Ω max., Resolution: Approx. 2600
0 to 20mA	0 to 20 mA, Permissible load impedance: 500 Ω max., Resolution: Approx. 2600

● **Auxiliary output 1**

5	11	12	10
4			9
3			8
2			7
1	13	14	6

- Terminal Nos. 2 and 3 are for auxiliary output 1 (SUB1).
- The internal equalizing circuit for auxiliary output 1 is as follows:

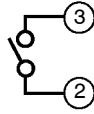

- Relay specifications are as follows:
SPST-NO, 250VAC, 1A

● **Option**

5	11	12	10
4			9
3			8
2			7
1	13	14	6

- Terminal Nos. 1, 13 and 14 are valid only when the option unit is set in the controller.
- The following four connections are possible depending on the type of option unit.

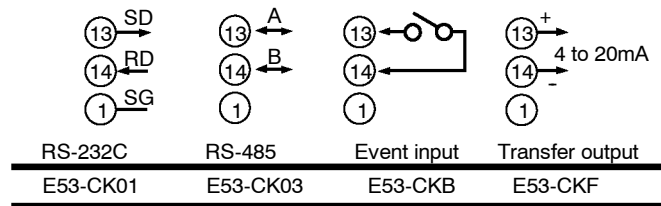

- For details on RS-232C and RS-485 communications functions, see Chapter 6 Using the Communications Function.
- Use event inputs under the following conditions

Contact input	ON: 1 kΩ max., OFF: 100 kΩ min.
No-contact input	ON: residual voltage 1.5V max., OFF: leakage current 0.1mA max.

Polarities during no-contact input are as follows:

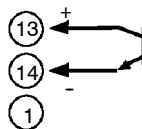

- Transfer output specifications are as follows:
4 to 20 mA, Load 500 Ω max., Resolution approx. 2600

K CHAPTER 3

BASIC OPERATION

This chapter describes an actual example for understanding the basic operation of the E5CK.

3.1	Control Example	3-2
3.2	Setting Input Specifications	3-3
	Input type	3-3
	Scaling	3-3
3.3	Setting Output Specifications	3-5
	Output assignments	3-5
	Direct/reverse operation	3-5
	Control period	3-6
3.4	Setting Alarm Type	3-7
	Alarm type	3-7
	Alarm value	3-7
	Alarm hysteresis	3-8
	Close in alarm/open in alarm	3-8
3.5	Protect Mode	3-10
	Security	3-10
	A/M key protect	3-10
3.6	Starting and Stopping Operation	3-11
3.7	Adjusting Control Operation	3-12
	Changing the set point	3-12
	Manual operation	3-12
	Auto-tuning (A.T.)	3-13

3.1 Control Example

This chapter describes the following control example to facilitate understanding of the basic operation of the E5CK controller.

This description assumes that the controller is operated under the following conditions.

- A humidity sensor of output 4 to 20 mA is connected to the controller. The measuring range of the humidity sensor is set to 10 to 95%.
- A humidifier is controlled by pulse output to maintain humidity at a constant 60%.
- An alarm is output when the humidity exceeds the upper limit value (70%) or lower limit value (50%).

● Setup

- Output unit: relay/relay type (E53-R4R4)
- Input type jumper connector: “I (current input)”

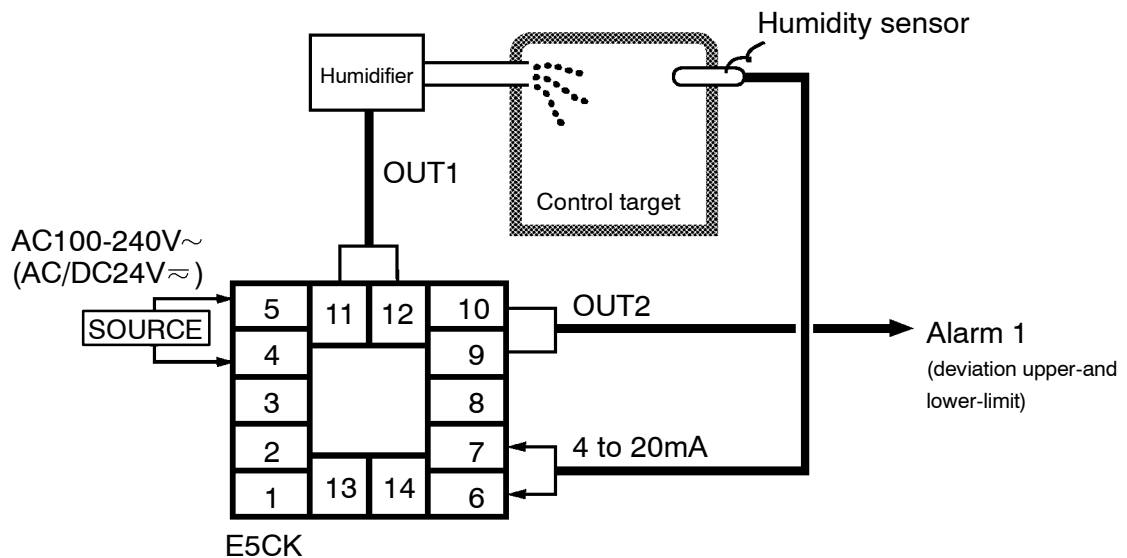

3.2 Setting Input Specifications

Input type



- Set the type No. (0 to 21) in the “input type” parameter. The factory setting is “2: K1 (thermocouple).”
- For details on input types and setting ranges, see page 5-22.

Scaling



- When the voltage input and current input are selected, scaling matched to the control is required.
- The “scaling upper limit”, “scaling lower limit” and “decimal point” parameters (setup mode) are use for scaling.
- The “scaling upper limit” parameter sets the physical quantity to be expressed by the upper limit value of input, and the “scaling lower limit” parameter sets the physical quantity to be expressed by the lower limit value of input. The “decimal point” parameter sets the number of digits past the decimal point.
- The following figure shows scaling example of 4 to 20 mA input. After scaling, the humidity can be directly read. In this case, the “decimal point” parameter is set to “1”.

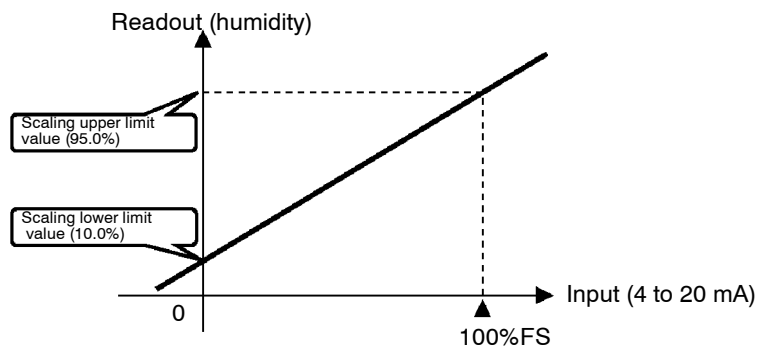

Input shift



- When temperature input is selected, scaling is not required. This is because input is treated as the “temperature” as it is matched to the input type. However, note that the upper and lower limit values of the sensor can be shifted. For example, if both the upper and lower limit values are shifted by 1.2°C, the process value (before shift) is regarded as 201.2°C after shift when input is 200°C before shift.
- To set input shift, set shift values in the “input shift upper limit” and “input shift lower limit” parameters (level 2 mode).

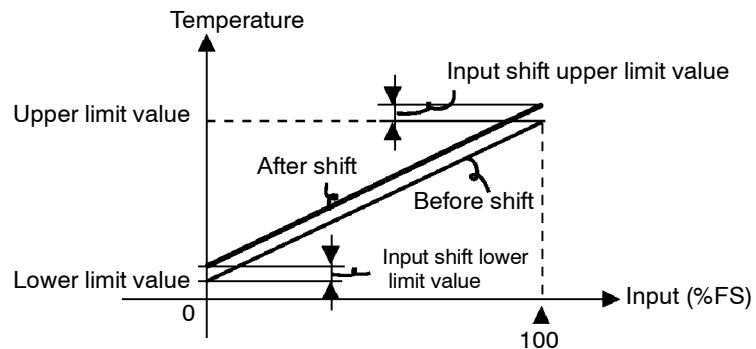

About the temperature unit

To switch the temperature unit from “°C” to “°F” for temperature unit, switch the setting of the °C/°F selection” parameter to [] from [].

Setting Example

In this example, let's set the parameters as follows:

- “input type” = “17 (4 to 20 mA)”
- “scaling upper limit value” = “950”
- “scaling lower limit value” = “100”
- “decimal point” = “1”

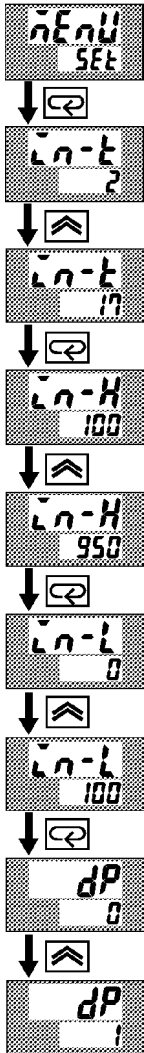

- (1) Select the menu display, and select [SEt] (setup mode) using the or keys. For details on selecting the menu display, see page 1-7.
- (2) Press the key to enter the setup mode. The top parameter in the setup mode [In-t] “input type” is displayed. The parameter default is “2”.
- (3) Press the key until the display indicates “17”.
- (4) Press the key to fix the set value. The display changes to [In-H] (“scaling upper limit value” parameter). The parameter default is “100”.
- (5) Press the key until the display indicates “950”.
- (6) Press the key to fix the set value. The display changes to [In-L] (“scaling lower limit value” parameter). The parameter default is “0”.
- (7) Press the key until the display indicates “100”.
- (8) Press the key to fix the set value. The display changes to [dP] (“decimal point” parameter). The parameter default is “0”.
- (9) Press the key until the display indicates “1”.

3.3 Setting Output Specifications

■ Output assignments





- Eight output are supported :
 - control output (heat)
 - control output (cool)
 - alarm outputs 1 to 3
 - LBA, and
 - error 1 (input error)
 - error 2 (A/D converter error).

These functions are assigned to control outputs 1 and 2, and auxiliary output 1.

- Restrictions on assignment destination are placed on some of the outputs. The following table shows where outputs may be assigned to.

Output Function \ Assignment Destination	Control Output		Auxiliary Output
	1	2	1
Control output (heat)	●	●	
Control output (cool)	●	●	
Alarm 1	●	●	●
Alarm 2	●	●	●
Alarm 3	●	●	●
LBA	●	●	●
Error 1; Input error			●
Error 2; A/D converter error			●

With control output (cool) the conditions for switching from standard control to heating and cooling control are reached when the output function is assigned at the cooling side during heating and cooling control.

In other words, heating and cooling control is carried out when control output (cool) is assigned, and standard control is carried out when output is not assigned. For details on heating and cooling control, see 4.1 Selecting the Control Method (page 4-2).

- The same output function can not be assigned to a single destination more than once.
- Factory settings are as follows:
 - Control output (heat) = control output 1
 - Alarm 1 = control output 2
 - Alarm 2 = auxiliary output 1.
- Output assignments are set in the “control output 1 assignment”, “control output 2 assignment” and “aux output 1 assignment” parameters (setup mode).

■ Direct/reverse operation

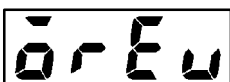

- “Direct operation” (or normal operation) refers to control where the manipulated variable is increased according to the increase in the process value. Alternatively, “reverse operation” refers to control where the manipulated variable is decreased according to the decrease in the process value.

For example, when the process value (PV), is lower than the set point (SP), in a heating control system, the manipulated variable increases by the difference between the PV and SP values.

Accordingly, this becomes “reverse operation” in a heating control system. Alternatively, this becomes “direct operation” in a cooling control system.

- Direct/reverse operation is set in the [drEw] “direct/reverse operation” parameter (setup mode).

Control period



- When the output unit is pulse output such as relay output, set the pulse output cycle (control period). Though a shorter pulse period provides better control performance, the control period should be set taking the life expectancy of the output unit into consideration when the output unit is relay.
- The control period is set in the “control period (heat)” parameter (level 1 mode). Factory setting is “20:20 seconds.”

Setting Example

In this example, let's set the parameters as follows:

- “control output 1 assignment” = “control output (heat)”
- “control output 2 assignment” = “alarm output 1”
- “direct/reverse operation” = “reverse operation”
- “control period” = “20 seconds”

All of the above settings in this example are factory settings. So, in this example, we are only going to check the parameter settings.

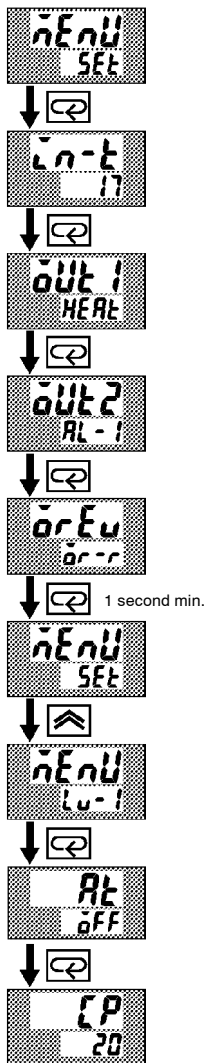

- (1) Select the menu display, and select [SFE] (setup mode) using the or keys. For details on selecting the menu display, see page 1-7.
- (2) Press the key to enter the setup mode. The top parameter in the setup mode [IN-T] “input type” is displayed. In this example, the parameter setting is “17: 4 to 20 mA.”
- (3) Press the key until [OUT 1] (“control output 1 assignment” parameter) is displayed. The parameter default is [HEAT].
- (4) As the setting in this example is to be left as it is, press the key. The display changes to [OUT 2] (“control output 2 assignment” parameter). The parameter default is [AL - 1].
- (5) As the setting in this example is to be left as it is, press the key until [DIR REV] (“direct/reverse operation” parameter) is displayed. The parameter default is [DIR - R].
- (6) As the setting in this example is to be left as it is, press the or keys to select [L1 - 1] (level 1 mode). For details on selecting the menu display, see page 1-7.
- (7) Press the key to enter the level 1 mode. The top parameter in the level 1 mode [AT] “AT execute/cancel” is displayed.
- (8) Press the key until [CP] (“control period” parameter) is displayed. The parameter default is “20”. As the setting in this example is to be left as it is, quit key operation.

3.4 Setting Alarm Type

- Three alarm outputs are supported: alarms 1 to 3. Of these, only the alarm assigned as the output can be used.
- Alarm output conditions are determined according to the combination of the “alarm type”, “alarm value” and “alarm hysteresis” parameter settings.
- The contact conditions when alarm output is ON can be set to “open” or “closed” in the “close in alarm/open in alarm” parameter.
- The following table shows the alarm types supported by the E5CK controller and their respective operations.

Alarm type



Alarm Type		Alarm Output Operation	
		When X is positive	When X is negative
1	Upper-and lower-limit alarm (deviation)	ON OFF	Always ON
2	Upper-limit alarm (deviation)	ON OFF	ON OFF
3	Lower-limit alarm (deviation)	ON OFF	ON OFF
4	Upper-and lower-limit range alarm (deviation)	ON OFF	Always OFF
5	Upper-and lower-limit alarm with standby sequence (deviation)	ON OFF	Always OFF
6	Upper-limit alarm with standby sequence (deviation)	ON OFF	ON OFF
7	Lower-limit alarm with standby sequence (deviation)	ON OFF	ON OFF
8	Absolute-value upper-limit alarm	ON OFF	ON OFF
9	Absolute-value lower-limit alarm	ON OFF	ON OFF
10	Absolute-value upper-limit alarm with standby sequence	ON OFF	ON OFF
11	Absolute-value lower-limit alarm with standby sequence	ON OFF	ON OFF

- Alarm types are set independently for each alarm in the “alarm 1 to 3” parameters (setup mode). Factory setting is “2: Upper-limit alarm (deviation)”.

Alarm value

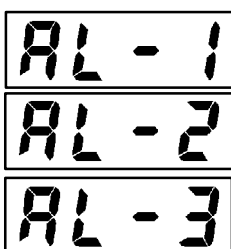

- Alarm values are indicated by “X” in the table above. Alarm output operation differs according to whether the value of the alarm is positive or negative.
- Alarm values are set independently for each alarm in the “alarm value 1 to 3” parameters (level 1 mode). Factory setting is “0”.

Alarm hysteresis

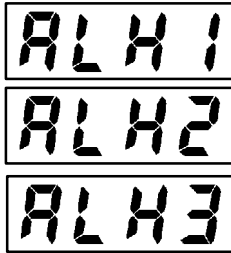

- The hysteresis of alarm outputs when alarms are switched ON/OFF can be set as follows.

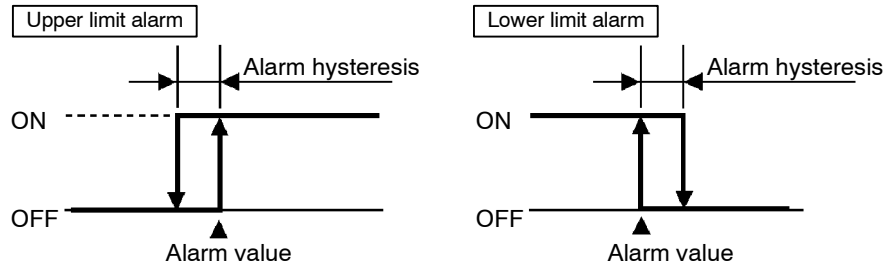

- Alarm hysteresis is set independently for each alarm in the “alarm 1 to 3 hysteresis” parameters (level 2 mode). Factory setting is “0.02: 0.02%FS”.

Standby sequence

- “Standby sequence” is a function for unconditionally turning alarm output OFF when the process value has left the alarm range once and it next enters the alarm range.
- For example, when the alarm type is set to “deviation lower limit,” generally the process value is within the alarm range, and alarm output become ON as it is as the process value when the power is turned ON is smaller than the set point. However, if the alarm type is set to “deviation lower limit with standby sequence”, alarm output first becomes ON when the process value exceeds the alarm setting value to leave the alarm range and once again falls below the alarm value.

Close in alarm/open in alarm

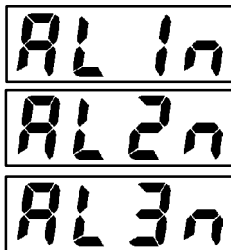

- When the controller is set to “close in alarm,” the status of the alarm output function is output as it is. When set to “open in alarm,” the status of the alarm output function is output inverted.

	Alarm	Output	Output LED
Close in alarm	ON	ON	Lit
	OFF	OFF	Not lit
Open in alarm	ON	OFF	Lit
	OFF	ON	Not lit

- Alarm type and close in alarm (normally open)/open in alarm (normally close) can be set independently for each alarm.
- Close in alarm/open in alarm is set in the “alarm 1 to 3 open in alarm” parameters (setup mode). Factory setting is [n - 0] “close in alarm”.

Summary of alarm operations

The figure below visually summarizes the above description of alarm operations (when alarm type is set to “lower limit alarm (deviation) with standby sequence”):

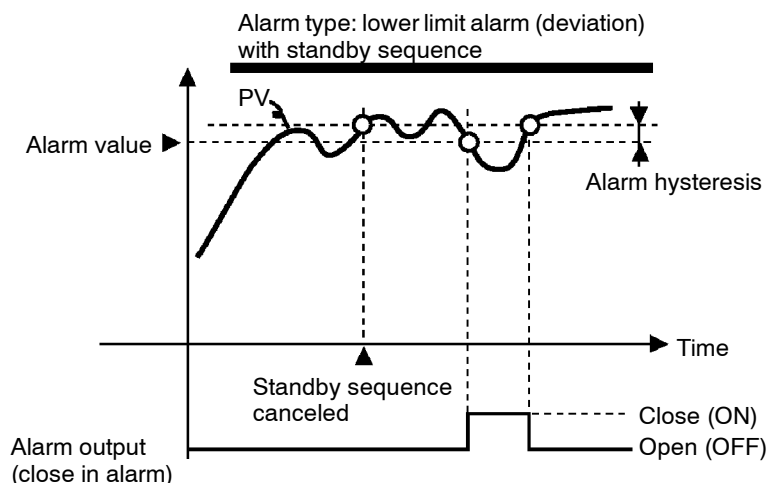

Setting Example

When a set point for a humidity exceeds $\pm 10.0\%$, alarm1 will be output. In this example, let's set the parameters as follows:

“alarm type 1”	= “1: (deviation upper-and lower-limit)”
“alarm value 1”	= “10.0”
“alarm hysteresis”	= “0.20”
“close in alarm/open in alarm”	= “ $\bar{1} - \bar{0}$: close in alarm”

Meanings of parameters, “alarm hysteresis” and “open in alarm/close in alarm” are the same settings at the shipment, so settings for operations are omitted.

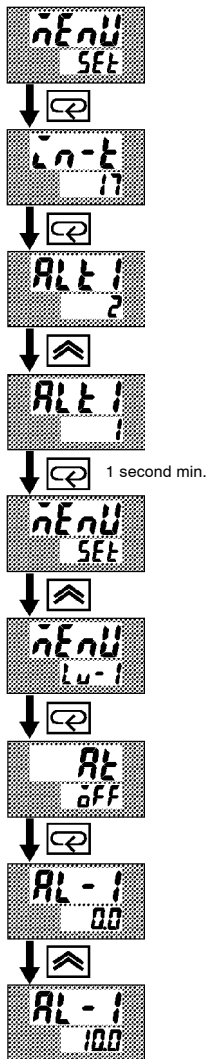

- (1) Select the menu display, and select [SEt] (setup mode) using the or keys. For details on selecting the menu display, see page 1-7.
- (2) Press the key to enter the setup mode. The top parameter in the setup mode [Lu-t] “input type” is displayed. In this example, the parameter setting is “17: 4 to 20 mA”.
- (3) Press the key until [ALt 1] (“alarm type 1” parameter) is displayed. The parameter default is “2: deviation upper limit”.
- (4) Press the key to return to “1: deviation upper and lower limit”.
- (5) Select the menu key, and select [Lu-1] (level 1 mode) using the or keys. For details on selecting the menu display, see page 1-7.
- (6) Press the key to enter the level 1 mode. The top parameter in the level 1 mode [ALt] “AT execute/cancel” is displayed.
- (7) Press the key until [AL-1] (“alarm value 1” parameter) is displayed.
- (8) In this example, the parameter setting is “0.0” so press the key until “10.0” is displayed.



About the Decimal Point of the Alarm Value

The decimal point of the alarm value conforms to the setting of the “decimal point” parameter (setup mode). In this example, the “decimal point” parameter is set to “1”. (During temperature input, the decimal point of the alarm value conforms to the set sensor.)

3.5 Protect Mode

Security

- This parameter allows you to protect until start of operation parameters that do not change during operation to prevent unwanted modification.
- The set value of the “security” (protect) parameter specifies the range of protected parameters.
- When this parameter is set to “0”, parameters are not protected.
- When this parameter is set to “1” to “3”, the number of modes that can be displayed on the menu display is limited.
When set to “1”, level 0 to 2, setup, expansion and option modes only can be selected. When set to “2”, only level 0 to 2 modes can be selected. When set to “3”, only level 0 and 1 modes can be selected.
- When this parameter is set to “4” to “6”, operations in only the level 0 mode can be selected, and the mode is not displayed on the menu display.
- When this parameter is set to “5”, only the “PV/SP” parameter can be used.
- When this parameter is set to “6”, only the “PV/SP” parameter can be used. (The set point can not change.)
- Default is “1”.

A/M key protect

- This parameter disables use of the key during operation. For example, if you protect use of the key by the “A/M key protect” parameter (protect mode) during auto operation, the controller cannot be set to the manual mode, preventing manual operation of the controller during operation.

Setting Example

- Let’s protect the setup, expansion, option and calibration modes. Set the parameters as follows:
“security” = “2: Usable only in level 0 to 2 modes”

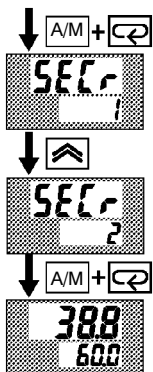

- (1) Press for 1 second minimum the and keys simultaneously, the controller enters the protect mode.
- (2) In the protect mode, the top parameter in the protect mode “security” is displayed. The parameter default is “1”. Press the key to change the parameter setting to “2”.
- (3) Press for 1 second minimum the and keys simultaneously, the display changes to the “PV/SP monitor” parameter (level 0 mode).

3.6 Starting and Stopping Operation



- You can start and stop operation by changing the setting of the “run/stop” parameter (level 0 mode).
- You can switch the RUN/STOP function up to 100,000 times.
- To stop operation, set the “run/stop” parameter to [5 t 0 P] (stop). In a stop state, the “STOP” LED lights.

● Manipulated variable at stop

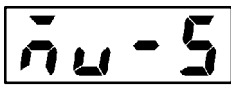

- To set output during a stop, specify the manipulated variable (Standard: -5.0 to 105.0%, Heating and cooling: -105.0 to 105.0%) in the “MV at stop” parameter (level 2 mode). Factory setting is “0.0: 0.0%”.

Setting Example

The following example describes the procedure to follow to stop control during operation of the controller.

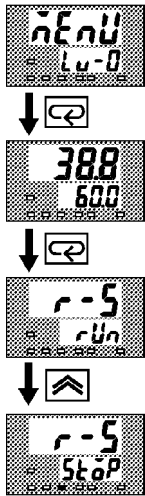

- (1) Select the menu display, and select [L v - 0] (level 0 mode) using the or keys. For details on selecting the menu display, see page 1-7.
- (2) Press the key to enter the level 0 mode. The PV and SP are displayed.
- (3) Press the key until [r - 5] (“run/stop” parameter) is displayed.
- (4) Press the key to select [5 t 0 P] (stop). The “STOP” LED lights, and operation stops.

To resume operation, follow the above procedure to select [r 0 n] (“run”). The “STOP” LED goes out and operation starts.

3.7 Adjusting Control Operation

■ Changing the set point



- You can change the set point in the “set point” parameter (level 0 mode).
- However, note that you cannot change the set point when the “security” parameter (protect mode) is set to “6”.
- To change the set point, press the or keys to select the desired value. If you leave the setting for two seconds, the set point is updated to the new setting.

Setting Example

In the following example, let's change the humidity set point from “60%” to “50%”.

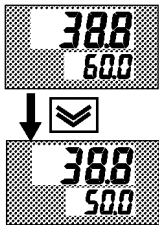

- (1) Select the PV/SP monitor display.
- (2) Press the key to change the setting to “50.0: 50.0%”.

■ Manual operation

- To set manual operation and manually set the manipulated variable, press for 1 second minimum the key. The controller enters the manual mode.
- The manipulated variable is displayed on the No.2 display. To change the manipulated variable, press the or keys. After two seconds, the manipulated variable is updated to the new setting.
- Other modes cannot be selected while in the manual mode. To select other modes, press for 1 second minimum the key. The manual mode is quit.
- The automatic return of display function does not work while in the manual mode.
- When switching between manual and auto operation, the manipulated variable is subject to balance-less, bump-less operation.
- If the power is interrupted during manual operation, manual operation is resumed at the manipulated variable at power interruption when the power is reset.
- You can switch the AUTO/MANUAL function up to 100,000 times.



Balance-less,
Bump-less Opera-
tion

To prevent sudden changes in the manipulated variable when switching between manual and auto operation, operation is resumed using the value that was active immediately before operation was switched, and the value is brought gradually closer to the value immediately after operation was switched.

The following diagram summarizes manual operation.

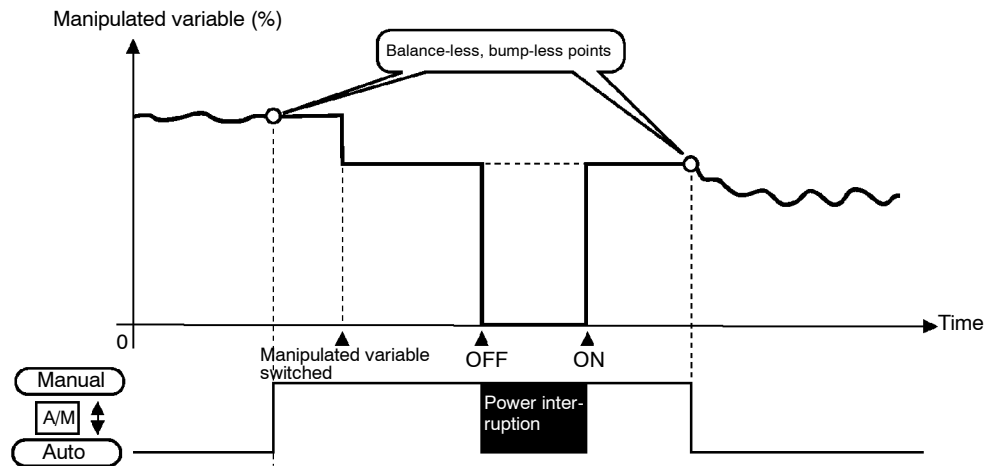

Auto-tuning (A.T.)



- AT (auto-tuning) cannot be executed while operation is canceled or during ON/OFF control.
- When you execute auto-tuning, the optimum PID parameters are automatically set by forcibly changing the manipulated variable to calculate the characteristics (called the “limit cycle method”) of the control target. During auto-tuning, the AT LED flashes.
- 40%AT or 100%AT can be selected by the limit cycle of MV change width. Specify [AT - 1] or [AT - 2], respectively, in the “AT execute/cancel” parameter (level 1 mode).
- During heating and cooling control, only 100%AT can be executed. (So, [AT - 1] (40%AT) will not be displayed.)
- To cancel AT execution, specify [FF] (“AT cancel”).

40%AT

In order to set the limit cycle of MV change width to 40%, select 40%AT to execute auto-tuning with fluctuations in the process value kept to a minimum. However, note that auto-tuning takes longer to execute compared with 100%AT.

The timing by which limit cycles are generated varies according to whether or not the deviation (DV) at the start of AT execution is 10% full-scale or less.

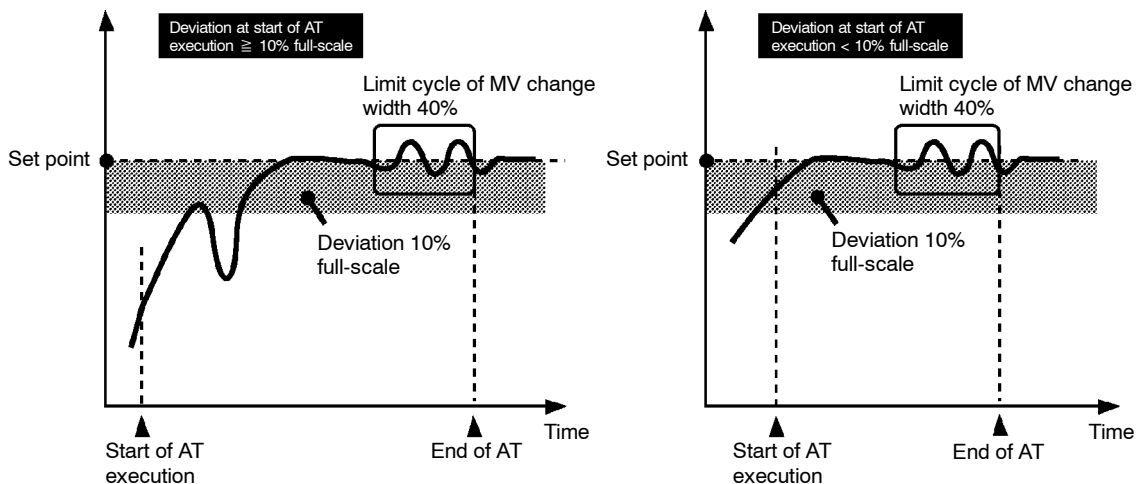

● 100%AT

In order to set the limit cycle of MV change width to 100%, select 100% AT to shorten the AT execution time without worrying about fluctuations in the process value.

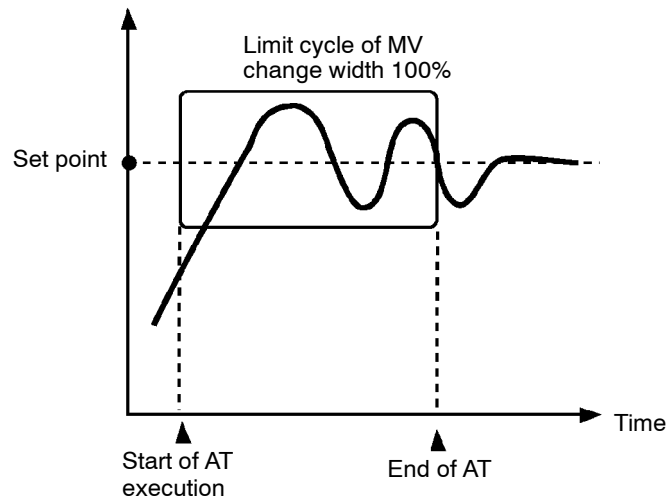

Setting Example

In this example, let's execute 40%AT.



- (1) Select [Lv-1] (level 1 mode) using the or keys. For details on selecting the menu display, see page 1-7.
 - (2) Press the key to enter the level 1 mode. The top parameter in the setup mode [At] “AT execute/cancel” is displayed. In this example, the parameter setting is [OFF] “AT cancel”
 - (3) Press the key to specify [At - 1].
 - (4) The AT LED flashes, and AT execution starts. When the AT LED goes out (end of AT execution), the parameter automatically returns to [OFF] (“AT cancel”).
- In addition to AT, the E5CK is also provided with fuzzy self-tuning (ST) that allows automatic calculation of the PID parameters suited to the control target. However, note that the ST function operates only during standard control by temperature input. For further information regarding the ST, please see page 5-29 and A-10.



About PID Parameters

When control characteristics are already known, the PID parameters can be set directly to adjust control.

PID parameters are set in the “proportional band” (P), “integrated time” (I) and “derivative time” (D) parameters (level 1 mode).

For details on the setting ranges of these parameters, see chapter 5 Level 1 Mode (page 5-11).

K CHAPTER 4

APPLIED OPERATION

This chapter describes each of the parameters required for making full use of the features of the E5CK. Read this chapter while referring to the parameter descriptions in chapter 5.

4.1	Selecting the Control Method	4-2
	Heating and cooling control	4-2
	ON/OFF control	4-3
4.2	Operating Condition Restrictions	4-4
	Manipulated variable restrictions	4-4
	Set point limiter	4-5
	SP ramp	4-5
4.3	How to Use Option Functions	4-7
	Event input	4-7
	Transfer output	4-8
4.4	LBA	4-9
4.5	Calibration	4-11
	Calibrating thermocouple	4-12
	Calibrating platinum resistance thermometer	4-15
	Calibrating current input	4-17
	Calibrating voltage input	4-18
	Checking indication accuracy	4-20

4.1 Selecting the Control Method

When selecting the control method, set the parameters according to the following table. (Parameters are factory-set to heating control.)

Control Method \ Parameter	Control output 1 assignment	Control output 2 assignment	Direct/Reverse operations
Heating control (Standard)	Control output (heat)	-	Reverse operation
Cooling control (Standard)	Control output (heat)	-	Direct operation
Heating and cooling control	Control output (heat)	Control output (cool)	Reverse operation

For details on how to assign outputs, see 3.3 Setting Output Specifications (page 3–5).

■ Heating and cooling control

- Dead band

- When heating and cooling control is selected, the “deadband” and “cooling coefficient” parameters can be used.

The dead band is set with the set point as its center. The dead band width is the set value of the “dead band” parameter (level 1 mode). Setting a positive value produces a dead band, while setting a negative value produces an overlap band.

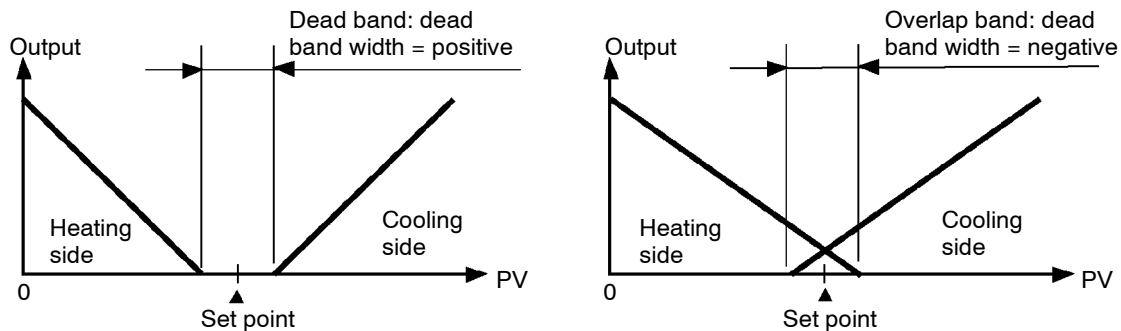

- Cooling coefficient

If the heating and cooling characteristics of the control target greatly differ, preventing satisfactory control characteristics from being obtained by the same PID parameters, adjust the proportional band (P at cooling side) using the cooling coefficient to balance control between the heating and cooling sides. In heating and cooling control, P at the heating or cooling side is calculated by the following formula:

$$\text{Heating side } P = P; \text{ Cooling side } P = \text{cooling coefficient} \times P$$

- Manipulated variable at stop

- In heating and cooling control, the manipulated variable output that is output when controller operation is stopped is dependent on the set value of the “MV at stop” parameter (level 2 mode) in the same way as for standard control.
- However, note that in heating and cooling control, the manipulated variable at the cooling side is treated as a negative value for the sake of convenience. When the manipulated variable at STOP is a negative value, the manipulated variable is output to only the cooling side, and when a positive value, the manipulated variable is output to only the heating side. The factory setting is “0”. If the controller is operated using the factory setting, the manipulated variable is not output to both the heating and cooling sides.



Switching with Manual operation

When the overlap band is set, the bumpless function that operates when switching between manual and automatic operation may not work.

ON/OFF control

Hysteresis

- Switching between advanced PID control and ON/OFF control is carried out by the “PID/ ON/OFF” parameter (expansion mode). When this parameter is set to [P L d], advanced PID control is selected, and when set to [o n o f f], ON/OFF control is selected. Default is [P L d].
- In ON/OFF control, hysteresis is provided in the program when switching between ON and OFF to stabilize operation. The hysteresis width provided during ON/OFF control is simply referred to as “hysteresis.” Control output (heat) and control output (cool) functions are set in the “hysteresis (heat)” and “hysteresis (cool)” parameters, respectively.
- In standard control (heating or cooling control), hysteresis can be set only for the heating side.

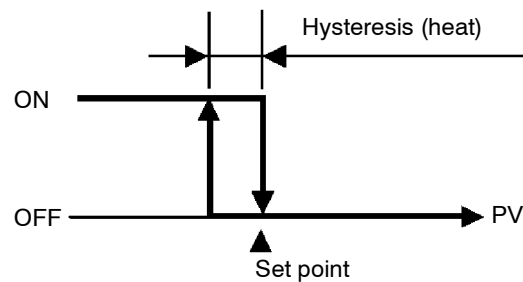

- In heating and cooling control, a dead band can be set. So, 3-position control is made possible.

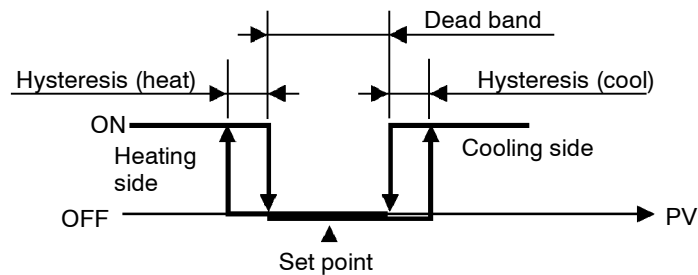

Parameters

Symbol	Parameter Name: Mode	Description
o u t 1	Control output 1 assignment : Setup	For specifying control method
o u t 2	Control output 2 assignment : Setup	For specifying control method
d r e v	Direct/Reverse operation : Setup	For specifying control method
[- d b	Dead band : Level 1	Heating and cooling control
[- S C	Cooling coefficient : Level 1	Heating and cooling control
n v - S	MV at stop : Level 2	Manipulated variable when control operation is stopped
H Y S	Hysteresis (heat) : Level 1	ON/OFF control
[H Y S	Hysteresis (cool) : Level 1	ON/OFF control
[o n o f f	PID / ON/OFF : Expansion	ON/OFF control

4.2 Operating Condition Restrictions

■ Manipulated variable restrictions

The upper-and lower-limit values of the manipulated variable can be restricted by the MV limiter, and the change rate of the manipulated variable can be restricted by the MV change rate limiter.

● MV limiter

The upper-and lower-limit values of the manipulated variable are set in the “MV upper limit” and “MV lower limit” parameters (level 2 mode). When the manipulated variable calculated by the E5CK is outside of the range of the MV limiter, actual outputs are dependent on the set value of these parameters.

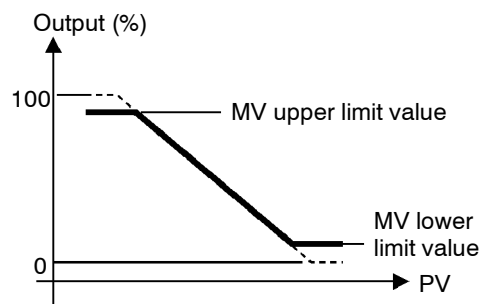

In heating and cooling control, the manipulated variable at the cooling side is treated as a negative value for the sake of convenience. The upper limit is set for the heating side (positive value), and the lower limit is set for the cooling side (negative value) as shown in the following figure.

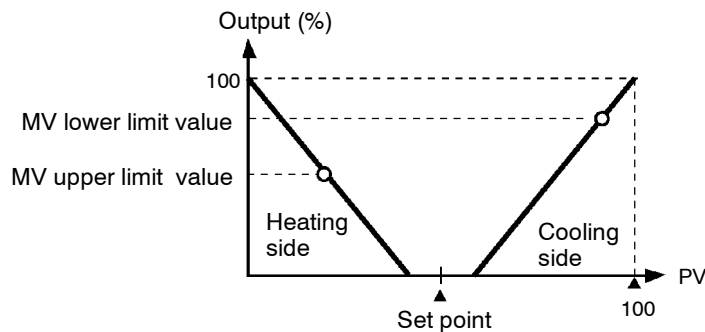

● MV change rate limiter

The “MV change rate limit” parameter (level 2 mode) sets the maximum permissible change width per second of the manipulated variable. If a change in the manipulated variable exceeds this parameter setting, the value calculated by the E5CK is reached while changing the value by the per-second value set in this parameter.

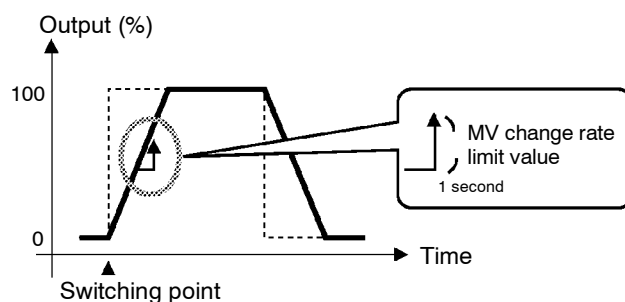

● **Limiter operation conditions**

The limiters are invalid or cannot be set when any of the following conditions occurs:

- During ON/OFF control
- During ST execution
- During AT execution (only by MV change rate limiter)
- During manual operation
- When operation is stopped
- When an error has occurred.

■ **Set point limiter**

The setting range of the set point is limited by the set point limiter. The upper-and lower-limit values of this set point limiter are set in the “Set point upper limit” and “Set point lower limit” parameters (expansion mode), respectively. However, note that when the set point limiter is reset, the set point is forcibly changed to the upper-or lower-limit value of the set point limiter if the set point is out of the limiter range. Also, when the input type, temperature unit and scaling (sensor) range are changed, set point limiter is forcibly reset to the scaling (sensor) range.

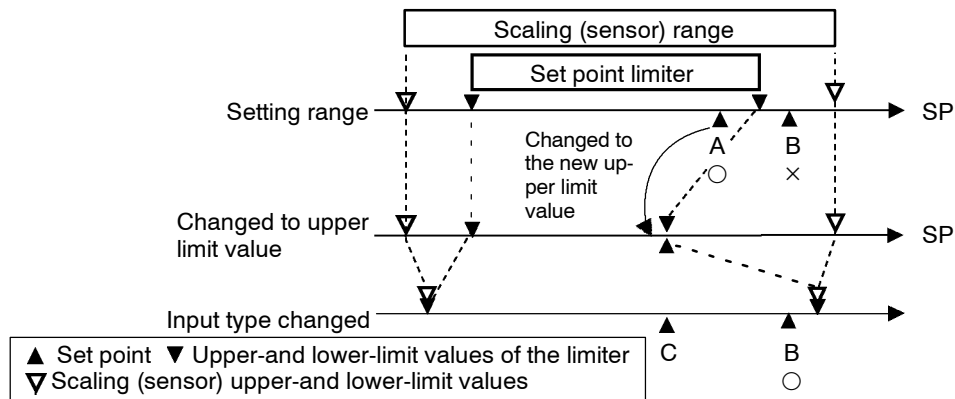

■ **SP ramp**

With the SP ramp function, the controller operates according to the value (set point during SP ramp) limited by a change rate, instead of the changed set point when set point is changed. The interval in which the set point during SP ramp is limited is referred to as the “SP ramp”.

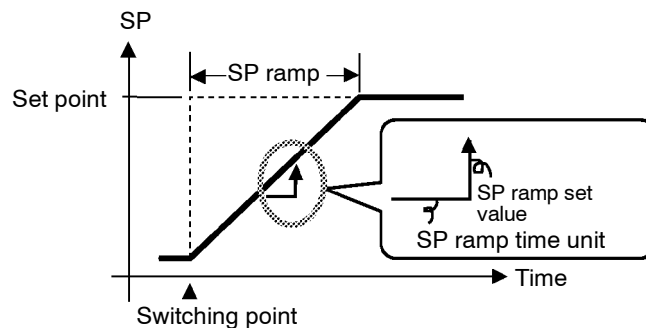

The change rate during the SP ramp is specified by the “SP ramp set value” and “SP ramp time unit” parameters. At the “SP ramp set value” default “0”, the SP ramp function is disabled.

The set point changing in SP ramp can be monitored in the “Set point during SP ramp” parameter (level 0 mode).

● **Operation at start**

The limiters are invalid or cannot be set when any of the following conditions occurs:

If the SP ramp function is enabled when the power is turned ON, and when “run” is switched to from “stop,” process value may reach the set point after SP ramp in the same way as when the set point is changed. In this case, operation is carried out with the process value regarded as the set point before the change was made.

The direction of the SP ramp changes according to the relationship between the process value and the set point.

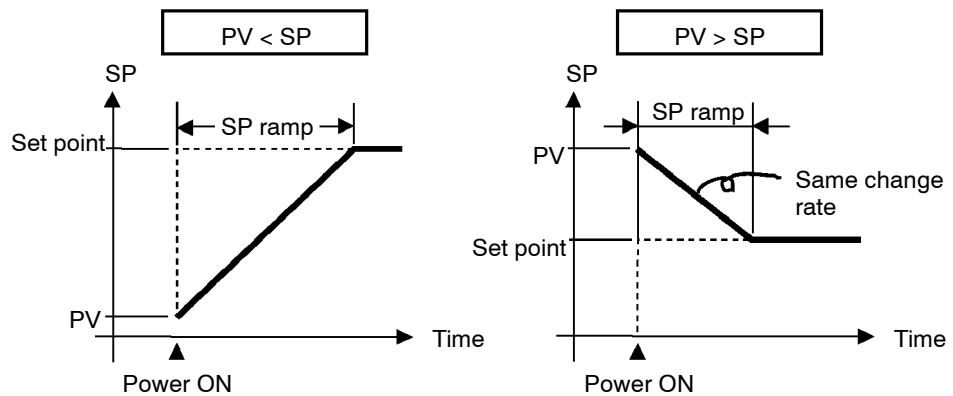

● **Restrictions during SP ramp**

- Execution of auto-tuning starts after the end of SP ramp.
- When the controller is switched to the manual mode, the set point changes continuously until SP ramp ends.
- When an error occurs, the SP ramp function becomes invalid.

Parameters

Symbol	Parameter Name: Mode	Description
$\bar{o}L-H$	MV upper limit : Level 2	Manipulated variable restrictions
$\bar{o}L-L$	MV lower limit : Level 2	Manipulated variable restrictions
$\bar{o}rL$	MV change rate limit : Level 2	Manipulated variable restrictions
$S\bar{L}-H$	SP setting upper limit: Expansion	SP setting restrictions
$S\bar{L}-L$	SP setting lower limit : Expansion	SP setting restrictions
$S\bar{P}r\bar{t}$	SP ramp set value : Level 2	SP changing restrictions
$S\bar{P}r\bar{U}$	SP ramp time unit : Level 2	SP changing restrictions

4.3 How to Use Option Functions

- For details on the communications function, refer to Chapter 6 Using the Communications Function.

■ Event input

● Input assignments

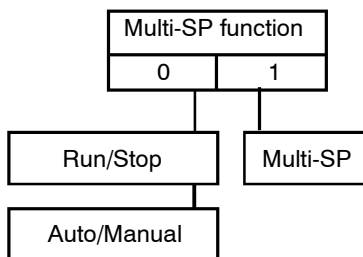

- When using event input, add on the input unit (E53-CKB).
- You can choose from the following three event input functions:
Run/Stop
Auto/Manual
Multi-SP
- When selecting an option function, first determine whether or not the multi-SP function is to be used. You can select two of the remaining option functions only when the multi-SP function is not in use.
- When using the multi-SP function, set the “multi-SP function” parameter (option mode) to “1: ON”. When using other functions, set this parameter to “0: OFF”.
- When specifying event input other than the multi-SP function, specify event input in the “event input assignment 1” parameter (option mode). The following table shows the relationship between parameter settings and event input functions.

Setting	Function	
STOP	ON : Stop	/OFF : Run
MAN	ON : Manual	/OFF : Auto

● Run/Stop

- When event input is set to “ON”, controller operation is stopped and the “STOP” LED lights. The content of event input is reflected in the “run/stop” parameter (level 0 mode).
- Run/Stop can be switched up to 100,000 times.

● Auto/Manual

- When event input is set to “ON”, the controller is switched for manual operation, and the “MANU” LED lights.
- Turn event input ON/OFF while the controller is ON.
- Auto/Manual can be switched up to 100,000 times.



About the event input and key operation

There is no order of priority when inputting events and operating the keys. However, because event input of run/stop or auto/manual must be carried out in either of the physical ON/OFF states, parameters ultimately conform to event input even if an attempt is made to switch the setting by key operation.

● Multi-SP

- The set points set to the “set point 0” and “set point 1” parameters (level 1 mode) can be switched for use. However, note that these parameters cannot be set when the multi-SP function is not selected.
- The set point can be switched up to 100,000 times.
- When event input is “OFF”, set point 0 is used, and when “ON” set point 1 is used.
- When you have changed the set point, the set point of the currently selected parameter is changed.
- When you have switched between “set point 0” and “set point 1”, the SP ramp function works if the SP ramp function is enabled. The following examples shows how the set point changes when you switch from set point 0 and set point 1.

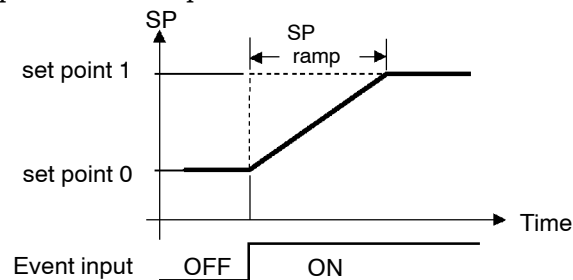

■ Transfer output

- When using transfer output, add on the communications unit (E53-CKF).
- You can select the following data items in the “transfer output type” parameter (option mode) as the transfer outputs:
 - Set point
 - Set point during SP ramp
 - Process value
 - Manipulated variable (heat), and
 - Manipulated variable (cool).
- These transfer outputs can be scaled according to the settings of the “transfer output upper limit” and “transfer output lower limit” parameters before output. Setting of an upper limit value smaller than the lower limit value is allowed, so reverse scaling can also be carried out. Also, the scale can be enlarged by the upper-and lower-limit width specified for each data item. The following example shows scaling of the reading side manipulated variable.

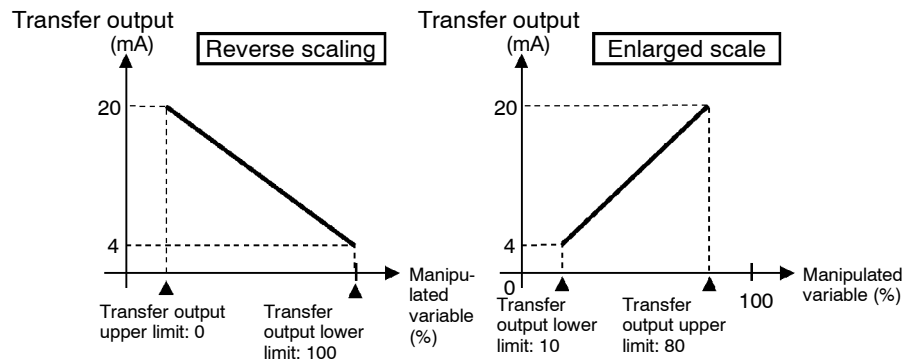

Parameters

Symbol	Parameter Name: Mode	Application
E _U - \bar{n}	Multi-SP function : Option	Event input functions
E _U -1	Event input assignment 1 : Option	Event input functions
SP-0	Set point 0 : Level 1	Multi-SP
SP-1	Set point 1 : Level 1	Multi-SP
t _r -t	Transfer output type : Option	Transfer output designation
t _r -H	Transfer output upper limit : Option	Transfer output scaling
t _r -L	Transfer output lower limit : Option	Transfer output scaling

4.4 LBA

- The LBA (Loop Break Alarm) function can be used only when assigned as an output. Also, the LBA function does not work when a memory error or A/D converter error occurs.
- LBA (Loop Break Alarm) is a function for judging that an error has occurred somewhere on the control loop and outputting an alarm when the process value does not change with the manipulated variable at a maximum or minimum state. Accordingly, the LBA function can be used as a means for detecting a malfunctioning control loop.

● LBA detection time

- Normally, when output is set to maximum or minimum, the process value rises or falls after the dead time has elapsed. LBA is output if the process value does not change in the predicted direction after a fixed amount of time has elapsed. This fixed amount of time is the “LBA detection time.”

● LBA detection width

- LBA operation sometimes becomes unstable when the process value fluctuates considerably due to the control characteristics. The LBA detection width is provided so that changes with respect to output can be correctly detected. Changes smaller than the detection width due to LBA detection timing are not regarded as changes.

● LBA detection example

- The following example describes what happens when a heater burnout at maximum output.

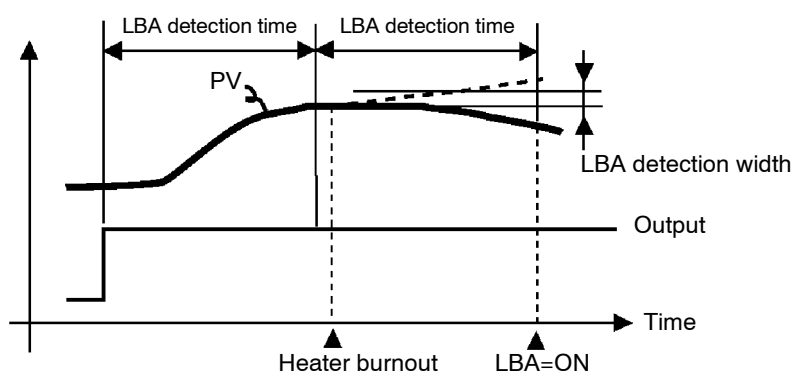

- LBA judgment is carried out at each LBA detection time from the point of maximum output. In above figure, the process value (PV) is changing greatly at the 1st judgment timing, so LBA remains OFF.
- At the 2nd judgment timing, the process value increases as indicated by the broken line of the process value is normal. This means that the change width exceeds the LBA detection width, and LBA output remains OFF.
- If the heater burns out at the point shown in the above figure, the process value “decreases.” Accordingly, it is judged that “the process value is not changing in the increasing direction” at the 2nd judgment timing and the LBA output becomes ON.

● **Setting the LBA detection time**

- The LBA detection time is automatically set by auto-tuning (except in heating and cooling control).
- If the optimum LBA detection time cannot be obtained by auto-tuning, set the time in the “LBA detection time” parameter (level 2 mode).

● **Determining the LBA detection time**

- Calculate the LBA detection time as follows:
 - (1) Set output to maximum.
 - (2) Measure the time it takes for the input change width to reach the LBA detection width (default: 0.2 % full-scale).
 - (3) Take a value twice that of the measurement time as the LBA detection time.

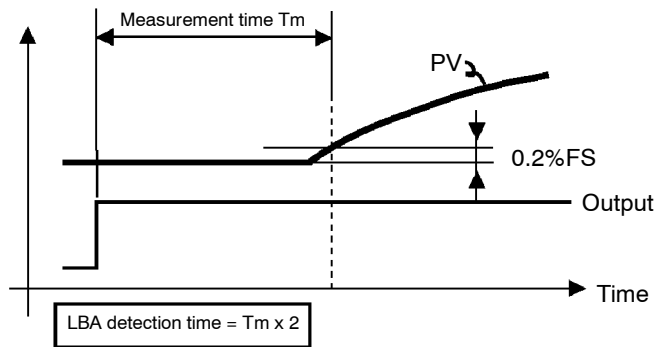

- (4) In the case of ON/OFF operation, set the LBA detection time to a value longer than the control period.

Parameters

Symbol	Parameter Name: Mode	Application
At	AT Execute/Cancel : Level 1	Automatic setting of LBA detection time
LbA	LBA detection time : Level 2	Setting of LBA detection time
LbAb	LBA detection width : Expansion	Changing of LBA detection width

4.5 Calibration

- To calibrate the E5CK controller, select [**CLb**] in the menu display to select the calibration mode. [**Adj**] is displayed.
- However, note that [**CLb**] may not be displayed on the menu display when, for example, the user is calibrating the E5CK controller for the first time. If this happens, [**CLb**] is displayed by changing the “security” parameter (protect mode) to “0”.
- The parameters in the calibration mode are configured as follows.

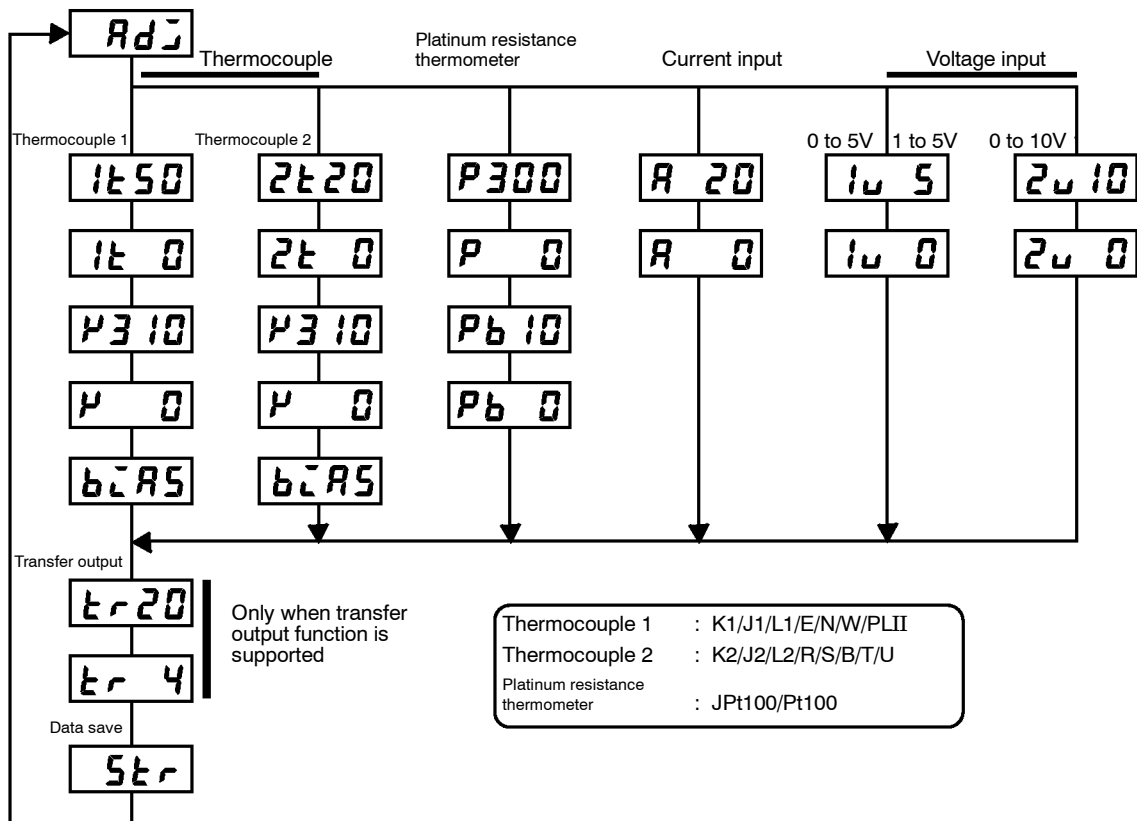

- To select the desired parameter, press the **↶** key. Parameters are displayed in the following order:
Calibration of inputs → Calibration of transfer output → Saving of calibration data
If the E5CK controller does not support the transfer output function, calibration of transfer output is automatically deleted from the calibration procedure as follows:
Calibration of inputs → Saving of calibration data
- Only inputs that have been set in the “input type” parameter (setup mode) can be calibrated. To temporarily save data for each of the calibration parameters, press the **↵** key for 1 second.
- Transfer output can be calibrated only when the communications unit (E53-CKF) is set in the controller. To adjust data items, press the **↶** or **↷** keys.
- The data save menu is displayed only when all calibration items have temporarily been saved.
- After calibrating input, you must always check indication accuracy. For details, see page 4-20.

● Calibration item menu



Calibration item parameter
Process value

- Parameters are displayed on the No.1 display, and the process value is displayed in Hexadecimal on the No.2 display.
- Normally, the process value changes by several digits. The process value flashes, for example, when a sensor error causes the process value to stray from the calibration target range.
- When the process value display is flashing, the process value is not saved as data even if the key is pressed.

● Calibration save mark



calibration save mark

- Once the E5CK controller has been calibrated by the user, [Adj] is preceded by the “.” mark when the calibration mode is selected.

■ Calibrating thermocouple

- Calibrate according to the type of thermocouple, thermocouple 1 group (K1, J1, L1, E, N, W, PLII) and thermocouple 2 group (K2, J2, L2, R, S, B, T, U).
- When calibrating, do not cover the bottom or top of the controller. Also, do not touch the input terminals (Nos. 6 and 7) and compensating conductor on the E5CK controller.

● Preparations

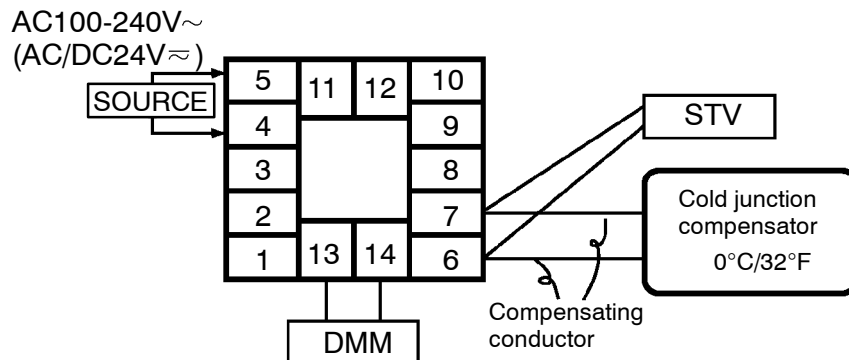

- Set the cold junction compensator to 0°C. However, make sure that internal thermocouples are disabled (tips are open).
- In the above figure, STV refers to a standard DC current/voltage source, and DMM refers to a precision digital multimeter.
- Use a compensating conductor selected thermocouple. However, note that when thermocouple R, S, E, B, W or PLII is used, the compensating conductor can be substituted with the cold junction compensator for thermocouple K and compensating conductor.



Connecting the Cold Junction Compensator

Correct process values cannot be obtained if you touch the contact ends of the compensating conductor during calibration of a thermocouple. Accordingly, short (enable) or open (disable) the tip of the compensating conductor inside the cold junction compensator as shown in the figure below to create a contact or non-contact state for the cold junction compensator.

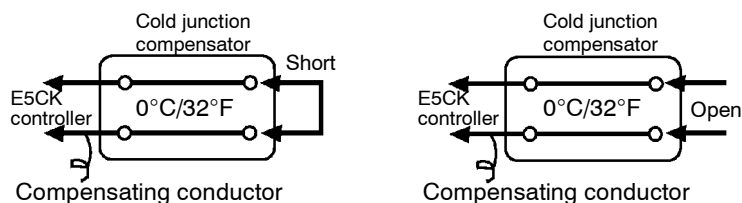

● Calibration: thermocouple 1

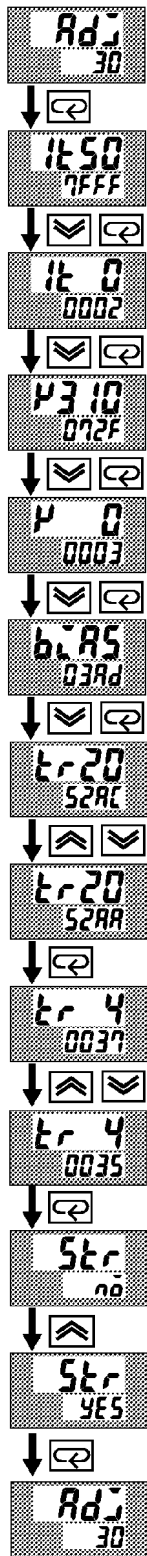

This example describes how to calibrate a thermocouple when the transfer output function is supported. If the transfer output function is not supported, skips steps (7) to (10).

- (1) When [Adj] is displayed, the 30-minute timer is displayed on the No.2 display and counts down. This timer serves as a guide for the aging time when aging is required.
- (2) First, calibrate the main input. Press the key to display [1E 50] (50mV calibration display). Set STV output to 50mV. When the value on the No.2 display has stabilized (changes of several digits max.), press the key to temporarily save the calibration data.
- (3) Press the key to display [1E 0] (0mV calibration display). Set STV output to 0mV. When the value on the No.2 display has stabilized (changes of several digits max.), press the key to temporarily save the calibration data.
- (4) Next, calibrate the cold junction compensator. Press the key to display [P3 10] (310mV calibration display). Set STV output to 310mV. When the value on the No.2 display has stabilized (changes of several digits max.), press the key to temporarily save the calibration data.
- (5) Press the key to display [P 0] (0mV calibration display). Set STV output to 0mV. When the value on the No.2 display has stabilized (changes of several digits max.), press the key to temporarily save the calibration data.
- (6) Finally, calibrate the bias compensation value. Disconnect the STV, and enable the thermocouple of the cold junction compensator. When carrying this out, make sure that the wiring on the STV is disconnected. Make sure that the cold junction compensator is set to 0°C and press the key. The display changes to [bL 85] (calibration display for the bias compensation value). When the value on the No.2 display has stabilized (changes of several digits max.), press the key to temporarily save the calibration data.
- (7) Next, calibrate the transfer output function. If the transfer output function is not supported, skip to step (11). Press the key. The display changes to [Er 20] (20mA calibration display).
- (8) Set the output to 20mA by the or keys while monitoring the voltage on the digital multimeter. In the example on the left, the display indicates that the value two digits smaller than before calibration is “20mA”.
- (9) Press the key. The display changes to [Er 4] (4mA calibration display).
- (10) Set the output to 4mA by the or keys while monitoring the voltage on the digital multimeter. In the example on the left, the display indicates that the value two digits smaller than before calibration is “4mA”.
- (11) Press the key until the display changes to the data save display. Press the key. The No.2 display changes to [YES], and two seconds later the calibration data is saved to internal memory. If you press the key when the No.2 display reads [no], the calibration data is invalidated.
- (12) This completes calibration of the thermocouple 1 group. Press the key to return the display to [Adj].

● Calibration:
thermocouple 2

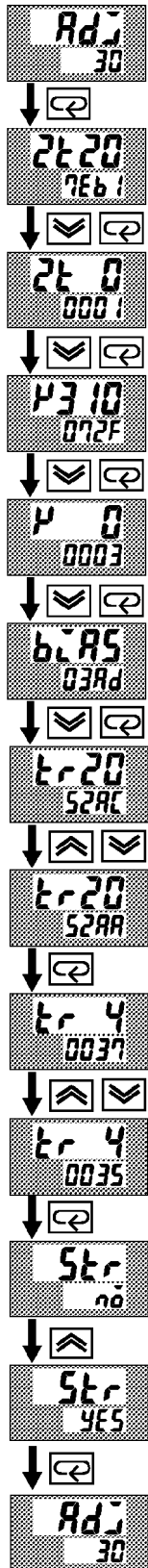

This example describes how to calibrate a thermocouple when the transfer output function is supported. If the transfer output function is not supported, skips steps (7) to (10).

- (1) When [Adj] is displayed, the 30-minute timer is displayed on the No.2 display and counts down. This timer serves as a guide for the aging time when aging is required.
- (2) First, calibrate the main input. Press the [] key to display [2t 20] (20mV calibration display). Set STV output to 20mV. When the value on the No.2 display has stabilized (changes of several digits max.), press the [] key to temporarily save the calibration data.
- (3) Press the [] key to display [2t 0] (0mV calibration display). Set STV output to 0mV. When the value on the No.2 display has stabilized (changes of several digits max.), press the [] key to temporarily save the calibration data.
- (4) Next, calibrate the cold junction compensator. Press the [] key to display [P3 10] (310mV calibration display). Set STV output to 310mV. When the value on the No.2 display has stabilized (changes of several digits max.), press the [] key to temporarily save the calibration data.
- (5) Press the [] key to display [P 0] (0mV calibration display). Set STV output to 0mV. When the value on the No.2 display has stabilized (changes of several digits max.), press the [] key to temporarily save the calibration data.
- (6) Finally, calibrate the bias compensation value. Disconnect the STV, and enable the thermocouple of the cold junction compensator. When carrying this out, make sure that the wiring on the STV is disconnected. Make sure that the cold junction compensator is set to 0°C and press the [] key. The display changes to [b 85] (calibration display for the bias compensation value). When the value on the No.2 display has stabilized (changes of several digits max.), press the [] key to temporarily save the calibration data.
- (7) Next, calibrate the transfer output function. If the transfer output function is not supported, skip to step (11). Press the [] key. The display changes to [t r 20] (20mA calibration display).
- (8) Set the output to 20mA by the [] or [] keys while monitoring the voltage on the digital multimeter. In the example on the left, the display indicates that the value two digits smaller than before calibration is “20mA”.
- (9) Press the [] key. The display changes to [t r 4] (4mA calibration display).
- (10) Set the output to 4mA by the [] or [] keys while monitoring the voltage on the digital multimeter. In the example on the left, the display indicates that the value two digits smaller than before calibration is “4mA”.
- (11) Press the [] key until the display changes to the data save display. Press the [] key. The No.2 display changes to [4E5], and two seconds later the calibration data is saved to internal memory. If you press the [] key when the No.2 display reads [n0], the calibration data is invalidated.
- (12) This completes calibration of the thermocouple 2 group. Press the [] key to return the display to [Adj].

■ Calibrating platinum resistance thermometer

● Preparation

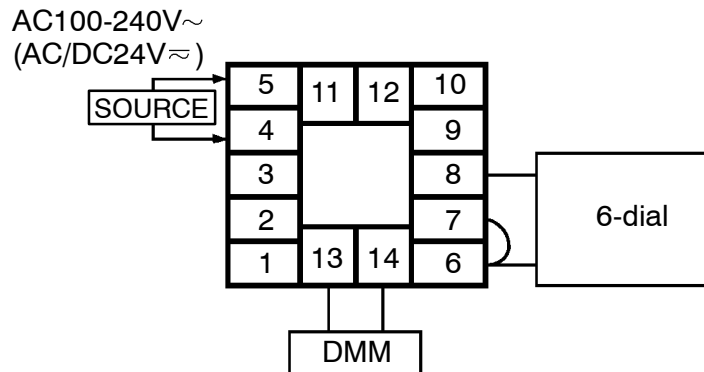

- Use leads of the same thickness when connecting to the platinum resistance thermometer.
- In the above figure, 6-dial refers to a precision resistance box, and DMM stands for a digital multimeter. However, note that the DMM is required only when the transfer output function is supported.
- Connect (short) the leads from terminal Nos. 6 and 7.

● Calibration

This example describes how to calibrate a platinum resistance thermometer when the transfer output function is supported. If the transfer output function is not supported, skips steps (7) to (10).

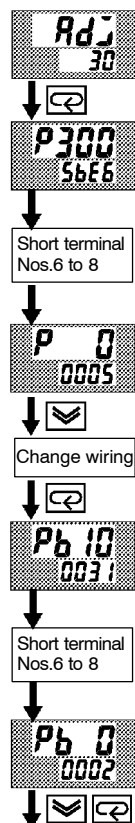

Cont'd on next page

- (1) When [Pd] is displayed, the 30-minute timer is displayed on the No.2 display and counts down. This timer serves as a guide for the aging time when aging is required.
- (2) First, calibrate the main input. Press the [P] key to display [P 300] (300Ω calibration display). Set the 6-dial to 300Ω. When the value on the No.2 display has stabilized (changes of several digits max.), press the [V] key to temporarily store the calibration data.
- (3) Press the [P] key to switch [P 0] (0Ω calibration) display. Short terminal No.6 to 8. When the value on the No.2 display has stabilized (changes of several digits max.), press the [V] key to temporarily store the calibration data.
- (4) Next, calibrate the B-B' input. Change the wiring as follows.

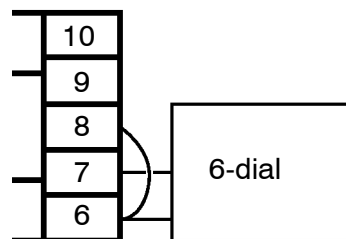

Make the connection across terminals 6 and 7 and the 6-dial as short as possible. Short terminals 6 and 8.

- (5) Press the [P] key to display [Pb 10] (10Ω calibration display). Set the 6-dial to 10Ω. When the value on the No.2 display has stabilized (changes of several digits max.), press the [V] key to temporarily store the calibration data.
- (6) Press the [P] key to display [Pb 0] (0Ω calibration display). Set the 6-dial to 10Ω. When the value on the No.2 display has stabilized (changes of several digits max.), press the [V] key to temporarily store the calibration data.

From previous page

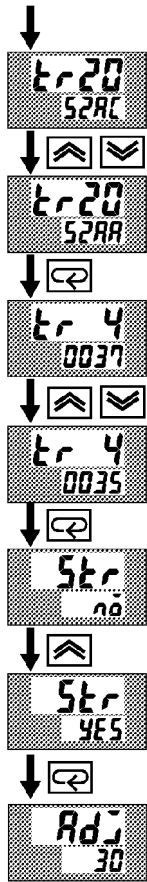

- (7) Next, calibrate the transfer output function. If the transfer output function is not supported, skip to step (11). Press the key. The display changes to [t r 20] (20mA calibration display).
- (8) Set the output to 20mA by the or keys while monitoring the voltage on the digital multimeter. In the example on the left, the display indicates that the value two digits smaller than before calibration is “20mA”.
- (9) Press the key. The display changes to [t r 4] (4mA calibration display).
- (10) Set the output to 4mA by the or keys while monitoring the voltage on the digital multimeter. In the example on the left, the display indicates that the value two digits smaller than before calibration is “4mA”.
- (11) Press the key until the display changes to the data save display. Press the key. The No.2 display changes to [YES], and two seconds later the calibration data is saved to internal memory. If you press the key when the No.2 display reads [no], the calibration data is invalidated.
- (12) This completes calibration of the platinum resistance thermometer. Press the key to return the display to [Adj].

■ Calibrating current input

● Preparation

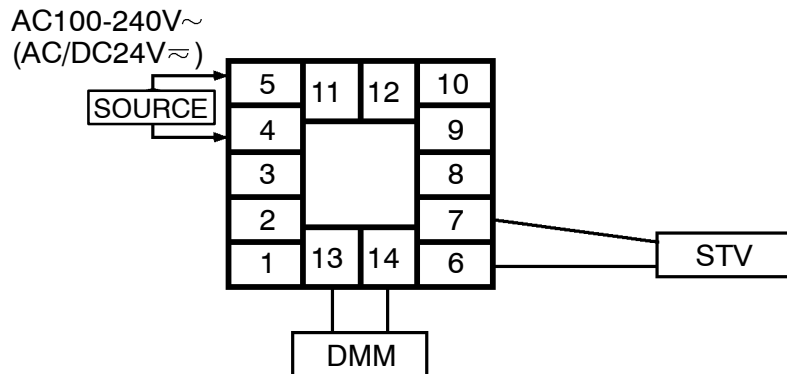

- In the above figure, STV refers to a standard DC current/voltage source, and DMM refers to a precision digital multimeter. However, note that the DMM is required only when the transfer output function is supported.

● Calibration

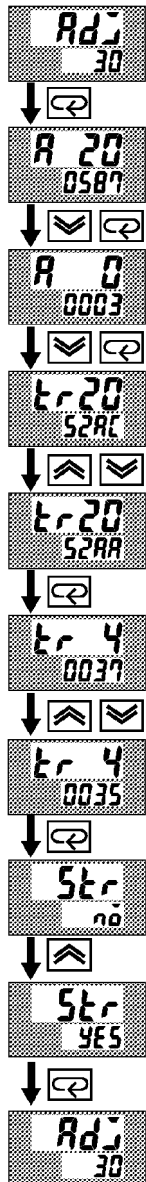

This example describes how to calibrate a current input when the transfer output function is supported. If the transfer output function is not supported, skips steps (4) to (7).

- (1) When [Adj] is displayed, the 30-minute timer is displayed on the No.2 display and counts down. This timer serves as a guide for the aging time when aging is required.
- (2) Press the key. The display changes to [A 20] (20mA calibration display). Set the STV output to 20mA. When the value on the No.2 display has stabilized (changes of several digits max.), press the key to temporarily store the calibration data.
- (3) Press the key. The display changes to [A 0] (0mA calibration display). Set the STV output to 0 mA. When the value on the No.2 display has stabilized (changes of several digits max.), press the key to temporarily store the calibration data.
- (4) Next, calibrate the transfer output function. If the transfer output function is not supported, skip to step (8). Press the key. The display changes to [tr 20] (20mA calibration display).
- (5) Set the output to 20mA by the or keys while monitoring the voltage on the digital multimeter. In the example on the left, the display indicates that the value two digits smaller than before calibration is “20mA”.
- (6) Press the key. The display changes to [tr 4] (4mA calibration display).
- (7) Set the output to 4mA by the or keys while monitoring the voltage on the digital multimeter. In the example on the left, the display indicates that the value two digits smaller than before calibration is “4mA”.
- (8) Press the key until the display changes to the data save display. Press the key. The No.2 display changes to [YES], and two seconds later the calibration data is saved to internal memory. If you press the key when the No.2 display reads [no], the calibration data is invalidated.
- (9) This completes calibration of current input. Press the key to return the display to [Adj].

Calibrating voltage input

● Preparation

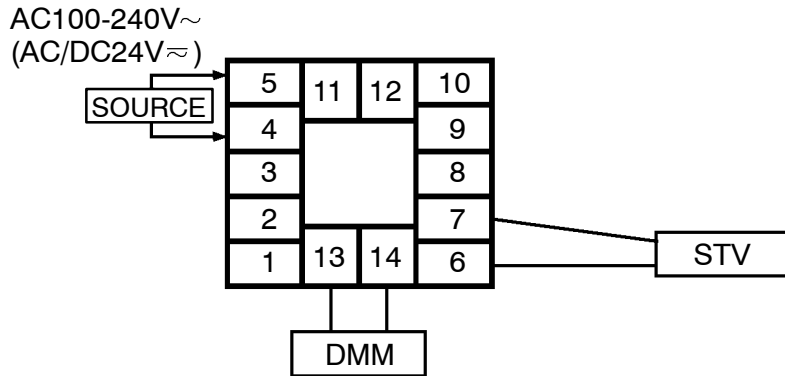

- In the above figure, STV refers to a standard DC current/voltage source, and DMM refers to a precision digital multimeter. However, note that the DMM is required only when the transfer output function is supported.

● Calibration: 0 to 5 V, 1 to 5 V

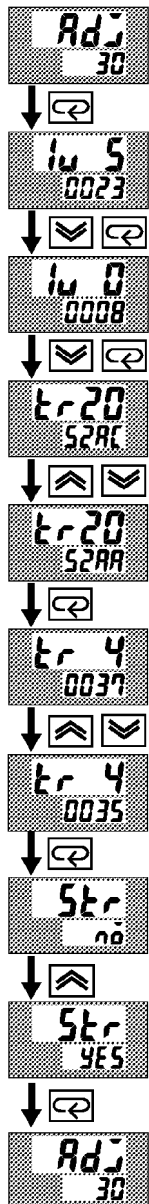

This example describes how to calibrate voltage input when the transfer output function is supported. If the transfer output function is not supported, skips steps (4) to (7).

- (1) When [Adj] is displayed, the 30-minute timer is displayed on the No.2 display and counts down. This timer serves as a guide for the aging time when aging is required.
- (2) Press the [Enter] key. The display changes to [u 5] (5 V calibration display). Set the STV output to 5V. When the value on the No.2 display has stabilized (changes of several digits max.), press the [Down] key to temporarily store the calibration data.
- (3) Press the [Enter] key. The display changes to [u 0] (0V calibration display). Set the STV output to 0V. When the value on the No.2 display has stabilized (changes of several digits max.), press the [Down] key to temporarily store the calibration data.
- (4) Next, calibrate the transfer output function. If the transfer output function is not supported, skip to step (8). Press the [Enter] key. The display changes to [tr 20] (20mA calibration display).
- (5) Set the output to 20mA by the [Down] or [Up] keys while monitoring the voltage on the digital multimeter. In the example on the left, the display indicates that the value two digits smaller than before calibration is “20mA”.
- (6) Press the [Enter] key. The display changes to [tr 4] (4mA calibration display).
- (7) Set the output to 4mA by the [Down] or [Up] keys while monitoring the voltage on the digital multimeter. In the example on the left, the display indicates that the value two digits smaller than before calibration is “4mA”.
- (8) Press the [Enter] key until the display changes to the data save display. Press the [Up] key. The No.2 display changes to [YES], and two seconds later the calibration data is saved to internal memory. If you press the [Enter] key when the No.2 display reads [00], the calibration data is invalidated.
- (9) This completes calibration of voltage input (0 to 5V, 1 to 5V). Press the [Enter] key to return the display to [Adj].

● Calibration : 0 to 10V

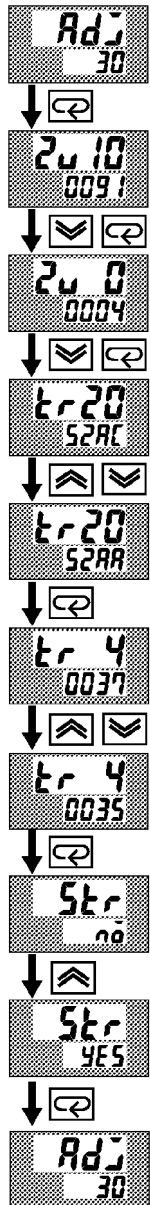

This example describes how to calibrate voltage input when the transfer output function is supported. If the transfer output function is not supported, skips steps (4) to (7).

- (1) When [Adj] is displayed, the 30-minute timer is displayed on the No.2 display and counts down. This timer serves as a guide for the aging time when aging is required.
- (2) Press the key. The display changes to [2u 10] (10V calibration display). Set the STV output to 10V. When the value on the No.2 display has stabilized (changes of several digits max.), press the key to temporarily store the calibration data.
- (3) Press the key. The display changes to [2u 0] (0V calibration display). Set the STV output to 0V. When the value on the No.2 display has stabilized (changes of several digits max.), press the key to temporarily store the calibration data.
- (4) Next, calibrate the transfer output function. If the transfer output function is not supported, skip to step (8). Press the key. The display changes to [tr 20] (20mA calibration display).
- (5) Set the output to 20mA by the or keys while monitoring the voltage on the digital multimeter. In the example on the left, the display indicates that the value two digits smaller than before calibration is “20mA”.
- (6) Press the key. The display changes to [tr 4] (4mA calibration display).
- (7) Set the output to 4mA by the or keys while monitoring the voltage on the digital multimeter. In the example on the left, the display indicates that the value two digits smaller than before calibration is “4mA”.
- (8) Press the key until the display changes to the data save display. Press the key. The No.2 display changes to [4E5], and two seconds later the calibration data is saved to internal memory. If you press the key when the No.2 display reads [na], the calibration data is invalidated.
- (9) This completes calibration of voltage input (0 to 10V). Press the key to return the display to [Adj].

■ Checking indication accuracy

- After calibrating input, make sure that you check indication accuracy to make sure that the E5CK controller has been correctly calibrated.
- Operate the E5CK controller in the PV/SP monitor (level 0 mode) mode.
- Check the indication accuracy at the upper and lower limits and mid-point.

● Thermocouple

- Preparation

The following figure shows the required device connection. Make sure that the E5CK controller and cold junction compensator are connected by a compensating conductor for the input type that is to be used during actual operation.

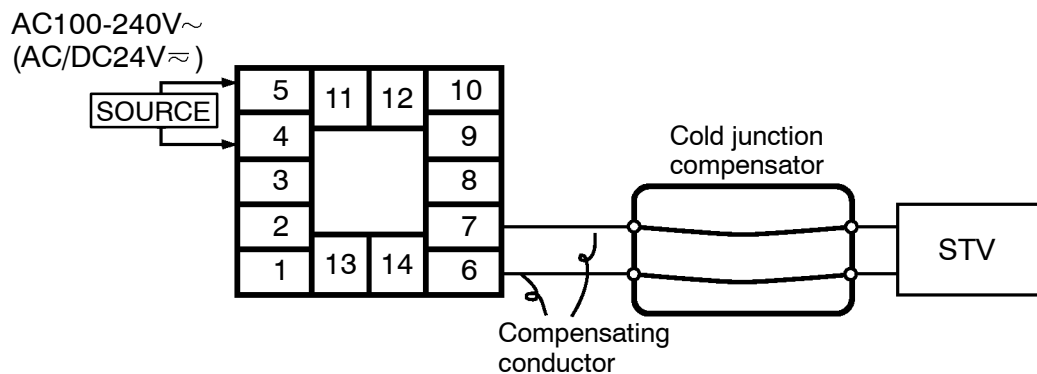

- Operation

Make sure that the cold junction compensator is at 0°C, and set STV output to the voltage equivalent to the starting power of the check value.

● Platinum resistance thermometer

- Preparation

The following figure shows the required device connection.

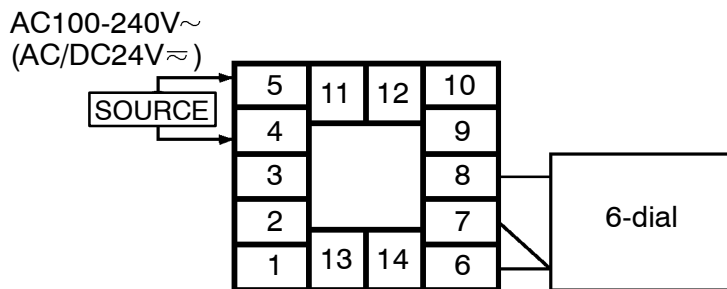

- Operation

Set the 6-dial to the resistance equivalent to the check value.

● Current or voltage input

- Preparation

The following figure shows the required device connection.

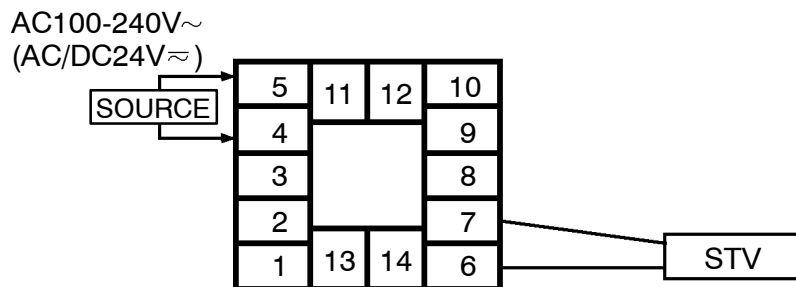

- Operation

Set the STV to the current or voltage value equivalent to the check value.

K CHAPTER 5

PARAMETERS

This chapter describes the parameters of the E5CK. Use this chapter as a reference guide.

Conventions Used in this Chapter	5-2
Protect Mode	5-3
Manual Mode	5-5
Level 0 Mode	5-6
Level 1 Mode	5-9
Level 2 Mode	5-15
Setup Mode	5-21
Expansion Mode	5-27
Option Mode	5-32
Calibration Mode	5-36

Conventions Used in this Chapter

■ The meaning of icons used in this chapter



Function

Describes the functions of the parameter.



Comment

Describes the range and defaults of the parameter setting.



Monitor

Used for monitor-dedicated parameters.
Describes the range of the monitor values.



Example
of use

Describes a procedure using parameters in operating instructions.



See

Describes related parameters and items.



Model

Describes models of the E5CK or option units supporting the parameter being described.

■ About parameter display

On the E5CK controller, only parameters that can be used are displayed. These parameters are displayed only when the “Conditions of Use” on the right of the parameter heading are satisfied. However, note that the settings of protected parameters are still valid, and are not displayed regardless of the conditions of use.

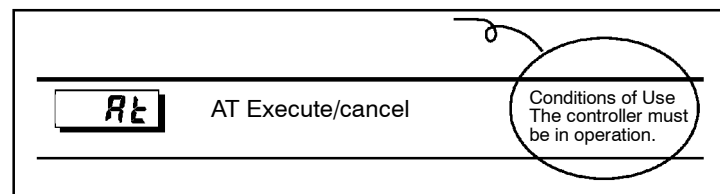

Protect Mode

- The protect mode is for disabling (protecting) the functions of the menu key or [A/M] key. Before changing parameters in this mode, first make sure that protecting the menu key or [A/M] key will not cause any problems in operation.
- To select this mode, press the [A/M] key and [↶] key simultaneously for 1 second minimum. To exit this mode, press the [A/M] key and [↶] key down again simultaneously for 1 second minimum.
- The following table shows the parameters supported in this mode and the page where the parameter is described.

Symbol	Parameter Name	Page
SECr	Security	5-3
PEYP	[A/M] key protect	5-4

SECr Security



Function

- This parameter specifies which parameters are protected. However, note that the protect mode and manual mode cannot be protected.



Comment

- When this parameter is set to “0” to “3”, only the modes indicated by the “○” mark in the table below can be selected on the menu display. For example, when this parameter is set to “2”, only level 0 to 2 modes can be selected.

Mode	Set value						
	0	1	2	3	4	5	6
Calibration	○						
Option	○	○					
Expansion	○	○					
Setup	○	○					
Level 2	○	○	○				
Level 1	○	○	○	○			
Level 0	○	○	○	○	○	○	*

- When this parameter is set to “4” to “6”, operations in only the level 0 mode can be selected, and the mode is not displayed on the menu display.
- When this parameter is set to “5”, only the “PV/SP” parameter in the level 0 mode can be used.
- When this parameter is set to “6”, only the “PV/SP” parameter in the level 0 mode can be used. (The set point cannot change.)
- Default is “1”. (Only the calibration mode is protected.)



See

- Related article
3.5 Protect Mode (page 3-10)

Protect Mode

PEYP [A/M] key protect





Function

- Invalidate the function of the  key. In other words, you cannot switch between the auto and manual operations by key operation.



Comment





- [$\bar{0}n$] :  key protect ON
- [$\bar{0}FF$] :  key protect canceled
- Default = [$\bar{0}FF$]



See

- Related article
3.5 Protect Mode (page 3-10)



Manual Mode

- In this mode, manual operations are possible, and the “MANU” LED lights.
- When this mode is selected, the manipulated variable that was active immediately before the mode was switched to is output. When changing the manipulated variable, change it using the  or  keys. When this mode is selected during auto-tuning, auto-tuning is canceled.
- To select this mode when in the level 0 to 2 modes, press the  key for 1 second minimum. To exit this mode, press the  key for 1 second minimum. The mode changes to the level 0 mode.
- “Manual MV” is the only parameter available in this mode.

Manual MV



Function

- Set the manipulated variable for manual operation.
- The process value is displayed on the No.1 display, and the manipulated variable is displayed on the No.2 display. Change the manipulated variable using the  or  keys.

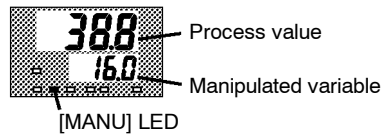

The manual manipulated variable is held when the power is interrupted.



Comment





Control Method	Setting Range	Unit	Default
Standard	-5.0 to 105.0	%	0
Heating and cooling	-105.0 to 105.0	%	0



See

- Related article
3.7 Adjusting Control Operation (page 3-12)

Level 0 Mode

- The parameters in this mode can be used only when the “security” parameter (protect mode) is set to “0” to “4”.
- The “PV/SP” parameter can also be used when the “Security” parameter is set to “5” or “6”. However, note that when set to “6”, the SP cannot be changed.
- This mode is used for monitoring the process value, set point and manipulated variable during operation, and for checking and setting the SP setting value. It is also used for starting and stopping controller operation.
- To select this mode when in the levels 1 and 2, setup, expansion, option and calibration modes, press the  key for 1 second minimum. The display changes to the menu display. If you select [L U - 0] then press  key for 1 second minimum, the controller enters the level 0 mode.
- To select parameters in this mode, press the  key. To change parameter settings, use the  or  keys.
- The following table shows the parameters supported in this mode and the page where the parameter is described.

Symbol	Parameter Name	Page
	PV/SP	5-6
SP - \bar{n}	Set point during SP ramp	5-7
\bar{o}	MV monitor (heat)	5-7
[- \bar{o}	MV monitor (cool)	5-7
r - S	Run/Stop	5-8

PV/SP



Process value
Set point



Function

- The process value is displayed on the No.1 display, and the set point is displayed on the No.2 display. The set point can be set.
- When the multi-SP function is in use, the value of whichever is set, set point 0 or 1, is linked.
- The decimal point position is dependent on the selected sensor during temperature input and on the results of scaling during analog input.



Comment

- Process value

Monitor Range	Unit
Scaling lower limit -10%FS to scaling upper limit +10%FS	EU

During temperature input, the range of the currently selected sensor is taken as the monitor range.

- Set point

Setting Range	Unit	Default
SP setting lower limit to SP setting upper limit	EU	0



See

- Related article
3.7 Adjusting Control Operation (page 3-12)
- Related parameters
“Input type” “Scaling upper limit” “Scaling lower limit” “Decimal point” (setup mode)
“SP setting upper limit” “SP setting lower limit” (expansion mode)

SP - \bar{n}

Set point during SP ramp

Conditions of Use
The SP ramp function must be enabled.



Function

- Sets the set point.



Monitor

Monitor Range	Unit	Default
SP setting lower limit to SP setting upper limit	EU	0



See

- Related article
3.7 Adjusting Control Operation (page 3–12)
- Related parameters
“PV/SP” (level 0 mode)
“SP ramp time unit” “SP ramp set value” (level 2 mode)
“Set point upper limit” “Set point lower limit (expansion mode)”

\bar{a}

MV monitor (heat)

$\bar{c} - \bar{a}$

MV monitor (cool)



Function

- This parameter cannot be set.
- Monitors the manipulated variable on the heating or cooling side.
- The manipulated variable in a standard control system is checked in the “MV monitor (heat)” parameter.
- The “MV monitor (cool)” parameter can be used only during heating and cooling control.



Monitor

- MV monitor (heat)

Control	Monitor Range	Unit
Standard	-5.0 to 105.0	%
Heating and cooling	0.0 to 105.0	%

- MV monitor (cool)

Control	Monitor Range	Unit
Heating and cooling	0.0 to 105.0	%

Level 0 Mode

r-5

Run/Stop





Function

- This parameter is used for checking the operating status of the controller, and for specifying start and stop of operation.
- When the “run/stop” function is assigned to event input, “stop” is set when event input is ON, and “run” is set when event input is OFF. Parameter setting follows event input, even if attempting to change settings by key operation.



Example of use





- To start operation, set this parameter to [rU α] press the  or  keys. To stop operation, set this parameter to [St α P]. When operation is stopped, the “STOP” LED lights.
- Default is [rU α]



See

- Related article
3.6 Starting and Stopping Operation (page 3-11)

Level 1 Mode

- The parameters in this mode can be used only when the “security” parameter (protect mode) is set to “0” to “3”.
- This mode contains the main parameters for adjusting control. These parameters include parameters for executing AT (auto-tuning), setting the alarm values, setting the control period, and setting PID parameters.
- To select this mode when in the levels 0 and 2, setup, expansion, option and calibration modes, press the  key for 1 second minimum. The display changes to the menu display. If you select [L u - !] then press the  key for 1 second minimum, the controller enters the level 1 mode.
- To select parameters in this mode, press the  key. To change parameter settings, use the  or  keys.
- The following table shows the parameters supported in this mode and the page where the parameter is described.

Symbol	Parameter Name	Page
AL	AT Execute/Cancel	5-10
SP-0	Set point 0	5-10
SP-1	Set point 1	5-10
AL-1	Alarm value 1	5-11
AL-2	Alarm value 2	5-11
AL-3	Alarm value 3	5-11
P	Proportional band	5-11
I	Integral time	5-11
d	Derivative time	5-11
[- SC	Cooling coefficient	5-12
[- db	Dead band	5-12
oF - r	Manual reset value	5-13
HYS	Hysteresis (heat)	5-13
[HYS	Hysteresis (cool)	5-13
[P	Control period (heat)	5-14
[- [P	Control period (cool)	5-14

Level 1 Mode



AT Execute/Cancel

Conditions of Use

The controller must be in operation, control must be advanced PID control, and ST must be set to OFF.



Function

- Selects the limit cycle of MV change width (40% or 100%) for execution. After AT execution, the “PID” and the “LBA detection time” (LBA: Loop Break Alarm) parameters are set automatically.

- During heating and cooling control, only 100%AT can be executed.



Example of use

- When this parameter is selected, the setting becomes [δFF].
- To execute 40%AT, select [$AT - 1$], and to execute 100%AT, select [$AT - 2$]. During execution of auto-tuning, the AT LED flashes. However, note that during heating and cooling control, [$AT - 1$] is not displayed.

- When AT execution ends, the parameter setting automatically returns to [δFF].



See

- Related article
3.7 Adjusting Control Operation (page 3-13)
- Related parameters
“Run/Stop” (level 0 mode)
“Proportional band” “Integral time” “Derivative time” (level 1 mode)
“LBA detection time” (level 2 mode)



Set point 0

Conditions of Use

The multi-SP function must be in operation.



Set point 1



Function

- When event input is OFF, the “set point 0” parameter is used, and when ON, the “set point 1” parameter is used.
- When the “set point” parameter has been changed, the setting of whichever is selected in event input, “set point 0” or “set point 1”, is linked and changed.
- The decimal point position is dependent on the selected sensor during temperature input and on the results of scaling during analog input.



Comment

Setting Range	Unit	Default
Scaling lower limit to Scaling upper limit	EU	0



See

- Related article
4.3 How to Use Option Functions (page 4-8)
- Related parameters
“Multi-SP function” (option mode)
“Set point” (level 0 mode)
“Input type” “Scaling upper limit” “Scaling lower limit” “Decimal point” (setup mode)

AL - 1

Alarm value 1

AL - 2

Alarm value 2

AL - 3

Alarm value 3

Conditions of Use

Alarms must be assigned as outputs. For example, if alarm outputs 1 and 2 only are assigned as outputs, the “alarm value 3” parameter cannot be used.



Function

- This parameter is used for monitoring or changing the alarm values of alarm outputs 1 to 3.
- During temperature input, the decimal point position is dependent on the currently selected sensor, and during analog input on the results of scaling.



Comment

Setting Range	Unit	Default
-1999 to 9999	EU	0



See

- Related article
3.7 Adjusting Control Operation (page 3-12)
- Related parameters
“Input type” “Scaling upper limit” “Scaling lower limit” “Decimal point” “Control output 1 assignment” “Control output 2 assignment” “Auxiliary output 1 assignment” “Alarm 1 type” “Alarm 2 type” “Alarm 3 type” “Alarm 1 open in alarm” “Alarm 2 open in alarm” “Alarm 3 open in alarm” (setup mode)
“Alarm 1 hysteresis” “Alarm 2 hysteresis” “Alarm 3 hysteresis” (level 2 mode)
“Standby sequence reset method” (expansion mode)

P

Proportional band

Conditions of Use

Control must be advanced PID control, and ST must be set to OFF.

I

Integral time

d

Derivative time



Function

- Sets the PID parameters. However, note that the PID parameter settings are changed to optimum values when auto-tuning is executed, and self-tuning is selected.



Comment

Parameter	Setting Range	Unit	Default
Proportional band	0.1 to 999.9	%FS	10.0
Integral time	0 to 3999	Second	233
Derivative time	0 to 3999	Second	40



See

- Related parameter
“AT Execute/Cancel” (level 1 mode)

Level 1 Mode

C-5C

Cooling coefficient

Conditions of Use

The control must be heating and cooling control, and advanced PID control.



Function

- In heating and cooling control, P at the cooling side is calculated by the following formula:

$$\text{Cooling side P} = \text{cooling coefficient} \times P$$



Comment

Setting Range	Unit	Default
0.01 to 99.99	None	1.00



See

- Related article
4.1 Selecting the Control Method (page 4-2)
- Related parameter
“Proportional band” (level 1 mode)

C-db

Dead band

Conditions of Use

The control system must be heating and cooling control.



Function

- Sets the output dead band width in a heating and cooling control system. A negative setting sets an overlap band.



Comment

Setting Range	Unit	Default
-19.99 to 99.99	%FS	0.00



See

- Related article
4.1 Selecting the Control Method (page 4-2)

OF-r

Manual reset value

Conditions of Use

The control must be standard control, advanced PID control, ST must be set to OFF, and the “integral time” parameter must be set to “0”.



Function

- Sets the required manipulated variable to remove offset during stabilization of P or PD control.



Comment

Setting Range	Unit	Default
0.0 to 100.0	%	50.0

HYS

Hysteresis (heat)

Conditions of Use

The control system must be ON/OFF control.

CHYS

Hysteresis (cool)



Function

- Sets the hysteresis for ensuring stable operation at ON/OFF switching.
- In standard control, use the “hysteresis (heat)” parameter. The “hysteresis (cool)” parameter cannot be used.
- In heating and cooling control, the hysteresis can be set independently for heating and cooling. Use the “hysteresis (heat)” parameter to set the heating side hysteresis, and use the “hysteresis (cool)” parameter to set the cooling side hysteresis.



Comment

Parameter	Setting Range	Unit	Default
Hysteresis (heat)	0.01 to 99.99	%FS	0.10
Hysteresis (cool)	0.01 to 99.99	%FS	0.10



See

- Related article
 - 4.1 Selecting the Control Method (page 4-3)
- Related parameters
 - “Control output 1 assignment” “Control output 2 assignment” (setup mode)
 - “PID / ON/OFF” (expansion mode)

Level 1 Mode



Control period (heat)



Control period (cool)

Conditions of Use

Relay or voltage output must be set as the outputs, and the control must be set to advanced PID control.



Function

- Sets the pulse output period. Set the control period taking the control characteristics and life expectancy of the controller into consideration.
- In standard control, use the “control period (heat)” parameter. The “control period (cool)” parameter cannot be used.
- In heating and cooling control, the control period can be set independently for heating and cooling. Use the “control period (heat)” parameter to set the heating side control period, and use the “control period (cool)” parameter to set the cooling side control period.



Comment







Parameter	Setting Range	Unit	Default
Control period (heat)	1 to 99	Second	20
Control period (cool)	1 to 99	Second	20



See

- Related article
3.3 Setting Output Specifications (page 3-5)
- Related parameters
“Control output 1 assignment” “Control output 2 assignment” (setup mode)

Level 2 Mode

- The parameters in this mode can be used only when the “security” parameter (protect mode) is set to “0” to “2”.
- This mode contains the auxiliary parameters for adjusting control. These parameters include parameters for limiting the manipulated variable and set point, parameters for switching between remote and local operation, and parameters for setting the LBA (Loop Break Alarm), alarm hysteresis, and input digital filter values.
- To select this mode when in the levels 0 and 1, setup, expansion, option and calibration modes, press the  key for 1 second minimum. The display changes to the menu display. If you select [L u - 2] using the   key then press the  key for 1 second minimum, the controller enters the level 2 mode.
- To select parameters in this mode, press the  key. To change parameter settings, use the  or  keys.
- The following table shows the parameters supported in this mode and the page where the parameter is described.

Symbol	Parameter Name	Page
r-L	Remote/Local	5-16
SPrU	SP ramp time unit	5-16
SPrE	SP ramp set value	5-16
LbA	LBA detection time	5-17
n̄u-S	MV at stop	5-17
n̄u-E	MV at PV error	5-17
ōL-H	MV upper limit	5-18
ōL-L	MV lower limit	5-18
ōrL	MV change rate limit	5-18
īnF	Input digital filter	5-19
ALH1	Alarm 1 hysteresis	5-19
ALH2	Alarm 2 hysteresis	5-19
ALH3	Alarm 3 hysteresis	5-19
īnSH	Input shift upper limit (temperature)	5-20
īnSL	Input shift lower limit (temperature)	5-20

Level 2 Mode



Remote/Local

Conditions of Use
The communications function must be in use.



Function

- Switches between remote and local operation.
- To change the parameter setting during remote operation, use the communications function. To change the parameter setting during local operation, change the setting on the E5CK controller.
- You can check the parameter setting by both communications and on the E5CK controller regardless of whether the controller is switched to remote or local operation.



Comment

Setting Range	Default
[r \bar{n}]: remote / [L \bar{C}]: local	[L \bar{C}]



SP ramp time unit

Conditions of Use
ST must be set to OFF.



SP ramp set value



Function

- Specifies the change rate during SP ramp operation. Set the maximum permissible change width per unit of time (minute or hour) as the “SP ramp set value”. However, note that when set to “0”, the SP ramp function is disabled.
- The time unit and SP ramp set value are independent of each other. For example, when setting “30 per minute”, set the “SP ramp set value” parameter to “30” and the “SP ramp time unit” parameter to [\bar{n}] (“minute”). However, if you change the time unit only to [\bar{H}] (“hour”), the set time becomes “30 per hour.”
- During temperature input, the decimal point position of the SP ramp set value is dependent on the currently selected sensor, and during analog input on the results of scaling.



Comment

Parameter	Setting Range	Unit	Default
SP ramp time unit	[\bar{n}]: minute/ [\bar{H}]: hour	None	\bar{n}
SP ramp set value	0 to 9999	EU	0

During temperature input, the range of the currently selected sensor it taken as the setting range for the “SP ramp set value” parameter.



See

- Related article
4.2 Operating Condition Restrictions (page 4-5)
- Related parameters
“Input type” “Scaling upper limit” “Scaling lower limit” “Decimal point” (setup mode)

LBA

LBA detection time

Conditions of Use

The LBA (Loop Break Alarm) function must be assigned as an output.



Function

- This parameter is automatically set by AT execution.
- The LBA is output if the change width of the process value falls below 0.2 %full-scale of the time preset to this parameter when the manipulated variable is set in the “MV upper limit” or “MV lower limit” parameters.
- The LBA function is disabled when this parameter is set to “0”.



Comment

Setting Range	Unit	Default
0 to 9999	Second	0



See

- Related article
 - 4.4 LBA (page 4-9)
 - 7.3 How to Use Error Output (page 7-5)
- Related parameters
 - “AT Execute/Cancel” (level 1 mode)
 - “Control output 1 assignment” “Control output 2 assignment” “Auxiliary output 1 assignment” (setup mode)

MV-5

MV at stop

MV-E

MV at PV error



Function



Comment

- The “MV at stop” parameter sets the manipulated variable when operation stops.
- The “MV at PV error” parameter sets the manipulated variable when an input error occurs.
- The setting ranges during standard control and heating and cooling control are different.
- The manipulated variable at the cooling side during heating and cooling control is expressed as a negative value.

Control Method	Setting Range	Unit	Default
Standard	-5.0 to 105.0	%	0
Heating and cooling	-105.0 to 105.0	%	0



See

- Related articles
 - MV at stop : 3.6 Starting and Stopping Operation (page 3-11)
 - MV at PV error : 7.2 How to Use the Error Display (page 7-3)

Level 2 Mode

OL-H

MV upper limit

OL-L

MV lower limit

ORL

MV change rate limit

Conditions of Use

The control must be advanced PID control, and ST must be set to OFF.



Function

- The “MV upper limit” and “MV lower limit” parameters set the upper and lower limits of the manipulated variable. When the manipulated variable calculated by the E5CK controller is outside of the upper-and lower-limit range, the upper limit or lower limit set to these parameters is output, respectively.
- The “MV change rate limit” parameter sets the maximum permissible change width per second of the manipulated variable. If a change in the manipulated variable causes this parameter setting to be exceeded, the calculated value is reached while changing the value by the per-second value set in this parameter. The “MV change rate limit” function is disabled when this parameter is set to “0.0”.



Comment

- MV upper limit
The setting ranges during standard control and heating and cooling control are different. Also, the manipulated variable at the cooling side during heating and cooling control is expressed as a negative value.

Control Method	Setting Range	Unit	Default
Standard	MV lower limit +0.1 to 105.0	%	105.0
Heating and cooling	0.0 to 105.0	%	105.0

- MV lower limit
The setting ranges during standard control and heating and cooling control are different. Also, the manipulated variable at the cooling side during heating and cooling control is expressed as a negative value.

Control Method	Setting Range	Unit	Default
Standard	-5.0 to MV upper limit -0.1	%	-5.0
Heating and cooling	-105.0 to 0.0	%	-105.0

- MV change rate limit

Setting Range	Unit	Default
0.0 to 100.0	%	0.0



See

- Related article
4.2 Operating Condition Restrictions (page 4-4)

INF

Input digital filter



Function

- Sets the time constant of the input digital filter. The following figure shows the effect on data after passing through the digital filter.

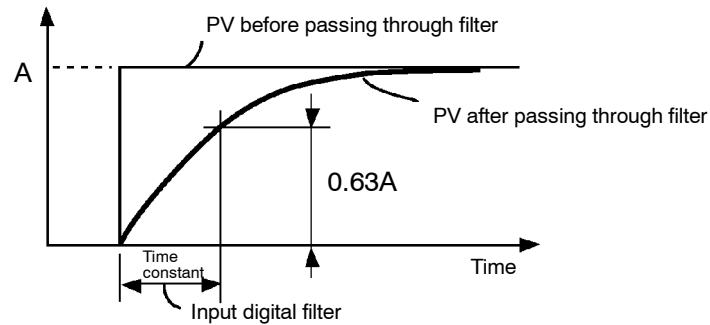

Comment

Setting Range	Unit	Default
0 to 9999	Second	0

ALH1

Alarm 1 hysteresis

ALH2

Alarm 2 hysteresis

ALH3

Alarm 3 hysteresis

Conditions of Use

Alarms must be assigned as outputs. For example, if alarm outputs 1 and 2 only are assigned as outputs, the “alarm 3 hysteresis” parameter cannot be used.



Function

- This parameter is for checking the hysteresis of alarm outputs 1 to 3.



Comment

Setting Range	Unit	Default
0.01 to 99.99	%FS	0.02



See

- Related article
3.4 Setting Alarm Type (page 3-7)
- Related parameters
“Alarm 1 type” “Alarm 2 type” “Alarm 3 type” “Alarm 1 open in alarm” “Alarm 2 open in alarm” “Alarm 3 open in alarm” (setup mode)
“Alarm value 1” “Alarm value 2” “Alarm value 3” (level 1 mode)

Level 2 Mode

LnSH

Input shift upper limit

LnSL

Input shift lower limit

Conditions of Use

The input type must be set to temperature input (thermocouple or platinum resistance thermometer).



Function

- Sets each of the shift amounts for the input shift upper and lower limit values.



Comment







Setting Range	Unit	Default
-199.9 to 999.9	°C or °F	0.0



See

- Related article
3.2 Setting Input Specifications (page 3-3)
- Related parameter
“Input type” (setup mode)

Setup Mode

- The parameters in this mode can be used only when the “security” parameter (protect mode) is set to “0” and “1”.
- This mode contains the parameters for setting the basic specifications of the E5CK controller. These parameters include parameters for specifying the input type, scaling, output assignments, and direct/reverse operation.
- To select this mode when in the levels 0 to 2, expansion, option and calibration modes, press the  key for 1 second minimum. The display changes to the menu display. If you select [5Et] using the   key then press the  key for 1 second minimum, the controller enters the setup mode.
- To select parameters in this mode, press the  key. To change parameter settings, use the  or  keys.
- The following table shows the parameters supported in this mode and the page where the parameter is described.

Symbol	Parameter Name	Page
in-t	Input type	5-22
in-H	Scaling upper limit	5-23
in-L	Scaling lower limit	5-23
dP	Decimal point	5-23
d-U	°C/°F selection	5-24
inIt	Parameter initialize	5-23
out1	Control output 1 assignment	5-24
out2	Control output 2 assignment	5-24
Sub1	Auxiliary output 1 assignment	5-25
ALt1	Alarm 1 type	5-25
ALIn	Alarm 1 open in alarm	5-26
ALt2	Alarm 2 type	5-25
AL2n	Alarm 2 open in alarm	5-26
ALt3	Alarm 3 type	5-25
AL3n	Alarm 3 open in alarm	5-26
orEv	Direct/Reverse operation	5-26

Setup Mode

In-t

Input type



Function



Comment

- Match the setting (software) of this parameter with the setting (hardware) of the input type jumper connector.
- Set the input types to be connected to terminal Nos. 6 to 8 by the input type codes in the table below.
- Set the code according to the following table. Default is “2: K1 thermocouple”.

Set value	Input Type			Jumper Position
0	JPt	-199.9 to 650.0 (°C) / -199.9 to 999.9 (°F)	Platinum resistance thermometer	TC·PT
1	Pt	-199.9 to 650.0 (°C) / -199.9 to 999.9 (°F)		
2	K1	-200 to 1300 (°C) / -300 to 2300 (°F)	Thermocouple	TC·PT
3	K2	0.0 to 500.0 (°C) / 0.0 to 900.0 (°F)		
4	J1	-100 to 850 (°C) / -100 to 1500 (°F)		
5	J2	0.0 to 400.0 (°C) / 0.0 to 750.0 (°F)		
6	T	-199.9 to 400.0 (°C) / -199.9 to 700.0 (°F)		
7	E	0 to 600 (°C) / 0 to 1100 (°F)		
8	L1	-100 to 850 (°C) / -100 to 1500 (°F)		
9	L2	0.0 to 400.0 (°C) / 0.0 to 750.0 (°F)		
10	U	-199.9 to 400.0 (°C) / -199.9 to 700.0 (°F)		
11	N	-200 to 1300 (°C) / -300 to 2300 (°F)		
12	R	0 to 1700 (°C) / 0 to 3000 (°F)		
13	S	0 to 1700 (°C) / 0 to 3000 (°F)		
14	B	100 to 1800 (°C) / 300 to 3200 (°F)		
15	W	0 to 2300 (°C) / 0 to 4100 (°F)		
16	PLII	0 to 1300 (°C) / 0 to 2300 (°F)		
17	4 to 20mA		Current input	I
18	0 to 20mA			
19	1 to 5V		Voltage input	V
20	0 to 5V			
21	0 to 10V			



See

- Related article
3.2 Setting Input Specifications (page 3-3)
- Related parameters
When input type is set to temperature input:
“°C/°F selection” (setup mode)
When input type is set to voltage input or current input:
“Scaling upper limit” “Scaling lower limit” “Decimal point” (setup mode)

Ln-H

Scaling upper limit

Conditions of Use

The input type must be set to analog input (voltage or current input).

Ln-L

Scaling lower limit

dP

Decimal point



Function

- This parameter can be used only when voltage input or current input is selected as the input type.
- When voltage input or current input is selected as the input type, scaling is carried out. Set the scaling upper limit in the “scaling upper limit” parameter and the scaling lower limit in the “scaling lower limit” parameter.
- The “decimal point” parameter specifies the decimal point position of parameters (set point, etc.) whose unit is set to EU (Engineering Unit).



Comment

- Scaling upper limit, Scaling lower limit

Parameter	Setting Range	Unit	Default
Scaling upper limit	Scaling lower limit +1 to 9999	EU	100
Scaling lower limit	-1999 to scaling upper limit -1	EU	0

- Decimal point : default : 0

Set Value	Setting	Example
0	0 digits past decimal point	1234
1	1 digit past decimal point	123.4
2	2 digits past decimal point	12.34
3	3 digits past decimal point	1.234



See

- Related article
3.2 Setting Input Specifications (page 3-3)
- Related parameter
“Input type” (setup mode)

Init

Parameter initialize



Function

- Returns parameter settings to their defaults. However, note that the following parameters are not affected by execution of this parameter: “input type”, “scaling upper limit”, “scaling lower limit”, “decimal point” and “°C/°F selection”.



Example of use

- When this parameter is selected, [nō] (“no”) is first displayed. To initialize parameters, press the  key to specify [yēs] (“yes”).

Setup Mode

d-U

°C/°F selection

Conditions of Use

The input type must be set to temperature input (thermocouple or platinum resistance thermometer).



Function

- This parameter can be used when thermocouple or platinum resistance thermometer is selected as the input type.
- Set the temperature input unit to either of “°C” or “°F”.



Comment

Setting Range	Default
[:°C / F :°F	[



See

- Related article
3.2 Setting Input Specifications (page 3-3)
- Related parameter
“Input type” (setup mode)

out 1

Control output 1 assignment

out 2

Control output 2 assignment



Function

- Assigns the output functions to either of control output 1 or 2.
- The following six output functions can be assigned as outputs:
Control output (heat), Control output (cool), Alarms 1 to 3, and LBA.
- Errors 1 and 2 cannot be assigned as outputs.
- When the output function assigned to control output 1 is ON, the OUT1 LED lights. However, note that the OUT1 LED does not light when control output (heat) or control output (cool) are assigned to linear outputs such as current and voltage.
- When the output function assigned to control output 2 is ON, the OUT2 LED lights.



Comment

Symbol	HEAT	COOL	AL-1	AL-2	AL-3	LBA
Function	Control output (heat)	Control output (cool)	Alarm 1	Alarm 2	Alarm 3	LBA

Defaults:

“Control output 1” = [HEAT], “Control output 2” = [AL-1]



See

- Related article
3.3 Setting Output Specifications (page 3-5)
- Related parameters
 - Alarm-related parameters
 - Heating and cooling related parameter
“LBA detection time” (level 2 mode)

SUB1 Auxiliary output 1 assignment

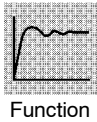

- Assigns output functions to auxiliary output 1. The following six output functions can be assigned as outputs:
Alarms 1 to 3, LBA, Error 1 (input error), and Error 2 (A/D converter error).
- Control output (heat) and control output (cool) cannot be assigned as outputs.
- When the output function assigned to auxiliary output 1 is ON, the SUB1 LED lights.



Symbol	AL-1	AL-2	AL-3	LbA	S.Err	E333
Function	Alarm 1	Alarm 2	Alarm 3	LBA	Error 1	Error 2

Defaults: [AL-2]



- Related article
3.3 Setting Output Specifications (page 3-5)
- Related parameter
• Alarm-related parameter
“LBA detection time” (level 2 mode)

AL1 Alarm 1 type

AL2 Alarm 2 type

AL3 Alarm 3 type

Conditions of Use

Alarms must be assigned as outputs. For example, if alarm outputs 1 and 2 only are assigned as outputs, the “alarm 3 type” parameter cannot be used.

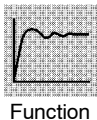

- “Alarm 1 to 3 type” parameters specify the operation of the alarm by the one of the set values in the following table. For details of operation at an alarm, see page 3-7.



Set Value	Settings	Set Value	Settings
1	Upper-and lower-limit alarm (deviation)	7	Lower-limit alarm with standby sequence (deviation)
2	Upper-limit alarm (deviation)	8	Absolute-value upper-limit alarm
3	Lower-limit alarm (deviation)	9	Absolute-value lower-limit alarm
4	Upper-and lower-limit range alarm (deviation)	10	Absolute-value upper-limit alarm with standby sequence
5	Upper-and lower-limit alarm with standby sequence (deviation)	11	Absolute-value lower-limit alarm with standby sequence
6	Upper-limit alarm with standby sequence (deviation)		

Defaults: Deviation upper limit

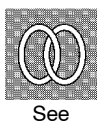

- Related article
3.4 Setting Alarm Type (page 3-7)
- Related parameters
“Alarm value 1” “Alarm value 2” “Alarm value 3” (level 1 mode)
“Alarm 1 hysteresis” “Alarm 2 hysteresis” “Alarm 3 hysteresis” (level 2 mode)
“Alarm 1 open in alarm” “Alarm 2 open in alarm” “Alarm 3 open in alarm” “Control output 1 assignment” “Control output 2 assignment” (setup mode)

Setup Mode

AL1n

Alarm 1 open in alarm

AL2n

Alarm 2 open in alarm

AL3n

Alarm 3 open in alarm

Conditions of Use

Alarms must be assigned as outputs. For example, if alarm outputs 1 and 2 only are assigned as outputs, the “alarm 3 open in alarm” parameter cannot be used.

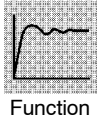

Function

- Selects the output states of alarms 1 to 3.
- When the controller is set to “close in alarm,” the status of the alarm output function is output as it is. When set to “open in alarm,” the status of the alarm output function is output inverted. The following table shows the relationship between alarm output functions, output and output LEDs.

	Alarm	Output	Output LED
Close in alarm	ON	ON	Lit
	OFF	OFF	Not lit
Open in alarm	ON	OFF	Lit
	OFF	ON	Not lit



Comment

Setting Range	Default
n - ā: Close in alarm/ n - ā̄: Open in alarm	n - ā̄

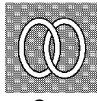

See

- Related article
3.3 Setting Output Specifications (page 3-5)
- Related parameters
“Alarm value 1” “Alarm value 2” “Alarm value 3” (level 1 mode)
“Alarm 1 hysteresis” “Alarm 2 hysteresis” “Alarm 3 hysteresis” (level 2 mode)
“Alarm 1 open in alarm” “Alarm 2 open in alarm” “Alarm 3 open in alarm”
“Control output 1 assignment” “Control output 2 assignment” (setup mode)

ā̄rēu

Direct/Reverse operation

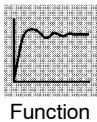

Function

- “Direct operation” (or normal operation) refers to control where the manipulated variable is increased according to the increase in the process value. Alternatively, “reverse operation” refers to control where the manipulated variable is increased according to the decrease in the process value.

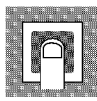

Comment



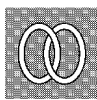



Setting Range	Default
ā̄r - r: Reverse operation/ ā̄r - ā̄: Direct operation	ā̄r - r



See

- Related article
3.3 Setting Output Specifications (page 3-5)

Expansion Mode

- The parameters in this mode can be used only when the “security” parameter (protect mode) is set to “0” and “1”.
- This mode contains the parameters for setting expanded functions. These parameters include parameters for setting ST (self-tuning), setting the SP setting limiter, selecting advanced PID and ON/OFF control, specifying the standby sequence reset method, and automatic return of display mode.
- To select this mode when in the levels 0 to 2, setup, option and calibration modes, press the  key for 1 second minimum. The display changes to the menu display. If you select [ESt] using the   key then press the  key for 1 second minimum, the controller enters the expansion mode.
- To select parameters in this mode, press the  key. To change parameter settings, use the  or  keys.
- The following table shows the parameters supported in this mode and the page where the parameter is described.

Symbol	Parameter Name	Page
SL-H	Set point upper limit	5-28
SL-L	Set point lower limit	5-28
EntL	PID / ON/OFF	5-28
St	ST	5-29
St-b	ST stable range	5-29
ALFA	α	5-29
At-G	AT calculated gain	5-30
rEst	Standby sequence reset method	5-30
rEt	Automatic return of display mode	5-31
At-H	AT hysteresis	5-31
LbAb	LBA detection width	5-31

Expansion Mode

SL-H Set point upper limit

SL-L Set point lower limit



Function

- Limits the upper and lower limits of the set point. When the set point exceeds the settings of the “Set point upper limit” and “Set point lower limit” parameters, the E5CK controller regards the settings of the “Set point upper limit” and “Set point lower limit” parameters as the set points.
- When the input type is changed to temperature input, the set point upper and lower limits are changed to the upper and lower limits of the currently selected sensor. And when the input type is changed to analog input, the set point upper and lower limits are changed to the scaling upper and lower limits.
- During temperature input, the decimal point position is dependent on the currently selected sensor, and during analog input on the results of scaling.



Comment

Parameter	Setting Range	Unit	Default
SP setting upper limit	SP setting lower limit + 1 to scaling upper limit	EU	1300
SP setting lower limit	Scaling lower limit to SP setting upper limit - 1	EU	-200

During temperature input, the range becomes the range of use of the selected sensor instead of the scaling upper and lower limit values.



See

- Related article
4.2 Operating Condition Restrictions (page 4-5)
- Related parameters
“Input type” “Scaling upper limit” “Scaling lower limit” “Decimal point” (setup mode)

Ctrl PID / ON/OFF



Function

- Selects advanced PID control or ON/OFF control.



Comment

Setting Range	Default
PID : advance PID/ ON/OFF	PID



See

- Related article
4.1 Selecting the Control Method (page 4-3)
- Related parameters
“Hysteresis (heat)” “Hysteresis (cool)” (level 1 mode)

Expansion Mode

St ST

Conditions of Use

The input type must be set to temperature input, and the control must be either standard control or advanced PID control.

St-b ST stable range



Function

- When the “ST” parameter is set to “ON”, the self-tuning (ST) function is active. During operation of the ST function, the power on the load side connected to the control output must be turned ON at the same time or before start of E5CK operation.
- The “ST stable range” parameter sets the stable range width during self-tuning. However, note that this parameter cannot be used when the “ST” parameter is set to “OFF”.



Comment

Parameter	Setting Range	Unit	Default
ST	$\bar{0}FF$: ST function OFF/ $\bar{0}n$: ST function ON	None	$\bar{0}FF$
ST stable range	0.1 to 999.9	°C or °F	15.0



See

- Related article
Fuzzy self-tuning (page A-10)
- Related parameters
“Input type” (setup mode)
“PID / ON/OFF” (expansion mode)

ALFA α

Conditions of Use

The control must be advanced PID control, and ST must be set to OFF.



Function

- Sets advanced PID-control parameter α .



Comment

Setting Range	Unit	Default
0.00 to 1.00	None	0.65



See

- Related parameter
“PID / ON/OFF” (expansion mode)

Expansion Mode

AT-G

AT calculated gain

Conditions of Use

The control must be advanced PID control, and ST must be set to OFF.



Function

- Sets the gain when adjusting the PID parameters by auto-tuning.
- To give priority to response, decrease the set value of this parameter. To give priority to stability, increase the set value of this parameter.



Comment

Setting Range	Unit	Default
0.1 to 10.0	None	1.0



See

- Related parameters
 “AT Execute/Cancel” (level 1 mode)
 “PID / ON/OFF” (expansion mode)

r-EST

Standby sequence reset method



Function

- Selects the conditions for enabling reset after the standby sequence of the alarm has been canceled.
- Condition A:
Control started (including power ON), and set point, alarm value or input shift value changed, and when set points 1 and 2 are switched.
- Condition B:
Power ON



Comment

Setting Range	Default
0: Condition A / 1: Condition B	0



See

- Related parameters
 “Alarm 1 type” “Alarm 2 type” “Alarm 3 type” (setup mode)

rEt

Automatic return of display mode



Function

- If you do not operate any of the controller keys for the time set in this parameter when in levels 0 to 2 modes, the display automatically returns to the PV/SP display.
- When this parameter is set to “0”, this function is disabled.
- This parameter is invalid while the menu is displayed.



Comment

Setting Range	Unit	Default
0 to 99	Second	0

At-H

AT hysteresis

Conditions of Use

The control must be advanced PID control, and ST must be set to OFF.



Function

- The levels of limit cycle operations during AT execution are given hysteresis at event ON/OFF switching. This parameter sets this hysteresis width.



Comment

Setting Range	Unit	Default
0.1 to 9.9	%FS	0.2

LbAb

LBA detection width

Conditions of Use

The LBA (Loop Break Alarm) function must be assigned as an output.



Function









- This parameter can be used when LBA is assigned as an output.
- When the change width of the manipulated variable is below the width set in this parameter, the controller regards this as detection of an LBA.









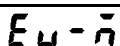
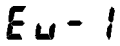

Comment

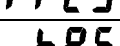
Setting Range	Unit	Default
0.0 to 999.9	%FS	0.2

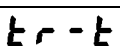
Option Mode

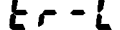
- The parameters in this mode can be used only when the “security” parameter (protect mode) is set to “0” and “1”.
- You can select this mode only when the option unit is set in the controller. In this mode, you can set the communications conditions, transfer output and event input parameters to match the type of option unit set in the controller.
- To select this mode when in the levels 0 to 2, setup, expansion and calibration modes, press the  key for 1 second minimum. The display changes to the menu display. If you select [] using the   key then press the  key for 1 second minimum, the controller enters the option mode.
- To select parameters in this mode, press the  key. To change parameter settings, use the  or  keys.
- The following table shows the parameters supported in this mode and the page where the parameter is described.

Symbol	Parameter Name	Page
	Multi-SP function	5-33
	Event input assignment 1	5-33
	Communication stop bit	5-34
	Communication data length	5-34
	Communication parity	5-34
	Communication baud rate	5-34
	Communication unit No.	5-34
	Transfer output type	5-35
	Transfer output upper limit	5-35
	Transfer output lower limit	5-35

E_U-ñ

Multi-SP function

Conditions of Use

The event input function must be in use.



Function

- This parameter specifies the number of set points (SP) when using the multi-SP function. When set to “0”, the multi-SP function cannot be used.



Comment

Setting Range	Unit	Default
0 to 1	None	0



See

- Related article
4.3 How to Use Option Functions (4-7)
- Related parameter
“Event input assignment 1” (option mode)



Model

- Option unit
Event input unit (E53-CKB)

E_U-1

Event input assignment 1

Conditions of Use

Event input must be specified when the event input function is in use.



Function

- This parameter specifies event input other than the multi-SP function. The following two functions can be specified:
Run/Stop and Manual/Auto.
- Event input is disabled while the menu is displayed.
It is also disabled in set up, expansion, option and calibration modes.



Comment

Symbol	Function	Event Input Operation
StōP	Run/Stop	ON: Stop, OFF : Run
ñRn	Manual/Auto	ON: Manual, OFF : Auto



See

- Related article
4.3 How to Use Option Functions (page 4-7)
- Related parameter
“Event input assignment 1” (option mode)



Model

- Option unit
Event input unit (E53-CKB)

Option Mode

5bit	Communication stop bit	6PS	Communication baud rate
LEN	Communication data length	U-no	Communication unit No.
Prty	Communication parity	Conditions of Use The communications function must be in use.	

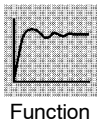

Function

- These parameters set the communications conditions. Make sure that the stop bit, data length, parity and baud rate of the host computer and the E5CK controller are matching. These parameters are valid when the power is turned ON again or when level 0 to 2 modes are switched.
- When connecting two or more E5CK controllers to the host computer, set unit Nos. that will not conflict with the unit Nos. of other controllers.



Comment

- “Communication stop bit” parameter

Setting Range	Unit	Default
1, 2	Bits	2

- “Communication data length” parameter

Setting Range	Unit	Default
7, 8	Bits	7

- “Communication parity” parameter

Setting	Default
nōnE: None/ EUEE: Even/ odd: Odd	EUEE

- “Communication baud rate” parameter

Setting Range	Unit	Default
1.2, 2.4, 4.8, 9.6, 19.2	kbps	9.6

- “Communication unit No.” parameter

Setting Range	Unit	Default
0 to 99	None	0



See

- Related article
 Capter 6 Using the Communications Function (page 6-1)
- Related parameter
 “Remote/Local” (level 2 mode)

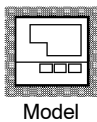

Model

- Option unit
 RS-232C unit (E53-CK01), RS-485 unit (E53-CK03)

Er-t

Transfer output type

Conditions of Use

The transfer output function must be in use.

Er-H

Transfer output upper limit

Er-L

Transfer output lower limit



Function

- These parameters set the transfer output conditions.
- The “transfer output type” parameter selects one of the following as the transfer output type, and assigns this to transfer output: Set point, Set point during SP ramp, Process value, Manipulated variable (heat), and Manipulated variable (cool). However, note that “manipulated variable (cool)” can be selected only during heating and cooling control.
- The “transfer output upper limit” and “transfer output lower limit” parameters are used for scaling of transfer output. The setting range varies according to this output data. Also, a lower limit value larger than the upper limit value may be set.
- During temperature input, the decimal point position of the set point, set point during SP ramp or process value is dependent on the currently selected sensor, and during analog input on the results of scaling.



Comment

Transfer Type	Transfer Output Lower Limit to Transfer Output Upper Limit
SP Set point	Set point lower limit value to Set point upper limit value
SP-r̄ Set point during SP ramp	Set point lower limit value to Set point upper limit value
Pv Process value	Scaling lower limit to scaling upper limit
h̄ Manipulated variable (heat)	-5.0% to 105.0%
c̄ Manipulated variable (cool)	0.0% to 105.0%

- The output ranges of the set point, set point during SP ramp or process value when temperature input is selected are the ranges supported by the selected sensor.
- When you have selected the “manipulated variable (heat)” parameter, the transfer output lower limit during heating and cooling control becomes “0.0”.



See







- Related article
4.3 How to Use Option Functions (page 4-8)



Model

- Option unit
Transfer output unit (E53-CKF)

Calibration Mode

- The parameters in this mode can be used only when the “security” parameter (protect mode) is set to “0”. When selecting this mode for the first time after the E5CK has left the factory, return the “security” parameter to “0”.
- This mode contains the parameters for user calibration of inputs and outputs. Only parameters relating to input types specified in the “input type” parameter (setup mode) can be used. Also, related output parameters can be used only when the communications unit (E53-CKF) is added on.
- To select this mode when in the levels 0 to 2, setup, expansion and option modes, press the  key for 1 second minimum. The display changes to the menu display. If you select [ ] using the   key then press the  key for 1 second minimum, the controller enters the calibration mode.
- For details on parameters in the calibration mode, see 4.5 Calibration (page 4-11).

K CHAPTER 6

USING THE COMMUNICATIONS FUNCTION

This chapter mainly describes communications with a host computer and communications commands.

6.1	Outline of the Communications Function	6-2
	Outline	6-2
	Transfer procedure	6-2
	Interface	6-2
6.2	Preparing for Communications	6-3
	Cable connections	6-3
	Setting the communications specifications	6-4
6.3	Command Configuration	6-5
6.4	Commands and Responses	6-6
	Reading/writing parameters	6-6
	Issuing special commands	6-9
6.5	How to Read Communications Error Information	6-10
	Undefined error	6-11
6.6	Program Example	6-12
	How to use programs	6-12
	Program list (language: IBM PC)	6-13
	Examples of use	6-14

6.1 Outline of the Communications Function

■ Outline

The communications function allows you to monitor and set E5CK parameters by a program prepared and running on a host computer connected to the E5CK controller. This chapter describes operations as viewed from the host computer.

When using the communications function, the option unit for RS-232C or RS-485 communications must be added on. The E5CK communications function allows you to carry out the following:

- Reading/writing of parameters;
- Operation instructions; and
- Selecting the setting level.

The communications function assumes the following conditions:

- Writing of parameters is possible in during remote operation. Also, parameters cannot be written during execution of auto-tuning;
- Writing parameters are provided with a setting level. Writing conditions are as follows depending on the setting level:

Setting level 1: No restrictions

Setting level 0: Writing of parameters in the setup and expansion modes only is prohibited.

- For details on switching between setting levels, see page 6-9.
- The “run/stop”, “remote/local” and “AT execute/cancel” parameters are set aside from other parameters as special commands for instructing operations.

■ Transfer procedure

The host computer sends a “command frame” to the controller, and the controller returns a “response frame” corresponding to the content of the command sent by the host computer. In other words, a response frame is returned for each command frame sent.

The following diagram shows command frame/response frame operations.

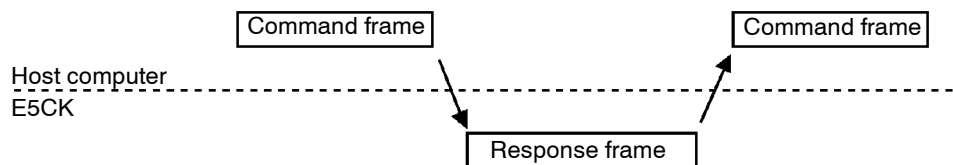

■ Interface

The host computer carries out communications conforming to the RS-232C or RS-485 interface specifications.

Option units supporting the RS-232C and RS-485 specifications are as follows:

- Option units
 - E53-CK01 (RS-232C)
 - E53-CK03 (RS-485)

6.2 Preparing for Communications

For details on wiring when using the communications, see Chapter 2 Preparations.

■ Cable connections

● RS-232C

- Only one controller can be connected to the host computer.
- The cable length should not exceed 15 meters.
- Use shielded twisted-pair cables (AWG28 or more) for the cables.

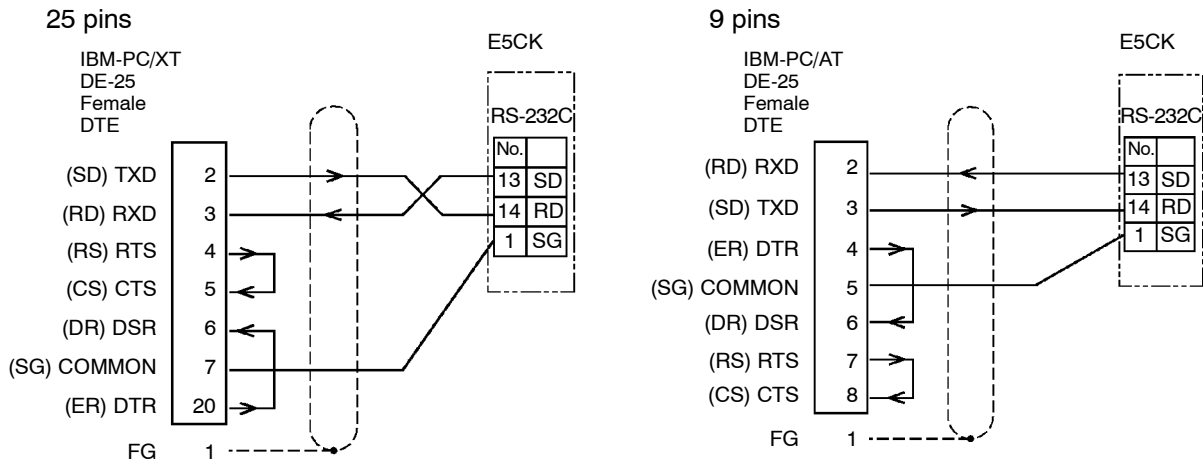

● RS-485

- Up to 32 controllers including a computer can be connected to the host computer.
- The total cable length should not exceed 500 meters.
- Use shielded twisted-pair cables (AWG28 or more) for the cables.
- Attach terminators to the controllers at both ends of a series of controllers connected in an open configuration. For example, in the following configuration, connect the terminator to the host unit and the unit No.30, and do not connect terminators to unit Nos.0 to 29.
- Use terminators having a resistance of 120Ω (1/2 W). The total resistance of both ends should be at least 54Ω .

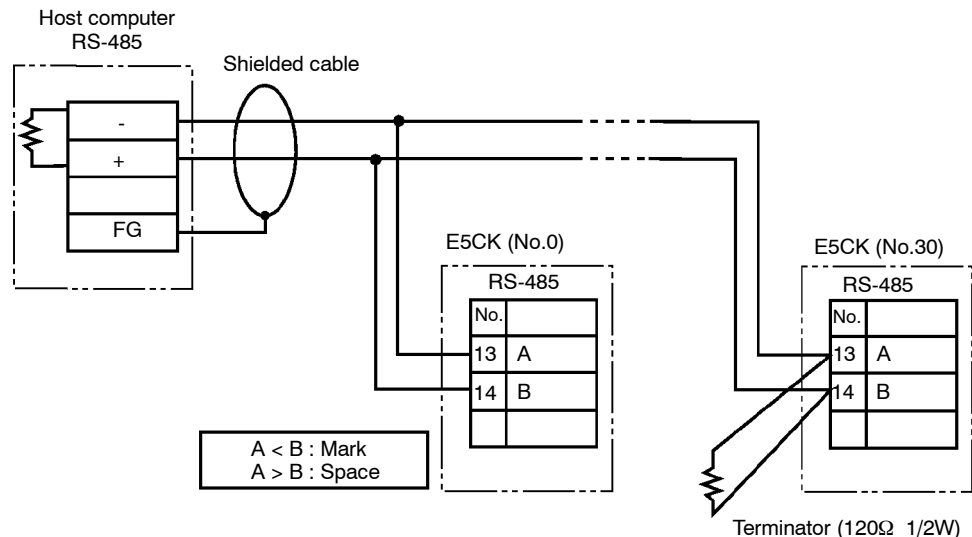

■ Setting the communications specifications

Match the communications specifications of the host computer and E5CK controller. When two or more controllers are connected to the host computer, make sure that the communications specifications of all controllers are the same.

This section describes how to set the communications specifications of the E5CK controller. For details on the host computer, see the relevant manual supplied with the host computer.

● Communications parameters

Set the communications specifications of the E5CK in the controller's communications parameters. The communications parameters are set on the front panel of the E5CK controller.

The following table shows the communications parameters provided on the E5CK controller and their respective settings.

Parameter/Symbol		Setting	Set Value
Unit No.	<i>U-nō</i>	0 to 99	0 to 99
Baud rate	<i>bPS</i>	1.2/2.4/4.8/9.6/19.2 (kbps)	1.2/2.4/4.8/ 9.6 /19.2
Bit length	<i>LEN</i>	7/8 (bit)	7 /8
Parity	<i>Prty</i>	None/even/odd	<i>nōnE</i> / / <i>ōdd</i>
Stop bit	<i>Sbct</i>	1/2	1/ 2

Inverted items are factory-settings.

6.3 Command Configuration

Command configuration is as follows and are paired with a response.

● Command

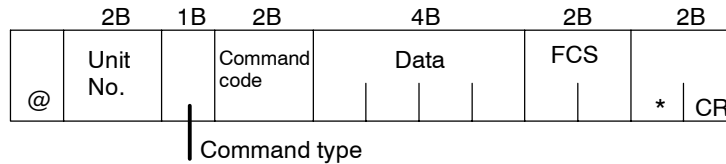

● Response

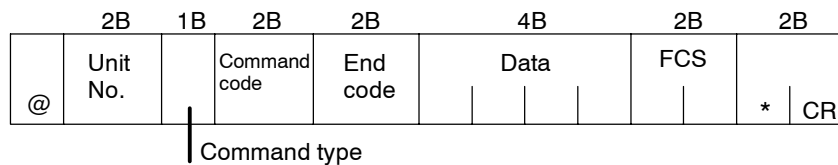

- “@”
The start character. This character must be inserted before the leading byte.
- Unit No.
Specifies the “unit No.” of the E5CK. If there are two or more transmission destinations, specify the desired destination using “unit No.”
- Command type
Specifies the command type by codes “1” to “3”: parameter read, parameter write and special commands.
- Command code
Specifies the command for each command type. With parameter read/write commands, this becomes the parameter No.
- Data
Specifies the set value or setting content. In the parameter read command, set dummy data “0000”. In the response, this is inserted only when the end code is “00”.
- End code
Sets the communication results. For details on the types and meanings of end codes, see 6.5 How to Read Communications Error Information (page 6-10).
- FCS (Frame Check Sequence)
Set the frame check results from the start character to the data section. For details on the frame check, see 6.6 Program Example (page 6-12).
- “*” “CR (Carriage Return) code”
Indicates the end (terminator) of the command or response block.

6.4 Commands and Responses

This section describes commands and response in detail. The conventions used in this section and data restrictions are as follows:

- Data is expressed in 1-byte units and in ASCII code.
- When the read or write data is a numerical value, the data to be set must conform to the following conditions:

(1) The decimal point “.” is not indicated in fractions.

(2) The leftmost bit of minus numerical data must be expressed as follows:

[example]

10.0=[0100], -150.0=[A500], -15=[F015]

■ Reading/writing parameters

● Reading parameters

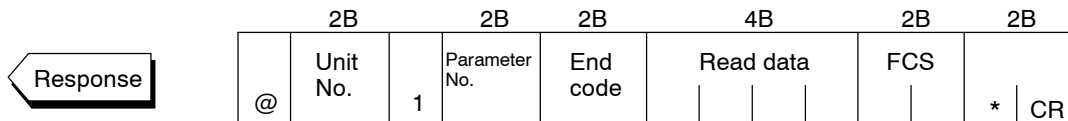
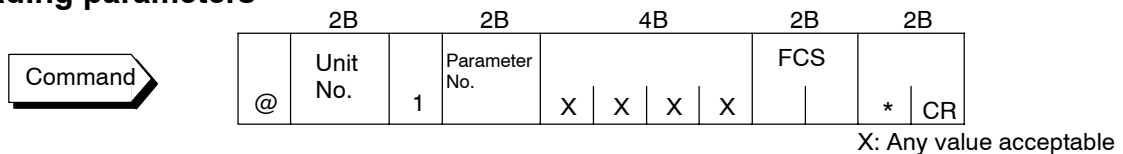

● Writing parameters

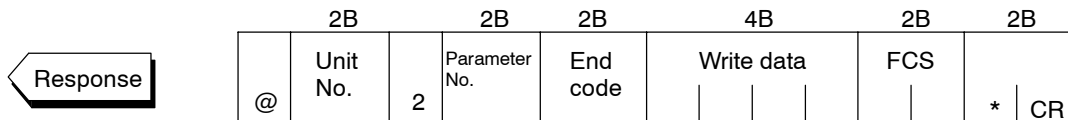
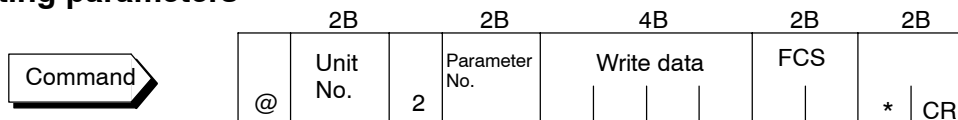

Reading or writing of the parameters of a specified controller is executed.

- Writing is possible only during remote operation.
- Reading is impossible during executing auto-tuning.
- The followings are set aside as special commands. For details, see page 6-9.

“run/stop”, “remote/local”, “AT execute/cancel”

- For details on parameters in each setting level, see the tables on pages 6-7 and 6-8.



Writing the Set Value

With X format “MA” and “ME” commands (see page A-12), you can select non-volatile RAM or RAM as the memory for the set value. The limit for the number of times that non-volatile RAM can be written to is 100,000 times. When the number of times that the set point is written exceeds this limit, set RAM write mode as the memory.

Parameter No.	Parameter	Data Setting and Monitor Range	Mode
00	PV monitor *1	Scaling lower limit -10% to scaling upper limit +10% *2	Level 0
86	SP monitor during SP ramp *1	Set point lower limit to set point upper limit	
04	MV monitor (heat) *1	-5.0 to 105.0 *3	
42	MV monitor (cool) *1	0.0 to 105.0	
01	Set point	Set point lower limit to set point upper limit	
02	Alarm value 1	-1999 to 9999	Level 1
03	Alarm value 2	-1999 to 9999	
41	Alarm value 3	-1999 to 9999	
19	Proportional band	0.1 to 999.9	
20	Integral time	0 to 3999	
21	Derivative time	0 to 3999	
22	Cooling coefficient	0.01 to 99.99	
09	Dead band	-19.99 to 99.99	
23	Manual reset value	0.0 to 100.0	
06	Hysteresis (heat)	0.01 to 99.99	
43	Hysteresis (cool)	0.01 to 99.99	
07	Control period (heat)	1 to 99	
08	Control period (cool)	1 to 99	
44	SP ramp time unit	0: Minutes, 1: Hours	
45	SP ramp set value	0 to 9999	
46	LBA detection time	0 to 9999	
47	MV at stop	-5.0 to 105.0 *4	
48	MV at PV error	-5.0 to 105.0 *4	
50	MV upper limit	MV lower limit +0.1 to 105.0	
49	MV lower limit	-5.0 to MV upper limit -0.1 *5	
51	MV change rate limit	0.0 to 100.0	
56	Input digital filter	0 to 9999	
25	Alarm 1 hysteresis	0.01 to 99.99	
26	Alarm 2 hysteresis	0.01 to 99.99	
52	Alarm 3 hysteresis	0.01 to 99.99	
53	Input shift upper limit	-199.9 to 999.9	
54	Input shift lower limit	-199.9 to 999.9	

*1 Possible only during reading

*2 During temperature input, the range becomes the range of use of the selected sensor.

*3 During heating and cooling control, the range becomes 0.0 to 105.0.

*4 During heating and cooling control, the range becomes -105.0 to 105.0.

*5 During heating and cooling control, the range becomes -105.0 to MV upper limit -0.1.



About invalid parameters

Currently, if a command is used for invalid parameters (parameters that do not satisfy the conditions of use in Chapter 5), the “undefined” error (end code: IC) is output.

Parameter No.	Parameter	Data Setting Range	Mode	
57	Input type	0 to 21 ^{*1}	Setup	
59	Scaling upper limit	Scaling lower limit +1 to 9999		
58	Scaling lower limit	-1999 to scaling upper limit -1		
60	Decimal point	0 to 3		
30	°C/°F selection	0 : °C, 1 : °F		
61	Control output 1 assignment	0 to 4, 6 ^{*2}		
62	Control output 2 assignment	0 to 4, 6 ^{*2}		
63	Auxiliary output 1 assignment	2 to 4, 6 to 8 ^{*3}		
65	Alarm 1 type	1 to 11 ^{*4}		
66	Alarm 1 open in alarm	0: closed in alarm, 1: open in alarm		
67	Alarm 2 type	1 to 11 ^{*4}		
68	Alarm 2 open in alarm	0: closed in alarm, 1: open in alarm		
69	Alarm 3 type	1 to 11 ^{*4}		
70	Alarm 3 open in alarm	0: closed in alarm, 1: open in alarm		
71	Direct/Reverse operation	0: Reverse operation, 1: Direct operation		
28	Set point upper limit ^{*5}	Set point lower limit +1 to scaling upper limit		Expansion
27	Set point lower limit ^{*5}	Scaling lower limit to Set point upper limit -1		
72	PID / ON/OFF	0: Advanced PID, 1: ON/OFF		
73	ST	0 : OFF, 1 : ON		
34	ST stable range width	0.1 to 999.9		
35	α	0.00 to 1.00		
85	AT calculated gain	0.1 to 10.0		
37	Standby sequence reset method	0, 1 ^{*6}		
36	Automatic return of display mode	0 to 99		
93	AT hysteresis	0.1 to 9.9		
55	LBA detection width	0.0 to 999.9		

*1 See page 5-22.

*2 0: Control output (heat), 1: Control output (cool), 2: Alarm 1, 3: Alarm 2, 4: Alarm 3, 6: LBA.

*3 2: Alarm 1, 3: Alarm 2, 4: Alarm 3, 6: LBA, 7: Error 1, 8: Error 2

*4 See page 5-25.

*5 During temperature input, the range becomes the range of use of the selected sensor.

*6 See page 5-30.



Reading the status

To read the E5CK controller status, use the X format “RX” command. For details, see the Appendix: X Format Head List (page A-13).

■ Issuing special commands

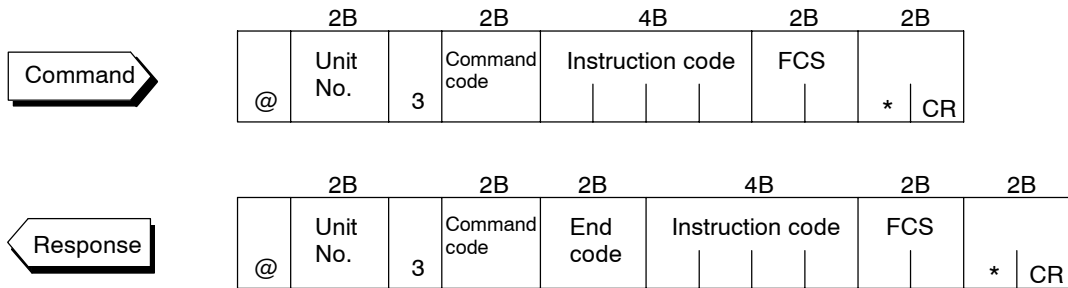

The following functions are issued as special commands.

- **Run/Stop**
Runs or stops programs. This command cannot be issued in setting level 1. Run/Stop can be switched up to 100,000 times.
- **Remote/Local**
Selects remote operation or local operation.
- **AT Execute/Cancel**
Executes or cancels auto-tuning. This command cannot be issued in setting level 1.
- **Move to setting level 1**
Issue this command when writing parameters in setup and expansion modes.
- **Software reset**
A response is not returned to this command. Also, communications with the E5CK cannot be carried out for five seconds after reset.

The following table shows the special commands that are available on the E5CK controller.

Command No.	Command	Instruction Code
00	Run/Stop	0000: Run, 0001: Stop
02	Remote/Local	0000: Remote, 0001: Local
07	AT Execute/Cancel	0000: Cancel, 0001: 40%AT execution, 0002: 100% AT execution
09	Move to setting level 1	0000
11	Software reset	0000

About Setting Levels

To return to setting level 0 from setting level 1, issue the “software reset” command. If the parameter write command is issued for the setup and expansion modes in setting level 0, an error occurs, and the end code (0D = Command cannot be executed) is returned.

6.5 How to Read Communications Error Information

The result of communications on the E5CK can be checked by the end code in the response frame. Use this end code to remedy errors that may occur.

End code

Communications are normal when the end code in the response is “00”. If the end code is not “00”, this indicates that an error other than an undefined error has occurred. The end code format is as follows and does not contain a data area.

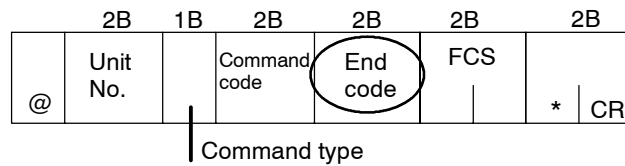

End code	0D	Code name	Command cannot be executed
----------	----	-----------	----------------------------

Description

- Writing was carried out during local operation.
- Writing was carried out during executing auto-tuning.
- An attempt was made to execute 40%AT during heating and cooling control.
- An attempt was made to switch run/stop in setting level 1.
- An attempt was made to execute AT in setting level 1.

Action

- Issue the parameter read or write commands in conditions other than above.

End code	10	Code name	Parity error
----------	----	-----------	--------------

Description

Parity check error was detected in the received data.

Action

Check the communications condition. If the communications condition of the host computer and E5CK controller match, then a probable cause is a problem in the communications circuit of one or both of the host computer and E5CK controller.

End code	11	Code name	Framing error
----------	----	-----------	---------------

Description

Stop bit cannot be detected.

Action

Check the communications condition. If the communications condition of the host computer and E5CK controller match, then a probable cause is a problem in the communications circuit of one or both of the host computer and E5CK controller.



About the unit No.

Responses are not returned unless the target unit for communications and the unit No. in the command match.

End code	12	Code name	Overrun error
----------	----	-----------	---------------

● **Description**

The receive buffer overflowed.

● **Action**

Check the communications condition. If the communications condition of the host computer and E5CK controller match, then a probable cause is a problem in the communications circuit of one or both of the host computer and E5CK controller.

End code	13	Code name	FCS error
----------	----	-----------	-----------

● **Description**

The FCS (Frame Check Sequence) do not match.

● **Action**

Check the FCS program.

End code	14	Code name	Format error
----------	----	-----------	--------------

● **Description**

The received command length does not match the length defined in the frame format.

● **Action**

Check the communications condition. If the communications condition of the host computer and E5CK controller match, then a probable cause is a problem in the communications circuit of one or both of the host computer and E5CK controller.

End code	15	Code name	Setting range error
----------	----	-----------	---------------------

● **Description**

Numerical values or code values in the data are not within the setting range.

● **Action**

Check the parameter and read or write data of special commands.

■ Undefined error

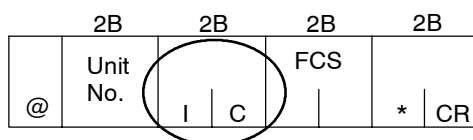

● **Description**

- An undefined header code has been received.
- A currently invalid parameter (e.g. the scaling command during temperature input) has been received.

● **Action**

- Check the parameter No.

6.6 Program Example

How to use programs

The program described below is for obtaining corresponding response frame data when some of the command frame data is input.

The input format is as follows. The FCS and terminator are automatically generated, and need not be input.

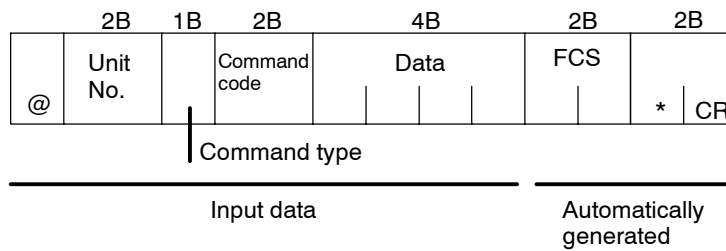

The output format is as follows. The content of the response frame is displayed as it is.

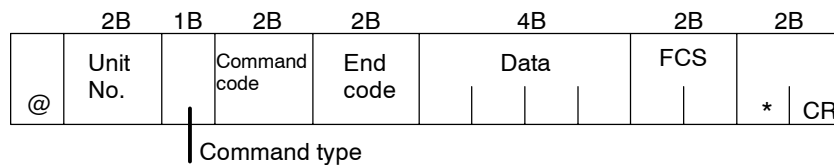

Procedure

- (1) Read the program.
- (2) Enter "RUN".
- (3) When "send data:" is displayed, enter the command data (from @ to the command string).
- (4) The content of the response frame is displayed following "receive data:".

Conditions when running a program

- Set the communications condition as follows:
 - Baud rate : 9600 bps
 - Bit length : 7 bits
 - Parity : Even
 - Stop bit : 2
- Make sure that the communications cable is properly connected.

■ Program list (language: IBM PC COMPATIBLE MACHINE)

```

1000 ' -----
1010 ' PROGRAM : E5CK Communication Program
1020 ' ----- For IBM PC COMPATIBLE MACHINE
1030 ' VERSION : 1.00
1040 ' Copyright (C) 1995 OMRON Corporation All Rights Reserved.
1050 ' -----
1060 ' ----- RS-232C SPEED: 9600BPS, PARITY: EVEN, DATA: 7, STOP: 2 -----
1070 OPEN "COM: 9600, E, 7, 2, CD0, CS0, DS0, RB256, RS "FOR RANDAM AS #1 LEN=256
1080 REPEAT
1090 ' -----Make Command
1100 PRINT "send data : " ;
1110 INPUT SEND$
1120 ' -----FCS calculation-----
1130 FCS=0
1140 FOR IFCS=1 TO LEN (SEND$)
1150 FCS=FCS XOR ASC (MID$ (SEND$, IFCS, 1))
1160 NEXT
1170 FCS$=RIGHT$ ("0"+HEX$ (FCS), 2)
1180 ' ----- Send data to communication port -----
1190 PRINT #1, SEND$+FCS$+"*"
1200 ' ----- Receive data from communication port -----
1210 RECCNT=0: TMP$=""
1220 DRECLOOP:
1230 IF LOC (1) <> 0 THEN DREC1
1240 RECCNT=RECCNT+1
1250 IF RECCNT=5000 THEN *DRECERR ELSE DRECLOOP
1260 'DREC1
1270 TMP$=TMP$+INPUT$ (LOC (1), #1)
1280 IF RIGHT$ (TMP&, 1)=CHR$ (13) THEN DRECEND
----- ELSE RECCNT=0: GOTO DRECLOOP
1290 DRECERR:
1300 TMP$="No response !!"
1310 DRECEND:
1320 RECV$=TMP$
1330 PRINT "response: "; RECV$
1340 ' ----- Repeat to make Command -----
1350 GOTO REPEAT
1360 ' ----- END -----
1370 CLOSE #1
1380 END

```

Examples of use

● Set the unit No. to “00”

- In the following examples, data is shown in individual blocks to make the examples easier to understand. However, when actually creating programs, do not leave spaces between frame items. Also, response are displayed without spaces between frame items.

● Set the set point to “300.0”

- Input data

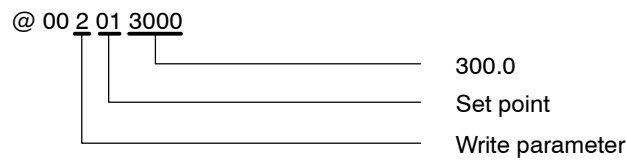

- Response

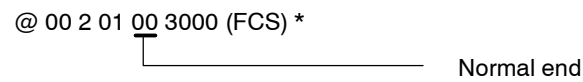

● Start running

- Input data

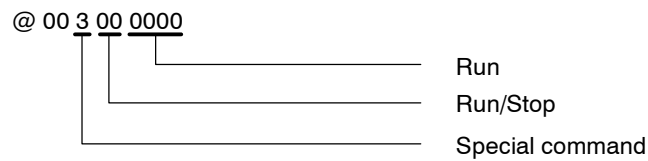

- Response

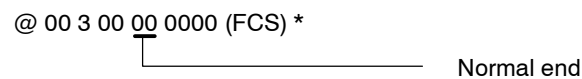

● Monitor process value

- Input data

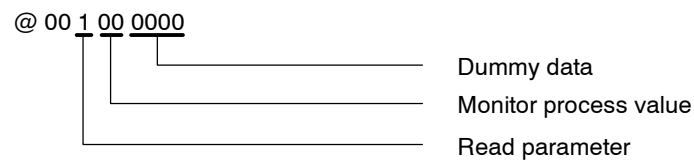

- Response

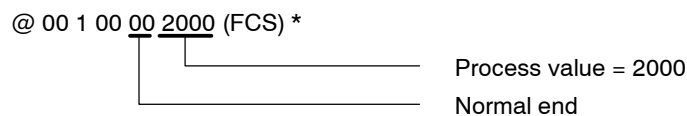

K CHAPTER 7

TROUBLESHOOTING

This chapter describes how to find out and remedy the cause if the E5CK does not function properly.

7.1	Initial Checks	7-2
7.2	How to Use the Error Display	7-3
7.3	How to Use Error Output	7-5
7.4	Checking Operation Restrictions	7-6

7.1 Initial Checks

If trouble occurs, first of all check the following.

(1) Power supply

Make sure that the power supply is ON. Also, make sure that the power supply is within the rated voltage range.

(2) Input type jumper connectors

Make sure that the jumper connectors are at their correct positions. The following table shows the operations when the jumper connector positions do not match the “input type” parameter settings.

Jumper Connector	Parameter	Operation
TC • PT	Current (0 to 20mA)	Fixed at scaling lower limit value
	Current (4 to 20mA)	S.E r r
	Voltage (0 to 10V, 0 to 5V)	Fixed at scaling lower limit value
	Voltage (1 to 5V)	S.E r r
I	Temperature input	S.E r r
	Voltage (0 to 10V, 0 to 5V)	Fixed at scaling lower limit value
	Voltage (1 to 5V)	S.E r r
V	Temperature input	S.E r r
	Current (0 to 20mA)	Fixed at scaling lower limit value
	Current (4 to 20mA)	S.E r r

(3) Wiring

Make sure that all cables are properly connected.

(4) Communications condition

When communicating using the RS-232C or RS-485 communications interfaces, make sure that the baud rate and other communications condition settings on the host computer and E5CK controller are matching, and are within the permissible ranges.

If there appears to be nothing wrong after checking the E5CK controller, and the same phenomenon continues, check the controller in more detail, for example, on the error display.

7.2 How to Use the Error Display

When an error has occurred, the No.1 display alternately indicates error codes together with the current display item.

This section describes how to check error codes on the display, and the actions you must be taken to remedy the problem.



Input error

- **Meaning** Input is in error.
- **Action** Check the wiring of inputs, disconnections, and shorts, and check the input type and the input type jumper connector.
- **Operation at error** For control output functions, output the manipulated variable matched to the setting of the “MV at PV error” parameter (level 2 mode). Alarm output functions are activated when the upper limit is exceeded.

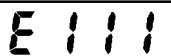

Memory error

- **Meaning** Internal memory operation is in error
- **Action** First, turn the power OFF then back ON again. If the display remains the same, the E5CK controller must be repaired. If the display is restored to normal, then a probable cause can be external noise affecting the control system. Check for external noise.
- **Operation at error** Control output functions turn OFF (2mA max. at 4 to 20mA output, and output equivalent to 0% in case of other outputs). Alarm output functions turn OFF.



A/D converter error

- **Meaning** Internal circuits are in error.
- **Action** First, turn the power OFF then back ON again. If the display remains the same, the E5CK controller must be repaired. If the display is restored to normal, then a probable cause can be external noise affecting the control system. Check for external noise.
- **Operation at error** Control output functions turn OFF (2mA max. at 4 to 20mA output, and output equivalent to 0% in case of other outputs). Alarm output functions turn OFF.



Calibration data error

This error is output only during temperature input, and is displayed for two seconds when the power is turned ON.

- **Meaning** Calibration data is in error.
- **Action** Must repair.
- **Operation at error** Both control output functions and alarm output functions operate. However, note that readout accuracy is not assured.



Display range over



- **Meaning** Though not an error, this is displayed when the process value exceeds the display range when the control range (setting range $\pm 10\%$) is larger than the display range (–1999 to 9999).
 - When less than “-1999” [C C C C]
 - When greater than “9999” [9 9 9 9]
- **Operation** Control continues, allowing normal operation.

7.3 How to Use Error Output

The E5CK controller allows you to assign error output to terminals as outputs.

For details on output assignments, see 3.3 Setting Output Specifications (page 3-5).

● LBA

- LBA (Loop Break Alarm) can be used as a means for detecting loop breaks when the control loop is not functioning normally. For details, see page 4-9.
- LBA allows you to detect the following errors:
 - (1) Heater burnout
 - (2) Output error (contact weld, damaged transistors, etc.)
 - (3) Sensor error (constant input values, etc.)
- If you use the LBA function, set the loop break detection time matched to the control characteristics in the “LBA detection time” parameter (level 2 mode).

● Input errors

- If you assign error 1 as the output, an error can be output when input is in error. When this error occurs, remedy by following the description for “Input error” (page 7-3).

● A/D converter error

- If you assign error 2 as the output, an error can be output when the A/D converter is in error. When this error occurs, remedy by following the description for “A/D converter error” (page 7-3).

7.4 Checking Operation Restrictions

With the E5CK controller, auto-tuning or self-tuning sometimes do not operate depending on the way functions are combined. The table below summarizes the main operating restrictions.

If the E5CK controller is not operating properly, first check whether operating conditions violate the restrictions in this table.

Restriction	Inoperable or Invalid Functions			
	ST Execution	AT Execution	Limiter Function	Other
At analog input	×			
At heating and cooling control	×	40%AT		
At ON/OFF control	×	×	Manipulated variable MV change rate	
ST = ON	-	×	Manipulated variable MV change rate	SP ramp function
At AT execution	-	-	MV change rate	Parameter setting
At stop	×	×	Manipulated variable MV change rate	

Items marked by a “x” indicates combinations of conditions not acceptable during ST or AT execution.

Items marked by “-” are impossible combinations.

K APPENDIX

SPECIFICATIONS	A-2
CONTROL BLOCK DIAGRAM	A-5
SETTING LIST	A-6
PARAMETER OPERATIONS LIST	A-8
FUZZY SELF-TUNING	A-10
MODEL LIST	A-13
X FORMAT	A-14
ASCII CODE LIST	A-17

SPECIFICATIONS

Ratings

	AC100-240V type	AC/DC24V type
Supply Voltage	AC100-240V ~, 50/60 Hz	AC/DC24V ~, 50/60Hz
Power Consumption	15VA	6VA, 3.5W
Operating Voltage Range	85% to 110% of rated supply voltage	
Input	Thermocouple : K, J, T, E, L, U, N, R, S, B, W, PLII ^{*1, *2} Platinum resistance thermometer : JPt100, Pt100 Current input : 4 to 20mA, 0 to 20mA Voltage input : 1 to 5V, 0 to 5V, 1 to 10V	
Input Impedance	Voltage input : 1 MΩ min. Current input : 150 Ω	
Control Output	According to output unit (see "Output Unit Ratings and Characteristics")	
Auxiliary Output	SPST-NO, 1A at 250 VAC (resistive load)	
Control Method	Advanced PID or ON/OFF control	
Setting Method	Digital setting using front panel keys	
Indication Method	7-segment digital display and LEDs	
Other Functions	According to option unit (see "Option Unit Ratings and Characteristics")	
Ambient Temperature	Operating : -10°C to 55°C (with no icing)/3-year warranty period: -10°C to 50°C Storage : -25°C to 65°C (with no icing)	
Ambient Humidity	35% to 85% RH	

*1 Thermocouple W is W/Re5-26 (tungsten rhenium 5, tungsten rhenium 26).

*2 The following table shows the setting ranges and indication ranges for each of the inputs.

Input	Setting Range	Indication Range
JPt100	-199.9 to 650.0(°C) /-199.9 to 999.9(°F)	-199.9 to 735.0(°C) /-199.9 to 999.9(°F)
Pt100	-199.9 to 650.0(°C) /-199.9 to 999.9(°F)	-199.9 to 735.0(°C) /-199.9 to 999.9(°F)
K1	-200 to 1300(°C) /-300 to 2300(°F)	-350 to 1450(°C) /-560 to 2560(°F)
K2	0.0 to 500.0(°C) /0.0 to 900.0(°F)	-50.0 to 550.0(°C) /-90.0 to 990.0(°F)
J1	-100 to 850(°C) /-100 to 1500(°F)	-195 to 945(°C) /-260 to 1660(°F)
J2	0.0 to 400.0(°C) /0.0 to 750.0(°F)	-40.0 to 440.0(°C) /-75.0 to 825.0(°F)
T	-199.9 to 400.0(°C) /-199.9 to 700.0(°F)	-199.9 to 460.0(°C) /-199.9 to 790.0(°F)
E	0 to 600(°C) /0 to 1100(°F)	-60 to 660(°C) /-110 to 1210(°F)
L1	-100 to 850(°C) /-100 to 1500(°F)	-195 to 945(°C) /-260 to 1660(°F)
L2	0.0 to 400.0(°C) /0.0 to 750.0(°F)	-40.0 to 440.0(°C) /-75.0 to 825.0(°F)
U	-199.9 to 400.0(°C) /-199.9 to 700.0(°F)	-199.9 to 460.0(°C) /-199.9 to 790.0(°F)
N	-200 to 1300(°C) /-300 to 2300(°F)	-350 to 1450(°C) /-560 to 2560(°F)
R	0 to 1700(°C) /0 to 3000(°F)	-170 to 1870(°C) /-300 to 3300(°F)
S	0 to 1700(°C) /0 to 3000(°F)	-170 to 1870(°C) /-300 to 3300(°F)
B	100 to 1800(°C) /300 to 3200(°F)	-70 to 1970(°C) /10 to 3490(°F)
W	0 to 2300(°C) /0 to 4100(°F)	-230 to 2530(°C) /-410 to 4510(°F)
PLII	0 to 1300(°C) /0 to 2300(°F)	-130 to 1430(°C) /-230 to 2530(°F)
4 to 20mA 0 to 20mA 1 to 5V 0 to 5V 0 to 10V	One of following ranges depending on results of scaling -1999 to 9999 -199.9 to 999.9 -19.99 to 99.99 -1.999 to 9.999	-10 to 110% of setting range. Note, however that max. value is -1999 to 9999

Characteristics

Indication Accuracy	Thermocouple: ($\pm 0.3\%$ of indication value or $\pm 1^\circ\text{C}$, whichever greater) ± 1 digit max. (*1) Platinum resistance thermometer: ($\pm 0.2\%$ of indication value or $\pm 0.8^\circ\text{C}$ whichever greater) ± 1 digit max. Analog input: $\pm 0.2\% \pm 1$ digit max.	
Temperature variation influence (*2)	Platinum resistance thermometer: ($\pm 1\%$ of PV or $\pm 2^\circ\text{C}$, whichever greater) ± 1 digit max. Thermocouple (R, S, B, W): ($\pm 1\%$ of PV or $\pm 10^\circ\text{C}$, whichever greater) ± 1 digit max.	
Voltage variation influence (*2)	Other thermocouples (K1, K2, J1, J2, E, N, T, L1, L2, U, PLII): ($\pm 1\%$ of PV or $\pm 4^\circ\text{C}$, whichever greater) ± 1 digit max. Analog input (current, voltage, or remote SP input): $\pm 1\% \text{FS} \pm 1$ digit max.	
Hysteresis	0.01 to 99.99%FS (in units of 0.01%FS)	
Proportional Band (P)	0.1 to 999.9% FS (in units of 0.1%FS)	
Integral (reset) Time (I)	0 to 3999 s (in units of 1 second)	
Derivative (rate) Time (D)	0 to 3999 s (in units of 1 second)	
Control Period	1 to 99 s (in units of 1 second)	
Manual Reset Value	0.0 to 100.0% (in units of 0.1%)	
Alarm Setting Range	-1999 to 9999 or -199.9 to 999.9 (decimal point position dependent on input type)	
Sampling Period	Temperature input: 250 ms, Analog input: 100 ms	
Insulation Resistance	20 M Ω min. (at 500 VDC)	
Dielectric Strength	2000 VAC, 50/60Hz for 1 min (between terminals of different polarities)	
Vibration Resistance	Malfunction	10 to 55 Hz, 10 m/s ² (1G) for 10 min each in X, Y, and Z directions
	Destruction	10 to 55 Hz, 20 m/s ² (2G) for 2hrs each in X, Y, and Z directions
Shock Resistance	Malfunction	200 m/s ² min. (20G), 3 times each in 6 directions (100 m/s ² (10G) applied to the relay)
	Destruction	300 m/s ² min. (30G), 3 times each in 6 directions
Weight	Approx. 170 g, adapter: approx. 10 g	
Enclosure Ratings	Front panel: NEMA4 for indoor use (equivalent to IP66) Rear case: IEC standard IP20 Terminals: IEC standard IP00	
Memory Protection	Non-volatile memory (Write operation : 100000 max.) (*3)	

*1 The indication accuracy of the K1, T, and N thermocouples at a temperature of -100°C or less is $\pm 2^\circ\text{C} \pm 1$ digit maximum. The indication accuracy of the U, L1 and L2 thermocouples at any temperature is $\pm 2^\circ\text{C} \pm 1$ digit maximum. The indication accuracy of the B thermocouple at a temperature of 400°C or less is unrestricted. The indication accuracy of the R and S thermocouples at a temperature of 200°C or less is $\pm 3^\circ\text{C} \pm 1$ digit maximum. The indication accuracy of the W thermocouple is ± 1 digit max. of whichever is the greater of $\pm 0.3\%$ or $\pm 3^\circ\text{C}$ of the indicated value. The indication accuracy of the PLII thermocouple is ± 1 digit max. of whichever is the greater of $\pm 0.3\%$ or $\pm 2^\circ\text{C}$ of the indicated value.

*2 Ambient temperature: -10°C to 23°C to 55°C
 Voltage range: -15 to $+10\%$ of rated voltage

*3 Write operations: Parameter changes, remote/local selection, etc.

■ Output Unit Ratings and Characteristics

Relay output	SPST, 250 VAC, 3A (resistive load) Mechanical life expectancy: 10,000,000 operations min Electrical life expectancy: 100,000 operations min
Voltage Output (NPN)	NPN, 12 VDC, 20 mA (with short-circuit protection)
Voltage Output (PNP)	PNP, 12 VDC, 20 mA (with short-circuit protection)
Linear Voltage Output	0 to 10 VDC, Permissible load impedance: 1 k Ω min., Resolution: Approx. 2600
Linear Current Output	4 to 20 mA, Permissible load impedance: 500 Ω max., Resolution: Approx. 2600
	0 to 20 mA, Permissible load impedance: 500 Ω max., Resolution: Approx. 2600

■ Option Unit Ratings and Characteristics

Event inputs	Contact input	ON: 1 k Ω max., OFF: 100 k Ω min.
	No-contact input	ON: residual voltage 1.5 V max., OFF: leakage current 0.1 mA max.
Communications	Interface	:RS-232C or RS-485
	Transmission method	:Half-duplex
	Synchronization method	:Start-stop synchronization (asynchronous method)
	Baud rate	:1.2/2.4/4.8/9.6/19.2 kbps
Transfer output	4 to 20 mA, Permissible load impedance: 500 Ω max. Resolution: Approx. 2600	

CONTROL BLOCK DIAGRAM

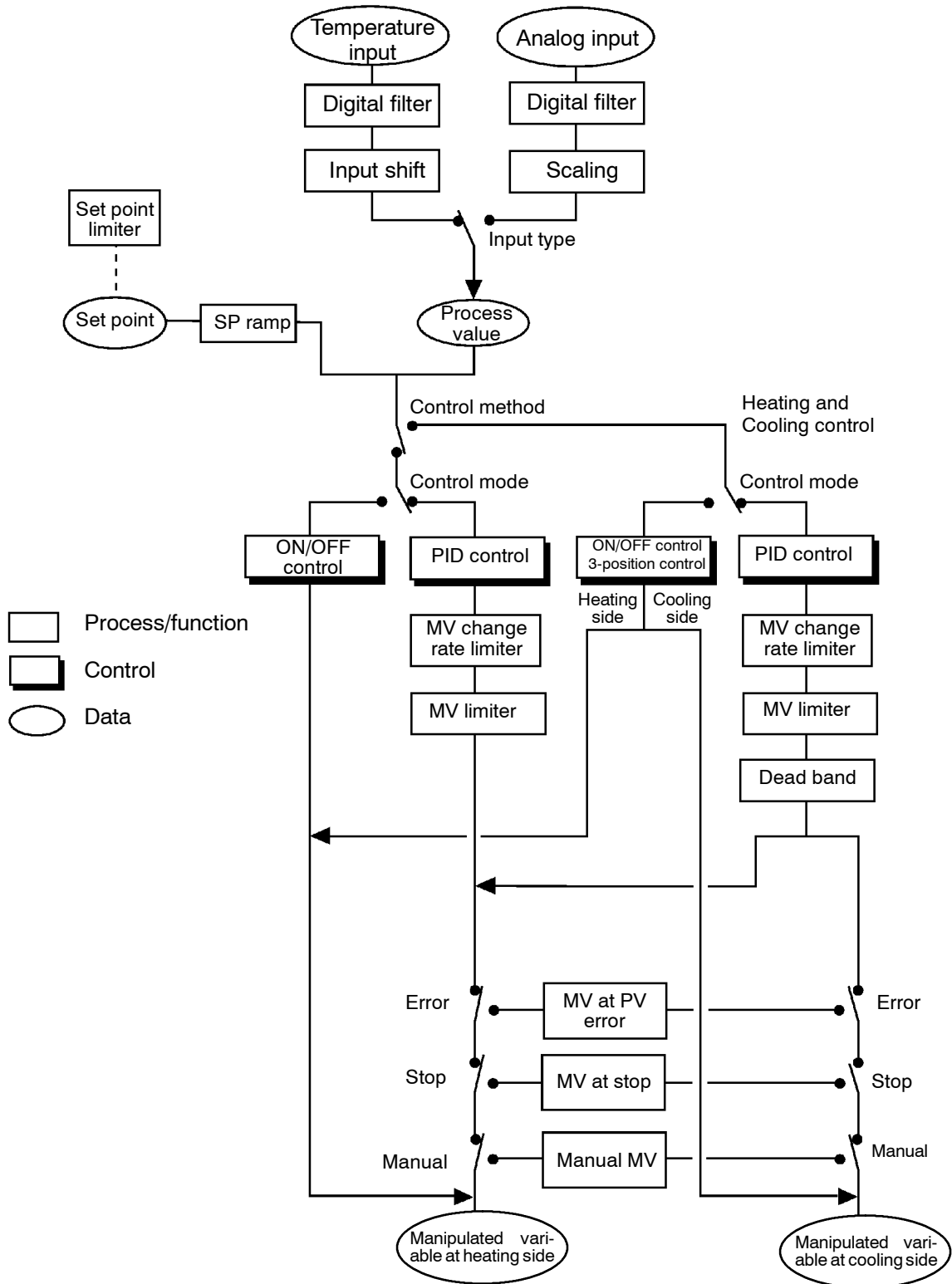

SETTING LIST

Mode	Parameter Name	Setting Range	Unit	Default	Remarks	Setting
Protect	SECr Security	0 to 6	None	1		
	PEYp [A/M] key protect	ON/OFF	None	OFF		
Manual	Manual MV	-5.0 to 105.0 *1	%	0.0		
Level 0	Set point	Set point lower limit to Set point upper limit	EU	0		
	r-S Run/Stop	Run/Stop	None	RUN		
Level 1	RE AT Execute/Cancel	OFF/AT-1/AT-2	None	OFF	During running	
	SP-0 Set point 0	Set point lower limit to Set point upper limit	EU	0	Multi-SP	
	SP-1 Set point 1	Set point lower limit to Set point upper limit	EU	0	Multi-SP	
	AL-1 Alarm value 1	-1999 to 9999	EU	0		
	AL-2 Alarm value 2	-1999 to 9999	EU	0		
	AL-3 Alarm value 3	-1999 to 9999	EU	0		
	P Proportional band	0.1 to 999.9	%FS	10.0		
	I Integral time	0 to 3999	sec	233		
	d Derivative time	0 to 3999	sec	40		
	C-S Cooling coefficient	0.01 to 99.99	None	1.00	At heating and cooling control	
	C-db Dead band	-19.99 to 99.99	%FS	0.00	At heating and cooling control	
	oF-r Manual reset value	0.0 to 100.0	%	50.0		
	HYS Hysteresis (heat)	0.01 to 99.99	%FS	0.10		
	[HYS Hysteresis (cool)	0.01 to 99.99	%FS	0.10	At heating and cooling control	
	[P Control period (heat)	1 to 99	sec	20		
	[-CP Control period (cool)	1 to 99	sec	20	At heating and cooling control	
	Level 2	r-L Remote/Local	RMT/LCL	None	LCL	
SP-rU SP ramp time unit		M(Minutes) / H(Hours)	None	M		
SP-rE SP ramp set value		0 to 9999	EU	0		
LbA LBA detection time		0 to 9999	Sec	0		
nu-S MV at stop		-5.0 to 105.0 *1	%	0.0		
nu-E MV at PV error		-5.0 to 105.0 *1	%	0.0		
oL-H MV upper limit		MV lower limit + 0.1 to 105.0 *2	%	105.0		
oL-L MV lower limit		-5.0 to MV upper limit -0.1 *3	%	-5.0		
o-rL MV change rate limit		0.0 to 100.0	%/sec	0.0		
I-nF Input digital filter		0 to 9999	sec	0		
ALH1 Alarm 1 hysteresis		0.01 to 99.99	%FS	0.02		
ALH2 Alarm 2 hysteresis		0.01 to 99.99	%FS	0.02		
ALH3 Alarm 3 hysteresis		0.01 to 99.99	%FS	0.02		
I-nSH Input shift upper limit		-199.9 to 999.9	°C/°F	0.0	Temperature input	
I-nSL Input shift lower limit	-199.9 to 999.9	°C/°F	0.0	Temperature input		

*1 During heat and cooling control, the lower limit becomes -105.0%.

*2 During heat and cooling control, the setting range becomes 0.0 to 105.0%.

*3 During heat and cooling control, the setting range becomes -105.0 to 0.0%.

Mode	Parameter Name	Setting Range	Unit	Default	Remarks	Setting
Setup	Ln-t	Input type	0 to 21	None	2	
	Ln-H	Scaling upper limit	Scaling lower limit +1 to 9999 *4	EU	-100	Analog input
	Ln-L	Scaling lower limit	-1999 to SP setting upper limit -0.1 *4	EU	0	Analog input
	dP	Decimal point	0 to 3	None	0	Analog input
	d-U	°C/°F selection	°C/°F	None	°C	Temperature input
	LnI	Parameter initialize	Yes/No	None	NO	
	OUT1	Control output 1 assignment	Heat/Cool/Alarm 1/Alarm 2/Alarm 3/LBA	None	HEAT	
	OUT2	Control output 2 assignment	Heat/Cool/Alarm 1/Alarm 2/Alarm 3/LBA	None	AL-1	
	SUB1	Auxiliary output 1 assignment	Alarm 1/Alarm 2/Alarm 3/LBA/S.ERR/E333	None	AL-2	
	AL1	Alarm 1 type	1 to 11	None	2	Output assignment needed
	AL1n	Alarm 1 open in alarm	N-O/N-C	None	N-O	Output assignment needed
	AL2	Alarm 2 type	1 to 11	None	2	Output assignment needed
	AL2n	Alarm 2 open in alarm	N-O/N-C	None	N-O	Output assignment needed
	AL3	Alarm 3 type	1 to 11	None	2	Output assignment needed
	AL3n	Alarm 3 open in alarm	N-O/N-C	None	N-O	Output assignment needed
	OR-EU	Direct/Reverse operation	OR-D/OR-R	None	OR-R	
Expansion	SL-H	Set point upper limit	Set point lower limit +1 to scaling upper limit *2	None	1300 *4	
	SL-L	Set point lower limit	Scaling lower limit to Set point upper limit -1 *2	None	-200 *4	
	LnI	PID/ON/OFF	PID / ON/OFF	None	PID	
	ST	ST	OFF/ON	None	OFF	
	ST-b	ST stable range	0.1 to 999.9	°C/°F	15.0	ST=ON
	ALFA	α	0.00 to 1.00	None	0.65	
	AT-G	AT calculated gain	0.1 to 10.0	None	1.0	
	rEST	Standby sequence reset setting method	0/1	None	0	
	rEt	Automatic return of display mode	0 to 99	Sec	0	
	AT-H	AT hysteresis	0.1 to 9.9	%FS	0.2	
LbAb	LBA detection width	0.0 to 999.9	%FS	0.2		
Option	EU-n	Multi-SP function	0/1	None	0	
	EU-1	Event input assignment 1	STOP/MAN	None	STOP	
	SbI	Communication stop bit	1/2	bits	2	
	LEn	Communication data length	7/8	bits	7	
	Prty	Communication parity	None/Even/Odd	None	EVEN	
	bPS	Communication baud rate	1.2/2.4/4.8/9.6/19.2	kbps	9.6	
	U-na	Communication unit No.	0 to 99	None	0	
	Tr-t	Transfer output type	SP/SP-M/PV/O/C-O	None	SP	
	Tr-H	Transfer output upper limit	*5	*5	*5	
Tr-L	Transfer output lower limit	*5	*5	*5		

*4 When temperature input is selected, the sensor range selected in the “input type” parameter (setup mode) corresponds to the scaling upper and lower limit value.

*5 Set the transfer output type parameter according to the following table.

Transfer Output Type	Transfer Output Lower Limit to Transfer Output Upper Limit
SP :Set point	Set point lower limit to Set point upper limit
SP-M :Set point during SP ramp	Set point lower limit to Set point upper limit
PV :Process value	Scaling lower limit to scaling upper limit
O :Manipulated variable (heat)	-5.0 to 105.0%
C-O :Manipulated variable (cool)	0.0 to 105.0%

- The output ranges of the SP setting, set point or process value when temperature input is selected are the ranges supported by the selected sensor.
- When the heating side manipulated variable or cooling side manipulated variable is selected, the transfer output lower limit in a heating and cooling control becomes “0.0”.

PARAMETER OPERATIONS LIST

- Switching to modes other than manual or protect mode is carried out by mode selection in the menu display.
- The figure below shows all parameters in the order that they are displayed. Some parameters are not displayed depending on the protect mode setting and conditions of use.

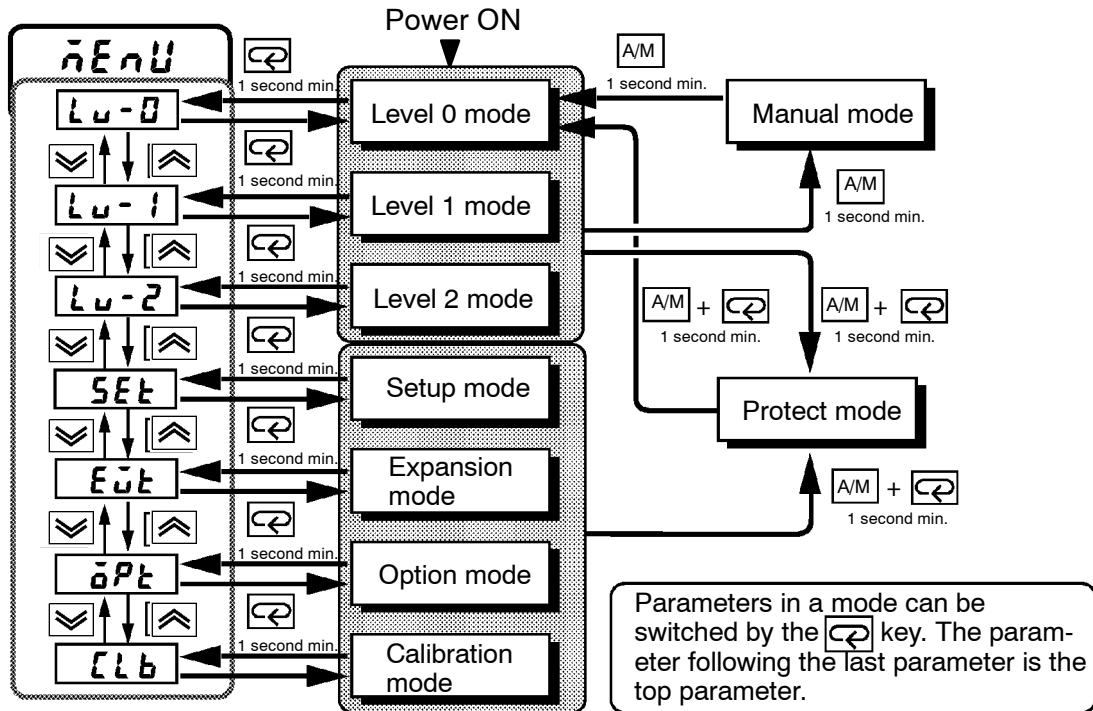

Level 0

- PV/SP
- SP-*n* Set point during SP ramp
- o* MV monitor (heat)
- c-o* MV monitor (cool)
- r-S* Run/Stop

Manual mode

- Manual MV

Protect mode

- SEC*r* Security
- PEYP [A/M] key protect

Level 1

- At AT Execute/Cancel
- SP-0 Set point 0
- SP-1 Set point 1
- AL-1 Alarm value 1
- AL-2 Alarm value 2
- AL-3 Alarm value 3
- P Proportional band
- I Integral time
- d Derivative time
- c-SC* Cooling coefficient
- c-db* Dead band
- oF-r* Manual reset value
- HYS Hysteresis (heat)
- cHYS* Hysteresis (cool)
- cP* Control period (heat)
- c-cP* Control period (cool)

Level 2

- r-L* Remote/Local
- SP*r-U* SP ramp time unit
- SP*r-t* SP ramp set value
- LbA LBA detection time
- nU-S* MV at stop
- nU-E* MV at PV error
- oL-H* MV upper limit
- oL-L* MV lower limit
- o-rL* MV change rate limit
- c-nF* Input digital filter
- ALH1 Alarm 1 hysteresis
- ALH2 Alarm 2 hysteresis
- ALH3 Alarm 3 hysteresis
- c-nSH* Input shift upper limit
- c-nSL* Input shift lower limit

Setup mode

- Ln-t** Input type
- Ln-H** Scaling upper limit
- Ln-L** Scaling lower limit
- dP** Decimal point
- d-U** °C/°F selection
- LnIt** Parameter initialize
- oUt1** Control output 1 assignment
- oUt2** Control output 2 assignment
- Sub1** Auxiliary output 1 assignment
- ALt1** Alarm 1 type
- ALIn** Alarm 1 open in alarm
- ALt2** Alarm 2 type
- AL2n** Alarm 2 open in alarm
- ALt3** Alarm 3 type
- AL3n** Alarm 3 open in alarm
- orEv** Direct/Reverse operation

Expansion mode

- SL-H** Set point upper limit
- SL-L** Set point lower limit
- ContL** PID / ON/OFF
- St** ST
- St-b** ST stable range
- ALFA** α
- At-G** AT calculated gain
- rEst** Standby sequence reset method
- rEt** Automatic return of display mode
- At-H** AT hysteresis
- LbAb** LBA detection width

Option mode

- Ev-n** Multi-SP function
- Ev-1** Event input assignment 1
- SbIt** Communication stop bit
- LEn** Communication data length
- Prty** Communication parity
- bPS** Communication baud rate
- U-n0** Communication unit No.
- tr-t** Transfer output type
- tr-H** Transfer output upper limit
- tr-L** Transfer output lower limit

Calibration mode

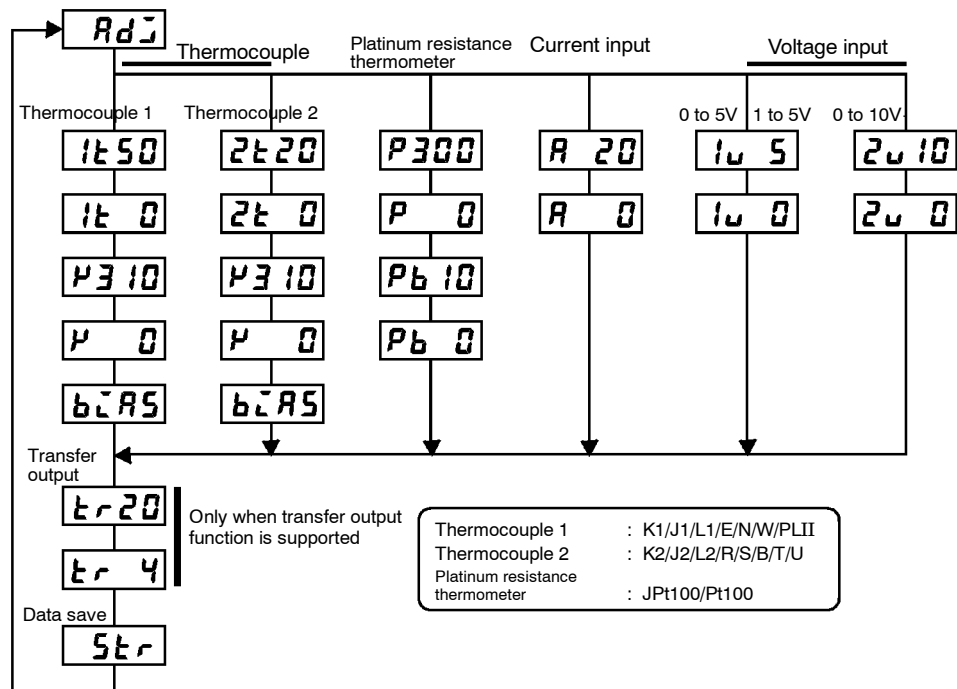

FUZZY SELF-TUNING

Fuzzy self-tuning is a function that enables the E5CK to calculate the most suitable PID constants for the controlled object.

■ Features

- The E5CK determines by itself when to perform fuzzy self-tuning.

■ Fuzzy Self-tuning Function

The fuzzy self-tuning function has three modes.

In SRT(step response tuning) mode, the PID constants are tuned using a step response method at the time the set point is changed.

In DT(disturbance tuning) mode, the PID constants are amended so that the controlled temperature will be within the target range set in advance when there is external disturbance.

In HT(hunting tuning) mode, when hunting occurs, the PID constants are amended to suppress the hunting.

Note: Be sure to turn on the power supply to the load either before or simultaneously with the start of Temperature Controller operation. Dead time will be measured from the time the Temperature Controller starts operating. If a load such as a heater is turned on after the Temperature Controller is turned on, dead time longer than the actual value will be measured and inappropriate PID constants will be obtained. If an extremely large amount of dead time is measured, the control amount will be set to 0% for a short period of time before being returned to 100%, and the constants will then be returned. Retuning is performed only for large amounts of dead time, so be sure to follow the precaution given above when starting operation.

● Startup Conditions of SRT

SRT will start if the following conditions are satisfied simultaneously when the E5CK is turned on or the set point is changed.

At the time the E5CK starts operation	At the time set point is changed
1) The set point at the time the E5CK starts operating is different from the set point used at the time SRT was last executed (see note). 2) The difference between the set point and the process value at the time the E5CK starts operating is larger than the present proportional band value $(P) \times 1.27+4$ 3) The process value at the time the E5CK starts operating is smaller than the set point in reverse operation and larger than the set point in normal operation.	1) The new set point is different from the set point used at the time SRT was executed last (see note). 2) The set point changing range is larger than the present proportional band value $(P) \times 1.27+4$. 3) The process value is in stable condition before the set point is changed. 4) A larger set point value is set in reverse operation and a smaller set point is set in normal operation.

Note: The last SRT-executed set point is set to 0 before shipping and when changing from advanced PID control to advanced PID control with fuzzy self-tuning.

● **Imposition Completion Condition of Step Control Amount**

In order to prevent overshooting, the step controlled amount must be imposed continuously only while the present deviation is the same as or greater than the value obtained from the proportional band (P) x 1.27. The step control will not be applied when the deviation becomes smaller than this value.

● **PID Constant Refreshing Conditions**

If the step control amount is applied before the maximum temperature slope (R) is obtained, SRT will not renew any PID constant. If the proportional band obtained from the R and L values that were measured before the imposition had been completed is larger than the present proportional band, the PID constants will be renewed because the measured value is in the direction towards the suitable proportional band value, and the set point at that time will be the SRT-executed set point.

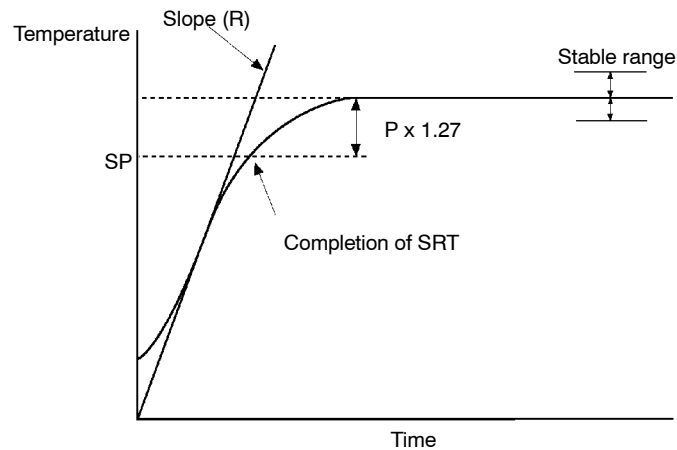

● **Stable Temperature Status**

If the temperature is within the stable range for a certain time, it is deemed that the temperature is stable. This time is called stability judgement time. Like PID constants, stability judgement time is adjusted with fuzzy self-tuning according to the characteristics of the object to be controlled. Fuzzy self-tuning will not be activated if the temperature is stable because the Temperature Controller deems that temperature control is smooth.

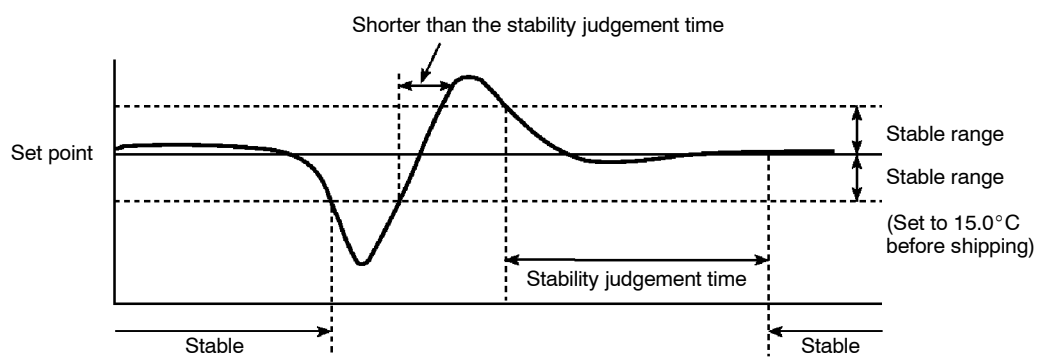

● Balanced Status

If the process value is within the stable range for 60s when there is no output, it is deemed that the temperature is balanced.

● Startup Conditions of DT

- (1) DT will start if the temperature that has been stable varies due to external disturbance and the deflection of the temperature exceeds the stable range, and then the temperature becomes stable, provided that the number of maximum temperature values is less than four.
- (2) DT will start if the set point is changed under the condition that SRT does not start and the temperature becomes stable, provided that the number of maximum temperature values is less than four. If there are four or more maximum temperature values, HT will start.

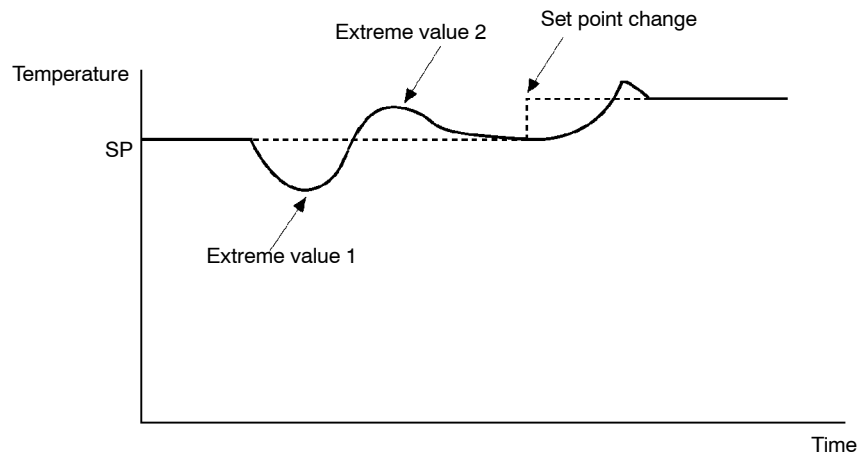

● Startup Conditions of HT

HT will be ON when there is hunting with four or more maximum temperature values (extreme values) while SRT is not being executed.

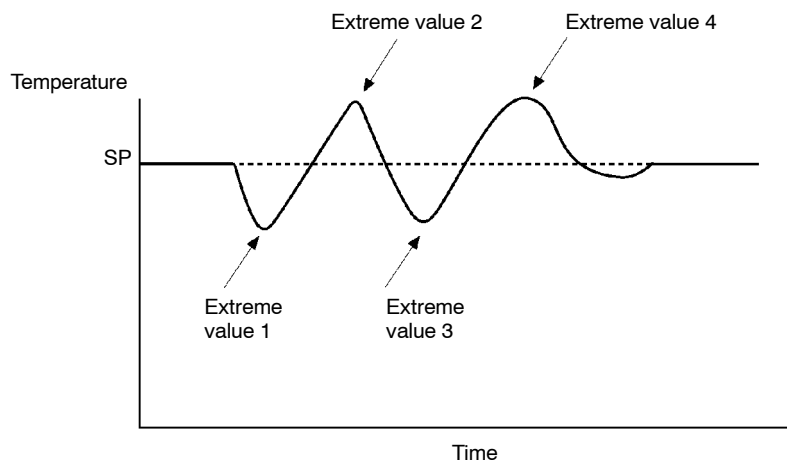

Note: In specific applications where temperature varies periodically due to disturbance, internal parameters need to be adjusted.

MODEL LIST

Description	Type Name	Specification
Base unit	E5CK-AA1	Base unit (AC100-240V~)
	E5CK-AA1-500	Base unit with terminal cover (AC100-240V~)
	E5CK-AA1 AC/DC24V	Base unit (AC/DC24V≈)
	E5CK-AA1-500 AC/DC24V	Base unit (AC/DC24V≈) with terminal cover
Output module	E53-R4R4	Relay/relay
	E53-Q4R4	Pulse (NPN)/relay
	E53-Q4HR4	Pulse (PNP)/relay
	E53-C4R4	Linear (4 to 20mA)/relay
	E53-C4DR4	Linear (0 to 20mA)/relay
	E53-V44R4	Linear (0 to 10V)/relay
	E53-Q4Q4	Pulse (NPN)/pulse (NPN)
	E53-Q4HQ4H	Pulse (PNP)/pulse (PNP)
Option module	E53-CK01	RS-232C
	E53-CK03	RS-485
	E53-CKB	Event input : 1 point
	E53-CKF	Transfer output (4 to 20mA)
Terminal cover	E53-COV07	Terminal cover for E5CK

The output unit is required for E5CK-AA1 (including -500). For details on the output unit, see page 2-3.
When adding on the option unit, also see the option unit list on page 2-3.

X FORMAT

Format

The E5CK controller supports communications in the X format which is used in other Omron controllers such as ES100, E5AJ/EJ and E5AX/EX. Commands are structured as follows and are paired with a response.

● Command

	2B	2B	2B		2B	2B
@	Unit No.	Header code	Data code	Data	FCS	* CR

● Response

	2B	2B	2B		2B	2B
@	Unit No.	Header code	End code	Data	FCS	* CR

- “@”
 - The start character. This character must be inserted before the leading byte.
- Unit No.
 - Specifies the “unit No.” of the E5CK. If there are two or more transmission destinations, specify the desired destination using “unit No.”
- Header code/Data code
 - Specifies the command type. For details on the command type, see page A-12.
- Data
 - Specifies the set value or setting content. The data length varies according to the command.
- End code
 - Sets the communication results. For details on the types and meanings of end codes, see 6.5 How to Read Communications Error Information (page 6-10).
- FCS (Frame Check Sequence)
 - Set the frame check results from the start character to the data section. For details on the frame check, see 6.6 Program Example (page 6-12).
- “*” “CR (Carriage Return) code”
 - Indicates the end (terminator) of the command or response block.

■ X FORMAT HEAD LIST

Header Code	Data Code	Command Content	R/W	Data	Remarks
IC	01	Undefined error	-	None	Error response
MB	01	Remote/Local	Write	4B	
MA	01	RAM write mode	Write	None	
ME	01	Backup mode			
MW	01	RAM data batch save			
R%	01	Alarm value 1 read	Read	4B	
	02	Alarm value 2 read			
	03	Alarm value 3 read			
RB	01	Proportional band read			
RN	01	Integrated time read			
RV	01	Derivative time read			
RC	01	Cooling coefficient read	Read	4B	During heating and cooling control
RD	01	Dead band read			
RI	01	Input shift upper limit read	Read	4B	
	02	Input shift lower limit read			
RL	01	SP setting limit read	Read	8B	Upper-and lower-limit batch read
RO	01	Manipulated variable read	Read	4B	
RS	01	Set point read			
RX	01	Process value read	Read	8B	with status
W%	01	Alarm value 1 write	Write	4B	
	02	Alarm value 2 write			
	03	Alarm value 3 write			
WB	01	Proportional band write			
WN	01	Integrated time write			
WV	01	Derivative time write			
WC	01	Cooling coefficient write	Write	4B	During heating and cooling control
WD	01	Dead band write			
WI	01	Input shift upper limit write	Write	4B	
	02	Input shift lower limit write			
WS	01	Set point write			

● RX (process value read) command status

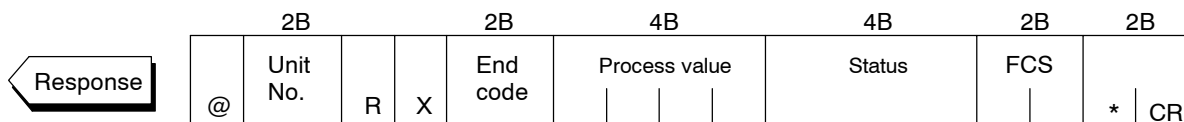

Bit	Content	"1"	"0"
0	Run/Stop	Stop	Run
1	Setting level	1	0
2	Input error	ON	OFF
3	A/D converter error	ON	OFF
4	LBA	ON	OFF
5			
6			
7	EEPROM	RAM≠EEPROM	RAM=EEPROM
8	Alarm 1	ON	OFF
9	Alarm 2	ON	OFF
10	Alarm 3	ON	OFF
11	AT	AT execution	OFF
12	RAM mode	RAM mode	Backup mode
13	Auto/Manual	Manual	Auto
14			
15	Remote/Local	Remote	Local

ASCII CODE LIST

Hex		0	1	2	3	4	5	6	7	Upper 4 bits
	Bin	0000	0001	0010	0011	0100	0101	0110	0111	
0	0000			SP	0	@	P		p	
1	0001			!	1	A	Q	a	q	
2	0010			"	2	B	R	b	r	
3	0011			#	3	C	S	c	s	
4	0100			\$	4	D	T	d	t	
5	0101			%	5	E	U	e	u	
6	0110			&	6	F	V	f	v	
7	0111			'	7	G	W	g	w	
8	1000			(8	H	X	h	x	
9	1001)	9	I	Y	i	y	
A	1010			*	:	J	Z	j	z	
B	1011			+	;	K	[k	{	
C	1100			,	<	L	¥	l		
D	1101			-	=	M]	m	}	
E	1110			.	>	N	^	n	~	
F	1111			/	?	O	_	o	DEL	

Lower 4 bits

A

- A/D converter error 3-5,7-5
- A/M key 1-3
- A/M key protect 3-10
- [A/M] key protect 5-4
- ASCII CODE LIST A-17
- AT Execute/Cancel 5-10
- AT calculated gain 5-30
- AT hysteresis 5-31
- About Calibration 1-10
- About invalid parameters 6-7
- About PID Parameters 3-14
- About the Decimal Point of
the Alarm Value 3-9
- About the power blocks 2-6
- About the event input and key
operation[event input] 4-7
- Adjusting Control Operation 3-12
- Alarm 1 hysteresis 5-19
- Alarm 1 open in alarm 5-26
- Alarm 1 type 5-25
- Alarm 2 hysteresis 5-19
- Alarm 2 open in alarm 5-26
- Alarm 2 type 5-25
- Alarm 3 hysteresis 5-19
- Alarm 3 open in alarm 5-26
- Alarm 3 type 5-25
- Alarm hysteresis 3-8
- Alarm type 3-7
- Alarm value 3-7
- Alarm value 1 3-7,5-11
- Alarm value 2 3-7,5-11
- Alarm value 3 3-7,5-11
- Auto-tuning(A.T.) 1-3,3-13
- Auto/Manual 3-12,4-7
- Automatic return of display mode 5-31
- Auxiliary output 1 assignment 5-25
- Auxiliary output 1[Terminal Nos.] 2-8

B

- Balance-less, Bump-less Operation 3-12

C

- CONTROL BLOCK DIAGRAM A-5
- Cable connections[communications] ... 6-3
- Calibrating current input 4-17
- Calibrating inputs 1-10
- Calibrating platinum resistance
thermometer 4-15
- Calibrating thermocouple 4-12
- Calibrating transfer output 1-10

- Calibrating voltage input 4-18
- Calibration 4-11
- Calibration item menu 4-12
- Calibration mode 1-7,5-36
- Calibration save mark 4-12
- Changing the set point 3-12
- Checking indication accuracy 4-20
- Close in alarm/open in alarm 3-8
- Command Configuration
[communications] 6-5
- Commands and Responses
[communications] 6-6
- Communication baud rate 5-34
- Communication data length 5-34
- Communication parity 5-34
- Communication stop bit 5-34
- Communication unit No. 5-34
- Communications parameters 6-4
- Connecting the Cold Junction
Conductor 4-12
- Control output 1 assignment 5-24
- Control output 2 assignment 5-24
- Control output[Terminal Nos.] 2-7
- Control period 3-6
- Control period(cool) 5-14
- Control period(heat) 5-14
- Cooling coefficient 4-2,5-12
- Current input 1-4

D

- Dead band 4-2,5-12
- Decimal point 5-23
- Derivative time 5-11
- Dimensions 2-4
- Direct/reverse operation 3-5,5-26
- Down key 1-3
- Draw-out 2-2

E

- Error Display 7-3
- Error output 7-5
- Event input 1-4,4-7
- Event input assignment 1 5-33
- Expansion mode 1-6,5-27

F

- Fixing settings 1-8
- Front panel 1-2

H

- Heating and cooling control 4-2
- How to Read Communications
Error Information 6-10

- How to Use Option Functions 4-7
 How to use keys 1-3
 Hysteresis 4-3
 Hysteresis(cool) 5-13
 Hysteresis(heat) 5-13
- I**
- Input and Output 1-4
 Input assignments 4-7
 Input digital filter 5-19
 Input errors 7-5
 Input shift 3-3
 Input shift lower limit 3-3,5-20
 Input shift upper limit 3-3,5-20
 Input type 3-3,5-22
 Input [Terminal Nos.] 2-6
 Installation 2-4
 Integral time 5-11
 Interface 6-2
 Issuing special commands 6-9
- L**
- LBA 4-9,7-5
 LBA detection example 4-9
 LBA detection time 4-9,5-17
 LBA detection width 4-9,5-31
 Level 0 mode 1-6,5-6
 Level 1 mode 1-6,5-9
 Level 2 mode 1-6,5-15
 Limiter operation conditions 4-5
- M**
- MANU 1-3
 MV at PV error 5-17
 MV change rate limit 5-18
 MV change rate limiter 4-4
 MV limiter 4-4
 MV lower limit 5-18
 MV monitor(cool) 5-7
 MV monitor(heat) 5-7
 MV upper limit 5-18
 Main parts 1-2
 Manipulated variable at stop 3-11,4-2
 Manipulated variable restrictions 4-4
 Manual MV 5-5
 Manual mode 1-6,5-5
 Manual operation 3-12
 Manual reset value 5-13
 Menu display 1-7
 Mode key 1-3
 Model List A-13
- Mounting 2-5
 Multi-SP 4-8
 Multi-SP function 5-33
- N**
- Names of parts 1-2
 No. 1 display 1-3
 No. 2 display 1-3
- O**
- ON/OFF control 4-3
 OUT1 1-3
 OUT2 1-3
 Operating Condition Restrictions 4-4
 Operation at start [SP ramp] 4-6
 Operation indicators 1-3
 Option mode 1-7,5-32
 Option [Terminal Nos.] 2-8
 Output assignments 1-5,3-5
- P**
- PARAMETER OPERATIONS LIST ... A-8
 PARAMETERS 5-1
 PID/ON/OFF 5-28
 PV/SP 5-6
 Panel cutout 2-4
 Parameter initialize 5-23
 Parameter types 1-6
 Parameters and Menus 1-6
 Platinum resistance thermometer 4-20
 Precautions when wiring 2-6
 Proportional band 5-11
 Protect mode 1-6,3-10,5-3
- R**
- RMT 1-3
 RS-232C 1-9,6-3
 RS-485 1-9,6-3
 Reading the status [communications] .. 6-8
 Reading/writing parameters 6-6
 Registering calibration data 1-10
 Remote/Local 5-16
 Restrictions during SP ramp 4-6
 Run/Stop 4-7,5-8
- S**
- SETTING LIST A-6
 SP ramp 4-5
 SP ramp set value 5-16
 SP ramp time unit 5-16
 SP setting lower limit 5-28
 SP setting upper limit 5-28

SPECIFICATIONS	A-2
ST	5-29
ST stable range	5-29
STOP	1-3
SUB1	1-3
Scaling	3-3
Scaling lower limit	5-23
Scaling upper limit	5-23
Security	3-10,5-3
Selecting modes	1-7
Selecting parameters	1-8
Selecting the Control Method	4-2
Set point 0	5-10
Set point 1	5-10
Set point during SP ramp	5-7
Set point limiter	4-5
Setting Alarm Type	3-7
Setting Input Specifications	3-3
Setting Output Specifications	3-5
Setting the communications specifications	6-4
Setting the input type	2-2
Setting up	2-2
Setup mode	1-6,5-21
Standby sequence	3-8
Standby sequence reset method	5-30
Starting and Stopping Operation	3-11

Summary of alarm operations	3-8
-----------------------------------	-----

T

TROUBLESHOOTING	7-1
Temperature input	1-4
Terminal arrangement	2-6
Thermocouple	4-20
Transfer output	1-5,4-8
Transfer output lower limit	5-35
Transfer output type	5-35
Transfer output upper limit	5-35
Transfer procedure [communications] ..	6-2

U

Up key	1-3
--------------	-----

V

Voltage input	1-4
---------------------	-----

W

Wiring Terminals	2-6
Writing the Set Value	6-6

X

X FORMAT	A-14
----------------	------

°C/°F selection	5-24
α	5-29

Revision History

A manual revision code appears as a suffix to the catalog number on the front cover of the manual.

Cat. No. H078-E1-03D



The following table outlines the changes made to the manual during each revision. Page numbers refer to previous version.

Revision code	Date	Revised content
1	September 1995	Original production
2	April 1996	<p>Page IV: Changed "100 to 240 VAC" to "AC100-240V or AC/DC24V".</p> <p>Page 1-3: Modified the spellings in Operation indicators.</p> <p>Page 1-7: Modified the diagram of mode.</p> <p>Page 2-6: Modified the power specifications in "Terminal arrangement".</p> <p>Page 2-7: Modified the diagram in "Control output".</p> <p>Page 3-2: Modified the diagram in "Setup".</p> <p>Page 3-8: Added some texts to summary of alarm operations.</p> <p>Page 3-9: Changed "temperature" to "humidity". Added "upper and" to the text of step (4).</p> <p>Page 3-12: Changed "temperature" to "humidity" in "Setting example". Changed "°C" to "%" in "Setting example".</p> <p>Page 3-13: Moved a block (that was the 7th bullet) to the end of the step (4) of "Setting example" on page 3-14.</p> <p>Page 4-5: Modified the diagram in "Set point limiter".</p> <p>Page 4-7: Added some texts to "Input assignments", "Run/Stop" and "Auto/Manual".</p> <p>Page 4-11: Changed a text in the diagram.</p> <p>Page 4-12: Added text to Preparations.</p> <p>Page 4-15: Modified the diagram in "Preparation".</p> <p>Page 4-17: Modified the diagram in "Preparation". Changed "voltage" to "current" in step (9).</p> <p>Page 4-18: Modified the diagram in "Preparation".</p> <p>Page 4-20: Modified the diagrams on this page.</p> <p>Page 5-2: Added some texts to the meanings of the model icons.</p> <p>Page 5-3: Added some texts to the comment descriptions.</p> <p>Page 5-5: Added some texts to Manual Mode.</p> <p>Page 5-6: Added some texts to Level 0 Mode.</p> <p>Page 5-7: Deleted "Related parameters" in "Set point during SP ramp".</p> <p>Page 5-17: Deleted some texts in "LBA detection time".</p> <p>Page 5-18: Added a sentence to the Function descriptions.</p> <p>Page 5-27: Changed "SP setting" to "Set point" on the table.</p> <p>Page 5-30: Added some texts to Condition A.</p> <p>Page 5-34: Changed the descriptions of "Related article".</p> <p>Page 6-3: Changed the diagram of RS-232C.</p> <p>Page 6-7: Changed "-999.9" to "-199.9" in the parameters No.53 and 54.</p> <p>Page 6-9: Added a sentence to Run/Stop.</p> <p>Page 6-10: Added the "End code".</p> <p>Page 6-13: Changed the program address No. "1110" to "1120".</p> <p>Page 7-6: Changed "Not possible only with 40%AT" to "40%AT" on the table.</p> <p>Page A-2: Changed the table of "Ratings".</p> <p>Page A-3: Changed "0.1%FS" to "0.01%FS" in the description of Hysteresis on table.</p> <p>Page A-5: Added some texts to the diagram.</p> <p>Page A-6,7: Modified the setting list table.</p> <p>Page A-10: Changed the descriptions of "SRT Startup Conditions".</p> <p>Page A-13: Modified the list table of "Model list".</p>
2A	July 1996	Page 6-9: Changed the table of "Instruction Code".
2B	September 1996	<p>Page 1-7: Modified the diagram in "Selecting modes".</p> <p>Page 5-33: Changed the Event Input Operation "ON:Run" to "OFF:Run".</p> <p>Page A-2: Added text to *1.</p> <p>Page A-8: Modified the diagram in "PARAMETER OPERATIONS LIST".</p> <p>Page A-10: Changed the letter "k" to "K".</p>

Revision code	Date	Revised content
3	April 1997	<p>Page 1-7: Added text to Menu display.</p> <p>Page 2-7: Deleted the Specifications of 0 to 20mA on the table of "Control output".</p> <p>Page 3-4: Added "1 second min." to the display flowchart.</p> <p>Page 3-6: Added text to Control period. Changed "control period" to "control period (heat)" in "Setting Example". Added "1 second min." to the display flowchart. Changed "control period" to "control period (heat)" in step (8).</p> <p>Page 3-9: Added "1 second min." to the display flowchart.</p> <p>Page 3-11: Changed "(-5.0 to 105.0%)" to "(Standard:-5.0 to 105.0%, Heating and Cooling:-105.0 to 105.0%)" in Manipulated variable at stop. Added "1 second min." to the display flowchart.</p> <p>Page 3-12: Deleted the display of "Changing the set point". Added a display and some texts to Manual operation.</p> <p>Page 3-13: Added a display to 40%AT.</p> <p>Page 3-14: Added a display to 100%AT. Added "1 second min." to the display flowchart.</p> <p>Page 4-2: Moved the title of Heating and cooling control". Added some texts to "Heating and cooling control".</p> <p>Page 4-4: Modified the lower figure for "MV limiter".</p> <p>Page 4-7: Moved "Run/Stop, Auto/Manual, Reference" to page 4-8. Moved "Multi-SP" on page 4-8 to 4-7.</p> <p>Page 4-8: Moved "Run/Stop, Auto/Manual, Reference" on page 4-7 to 4-8. Moved "Multi-SP" on page 4-7. Added "Factory setting is Set point" to Transfer output. Added the title of "Transfer output scaling".</p> <p>Page 4-10: Deleted (4) in Determining the LBA detection time.</p> <p>Page 4-15: Modified display flowchart.</p> <p>Page 4-17: Added "Conditions of Use" to MV at stop.</p> <p>Page 5-27: Deleted "resetting the parameters" in the sixth lines from the top.</p> <p>Page 5-29: Added "Usually use the default value." to α.</p> <p>Page 5-30: Added "Usually use the default value." to AT calculated gain. Added a figure to "Standby sequence reset method".</p> <p>Page 5-31: Added "Usually use the default value." to AT hysteresis.</p> <p>Page 5-35: Added some texts to the table. Deleted "When you have selected the "manipulated variable (heat)" parameter, the transfer output lower limit during heating and cooling control becomes "0.0"".</p> <p>Page 6-11: Deleted "End code12".</p> <p>Page 7-5: Added "(auxiliary output 1)" to Input errors and A/D converter error.</p> <p>Page A-4: Modified the table of "Output Unit Ratings and Characteristics".</p> <p>Page A-5: Modified the diagram.</p> <p>Page A-6: Added Remarks to the Parameter of "Remote/Local".</p> <p>Page A-7: Changed the description "-5.0 to 105.0%" of "O" in Transfer Output Type to "Standard:-50. To 105.0%, Heating and cooling:0.0 to 105.0%". Deleted two lines of the texts from the bottom.</p> <p>Page A-10: Deleted 2) of "At the time the E5CK starts operation" in "Startup Conditions of SRT". Deleted 2) of "At the time set point is changed".</p> <p>Page A-11: Deleted "Imposition Completion Condition of Step Control Amount". Modified figure in "PID Constant Refreshing Conditions".</p> <p>Page A-13: Changed "Type Name" and "Specification" in "Base unit".</p> <p>Page A-14: Added some texts to "Format". Modified the diagram in "Command". Modified "X FORMAT HEAD LIST". Added "Note".</p>
3A	April 1998	<p>Page 3-5: Added a sentence to "Output assignments".</p> <p>Page A-7: Changed "OR-R/OR-D" to "OR-D/OR-R" in the middle of the page.</p>
03B	March 2004	<p>Page 5-3: Changed the bottom table.</p> <p>Page A-6: Add "FS" to the "Unit" column in three cells toward the bottom of the table.</p>
03C	December 2004	<p>Page A-3: Added information to table and accompanying notes.</p>
03D	August 2006	<p>Page 5-8: Changed description of key operation in second bulleted item.</p>

OMRON

OMRON Corporation
Industrial Automation Company

Control Devices Division H.Q.

Analog Controller Division

Shiokoji Horikawa, Shimogyo-ku,
Kyoto, 600-8530 Japan
Tel: (81)75-344-7080/Fax: (81)75-344-7189

Regional Headquarters

OMRON EUROPE B.V.

Wegalaan 67-69, NL-2132 JD Hoofddorp
The Netherlands
Tel: (31)2356-81-300/Fax: (31)2356-81-388

OMRON ELECTRONICS LLC

1 East Commerce Drive, Schaumburg, IL 60173
U.S.A.
Tel: (1)847-843-7900/Fax: (1)847-843-8568

OMRON ASIA PACIFIC PTE. LTD.

83 Clemenceau Avenue,
#11-01, UE Square,
239920 Singapore
Tel: (65)6835-3011/Fax: (65)6835-2711

OMRON (CHINA) CO., LTD.

Room 2211, Bank of China Tower,
200 Yin Cheng Road (M),
Shanghai, 200120 China
Tel: (86)21-5037-2222/Fax: (86)21-5037-2200

Authorized Distributor: