

Programmable Digital Controller E5AR-T E5ER-T

User's Manual

Overview

Preparations

Typical Control
Examples

Settings Required
for Basic Control

Functions and
Operations

CompoWay/F
Communications

Modbus
Communications

Parameters

User Calibration

Troubleshooting

Appendix

Introduction

OMRON products are manufactured for use according to proper procedures by a qualified operator and only for the purposes described in this manual.

This manual describes the functions, performance, and application methods needed for optimum use of the E5AR-T/ER-T Programmable Digital Controllers.

Please observe the following items when using the E5AR-T/ER-T Programmable Digital Controllers.

- This product is designed for use by qualified personnel with a knowledge of electrical systems.
- Read this manual carefully and make sure you understand it well to ensure that you are using the E5AR-T/ER-T Programmable Digital Controllers correctly.
- Keep this manual in a safe location so that it is available for reference when required.

Precautions on Using the Product

Before using the Controller under the following conditions, make sure that the ratings and performance characteristics of the Controller are sufficient for the systems, machines, and equipment, and be sure to provide the systems, machines, and equipment with double safety mechanisms, and also consult your OMRON representative.

- Using the Controller under conditions which are not described in the manual
- Applying the Controller to nuclear control systems, railroad systems, aviation systems, vehicles, combustion systems, medical equipment, amusement machines, safety equipment, and other systems, machines, and equipment
- Applying the Controller to systems, machines, and equipment that may have a serious influence on lives and property if used improperly, and especially require safety

Notice

- (1) All rights reserved. No part of this manual may be reprinted or copied without the prior written permission of OMRON.
- (2) The specifications and other information in this manual are subject to change without notice for purposes of improvement.
- (3) Considerable care has been taken in the preparation of this manual; however, OMRON assumes no responsibility or liability for any errors or inaccuracies that may appear. In the event that a problem is discovered, please contact one of the OMRON offices or agents listed at the end of the manual, and provide the catalogue number shown on the cover of the manual.

Terms and Conditions Agreement

Read and understand this Manual

Please read and understand this catalog before purchasing the products. Please consult your OMRON representative if you have any questions or comments.

Warranty, Limitations of Liability

Warranties

- **Exclusive Warranty** Omron's exclusive warranty is that the Products will be free from defects in materials and workmanship for a period of twelve months from the date of sale by Omron (or such other period expressed in writing by Omron). Omron disclaims all other warranties, express or implied.

- **Limitations** OMRON MAKES NO WARRANTY OR REPRESENTATION, EXPRESS OR IMPLIED, ABOUT NON-INFRINGEMENT, MERCHANTABILITY OR FITNESS FOR A PARTICULAR PURPOSE OF THE PRODUCTS. BUYER ACKNOWLEDGES THAT IT ALONE HAS DETERMINED THAT THE PRODUCTS WILL SUITABLY MEET THE REQUIREMENTS OF THEIR INTENDED USE.
Omron further disclaims all warranties and responsibility of any type for claims or expenses based on infringement by the Products or otherwise of any intellectual property right.

- **Buyer Remedy** Omron's sole obligation hereunder shall be, at Omron's election, to (i) replace (in the form originally shipped with Buyer responsible for labor charges for removal or replacement thereof) the non-complying Product, (ii) repair the non-complying Product, or (iii) repay or credit Buyer an amount equal to the purchase price of the non-complying Product; provided that in no event shall Omron be responsible for warranty, repair, indemnity or any other claims or expenses regarding the Products unless Omron's analysis confirms that the Products were properly handled, stored, installed and maintained and not subject to contamination, abuse, misuse or inappropriate modification. Return of any Products by Buyer must be approved in writing by Omron before shipment. Omron Companies shall not be liable for the suitability or unsuitability or the results from the use of Products in combination with any electrical or electronic components, circuits, system assemblies or any other materials or substances or environments. Any advice, recommendations or information given orally or in writing, are not to be construed as an amendment or addition to the above warranty.

See <http://www.omron.com/global/> or contact your Omron representative for published information.

Limitation on Liability; Etc

OMRON COMPANIES SHALL NOT BE LIABLE FOR SPECIAL, INDIRECT, INCIDENTAL, OR CONSEQUENTIAL DAMAGES, LOSS OF PROFITS OR PRODUCTION OR COMMERCIAL LOSS IN ANY WAY CONNECTED WITH THE PRODUCTS, WHETHER SUCH CLAIM IS BASED IN CONTRACT, WARRANTY, NEGLIGENCE OR STRICT LIABILITY.

Further, in no event shall liability of Omron Companies exceed the individual price of the Product on which liability is asserted.

Application Considerations

Suitability of Use

Omron Companies shall not be responsible for conformity with any standards, codes or regulations which apply to the combination of the Product in the Buyer's application or use of the Product. At Buyer's request, Omron will provide applicable third party certification documents identifying ratings and limitations of use which apply to the Product. This information by itself is not sufficient for a complete determination of the suitability of the Product in combination with the end product, machine, system, or other application or use. Buyer shall be solely responsible for determining appropriateness of the particular Product with respect to Buyer's application, product or system. Buyer shall take application responsibility in all cases.

NEVER USE THE PRODUCT FOR AN APPLICATION INVOLVING SERIOUS RISK TO LIFE OR PROPERTY WITHOUT ENSURING THAT THE SYSTEM AS A WHOLE HAS BEEN DESIGNED TO ADDRESS THE RISKS, AND THAT THE OMRON PRODUCT(S) IS PROPERLY RATED AND INSTALLED FOR THE INTENDED USE WITHIN THE OVERALL EQUIPMENT OR SYSTEM.

Programmable Products

Omron Companies shall not be responsible for the user's programming of a programmable Product, or any consequence thereof.

Disclaimers

Performance Data

Data presented in Omron Company websites, catalogs and other materials is provided as a guide for the user in determining suitability and does not constitute a warranty. It may represent the result of Omron's test conditions, and the user must correlate it to actual application requirements. Actual performance is subject to the Omron's Warranty and Limitations of Liability.

Change in Specifications

Product specifications and accessories may be changed at any time based on improvements and other reasons. It is our practice to change part numbers when published ratings or features are changed, or when significant construction changes are made. However, some specifications of the Product may be changed without any notice. When in doubt, special part numbers may be assigned to fix or establish key specifications for your application. Please consult with your Omron's representative at any time to confirm actual specifications of purchased Product.

Errors and Omissions

Information presented by Omron Companies has been checked and is believed to be accurate; however, no responsibility is assumed for clerical, typographical or proofreading errors or omissions.

Precautions

Definition of Safety Notices and Information





The following notation is used in this manual to provide precautions required to ensure safe usage of the product.

The safety precautions that are provided are extremely important to safety. Always read and heed the information provided in all safety precautions.





The following notation is used.

 Caution	Indicates a potentially hazardous situation which, if not avoided, may result in minor or moderate injury or in property damage.
--	--

● Symbols

Symbol		Meaning
Caution		General Caution Indicates non-specific general cautions, warnings, and dangers.
		Electrical Shock Caution Indicates possibility of electric shock under specific conditions.
Prohibition		General Prohibition Indicates non-specific general prohibitions.
Mandatory Caution		General Caution Indicates non-specific general cautions, warnings, and dangers.

● Precautions

 CAUTION	
<p>Do not touch the terminals while power is being supplied. Doing so may occasionally result in minor injury due to electric shock.</p>	
<p>Do not touch the terminals or the electronic components or patterns on the PCB within 1 minute after turning OFF the power supply. Doing so may occasionally result in minor injury due to electric shock.</p>	
<p>Do not allow pieces of metal, wire clippings, or fine metallic shavings or filings from installation to enter the product. Doing so may occasionally result in electric shock, fire, or malfunction.</p>	
<p>Do not use the product in locations where flammable or explosive gases are present. Doing so may occasionally result in minor or moderate explosion, causing minor or moderate injury, or property damage.</p>	
<p>Do Not disassemble, modify, or repair the product or touch any of the internal parts. Minor electric shock, fire, or malfunction may occasionally occur.</p>	
<p>Tighten the screws on the terminal block to the following specified torque. Loose screws may occasionally cause fire, resulting in minor or moderate injury, or damage to the equipment. Terminal block screws: 0.40 to 0.56 N·m</p>	
<p>Perform correct setting of the product according to the application. Failure to do so may occasionally cause unexpected operation, resulting in minor or moderate injury, or damage to the equipment.</p>	
<p>A malfunction in the Product may occasionally make control operations impossible or prevent alarm outputs, occasionally resulting in property damage to the system or equipment connected to the Product. To maintain safety in the event of malfunction of the Product, take appropriate safety measures, such as installing a monitoring device in a separate system.</p>	
<p>Do not use the equipment for measurements within measurement categories II, III, or IV (according to IEC61010-1). Doing so may occasionally cause unexpected operation, resulting in minor or moderate injury, or damage to the equipment. Use the equipment for measurements only within the measurement categories for which the product is designed.</p>	
<p>The service life of the output relays depends on the switching capacity and switching conditions. Consider the actual application conditions and use the product within the rated load and electrical service life. Using the product beyond its service life may occasionally result in contact welding or burning.</p>	

Precautions for Safe Use

- (1) Use and store the Digital Controller in the range of specifications for ambient temperature and humidity. The service life will decrease due to increased internal temperature if multiple Digital Controllers are mounted closely side by side or one on top of the other. If this type of mounting is used, use forced cooling, e.g., use a fan to blow air onto the Digital Controllers.
- (2) Do not prevent heat dissipation by obstructing the periphery of the Digital Controller. Do not block the vents on the Digital Controller unit.
- (3) The supplied power voltage and load must be within the rated and specified ranges.
- (4) Be sure to confirm the name and polarity for each terminal before wiring the terminal block.
- (5) Do not connect anything to unused terminals.
- (6) Use the specified size of crimp terminals (M3, width: 5.8 mm max.) to wire the terminal block. When connecting bare wires, use copper stranded or solid wires, and use AWG22 (cross-sectional area of 0.326 mm²) to AWG14 (cross-sectional area of 2.081 mm²) for the power supply terminals and AWG28 (cross-sectional area of 0.081 mm²) to AWG16 (cross-sectional area of 1.309 mm²) for other terminals. (Length of exposed wire: 6 to 8 mm)
- (7) Ensure that the rated voltage is attained within 2 seconds after turning ON the power.
- (8) Turn OFF the power first when you need to draw out the Digital Controller. Do Not touch the terminals or the electronic components, or subject them to physical shock. When inserting the Digital Controller, do not allow the electronic components to contact the case.
- (9) Do not remove the inner circuit board.
- (10) The output may turn OFF when shifting to certain levels. Take this into consideration when performing control.
- (11) Allow a warm-up time of at least 30 minutes.
- (12) To prevent inductive noise, separate the Digital Controller terminal block wiring from power lines that carry high voltages or high currents. Also, do not wire power lines together with or parallel to the Digital Controller wiring. Using shielded cables and separate conduits or ducts is recommended.
Attach a surge suppressor or noise filter to peripheral devices that generate noise (in particular, motors, transformers, solenoids, magnetic coils, or other equipment that has an inductive component). When a noise filter is used at the power supply, first check the voltage or current, and attach the noise filter as close as possible to the product. Allow as much space as possible between the product and devices that generate powerful high frequencies (e.g., high-frequency welders, high-frequency sewing machines) or surge.
- (13) Install a switch or circuit breaker that allows the operator to immediately turn OFF the power, and label suitably.
- (14) The product is designed for indoor use only.
Do not use the product outdoors or in any of the following locations.
 - Locations where dust or corrosive gas is present (in particular, sulfur or ammonia gases)
 - Locations where condensation or ice may form
 - Locations directly exposed to sunlight
 - Locations subject to strong shocks or vibration
 - Locations where water or oil may splatter on the Digital Controller
 - Locations directly exposed to radiant heat from heating equipment
 - Locations subject to sudden or extreme changes of temperature
- (15) Do not use paint thinner or similar chemical to clean with. Use standard grade alcohol.

Precautions for Correct Use

● Service Life

Use the product within the following temperature and humidity ranges:

Temperature: -10 to 55°C (no icing or condensation)

Humidity: 25% to 85%

When the product is installed inside a control panel, make sure that the temperature around the product, not the temperature around the control panel, does not exceed 55°C.

The service life of this product and similar electronic devices is determined not only by the number of switching operations of relays but also by the service life of internal electronic components. Component service life is affected by the ambient temperature: the higher the temperature becomes, the shorter the service life becomes and, the lower the temperature becomes, the longer the service life becomes. Therefore, the service life can be extended by lowering the temperature of the product.

Be sure to install the product according to the specified conditions. Otherwise, the heat generated by the product will cause the internal temperature to rise, shortening the service life. If necessary, cool the product using fans or other means of air ventilation.

When providing forced cooling, however, be careful not to cool down the terminals sections alone to avoid measurement errors.

● Noise Countermeasures

To prevent inductive noise, separate the wiring for the product's terminal block and connector from high-voltage, high-current power lines. Do not run the wiring parallel to or in the same cable as power lines. The influence of noise can also be reduced by using separate wiring ducts or shield lines.

Install surge absorbers or noise filters in devices near the product that generate noise (in particular, devices with an inductance component, such as motors, transformers, solenoids, and magnetic coils).

If a noise filter is used for the power supply, check the voltage and current, and install the noise filter as close as possible to the product.

Separate the product as far as possible from devices generating strong high-frequency noise (e.g., high-frequency welders and high-frequency sewing machines) or surges.

● Measurement Accuracy

When extending the thermocouple lead wire, be sure to use a compensating wire that matches the thermocouple type.

When extending the lead wire of the platinum resistance thermometer, be sure to use wires that have low resistance, and make sure that the resistances of the three lead wires are the same.

If the measurement accuracy is low, check whether the input shift is set correctly.

● Waterproofing

The degree of protection is as shown below.

Front panel	NEMA 4x indoor use
Rear case	IP20
Terminals	IP00

About this Manual

● How to use the manual

Purpose	Related section	Contents
General explanation of the E5AR-T/ER-T	Section 1 Overview	Explains the features, part names, and main functions of the E5AR-T/ER-T.
Setup	Section 2 Preparations Section 3 Typical Control Examples	Explains how to set up the E5AR-T/ER-T for operation (including mounting, wiring, and initial settings).
Basic operation of the E5AR-T/ER-T	Section 4 Settings Required for Basic Control Section 8 Parameters	Explains the basic functions of the E5AR-T/ER-T.
Advanced functions of the E5AR-T/ER-T	Section 5 Functions and Operations Section 8 Parameters	Explains the operating methods required to get the most out of the E5AR-T/ER-T, such as functions related to programmed operation.
Communication functions	Section 6 CompoWay/F Communications Section 7 Modbus Communications	Explains how to use communication-based functions.
User calibration	Section 9 User Calibration	Explains calibration procedures that can be performed by the user.
Troubleshooting	Section 10 Troubleshooting	Explains what to do when you encounter a problem.
Appendix		Provides product specifications and lists of parameters. Can be used to make a copy of your parameter settings.

● Special Notation

(1) Important

“Important” appears where incorrect settings or operation will prevent a function from achieving the expected result.

Important

Set the input type before setting the scaling value.
If the input type is changed after setting the scaling value, the scaling value will be automatically initialized.

(2) Hint

“Hint” gives useful hints, advice, and other supplemental information.

Hint

Overshooting can be adjusted using the external interference overshoot adjustment function when there is excessive overshooting in temperature control (i.e., in response to external interference).

(3) Notation used to indicate various information on parameters (“Function,” “Setting,” “Monitor,” and “Reference”) are explained in *Section 8 Parameters*.

● Abbreviations

Abbreviations used in the parameters, illustrations, and text are listed in the following table.

Abbreviation	Meaning	Abbreviation	Meaning
PV	Present value	ch	Channel
SP	Set point	CH	Channel
SV	Set value	PSP	Program SP
AT	Auto-tuning	RSP	Remote SP
EU	Engineering units*	FSP	Fixed SP

* Data after scaling is shown in engineering units such as °C, m, and g. “EU” is used to indicate the minimum increment of such a quantity. For example, the minimum increment of 50.02 m is 0.01 m, and thus 1 EU would be equal to 0.01 m.

● Notation Used for Settings

Letters, numbers, and abbreviations in settings that appear on the E5AR-T/ER-T display are as follows:

A	B	C	D	E	F	G	H	I	J	K	L	M
---	---	---	---	---	---	---	---	---	---	---	---	---

N	O	P	Q	R	S	T	U	V	W	X	Y	Z
---	---	---	---	---	---	---	---	---	---	---	---	---

0	1	2	3	4	5	6	7	8	9	-1
0	1	2	3	4	5	6	7	8	9	-1 (Most significant digit)

● Revision History

The revision code of this manual is given at the end of the catalog number at the bottom left of the back cover. The following table outlines the changes made to the manual during each revision. Page numbers refer to the previous version.

Cat. No.	H201-E1-03
----------	------------

Revision code	Date	Pages and changes
01	September 2006	Original production
02	November 2010	<p>The wording for voltage outputs was changed from “pulses” to “for driving SSR” throughout the manual.</p> <p>Page 1-10: Added note.</p> <p>Page 1-13: Changed descriptions of output 1 and output 2.</p> <p>Pages 6-9 and 7-10: Replaced last paragraph.</p> <p>Page A-13: Changed setting/monitor ranges for Modbus addresses 0614, 0616, 0618, and 061A. Deleted note 5 and added reference to note 5.</p> <p>Page A-14: Changed setting/monitor range for Modbus addresses 1824. Changed references from note 6 to note 5.</p> <p>Page A-15: Deleted note 5 and changed references from note 7 to note 6.</p> <p>Page A-17: Deleted note 2 and changed references from note 3 to note 2.</p> <p>Page A-21: Changed setting/monitor ranges for Modbus addresses 1904, 1906, 190A, 190C, 1910, and 1912. Deleted note 4.</p> <p>Page A-39: Changed setting/monitor ranges for CompoWay/F addresses 0011, 0012, 0014, 0015, 0017, and 0018.</p> <p>Page A-40: Changed setting/monitor range for CompoWay/F addresses 0402.</p> <p>Page A-43: Removed note.</p>
03	September 2013	<p>Page 2-2: Added text to figures.</p> <p>Page 5-6: Corrected 210.0 to 190.0 in two places.</p> <p>Page 8-59: Added paragraph to second section.</p> <p>Page 10-3: Changed correction for EEPROM error.</p>

TABLE OF CONTENTS

Introduction	I
Precautions on Using the Product	I
Read and understand this Manual	II
Warranty, Limitations of Liability	II
Application Considerations	III
Disclaimers	III
Precautions	IV
Precautions for Safe Use	VI
Precautions for Correct Use	VII
About this Manual	VIII

Section 1 Overview

1.1	Main Features of the E5AR-T and E5ER-T	1-2
	Inputs	1-2
	Controller	1-2
	Outputs	1-3
1.2	Part Names and Functions	1-4
	Front Panel	1-4
	Interpreting the Display	1-5
	Using the Keys	1-7
1.3	I/O and Main Functions	1-8
	I/O Configuration	1-8
	Main Functions	1-9
	Model Number Structure	1-13

Section 2 Preparations

2.1	Installation	2-2
	Dimensions	2-2
	Installation	2-2
2.2	Using the Terminals	2-4
	Terminal Arrangements	2-4
	Precautions when Wiring	2-9
	Wiring	2-10

Section 3 Typical Control Examples

3.1	Standard Control	3-2
	Application	3-2
	Wiring	3-3
	Settings	3-3
	Program Settings	3-5
	Adjustment	3-6
3.2	Coordinated Electric Oven Operation	3-7
	Application	3-7
	Wiring	3-7
	Settings	3-8

Section 4 Settings Required for Basic Control

4.1	Setting Levels and Key Operations	4-2
	Changing Parameters	4-4
	Saving Parameter Settings	4-4
4.2	Set Values	4-6
4.3	Initial Setting Example	4-7
4.4	Setting the Input Type	4-10
	Input Type	4-10
	Scaling	4-11
4.5	Selecting the Temperature Unit	4-14
4.6	Selecting the Control Mode	4-15
	Standard Control	4-15
	Heating/Cooling Control	4-15
	Standard Control with Remote SP	4-16
	Heating/Cooling Control with Remote SP	4-16
	Proportional Control	4-16
	Cascade Standard Control	4-17
	Cascade Heating/Cooling Control	4-17
	Position-proportional Control	4-18
4.7	Setting Output Parameters	4-20
	Control Period	4-20
	Direct Operation (Cooling)/Reverse Operation (Heating)	4-20
	Output Type	4-21
	Output Assignments	4-21
4.8	Program Settings	4-23
	Outline of Program Functions	4-23
	Program Parameters	4-23
	Program Setting Example	4-25
4.9	Performing ON/OFF Control	4-31
	ON/OFF Control	4-31
	Settings	4-32
4.10	Determining the PID Constants (AT or Manual Settings)	4-33
	Auto-tuning (AT)	4-33
	Limit Cycle	4-35
	Manual Settings	4-36
4.11	Using Auxiliary Outputs	4-37
	Auxiliary Output Assignments	4-37
	Alarm Types	4-38
	Alarm Values	4-39
	Alarm Sets	4-39
	Settings	4-39
4.12	Starting and Stopping Operation	4-41
	Starting Operation (Run) and Stopping Operation (Reset)	4-41
	Other	4-45
	Settings	4-46
4.13	Manual Operation	4-47
	Manual Mode	4-47
4.14	Changing Channels	4-50
	Changing Channels	4-50
4.15	Adjusting Programs	4-51
	Changing the SP	4-51
	Changing the Time	4-51
4.16	Operating Precautions	4-52

Section 5 Functions and Operations

- 5.1 Input Adjustment Functions 5-2
 - Input Correction 5-2
 - First Order Lag Operation 5-5
 - Moving Average 5-5
 - Broken-line Approximation 5-6
 - Extraction of Square Root 5-7
 - Other Input Adjustments 5-7
- 5.2 Control Functions 5-8
 - Alarm Sets 5-8
 - SP Limits 5-9
 - PID Sets 5-10
 - Operating Programs Using Multiple Channels 5-11
 - Disturbance Overshoot Adjustment 5-13
- 5.3 Output Adjustment Functions 5-15
 - MV Limits 5-15
 - MV Change Rate Limit 5-16
 - MV at Reset 5-17
 - MV at PV Error 5-17
- 5.4 Display and Key Adjustment Functions 5-18
 - Display Scan 5-18
 - PF Settings (Function Keys) 5-20
 - Other Display and Key Adjustment Functions 5-22
- 5.5 Protecting Settings 5-23
 - Protection 5-23
- 5.6 Alarm Adjustment Functions 5-25
 - Alarm Hysteresis 5-25
 - Standby Sequence 5-25
 - Alarm Latch 5-26
 - Close in Alarm/Open in Alarm 5-26
 - Alarm SP Selection 5-26
- 5.7 Program Operation Functions 5-28
 - Rate of Rise Programming 5-28
 - Program Operations 5-30
 - SP Modes 5-31
 - Wait 5-32
 - Time Signal 5-33
 - Segment Outputs 5-34
 - Program Status Outputs 5-36
 - Operation at Program Start 5-37
 - End Condition 5-38
- 5.8 Using Event Inputs 5-39
 - Event Input Assignments 5-39
- 5.9 Using a Transfer Output 5-47
 - Transfer Output Settings 5-47
- 5.10 Using Communications 5-49
 - Setting Communications Parameters 5-49
 - Communications Writing 5-50

Section 6 CompoWay/F Communications

- 6.1 Communications Method 6-2
 - CompoWay/F Communications 6-2
 - Communications Specifications 6-2
 - Transfer Protocol 6-3

6.2	Frames	6-4
	Command Frames	6-4
	Response Frames	6-5
6.3	FINS-mini Text	6-6
6.4	Variable Areas	6-7
	Variable Types	6-7
	Addresses	6-8
	Number of Elements	6-9
	Set Values	6-9
6.5	Read from Variable Area	6-10
6.6	Write to Variable Area	6-11
6.7	Operation Commands	6-13
6.8	Setting Areas	6-15
6.9	Commands and Responses	6-17
	Reading Monitor Values	6-17
	Reading Set Values	6-18
	Composite Read from Variable Area	6-19
	Writing Set Values in Protect Level	6-21
	Writing Set Values	6-21
	Set Value Compound Write	6-23
	Composite Read Registration	6-24
	Composite Read Registration Confirmation	6-25
	Composite Registration Read	6-25
	Communications Writing	6-26
	Run/Reset	6-26
	AT Execute	6-27
	AT Cancel	6-28
	Write Mode	6-28
	Save RAM Data	6-30
	Software Reset	6-30
	Move to Setting Area 1	6-30
	Move to Protect Level	6-31
	Auto/Manual	6-31
	Parameter Initialization	6-32
	Alarm Latch Cancel	6-33
	SP Mode	6-33
	Hold	6-34
	Advance	6-35
	Back	6-36
	Controller Attribute Read	6-36
	Controller Status Read	6-38
	Echoback Test	6-39
6.10	Program Example	6-40
	N88Basic	6-40

Section 7 Modbus Communications

7.1	Communications Method	7-2
	Modbus Communications	7-2
	Communications Specifications	7-2
	Transfer Protocol	7-3
7.2	Frames	7-4
	Command Frames	7-4
	Response Frames	7-5
7.3	List of Functions	7-7
7.4	Variable Areas	7-8

	Addresses	7-8
	Number of Elements	7-9
	Set Values	7-10
7.5	Read from Variable Area	7-11
7.6	Write to Variable Area	7-13
7.7	Operation Commands	7-15
7.8	Setting Areas	7-18
7.9	Commands and Responses	7-20
	Reading Monitor Values	7-20
	Reading Set Values	7-21
	Writing Set Values in Protect Level	7-22
	Writing Set Values	7-23
	Communications Writing	7-24
	Run/Reset	7-25
	AT Execute	7-26
	AT Cancel	7-27
	Write Mode	7-27
	Save RAM Data	7-28
	Software Reset	7-29
	Move to Setting Area 1	7-29
	Move to Protect Level	7-30
	Auto/Manual	7-30
	Parameter Initialization	7-31
	Alarm Latch Cancel	7-32
	SP Mode	7-32
	Hold	7-33
	Advance	7-34
	Back	7-35
	Echoback Test	7-35

Section 8 Parameters

8.1	Using this Section	8-2
8.2	Protect Level ($\bar{L}Pr\bar{L}$)	8-3
8.3	Operation Level ()	8-6
8.4	Program Setting Level ()	8-16
8.5	Adjustment Level ($\bar{L}Ad\bar{L}$)	8-22
8.6	Adjustment 2 Level ($\bar{L}Ad2\bar{L}$)	8-33
8.7	Alarm Set Setting Level ($\bar{L}AL\bar{n}$)	8-36
8.8	PID Setting Level ($\bar{L}P\bar{L}d$)	8-39
8.9	Time Signal Setting Level ()	8-43
8.10	Approximation Setting Level ($\bar{L}EE\bar{L}$)	8-46
8.11	Input Initial Setting Level ($\bar{L}I$)	8-49
8.12	Control Initial Setting Level ($\bar{L}I$)	8-55
8.13	Control Initial Setting 2 Level ($\bar{L}I2$)	8-63
8.14	Alarm Setting Level ($\bar{L}A$)	8-74
8.15	Display Adjustment Level ($\bar{L}A$)	8-80
8.16	Communications Setting Level ($\bar{L}A$)	8-84
8.17	Advanced Function Setting Level ($\bar{L}AdF$)	8-88
8.18	Expansion Control Setting Level ($\bar{L}E\bar{L}$)	8-94

Section 9 User Calibration

9.1	Parameters for User Calibration	9-2
	Output Calibration Parameters	9-2
9.2	User Calibration	9-4

	Input Calibration	9-4
	Output Calibration	9-4
	Registering Calibration Data	9-4
9.3	Thermocouple Input Calibration	9-5
	Preparations	9-5
9.4	Analog Input Calibration	9-8
9.5	Resistance Thermometer Calibration	9-10
9.6	Output Calibration	9-12
9.7	Inspecting Indicator Accuracy	9-14
	Thermocouples	9-14
	Resistance Thermometers	9-14
	Analog Inputs	9-15

Section 10 Troubleshooting

10.1	Troubleshooting Checklist	10-2
10.2	Error Messages	10-3
10.3	Inferring Causes from Conditions: Abnormal Measured Values	10-5
	The Measured Value Is Abnormal or Measurement Is Not Possible	10-5
10.4	Inferring Causes from Conditions: Abnormal Control	10-7
	The PV Does Not Increase	10-7
	The Measured Value Increases Above the SP	10-7
	Overshooting or Undershooting Occurs	10-8
	Hunting Occurs	10-8
	SP Does Not Change as Programmed	10-9
	The Segment Does Not Advance	10-9
	The Program Is Reset in the Middle	10-9
10.5	Inferring Causes from Conditions: Abnormal Outputs	10-10
	No Control Output or No Alarm Output	10-10
10.6	Inferring Causes from Conditions: Communications Problems	10-11
	Cannot Communicate or No Response	10-11
10.7	Inferring Causes from Conditions: Reset Operation	10-12
	Outputs Are Made While Resetting (Operation Will Not Stop)	10-12

Appendix

Specifications	A-2
Unit Ratings	A-2
Controller Performance Specifications	A-3
Sensor Input Setting Ranges and Display/Control Ranges	A-4
ASCII Table	A-5
Setting Lists	A-6
E5□R-T Status (Communications)	A-8
E5□R-T Program Status (Communications)	A-10
Initialization Due to Changing Parameter Settings	A-44
Parameter Charts	A-48

Index

Section 1 Overview

1.1	Main Features of the E5AR-T and E5ER-T	1-2
1.2	Part Names and Functions	1-4
1.3	I/O and Main Functions	1-8

1.1 Main Features of the E5AR-T and E5ER-T

The E5AR-T/ER-T is an advanced Programmable Digital Controller that features high-precision control. The E5AR-T/ER-T has the following features.

■ Inputs

● High-speed Sampling

- Sampling period: 50 ms

● High Accuracy and High Resolution

- Indication accuracy
 - Thermocouple: (Larger of $\pm 0.1\%$ PV or $\pm 1^\circ\text{C}$) ± 1 digit max.
 - Platinum resistance thermometer:
 - (Larger of $\pm 0.1\%$ PV or $\pm 0.5^\circ\text{C}$) ± 1 digit max.
 - Analog input: ($\pm 0.1\%$ FS) ± 1 digit max
 - (For non-standard specifications, refer to *Appendix Specifications* (P. A-2))
- Input resolution: $1/100^\circ\text{C}$
(Pt100: A range of -150.00 to 150.00°C with a resolution of 0.01°C is provided.)
- High-speed sampling is achieved simultaneously with high accuracy and high resolution. This provides high-accuracy, high-speed control to match your application.

● Multi-input Function

- A wide range of temperature inputs and analog inputs is supported.
 - Temperature inputs:
 - Thermocouples: K, J, T, E, L, U, N, R, S, B, W
 - Platinum resistance thermometers: Pt100
 - Analog inputs:
 - Current inputs: 4 to 20 mA or 0 to 20 mA
 - Voltage inputs: 1 to 5 V, 0 to 5 V, or 0 to 10 V

● Multiple Inputs

- The E5AR-T is available with either 2 input or 4 input channels. The E5ER-T comes with 2 inputs.

■ Controller

● Programs

- Up to 32 programs can be created containing set points, times, PID set numbers, alarm set numbers, wait upper/lower limits, segment outputs, program repetitions, and program links. The set point, times, wait function, and segment outputs can be set for each segment. Outputs can be set for each segment or outputs can be set based on the time from the start of the segment.

● PID Sets

- Up to 8 PID sets can be created to store settings (PID constants, MV limits, and automatic selection range upper limits) for PID control.

● A wide Variety of Control Modes and Functions

- PID sets can be selected not only by directly specifying the PID set number in a program, but they can also be selected automatically according to the present value, deviation, or set point.
- Coordinated operation is possible with one Digital Controller for models with 2 or 4 input channels, eliminating the need for slave adjusters.
- Position-proportional Control Models support floating control or closed control. Floating control allows position-proportional control without a potentiometer.

■ Outputs

● Multi-output Function

- Multi-outputs enable using either current outputs or voltage outputs (for driving SSRs).

● High Resolution

- Resolution of Current Outputs
0 to 20 mA: Approx. 54,000
4 to 20 mA: Approx. 43,000

● Control Period

- The control period can be set as short as 0.2 seconds, allowing precise time-proportioning control for voltage outputs (for driving SSRs).

1.2 Part Names and Functions

■ Front Panel

● E5AR-T

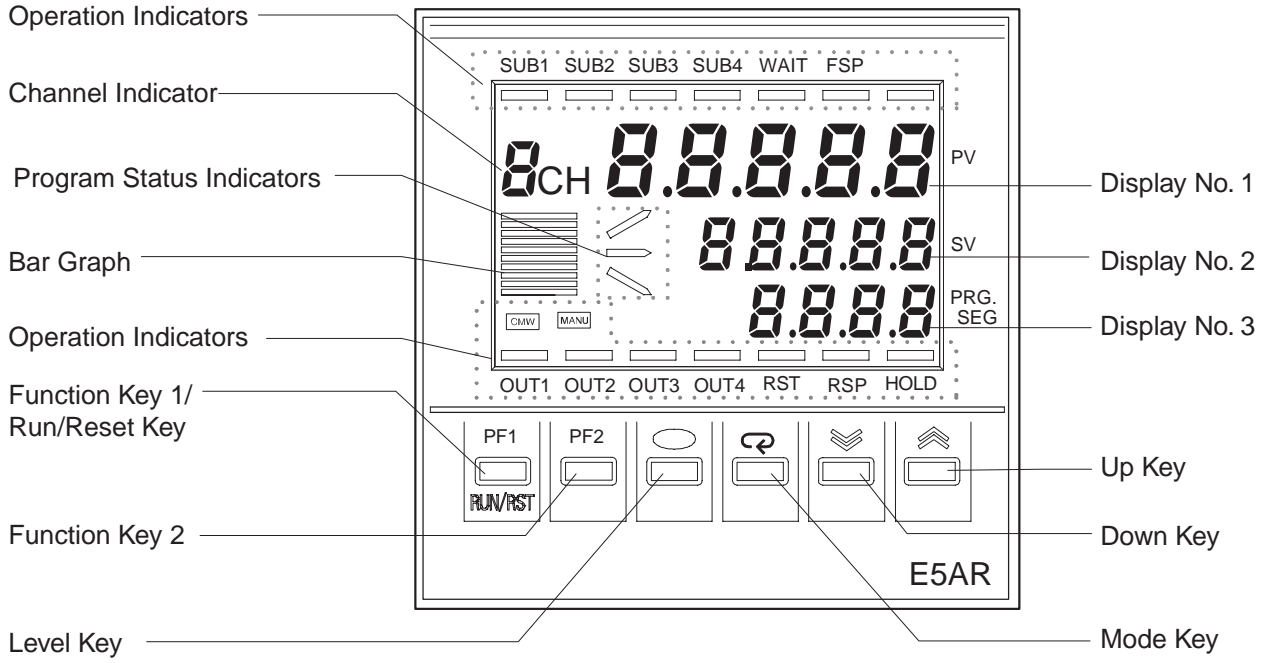

● E5ER-T

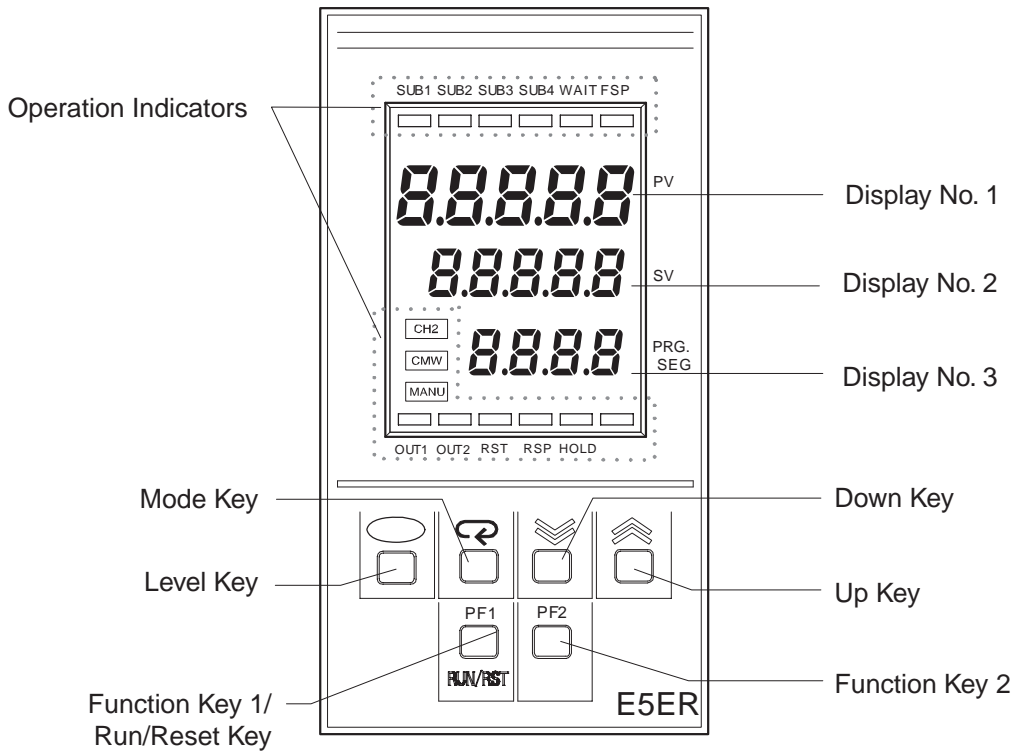

■ Interpreting the Display

- **Display No. 1** Shows the present value, the parameter name, or error name (red).
- **Display No. 2** Shows the set point or the set value of the parameter (green).
- **Display No. 3** Shows the program number, segment number, or the level name (orange).
- **Channel Indicator** Shows the set channel number (orange).

The channel indicator functions only on models with more than one input. It is always OFF on models with only one input.

The E5ER-T indicates the channel using the CH2 operation indicator.
- **Bar Graph** Shows a bar graph of the set item, such as the program time remaining or output level.
- **Program Status Indicators** Shows the direction of change of the present SP of the present segment. The indicators light as follows: Rising segment: top indicator, fixed-temperature segment: middle indicator, and falling segment: bottom indicator.

● Operation Indicators

Operation indicator	Model		Common/Individual channel indicator	Explanation
	E5AR-T	E5ER-T		
OUT1	●	●	Common indicators (orange)	Turns ON/OFF when control output 1 turns ON/OFF. (See note 2.)
OUT2	●	●		Turns ON/OFF when control output 2 turns ON/OFF. (See note 2.)
OUT3	●	–		Turns ON/OFF when control output 3 turns ON/OFF. (See note 2.)
OUT4	●	–		Turns ON/OFF when control output 4 turns ON/OFF. (See note 2.)
SUB1	●	●	Common indicators (red)	Turns ON/OFF when the output function assigned to auxiliary output 1 turns ON/OFF.
SUB2	●	●		Turns ON/OFF when the output function assigned to auxiliary output 2 turns ON/OFF.
SUB3	●	●		Turns ON/OFF when the output function assigned to auxiliary output 3 turns ON/OFF.
SUB4	●	●		Turns ON/OFF when the output function assigned to auxiliary output 4 turns ON/OFF.
RST	●	●	Individual channel indicator (orange)	ON while the program is being reset. Otherwise, OFF.
RSP	●	●	Individual channel indicator (orange)	ON when the SP mode is set to Remote SP Mode. Otherwise, OFF.
HOLD	●	●	Individual channel indicator (orange)	ON while the program is being held. Otherwise, OFF.
WAIT	●	●	Individual channel indicator (red)	ON while the program is waiting. Otherwise, OFF.
FSP	●	●	Individual channel indicator (red)	ON when the SP mode is set to Fixed SP Mode. Otherwise, OFF.
MANU	●	●	Individual channel indicator (orange)	ON when operation is set to Manual Mode. Otherwise, OFF.
CMW	●	●	Common indicator (orange)	Turns ON/OFF when writing via communications is enabled/disabled.
CH2	–	●	Individual channel indicator (orange)	ON when channel 2 is being displayed. Otherwise, OFF.

Note 1. ●: Indicates that the model supports the function. The function, however, may be disabled depending on the settings. An indicator is always OFF for a disabled function.

–: Indicates that the model does not support the function.

2. When the control output is a current output, the indicator turns OFF when the MV is 0% or less and turns ON when the MV is greater than 0%.

■ Using the Keys

Key	Name	Description
	Level Key	Press to change setting levels.
	Mode Key	Press to change the parameter within a setting level. Hold down to change the parameter backward (one change per second).
	Up Key	Each time the Key is pressed, the value of the No. 2 display increases. Hold down the key to increase the value quickly. The key is also used to scroll forward through the setting items.
	Down Key	Each time the Key is pressed, the value of the No. 2 display decreases. Hold down the key to decrease the value quickly. The key is also used to scroll backward through the setting items.
	Protect Key	Press both the and Keys simultaneously to change to the Protect Level. Refer to <i>4.1 Setting Levels and Key Operations</i> (P. 4-2) for details.
	Function Key 1/ Run/Reset Key	When pressed, this function key activates the function set with the PF1 parameter. Example: When the PF1 parameter is set to "RUN/RST," this key functions as an Run/Reset Key that is used to switch between Run Mode and Reset Mode. ("RUN/RST" is the default PF1 setting.) The mode changes from Reset Mode to Run Mode when the key is pressed for at least one second and changes from Run Mode to Reset Mode when the key is press for at least two seconds.
	Function key 2	When pressed, this function key activates the function set with the PF2 parameter. Example: When this key is set as a Channel Key, the channel is switched on models with a multi-channel configuration. The channel switching sequence is as follows: CH1 → CH2 → ... → Highest channel set in the Enabled Channel Setting ↑ _____ ↓

1.3 I/O and Main Functions

I/O Configuration

The I/O configuration of the E5AR-T/ER-T and internal setting items are shown in the following diagram.

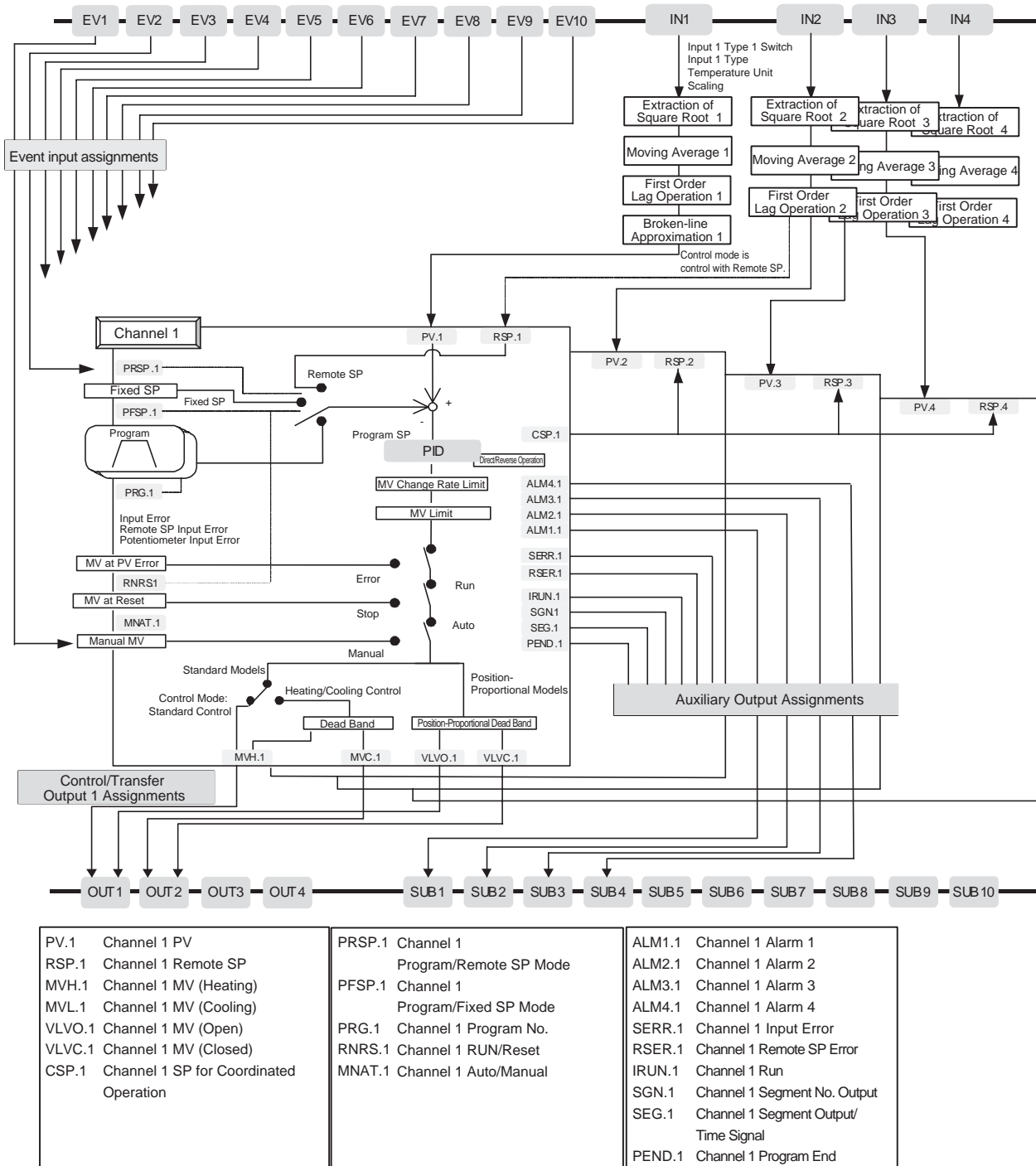

Models with more than one input have the same setting data for channels 2 to 4, depending on the number of input points.

■ Main Functions

● Inputs

First, set the input type switch for each input to specify using either a temperature input (thermocouple (TC) or resistance thermometer (PT)) or an analog input (current input or voltage input), and then set the Input Type parameter.

If the input type switch is set to a temperature input (resistance thermometer or thermocouple), the temperature unit can be set. If the input type switch is set to an analog input (current input or voltage input), scaling and the decimal point position can be set.

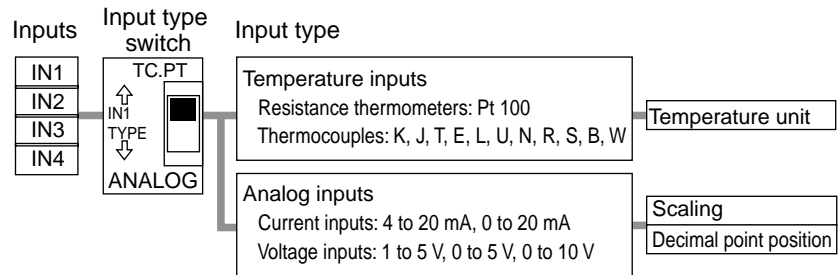

Location of Input Type Switches

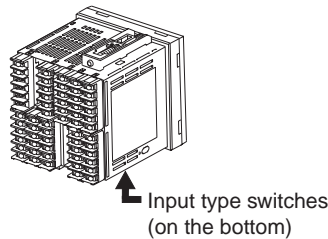

● Event Input Assignments

An operation command can be assigned to each event input. If event inputs are to be used, use an E5AR/ER-□□B/D/M Controller.

For models with more than one input, assignments can be made for channels 2 and higher as needed depending on the number of channels. The Communications Writing OFF/ON operation instruction is common to all channels.

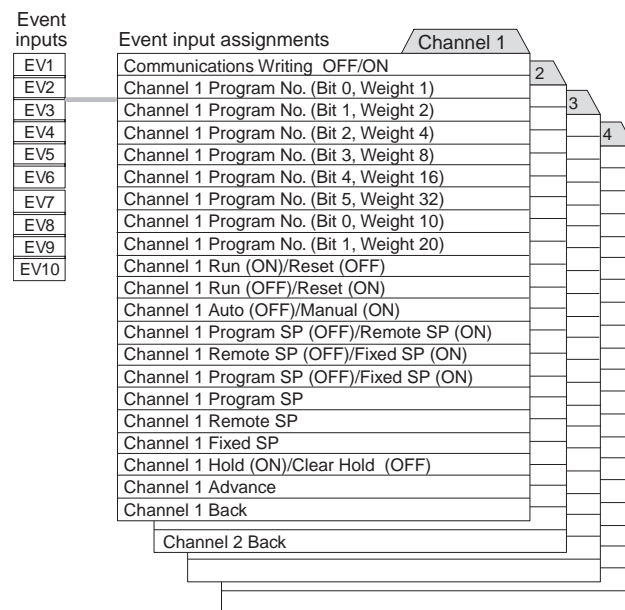

● Control Modes

The type of control performed by each Controller is selected by setting the control mode. Setting the control mode sets default values for the output assignments required for the control.

After setting the control mode, specify direct/reverse operation for each channel.

Standard Models

The control modes that can be selected depend on the number of input points.

Control mode	1-input models	2-input models	4-input models	Out-puts	Control/Transfer output assignment
Standard Control	IN1	IN1	IN1	OUT1	Channel 1 Control Output (Heating)
		IN2	IN2	OUT2	Channel 2 Control Output (Heating)
			IN3	OUT3	Channel 3 Control Output (Heating)
			IN4	OUT4	Channel 4 Control Output (Heating)
Heating/Cooling Control	IN1	IN1	IN1	OUT1	Channel 1 Control Output (Heating)
				OUT2	Channel 1 Control Output (Cooling)
		IN2	IN2	OUT3	Channel 2 Control Output (Heating)
				OUT4	Channel 2 Control Output (Cooling)
Standard Control with Remote SP	–	IN1 IN2: Remote SP	–	OUT1	Channel 1 Control Output (Heating)
Heating/Cooling Control with Remote SP	–	IN1 IN2: Remote SP	–	OUT1 OUT2	Channel 1 Control Output (Heating) Channel 1 Control Output (Cooling)
Proportional Control	–	IN1 IN2: Ratio setting	–	OUT1	Channel 1 Control Output (Heating)
Cascade Standard Control	–	IN1: Primary loop IN2: Secondary loop	–	OUT1	Channel 2 Control Output (Heating)
Cascade Heating/Cooling Control	–	IN1: Primary loop IN2: Secondary loop	–	OUT1 OUT2	Channel 2 Control Output (Heating) Channel 2 Control Output (Cooling)

Direct/Reverse operation	Description
Direct operation (cooling)	Control whereby the MV is increased as the present value increases (When the present value (PV) is higher than the set point (SP), the MV is increased in proportion to the difference between the PV and the SP.)
Reverse operation (heating)	Control whereby the MV is decreased as the present value increases (When the present value (PV) is lower than the set point (SP), the MV is increased in proportion to the difference between the PV and the SP.)

- When pulse outputs are used, the control period must be set for each channel.

Note: "Pulse outputs" indicates relay outputs and voltage outputs (for driving SSRs).

Position-proportional Control Models

Position-proportional Control Models support only standard control.

Control mode	1-input models	2-input models	4-input models	Out-puts	Control/Transfer output assignment
Standard Control	IN1	-	-	OUT1	Channel 1 Control Output (Open)
				OUT2	Channel 2 Control Output (Closed)

Direct/Reverse operation	Description
Direct operation (cooling)	Control whereby the MV is increased as the present value increases (When the present value (PV) is higher than the set point (SP), the MV is increased in proportion to the difference between the PV and the SP.)
Reverse operation (heating)	Control whereby the MV is decreased as the present value increases (When the present value (PV) is lower than the set point (SP), the MV is increased in proportion to the difference between the PV and the SP.)

- Floating control or closed control can also be selected for the Position-proportional Control Models. Floating control enables position-proportional control without a feedback potentiometer.

● Control/Transfer Output Assignments

Parameters can be used to assign the type of data that is output from each output. For the models with more than one input, assignments can be made for channels 2 and higher as needed depending on the number of channels.

Outputs	Control/Transfer Output Assignments	Channel 1
OUT1	Channel 1 control output (heating or open) for control output	
OUT2	Channel 1 control output (cooling or close) for control output	
OUT3	Channel 1 present set point	
OUT4	Channel 1 PV	
	Channel 1 control output (heating or open) for transfer output	
	Channel 1 control output (cooling or close) for transfer output	
	Channel 1 valve opening	

When control outputs are used, assignments are made automatically based on the control mode that is set, as explained on the previous page. No changes are necessary.

When an output is used as a transfer output, assign the data to be transferred to an unused output.

For outputs with multi-output functionality, specify a voltage output (for driving SSR) or a linear current output using the multi-output output type setting.

For linear current outputs, 0 to 20 mA or 4 to 20 mA can be selected. Voltage outputs (for driving SSRs) are 12 VDC, 40 mA.

Outputs

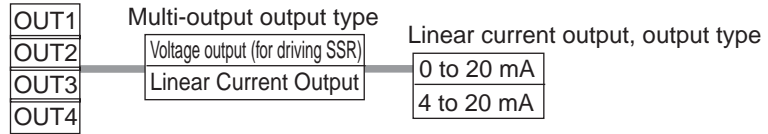

● Auxiliary Output Assignments

The type of data that is output from each auxiliary output can be assigned.

For models with more than one input, assignments can be made for channels 2 and higher as needed depending on the number of channels.

The U-ALM output is an OR output of alarm functions 1 to 4 for all channels.

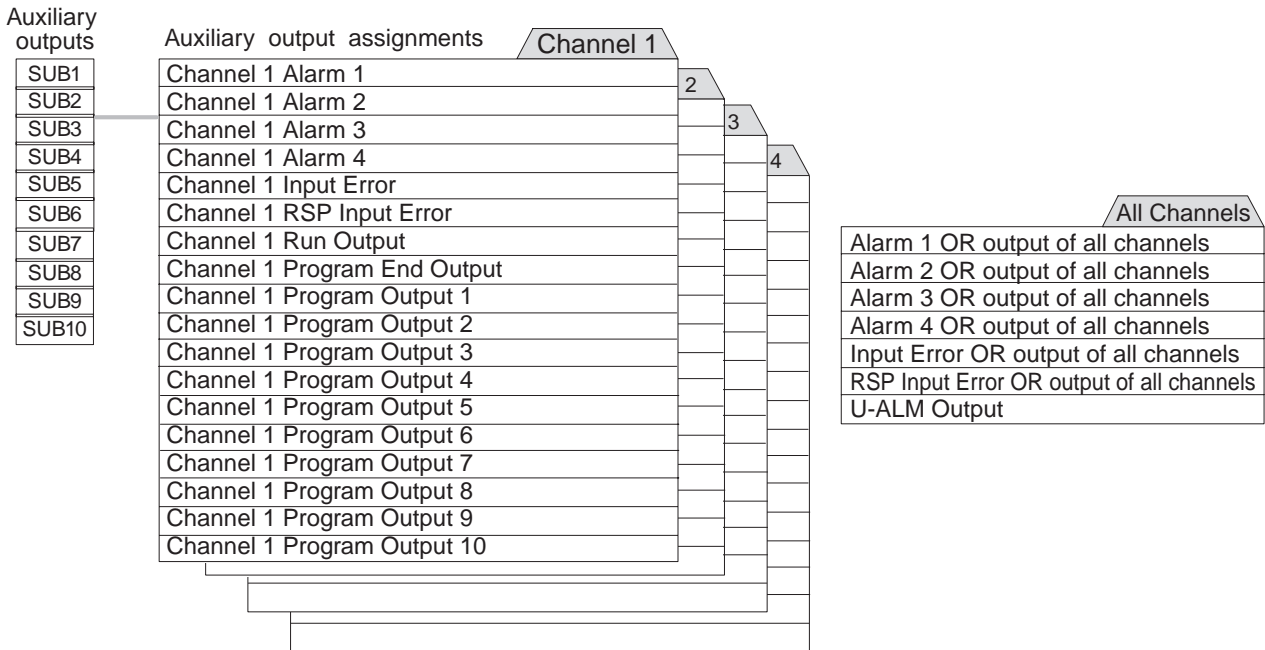

■ Model Number Structure

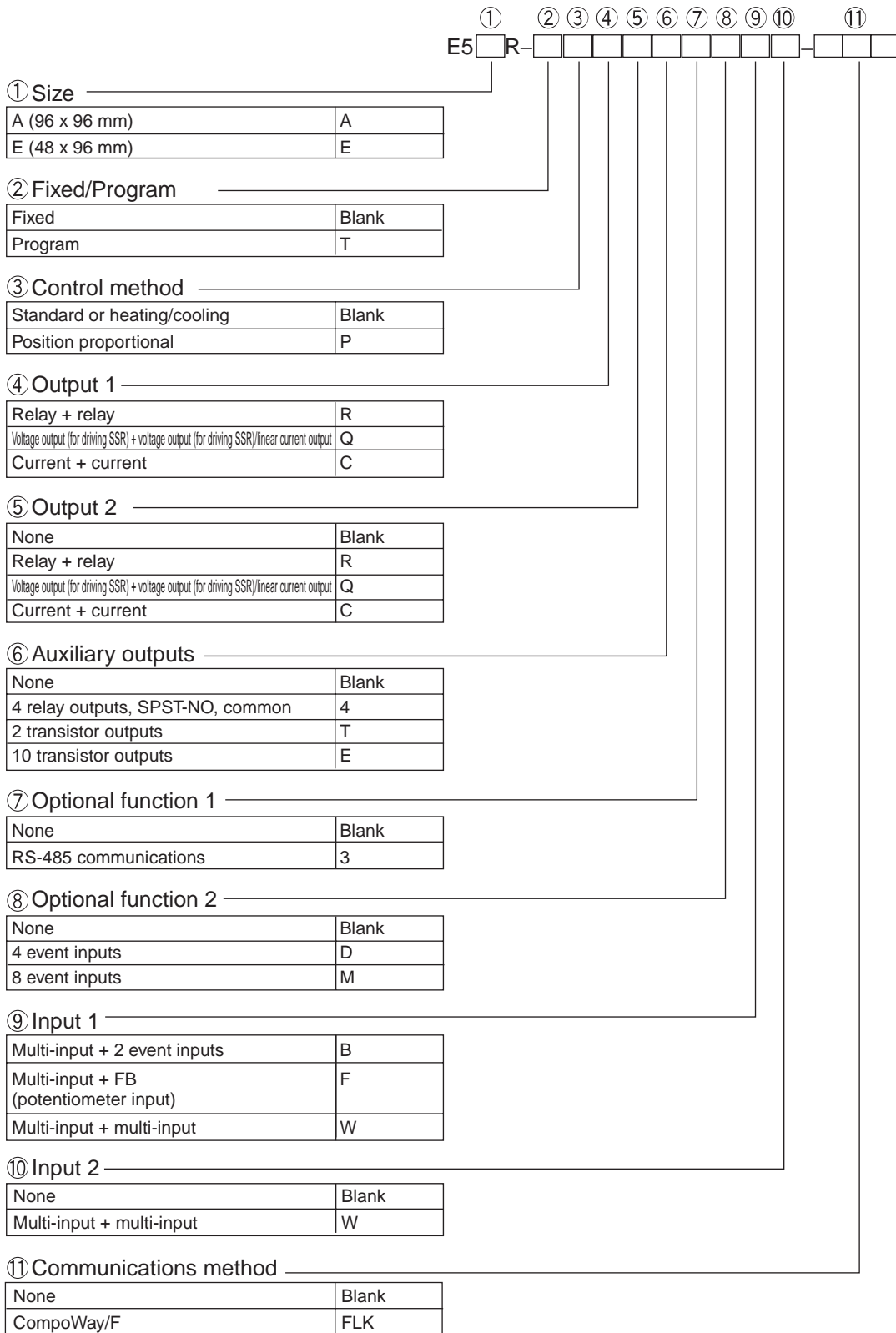

The above information on the model number structure is based on functionality. Models may not actually be available for all possible combinations of features. Please check the catalog for availability before ordering.

Section 2 Preparations

2.1	Installation	2-2
2.2	Using the Terminals	2-4

2.1 Installation

■ Dimensions

● E5AR-T

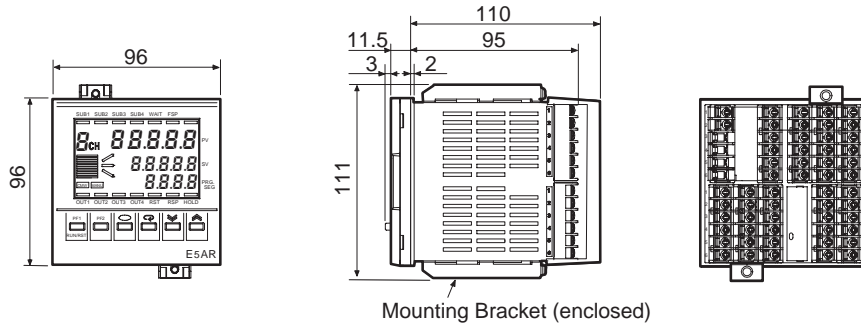

● E5ER-T

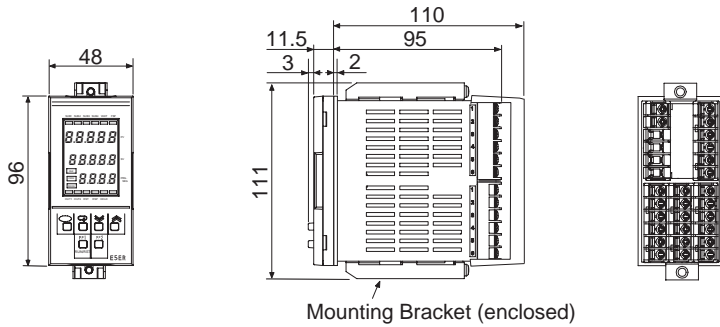

■ Installation

● Panel Cutout Dimensions

E5AR-T

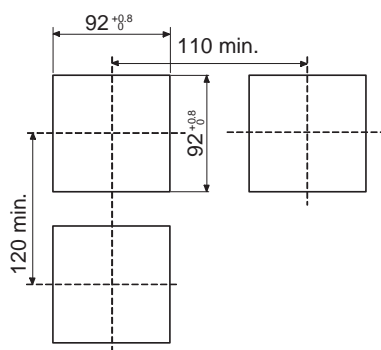

E5ER-T

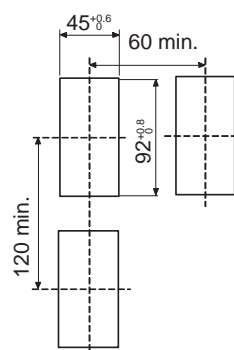

● Installation Procedure

- ① If the front of the Controller needs to be watertight, attach the enclosed watertight packing. If the front of the Controller does not need to be watertight, the watertight packing does not need to be attached.
- ② Insert the Controller into the cutout in the panel.
- ③ Insert the enclosed fittings into the grooves on the top and bottom of the rear case.

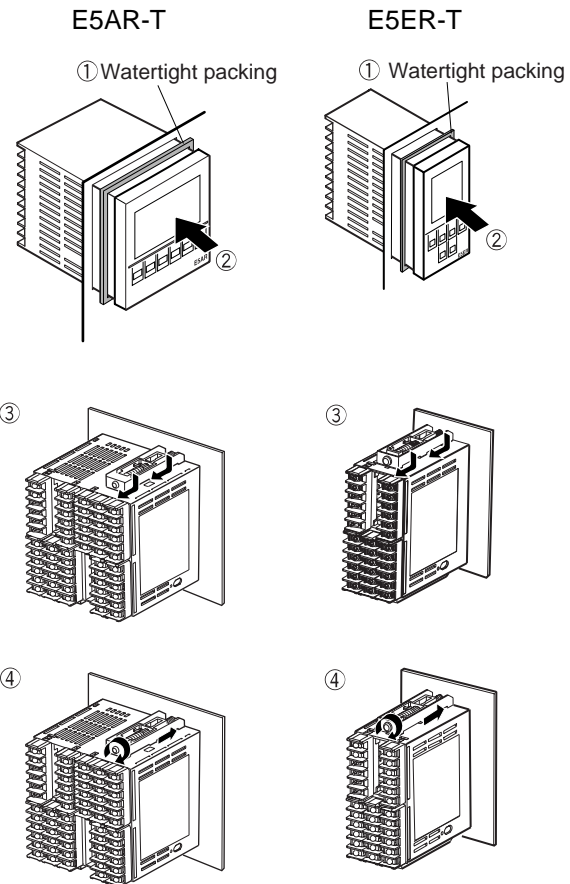

- ④ Gradually tighten the screws in the top and bottom fittings, alternating between them so that they are balanced. Tighten the screws until the ratchet turns freely (i.e., until the screws are no longer engaged).

● Pulling Out the Controller

Normally there is no need to pull out the Controller. However, it can be pulled out if needed for maintenance purposes.

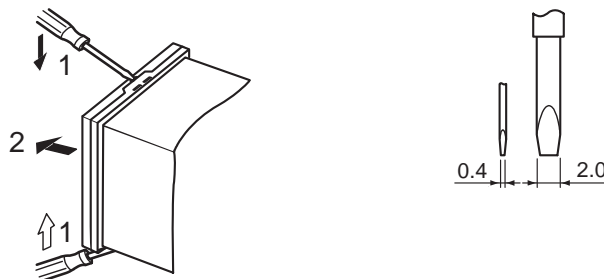

When pulling out the Controller, place a cloth over the screwdriver to prevent scratches and other damage.

2.2 Using the Terminals

Verify the layout of the terminals (labeled beginning from A and from 1) using the markings on the top and sides of the case.

Terminal Arrangements

● E5AR-T

E5AR-TQ4B

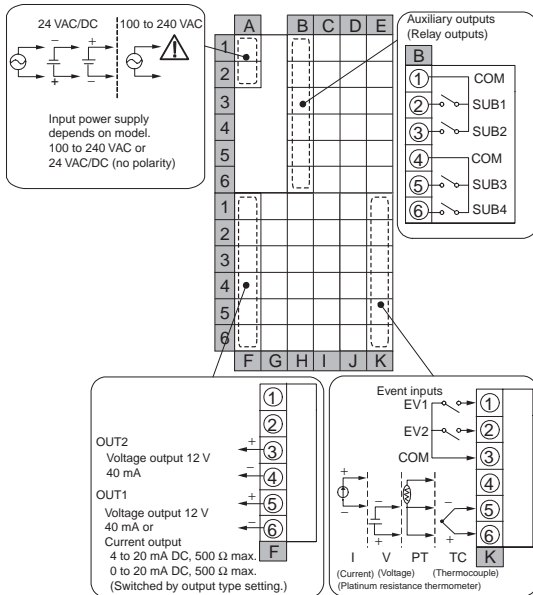

E5AR-TC4B

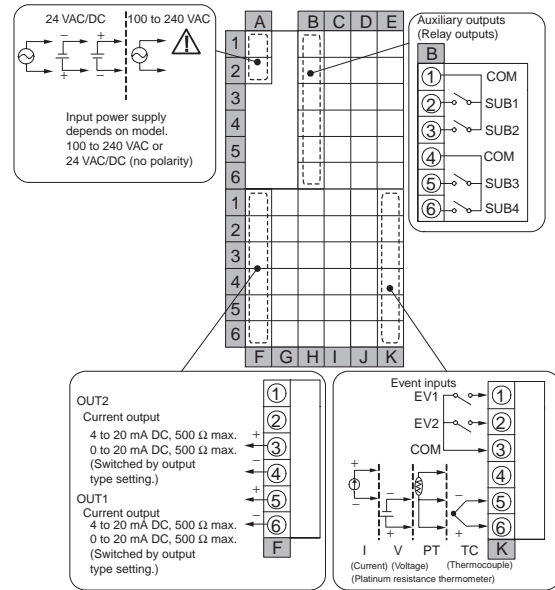

E5AR-TQ43B-FLK

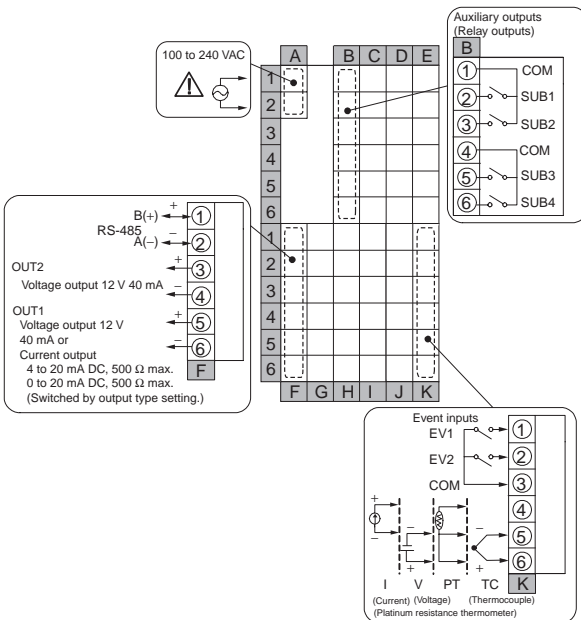

E5AR-TC43B-FLK

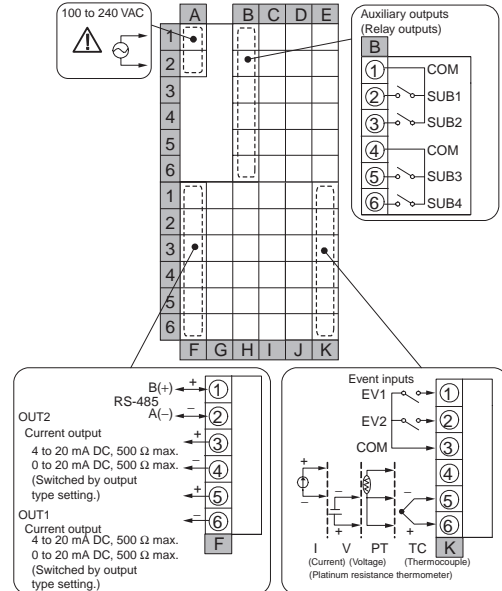

Note: With the E5AR-T, the power supply voltage must be 100 to 120 V for UL compliance. With the E5AR-T, the power supply voltage must be 100 to 240 V for CE marking compliance.

E5AR-TQE3MB-FLK

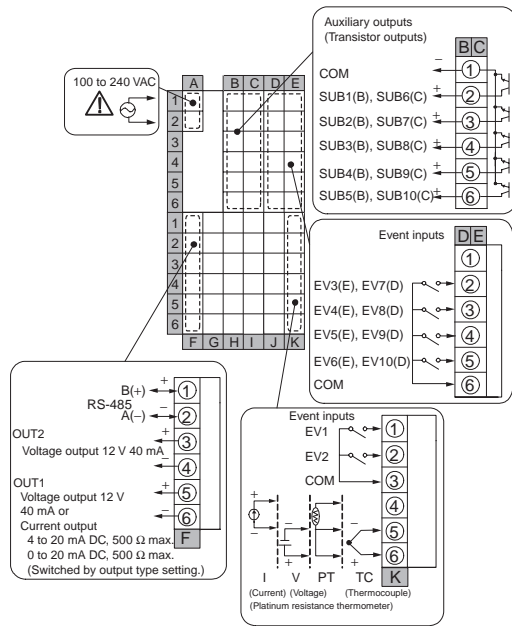

E5AR-TCE3MB-FLK

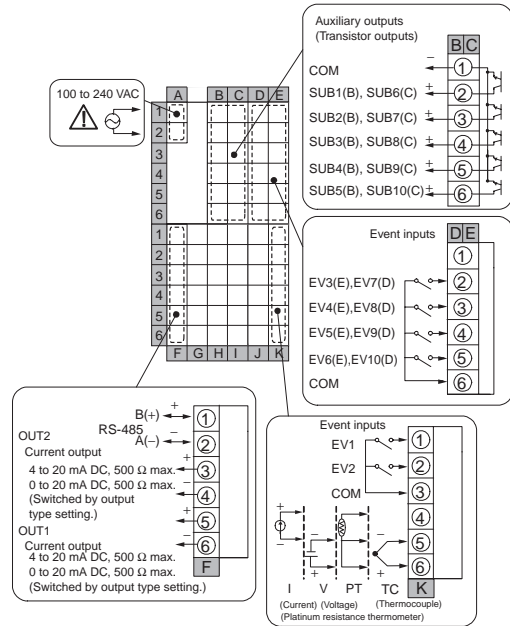

E5AR-TQCE3MB-FLK

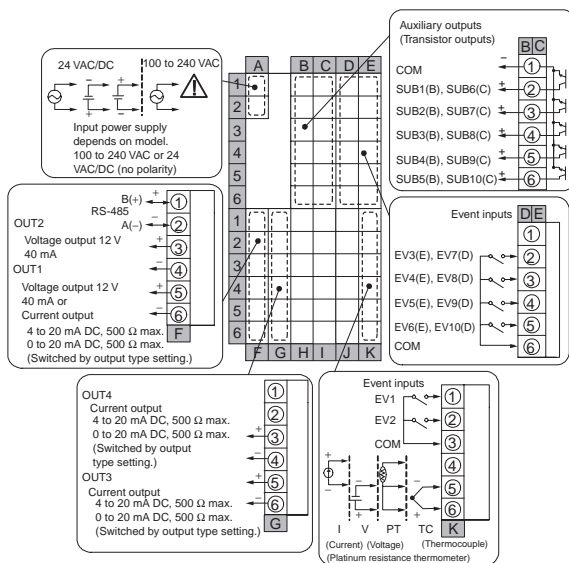

E5AR-TQ43DW-FLK (2-loop Controller)

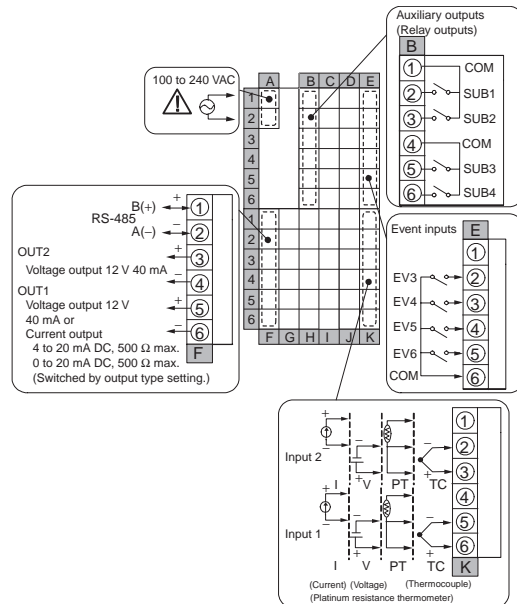

Note: With the E5AR-T, the power supply voltage must be 100 to 120 V for UL compliance. With the E5AR-T, the power supply voltage must be 100 to 240 V for CE marking compliance.

E5AR-TC43DW-FLK (2-loop Controller)

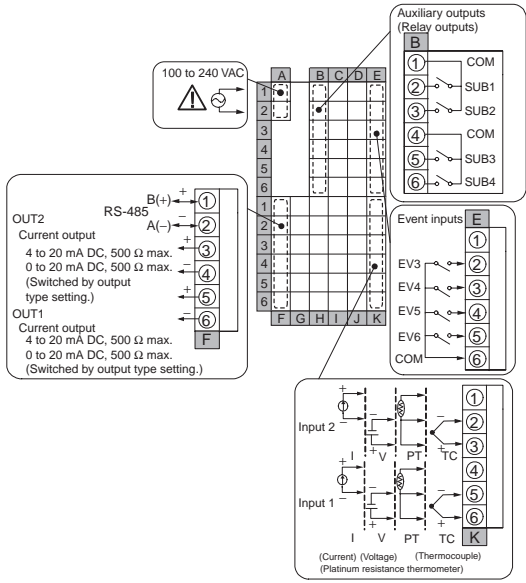

E5AR-TQQE3MW-FLK (2-loop Controller)

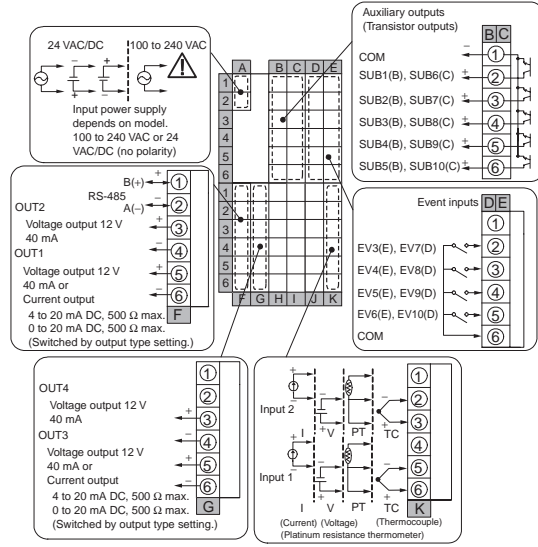

E5AR-TCCE3MWW-FLK (4-loop Controller)

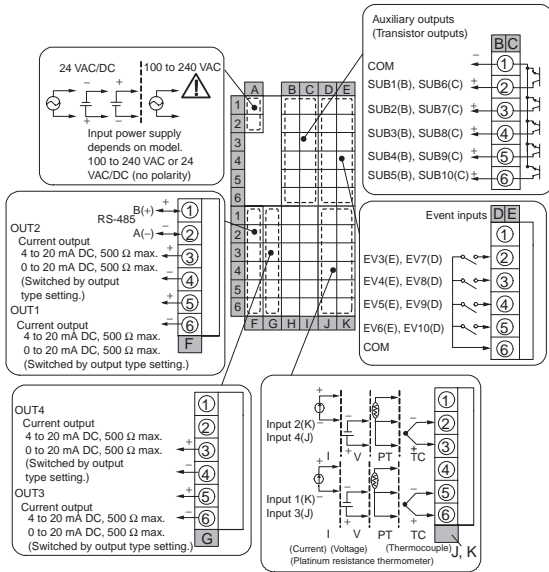

E5AR-TQQE3MWW-FLK (4-loop Controller)

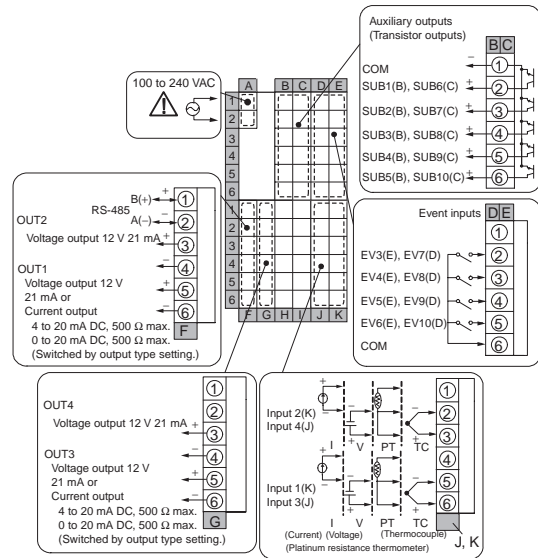

Note: With the E5AR-T, the power supply voltage must be 100 to 120 V for UL compliance. With the E5AR-T, the power supply voltage must be 100 to 240 V for CE marking compliance.

E5AR-TPR4DF

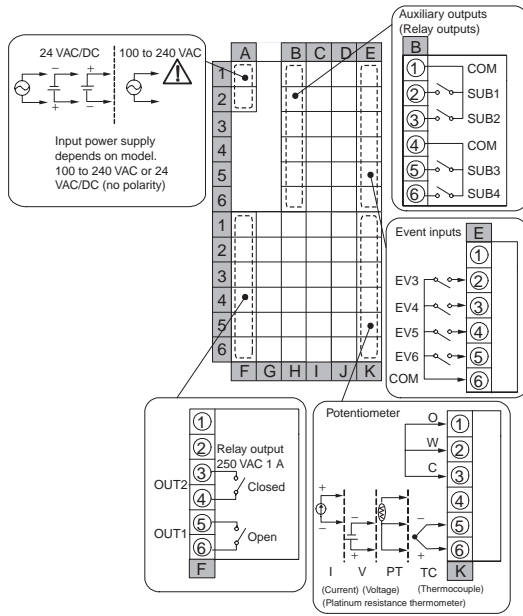

E5AR-TPRQE3MF-FLK

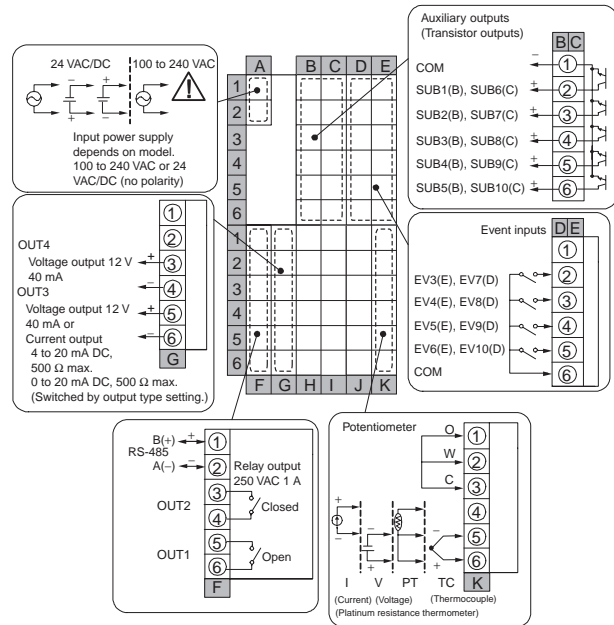

Note: With the E5AR-T, the power supply voltage must be 100 to 120 V for UL compliance. With the E5AR-T, the power supply voltage must be 100 to 240 V for CE marking compliance.

● E5ER-T

E5ER-TQ4B

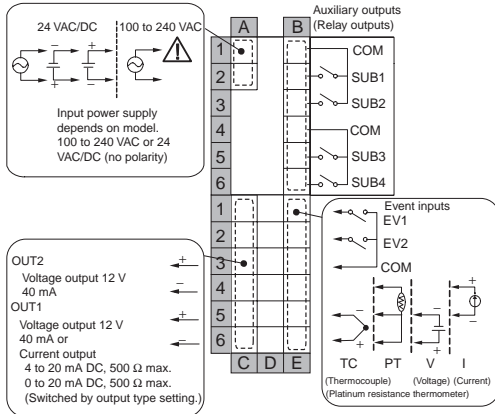

E5ER-TC4B

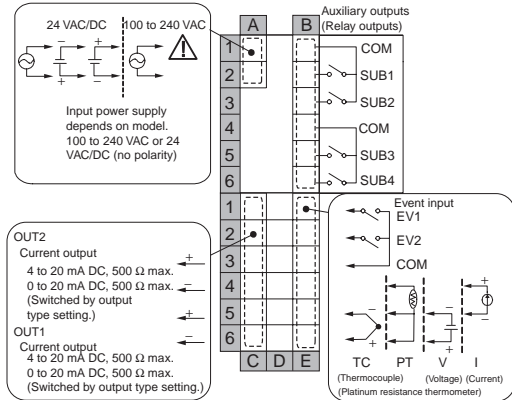

E5ER-TQC43B-FLK

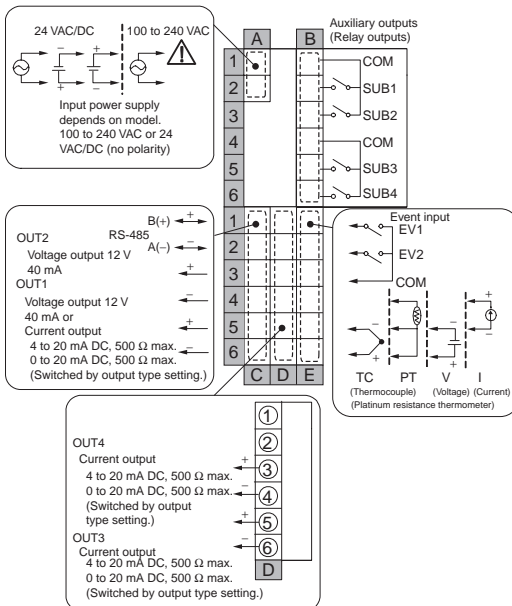

E5ER-TQT3DW-FLK (2-loop Controller)

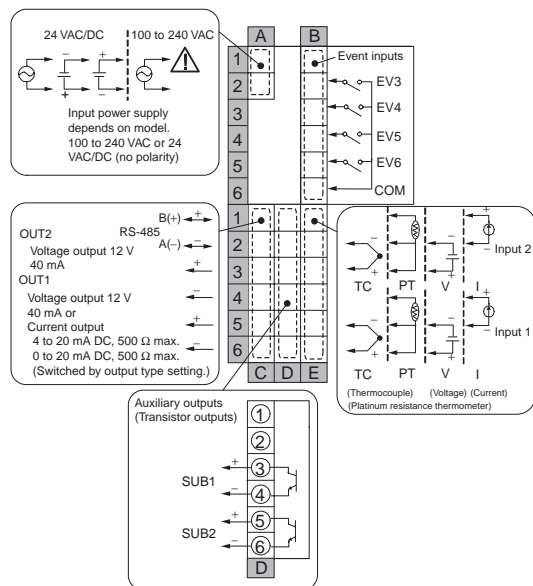

Note: With the E5AR-T, the power supply voltage must be 100 to 120 V for UL compliance. With the E5ER-T, the power supply voltage must be 100 to 240 V for CE marking compliance.

E5ER-TCT3DW-FLK (2-loop Controller)

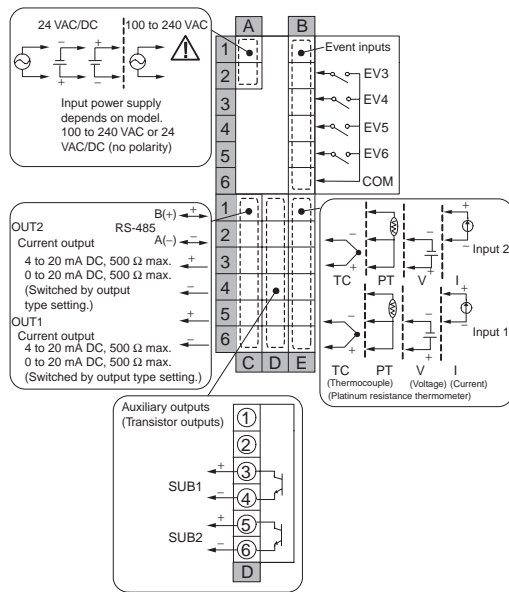

E5ER-TPRTDF

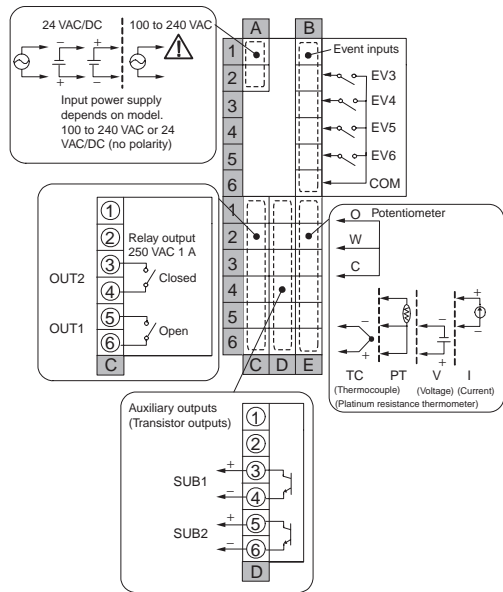

E5ER-TPRQ43F-FLK

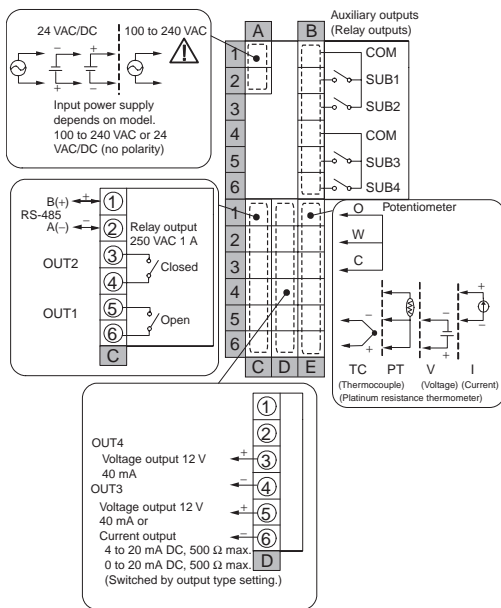

Note: With the E5AR-T, the power supply voltage must be 100 to 120 V for UL compliance. With the E5ER-T, the power supply voltage must be 100 to 240 V for CE marking compliance.

■ Precautions when Wiring



- To avoid the effects of noise, wire the signal wires and the power line separately.
- Use crimp terminals to connect to the terminals.
- Tighten screws to a torque of 0.40 to 0.56 N·m.
- Use M3 crimp terminals with one of the shapes shown at the left.

■ Wiring

● Power Supply (Terminals)

E5AR-T

	A	B	C	D	E	
1						1
2						2
3						3
4						4
5						5
6						6
1						1
2						2
3						3
4						4
5						5
6						6
	F	G	H	I	J	K

E5ER-T

	A	B	
1			1
2			2
3			3
4			4
5			5
6			6
1			1
2			2
3			3
4			4
5			5
6			6
	C	D	E

The area inside the lines around terminal numbers in the diagram represents the interior of the Controller, and the area outside the lines represent the exterior.

- Connect terminals A1 and A2 as follows:

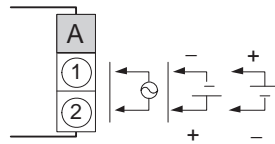

The input power supply depends on the model.
100 to 240 VAC or 24 VAC/VDC (no polarity)

Input voltage	E5AR-T	E5ER-T
100 to 240 VAC, 50/60 Hz	22 VA	17 VA
100 to 120 VAC, 50/60 Hz (for UL certification)		
100 to 240 VAC, 50/60 Hz (for CE marking)		
24 VAC, 50/60 Hz	15 VA	11 VA
24 VDC (no polarity)	10 W	7 W

● Inputs (Terminals)

E5AR-T

	A	B	C	D	E	
1						1
2						2
3						3
4						4
5						5
6						6
1						1
2						2
3						3
4						4
5						5
6						6
	F	G	H	I	J	K

1						1
2						2
3						3
4						4
5						5
6						6
1						1
2						2
3						3
4						4
5						5
6						6
	F	G	H	I	J	K

E5ER-T

	A	B	
1			1
2			2
3			3
4			4
5			5
6			6
1			1
2			2
3			3
4			4
5			5
6			6
	C	D	E

- For input 1 (IN1), connect terminals K4 to K6 on the E5AR-T, or E4 to E6 on the E5ER-T according to the input type, as shown below.
- For a Controller with more than one input, connect inputs 2 to 4 (IN2 to IN4) in the same way according to the number of input points.

E5AR-T

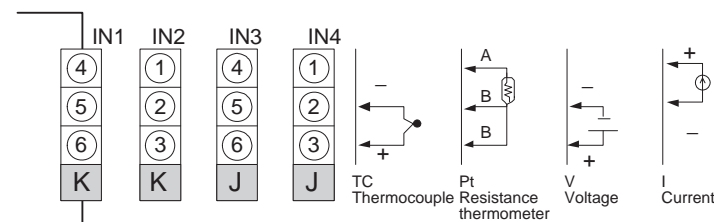

E5ER-T

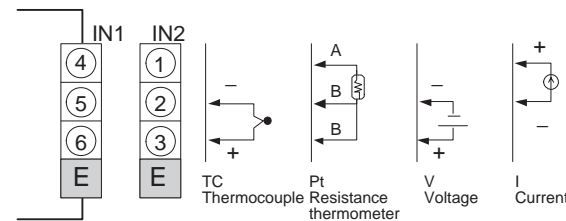

To prevent the appearance of error displays due to unused inputs, set the Number of Enabled Channels parameter.

● Control/Transfer Outputs (Terminals)

E5AR-T

	A		B	C	D	E	
1							1
2							2
3							3
4							4
5							5
6							6
1							1
2							2
3							3
4	OUT2	OUT4					4
5	OUT1	OUT3					5
6	F	G	H	I	J	K	6

E5ER-T

	A		B	
1				1
2				2
3				3
4				4
5				5
6				6
1				1
2				2
3				3
4	OUT2	OUT4		4
5	OUT1	OUT3		5
6	C	D	E	6

- On the E5AR-T, control output 1 (OUT1) outputs to terminals F5 and F6, and control output 2 (OUT2) outputs to terminals F3 and F4.
- On the E5ER-T, control output 1 (OUT1) outputs to terminals C5 and C6, and control output 2 (OUT2) outputs to terminals C3 and C4.
- On a Controller with more than one input, output takes place from control output 3 (OUT3) and control output 4 (OUT4).

E5AR-T

Voltage output (for driving SSR)

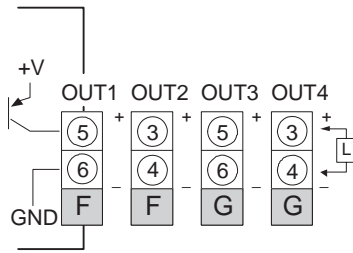

Linear current output

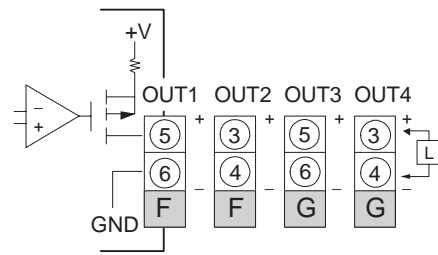

E5ER-T

Voltage output (for driving SSR)

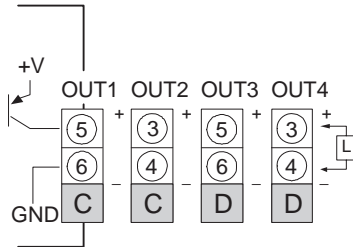

Linear current output

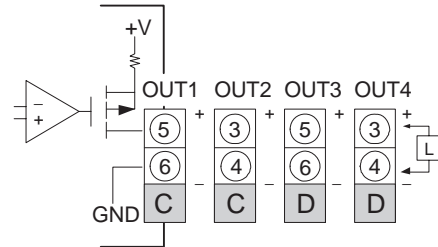

- If terminals 5 and 6 are used for a voltage output (for driving SSR), approximately 2 V are output when the power is turned ON (load resistance: 10 kΩ max. for 10 ms).
- If a linear current output is used, approximately 2 mA are output for 1 second when the power is turned ON.
- Control outputs that are not used for control can be used for transfer outputs by setting the Control/Transfer Output Assignment parameters.
- Specifications for each output type are as follows:

Output type	Specifications
Voltage Output (for driving SSR)	Output voltage: 12 VDC+15%, -20%(PNP) Max. load current: 40 mA*, with short-circuit protection circuit
Linear Current Output	0 to 20 mA DC (resolution: approx. 54,000) 4 to 20 mA DC (resolution: approx. 43,000) Load: 500 Ω max.

* The value for the E5AR-TQQ□□□WW-□□□ is 21 mA max.

- A Position-proportional Control Model has relay outputs (250 VAC, 1 A). Control output 1 (OUT1) is an open output and control output 2 (OUT2) is a closed output.

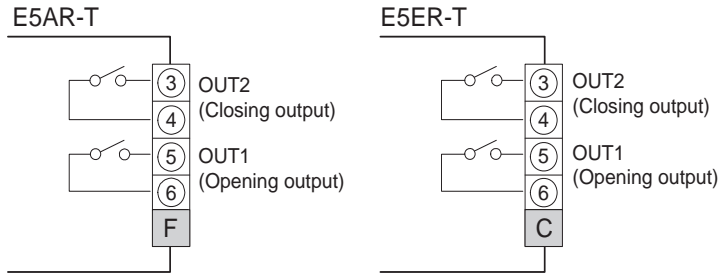

- Relay output specifications are as follows:
250 VAC, 1 A (including inrush current)
- On the E5AR-T□4□□, auxiliary outputs 1 to 4 (SUB1 to SUB4) output to terminals B1 to B6.

● Auxiliary Outputs (Terminals)

E5AR-T□4□□

	A	B	C	D	E	
1		COM				1
2		SUB1				2
3		SUB2				3
4		COM				4
5		SUB3				5
6		SUB4				6
1						1
2						2
3						3
4						4
5						5
6						6
	F	G	H	I	J	K

E5AR-T□4□□

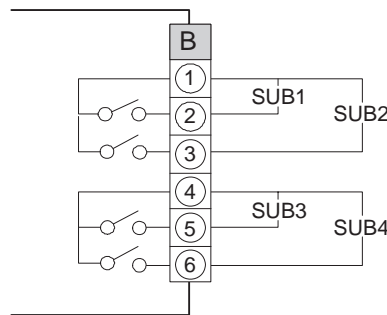

- Relay output specifications are as follows:
250 VAC, 1 A (including inrush current)
- On the E5AR-T□E□□, auxiliary outputs 1 to 5 (SUB1 to SUB5) output to terminals B1 to B6, and auxiliary outputs 6 to 10 (SUB6 to SUB10) output to terminals C1 to C6.

E5AR-T□E□□

	A	B	C	D	E	
1		COM	COM			1
2		SUB1	SUB6			2
3		SUB2	SUB7			3
4		SUB3	SUB8			4
5		SUB4	SUB9			5
6		SUB5	SUB10			6
1						1
2						2
3						3
4						4
5						5
6						6
	F	G	H	I	J	K

E5AR-T□E□□

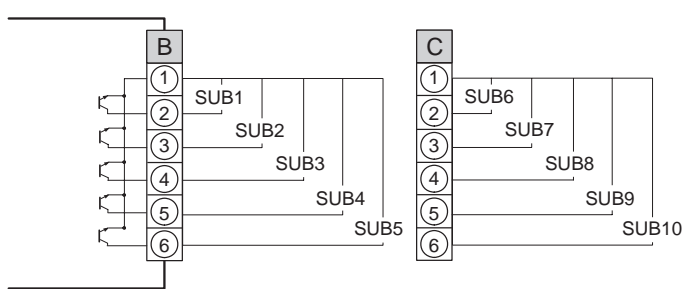

E5ER-T

	A	B	
1		COM	1
2		SUB1	2
3		SUB2	3
4		COM	4
5		SUB3	5
6		SUB4	6
1			1
2			2
3			3
4		SUB1	4
5		SUB2	5
6			6
	C	D	E

- Transistor output specifications are as follows:
Maximum load voltage: 30 VDC
Maximum load current: 50 mA
Residual voltage: 1.5 V max.
Leakage current: 0.4 mA max.

- On the E5ER-T□4□□, auxiliary outputs 1 to 4 (SUB1 to SUB4) output to terminals B1 to B6.

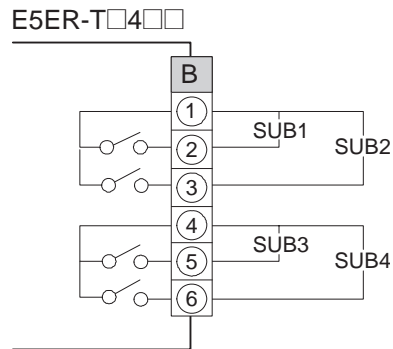

- Relay output specifications are as follows:
250 VAC 1 A
- On the E5ER-T□T□□ auxiliary outputs 1 and 2 (SUB1 and SUB2) output to terminals D3 to D6.

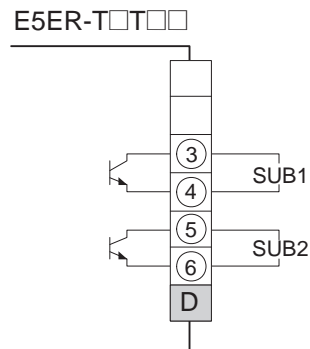

- Transistor output specifications are as follows:
Maximum load voltage: 30 VDC
Maximum load current: 50 mA
Residual voltage: 1.5 V max.
Leakage current: 0.4 mA max.

● Potentiometer Inputs (Terminals)

E5AR-T

	A	B	C	D	E	
1						1
2						2
3						3
4						4
5						5
6						6
1						1
2					PMTR	2
3						3
4						4
5						5
6						6
F	G	H	I	J	K	

E5ER-T

	A	B	
1			1
2			2
3			3
4			4
5			5
6			6
1			1
2			2
3		PMTR	3
4			4
5			5
6			6
C	D	E	

- To use a Position-proportional Control Model to monitor the amount of valve opening or perform closed control, connect a potentiometer (PMTR) as shown in the following diagram.

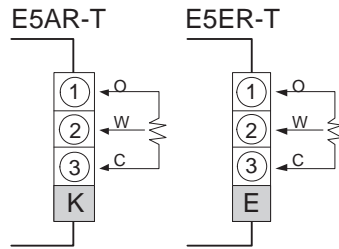

- For information on the potentiometer, refer to the manual for the valve you are connecting. Terminal numbers are as follows:
O: Open, W: Wipe, C: Close
The input range is 100 Ω to 2.5 kΩ (between C and O).

● Event Inputs (Terminals)

E5AR-T

	A	B	C	D	E	
1						1
2				EV7	EV3	2
3				EV8	EV4	3
4				EV9	EV5	4
5				EV10	EV6	5
6				COM	COM	6
1					EV1	1
2					EV2	2
3					COM	3
4						4
5						5
6						6
F	G	H	I	J	K	

E5ER-T

	A	B	
1			1
2		EV3	2
3		EV4	3
4		EV5	4
5		EV6	5
6		COM	6
1		EV1	1
2		EV2	2
3		COM	3
4			4
5			5
6			6
C	D	E	

- To use event inputs on the E5AR-T, connect event inputs 1 and 2 (EV1 and EV2) to terminals K1 to K3, event inputs 3 to 6 (EV3 to EV6) to terminals numbers E2 to E6 event inputs 7 to 10 (EV7 to EV10) to terminals numbers D2 to D6. The number of event inputs depends on the model.
- To use event inputs on the E5ER-T, connect event inputs 1 and 2 (EV1 and EV2) to terminals E1 to E3 and event inputs 3 to 6 (EV3 to EV6) to terminals numbers B2 to B6. The number of event input points depends on the model.

- The number of input points for each model is as follows:
 E5AR-T□□□B, E5ER-T□□□B: 2 points, EV1 and EV2
 E5AR-T□□□D, E5ER-T□□□D: 4 points, EV3 to EV6
 E5AR-T□□□M: 8 points, EV3 to EV10
 E5AR-T□□□MB: 10 points, EV1 to EV10

E5AR-T

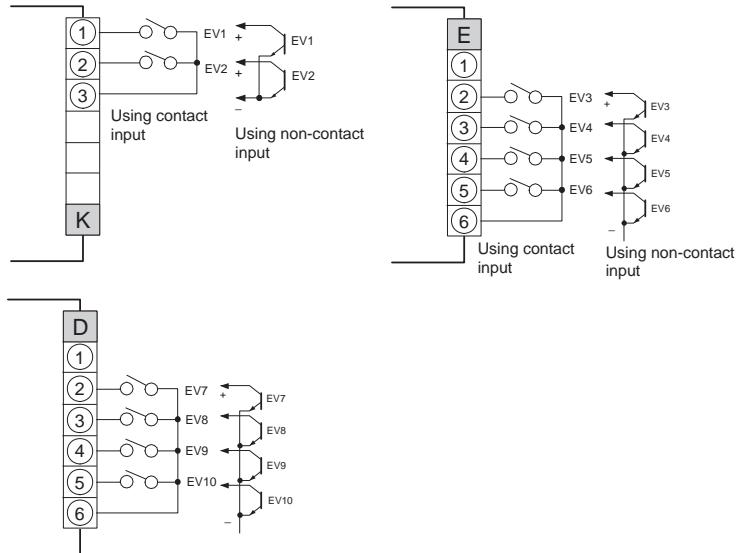

E5ER-T

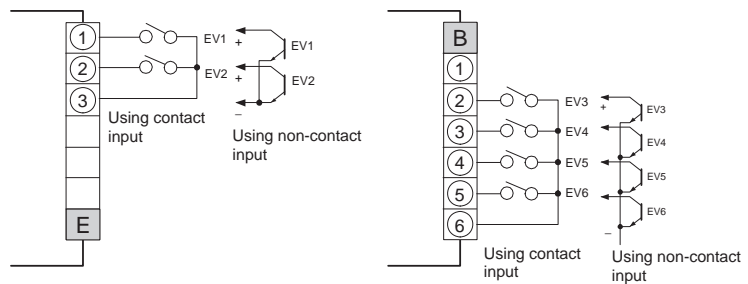

- The input ratings of each input are as follows:

Contact	ON: 1 kΩ max., OFF: 100 kΩ or higher
Non-contact	ON: residual voltage of 1.5 V max., OFF: leakage current of 0.1 mA max.

Circuit Diagram

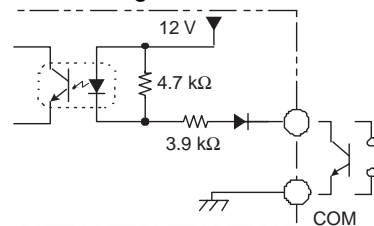

● Communications (Terminals)

E5AR-T

	A	B	C	D	E	
1						1
2						2
3						3
4						4
5						5
6						6
1	RS485					1
2						2
3						3
4						4
5						5
6						6
	F	G	H	I	J	K

E5ER-T

	A	B	
1			1
2			2
3			3
4			4
5			5
6			6
1	RS485		1
2			2
3			3
4			4
5			5
6			6
	C	D	E

- To communicate with a host system, connect the communications line between terminals F1 and F2 on the E5AR-T, or between C1 and C2 on the E5ER-T.

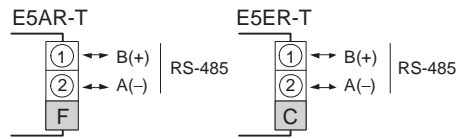

- The connection type is 1:1 or 1:N. With a 1:N installation, up to 32 Controllers, including the host computer, can be connected.
- The maximum total cable length is 500 m.
- Use a shielded twisted-pair cable (AWG28 min.).

Cable Reference Diagram

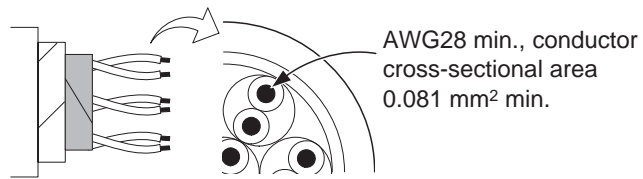

- Use a resistance of 100 to 125 Ω (1/2 W) for the terminators. Install terminators at both ends of the transmission path, including the host computer.
- To connect to an RS-232C port on a computer, use an RS-232C-485 converter.
Example converter: K3SC RS-232C/RS-485 Interface Converter

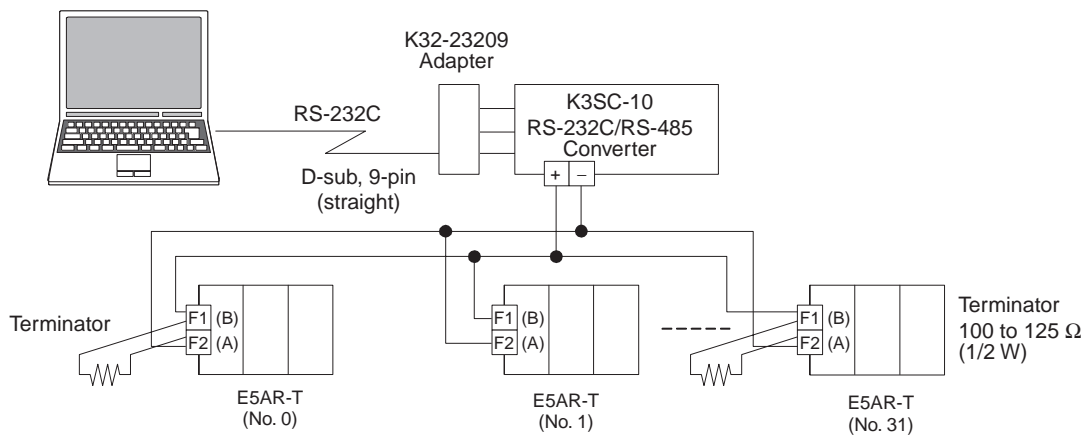

Insulation Blocks As shown in the following diagram, the function blocks of the E5AR-T/ER-T are electrically insulated.

Functional insulation is provided between all of the following: <Inputs>, <event inputs/voltage outputs/current outputs>, and <communications>.

Basic insulation is provided between all of the following: <Inputs/event inputs/voltage outputs/current outputs/communications>, <relay outputs>, and <transistor outputs>.

If reinforced insulation is required, input, event input, voltage output, current output, and communications terminals must be connected to a device that have no exposed charged parts and whose basic insulation is suitable for the applicable maximum voltage of connected devices.

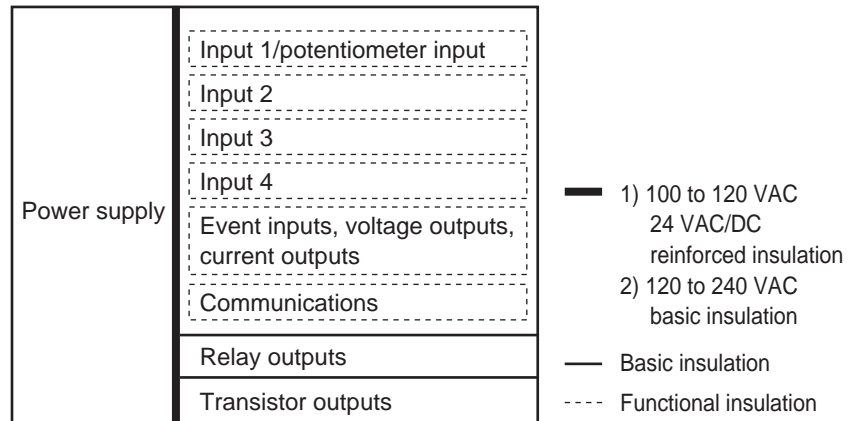

Section 3 *Typical Control Examples*

3.1	Standard Control	3-2
3.2	Coordinated Electric Oven Operation	3-7

3.1 Standard Control

This section introduces an example of program control of an electric oven as a basic control example.

Application

● Connection Configuration

The following connections are used to control an electric oven using the E5AR-T. Here, the E5AR-TQ4B is used.

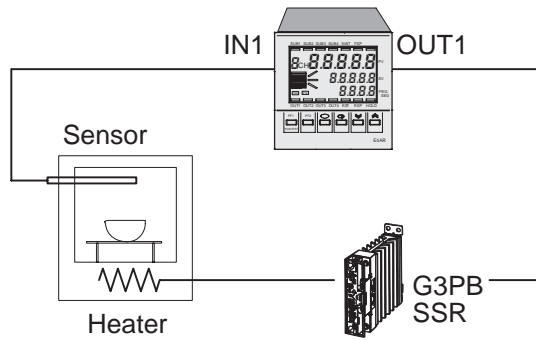

● Programmed Operation Example

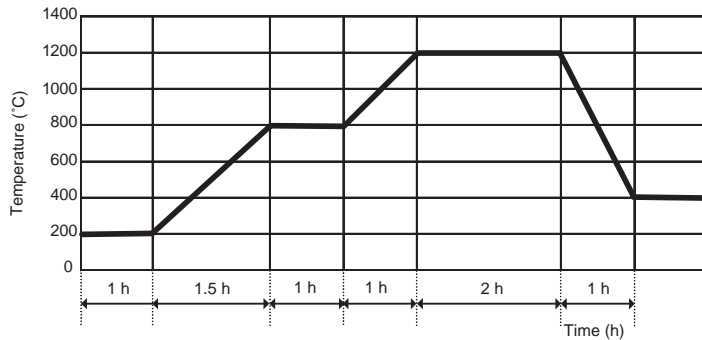

■ Wiring

A type-R thermocouple is connected to the IN1 terminal, and an SSR is connected to the OUT1 terminal. The wiring for the E5AR-TQ4B is shown in the following diagram.

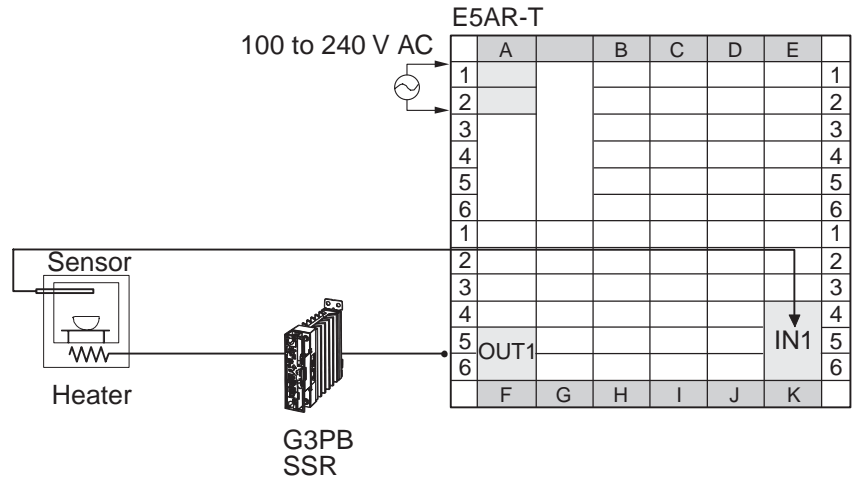

Typical Control Examples

■ Settings

Set the parameters as follows:

Parameter	Setting
Input 1 type switch	TC. PT (default)
Input 1 Input Type	11 (R 0.0 to 1700.0°C)
Output 1 Type	0 (Voltage Output (for driving SSR) (default))
Control Mode	0 (Standard Control (default))
Direct/Reverse Operation	Reverse (Reverse Operation (default))
PV Start	SP (SP Start (default))
End Condition	Continue (Continue (default))
Control Period (Heating)	2.0

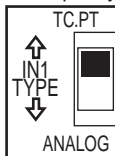

● Setting Procedure

Input 1 Input Type Switch

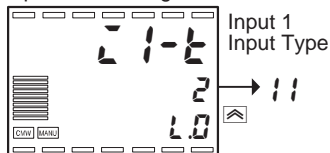

Input Initial Setting Level



1. Before turning ON the power, be sure that the input 1 type switch is set to TC. PT.
2. Turn ON the power and then hold down the  Key for at least 3 seconds to move from the Operation Level to the Input Initial Setting Level.  (Input 1 Input Type) will be displayed. Press the  Key to select the setting 11 (R 0.0 to 1700.0°C).

Control Initial Setting Level

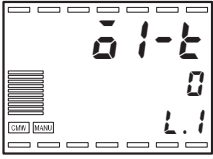

Output 1 Type

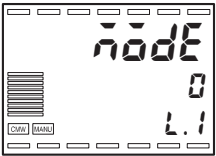

Control Mode

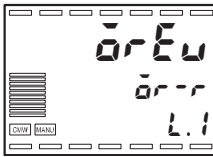

Direct/Reverse Operation

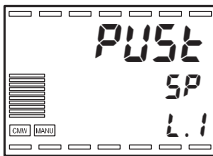

PV Start

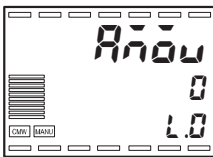

Move to Advanced Function Setting Level
-169

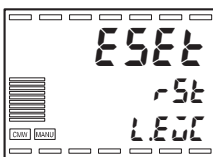
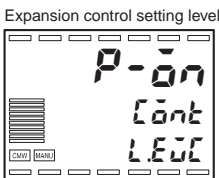

End Condition

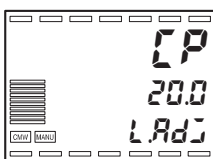
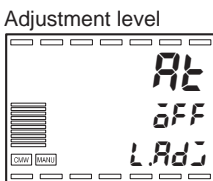

Control Period (Heating)

3. Press the Key for less than 1 second to move from the Input Initial Setting Level to the Control Initial Setting Level. $\bar{a} \bar{i} \bar{t}$ (Output 1 Type) will be displayed. Make sure that the set value is 0 (Voltage Output (for driving SSR)).
4. Press the Key repeatedly to select $\bar{n} \bar{o} \bar{d} \bar{e}$ (Control Mode). Make sure that the setting is 0 (Standard Control).
5. Press the Key to select $\bar{d} \bar{r} \bar{e} \bar{v}$ (Direct/Reverse Operation). Make sure that the setting is $\bar{d} \bar{r} \bar{r}$ (Reverse Operation).
6. Press the Key repeatedly to select $\bar{p} \bar{v} \bar{s} \bar{t}$ (PV Start). Make sure that the setting is $\bar{s} \bar{p}$ (SP Start).
7. Press the Key for less than 1 second to move from the Control Initial Setting Level to the Input Initial Setting Level and then press the Key repeatedly to select $\bar{m} \bar{o} \bar{v} \bar{e}$ (Move to Advanced Function Setting Level). Press the Key and set the password to -169 to move to Advanced Function Setting Level.
8. Press the Key or less than 1 second to move from the Advanced Function Setting Level to the Expansion Control Setting Level.
9. Press the Key to select $\bar{e} \bar{s} \bar{e} \bar{t}$ (End Condition). Press the Key to select the setting $\bar{c} \bar{o} \bar{n} \bar{t}$ (Continue).
10. Press the Key twice for at least 1 second to return to the Operation Level, and then press the Key for less than 1 second to move from the Operation Level to the Adjustment Level.
11. Press the Key repeatedly to select $\bar{c} \bar{p}$ (Control Period (Heating)), and then press the Key to select $\bar{2} \bar{0}$.

■ Program Settings

The following program is used in this example.

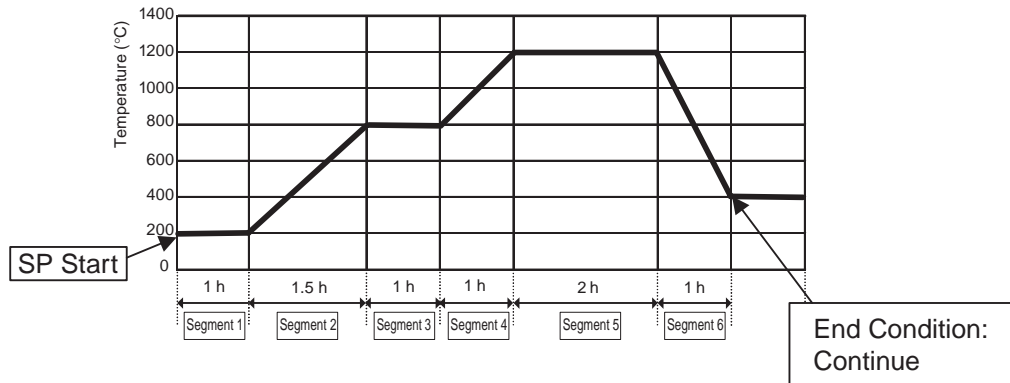

● Setting Procedure

Program Setting Level

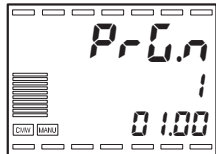

1. Press the Key for less than 1 second to move to the Program Setting Level. *PrG.n* (Program Editing) will be displayed. Set the program number to 1.

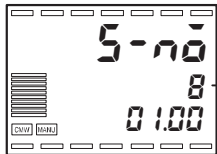

Number of Segments Used
8 → 6

2. Press the Key to select *S-nō* (Number of Segments Used). Press the Key to select 6 segments.

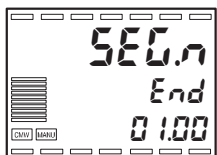

Segment Editing

3. Press the Key to select *SEd.n* (Segment Editing). Change from *End* to *1*.

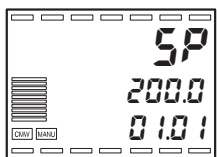

Segment Set Point

4. Press the Key to select *SP* (Segment Set Point). Press the Key to set the set point to *200.0*.

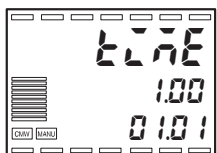

Segment Time

5. Press the Key to select *t.nE* (Segment Time). Press the Key to set the time to *1.00*.

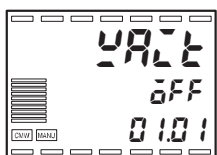

Wait

6. Press the Key to select *YRtE* (Wait). Make sure the setting is *0FF*.

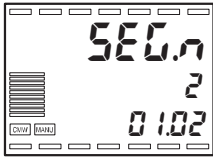

Segment Editing

7. Press the Key to return to **SEG.n** (Segment Editing). The segment number will automatically change to **2**.

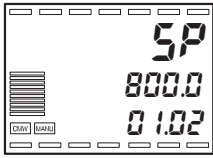

Segment Set Point

8. Press the Key to select **SP** (Segment Set Point). Press the Key to set the set point to **800.0**.

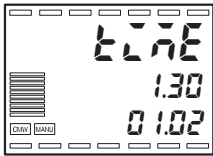

Segment Time

9. Press the Key to select **TIME** (Segment Time). Press the Key to set the time to **1.30**.

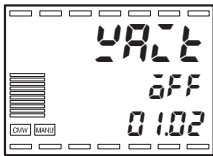

Wait

10. Press the Key to select **WAIT** (Wait). Make sure the setting is **OFF**.

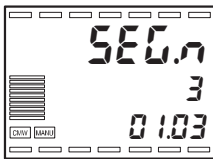

Segment Editing

11. Press the Key to return to **SEG.n** (Segment Editing). The segment number will automatically change to **3**.

Note: Continue repeating the above procedure to set segments 3 to 6. When finished, press the Key for less than 1 second to move to the Operation Level.

■ Adjustment

To adjust the PID constants, execute autotuning.

For more information, see *4.10 Determining the PID Constants (AT or Manual Settings)* (P. 4-33).

3.2 Coordinated Electric Oven Operation

With Models with Four Input Channels, coordinated operation can be performed based on channel 1. Operation is programmed using the same program for all channels. Offsets can be set for channels 2 to 4.

Application

Traditionally, three programmable temperature Controllers were required to control electric ovens in three zones. With the E5AR-T/ER-T, however, only one Controller is required for coordinated operation as long as the same program is used. Here, the E5AR-TCCE3MWW-FLK is used.

Typical Control Examples

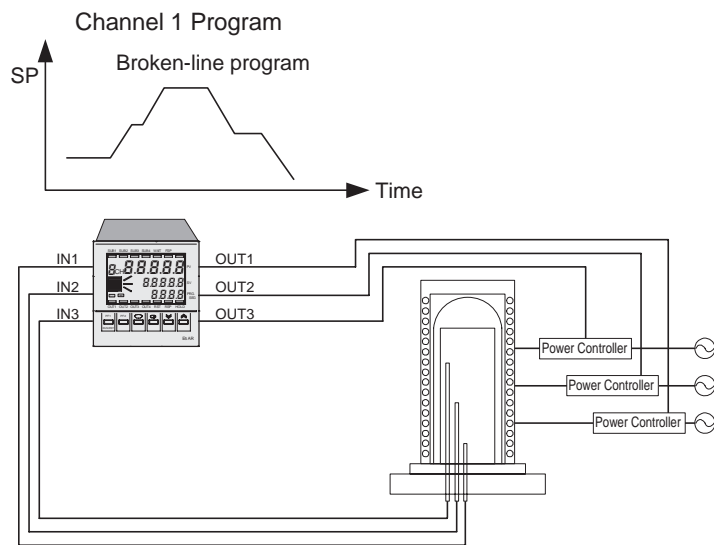

Wiring

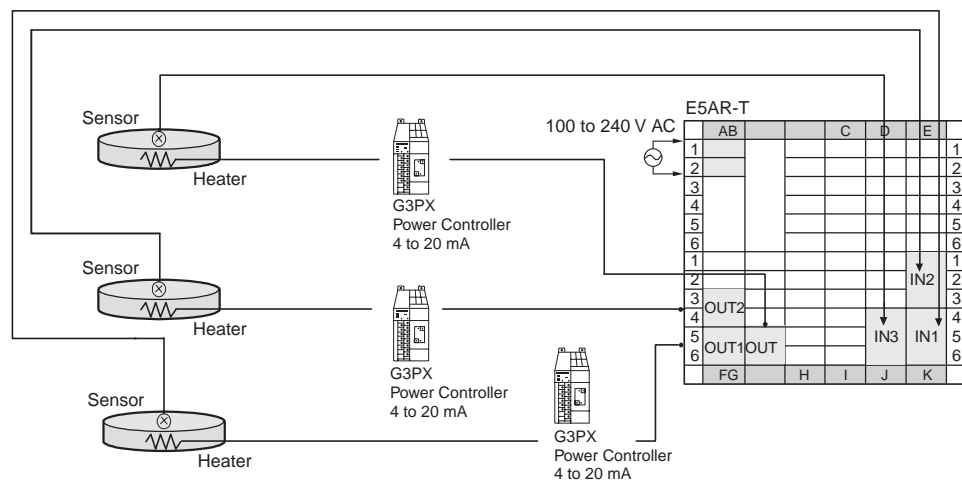

■ Settings

Inputs 1, 2 and 3 are set for type-K thermocouples. The settings for input 1 are shown below. The same settings are used for inputs 2 and 3.

Type	Setting
Input 1 type switch (Same for inputs 2 and 3.)	TC. PT (factory setting)
Input 1 Input Type parameter (Same for inputs 2 and 3.)	2: K, -200.0 to 1300°C (default)
Number of Enabled Channels parameter	3

● Setting Procedure

Input initial Setting Level

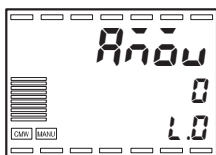
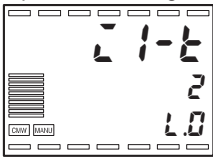
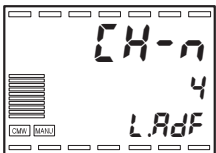
Move to Advanced
Function Setting LevelNumber of
Enabled Channels

1. Hold down the Key for at least 3 seconds to move from the Operation Level to the Input Initial Setting Level. $I-1$ (Input 1 Input Type) will be displayed. Press the Key to select the setting 2 (K -200.0 to 1300.0°C)
2. Press the Key repeated to select $A-169$ (Move to Advanced Function Setting Level). Press the Key and set the password to -169 to move to Advanced Function Setting Level.
3. Press the Key repeated to select $CH-4$ (Number of enabled channels). Press the Key to set the number of enabled channels to 3. This will disable channel 4.
4. Press the Key twice for at least 1 second to return to the Input Initial Setting Level, and then press the Key for at least 1 second to return to the Operation Level.

Input the program for channel 1 according to the setting procedure in 3.1 Standard Control (P. 3-2).

Section 4 Settings Required for Basic Control

4.1	Setting Levels and Key Operations.....	4-2
4.2	Set Values.....	4-6
4.3	Initial Setting Example	4-7
4.4	Setting the Input Type	4-10
4.5	Selecting the Temperature Unit	4-14
4.6	Selecting the Control Mode	4-15
4.7	Setting Output Parameters	4-20
4.8	Program Settings	4-23
4.9	Performing ON/OFF Control	4-31
4.10	Determining the PID Constants (AT or Manual Settings) ..	4-33
4.11	Using Auxiliary Outputs	4-37
4.12	Starting and Stopping Operation	4-41
4.13	Manual Operation	4-47
4.14	Changing Channels	4-50
4.15	Adjusting Programs	4-51
4.16	Operating Precautions.....	4-52

4.1 Setting Levels and Key Operations

The parameters are grouped into levels and the values that are set for the parameters are called set values. On the E5AR-T/ER-T, the parameters are grouped into 19 levels as shown below.

When the power is turned ON, all indicators will light for 1 second. The initial level after turning ON the power is the Operation Level.

Settings Required for Basic Control

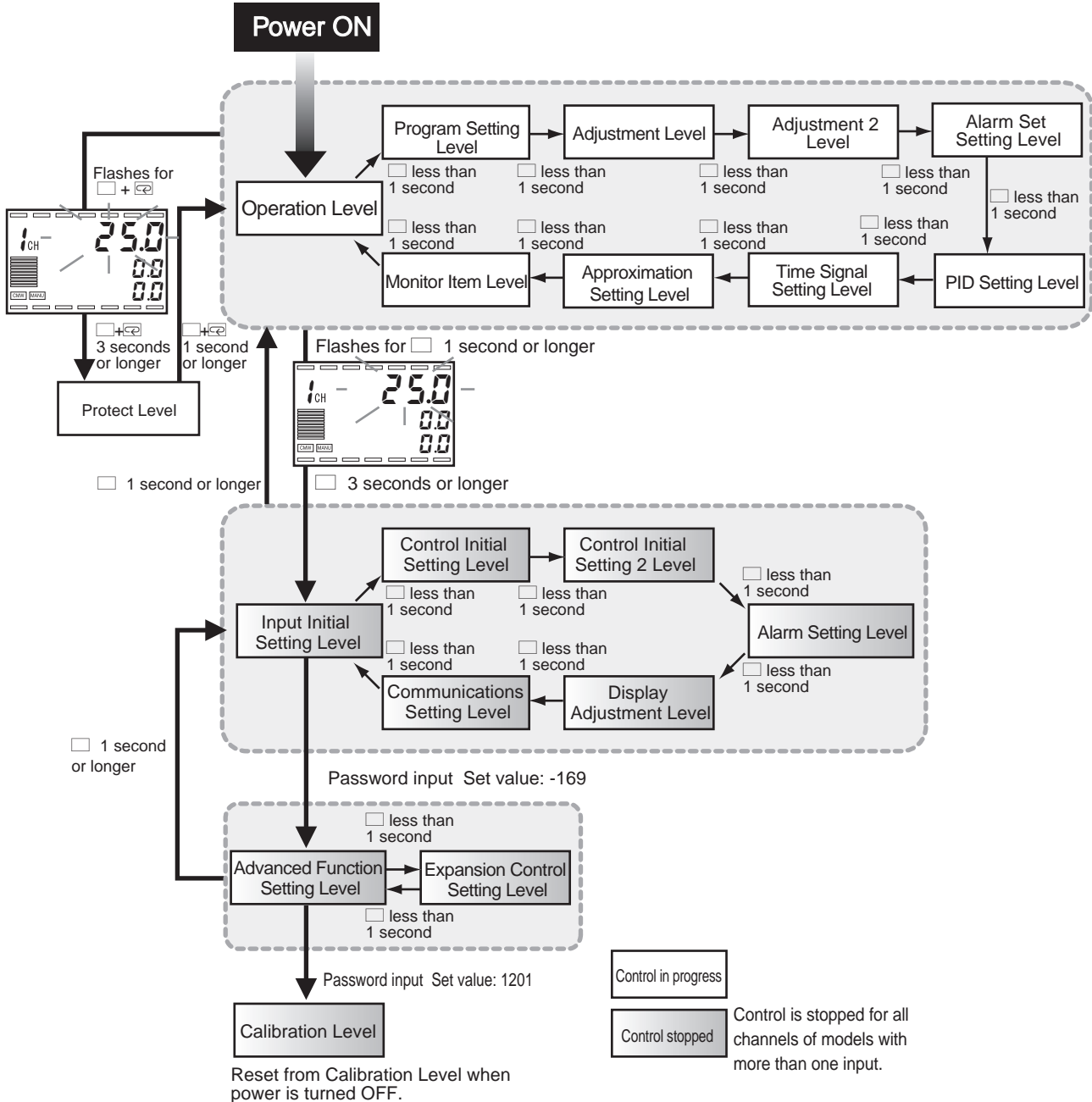

Level	Description	Operation
Protect Level	Settings to prevent accidental key inputs.	During operation
Operation Level	Basic displays and settings for operation.	
Program Setting Level	Program and segment settings.	
Adjustment Level	Option settings and control adjustments.	
Adjustment 2 Level	Settings that can be adjusted during processing function control operations.	
Alarm Set Setting Level	Settings for each alarm set.	
PID Setting Level	PID constants and limit settings for each PID set.	
Time Signal Setting Level	Settings for time signals.	
Approximation Setting Level	Broken-line approximation and straight-line approximation settings.	
Monitor Item Level	Monitor displays for set values.	
Input Initial Setting Level	Initial settings related to inputs.	When operation is stopped
Control Initial Setting Level	Initial settings for output types and control modes.	
Control Initial Setting 2 Level	Initial settings for processing functions.	
Alarm Setting Level	Alarm type and output settings.	
Display Adjustment Level	Display adjustment settings.	
Communications Setting Level	Communications speed, communications data length, and other communications settings.	
Advanced Function Setting Level	Initialization of settings and PF Key settings.	
Expansion Control Setting Level	Advanced control settings and position-proportional control settings.	
Calibration Level	Calibration by the user.	





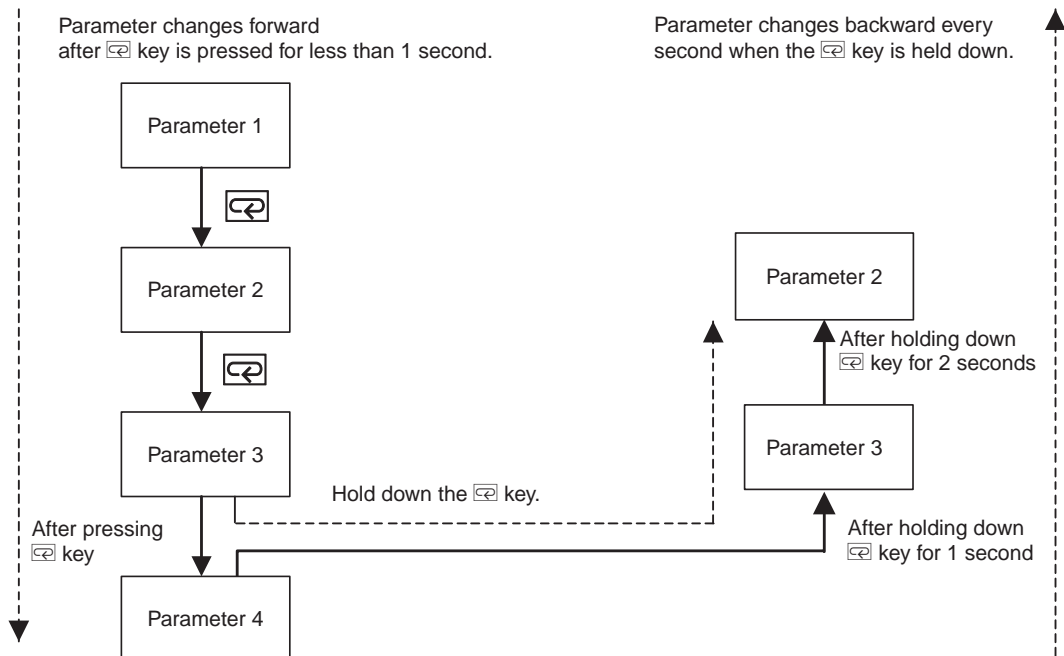

* To move to the Advanced Function Setting Level, set the Initial Setting Protection parameter in the Protect Level to 0.

■ Changing Parameters

Within each level, the parameter will change either forward or backward each time the  Key is pressed. (The parameters will not change backward in the Calibration Level.) For details, refer to *Section 8 Parameters*.



■ Saving Parameter Settings

- The first parameter will be displayed if the  Key is pressed when the last parameter is being displayed.
- To change a setting, use the  and  Keys to change the setting and then either wait for 2 seconds or press the  Key to save the change.
- A change to a parameter setting is also saved when the level is changed.
- Before turning OFF the power supply, always be sure that any changes to parameter settings are confirmed (e.g., by pressing the  Key). Any changes made with the  and  Keys that have not been saved will be lost when the power supply is turned OFF.

Control is stopped in following levels: Input Initial Settings, Control Initial Setting, Control Initial Settings 2, Alarm Settings, Display Adjustment, Communications Settings, Advanced Function Settings, Expansion Control Settings and Calibration. Control will stop on all channels as soon as you move to any of these levels.

Display No. 3 shows the current level. The characters and the corresponding levels are as follows:

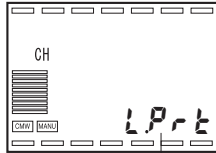

Display No. 3	Level
LPrt	Protect Level
Not lit *1	Operation Level
Not lit *1	Program Setting Level
LAdj	Adjustment Level
LAdj2	Adjustment 2 Level
LAln	Alarm Set Setting Level
LPid	PID Setting Level
Not lit *2	Time Signal Setting Level
LtEC	Approximation Setting Level
Lnon	Monitor Item Level
L0	Input Initial Setting Level
L1	Control Initial Setting Level
L2	Control Initial Setting 2 Level
L3	Alarm Setting Level
L4	Display Adjustment Level
L5	Communications Setting Level
LdF	Advanced Function Setting Level
LEc	Expansion Control Setting Level
LEAL	Calibration Level

*1 The program number and segment number are displayed.





*2 The program number and ± 5 are displayed.

4.2 Set Values

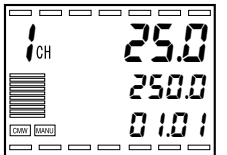
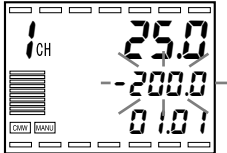
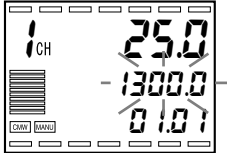
The value selected for each parameter is called the set value. There are two types of set values: numbers and characters. Set values are displayed and changed as follows:

Changing a Numeric Set Value



1. Press the  Key continuously to increase the set value.
When the upper limit of the setting is reached, the set value will flash and cannot be increased any further.
2. Press the  Key continuously to decrease the set value.
When the lower limit of the setting is reached, the set value will flash and cannot be decreased any further.
3. Follow steps 1 and 2 to change the set value to the desired value.
The setting is saved 2 seconds after it is changed, or when a key other than the  or  Key is pressed.
When setting the Manual MV parameter, the set value is output every 50 ms. The set value is saved as described above.

4.3 Initial Setting Example

This section describes how to make the initial settings for the sensor input type, alarm type, control period, and other parameters. Use the Key and Key to move through the displays. The parameter that is displayed next depends on how long the key is held down.

● Interpreting the Example

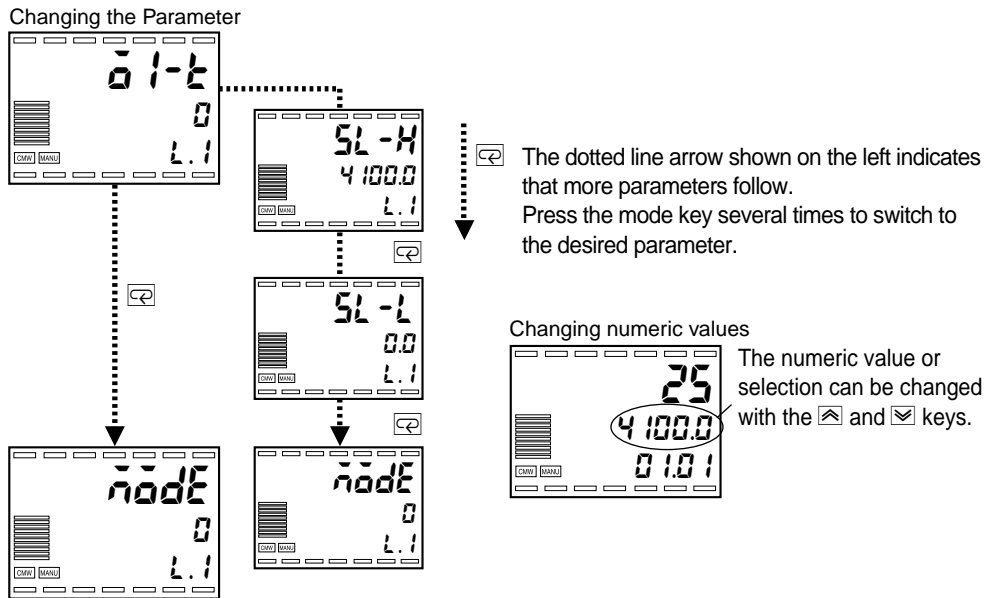

● Typical Example

E5AR-TQ4B	
Input type:	0 = Pt100 (-200.0 to 850.0°C)
Control mode:	PID control
Control output:	Voltage output (for driving SSR)
Alarm 1 type:	8 = Absolute-value upper-limit
Alarm value 1:	200.0°C
PID:	Obtained by auto-tuning (AT)
SP:	According to program

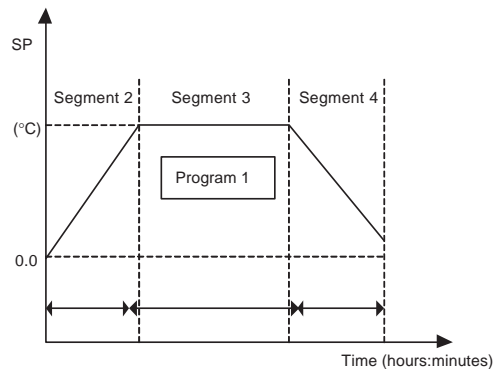
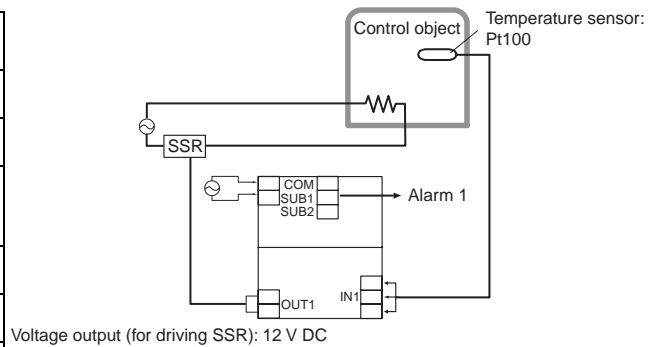

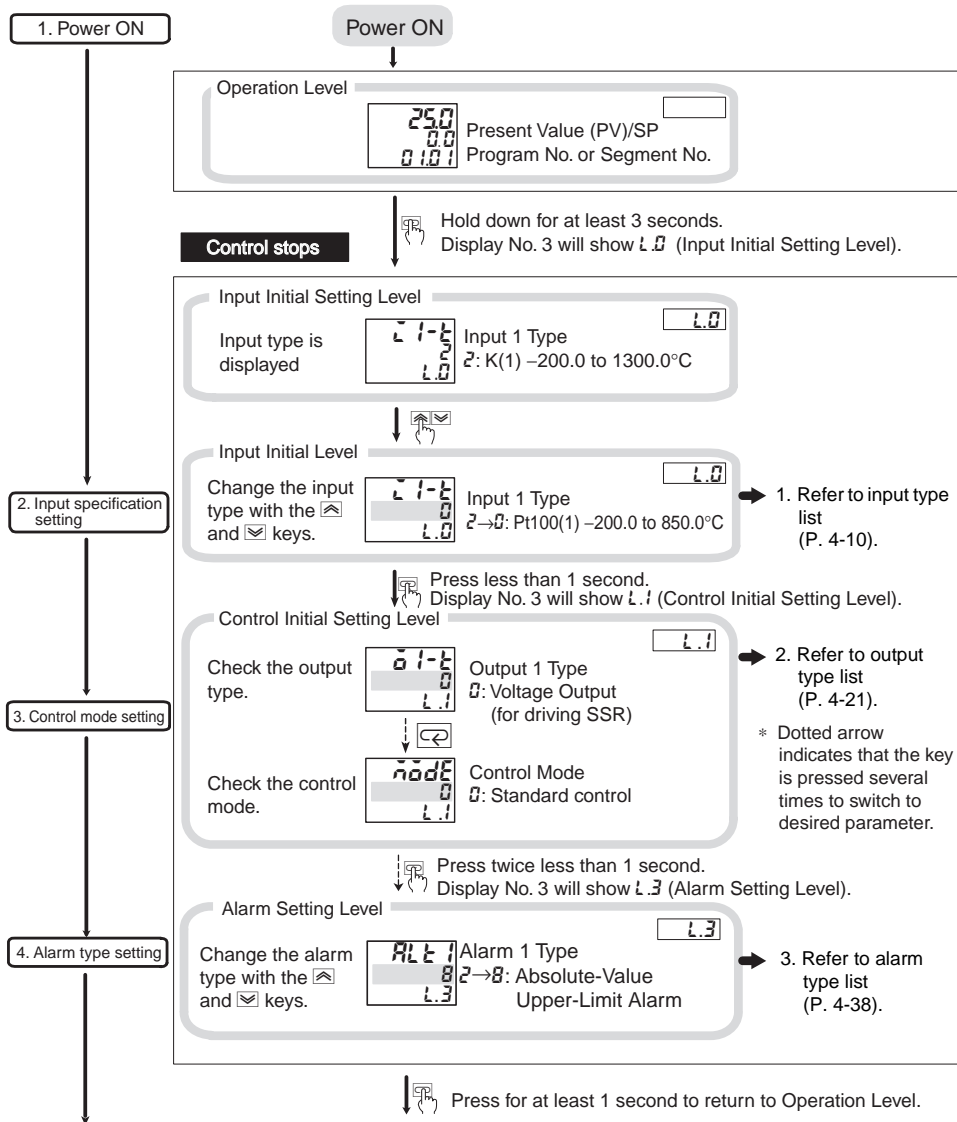

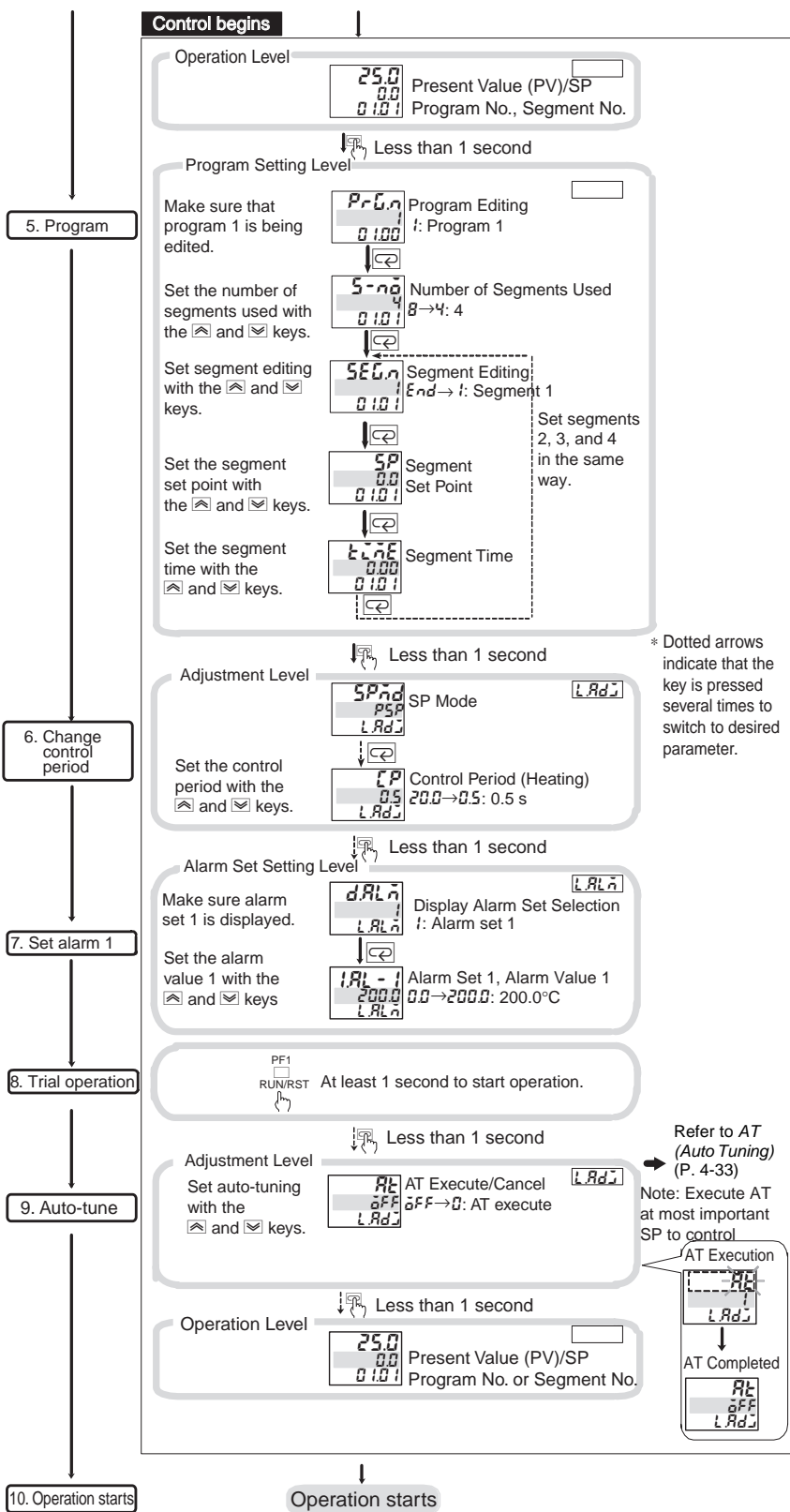

4.4 Setting the Input Type

Set the input type switch and the Input Type parameter according to the sensor to be used. Check the table below and set the correct value for the sensor temperature range to be used.

When using a Controller with more than one input, also set input type switches 2 to 4 and the Input 2 to 4 Type parameters according to the number of input points.

■ Input Type

Setting Input 1 to a Platinum Resistance Thermometer Pt100, -150.0 to 150.0°C (-199.99 to 300.00°F)

Input type SW

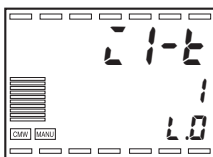
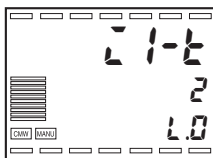
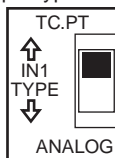

1. Make sure that the input 1 type switch is set to TC.PT and then turn ON the power.
2. Hold down the Key for at least 3 seconds to move from the Operation Level to the Input Initial Setting Level. The display will show $1-1$ (Input 1 Type).
3. Press the Key to enter the set value for the desired sensor. When using a Pt100 platinum resistance thermometer (-150.00 to 150.00°C (-199.99 to 300.00°F)), set the value to 1.

● Input Types

Set value	Input type	Setting range		Input type switch
		($^{\circ}\text{C}$)	($^{\circ}\text{F}$)	
0	Pt100 (1)	-200.0 to 850.0	-300.0 to 1500.0	<p>TC.PT</p> <p>TC.PT</p> <p>IN1 TYPE</p> <p>ANALOG</p>
1	Pt100 (2)	-150.00 to 150.00	-199.99 to 300.00	
2	K (1)	-200.0 to 1300.0	-300.0 to 2300.0	
3	K (2)	-20.0 to 500.0	0.0 to 900.0	
4	J (1)	-100.0 to 850.0	-100.0 to 1500.0	
5	J (2)	-20.0 to 400.0	0.0 to 750.0	
6	T	-200.0 to 400.0	-300.0 to 700.0	
7	E	0.0 to 600.0	0.0 to 1100.0	
8	L	-100.0 to 850.0	-100.0 to 1500.0	
9	U	-200.0 to 400.0	-300.0 to 700.0	
10	N	-200.0 to 1300.0	-300.0 to 2300.0	
11	R	0.0 to 1700.0	0.0 to 3000.0	
12	S	0.0 to 1700.0	0.0 to 3000.0	
13	B	100.0 to 1800.0	300.0 to 3200.0	
14	W	0.0 to 2300.0	0.0 to 4100.0	

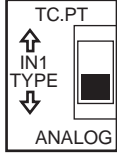
Set value	Input type	Setting range		Input type switch
		(°C)	(°F)	
15	4 to 20 mA	One of the following ranges is displayed depending on the scaling. –19999 to 99999 –1999.9 to 9999.9 –199.99 to 999.99 –19.999 to 99.999 –1.9999 to 9.9999		ANALOG 
16	0 to 20 mA			
17	1 to 5 V			
18	0 to 5 V			
19	0 to 10 V			

Set the input type switch according to the setting of the Input Type parameter.
The default settings are 2 and TC.PT.









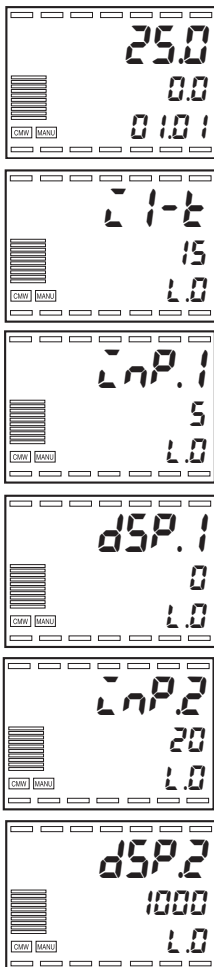



Hint

When an analog input (voltage or current input) is used, scaling is possible according to the type of control.

■ Scaling

Setting the Display to Show 0.0 for an Input Value of 5 mA and 100.0 for 20 mA When the Input 1 Type Parameter Is Set to 4 to 20 mA.



1. Hold down the  Key for at least 3 seconds to move from the Operation Level to the Input Initial Setting Level.
2. Make sure that $\bar{I}-t$ (Input 1 Type) is set to 15 (4 to 20 mA).
3. Press the  Key repeatedly to select $\bar{I}nP.1$ (Scaling Input Value 1). Set the scaling input value to 5 with the  and  Keys.
4. Press the  Key to select $d5P.1$ (Scaling Display Value 1). Set the scaling display value to 0 with the  and  Keys.
5. Press the  Key to select $\bar{I}nP.2$ (Scaling Input Value 2). Set the scaling input value to 20 with the  and  Keys.
6. Press the  Key to select $d5P.2$ (Scaling Display Value 2). Set the scaling display value to 1000 with the  and  Keys.

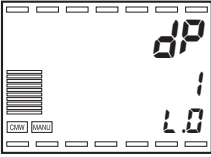

7. Press the Key to select **dP** (Decimal Point Position).
Set the decimal point position to 1 with the and Keys.

8. Hold down the Key for at least 1 second to return to the Operation Level.

Scaling can be set separately for each channel. For scaling, inputs 1 to 4 of a Controller with more than one input correspond to channels 1 to 4. Select the channel with the CH Key and then set the scaling.

Scaling Parameters

Parameter	Attribute	Display	Setting range	Default setting	Unit
Scaling Input Value 1	CH	$\bar{c}nP.1$	See table below.	4	See table below.
Scaling Display Value 1	CH	$dSP.1$	-19999 to scaling display value 2 - 1	0	EU
Scaling Input Value 2	CH	$\bar{c}nP.2$	See table below.	20	See table below.
Scaling Display Value 2	CH	$dSP.2$	Scaling display value 1 + 1 to 99999	100	EU
Decimal Point Position	CH	dP	0 to 4	0	-

Setting Range and Unit for Each Input Type

Input type	Setting range	Unit
4 to 20 mA	4 to 20	mA
0 to 20 mA	0 to 20	mA
1 to 5 V	1 to 5	V
0 to 5 V	0 to 5	V
0 to 10 V	0 to 10	V

The operation of E5AR-T/ER-T control functions and alarms is based on the input value. If a value greater than $\bar{c}nP.2$ (Scaling Input Value 2) is set for $\bar{c}nP.1$ (Scaling Input Value 1), operation will be as follows for the display value:

- **Direct/Reverse Operation**
When direct operation is set, the manipulated variable will increase when the display value decreases.
When reverse operation is set, the manipulated variable will increase when the display value increases.

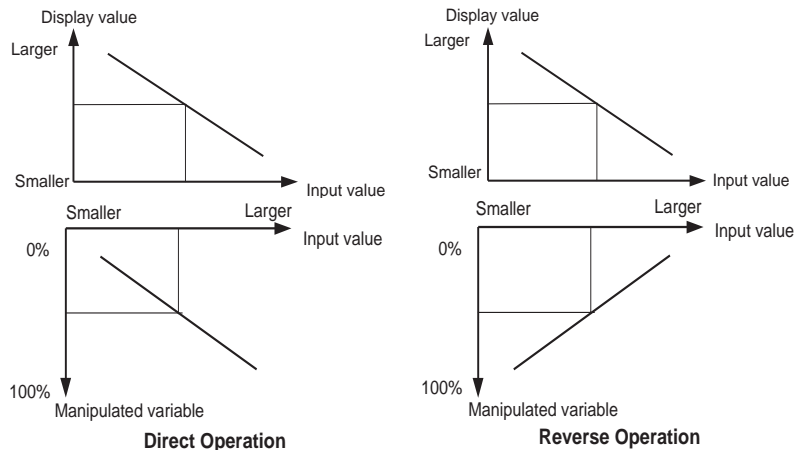

For information on direct and reverse operation, refer to 4.7 *Setting Output Parameters* (P. 4-20).

- Alarms

The upper-limit alarm and lower-limit alarm will be inverted. Therefore, set an alarm type and alarm values that invert the upper limit or lower limit of the display value. For example, if an absolute-value upper limit is set for the alarm type, operation will be as shown in the following figure.

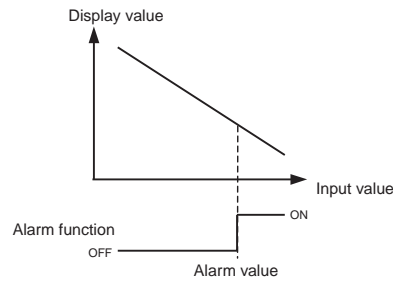

For information on alarms, refer to *4.11 Using Auxiliary Outputs* (P. 4-37).

- Input Correction

The sign of the input correction value will be inverted. Therefore, set the Input Correction 1 and Input Correction 2 parameters to values that invert the sign of the display value. For more information on input correction, refer to *5.1 Input Adjustment Functions* (P. 5-2).

Important

- PID Set Automatic Selection

If the PID Set Automatic Selection Data parameter is set to "PV," set the PID Set Automatic Selection Range Upper Limit parameter so that the set value decreases for the PID set numbers in ascending order as shown in the following figure.

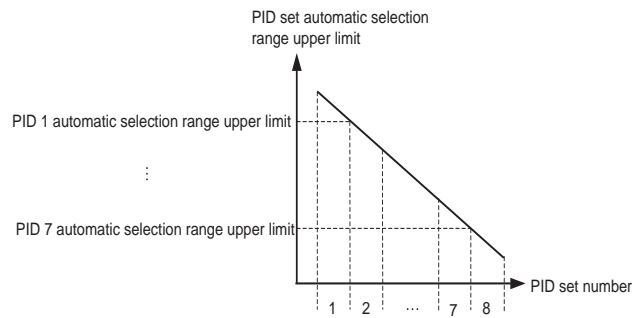

If the PID Set Automatic Selection Data parameter is set to "DV," the DV used when performing auto-select will be inverted.

For more information on the PID Set Automatic Selection parameter, refer to *5.2 Control Functions* (P. 5-8).

4.5 Selecting the Temperature Unit

When the input type is set to a temperature input (input from a thermocouple or a platinum resistance thermometer), either °C or °F can be selected for the temperature unit.

When using a Controller with more than one input, set the temperature unit separately for each input (inputs 2 to 4) according to the number of inputs.

Selecting °C

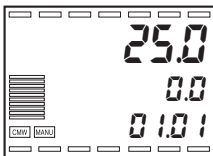
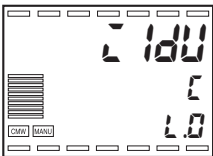
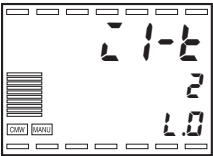
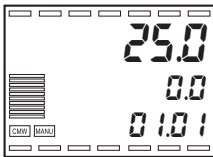

1. Hold the Key down for at least 3 seconds to move from the Operation Level to the Input Initial Setting Level.

2. Press the Key to select (Input 1 Temperature Units)
Select °C or °F with the and Keys.

: °C : °F

3. Hold the Key down for at least 1 second to return to the Operation Level.

4.6 Selecting the Control Mode

The control mode allows various types of control to be performed. The control mode is set to standard control by default.

■ Standard Control

- Standard heating or cooling control is performed. The Direct/Reverse Operation parameter is used to select heating (reverse operation) or cooling (direct operation).
- When using PID control, the Proportional Band (P), Integral Time (I), and Derivative Time (D) parameters must be set. These PID constants can be set either using auto-tuning (AT) or manually.
- When the proportional band (P) is set to 0.00%, control becomes ON/OFF control.

■ Heating/Cooling Control

- Heating and cooling control is performed.
- When using PID control, in addition to the Proportional Band (P), Integral Time (I), and Derivative Time (D) parameters, the Cooling Coefficient and Dead Band parameters must also be set. The PID constants can be set either using auto-tuning (AT) or manually. The Cooling Coefficient and Dead Band parameters must be set manually.
- When the proportional band (P) is set to 0.00%, control becomes ON/OFF control and 3-position control is possible.

● Dead Band

The dead band is set centered on the set point. The dead band width is set in the Dead Band parameter in the Adjustment Level. A negative setting sets an overlap band.

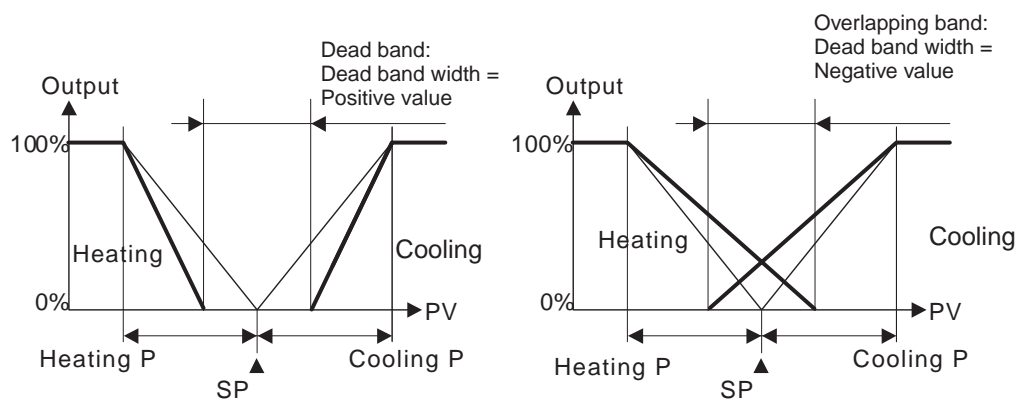

- The default dead band is 0.00.

● Cooling Coefficient

If heating and cooling characteristics of the controlled object are different and good control characteristics cannot be achieved with the same PID constants, a cooling coefficient can be set to adjust the proportional band for the cooling control output to achieve balance between heating and cooling control.

Heating P = P

Cooling P = Heating P × Cooling coefficient

The cooling P is obtained by multiplying the heating P by the cooling coefficient to control the cooling output with different characteristics from the heating output.

The following control modes can be selected only on Controllers with 2 inputs.

■ Standard Control with Remote SP

- An external DC current or voltage signal can be input into the remote SP input (input 2) to perform standard control using the remote SP input as the SP.
- Input 2 can be used within the setting range determined by the input 2 type.

■ Heating/Cooling Control with Remote SP

- An external DC current or voltage signal can be input into the remote SP input (input 2) to perform heating/cooling control using the remote SP input as the SP.
- Input 2 can be used within the setting range determined by the setting of the Input 2 Type parameter.

■ Proportional Control

- Proportional control is used to maintain a set proportional relationship between two variables.
- Proportional control is set in the Analog Parameter 1 (control rate) parameter.
- If the input type set for input 1 and input 2 are different, the units for input 1 and input 2 must be adjusted. Settings must be made for the following: first, the Straight-line Approximation 1 parameters must be used to convert input 2 from normalized data to industrial units and then the Straight-line Approximation 2 parameters must be used to convert the industrial units back to normalized data for input 1.

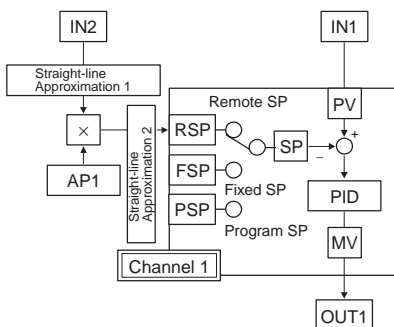

Hint

Set all numeric values for straight-line or broken-line approximation for the E5AR-T/ER-T to normalized data. For example, set 0.0200 for 20%. Also, when input 1 is set to a K-type thermocouple from 200.0 to 1300.00, -200.0°C is 0%, or 0.000, and 1300°C is 100%, or 1.000.

■ Cascade Standard Control

- Cascade control can be performed using standard control (heating control or cooling control).
- Input 1 is for the primary loop (channel 1) and input 2 is for the secondary loop (channel 2).

● AT with Cascade Control

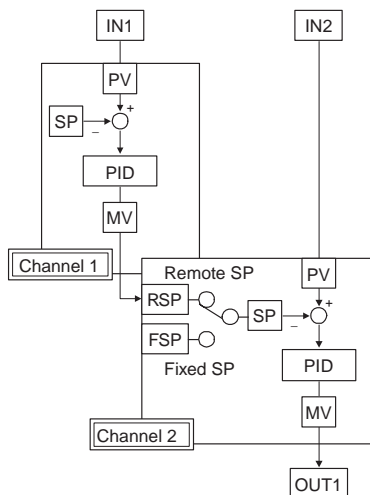

- (1) Execute AT for the secondary side to find the suitable PID constants.
Set the PV on the secondary side during stable control near the primary side SP as the fixed SP for the secondary side.
Set the channel 2 SP mode to Fixed SP Mode (cascade open), set the secondary side to independent control and execute AT.
Once AT has been completed, find the secondary side PID constants.
- (2) Change to cascade control and execute AT for the primary side to find the suitable PID constants.
Change the channel 2 SP mode to Remote SP Mode (cascade closed), change to cascade control, and execute AT for channel 1.

● Operation for Primary Side Input Errors

If an error occurs on the primary side, the value set for the MV at PV Error parameter is output as the primary side (channel 1) MV. The secondary side continues control of the remote SP equivalent to the primary side setting for the MV at PV Error parameter. This means that the primary side (channel 1) MV at PV Error parameter must always be set.

■ Cascade Heating/Cooling Control

- Cascade control can be performed using heating/cooling control.
- Input 1 is for the primary loop (channel 1) and input 2 is for the secondary loop (channel 2).

The Control Mode parameter does not need to be set for Position-proportional Control Models. These models always perform position-proportional control.

■ Position-proportional Control

- A potentiometer is used to determine how much the valve is open or closed. The opening of valves with control motors attached can be controlled, i.e., opened or closed.
- With position-proportional control, control can be switched between closed control and floating control. Travel time can be automatically measured using motor calibration, and position-proportional dead band, open/close hysteresis, PV dead band, and other parameters can be set.

● Closed/Floating

- Closed Control
When a potentiometer is connected, closed control provides feedback on the valve opening.
- Floating Control
No feedback is provided on the valve opening using a potentiometer. Control is possible without a potentiometer connected.

● Motor Calibration and Travel Time

Execute motor calibration if a potentiometer is connected for closed control or for floating control to monitor the valve opening.

The travel time, which is the time from when the valve is fully open to when it is fully closed, is automatically measured and set at the same time.

The Travel Time parameter must be set for floating control without a potentiometer connected. Set the Travel Time parameter to the time from when the valve is fully open to when it is fully closed.

● Position-proportional Dead Band and Open/Close Hysteresis

The valve output hold interval (the interval between open output and closed output ON/OFF points) is set using the Position Proportional Dead Band parameter and the hysteresis is set using the Open/Close Hysteresis parameter. The following diagram shows the relationship to the valve opening.

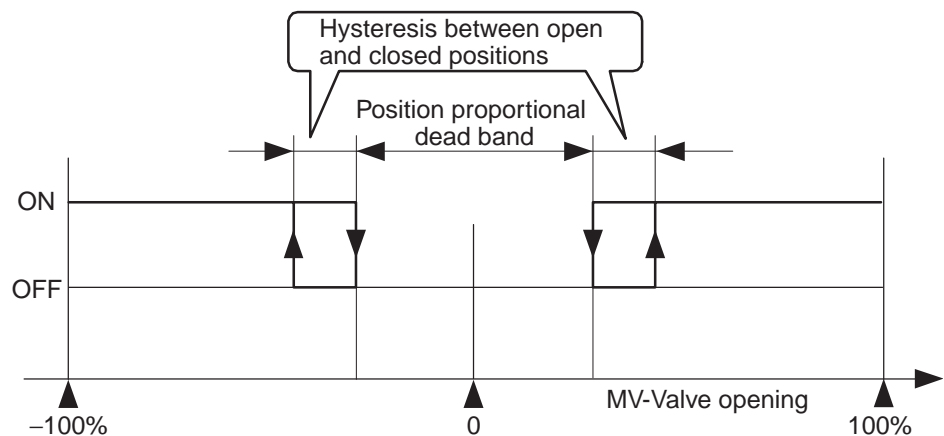

● PV Dead Band

If the PV is within the PV dead band, control is performed as if the PV is the same as the SP. The PV dead band is set in the PV Dead Band parameter. This function is useful to prevent unnecessary outputs when the PV approaches the SP.

● Operation at Potentiometer Input Error

The Operation at Potentiometer Input Error parameter is used to select the operation to perform if an error occurs with the potentiometer during closed control. The selections are to stop control or switch to floating control and continue.

**Important**

Potentiometer errors are not detected if the O or C lines are disconnected on the potentiometer. This function, i.e., the option of stopping control or switching to floating control, is not supported in such cases.

4.7 Setting Output Parameters

■ Control Period

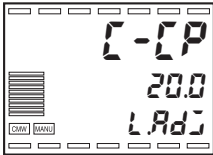
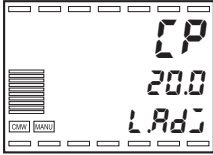

- The output period (control period) must be set. A shorter control period improves controllability, however, when a relay is used to control a heater, a control period of at least 20 seconds is recommended to preserve product life. After setting the control period in the initial settings, readjust it as necessary using trial operation.
- Set the values in [CP] (Control Period (Heating)) and [C-CP] (Control Period (Cooling)). The default values are 20.0 s.
- The Control Period (Cooling) parameter can be used only in heating/cooling control.
- When each channel is used independently for control, set the control period separately for each channel.

■ Direct Operation (Cooling)/Reverse Operation (Heating)

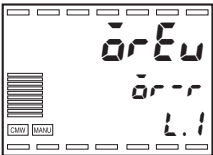
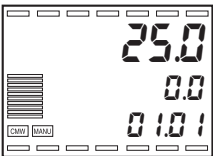

- Control that increases the MV as the PV increases is called direct operation (cooling), and control that increases the MV as the PV decreases is called reverse operation (heating).

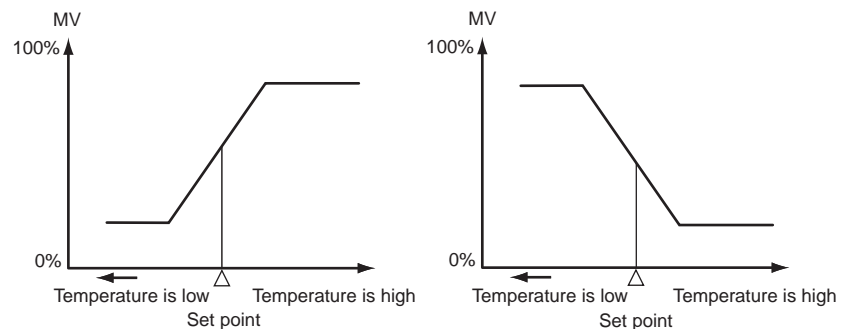

- For example, when the present value (PV) is less than the set point (SP) during heating control, the manipulated valuable (MV) is increased in proportion to the difference between the PV and SP. As such, heating control is “reverse operation.” Cooling control, which does the opposite, is “direct operation.”
- Set the Direct/Reverse Operation parameter to 0r-r (reverse operation) or 0r-d (direct operation). The default setting is for reverse operation (heating).
- When each channel is used independently for control, set the direct/reverse operation separately for each channel.

Output Type

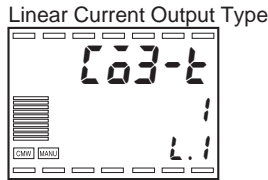
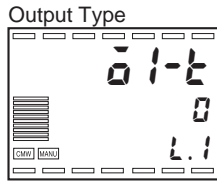

- The E5AR-T/ER-T provides multi-outputs that allow selection of voltage outputs (for driving SSRs) or linear current outputs. Select the output type in the Output * Type parameter for each output. The following are multi-outputs: output 1 of the E5AR-TQ□□□□ and E5ER-TQ□□□, and outputs 1 and 3 of the E5AR-TQQ□□.
- A linear current output can be set to 4 to 20 mA or 0 to 20 mA in the Linear Current Output * Type parameter.
- The voltage output (for driving SSR) is 12 VDC, 40 mA.

Output Type List

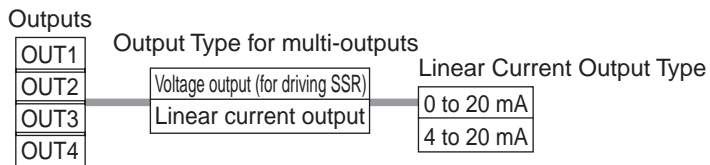

Output Assignments

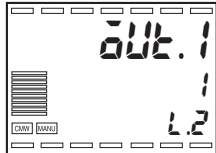

- The type of data that is output from each output can be assigned.
- On Controllers with more than one input, the data assignments can also be set for channels 2 and higher for the number of supported channels.

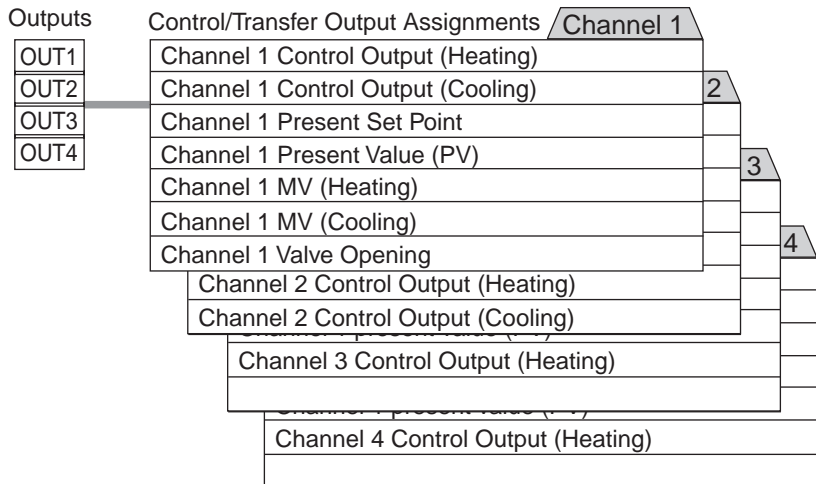

- When outputs are used as control outputs, assignments are made automatically based on the control mode setting as shown on the following page. There is no need to change the assignments.
- To use an output as a transfer output, assign the data you wish to transfer to an unused output. If a transfer output is assigned to a voltage output (for driving SSR), the output will turn OFF.

Control mode	Controllers with 1 input	Controllers with 2 inputs	Controllers with 4 inputs	Output	Control/Transfer output assignment
Standard Control	IN1	IN1	IN1	OUT1	Channel 1 Control Output (Heating)
	---	IN2	IN2	OUT2	Channel 2 Control Output (Heating)
		---	IN3	OUT3	Channel 3 Control Output (Heating)
			IN4	OUT4	Channel 4 Control Output (Heating)
Heating/Cooling Control	IN1	IN1	IN1	OUT1	Channel 1 Control Output (Heating)
	---	IN2	IN2	OUT2	Channel 1 Control Output (Cooling)
				OUT3	Channel 2 Control Output (Heating)
				OUT4	Channel 2 Control Output (Cooling)
Standard Control with Remote SP	---	IN1 IN2: Remote SP	---	OUT1	Channel 1 Control Output (Heating)
Heating/Cooling Control with Remote SP	---	IN1 IN2: Remote SP	---	OUT1 OUT2	Channel 1 Control Output (Heating) Channel 1 Control Output (Cooling)
Proportional Control	---	IN1 IN2: Ratio setting	---	OUT1	Channel 1 Control Output (Heating)
Cascade Standard Control	---	IN1: Primary loop IN2: Secondary loop	---	OUT1	Channel 2 Control Output (Heating)
Cascade Heating/Cooling Control	---	IN1: Primary loop IN2: Secondary loop	---	OUT1 OUT2	Channel 2 Control Output (Heating) Channel 2 Control Output (Cooling)
Position-proportional Control	IN1	---	---	OUT1 OUT2	Channel 1 Control Output (Open) *Cannot be changed Channel 1 Control Output (Close) *Cannot be changed

4.8 Program Settings

■ Outline of Program Functions

- Up to 32 programs can be created and each program can have up to 32 segments as long as the total number of segments does not exceed 256.
- A variety of program profiles can be created using the program link function.

The following diagram shows a program setting example.

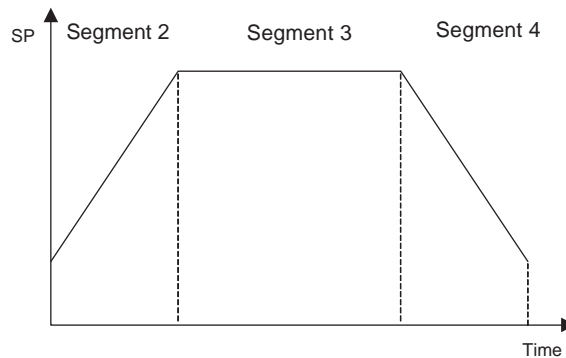

■ Program Parameters

● Number of Segments

- The maximum number of segments for a program is set using the Number of Segments parameter. The default is 16.
- The relationship between the number of programs and the number of segments that can be set using the Number of Segments parameter is shown in the following table.

Setting of Number of Segments parameter	Number of programs	Number of segments
8	32	8
12	20	12
16	16	16
20	12	20
32	8	32

● Program No.

- The program number cannot be changed while a program is being executed.
- The default program number is 1, except for independent operation. The following table shows the setting ranges.

Setting of Number of Segments parameter	Setting range
8	1 to 32
12	1 to 20
16	1 to 16
20	1 to 12
32	1 to 8

● Number of Segments Used

- The Number of Segments Used parameter is used to set the number of segments used for a specified program.
- The default is 8. The following table shows the setting ranges.

Setting of Number of Segments parameter	Setting range
8	1 to 8
12	1 to 12
16	1 to 16
20	1 to 20
32	1 to 32

- Once the program has been executed for the number of segments set for the Number of Segments Used parameter, the program will be in operation completed status. If the setting of the Number of Segments Used parameter is changed to a value smaller than the segment currently being executed in the program, the program will immediately change to operation completed status.

● Segment Set Point and Segment Time

- The Segment Set Point and Segment Time parameters are used to set one segment of a program. The present SP is determined by using the SP of the previous segment as the start point and the SP of the current segment as the end point. A straight line is drawn between these two points and the present SP is the point on that line where the current segment time has elapsed.
- The Segment Time parameter can be set to between 0.00 and 99.59 (hours. minutes or minutes. seconds) or between 0.00.0 and 99.59.9 (minutes. seconds.tenths of seconds). The default is 0.00 or 0.00.0.
- The first segment is a soak segment. To start from a ramp, set the Segment Time parameter for segment 1 to 0 to create a program that starts from segment 2 (when the Operation at Reset parameter is set to "Control Stop").

■ Program Setting Example

In this example, the following program will be created as program 2.

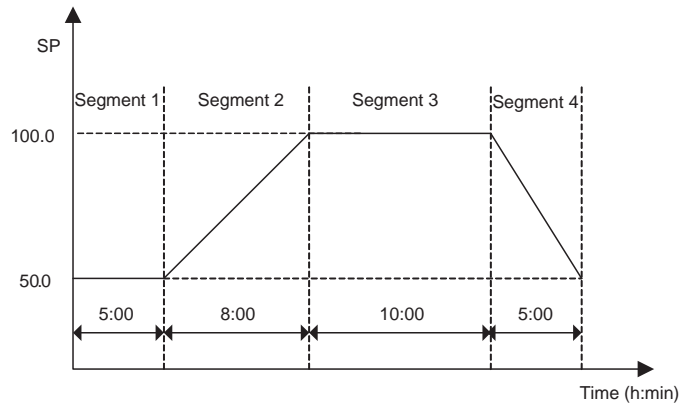

The following table shows the settings required for the Number of Segments, Number of Segments Used, and Program No. parameters.

Parameter	Set value
Number of Segments	8 (No. of programs: 32)
Number of Segments Used (Program No. 2)	4
Program No.	2

The Segment Set Point and Segment Time parameter settings for program 2 are given in the following table.

Segment No.	1	2	3	4	---
Segment Set Point	50.0	100.0	100.0	50.0	---
Segment Time (h:min)	5:00	8:00	10:00	5:00	---

Use the following procedure to set the Number of Segments parameter to 8 (thus setting the number of programs to 32).

Number of Segments

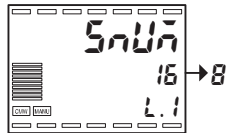
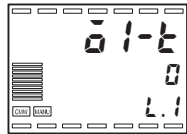
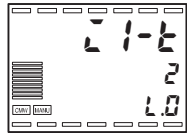
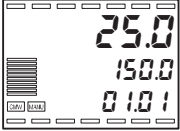

- (1) Hold down the Key for at least 3 seconds to move from the Operation Level to the Input Initial Setting Level.

- (2) In the Input Initial Setting Level, Display No. 3 will show *L. 0*. Press the Key for less than 1 second to move to the Control Initial Setting Level.

- (3) In the Input Initial Setting Level, Display No. 3 will show *L. 1*. Press the Key repeatedly (less than 1 second each time) to select the Number of Segments parameter.

- (4) Press the to set the Number of Segments parameter to 8.

Use the following procedure to set the Number of Segments Used parameter to 4.

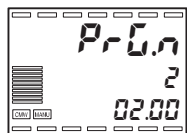
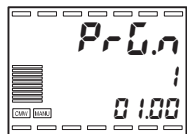
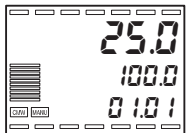

Number of Segments Used

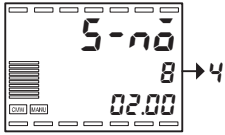

- (1) Hold down the Key for less than 1 second to move from the Operation Level to the Program Setting Level.

- (2) The Program Editing parameter will be displayed in the Program Setting Level. Select the number of the program to be edited. For example, to change the Number of Segments Used parameter for program 2, use the Key to select 2.



(3) Press the  Key to display the Number of Segments Used parameter for program 2. Use the  and  Keys to set the value to 4.

(4) Hold down the  Key for less than 1 second to return to the Operation Level.

Use the following procedure to set the program to be executed to 2 in the Operation Level.

Program No.

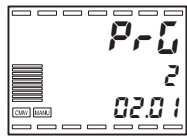
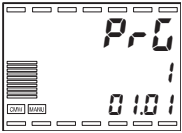
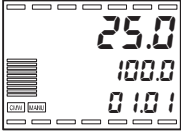

- (1) Press the Key several times to select the Program No. parameter to enable specifying the number of the program to execute.

- (2) Use the and Keys to set the program number to 2.

Use the following procedure to set the Segment Set Point and Segment Time parameters for segments 1 to 4 for program No. 2.

Segment Set Point and Segment Time

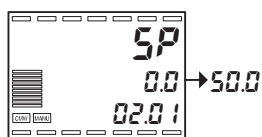
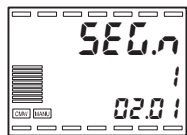
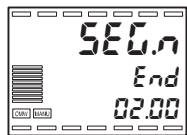
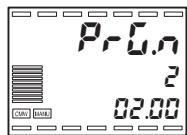
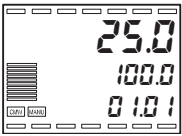

- (1) Hold down the Key for less than 1 second to move from the Operation Level to the Program Setting Level.

- (2) The Program Editing parameter will be displayed in the Program Setting Level. Select the number of the program to be edited. For example, to change the Segment Set Point and Segment Time parameters for program 2, use the and Keys to select 2.

- (3) Press the Key twice to display the Segment Editing parameter. Select the number of the segment to be edited. First, segment 1 parameters will be edited, so use the Key to select 1.

- (4) Press the Key for less than 1 second to display the Segment Set Point parameter for segment 1. Use the and Keys to set the Segment Set Point parameter for segment 1 to 50.0.

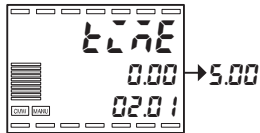

- (5) Press the Key for less than 1 second to display the Segment Time parameter for segment 1. Use the and Keys to set the Segment Time parameter for segment 1 to 5.00.

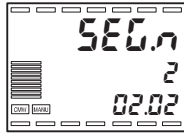

- (6) Press the Key several times to display the Segment Editing parameter again. This time the next segment number after the segment that was just edited will be displayed. Check that segment number 2 is displayed. (To edit segment 1 parameters again or to edit parameters for another segment number, use the and Keys to select the desired segment number.)

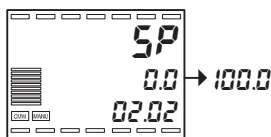

- (7) Press the Key for less than 1 second to display the Segment Set Point parameter for segment 2. Use the and Keys to set the Segment Set Point parameter for segment 2 to 100.0.

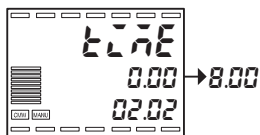

- (8) Press the Key for less than 1 second to display the Segment Time parameter for segment 2. Use the and Keys to set the Segment Time parameter for segment 2 to 8.00.

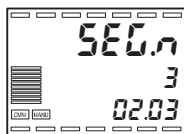

- (9) Press the Key several times to display the Segment Editing parameter again. Check that segment number 3, the next segment to be edited, is displayed.

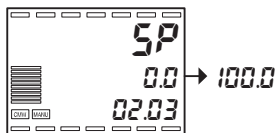

- (10) Press the Key for less than 1 second to display the Segment Set Point parameter for segment 3. Use the and Keys to set the Segment Set Point parameter for segment 3 to 100.0.

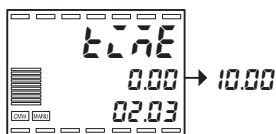

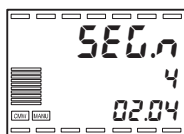

- (11) Press the Key for less than 1 second to display the Segment Time parameter for segment 3. Use the and Keys to set the Segment Time parameter for segment 3 to 10.00.



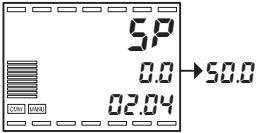

- (12) Press the Key several times to display the Segment Editing parameter again. Check that segment number 4, the next segment to be edited, is displayed.

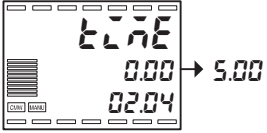

(13) Press the  Key for less than 1 second to display the Segment Set Point parameter for segment 4. Use the  and  Keys to set the Segment Set Point parameter for segment 4 to 50.0.



(14) Press the  Key for less than 1 second to display the Segment Time parameter for segment 4. Use the  and  Keys to set the Segment Time parameter for segment 4 to 5.00.

4.9 Performing ON/OFF Control

ON/OFF control consists of setting an SP and then having the control output turn OFF when the temperature reaches the SP during control. When the control output turns OFF, the temperature begins to fall, and once it falls to a certain point, the control output turns ON again. This action is repeated around a certain position. ON/OFF control requires setting the Hysteresis (Heating) parameter to the temperature drop from the SP where control output should turn ON. The Direct/Reverse Operation parameter is used to determine whether the MV is increased or decreased with respect to an increase or decrease of the PV.

■ ON/OFF Control

- On the E5AR-T/ER-T, switching between advanced PID control and ON/OFF control is accomplished by setting the Proportional Band parameter. When the proportional band is set to 0.00, ON/OFF control is performed, and when it is set to any value except 0.00, advanced PID control is performed. The default setting is 10.00.

● Hysteresis

- In ON/OFF control, hysteresis is added when switching between ON and OFF to stabilize operation. The width of the hysteresis is called simply the hysteresis. The hysteresis is set for both heating and cooling control output using the Hysteresis (Heating) and Hysteresis (Cooling) parameters.
- For standard control (heating or cooling control), only the Hysteresis (Heating) parameter is used, regardless of whether heating or cooling is being performed.

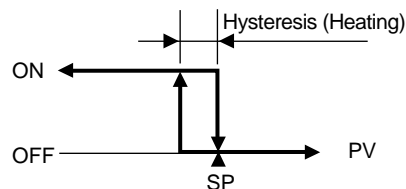

● Three-position Control

- For heating/cooling control, an area can be set where the MV is 0 for both heating and cooling. This area is called the dead band. This means that 3-position control can be performed.

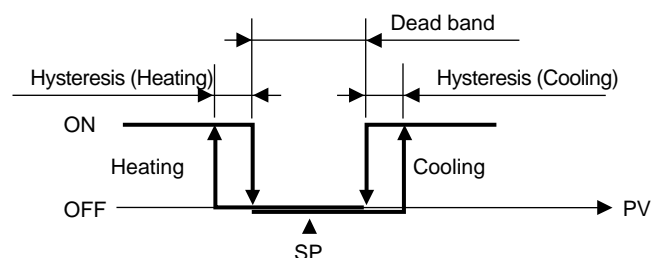

■ Settings

To perform ON/OFF control, the SP, Proportional Band, and Hysteresis (Heating) parameters must be set.

To ON/OFF control and an hysteresis (heating) of 2.00% FS, set the Proportional Band parameter to 0.00 in PID Setting Level to select ON/OFF control.

Setting ON/OFF Control (Proportional Band = 0.00)

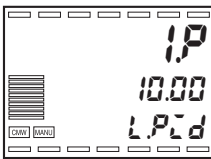
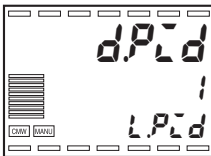
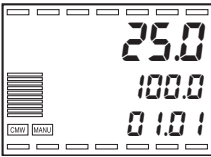

1. Press the Key repeatedly (less than 1 second each time) to move from the Operation Level to the PID Setting Level.
2. The PID Selection parameter is displayed in the PID Setting Level. If a PID set number will not be used, use the default setting (1). If a PID set number will be used, select the PID set number for the desired control.
3. Press the Key to display the Proportional Band parameter. Use the and Keys to set the value to 0.00
4. Press the Key repeatedly (less than 1 second each time) to return to the Operation Level.

Set the Hysteresis (Heating) parameter to 2.00 in the Adjustment Level.

Setting the Hysteresis

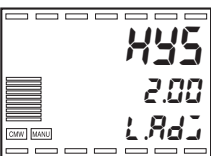
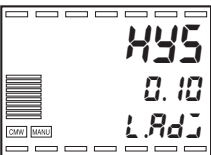
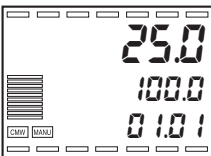

1. Press the Key for less than 1 second to move from the Operation Level to the Adjustment Level.
2. Press the Key repeatedly to select the Hysteresis (Heating) parameter.
3. Use the and Keys to set the value to 2.00.
4. Press the Key repeatedly (less than 1 second each time) to return to the Operation Level.

4.10 Determining the PID Constants (AT or Manual Settings)

■ Auto-tuning (AT)

- When AT is executed, the most suitable PID constants for the current SP are set automatically. This is accomplished by varying the MV to obtain the characteristics of the control object using the limit cycle method.

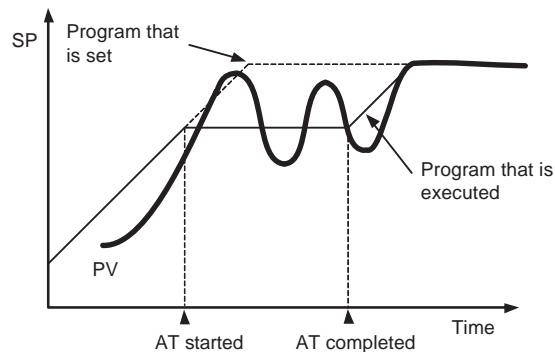

- The following operations are not possible during AT: Changing settings, holding or releasing the program, and segment operations, such as advance and back operations.
- AT will stop if the Run/Reset parameter is set to "Reset" and the Operation at Reset parameter is set to stop control, or if Manual Mode is entered.
- When executing AT, select 0 to execute AT for the PID set that is currently being used for control, or select 1 to 8 as to execute AT for a specific PID set.
- The results of AT will be reflected in PID Setting Level in the Proportional Band (P), Integral Time (I), and Derivative Time (D) parameters of the PID set number specified at the time AT was executed.

The following operation will be performed if the Operation at Reset parameter is set for fixed control.

- If the Run/Reset parameter is changed from "Run" to "Reset" during AT execution, the present SP will be changed to a fixed set point after AT has been completed.
- If AT is executed while the Run/Reset parameter is set to "Reset" and the Run/Reset parameter is changed from "Reset" to "Run" during AT execution, the set program will be started after completing AT for the fixed SP.

● Explanation of AT Operation

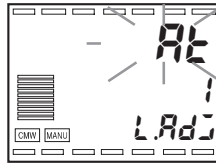
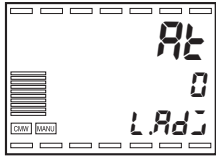
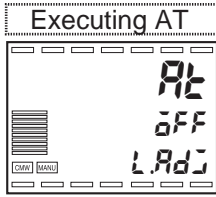

AT begins when the AT Execute/Cancel parameter is changed from OFF to 0.

While AT is being executed, AT flashes on Display No. 1. Display No. 2 shows the PID set number currently being used for control. When AT ends, the AT Execute/Cancel parameter goes OFF and the display stops flashing.

AT begins and the displays show the following:
 Display No. 1: Flashing display indicating AT is running.
 Display No. 2: Shows selected PID set number.

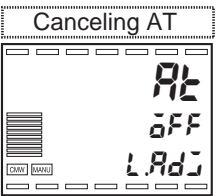

To stop AT, select OFF (AT Cancel).

During AT Execution

Present value (PV) / SP (Display 2)

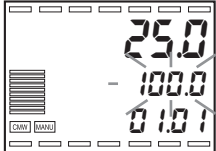

If you attempt to move to the Operation Level and display the PV or SP while AT is being executed, Display No. 2 will flash to indicate that AT is being executed.

- Only the Communications Writing, Run/Reset, AT Execute/Cancel, and Auto/Manual parameters can be changed while AT is running. No other settings can be changed.
- If the Run/Reset parameter is set to "Reset" while AT is being executed, AT will stop and operation will stop. If "Run" is then selected, AT will not resume.
- If an input error occurs while AT is being executed, AT will stop. AT will run again after recovery from the error.

■ Limit Cycle

The timing for generating a limit cycle depends on whether or not the deviation (DV) when AT is begun is less than the Temporary AT Excitation Judgement Deviation parameter (default: 10.0% FS).

The PV changes as follows during AT:

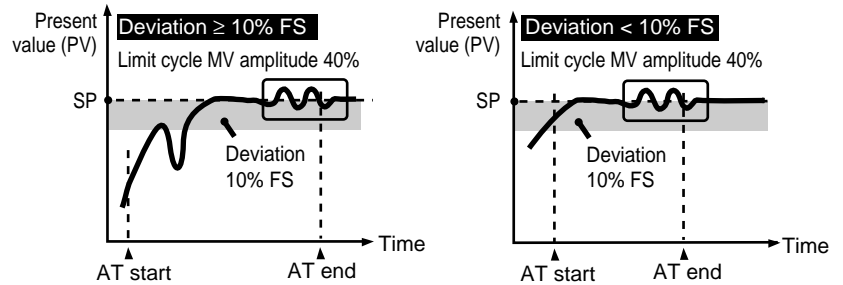

The amplitude of change of the limit cycle MV can be changed in the Limit Cycle MV Amplitude parameter.

For heating/cooling and position-proportional floating control, the limit cycle is as shown below regardless of the deviation.

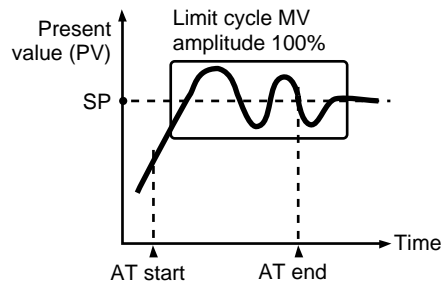



Manual Settings

To set the PID constants manually, set values for the Proportional Band (P), Integral Time (I), and Derivative Time (D) parameters

Supplement

- If you already know the control characteristics, directly set the PID constants to adjust control. The PID constants are set in the Proportional Band (P), Integral Time (I), and Derivative Time (D) parameters.
- I (integral time) and D (derivative time) can be set to 0 to select a proportional action. In the default settings, the Manual Reset Value parameter is set to 50.0% so that the proportional band is centered on the SP.

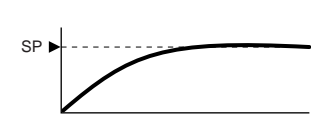
Changing P (Proportional Band)

When P is increased		A slow rise and a longer rectification time will occur, but there will be no overshoot.
When P is decreased		Overshoot and hunting will occur, but the SP will be reached quickly and stabilize.

Changing I (Integral Time)

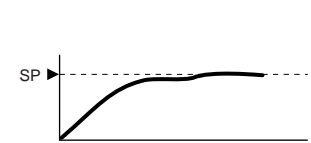
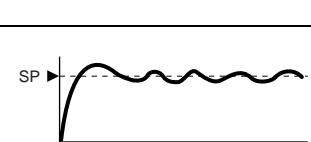
When P is increased		A longer time will be required to reach the SP. The rectification time will be longer, but there is less hunting, overshooting, and undershooting.
When P is decreased		Overshooting and undershooting will occur. Hunting will occur. A quick rise will occur.

Changing D (Derivative Time)

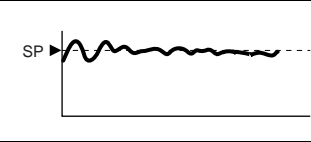
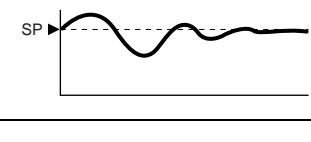
When P is increased		Less rectification time for overshooting and undershooting, but fine hunting will occur spontaneously.
When P is decreased		Overshooting and undershooting will be larger and more time will be required to return to the SP.

4.11 Using Auxiliary Outputs

The Auxiliary Output * Assignment, Alarm Type, Alarm Value, Alarm Upper Limit, Alarm Lower Limit, and Alarm Set Number parameters are described in this section.

■ Auxiliary Output Assignments

The type of data that is output from each auxiliary output can be assigned.

On Controller models with more than one output, data assignments can also be set for channels 2 and higher for the number of supported channels.

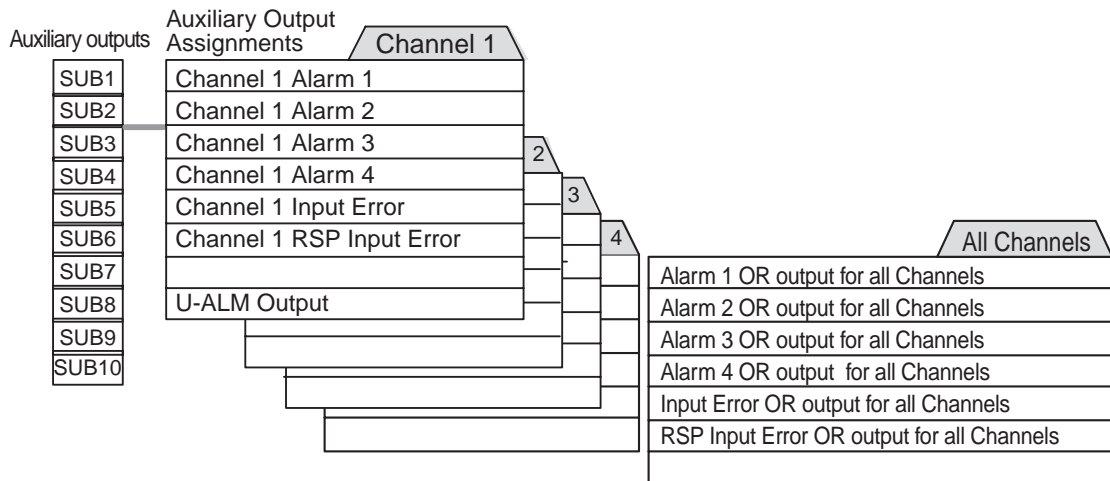

The U-ALM Output setting is an OR output of alarms 1 to 4 of all channels (overall alarm).

The default settings are as follows:

SUB1	SUB2	SUB3	SUB4
Channel 1 Alarm 1	Channel 1 Alarm 2	Channel 1 Alarm 3	Channel 1 Alarm 4

The E5ER-T□T□□ has only two auxiliary outputs, i.e., they do not have SUB3 and SUB4.

Alarm Types

SP = Set point

Set value	Alarm type	Alarm output function	
		Alarm value (X) is positive	Alarm value (X) is negative
0	Alarm function OFF	Output OFF	
*1	1 Upper-and lower-limit alarm		*2
	2 Upper-limit alarm		
	3 Lower-limit alarm		
*1	4 Upper-and lower-limit range alarm		*3
*1,*6	5 Upper-and lower-limit alarm with standby sequence	*5	*4
*6	6 Upper-limit alarm with standby sequence		
	7 Lower-limit alarm with standby sequence		
	8 Absolute-value upper-limit alarm		
	9 Absolute-value lower-limit alarm		
*6	10 Absolute-value upper-limit alarm with standby sequence		
*6	11 Absolute-value lower-limit alarm with standby sequence		

*1: Set values 1, 4, and 5: Allow upper and lower limits of alarm to be separately set. The upper and lower limits are indicated by L and H.

*2: Set value 1: Upper-and lower-limit alarm

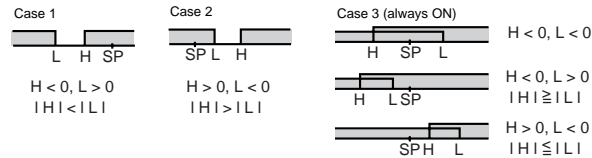

*3: Set value 4: Upper-and lower-limit range

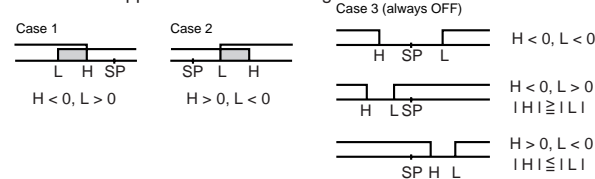

*4: Set value 5: Alarm with upper-limit and lower-limit with standby sequence

*With the above upper-and lower-limit alarms

- Cases 1 and 2:

If hysteresis overlaps the upper and lower limits, always OFF.

- Case 3: Always OFF.

*5: Set value 5: Alarm with upper-and lower-limit standby sequence

If hysteresis overlaps the upper and lower limits, always OFF.

*6: For information on standby sequences, refer to 5.6 Alarm Adjustment Functions.

Under the following conditions, the SP of segment 1 is used as the SP for deviation alarms.

- If the Operation at Reset parameter is set to stop control and the program is reset in Program SP Mode

- If the Operation at Reset parameter is set to stop control and the program is placed on standby in Program SP Mode

■ Alarm Values

Alarm values are indicated by “X” in the alarm type table. When separate upper and lower limits are set for an alarm, the upper limit value is indicated by “H” and the lower limit is indicated by “L.”

When an upper- and lower-limit alarm, upper- and lower-limit range alarm, or lower-limit alarm with standby sequence is selected, the Alarm Upper Limit and Alarm Lower Limit parameters must be set.

The Alarm Value parameter must be set when any other alarm type is selected.

■ Alarm Sets

- A group of alarm values is called an alarm set. The Alarm Set Number parameter is set for each program.
- Alarm set numbers can be set between 1 to 4. The default is 1. For channels 2 to 4 during coordinated operation and the secondary side (channel 1) during cascade control, however, alarm set numbers can be between 0 and 4. If 0 is selected, the alarm set number will be the same as the number selected for channel 1.

■ Settings

To output an alarm to an auxiliary output, the Auxiliary Output Assignment, Alarm Type, and Alarm Value parameters must be set.

To output a lower-limit alarm to auxiliary output 2 using channel 1 alarm 1 at an alarm value of 10.0°C, the Auxiliary Output 2 Assignment parameter is set to “CH 1 alarm 1” in the Control Initial Setting 2 Level.

Auxiliary Output 2 Assignment

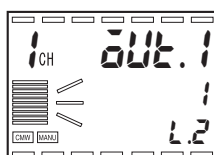
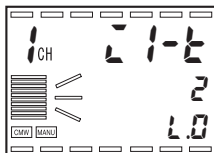
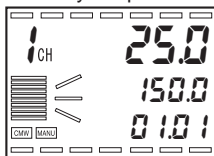

1. Hold down the Key for at least 3 seconds to move from the Operation Level to the Input Initial Setting Level.
2. In the Input Initial Setting Level, Display No. 3 will show **L.L.**. Press the Key twice (less than 1 second each time) to move to the Control Initial Setting 2 Level.
3. In the Control Initial Setting 2 Level, Display No. 3 will show **L.L.**. Press the Key repeatedly (less than 1 second each time) to select the Auxiliary Output 2 Assignment parameter.

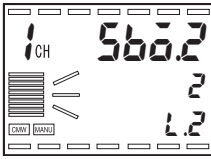

- Press the to set the Auxiliary Output 2 Assignment parameter to 1 (CH 1 Alarm 1).

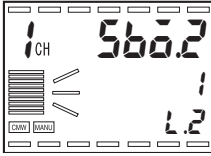

Set Alarm 1 Type parameter to a “Lower-limit Alarm” in the Alarm Setting Level.

Alarm 1 Type

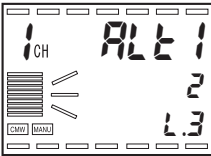

Alarm 1 type

- Press the Key for less than 1 second to move to the Alarm Setting Level.

The display will show the Alarm 1 Type parameter.

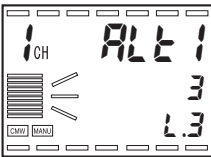

- Press the Key to select 3 (Lower-limit Alarm).

Set the Alarm Set Alarm Value 1 parameter to 10.0°C in the Alarm Set Setting Level.

Alarm Value

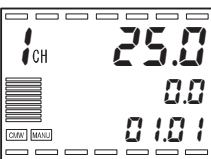

- Hold down the Key for at least 1 second to move to the Operation Level.

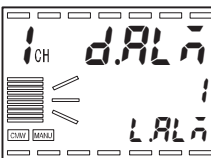

- Press the Key three times (less than 1 second each time) to move to the Alarm Set Setting Level.

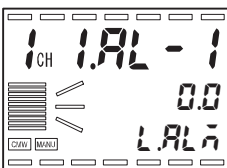

Alarm Set 1 Alarm Value 1

→ 10.0

- Press the Key repeatedly to select the Alarm Set 1 Alarm Value 1 parameter.

Press the Key to change the set value to 10.0.

4.12 Starting and Stopping Operation

■ Starting Operation (Run) and Stopping Operation (Reset)

To start program operation, set the Run/Reset parameter to “Run.” To stop program operation, set the Run/Reset parameter to “Reset.” Program execution will stop if the Hold parameter is set to “ON.”

● Operation at Reset

The operation status when the Run/Reset parameter is set to “Reset” can be selected. The two operation statuses outlined below can be selected by using the Operation at Reset parameter.

• Operation at Reset Parameter Set to “Control Stop”

The following diagram shows the status transition when the Operation at Reset parameter is set to “control stop.”

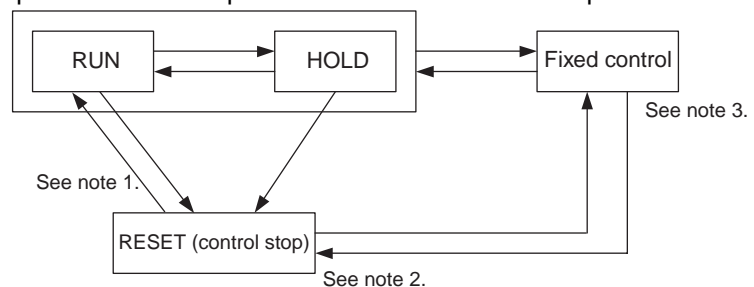

Note1: Program operation starts from the segment 1 SP.

2: Control is stopped while resetting.

3: The status switches to fixed control in SP mode.

Control stop is held when the mode is shifted to fixed control (Fixed SP Mode) or Remote SP Mode during the reset.

- When using Standard Models, set the MV at Reset parameter to between -5.0% and 105.0% to output during reset. The default is 0.0% . (For heating/cooling control, set the MV at Reset parameter to between -105.0% and 105.0% .)
- When using the Position-proportional Models, fully open, fully closed, or hold status can be selected using the MV at Reset parameter. In open status, only the output on the open side is ON. In closed status, only the output on the closed side is ON. In hold status, the outputs on both the open and closed sides are OFF. The default setting is “hold.”
- Operation at Reset Parameter Set to “Fixed Control”
The following diagram shows the status transitions when the Operation at Reset parameter is set to “fixed control.”

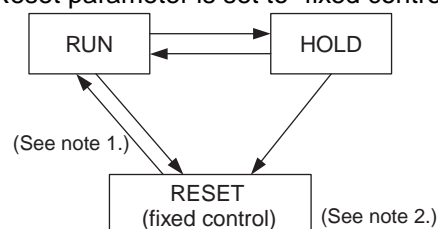

Note1:The program moves into Program SP Mode and program operation starts from the fixed SP.

2:Control does not stop. Control is executed for the fixed SP. (The program moves into Fixed SP Mode.) Control is executed for the remote SP when the program moves into Remote SP Mode.

- If the Operation at Reset parameter is set to “fixed control,” the first segment will become a ramp segment.
- The following table shows example settings.

Segment No.	1	2	3	---
Segment SP	100.0	100.0	50.0	---
Segment Time (h:min)	8:00	10:00	5:00	---

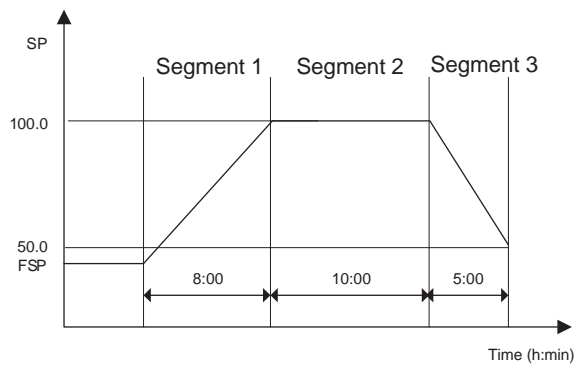

● Operation at Power ON

- This parameter determines the operating status when the power to the E5AR-T/ER-T is turned ON. The following 5 selections are possible.

Setting	Operation
Continue	The status of the system before the power was turned OFF is resumed.
Reset	Control is always reset status when the power is turned ON.
Manual Mode	Manual Mode is entered when the power is turned ON.
Run	The program is always executed from the beginning when the power is turned ON.
Ramp back	The SP starts from the present value when the power is turned ON and ramp operation is performed with the previous ramp slope.

- The following table shows what values are held depending on the Operation at Power ON parameter setting.

Parameter	Continue (See note 1.)	Reset	Manual	Run
Program No.	Held	Held	Held	Held
Segment No.	Held	---	Held	---

Parameter	Continue (See note 1.)	Reset	Manual	Run
Elapsed Program/ Segment Time	Held	---	Held	---
Program Repetitions	Held	---	Held	---
Hold Status	Held	---	Held	---
Auto/Manual	Held	Held	---	Held
Manual MV (See note 3.)	Held	Held	Held (See note 4.)	Held
Run/Reset	Held	---	Held	---

Note1: Including “Ramp Back.”

2: If a PV start causes an invalid period, time will be considered to have elapsed for the invalid period.

The elapsed program and segment timers will operate as outlined below when “Ramp Back” has been set for the Operation at Power ON parameter:

- If power is interrupted while soaking, the timer will stop until the present SP returns to the segment SP.
- If power is interrupted during ramp operation, the timer is restarted using the PV immediately after power is restored as the PV when power was interrupted.

3: For the Standard Models in Manual Mode at the power interruption.

4: If power is interrupted in Auto Mode, the value set for the MV at Reset parameter will be output, unless the Manual Output Method parameter is set to “Output Initial Value.” If the Manual Output Method parameter is set to “Output Initial Value,” the value set for the Manual MV Initial Value parameter will be output.

5: For coordinated operation, the channel 1 values for the Program No., Segment No., Elapsed Program Time, Elapsed Segment Time, Program Repetitions, and Hold Status parameters will be used for the other channels.

- The default setting for the Operation at Power ON parameter is “Continue.”
 - Set the Operation at Power ON parameter for each channel.
 - If the control mode is set to cascade control, set the Operation at Power ON parameter for channel 2.
- The operation when the Operation at Power ON parameter is set to “Ramp Back” is described below.

- Power Interrupted during a Soak Segment

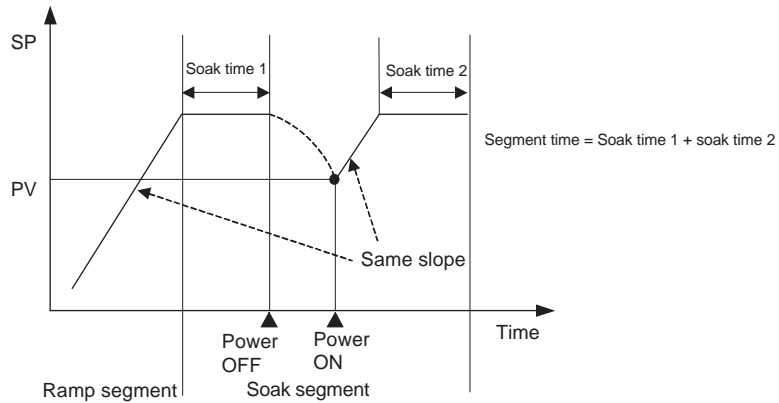

If power is interrupted during a soak segment and then restored, the ramp slope for the immediately preceding ramp segment is continued and ramp operation is executed from the PV immediately after power is restored to the target SP.

- If there is no ramp segment before the power interruption, the PV immediately after the power is restored will be held as the present SP and operation will be executed as a soak segment.

The ramp slope of the immediately preceding ramp segment is continued even if the program direction (temperature increasing/decreasing) is different from the ramp segment. Ramp operation is executed from the PV immediately after power is restored to the target SP.

If an input error occurs when the power is restored, control is executed using the SP of the soak segment when power was interrupted.

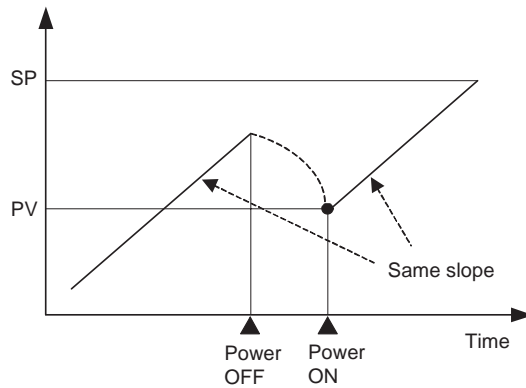

- Power Interrupted during a Ramp Segment

If power is interrupted during a ramp segment, the PV when power is restored will be used as the start point for the present SP and ramp operation will be executed at the ramp slope before the power interruption.

The ramp operation using the same ramp slope is the same as when the Step Time/Rate of Rise Programming parameter is set to “step time.” The time taken to reach the target SP will not match the set segment time.

The ramp slope of the immediately preceding ramp segment is continued even if the program direction (temperature increasing/decreasing) is different from the ramp segment.

If an input error occurs when power is restored, the program moves to the next segment.

The program timer value is held until the program returns to the status before the power was interrupted.

- Power Interrupted in Fixed SP or Remote SP Mode

Ramp operation is not executed for a fixed SP or remote SP if the power is interrupted in Fixed SP Mode or Remote SP Mode.

■ Other

- The timer continues when the mode is changed to Manual Mode during program operation.
- The timer continues if an input error occurs during program operation.
- In setting area 1, the time signal, segment output, program end output, and segment number output are all OFF.
- The program operation is also reset if the Run/Reset parameter for the secondary side (channel 2) is set to "Reset" when using cascade control.

■ Settings

The following procedure is used to stop program operation.

◆ “Run/Reset Selected for the PF1 Setting or PF2 Setting Parameter

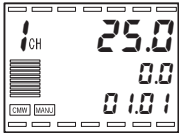

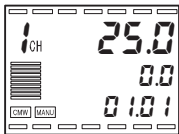

1. Press the PF Key for which Run/Reset has been specified for at least 1 second. The RST indicator will light and the program will stop.
To start operation again, press the same PF Key for at least 1 second again. The RST indicator will turn OFF and the program will start operation.

◆ “Run/Reset” Not Selected for the PF1 Setting or PF2 Setting Parameter

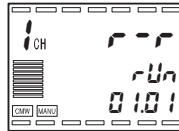

- (1) Press the  Key several times to select *r-r*: Run/Reset.



- (2) Press the  Key to switch to *r-st*: Reset. The RST indicator will light and the program will stop.
To restart the program, use the same procedure to switch to *r-rn*: Run. The RST indicator will turn OFF and the program will start.

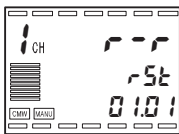

Hint

Switching between run and reset is also possible using an event input or communications.
For event inputs, refer to *5.8 Using Event Inputs* (P. 5-39).
For communications, refer to *5.10 Using Communications* (P. 5-49).

4.13 Manual Operation

■ Manual Mode

● Standard Control Models

- In standard control, the MV is manipulated, and in position-proportional control, the amount of valve opening is manipulated.
- To perform manual operation or to manually set the MV or valve opening, set the Manual/Auto parameter to $\bar{\text{MANU}}$ (Manual), or set the PF Setting parameter to $\bar{\text{P}}-\bar{\text{A}}$ (Auto/Manual) and then hold down the PF Key for at least 1 second.
- The MANU operation indicator lights in Manual Mode. The PV is displayed on Display No. 1, the MV is displayed on Display No. 2, and $\bar{\text{MANU}}$ is displayed on Display No. 3.
- To change the MV, press the \boxtimes and \boxminus Keys. The MV is updated every 50 ms.
- When switching between Manual Mode and Auto Mode, the action of the MV is balance-less and bumpless.
- Other setting levels can be moved to in Manual Mode. However, the AT Execute/Cancel parameter cannot be selected and does not appear on the display.
- Switching between auto and manual is possible a maximum of 100,000 times.
- If switching is performed more than 100,000 times, the auto/manual settings will not be written to EEPROM.
- During cascade control, if the primary loop is switched to manual control when the secondary loop is in any of the following conditions, the manual MV is disabled.
 - The secondary loop is in Local SP Mode (cascade open).
 - The secondary loop is in Manual Mode.
 - The operation set for an error is being performed for the secondary loop.

● Position-proportional Control Models

- When a potentiometer is connected, MANU operation indicator lights in Manual Mode. The PV is displayed on Display No. 1, the valve opening is displayed on Display No. 2, and $\bar{\text{MANU}}$ is displayed on Display No. 3. When a potentiometer is not connected, Display No. 2 shows “-----”.
- To turn ON the open output, press the \boxtimes Key. To turn ON the close output, press the \boxminus Key. The MV is updated every 50 ms.
- When switching between Manual Mode and Auto Mode, the action of the MV is balance-less, bumpless.
- Other setting levels can be moved to in Manual Mode. However, the AT Execute/Cancel parameter cannot be selected and does not appear on the display.

- Switching between auto and manual is possible a maximum of 100,000 times.
- If switching is performed more than 100,000 times, the auto/manual settings will not be written to EEPROM.

The procedure for switching to Manual Mode during control and changing the MV is given below.

◆ Auto/Manual Set for PF1 or PF2 Setting

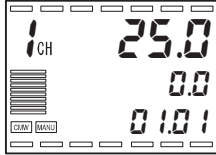

1. Hold down the PF Key set to switch between auto and manual at least 1 second. The MANU indicator will light and the mode will change to Manual.

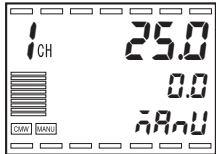

To return to Auto Mode, hold down the PF Key for at least 1 second. The MANU indicator will go OFF and the mode will change to Auto Mode.

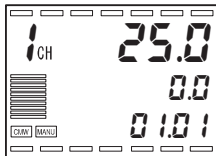

◆ Auto/Manual Not Set for PF1 or PF2 Setting

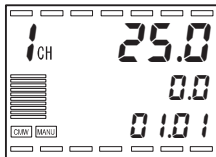

1. Press the  Key repeatedly to select A- \bar{a} (Auto/Manual).

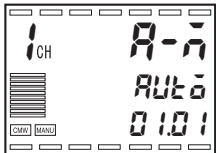

2. Press the  Key to switch to MANU (Manual). The MANU indicator will light and the mode will change to Manual.

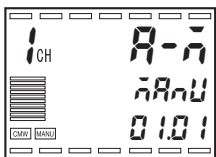

To resume control, follow the same procedure to switch back to AUTO (Auto). The MANU indicator will go OFF and the mode will change to Auto Mode.

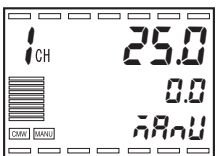

Hint

Switching between Auto and Manual Mode is also possible using an event input or communications. For event inputs, refer to 5.8 Using Event Inputs (P. 5-39). For communications, refer to 5.10 Using Communications (P. 5-49).

4.14 Changing Channels

■ Changing Channels

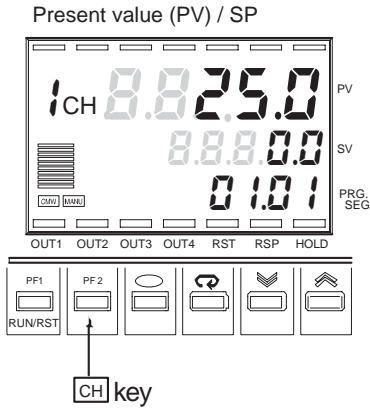

- On Controllers with more than one input, the channel number increases by 1 each time the **CH** Key is pressed and the displayed channel changes accordingly.
- Only channels that are enabled with the Number of Enabled Channels parameter can be displayed.
- If the Number of Enabled Channels parameter is set to 2 on a 4-point input type, the display will switch through the channels as follows each time the **CH** Key is pressed:
Channel 1 → Channel 2 → Channel 1 → Channel 2...

● Level after Changing Channels

- When changing channels, the level will remain the same as the level currently being displayed.
- When a Manual Mode channel is selected, the display will show the manual operation display in the Operation Level.

● Displayed Parameter after Changing Channels

- The displayed parameter after changing channels is as follows:
 1. If the parameter that is currently being displayed will continue to be displayed if it is enabled for the new channel.
 2. If the parameter that is currently being displayed is not enabled for the new channel because the control method is different or for any other reason, the next enabled parameter will be displayed.

The following is an example of changing channels in the Operation Level.

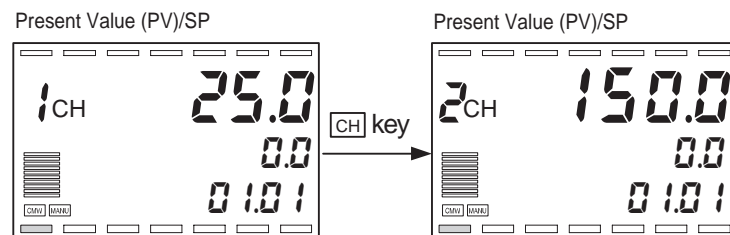

* The CH key is disabled on models with only one channel.

* Parameter for selected channel appears.

Hint

If you continue to hold down the **CH** Key after changing channels, you will not move to the next channel. To continue changing channels, release and press the **CH** Key again.
For more information, refer to *5.4 Display and Key Adjustment Functions* (P. 5-18).

4.15 Adjusting Programs

The temperature vector will change if the program is changed during operation when step time operation is used. This section describes the vector changes.

■ Changing the SP

If the SP is changed during a segment, the present SP will move in a straight line with the changed SP as the target point.

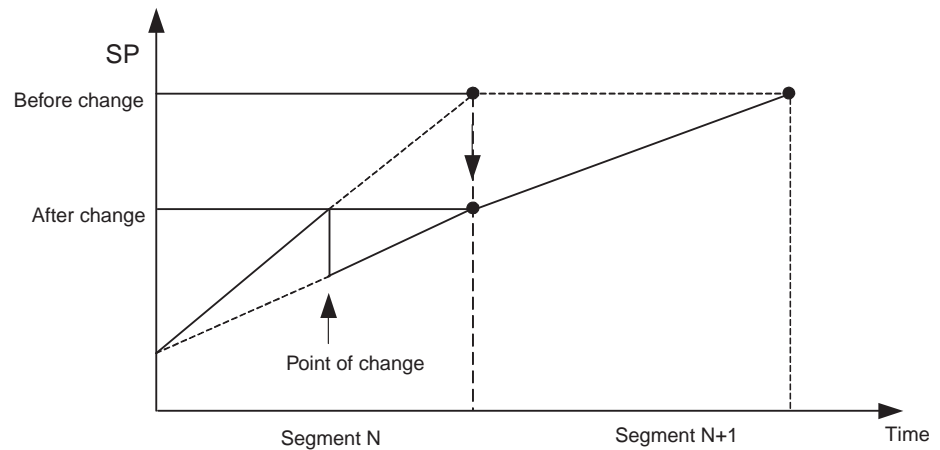

■ Changing the Time

If the time is changed during a segment, the slope of the line along which the present SP moves will change because the time taken to reach the target will change.

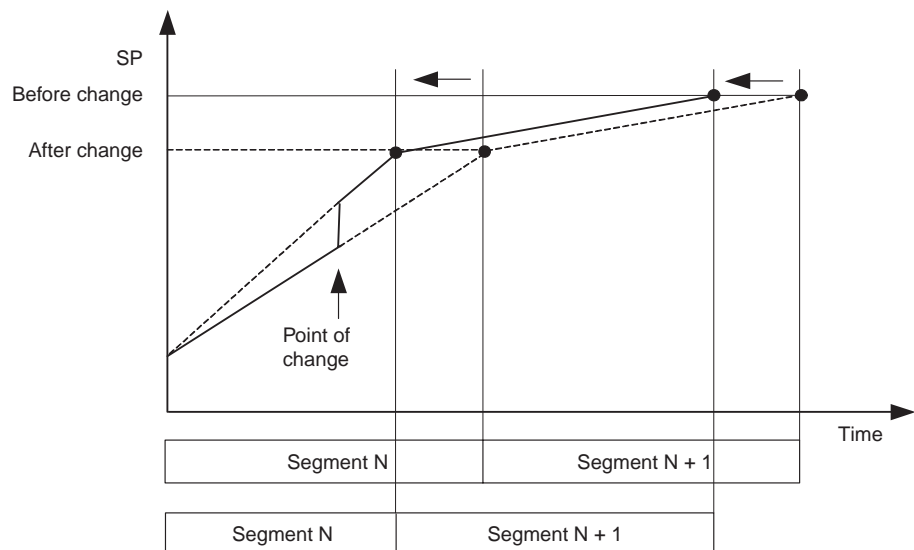

If the segment time after the change is shorter than the elapsed segment time, the program will immediately move to the next segment.

4.16 Operating Precautions

- (1) About four seconds is required for the outputs to turn ON after the power is turned ON. Take this into consideration when incorporating the Controller into a sequence circuit.
- (2) Using the Controller near radios, televisions, or other wireless devices may cause reception interference.

Section 5 *Functions and Operations*

5.1	Input Adjustment Functions	5-2
5.2	Control Functions	5-8
5.3	Output Adjustment Functions	5-15
5.4	Display and Key Adjustment Functions	5-18
5.5	Protecting Settings	5-23
5.6	Alarm Adjustment Functions.....	5-25
5.7	Program Operation Functions.....	5-28
5.8	Using Event Inputs.....	5-39
5.9	Using a Transfer Output.....	5-47
5.10	Using Communications.....	5-49

5.1 Input Adjustment Functions

Input Correction

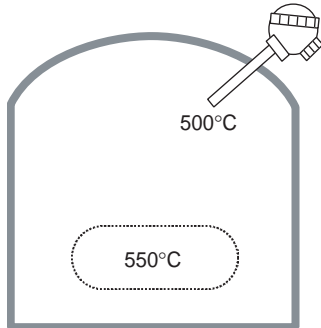

Two-point Correction

8252.1	Input Value 1 for Input Correction
8252.2	Input Value 2 for Input Correction
8255.1	Input Correction 1
8255.2	Input Correction 2

- The input value can be corrected using a 2-point correction.
- A temperature difference that occurs due to the positioning of the control sensor in respect to the position where the temperature is required can be rectified using the input correction values.

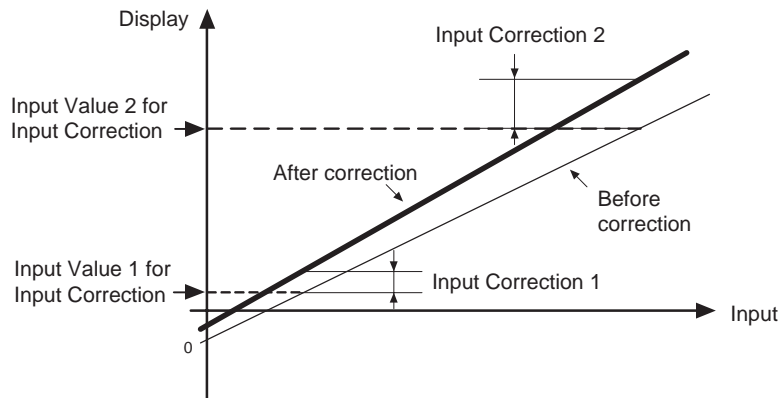

Parameter	Setting range	Unit	Default value
Input Value 1 for Input Correction	-19999 to 99999	EU	-200.0
Input Value 2 for Input Correction	-19999 to 99999	EU	1300.0
Input Correction 1	-199.99 to 999.99	EU	0.00
Input Correction 2	-199.99 to 999.99	EU	0.00

- Straight-line correction is accomplished by setting the Input Correction 1 parameter to the desired value for the input value set in the Input Value 1 for Input Correction parameter and setting the Input Correction 2 parameter to the desired value for the input value set in the Input Value 2 for Input Correction parameter. Different degrees of correction may be required for the Input Correction 1 and Input Correction 2 parameters and thus the slope of the line between the two points may differ before and after correction.
- Input correction is set separately for each channel. The input correction settings for inputs 1 to 4 of a Controller with more than one input correspond to channels 1 to 4. First select a channel with the **[CH]** Key and then set the corresponding input correction values.

● Obtaining Input Correction Values for 2-point Correction

Preparations

Temperature readings are taken using the E5AR-T/ER-T at any two points: the actual temperature at the required location (the object) and the present temperature of the E5AR-T/ER-T.

1. Set the input type based on the sensor.
2. Obtain a temperature sensor that can measure the temperature of the object as shown in Figure 1.

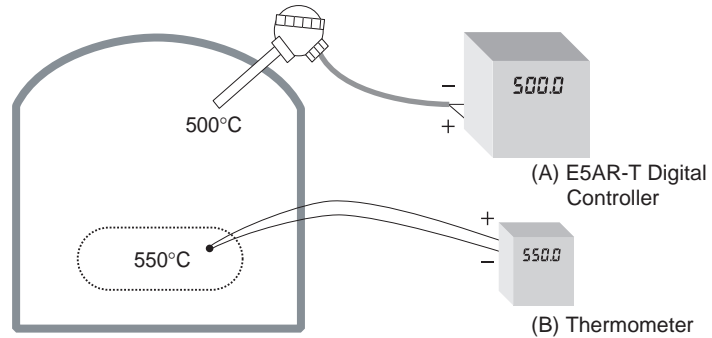

Figure 1. Configuration for Input Correction

● Procedure for Using a 2-point Correction

1. Correction will be performed based on the temperature readings at two points: one near room temperature and one near the desired SP. Measure the temperature of the object when it is near room temperature and when it is near the SP (B), and check the corresponding readings of the Controller (A) at the same temperatures.
2. Set the Input Correction 1 parameter to the difference between the temperature of the object (B) and the Controller reading (A) when near room temperature,

$$\text{Object temperature (B) - Controller reading (A)}$$

and set the Input Value 1 for Input Correction parameter to the Controller reading (A).

3. Set the Input Correction 2 parameter to the difference between the temperature of the object (B) and the corresponding Controller reading (A) when near the SP,

$$\text{Object temperature (B) - Controller reading (A)}$$

and set the Input Value 2 for Input Correction parameter to the Controller reading (A).

4. After making the settings, check the reading of the Controller (A) and the temperature of the object (B).
5. Correction has now been performed at two points, near room temperature and near the SP. If you wish to improve the accuracy near the SP, establish two more correction points above and below the SP. Figure 2 illustrates the correction.

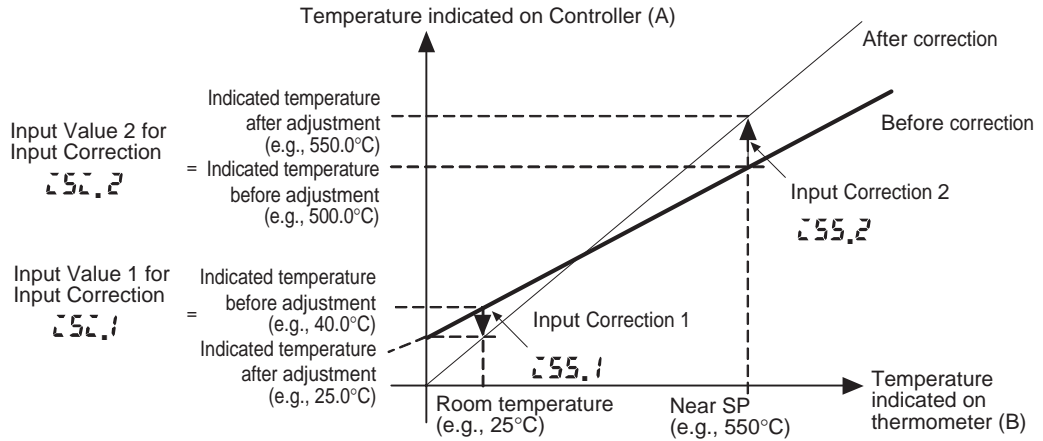

Figure 2. Two-Point Correction

● **Example of 2-point Correction**

The following example for a K typing input (1) from -200 to 1300°C.

- The temperature of the object is obtained.

Input Value 1 for Input Correction

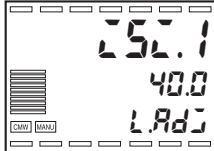

Input Shift 1

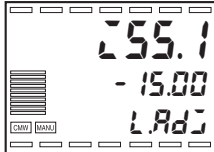

Input Value 2 for Input Correction

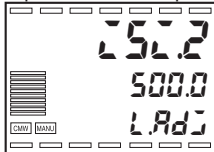

Input Shift 2

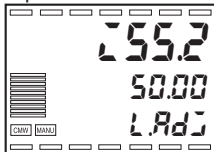

At room temperature ((B) = 25°C),
the Controller reading is (A) = 40.0°C

Near the SP ((B) = 550°C),
the Controller reading is (A) = 500.0°C

- In this case, the input correction values are obtained as follows:

Input Value 1 for Input Correction = Controller reading (A) = 40.0 (°C)

Input Correction 1
= Temperature of object (B) – Controller reading (A)
= 25 – 40 = -15.00 (°C)

Input Value 2 for Input Correction = Controller reading (A) = 500.0 (°C)

Input Correction 2
= Temperature of object (B) – Controller reading (A)
= 550 – 500 = 50.00 (°C)

■ First Order Lag Operation

First Order Lag Operation 1 Enabled

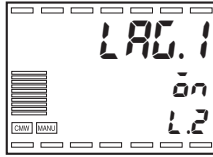

First Order Lag Operation 1 Time Constant

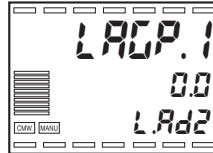

- A first order lag operation serves as a filter for an input. For a Controller with more than one input, the operation is set for each of inputs 1 to 4 in the First Order Lag Operation 1 to 4 parameters.
- To use a first order lag, set the First Order Lag Operation Enabled parameter to "ON" (the default setting is OFF). The First Order Lag Operation Time Constant parameter must also be set, and it is set so that the result of the operation is 0.63 times the input data.

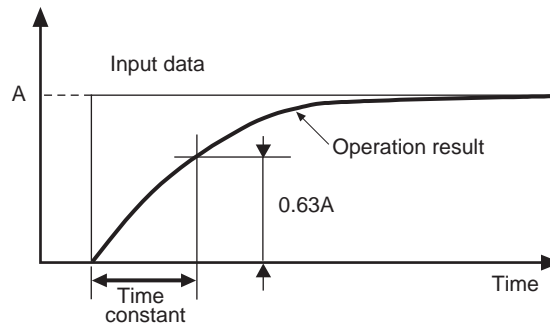

Parameter	Setting range	Unit	Default value
First Order Lag Operation 1 to 4 Enabled	OFF: Disabled, ON: Enabled	–	OFF
First Order Lag Operation 1 to 4 Time Constants	0.0 to 999.9	s	0.0

■ Moving Average

Movement Average 1 Enabled

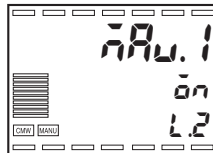

Move Average 1 Move Average Count

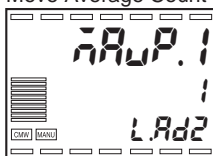

- The moving average operation reduces sudden changes in the input due to noise and other factors, and can be enabled separately for each input.
- To use the moving average operation, set the Movement Average Enabled parameter to "ON" (the default setting is OFF).
- A count must also be selected in the Move Average 1 to 4 Move Average Count parameter. Selections are 1, 2, 4, 8, 16, and 32 times.

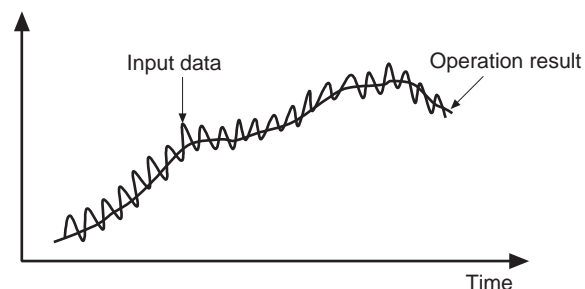

Parameter	Setting range	Unit	Default value
Movement Average 1 to 4 Enabled	OFF: Disabled, ON: Enabled	–	OFF
Move Average 1 to 4 Move Average Count	1, 2, 4, 8, 16, 32	Times (count)	1

Broken-line Approximation

Broken-line approximation is used to correct non-linearity in the input. Twenty broken-line approximation points can be set for input 1.

To use broken-line approximation, set the Broken-line Approximation enabled parameter to "ON" (the default setting is OFF).

Broken-line approximation includes the Broken-Line Approximation 1 Inputs 1 to 20 and Broken-line Approximation 1 Outputs 1 to 20 parameters. Normalized data is used to set the values so that the lower limit of the input setting range for input 1 is 0.000 and the upper limit is 1.000.

● Relation to Input Types

Broken-line Approximation 1 Enabled



Broken-line Approximation 1 Input 1



Broken-line Approximation 1 Output 1

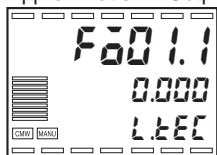

- Normalized data is used to set the values for broken-line approximation so that the lower limit of the input setting range for input 1 is 0.000 and the upper limit is 1.000. For example, if the input type of input 1 is J (2) (-20.0 to 400.0°C) and the broken-line approximation is to be applied to one point, 190.0°C, the values are set as follows:

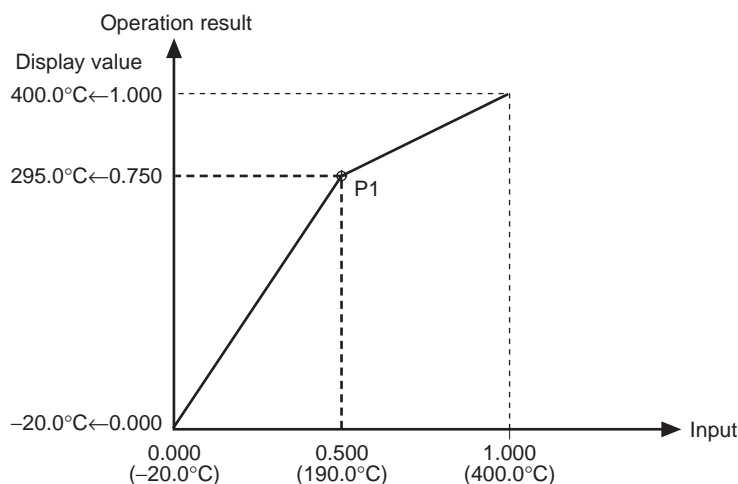

- Broken-line Approximation 1 Input 1 = 0.000
- Broken-line Approximation 1 Output 1 = 0.000
- Broken-line Approximation 1 Input 2 = 0.500
- Broken-line Approximation 1 Output 2 = 0.750
- Broken-line Approximation 1 Input 3 = 1.000
- Broken-line Approximation 1 Output 3 = 1.000

Parameter	Setting range	Unit	Default value
Broken-line Approximation 1 Enabled	OFF: Disabled, ON: Enabled	–	OFF
Broken-line Approximation 1 Input 1 to Broken-line Approximation 1 Input 20	-1.999 to 9.999	–	0.000
Broken-line Approximation 1 Output 1 to Broken-line Approximation 1 Output 20	-1.999 to 9.999	–	0.000

■ Extraction of Square Root

Extraction of Square Root
1 Enabled

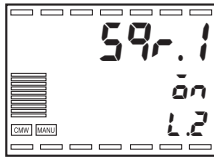

Extraction of Square
Root 1 Low-cut Point

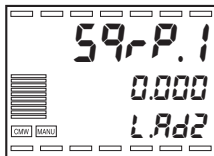

- An extraction of square root operation is supported for each input to allow direct input of the signal from a pressure differential flow meter.
- To use the extraction of square root operation, set the Extraction of Square Root Enabled parameter to “ON” (the default setting is OFF).
- The extraction of square root function includes an Extraction of Square Root Low-cut Point parameter that will set the result to 0 when the result of the operation is below the low-cut point. The low-cut point is set for each input using normalized data so that the lower limit of the input setting range is 0.000 and the upper limit is 1.000.

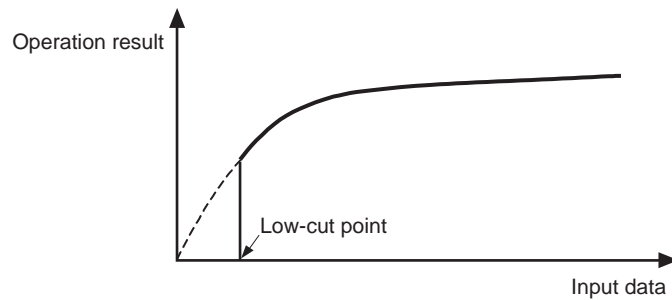

Parameter	Setting range	Unit	Default value
Extraction of Square Root 1 to 4 Enabled	OFF: Disabled, ON: Enabled	–	OFF
Extraction of Square Root Low-cut Point 1 to 4	0.000 to 9.999	EU	0.000

■ Other Input Adjustments

The following input adjustment functions are also available. These functions are explained in *Section 8 Parameters (P. 8-1)*.

- Sensor Induction Noise Reduction: Input Initial Setting Level
- PV Decimal Point Display: Input Initial Setting Level

5.2 Control Functions

■ Alarm Sets

- Up to 4 alarm sets with registered alarm values can be created.

Alarm set number	1	2	...	4
Alarm Values 1 to 4	240.0	300.0		
Alarm Upper Limits 1 to 4	40.0	30.0		
Alarm Lower Limits 1 to 4	40.0	30.0		

● Alarm Values

Alarm Set 1 Alarm Value 1

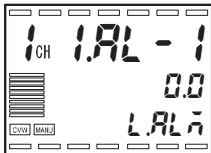

Alarm Set 1
Alarm Upper Limit 1

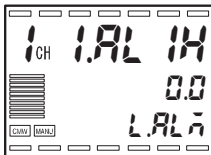

Alarm Set 1 Alarm Lower Limit 1

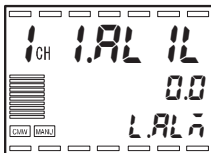

- The alarm values for alarms 1 to 4 are set according to the alarm type. Alarms for which the Alarm Type parameter is set to 0 (“No Alarm”) will not be displayed.
- Refer to 4.11 *Using Auxiliary Outputs* (P. 4-37) for information on how to set parameters.
- The first number in the setting is the alarm set number.

● Procedure

This section describes how to set the Alarm Set 2 Alarm Value 1 parameter. The settings in the following table are used as an example.

Alarm set number	1	2	...	4
Alarm Value 1		250.0		

Operation Level

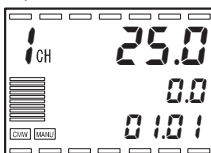

Operation Level (PV/SP)

Display Alarm Set Selection



- (1) Press the \square Key repeatedly to move to the Alarm Set Setting Level parameter (Display No. 3 will show $L.AL \bar{n}$).
- (2) Use the \blacktriangle and \blacktriangledown Keys to set the Display Alarm Set Setting Selection parameter to 2.

Alarm Set 2 Alarm Value 1

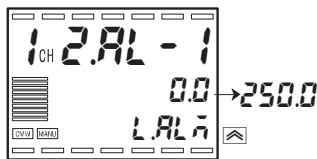

- (3) Press the \square Key to select the Alarm Set 2 Alarm Value 1 parameter.
- (4) Use the \blacktriangle and \blacktriangledown Keys to set the value to 250.0.

■ SP Limits

SP Upper Limit

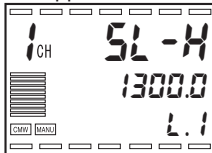

SP Lower Limit

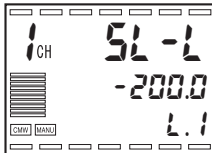

SP upper and lower limits can be set within the input setting range.

If an SP limit is changed so that the SP is outside of the limit, the previous SP set value will be automatically changed to the new value of the SP limit.

Example: Initially, the SP is 200°C, the SP upper limit is 300°C, and the SP lower limit is 100°C. If the SP upper limit is changed to 150°C, the SP will fall outside of the SP limit range of 100 to 150°C, and thus will be changed to 150°C.

If the Input Type, Temperature Unit, or scaling parameters are changed, the SP upper and lower limits will be reset to the upper and lower limits of the input setting range.

The SP limits are set separately for each channel.

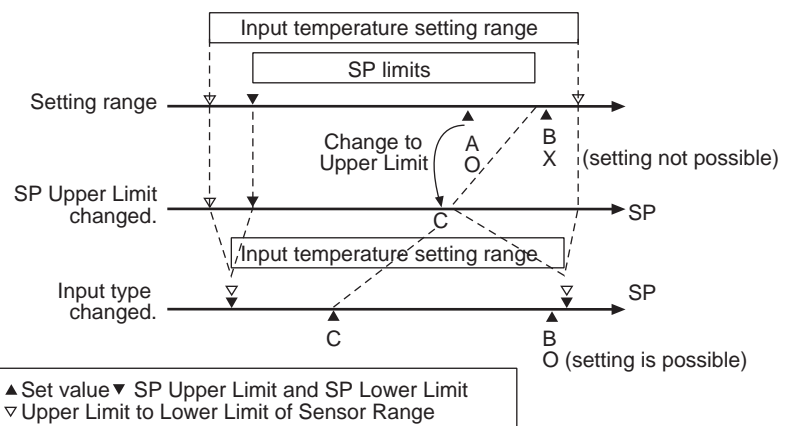

■ PID Sets

The E5AR-T/ER-T allows parameters to be grouped for use in PID control. A group of parameters is called a PID set. A PID set consists of the following parameters.

PID set number	1	2	...	8
P (Proportional Band)	20.50	35.70		
I (Integral Time)	240.0	300.0		
D (Derivative Time)	40.0	30.0		
MV Upper Limit	105.0	95.0		
MV Lower Limit	-5.0	5.0		
Automatic Selection Range Upper Limit	200.0	400.0		

- Select the PID set number in the Display PID Selection parameter of the PID Setting Level, and set the value for each PID constant.

● Procedure

Display PID * Selection

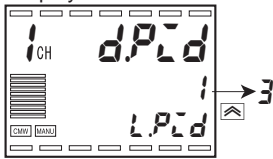

Set the P (Proportional Band) parameter of PID set 3 to 50.00% FS.

1. Press the Key repeatedly to move to the PID Setting Level (Display No. 3 will show $L.PId$).
2. Use the \uparrow and \downarrow Keys to set the Display PID Selection parameter to 3.
3. Press the \square Key to select the PID 3 Proportional Band parameter. To check the PID set number, use the leading digit of the parameter.
4. Use the \uparrow and \downarrow Keys to set the value to 50.00.

PID 3 Proportional Band

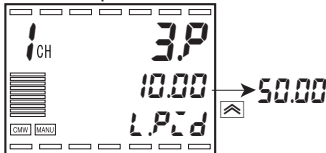

● Automatic Selection of the PID Set

- One of the PID set numbers 1 to 8 can be set in the PID Set Number parameter in the Program Setting Level. If the PID Set Number parameter is set to 0, the PID set will be automatically selected (PID Set Automatic Selection).
- If the PID Set Number parameter is set to 0 for channels 2 to 4 during coordinated operation or for the secondary side (Channel 2) during cascade control, the PID set number selected for channel 1 will be used.
- If the PID Set Number parameter is set to 0, the PID set will be automatically selected based on the pre-set conditions (PID Set Automatic Selection).

PID set	Automatic Selection Range Upper Limit
1	200.0
2	400.0
3	500.0
4	600.0
5	700.0
6	800.0
7	1000.0
8	1300.0

PV (present value (PV)) 24.00

Internal fixed value: 999.9% FS

In the example at left, the PID Set Automatic Selection Data parameter is set to "PV."

When $PV \leq 200.0^{\circ}\text{C}$, PID Set 1 is used

When $200.0 < PV \leq 400.0^{\circ}\text{C}$, PID Set 2 is used

The PID Automatic Selection Range Upper Limit parameters are set so that the values increase as the PID set numbers increase.

The value for PID set 8 is internally fixed so that the Automatic Selection Range Upper Limit parameter is set to 999.9% FS.

To prevent chattering when changing PID sets, hysteresis can be set in the PID Set Automatic Selection Hysteresis parameter.

The PV, DV (deviation), or SP can be set for the PID Set Automatic Selection Data parameter.

Parameter	Setting range	Unit	Default value
PID Set Number	0: Automatic 1 to 8: PID Sets 1 to 8	–	0
PID Sets 1 to 8 Automatic Selection Range Upper Limit	–19999 to 99999	EU	1450.0
PID Set Automatic Selection Data	0: PV, 1: DV, 2: SP	–	0: PV
PID Set Automatic Selection Hysteresis	0.10 to 99.99	%FS	0.50

■ Operating Programs Using Multiple Channels

● Models with Two Inputs

Independent operation or coordinated operation can be used when 2-channel standard control or 2-channel heating/cooling control is selected.

Note: Multi-channel program operation is not possible if heating/cooling control is selected for a model with two outputs.

(1) Independent Operation

The following table shows the number of programs if the Independent Operation/Coordinated Operation parameter is set to "Independent Operation."

Number of segments	Channel 1		Channel 2	
	Number of programs	Setting range	Number of programs	Setting range
8	16	1 to 16	16	1 to 16
12	10	1 to 10	10	1 to 10
16	8	1 to 8	8	1 to 8
20	6	1 to 6	6	1 to 6
32	4	1 to 4	4	1 to 4

(2) Coordinated Operation

- Coordinated operation based on channel 1 is possible when the Independent Operation/Coordinated Operation parameter is set to "Coordinated Operation." The program will be the same for both channel 1 and channel 2.

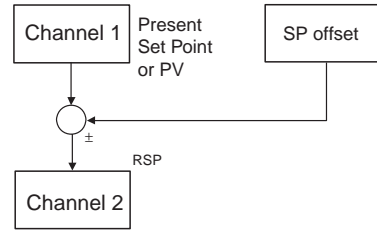

- As shown in the diagram on the right, coordinated operation is enabled when the channel 1 program pattern is input to the channel 2 remote SP.

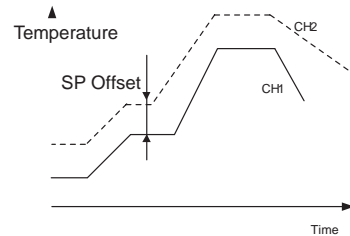

- The present SP or the PV can be set as the program pattern from channel 1. If the PV is set and channel 1 has an input error, an RSP input error will occur for channel 2.
- An offset can be set for channel 2.
- Any change in the Run/Reset parameter selection for channel 1 will also be changed for channel 2. The channel 2 Run/Reset parameter can, however, be set independently.
- Advance, hold, and back segment operations will be executed for both channels.

● Models with Four Inputs

- Coordinated operation based on channel 1 is possible. The program will be the same, therefore, for all channels.

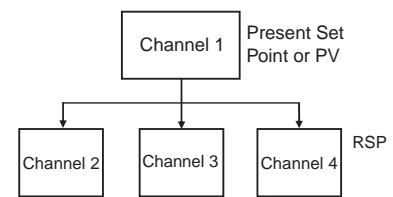

Offset can be set for channels 2 to 4.

- As shown in the diagram on the right, coordinated operation is enabled when the channel 1 program pattern is input to the remote SP for channels 2 to 4. The present SP or the PV can be set as the program pattern from channel 1. If the PV is set and channel 1 has an input error, an RSP input error will occur for channels 2 to 4.
- Any change in the Run/Reset parameter selection for channel 1 will also be changed for channels 2 to 4. Each Run/Reset parameter for channels 2 to 4 can, however, be set independently.
- Advance, hold, and back segment operations will be executed for all channels.

■ Disturbance Overshoot Adjustment

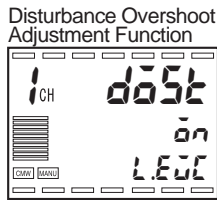

- The disturbance overshoot adjustment function adjusts the control waveform when disturbance occurs.
- To use this function, set the Disturbance Overshoot Adjustment Function parameter to "ON" (the default setting is "OFF").
- The disturbance response waveform can be adjusted using the Disturbance Gain and Disturbance Time Constant parameters.

● Disturbance Gain

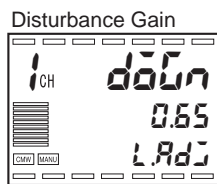

- The Disturbance Gain parameter can be increased to reduce overshooting when disturbance occurs.
- The Disturbance Gain parameter can be decreased to increase overshooting when disturbance occurs.
- When the Disturbance Gain parameter is set to 0, the disturbance overshoot adjustment function does not operate.

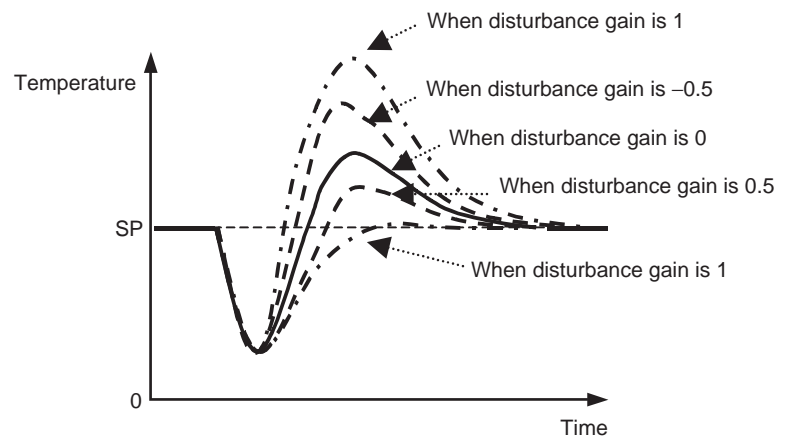

● Disturbance Time Constant

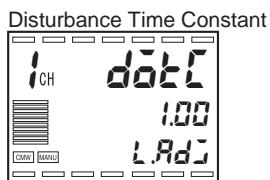

- The reset time after disturbance can be lengthened by increasing the disturbance time constant. (The default value of 1 is normally used for the disturbance time constant. If adjustment of the disturbance gain alone is not sufficient, this value can be adjusted for fine-tuning.)

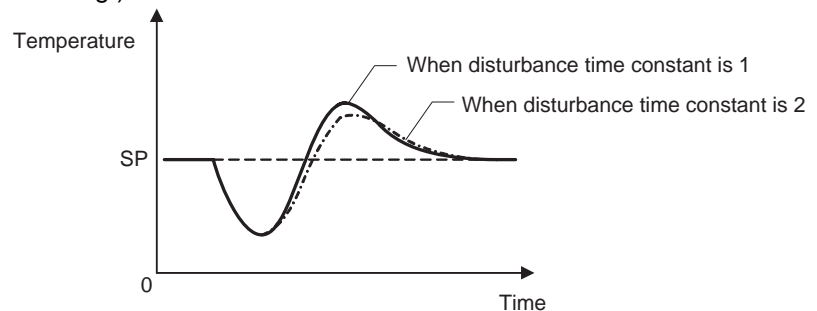

- The waveform may vary from that in the diagram depending on differences in the object of control and differences in PID constants.

● Conditions for Activating Disturbance Overshoot Adjustment

Disturbance Rectification Band

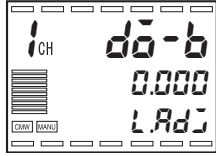

Disturbance Judgement Width

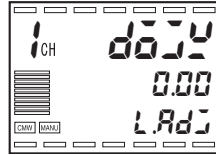

- If the deviation is greater than the value set for the Disturbance Judgement Width parameter after the PV is rectified to the value set for the Disturbance Rectification Band parameter, the disturbance overshoot adjustment function is activated.
- When the disturbance judgement width is a positive value, disturbance overshoot adjustment will activate when a disturbance occurs that makes the PV fall. When the disturbance judgement width is a negative value, disturbance overshoot adjustment will activate when a disturbance occurs that makes the PV rise.
- Disturbance overshoot adjustment is not activated in the following situations:
 - When the Disturbance Rectification Band or Disturbance Judgement Width parameter is set to 0.
 - When the SP is changed (when the SP change width exceeds the disturbance rectification band)
 - During AT
 - During ON/OFF control (P = 0.00)
 - During PD control (I = 0.00)

- The Disturbance Rectification Band and Disturbance Judgement Width parameters are set as percentages of FS. As such, if the input type is K (1) (-200.0 to 1300.0°C) and you wish to set the disturbance judgement width to 15.0°C, $15.0^{\circ}\text{C}/1500.0^{\circ}\text{C} \times 100 = 1.00\% \text{ FS}$

The Disturbance Judgement Width parameter is thus set to 1.00.

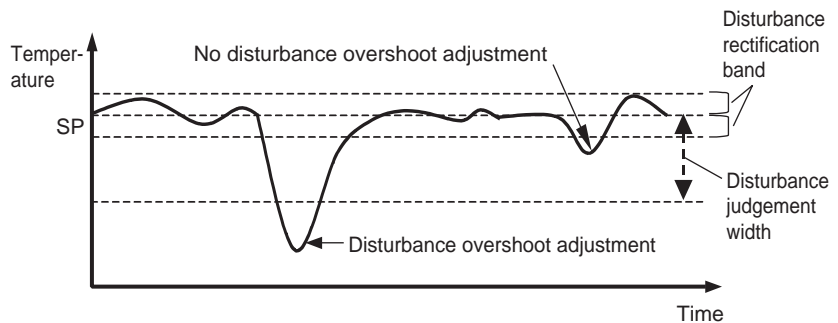

Parameter	Setting range	Unit	Default value
Disturbance Overshoot Adjustment Function	OFF: Disabled, ON: Enabled	–	OFF
Disturbance Gain	-1.00 to 1.00	–	0.65
Disturbance Time Constant	0.01 to 99.99	–	1.00
Disturbance Rectification Band	0.000 to 9.999	%FS	0.000
Disturbance Judgement Width	-99.99 to 99.99	%FS	0.00

5.3 Output Adjustment Functions

■ MV Limits

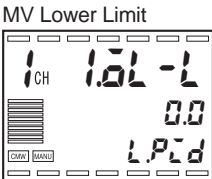
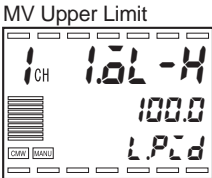

- Upper and lower limits can be applied to the output of the calculated MV.
- When using ON/OFF control, the MV will be the value set for the MV Upper Limit parameter when the output is ON and the value set for the MV Lower Limit parameter when the output is OFF.
- The MV limit function does not operate when floating control is selected on a Position-proportional Control Model.
- The following MVs take precedence over the MV limit function.
 - Manual MV
 - MV at Reset
 - MV at PV Error
- MV Upper Limit and MV Lower Limit parameters can also be set in PID sets.

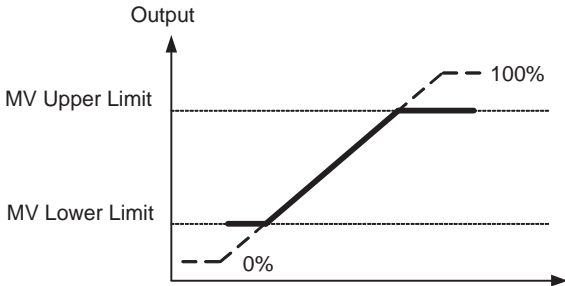

- For heating/cooling control, overall upper and lower limits are set for heating and cooling. (Separate limits cannot be set.)

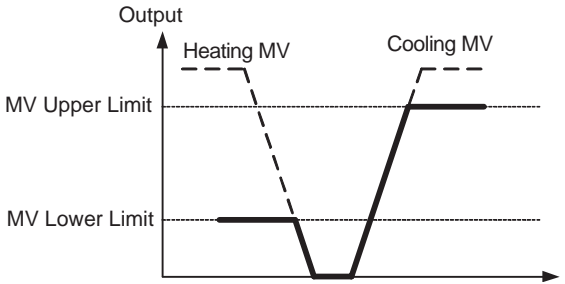

Parameter	Setting range	Unit	Default value
MV Upper Limit	Standard control: MV lower limit + 0.1 to 105.0	%	100.0
	Heating/cooling control: 0.0 to 105.0	%	100.0
MV Lower Limit	Standard control: -5.0 to MV upper limit -0.1	%	0.0
	Heating/cooling control: -105.0 to 0.0	%	-100.0

Functions and Operations

■ MV Change Rate Limit

MV Change Rate Limit (Heating)

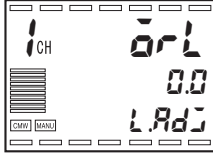

MV Change Rate Limit (Cooling)

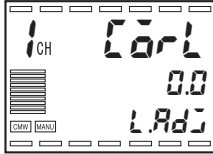

MV Change Rate Limit Mode

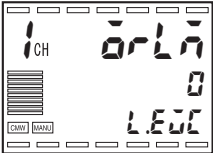

- The MV Change Rate Limit parameter is used to restrict the rate of change in the MV as a percentage per second (or in the opening of a valve for a Position-proportional Controller Model). If a change occurs in the MV that exceeds this setting, the MV is changed by the set limit each second until the required value is attained. When the limit is set to 0.0, the function is disabled.
- For standard control, use the MV Change Rate Limit (Heating) parameter. The MV Change Rate Limit (Cooling) parameter cannot be used.
- For heating/cooling control, separate limits can be set for heating and cooling. The MV Change Rate Limit (Heating) parameter is used for heating and the MV Change Rate Limit (Cooling) parameter is used for cooling.
- The MV Change Rate Limit parameters cannot be used in the following conditions:
 - Manual Mode
 - During AT
 - During ON/OFF control (P=0.00)
 - When control is stopped (MV Output at Stop)
 - During MV Output at PV error
- If you wish only to limit the rate of increase in the MV, set the MV Change Rate Limit Mode parameter to 1.

Parameter	Setting range	Unit	Default value
MV Change Rate Limit (Heating)	0.0 to 100.0	%/s	0.0
MV Change Rate Limit (Cooling)	0.0 to 100.0	%/s	0.0
MV Change Rate Limit Mode	0: Increase/decrease 1: Increase only	–	0

■ MV at Reset

MV at Reset

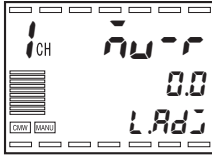

- This parameter specifies the value of the MV when control is stopped.

In heating/cooling control, a negative value is used for the cooling MV. Thus when the MV at Reset parameter is positive, the MV will be sent to the heating output, and when negative the MV will be sent to the cooling output.

The default setting is 0.0, which means there is no output at a reset for either standard or heating/cooling control.

Parameter	Setting range	Unit	Default value
MV at Reset	-5.0 to 105.0 (Standard control) -105.0 to 105.0 (Heating/cooling control)	%	0.0

Note: The order of priority of the MV parameter settings is
Manual MV > MV at Reset > MV at PV Error.

■ MV at PV Error

MV at PV Error

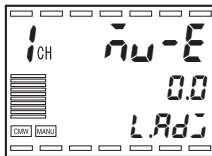

This parameter is used to output a fixed MV when an input error, or remote SP input error occurs.

When position-proportional control is selected, the MV at PV Error parameter also functions when a potentiometer input error occurs (when the Operation at Potentiometer Input Error parameter is set to "Stop" or "Close").

When control is stopped, the setting of the MV at Reset parameter takes precedence. In Manual Mode, the manual MV takes precedence.

Parameter	Setting range	Unit	Default value
MV at PV Error for Standard Control Models	-5.0 to 105.0 (Standard control) -105.0 to 105.0 (Heating/cooling control)	%	0.0
MV at PV Error for Position-proportional Control Models	-1: Closed output ON (Valve closed) 0: No output (valve opening hold) 1: Open output ON (Valve open)	-	0

Note: The order of priority of the MV parameter settings is
Manual MV > MV at Reset > MV at PV Error.

5.4 Display and Key Adjustment Functions

■ Display Scan

The display scan function is used to automatically change display channels on a Controller with more than one input.

This function applies only to channels that are enabled in the Number of Enabled Channels parameter. If the Number of Enabled Channels parameter is set to 3, channels 1, 2, and 3 are displayed.

● Starting/Stopping the Display Scan

The display scan can be started automatically after turning ON the power supply or by pressing the **[CH]** Key.

To stop the display scan, hold down the **[CH]** Key for at least 1 second.

Use the Start Display Scan after Power ON and Display Scan Period parameters to specify how the display scan operates.

Set values		Display scan status after turning ON power	Display scan control using [CH] Key
Start Display Scan after Power ON	Display Scan Period		
OFF	0 (=OFF)	Disabled	Disabled
	1 to 99		Enabled
ON	0 (=OFF)	Disabled	Disabled
	1 to 99	Enabled	Enabled

Start Display Scan at Power ON

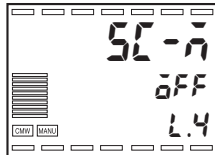

Display Scan Period

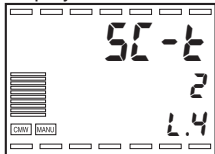

- If the PF1 Setting or PF2 Setting parameter is set to “CH” (CH Key), the PF1 or PF2 Key can be used as a CH Key. If the CH Key is not set for a function key, automatic starting of the display scan after turning ON the power is also disabled.
- When the display scan is enabled, use the **[CH]** Key to start or stop the display scan.
- To start the display scan, hold down the **[CH]** Key in the Operation Level, Program Setting Level, Adjustment Level, Adjustment 2 Level, Alarm Set Setting Level, PID Setting Level, Time Signal Setting Level, Approximation Setting Level, or Monitor Item Level. Display No. 1 will start to flash after the key is held down for 1 second, and after the key is held down for another 2 seconds, the display will stop flashing and the display scan will begin.
- If the **[CH]** Key is held down for more than 1 second during the display scan, the display scan will stop.
- During the display scan, only the **[CH]** Key is enabled. To use any other keys, the display scan must first be stopped with the **[CH]** Key.
- The Channel Indicator in Manual Mode shows the manual operation display.

● Example of Display Scan Operation

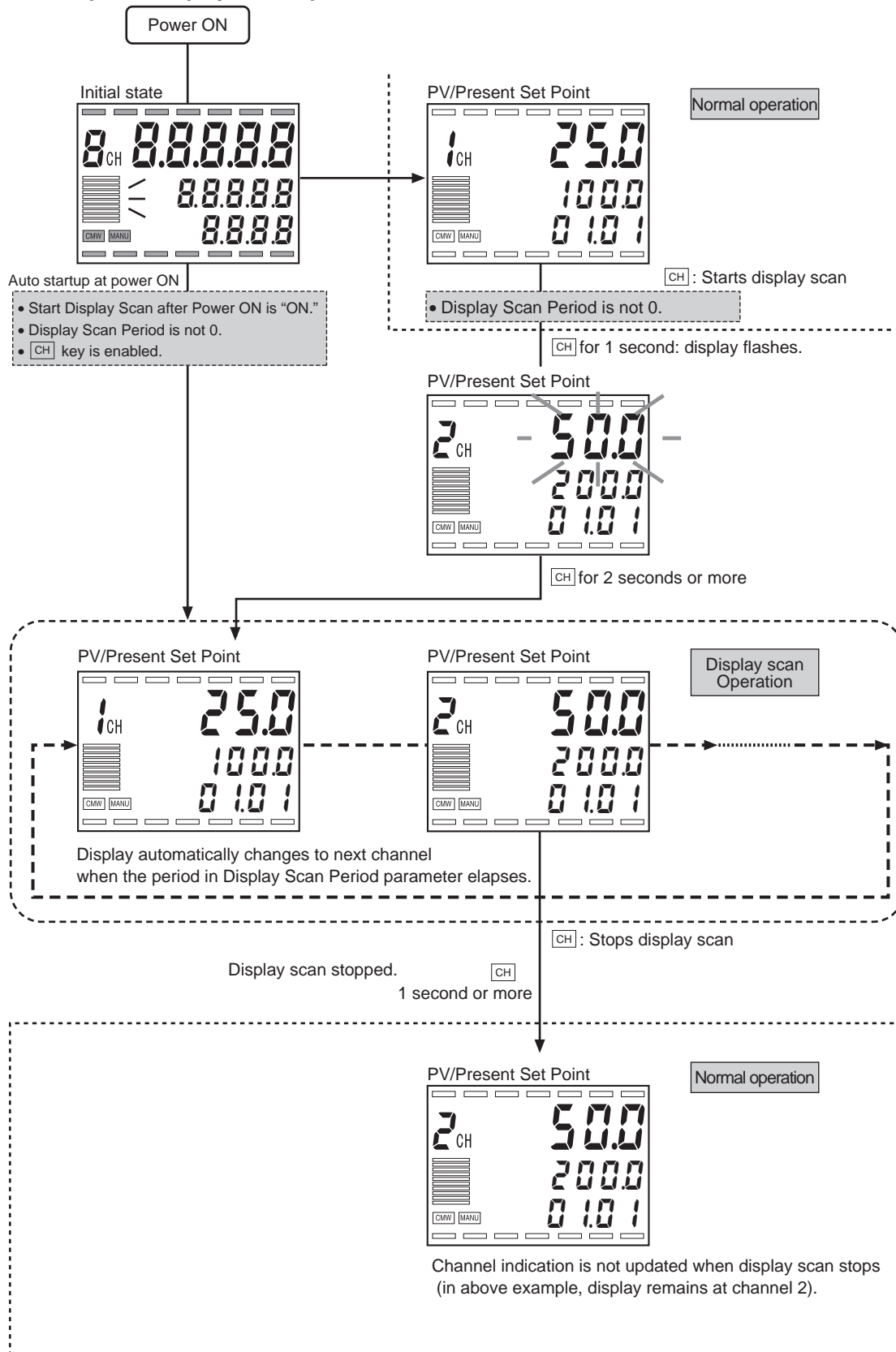

■ PF Settings (Function Keys)

PF1 Setting

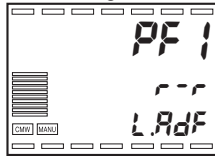

PF2 Setting

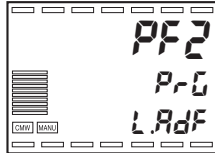

- The **PF1** and **PF2** Keys serve as function keys, and the functions of these keys can be selected.

Set values	Description	Function
OFF: $\bar{\alpha}FF$	Disabled	Does not operate as a function key.
RUN: rUn	Run	Executes run for the currently displayed channel.
RST: rSt	Reset	Resets the currently displayed channel.
P-R: $r-r$	Run/Reset	Executes run/reset for the currently displayed channel.
ARUN: $RrUn$	Run All	Executes run for all channels.
ARST: $RrSt$	Reset All	Resets for all channels.
HOLD: $H\bar{a}ld$	Hold/Clear Hold	Executes and clears hold for the currently displayed channel.
AHON: $RH\bar{o}n$	Hold All	Executes hold for all channels.
AHOF: $RH\bar{o}F$	Clear Hold All	Clears hold for all channels.
ADV: $Rd\bar{u}$	Advance	Executes an advance for the currently displayed channel.
AADV: $RRd\bar{u}$	Advance All	Executes an advance for all channels.
Bak: $bR\bar{u}$	Back	Executes a back operation for the currently displayed channel.
ABAK: $RbR\bar{u}$	Back All	Executes a back operation for all channels.
AT: $R\bar{t}$	AT Execute/Cancel	Starts and cancels AT execution. AT is executed for the currently selected PID set.
A-M: $R-\bar{n}$	A/M Key	Starts auto/manual operation for the currently displayed channel.
PRG: $Pr\bar{G}$	Select Program (PRG Key)	Changes the program number (the program number is incremented by 1).
PFDP: $PFdP$	Monitor/Setting Item	Displays monitor/setting items. Set the Monitor/Setting Item 1 to Monitor/Setting Item 5 parameters (Advanced Function Setting Level).
CH: $\bar{C}H$	CH Key	Switches channels.

- Hold down the **PF1** or **PF2** Key for at least 1 second to execute the function set in the PF1 Setting or PF2 Setting parameter, except for the following exceptions: The key will operate as soon as it is pressed if any of the following is set: Program, Monitor/Setting Item, or **CH** Key. When run or reset operations are set, the key must be pressed for at least 1 second for run, but for at least 2 seconds for reset.

* The default settings for the function keys are as follows:

PF1 Setting: $r-r$ (Run/Reset)

PF2 Setting: $P-r$ (Program)

The default setting is \square CH Key for models with more than one input channel.

* With the exception of the “Select Program,” “Monitor/Setting Item,” and “ \square CH Key” settings, the function keys are effective only in the following levels: Operation, Program Setting, Adjustment, Adjustment 2, Alarm Set Setting, PID Setting, Time Signal Setting, Approximation Setting, Monitor Item, and Protect Levels.

- A key set for “Program” is effective only in Operation Level.
- A key set for “Monitor/Setting Item” is effective only in Protect Level.
- A key set for “ \square CH Key” is effective in all levels.

The keys are effective only when the PF Key Protection parameter is set to “OFF.”

* Operation Adjustment Protection and Setting Change Protection do not apply to the function keys.

Parameter settings can be changed and saved using function keys if the key is set to the corresponding function.

● Monitor/Setting Item

The PF1 Setting or PF2 Setting parameter can be set to $PFdP$ (Monitor/Setting Item) to display monitor/settings using a function key.

The content to be displayed is set for each channel in the Monitor/Setting Item 1 to Monitor/Setting Item 5 parameters of the corresponding function key.

The selections are shown in the following table. Refer to the descriptions of individual parameters for the setting or monitor ranges.

PF1 Monitor/Setting Item 1

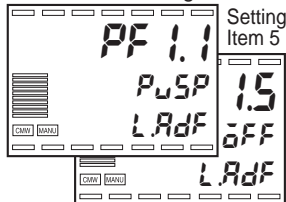

PF2 Monitor / Setting Item 1

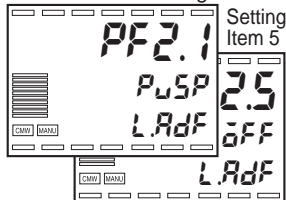

Set value	Description	Remarks	
		Monitor/Setting	Display
OFF	Disabled		
PVSP	PV/SP/MV	Can be set (SP)	–
PVDV	PV/Deviation	Monitor only	–
SEG.R	Remaining Segment Time	Monitor only	SEGr
P	Proportional Band (P)	Can be set	P
I	Integral Time (I)	Can be set	i
D	Derivative Time (D)	Can be set	d
AL-1	Alarm 1	Can be set	AL - 1
AL1H	Alarm Upper Limit 1	Can be set	AL 1H
AL1L	Alarm Lower Limit 1	Can be set	AL 1L
AL-2	Alarm 2	Can be set	AL - 2
AL2H	Alarm Upper Limit 2	Can be set	AL 2H
AL2L	Alarm Lower Limit 2	Can be set	AL 2L
AL-3	Alarm 3	Can be set	AL - 3
AL3H	Alarm Upper Limit 3	Can be set	AL 3H
AL3L	Alarm Lower Limit 3	Can be set	AL 3L
AL-4	Alarm 4	Can be set	AL - 4
AL4H	Alarm Upper Limit 4	Can be set	AL 4H
AL4L	Alarm Lower Limit 4	Can be set	AL 4L

◆ Displaying the Monitor/Setting Item

To display the Monitor/Setting Item, press the function key in Operation Level, Program Setting Level, Adjustment Level, Adjustment 2 Level, Alarm Set Setting Level, PID Setting Level, Time Signal Setting Level, Approximation Setting Level, or Monitor Item Level.

Press the key repeatedly to scroll from the Monitor/Setting Item 1 to the Monitor/Setting Item 5 parameters. After the Monitor/Setting Item 5 parameter, the display changes to the first parameter in Operation Level.

- * If any of settings for the Monitor/Setting Item 1 to Monitor/Setting Item 5 parameters are disabled, those settings will not appear and the display will show the next enabled setting.
- * If another key is pressed during display of a Monitor/Setting Item parameter, the following will take place:
 - If the Mode or Level Key is pressed, the first parameter in Operation Level will be displayed.
 - If a function key set as a channel key is pressed, the channel will change and the first parameter in Operation Level of the new channel will be displayed.
 - If the other function key is pressed and it is also set to Monitor/Setting Items, the first monitor/setting item set for that key will be displayed.
 - If the other function key is pressed and it is set to a function other than Monitor/Setting Items, the set function will be activated.
- * Display No. 3 operates as follows while displaying Monitor/Setting Items:
 - If the PV, SP, or MV is displayed, Display No. 3 monitors shows the MV.
 - Otherwise, the display goes OFF.

■ Other Display and Key Adjustment Functions

Other display and key adjustment functions are available. These functions are explained in *Section 8 Parameters*.

Parameter	Level
Bar Graph Display Item (E5AR-T only)	Display Adjustment Level
Automatic Display Return Time	Display Adjustment Level
Display Refresh Period	Display Adjustment Level
Monitor Item Level Setting	Display Adjustment Level
PV Decimal Point Display	Initial Setting Level

5.5 Protecting Settings

■ Protection

Protection is used to restrict access to settings in order to prevent accidental changes to the settings. The following protection can be set: Operation Adjustment Protection, Initial Setting Protection, Setting Change Protection, and PF Key Protection.

● Operation Adjustment Protection

Operation Adjustment Protection

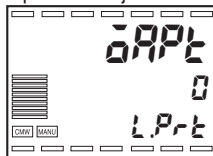

Operation Adjustment Protection restricts key operations in Operation Level, Program Setting Level, Adjustment Level, Adjustment 2 Level, Alarm Set Setting Level, PID Setting Level, Time Signal Setting Level, Approximation Setting Level, and Monitor Item Level.

Set value	Operation		Program Setting Level, Adjustment Level, and Adjustment 2 Level	Alarm Set Setting Level, PID Setting Level, Time Signal Setting Level, Approximation Level and Monitor Item Level
	PV, Fixed SP, or Program Number	Other		
0	Enabled	Enabled	Enabled	Enabled
1	Enabled	Enabled	Enabled	Prohibited
2	Enabled	Enabled	Prohibited	Prohibited
3	Enabled	Prohibited	Prohibited	Prohibited
4	Restrictions*	Prohibited	Prohibited	Prohibited

* The Program Number parameter is prohibited.

Enabled: No restrictions (Parameters can be displayed or changed, and the level can be entered.)

Restrictions: Some restrictions apply. (Parameters can be displayed but not changed.)

Prohibited: The parameters are completely protected. (Parameters cannot be displayed and the level can be entered.)

- The default setting is 0.

● Initial Setting Protection

Initial Setting Protection

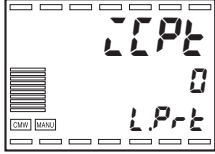

Initial Setting Protection restricts access to the Input Initial Setting, Control Initial Setting, Control Initial Setting 2, Alarm Setting, Display Adjustment, and Communications Setting Levels.

Set value	Move to Input Initial Setting Level	Move to Control Initial Setting, Control Initial Setting 2, Alarm Setting, Display Adjustment, or Communications Setting Level
0	Enabled Move to Advanced Function Setting Level parameter is displayed.	Enabled
1	Enabled Move to Advanced Function Setting Level parameter is not displayed.	Enabled
2	Prohibited	Prohibited

- When the Initial Setting Protection parameter is set to 2, nothing happens when the Level Key is held down to move to Input Initial Setting Level from Operation Level, Program Setting Level, Adjustment Level, Adjustment 2 Level, Alarm Set Setting Level, PID Setting Level, Time Signal Setting Level, Approximation Setting Level, or Monitor Item Level. (The flashing display to indicate movement to another level also does not appear.)
- The default setting is 0.

● Setting Change Protection

Setting Change Protection

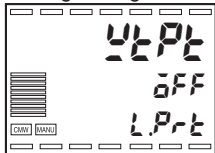

Setting Change Protection prevents use of the  and  Keys.

Set value	Description
OFF	Keys can be used to change settings.
ON	Keys cannot be used to change settings. (However, settings can be changed in Protect Level.)

- The default setting is OFF.

● PF Key Protection

PF Key Protection

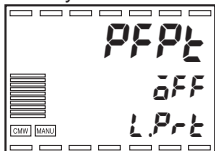

PF Key Protection prevents use of the PF1/PF2 Keys.

Set value	Description
OFF	PF1/PF2 Keys are enabled.
ON	PF1/PF2 Keys are disabled. (Prohibits use as a function key or a channel key.)

- The default setting is OFF.

5.6 Alarm Adjustment Functions

■ Alarm Hysteresis

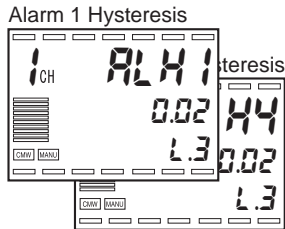

- Hysteresis can be applied when alarm outputs turn ON and OFF, as shown below.

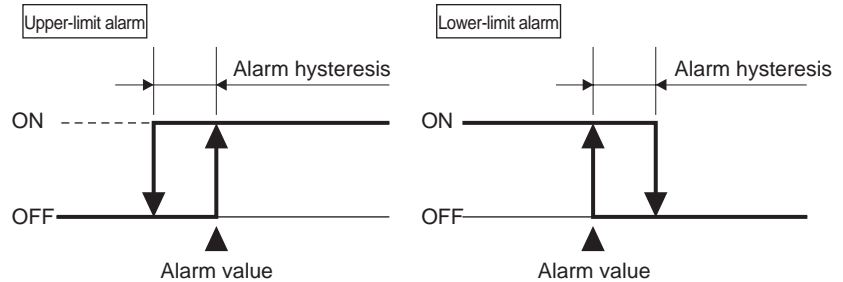

- Alarm hysteresis can be set separately for each alarm in the Alarm 1 to 4 Hysteresis parameters.
- All default values are 0.02 (%FS).

■ Standby Sequence

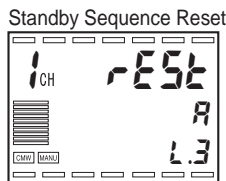

- A standby sequence is used to delay alarm output until the PV leaves the alarm range once and then subsequently enters it again.
- For example, for a lower-limit alarm, the PV is normally smaller than the SP when the power is turned ON and thus is within the alarm range, which would cause the alarm output to turn ON. However, if a “Lower Limit Alarm with Standby Sequence” is selected, the alarm output will not turn ON until the PV rises above the alarm set value and out of the alarm range, and then falls below the alarm value.

● Standby Sequence Reset

- The standby sequence is canceled when an alarm output occurs, and then restarts based on conditions specified in the Standby Sequence Reset parameter.
- Conditions A:
 - At the start of operation (including after turning ON power),
 - When the alarm value (alarm upper or lower limit) is changed,
 - When the input correction (Input Value 1 for Input Correction, Input Correction 1, Input Value 2 for Input Correction, or Input Correction 2 parameter) is changed,
 - When the SP of the current segment is changed (including changing the fixed SP in Fixed SP Mode),
 - When program is started (including when the program is started for program repetitions or program links), or
 - When the segment is changed (including when an advance is executed).

- Conditions B:
When power is turned ON
- The Standby Sequence Reset parameter is used for all of Alarms 1 to 4.
- The default setting is 0 (Conditions A).

Alarm Latch

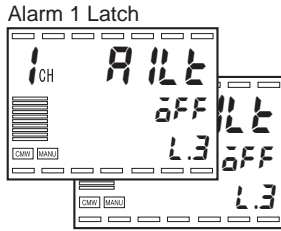

- The alarm latch is used to make an alarm output that has turned ON remain ON until the power is turned OFF, regardless of the temperature.
- The alarm latch can be canceled by turning the power OFF or by using a communications command.
- An alarm latch can be set separately for each alarm in the Alarm 1 to 4 Latch parameters.
- The default setting is 0 (OFF).

Close in Alarm/Open in Alarm

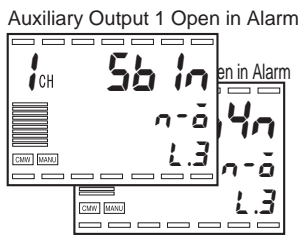

- When the Auxiliary Output Open in Alarm parameter is set to “Close in Alarm,” the alarm output state is output as is. When it is set to “Open in Alarm,” the alarm output state is inverted before being output.
- “Close in Alarm” or “Open in Alarm” can be set separately for each auxiliary output in the Auxiliary Output 1 to 10 Close in Alarm parameters.
- The default setting is $n-0$ (Close in Alarm).

Parameter setting	Auxiliary output function	Auxiliary output	Operation indicator
Close in Alarm: $n-0$	ON	ON	ON
	OFF	OFF	OFF
Open in Alarm: $n-1$	ON	OFF	ON
	OFF	ON	OFF

- The auxiliary outputs are OFF (open) while the power is turned OFF. Also, the auxiliary outputs require approximately 2 seconds after the power is turned ON before they are activated.

Alarm SP Selection

The set point that triggers a deviation alarm during ramp operation can be set to either the present SP or the target SP.

● Alarm Operation Summary

- The following example summarizes alarm operation. (In this example, a “Lower Limit Alarm with Standby Sequence” and “Close in Alarm” are selected).

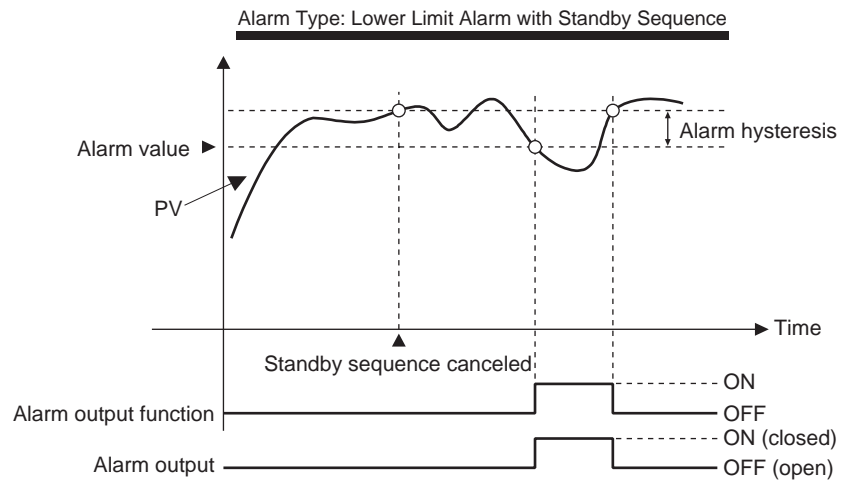

Display characters	Parameter	Level (Display No. 3)	Use
<i>RLt</i> *	Alarm 1 to 4 Type	Alarm Setting (L.3)	Sets the alarm type.
<i>R * Lt</i>	Alarm 1 to 4 Latch	Alarm Setting (L.3)	Alarm output latch
<i>RLH</i> *	Alarm 1 to 4 Hysteresis	Alarm Setting (L.3)	Alarm output hysteresis
<i>rEst</i>	Standby Sequence Reset	Alarm Setting (L.3)	Sets standby sequence reset conditions.
<i>Sb * n</i>	Auxiliary Output 1 to 10 Open in Alarm	Alarm Setting (L.3)	Close in Alarm or Open in Alarm

*: 1 to 4 or 1 to 10.

5.7 Program Operation Functions

■ Rate of Rise Programming

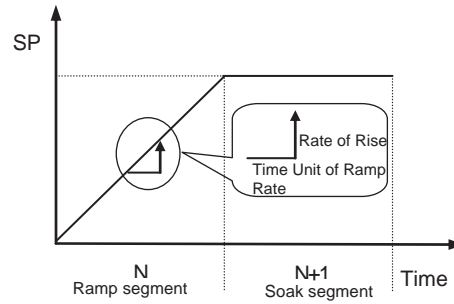

- With rate of rise programming, the program is set using 3 element: SP, rate of rise, and time. If selecting rate of rise programming, set the Step Time/Rate of Rise Programming parameter to “Rate of Rise Programming.”
- The Segment Time parameter can be set to between 0.00 and 99.59 (hours.minutes or minutes.seconds) or between 0.00.0 and 99.59.9 (minutes.seconds.tenths of seconds). The default is 0.00 or 0.00.0.
- The Time Unit of Ramp Rate parameter can be set to 10 hours, hours, minutes, or seconds. The default is minutes.
- If the Segment Rate of Rise parameter is set to 0, the ramp segment is skipped and the soak segment is continued.
- In ramp segments, the SP of the previous segment is used as the starting point and the rate of rise for the current segment is continued in a straight line. The point reached when the time for the current segment has passed then becomes the present SP.

● Operation at Reset Parameter Set to Stop Control

Ramp settings are for even-numbered segments by setting the SP and rate of rise.

- The following table shows an example setting. The Time Unit of Ramp Rate parameter is set to “Time.”

Segment No.	1	2	3	4	5	6	...
Segment Set Point	30.0	100.0	---	200.0	---	150.0	...
Segment Rate of Rise	---	7.0	---	5.0	---	5.0	...
Segment Time (hours:minutes)	6:00	---	0:00	---	14:00	---	...

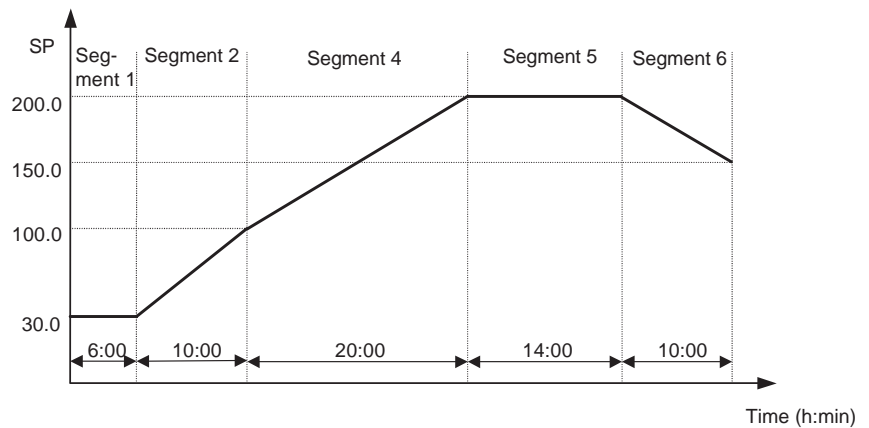

- For the E5AR-T/ER-T, Step Time programming is used for segment 1. The rate of rise programming can be selected to start from the segment 1 SP or from a PV start with slope priority.
- With rate of rise programming, the settings are made in blocks of two segments, so the final soak time cannot be set if the Number of Segments Used parameter is set to an even number. Therefore, the final segment will be a soak segment if the Number of Segments Used parameter is set to an odd number and will be a ramp segment if set to an even number.

● Operation at Reset Parameter Set to Use Fixed Control

Ramp settings are made for odd-numbered segments by setting the SP and rate of rise.

- The following table shows a setting example. The Time Unit of Ramp Rate parameter is set to "Time."

Segment No.	1	2	3	4	5	...
Segment Set Point	100.0	---	200.0	---	150.0	...
Segment Rate of Rise	7.0	---	5.0	---	5.0	...
Segment Time (hours:minutes)	---	0:00	---	14:00	---	...

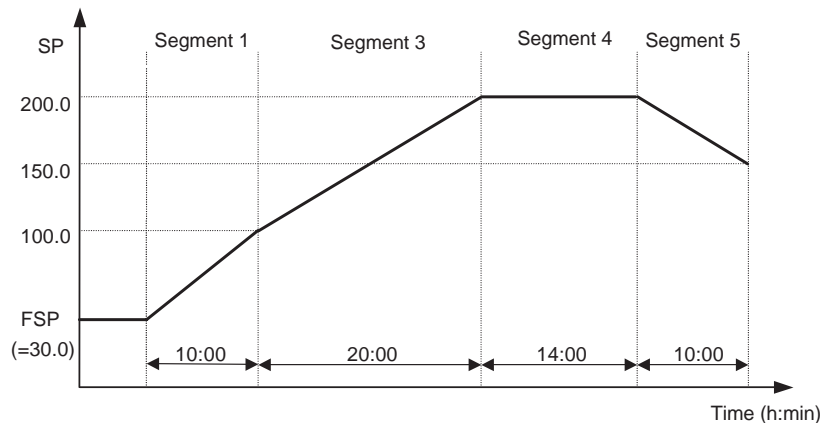

- With rate of rise programming, the settings are made in blocks of two segments, so the final soak time cannot be set if the Number of Segments Used parameter is set to an odd number. Therefore, the final segment will be a soak segment if the Number of Segments Used parameter is set to an even number and will be a ramp segment if set to an odd number.

● Changing Set Values

If the rate of rise setting is changed in the middle of a segment, the segment time for the ramp period changes as well as the rate of rise for the present SP.

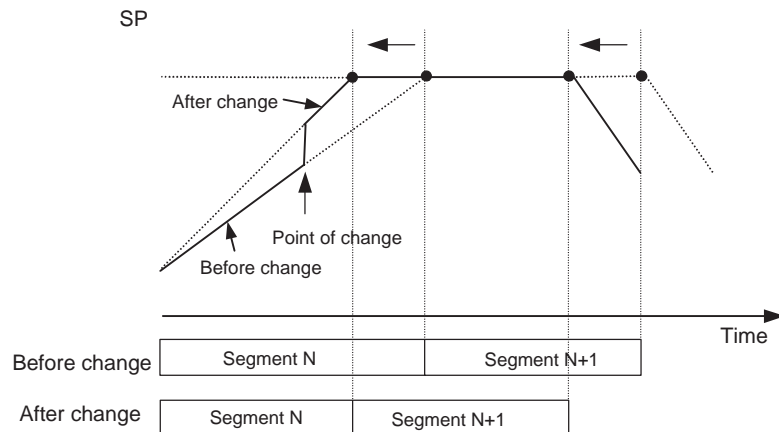

- In the above diagram, the increased rate of rise results in a shorter time for that segment.
- Similarly, if the SP is changed, the segment time for the ramp period is also changed.
- If the soak time is changed, only the segment time for the soak period is changed.

■ Program Operations

This section describes the parameters used during program operation.

● Advance

- An advance operation moves to the start of the next segment.
- An advance operation moves forward to the end of the present segment each time the Advance parameter is set to "ON." The Advance parameter turns OFF once the next segment has been reached.
- An advance operation cannot be executed during reset.

● Hold

- A hold operation forces the program to maintain steady-state control at the segment set point.
- The timer is stopped when the Hold parameter is set to "ON" and restarts when the Hold parameter is set to "OFF."

- The hold is cleared under the following conditions:
The Hold parameter is set to “OFF” (the program continues from the segment set point), the Run/Reset parameter is set to “Reset,” or the program operation is completed as a result of an advance operation being executed.
- If an advance operation is executed during a hold, the hold is continued from the beginning of the next segment.
- The Hold parameter cannot be executed while resetting.

● Back

- A back operation resets the segment timer and returns to the beginning of the current segment.
- If a back operation is executed during a hold, the hold is continued from the beginning of the current segment.

● Program Repetitions

- A program repetition restarts execution of the same program automatically after the end of the current program. The Program Repetitions parameter can be set up to 9,999.
- The number of executions will be the setting for the Program Repetitions parameter + 1.
- If the Program Repetitions parameter is changed to a smaller number during program operation, the currently executing program will be executed to the end and then the program will stop.

● Program Links

- A program link moves execution to segment 1 of the program number set for Program Link Destination parameter. Operation will be completed when the Program Link Destination parameter is set to program 0.
- If a program repeat operation is also set, the program link will start after the program repeat operation has been completed.
- If the Program Link Destination parameter is set to the current program number, the program will be repeated endlessly.
- Once all programs have been executed, operation will be according to the setting for the End Condition parameter.

■ SP Modes

The E5AR-T/ER-T uses three SP modes: Program SP (PSP), Fixed SP (FSP), and Remote SP (RSP).

● Switching SP Modes

- The diagram on the right shows an example of switching between Program SP Mode and Fixed SP Mode during program execution.

The operation is as follows:

- (1) Switch from Program SP to Fixed SP in segment N.
- (2) The mode changes to Fixed SP.
- (3) Return to Program SP from Fixed SP in segment N+1.

- If the Operation at Reset parameter is set to stop control, the timer will not start when the Run/Reset parameter is changed to “Run” in Fixed SP or Remote SP Mode.

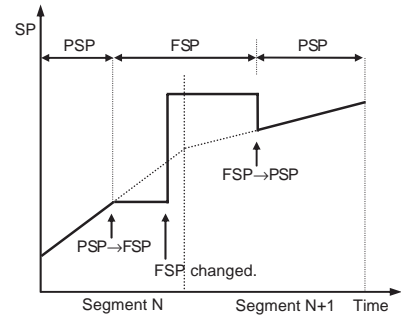

● SP Tracking

- When the SP Tracking parameter is set to “ON,” the program SP is held after the mode is changed from Program SP to Fixed SP and until the Fixed SP is changed. The SP is not tracked when the mode is changed from another mode into either Program SP or Remote SP.
- The diagram on the right shows SP tracking when the mode is changed from Program SP to Fixed SP.

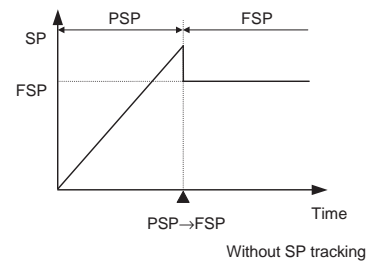
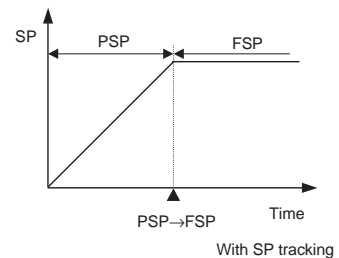

■ Wait

- If at the end of a program segment the difference (deviation) between the PV and the present set point (program SP) is not within a preset range, the program can be set to not continue. This is called the “wait” operation and the preset range is called the “wait band.”
- If the PV enters the wait band during wait operation, the program will immediately move to the next segment.
- There are two types of wait operation: “Wait at Segment End” and “Always wait,” which can be selected by setting the Wait Mode parameter. The wait operation can be enabled and disabled for each segment.
- Upper and lower limits can be set for the wait band and these can be set for each program. The wait operation will be disabled if the Wait Band parameter is set to 0.

● Wait at Segment End

If the difference (deviation) between the PV and the present SP is not less than the wait band, the program does not move to the next segment. As soon as the PV enters the wait band, the program moves to the next segment.

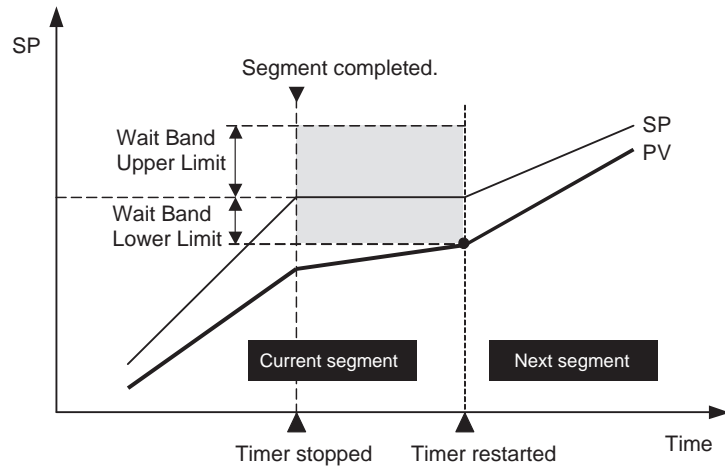

● Always Wait

The difference (deviation) between the PV and the present set point are constantly compared during program operation. If the PV is not within the wait band, the present set point is held at the point that the deviation went outside the wait band and the program does not move on. The program moves on as soon as the PV enters the wait band.

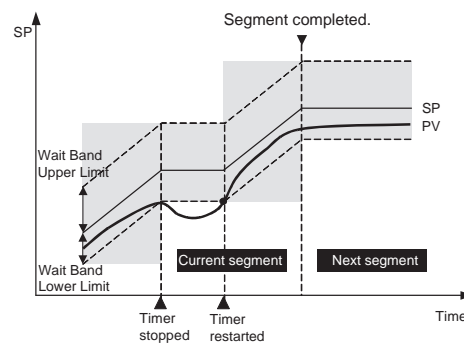

■ Time Signal

- One out of following functions can be selected: Segment Output, Time Signal, or Segment No. Output (described later).
- When the Time Signal parameter is enabled, 6 outputs can be set for each program and three different times can be set for each output.
- There are two timers for the time signal: a switch-ON timer and a switch-OFF timer. The timers start from the beginning of the segment.
- Outputs turn ON once the switch-ON time has elapsed and turn OFF after the switch-OFF time has elapsed.

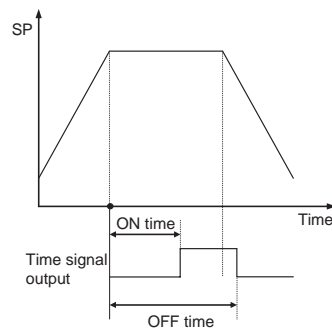

- The Time Signal 1 Set Segment 1 to Time Signal 6 Set Segment 3 parameters are used to set the segments in which the time signals will start. The default setting is 0 (disabled).
- The ON/OFF timing is set using the Time Signal 1 ON Time 1 to Time Signal 6 ON Time 3 and Time Signal 1 OFF Time 1 to Time Signal 6 OFF Time 3 parameters. The default setting is 0.00 or 0.00.0.
- Set the interval between the switch-ON time and switch-OFF time to at least 100 ms. Unexpected operation may result if the interval is less than 100 ms.
- ON Conditions
 - If the switch-OFF time is shorter than the switch-ON time, the output remains ON from when the switch-ON time has elapsed until reset or the next program starts.
 - If an advance operation is executed during a segment where a time signal is set, a time equivalent to the segment will be considered to have elapsed. In the above diagram, for example, outputs remain ON from the start of the next segment until the switch-OFF time has elapsed.
- The time signal is turned OFF under the following conditions:
 - During a reset
 - When one program has been completed when a program repeat or program link operation has been set.
- The time signal timer stops during hold, wait, and AT operations.

■ Segment Outputs

- One of following functions can be selected: Segment Output, Time Signal, or Segment No. Output (described later).
- Up to 10 outputs can be set for each program if using segment outputs is selected.
- Segment outputs can be set to ON or OFF for each segment. Outputs are turned ON if the Segment Output parameter for that segment is set to ON.

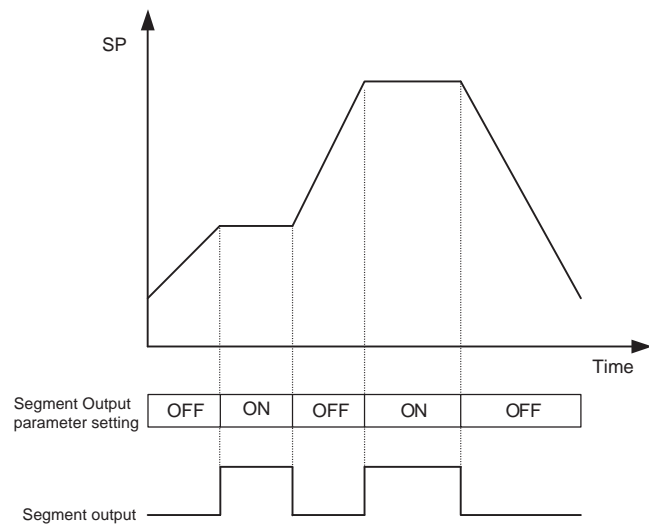

- Segment outputs are turned OFF during a reset.

■ Program Status Outputs

The following two types of program status outputs can be used.

● Program End Output

- Program End Output: Output at the end of the program.
- Segment No. Output: The number of the segment for which the program is being executed is output.

- The program end output occurs at the end of the last segment.
- The program end output occurs at the end of the last segment of the last program if a program repeat or program link operation is set.
- The pulse width for the program end output can be set using the Program End ON Time parameter. The setting range for the Program End ON Time parameter is 0.0 to 10.0 s. The default setting is 0.0.

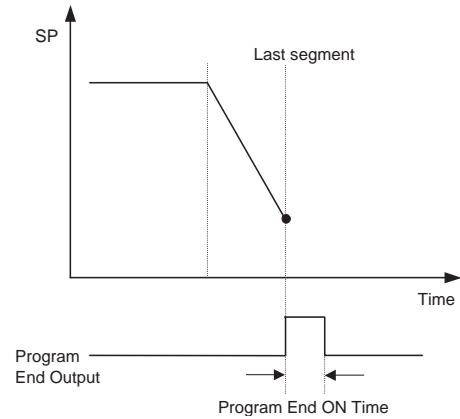

- The program end output is forced OFF if the Run/Reset parameter is changed to “Run” during a reset.
- If the Program End ON Time parameter is set to “ON,” the output also remains ON during reset status, i.e., until the Run/Reset parameter changes to “Run.”

● Segment No. Output

- One out of following functions can be selected: Segment No. Output, Time Signal, or Segment Output.
- The number of the segment for which the program is currently being executed is output in binary-coded hexadecimal.

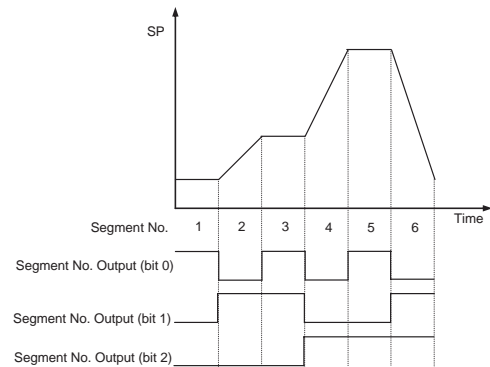

- All outputs turn OFF during reset.

■ Operation at Program Start

● PV Start

- The method for starting program operation can be selected from the following using the PV Start parameter: SP start, PV start with slope priority or PV start with time priority. A PV start with time priority cannot be selected, however, if rate of rise programming is set.
- A PV start is used only for the first program execution if a program repeat or program link operation is set.

SP Start A SP start is used to execute the program in order from the segment 1 SP.

If the Operation at Reset parameter is set to “Fixed Control,” then the program will start operation from the fixed SP.

PV Start with Slope Priority

Operation is started from the position of the first present set point that matches the PV at the start of the program. If the PV and the present set point do not match at any position, operation starts at the beginning of the program.

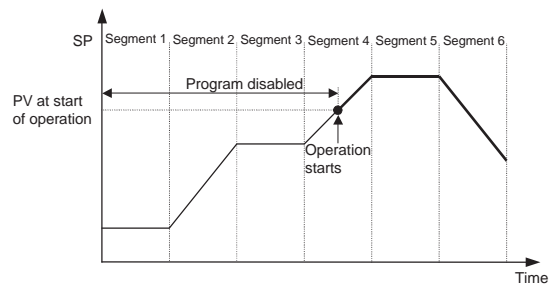

The above diagram shows an example of the operation. The first position where the PV and the present SP match is in segment 4 and from there the program is indicated by a bold line. The program prior to that position is ignored.

PV Start with Time Priority

The SP at the start of the program is set to the current PV and the ramp rate is modified accordingly to adjust to the segment time. This means that, in general, the segment 2 ramp rate will change from the rate that is set in the program.

The following diagram shows operation examples when the PV at the start of program operation is larger than the SP and when it is smaller than the SP. Once segment 2 has been completed, the operation is according to the program. Using a PV Start with time priority is disabled if rate of rise programming is used.

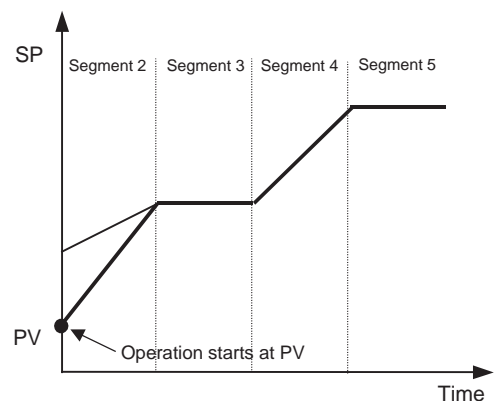
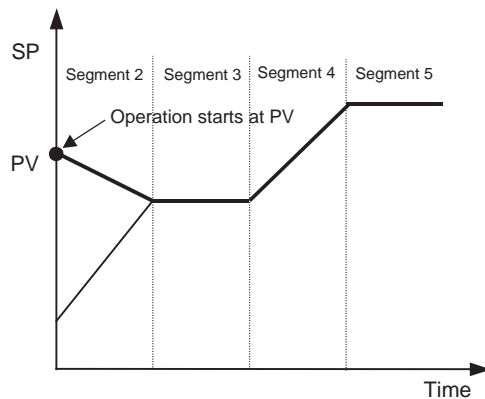

● Standby

- When a standby is set, the program does not start operating until the standby time (set in hours:minutes) has elapsed after the Run/Reset parameter is set to “Run.”
- The following conditions apply to operation during a standby:
 - Control outputs are governed by the MV at Reset parameter (the indicators and status display will show Run status).
If the Operation at Reset parameter is set to “Fixed Control,” then control outputs will start from the fixed SP.
 - Hold, advance, back, and AT operations (when the Operation at Reset parameter is set to “Stop Control”) cannot be executed.
If AT is executed when the Operation at Reset parameter is set to “Fixed Control,” the remaining standby time during AT execution is held.
 - If the power is interrupted during a standby, the remaining standby time is held (if the Operation at Power ON parameter is set to “Continue,” if the program is running and in Manual Mode before the power was turned OFF, and if a ramp back is set).
- If run operation is executed in reset status, the remaining standby time is set as the value for the Standby Time parameter. This means the remaining standby time is continued when run operation is executed during a standby (the set value for the Standby Time parameter is not initialized).

■ End Condition

The End Condition parameter is used to select the operation after a program has been completed can be selected. The options are Reset Status, Continue, or Fixed SP Mode.

Operating status	Description
Reset status	Ends operation.
Continue	Control is continued using the SP of the last segment. The final segment number is held as the segment number and the elapsed program time, elapsed segment time, and remaining segment time are held. The time signal status at the end of operation is held. If the setting of the Number of Segments Used parameter is changed after operation has completed, there is no change to the operation end status but control will switch to using the SP of the last segment after the change.
Fixed SP Mode	Operation is continued in Fixed SP Mode after the program has completed (run status). The segment number, elapsed program time, elapsed segment time, and remaining segment time will be the values from the start of the program. The time signal is OFF. If the SP Mode parameter is changed to Program SP (PSP), the program will start again. If, however, the Operation at Reset parameter is set to “Fixed Control,” Fixed SP Mode cannot be set.

5.8 Using Event Inputs

- An order of priority exists for event inputs, key operation, and communications settings: The last setting takes priority.
- The operation of event inputs can be switched between pulse operation (i.e., event occurs only when the input changes from OFF to ON) and toggle operation (i.e., event occurs either when the input changes from OFF to ON or from ON to OFF).

■ Event Input Assignments

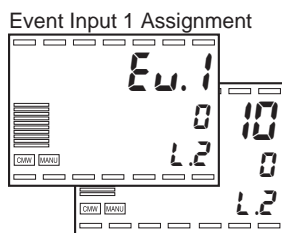

- Functions are assigned to event inputs (which use external contact inputs) using the Event Input Assignment 1 to 6 parameters.
- On a Controller with more than one input, functions can be assigned for channels 2 and higher for the number of supported channels.

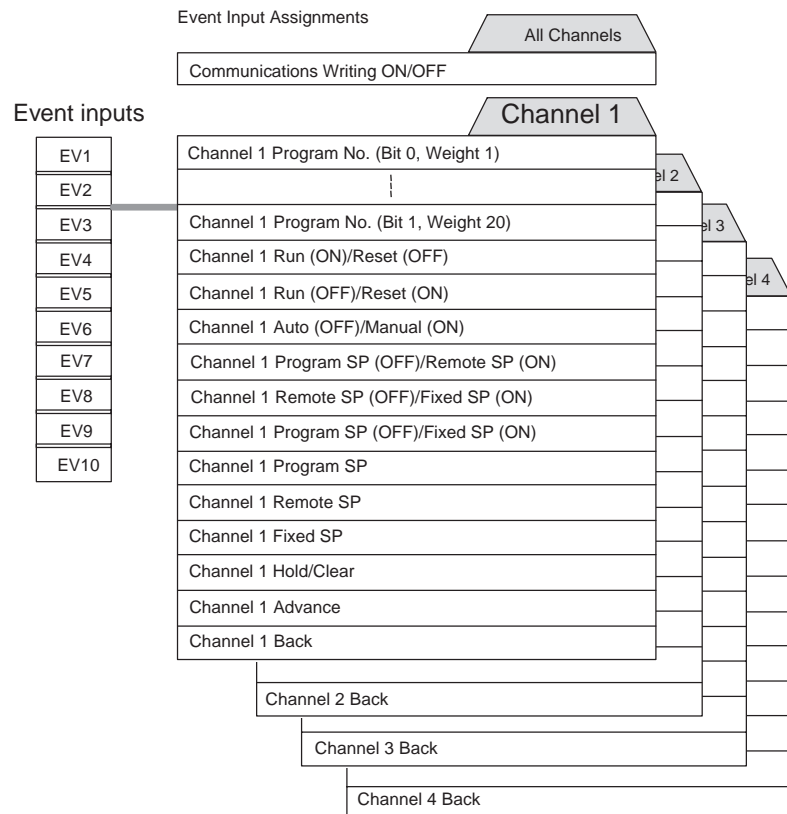

● Communications Writing OFF/ON

- When the event input is ON, parameters can be written using communications.
- The Communications Write OFF/ON function creates an operation command that applies to all channels.
- Operation is as described below based on the ON/OFF status of the event input.

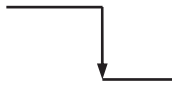
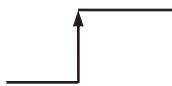
Event input	Description
	Communications Writing OFF
	Communications Writing ON

● Program Number

- The program number can be specified using the ON/OFF status of event inputs.
- This program number function creates an operation command that applies to all channels for coordinated operation and one specific channel for independent control.
- This function is enabled only during a reset.
- The following table shows the operation based on the ON/OFF status of event inputs.

Bit 0, Weight 1	Bit 1 Weight 2	Bit 2 Weight 4	Bit 3 Weight 8	Bit 4 Weight 16	Bit 5 Weight 32	Bit 0 Weight 10	Bit 1 Weight 20	Code	Program number
ON	OFF	OFF	OFF	OFF	OFF	---	---	Hexa-decimal	1
OFF	ON	OFF	OFF	OFF	OFF	---	---		2
ON	ON	OFF	OFF	OFF	OFF	---	---		3
OFF	OFF	ON	OFF	OFF	OFF	---	---		4
ON	OFF	ON	OFF	OFF	OFF	---	---		5
OFF	ON	ON	OFF	OFF	OFF	---	---		6
ON	ON	ON	OFF	OFF	OFF	---	---		7
OFF	OFF	OFF	ON	OFF	OFF	---	---		8
ON	OFF	OFF	ON	OFF	OFF	---	---		9
OFF	ON	OFF	ON	OFF	OFF	---	---		10
ON	ON	OFF	ON	OFF	OFF	---	---		11
OFF	OFF	ON	ON	OFF	OFF	---	---		12
ON	OFF	ON	ON	OFF	OFF	---	---		13
OFF	ON	ON	ON	OFF	OFF	---	---		14
ON	ON	ON	ON	OFF	OFF	---	---		15
OFF	OFF	OFF	OFF	ON	OFF	---	---		16
ON	OFF	OFF	OFF	ON	OFF	---	---		17
OFF	ON	OFF	OFF	ON	OFF	---	---		18
ON	ON	OFF	OFF	ON	OFF	---	---		19
OFF	OFF	ON	OFF	ON	OFF	---	---		20
ON	OFF	ON	OFF	ON	OFF	---	---		21
OFF	ON	ON	OFF	ON	OFF	---	---		22
ON	ON	ON	OFF	ON	OFF	---	---		23
OFF	OFF	OFF	ON	ON	OFF	---	---		24
ON	OFF	OFF	ON	ON	OFF	---	---		25
OFF	ON	OFF	ON	ON	OFF	---	---		26
ON	ON	OFF	ON	ON	OFF	---	---		27
OFF	OFF	ON	ON	ON	OFF	---	---		28
ON	OFF	ON	ON	ON	OFF	---	---		29
OFF	ON	ON	ON	ON	OFF	---	---		30
ON	ON	ON	ON	ON	OFF	---	---		31
OFF	OFF	OFF	OFF	OFF	ON	---	---		32

Bit 0, Weight 1	Bit 1 Weight 2	Bit 2 Weight 4	Bit 3 Weight 8	Bit 4 Weight 16	Bit 5 Weight 32	Bit 0 Weight 10	Bit 1 Weight 20	Code	Program number
ON	OFF	OFF	OFF	---	---	OFF	OFF	BCD	1
OFF	ON	OFF	OFF	---	---	OFF	OFF		2
ON	ON	OFF	OFF	---	---	OFF	OFF		3
OFF	OFF	ON	OFF	---	---	OFF	OFF		4
ON	OFF	ON	OFF	---	---	OFF	OFF		5
OFF	ON	ON	OFF	---	---	OFF	OFF		6
ON	ON	ON	OFF	---	---	OFF	OFF		7
OFF	OFF	OFF	ON	---	---	OFF	OFF		8
ON	OFF	OFF	ON	---	---	OFF	OFF		9
OFF	OFF	OFF	OFF	---	---	ON	OFF		10
ON	OFF	OFF	OFF	---	---	ON	OFF		11
OFF	ON	OFF	OFF	---	---	ON	OFF		12
ON	ON	OFF	OFF	---	---	ON	OFF		13
OFF	OFF	ON	OFF	---	---	ON	OFF		14
ON	OFF	ON	OFF	---	---	ON	OFF		15
OFF	ON	ON	OFF	---	---	ON	OFF		16
ON	ON	ON	OFF	---	---	ON	OFF		17
OFF	OFF	OFF	ON	---	---	ON	OFF		18
ON	OFF	OFF	ON	---	---	ON	OFF		19
OFF	OFF	OFF	OFF	---	---	OFF	ON		20
ON	OFF	OFF	OFF	---	---	OFF	ON		21
OFF	ON	OFF	OFF	---	---	OFF	ON		22
ON	ON	OFF	OFF	---	---	OFF	ON		23
OFF	OFF	ON	OFF	---	---	OFF	ON		24
ON	OFF	ON	OFF	---	---	OFF	ON		25
OFF	ON	ON	OFF	---	---	OFF	ON		26
ON	ON	ON	OFF	---	---	OFF	ON		27
OFF	OFF	OFF	ON	---	---	OFF	ON		28
ON	OFF	OFF	ON	---	---	OFF	ON		29
OFF	OFF	OFF	OFF	---	---	ON	ON		30
ON	OFF	OFF	OFF	---	---	ON	ON		31
OFF	ON	OFF	OFF	---	---	ON	ON		32

- The program number switches when the input changes from OFF to ON or ON to OFF.
- For binary coded hexadecimal (BCH), Program No. (Bit 0 Weight 1) to Program No. (Bit 5 Weight 32) are used. For binary coded decimal (BCD) Program No. (Bit 0 Weight 1) to Program No. (Bit 3 Weight 8) and Program No. (Bit 0 Weight 10) to Program No. (Bit 1 Weight 20) are used.
- Inputs without program number allocations are treated as OFF.
- If the program number is 0 or 33 or higher, the program number in EEPROM will be used.

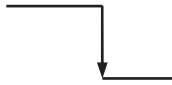
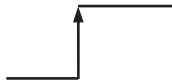

● **Run (ON)/Reset (OFF)**

- When the event input is ON, operation is performed and the Run/Reset parameter is set to “Run.”
- This Run (ON)/Reset (OFF) function creates an operation command that applies to one specific channel.
- Operation is as follows based on the ON/OFF status of the event input:

Event input	Description
	Reset
	Run (program operation)

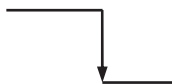

● **Run (OFF)/Reset (ON)**

- When the event input is ON, the Run/Reset parameter is set to “Reset.”
- This Run (OFF)/Reset (ON) function creates an operation command that applies to all channels for coordinated operation and one specific channel for independent control.
- Operation is as follows based on the ON/OFF status of the event input:

Event input	Description
	Run (program operation)
	Reset

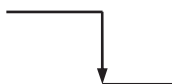

● **Auto (OFF)/Manual (ON)**

- When the event input is ON, the mode switches to Manual Mode.
- The Auto (OFF)/Manual (ON) function creates an operation command that applies to one specific channel.
- Operation is as follows based on the ON/OFF status of the event input:

Event input	Description
	Auto
	Manual

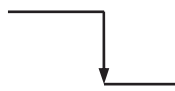

● Program SP (OFF)/ Remote SP (ON)

- This function is valid only when using control with a remote SP.
- When the event input is ON, the remote SP (RSP) is used as the SP. When the event input is OFF, the program SP (PSP) is used as the SP.
- The Program SP (OFF)/Remote SP (ON) function creates an operation command that applies to one specific channel.
- Operation is as follows based on the ON/OFF status of the event input:

Event input	Description
	Program SP Mode
	Remote SP Mode

● Remote SP (OFF)/ Fixed SP (ON)

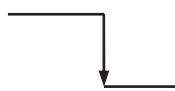
- When the event input is ON, the fixed SP (FSP) is used as the SP. When the event input is OFF, the remote SP (RSP) is used as the SP.
- The Remote SP (OFF)/Fixed SP (ON) function creates an operation command that applies to one specific channel. This function is disabled, however, for channels that do not support the remote SP function.
- Operation is as follows based on the ON/OFF status of the event input:

Event input	Description
	Remote SP Mode
	Fixed SP Mode

● **Program SP (OFF)/ Fixed SP (ON)**

- When the event input is ON, the fixed SP (FSP) is used as the SP. When the event input is OFF, the program SP (PSP) is used as the SP.
- The Program SP (OFF)/Fixed SP (ON) function creates an operation command that applies to one specific channel. This function is disabled, however, for channels 2 to 4 during coordinated operation.
- Operation is as follows based on the ON/OFF status of the event input:

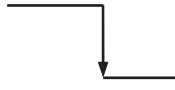
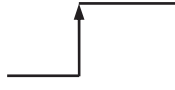
Event input	Description
	Program SP Mode
	Fixed SP Mode

● **Program SP**

- When the event input is ON, the program SP (PSP) is used as the SP. The event input must be reset before this function can be activated again.
- The Program SP function creates an operation command that applies to one specific channel. This function is disabled, however, for channels 2 to 4 during coordinated operation.
- Operation is as follows based on the ON/OFF status of the event input:

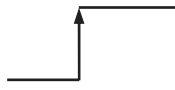
Event input	Description
	Program SP Mode

● **Remote SP**

- When the event input is ON, the remote SP (RSP) is used as the SP. The event input must be reset before this function can be activated again.
- The Remote SP function creates an operation command that applies to one specific channel. This function is disabled, however, for channels that do not support the remote SP function.
- Operation is as follows based on the ON/OFF status of the event input:

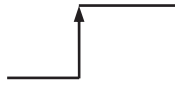
Event input	Description
	Remote SP Mode

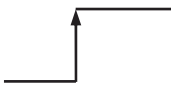

● Fixed SP

- When the event input is ON, the fixed SP (FSP) is used as the SP. The event input must be reset before this function can be activated again.
- The Fixed SP function creates an operation command that applies to one specific channel.
- Operation is as follows based on the ON/OFF status of the event input:

Event input	Description
	Fixed SP Mode

● Hold (ON)/Clear Hold (OFF)

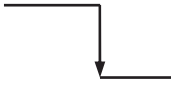
- When the event input is ON, the program is on hold and this status is held until the event input changes to OFF.
- The Hold (ON)/Clear Hold (OFF) function creates an operation command that applies to one specific channel. During coordinated operation, however, the operation command applies to all channels.
- This function is enabled only during program operation.
- Operation is as follows based on the ON/OFF status of the event input:

Event input	Description
	Clear Hold Mode
	Hold Mode

● Advance

- When the event input is ON, the segment is advanced to the beginning of the next segment. The event input must be reset before this function can be activated again.
- The advance function creates an operation command that applies to one specific channel. During coordinated operation, however, the operation command applies to all channels.
- This function is enabled only during program operation.
- Operation is as follows based on the ON/OFF status of the event input:

Event input	Description
	Advance Mode

● **Back**

- When the event input is ON, the program returns to the start of the current segment being executed. The event input must turn OFF once before this function can be used again.
- The back function creates an operation command that applies to one specific channel. During coordinated operation, however, the operation command applies to all channels.
- This function is enabled only during program operation.
- Operation is as follows based on the ON/OFF status of the event input:

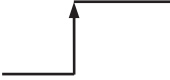
Event input	Description
	Back Mode

Display characters	Parameter names	Level (Display No. 3)	Use
E.V.*	Event Input 1 to 10 Assignment	Control Initial Setting 2 Level (L, R)	Event input specification

*: 1 to 10

5.9 Using a Transfer Output

Transfer Output Settings

Control/Transfer Output Assignments

- For a transfer output, use an output that is not being used as a control output.
- A transfer output can be used to output one of the following five types of data as selected in the Control/Transfer Output Assignment parameters.
 - (1) Present Set Point
 - (2) Present Value (PV)
 - (3) MV (Heating)
 - (4) MV (Cooling)
 - (5) Valve Opening

For more information, refer to 8.13 Control Initial Setting 2 Level (L2) Control/Transfer Output 1 to 4 Assignments (P. 8-64).

The heating and cooling MVs can be output only from a Standard Control Model, and the valve opening can be output only from a Position-proportional Control Model with a potentiometer connected.

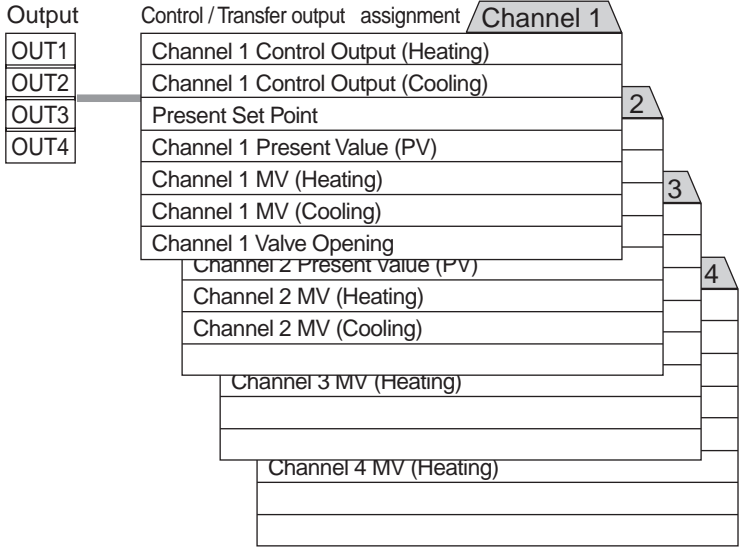

● Transfer Output Scaling

- Scaling of the output value can be performed using Transfer Output Upper Limit and Transfer Output Lower Limit parameters. The upper-limit can be set to a smaller value than the lower limit to perform reverse scaling. The scale can be enlarged using the width between the upper and lower limits specified in the parameters. The following diagram shows an example of scaling the heating MV.

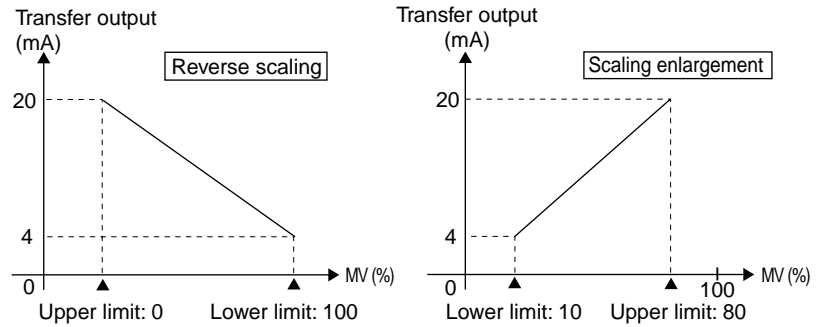

- If the Input Type, Scaling Input Value 1 or 2, SP Upper and Lower Limit, or Temperature Unit parameter is changed, the Transfer Output Upper Limit and Transfer Output Lower Limit parameters will be returned to the upper and lower limits of the setting range.
- If an input error occurs when the transfer output assignment is set to “PV,” the transfer output changes to the upper limit and it changes to the lower limit for reverse scaling.

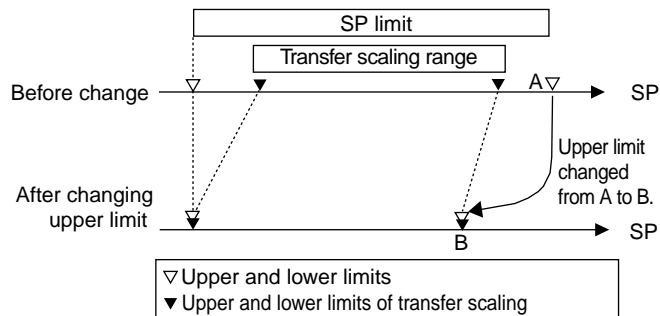

Display	Parameter	Level (Display No. 3)	Use
āūē. *	Control/Transfer Output 1 to 4 Assignment	Control Initial Setting 2 (L. 2)	Specify Control/Transfer Output
ērh. *	Transfer Output 1 to 4 Upper Limit and	Control Initial Setting 2 (L. 2)	Transfer Output Scaling
ērl. *	Transfer Output 1 to 4 Lower Limit		

*: 1 to 4

5.10 Using Communications

■ Setting Communications Parameters

Communications parameters are set in the Communications Setting Level. The parameters and settings are listed in the following table.

Display	Parameter	Set values	Description
<i>P5E1</i>	Protocol Selection	<i>[UF / odd]</i>	CompoWay/F or Modbus
<i>U-nd</i>	Communications Unit No.	0, <i>1</i> to 99	0 to 99
<i>bP5</i>	Communications Speed	<i>9.6</i> /19.2/38.4	9.6, 19.2, or 38.4 (kbits/s)
<i>LEn</i>	Communications Data Length	<i>7</i> /8 (bit)	7/8 (bits)
<i>5b2t</i>	Communications Stop Bit	1/ <i>2</i>	1/2 (bits)
<i>PrtY</i>	Communications Parity	<i>noneE / EvEn / odd</i>	None, even, or odd
<i>5bYt</i>	Transmission Wait Time	0 to <i>20</i> to 99	0 to 99 (ms)

* Default settings are highlighted.

● Parameter Descriptions

Protocol Selection (*P5E1*)

The communications protocol can be set to CompoWay/F (OMRON'S unified protocol for general-purpose serial communications), or Modbus (based on RTU Mode of Modbus Protocol (specifications: PI-MBUS-300 Rev.I) of Modicon Inc.).

Communications Unit No. (*U-nd*)

When performing communications with a host computer, a unit number must be set for each Controller to allow the host computer to recognize it. Any number from 0 to 99 can be set. The unit number is set to 1 by default. When using multiple Controllers, make sure that no Controllers have the same unit number or communications will not take place correctly. After setting a unit number, turn OFF the power and then turn it ON again to enable the new unit number.

Communications Speed (*bP5*)

Set the baud rate for communications with a host computer. The following speeds are possible:

9.6 (9,600 bit/s), 19.2 (19,200 bit/s), or 38.4 (38,400 bit/s)

After setting the baud rate, turn OFF the power and then turn it ON again to enable the new baud rate.

Communications Data Length (*LEn*)

The communications data length can be set to 7 bits or 8 bits.

Communications Stop Bit (*5b2t*)

The number of communications stop bits can be set to 1 or 2 bits.

Communications Parity (*PrtY*)

The communications parity can be set to none (*noneE*), even (*EvEn*), or odd (*odd*).

Transmission Wait Time (*5bYt*)

After changing the transmission wait time, perform a software reset or turn the power OFF and then ON to enable the new setting.

Hint
For information on communications procedures, refer to *Section 6 CompoWay/F Communications* (P. 6-1) or *Section 7 Modbus Communications* (P. 7-1) depending on the communications protocol you are using.

● **Procedure**

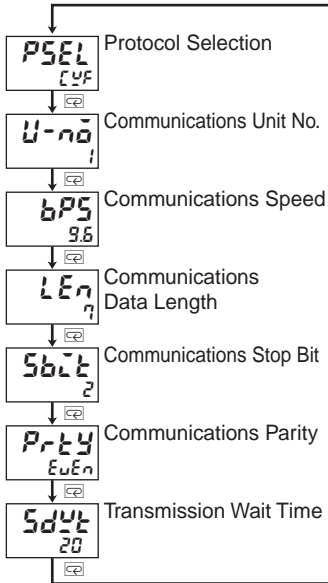

Configure communication setting data in accordance with the other computers

Before performing communications, perform the following steps to set the communications unit number, communications speed, and other communications parameters.

1. Hold down the Key for 3 seconds to move from the Operation Level to the Input Initial Setting Level.
2. Press the Key to move from the Input Initial Setting Level to the Communications Setting Level.
3. Press the Key to scroll through the setting items as shown at left.
4. Press the and Keys to change a setting.

■ **Communications Writing**

To allow a host computer to write parameters to a Controller, set the Communications Writing parameter (Adjustment Level) to $\bar{a}n$ (Enabled).

● **Procedure**

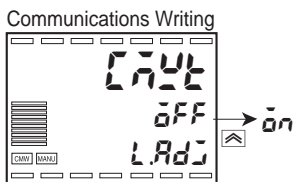

1. Press the Key for less than 1 second to move from the Operation Level to the Adjustment Level.
2. Press the Key to set the Communications Writing parameter to $\bar{a}n$.

Important
Parameters can be written 100,000 times. If you will be writing parameters frequently, set the RAM Write Mode parameter (Advanced Function Setting Level).

Section 6 CompoWay/F Communications

6.1	Communications Method	6-2
6.2	Frames.....	6-4
6.3	FINS-mini Text	6-6
6.4	Variable Areas	6-7
6.5	Read from Variable Area	6-10
6.6	Write to Variable Area.....	6-11
6.7	Operation Commands.....	6-13
6.8	Setting Areas	6-15
6.9	Commands and Responses	6-17
6.10	Program Example	6-40

6.1 Communications Method

■ CompoWay/F Communications

CompoWay/F is an OMRON protocol for general-purpose serial communications. CompoWay/F features a unified frame format and FINS-compliant commands, which have a long record of successful use with OMRON Programmable Controllers. CompoWay/F simplifies communications between multiple components and between components and a computer.

FINS (Factory Interface Network Service)

FINS is a protocol for message communications between Controllers on an OMRON factory automation network.

Supplement

Communications are implemented by creating a program on the host computer. The descriptions in this section are therefore from the perspective of the host computer. For example, “reading” and “writing” refer to the host computer reading from and writing to the E5AR-T/ER-T.

■ Communications Specifications

Transfer connection	Multi-point
Communications method	RS-485 (2-wire, half duplex)
Synchronization method	Start-stop
Baud rate	9.6, 19.2, or 38.4 Kbits/s
Send code	ASCII
Data length	7 or 8 bits
Stop bit length	1 or 2 bits
Error detection	Vertical parity: None, even, or odd BCC (Block Check Character)
Flow control	None
Interface	RS-485
Retry function	None
Communications buffer	217 bytes
Communications response send wait time	0 to 99 ms Default: 20 ms

Note: Default settings are shaded.

Transfer Protocol

The host computer sends a command frame, and the E5AR-T/ER-T returns a response frame based on the contents of the command frame. One response frame is sent in response to one command frame.

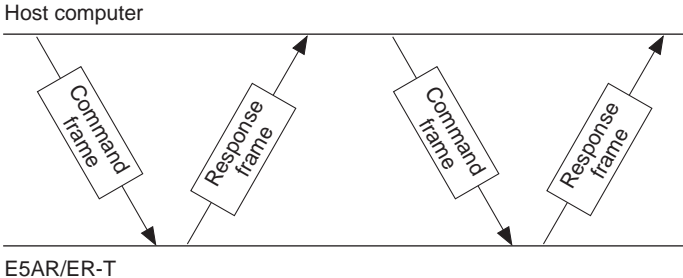

The exchange of the command frame and response frame is described below.

After receiving a response from the Controller, have the host computer wait at least 5 ms before sending the next command.

When writing multiple sets of parameters in a row, such as when writing to the variable area or performing a compound write, control characteristics may be affected. Observe the following points.

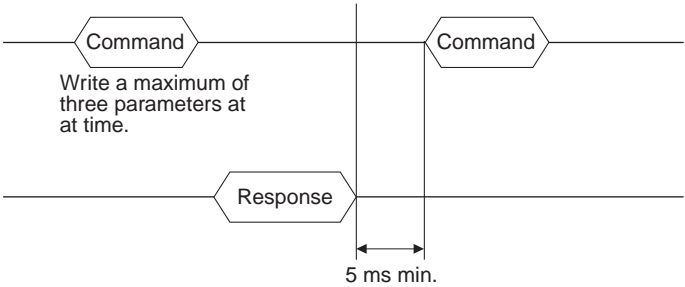

6.2 Frames

Commands from the host computer and responses from the E5AR-T/ER-T take the form of frames that conform to the CompoWay/F protocol. The data included in command frames and response frames is described in this section.

In the following descriptions, an “H” following a numeric value (for example 02H) indicates that the value is a hexadecimal number. Numbers or letters enclosed in quotation marks (for example “00”) are ASCII data.

■ Command Frames

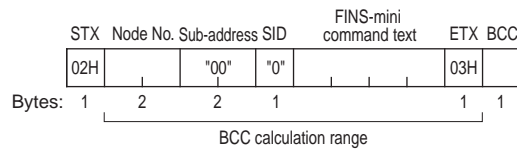

STX	A code that indicates the beginning of a communications frame (02H). Be sure to set this code in the leading byte.
Node No.	The node number specifies the destination. Specify the unit number of the E5AR-T/ER-T. When broadcasting to all nodes, specify “XX.” Responses are not returned for broadcasts.
Sub-address	Not used on the E5AR-T/ER-T. Always set to “00.”
SID (Service ID)	Not used on the E5AR-T/ER-T. Always set to 0.
FINS-mini command text	The text of the command.
ETX	A code that indicates the end of the text (03H).
BCC	Block Check Character This byte stores the result of the BCC calculation from the node number through EXT.

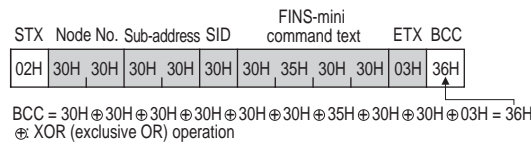

■ Response Frames

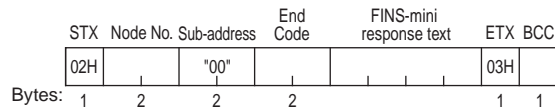

STX	A code that indicates the beginning of the communications frame (02H). This code is always set in the leading byte.
Node No.	The unit number that was specified in the command frame is returned here. This is the unit number of the responding E5AR-T/ER-T.
Sub-address	Not used on the E5AR-T/ER-T. Always set to "00."
End code	Returns the result of execution for the command frame.
FINS-mini response text	Text of the response.
ETX	A code that indicates the end of the text (03H).
BCC	Block Check Character This byte stores the result of the BCC calculation from the node number through EXT.

● End Codes

End code	Name	Meaning	Error detection priority
"0F"	FINS command error	Could not execute the specified FINS command.	8
"10"	Parity error	Sum of bits that are "1" in received data does not agree with the communications parity.	2
"11"	Framing error	Stop bit of command frame characters is 0.	1
"12"	Overrun error	Attempted to transfer new data when reception data buffer is already full.	3
"13"	BCC error	Calculated BCC is different from received BCC.	5
"14"	Format error	Characters other than "0" to "9" or "A" to "F" are contained in the FINS-mini Command Text or, for Echoback Test, data other than the test data was returned. No SID and FINS-mini Command Text, or no FINS-mini Command Text. MRC/SRC are not correct in FINS-mini Command Text.	7
"16"	Sub-address error	No sub-address, SID, or FINS-mini Command Text; or sub-address is less than 2 characters and no SID and FINS-mini Command Text.	6
"18"	Frame length error	The command frame exceeds the specified number of bytes.	4
"00"	Normal end	Command was executed normally without error.	None

Supplement

A response is not sent to command frames that do not end with the ETX.BCC characters.

6.3 FINS-mini Text

The FINS-mini Command Text and FINS-mini Response Text form the body of command/response communications. FINS-mini Command Text and FINS-mini Response Text are set as described in this section.

● Command Text

FINS-mini Command Text consists of a main request code (MRC) and a sub-request code (SRC), followed by the required data.

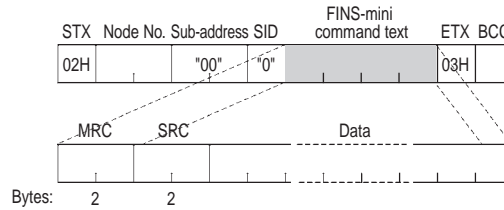

● Response Text

FINS-mini Response Text consists of the MRC and SRC, followed by a main response code (MRES) and sub-response code (SRES), and then the required data.

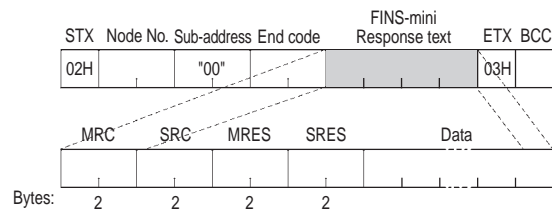

If the specified FINS-mini command was not successfully executed, the response will contain only the MRC, SRC, MRES and SRES.

● List of FINS-mini Commands for CompoWay/F

MRC	SRC	Command name	Description
"01"	"01"	Read from Variable Area	Reads monitor values or set values.
"01"	"02"	Write to Variable Area	Writes set values.
"01"	"04"	Composite Read from Variable Area	Reads multiple monitor values or set values.
"01"	"13"	Composite Write to Variable Area	Writes multiple set values.
"01"	"10"	Composite Registration Read	Reads in order the contents of addresses specified for the Composite Read Registration command.
"01"	"11"	Composite Read Registration	Specifies the addresses to be read for the Composite Read from Variable Area command.
"01"	"12"	Composite Read Registration Confirmation	Reads the contents of the registration for the Composite Read from Variable Area command.
"05"	"03"	Controller Attribute Read	Reads the model.
"06"	"01"	Controller Status Read	Reads the operating status.
"08"	"01"	Echoback Test	Performs an echoback test.
"30"	"05"	Operation Commands	Executes operation commands, such as Run/Reset, AT Execute/Cancel, and Move to Setting Area 1.

6.4 Variable Areas

The areas used for data exchange when communicating with the E5AR-T/ER-T are called the variable areas. Present values can be read, and set values can be read and written using the variable areas of the E5AR-T/ER-T.

Operation commands and reading Controller attributes do not use the variable areas.

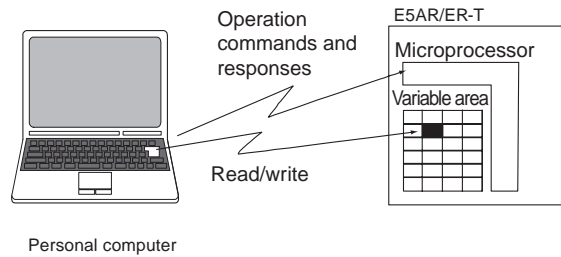

A variable areas is accessed by specifying the position of a variable within a variable area using the variable type and address.

■ Variable Types

The following table lists the variable types in the variable area.

Variable type	Description	Area
C4	Communications Monitor	Setting area 0 (Operation in progress.)
C5	Protect Level	
C6	Operation Level	
C7	Adjustment Level	
C8	Adjustment 2 Level	
C9	Alarm Set Setting Level	
CA	PID Setting Level	
CB	Approximation Setting Level	
D8	Program Setting Level	
D9	Time Signal Setting Level	
CC	Input Initial Setting Level	Setting area 1 (Operation stopped.)
CD	Control Initial Setting Level	
CE	Control Initial Setting 2 Level	
CF	Alarm Setting Level	
D0	Display Adjustment Level	
D1	Communications Setting Level	
D2	Advanced Function Setting Level	
D3	Expansion Control Setting Level	

■ Addresses

Addresses are allocated within each variable type. Addresses are two bytes long and written in hexadecimal. Addresses are allocated according to access size. Each address consists of a channel identifier and the address in the area.

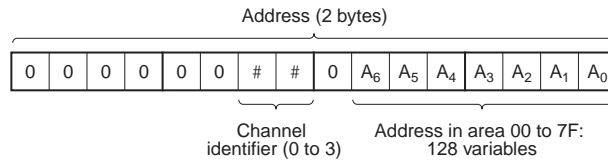

* Bits other than those for the channel identifier and the address in the area are used for variable types DA to F9.

● Channel Identifier

To specify channels 2 to 4 for Controllers with more than one input channel, specify a channel identifier between 1 and 3 to identify the channel. Only 0 (channel 1) can be specified for Controllers with only one input channel.

Channel identifier	Channel
0	Channel 1
1	Channel 2
2	Channel 3
3	Channel 4

● Address in Area

This address is allocated a parameter in the variable areas. Addresses are assigned in order beginning from the first parameter.

For more information on addresses, refer to *Appendix Setting Lists* (P. A-6).

The addresses indicated in the setting list are the addresses for channel 1. To specify an address of channel 2, for example, add 0100 to the address in the setting list. For channel 3, add 0200, and for channel 4, add 0300.

■ Number of Elements

The number of elements is expressed as a 2-byte hexadecimal number. For example, if the number of elements is 0010, the first 16 elements of data (H'10) from the address are specified.

The specification range for the number of elements depends on the command. Refer to *6.9 Commands and Responses* (P. 6-17) for more information.

■ Set Values

Values read and written to a variable area are expressed in hexadecimal and disregard the decimal point. Negative values are expressed as a two's complements.

Example: D'105.0 → H'0000041A

This variable is an 8-digit number in hexadecimal. Negative values are expressed as a two's complement. The decimal is disregarded. If the PV of the E5AR-T/ER-T is 105.0, it will be read as H'0000041A (105.0 → 1050 → H'0000041A). If data that uses the program time unit is read and is displayed as 99.59, the read data will be H'000026E7 (99.59 → 9959 → H'000026E7).

6.5 Read from Variable Area

Read from a variable area by setting the required data in the following FINS-mini command text format.

Command

FINS-mini Command Text

MRC	SRC	Variable type	Read start address	Bit position	Number of elements
"01"	"01"			"00"	
2	2	2	4	2	"0001" to "0019"

Data name	Description
MRC/SRC	Specify the Read from Variable Area FINS-mini command.
Variable type	Specify the variable type.
Read start address	Specify the first address to read.
Bit position	Not used on the E5AR-T/ER-T. Specify "00."
Number of elements	Specify the number of variables to read (max. of 25 (H'19)). Not needed for a compound read.

Response

FINS-mini Response Text

MRC	SRC	Response code (MRES/SRES)	Read data
"01"	"01"		
2	2	4	Number of elements × 8 bytes (for compound read, number of elements × 10 bytes)

Data name	Description
MRC/SRC	The FINS-mini command text is returned here.
Response code	Result of execution of the command.
Read data	Data that was read.

Response Codes

Response code	Error name	Description
"1001"	Command length too long	The command is too long.
"1002"	Command length too short	The command is too short.
"1101"	Area type error	Incorrect variable type.
"110B"	Response length too long	Number of elements is greater than 25 (H'0019).
"1100"	Parameter error	Specified bit position is not "00."
"2203"	Operation error	Unit error, unit change, display unit error, or EEPROM error.
"0000"	Normal end	---

6.6 Write to Variable Area

Write to a variable area by setting the required data in the following FINS-mini command text format.

Command

FINS-mini Command Text

MRC	SRC	Variable type	Write start address	Bit position	Number of elements	Write data
"01"	"02"			"00"	"0001" to "0018"	
2	2	2	4	2	4	

Data name	Description
MRC/SRC	Specify the Write to Variable Area FINS-mini command.
Variable type	Specify the variable type.
Write start address	Specify the first address to write.
Bit position	Not used on the E5AR-T/ER-T. Specify "00."
Number of elements	Specify the number of variables to be written (max. of 25 (H'18)). Not needed for a compound write.
Write data	Enter the data to be written.

Response

FINS-mini Response Text

MRC	SRC	Response code (MRES/SRES)
"01"	"02"	
2	2	4

Data name	Description
MRC/SRC	FINS-mini command text is returned here.
Response code	Result of execution of the command.

Response Codes

Response code	Error name	Description
"1002"	Command length too short	The command is too short.
"1101"	Area type error	Incorrect variable type.
"1003"	Number of elements/data number do not agree	The specified number of elements does not agree with the actual number of data elements.
"1100"	Parameter error	Specified bit position is not "00." Write data was outside of setting range.

Response code	Error name	Description
"2203"	Operation error	<ul style="list-style-type: none"> • Unable to execute because the communications writing function is disabled. • Write to setting area 1 was attempted from setting area 0. • Write to parameters in Protect Level was attempted from a different level. • AT is being executed. • Calibration Level is being used. • Unit error, unit change, display unit error, or EEPROM error. • Program number changed during programmed operation.
"0000"	Normal end	---

6.7 Operation Commands

Operation commands are sent using the following FINS-mini command text format.

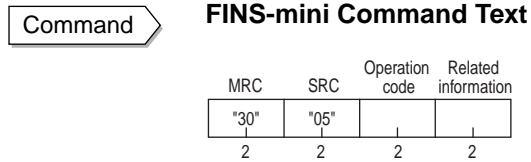

Data name	Description
MRC/SRC	Specify the Operation Command FINS-mini command.
Operation code	Specify the operation code.
Related information	Specify information related to the command.

The operation commands that are supported by the E5AR-T/ER-T are listed in the following table.

Operation code	Name	Related information	
		Higher byte	Lower byte
"00"	Communications Writing	0 *1	0: OFF (disabled) 1: ON (enabled)
"01"	Run/Reset	0 to 3, F *2	0: Run 1: Reset
"03"	AT Execute	0 to 3, F *2	0: Current PID set number 1 to 8: PID set number
"04"	RAM Write Mode	0 *1	0: Backup Mode 1: RAM Write Mode
"05"	Save RAM Data	0 *1	0
"06"	Software Reset	0 *1	0
"07"	Move to Setting Area 1	0 *1	0
"08"	Move to Protect Level	0 *1	0
"09"	Auto/Manual	0 to 3, F *2	0: Auto Mode 1: Manual Mode
"0A"	AT Cancel	0 to 3, F *2	0: Cancel
"0B"	Parameter Initialization	0 *1	0
"0C"	Alarm Latch Cancel	0 to 3, F *2	0
"0D"	SP Mode	0 to 3, F *2	0: PSP 1: RSP 2: FSP
"12"	Hold	0 to 3, F *2	0: Hold Cancel 1: Hold
"13"	Advance	0 to 3, F *2	0
"14"	Back	0 to 3, F *2	0

*1: Executed for all channels.

*2: Specify the channel.

0: CH1, 1: CH2, 2: CH3, 3: CH4, F: All channels

Note: When all channels is specified, only enabled channels will respond and processing will begin from channel 1. If an error is detected on any one channel, an operation error will occur. If all channels end normally, a normal end will occur.



When cascade control is selected for the control mode, specify channel 2 commands for the following operation commands:

- Run/Reset
- Auto/Manual
- SP Mode
- Cascade Open/Close

Response

FINS-mini Response Text

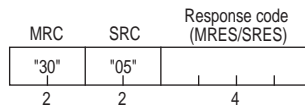

Data name	Description
MRC/SRC	FINS-mini command text is returned here.
Response code	Result of execution of the command.

Response Codes

Response code	Error name	Description
"1001"	Command length too long	The command is too long.
"1002"	Command length too short	The command is too short.
"1100"	Parameter error	Operation code or related information is not correct.
"2203"	Operation error	<ul style="list-style-type: none"> • Unable to execute because the communications writing function is disabled. • Unable to execute operation command. For more information, refer to corresponding operation command description in <i>6.9 Commands and Responses</i>. • Unit error, unit change, display unit error, or EEPROM error.
"0000"	Normal end	---

6.8 Setting Areas

The E5AR-T/ER-T has two setting areas for communications: Setting area 0 and setting area 1.

In setting area 0, operation continues. Setting area 0 makes it possible to perform operations that require operation to be in progress, such as reading the PV, writing an SP, and starting/resetting operation (Run/Reset), as well as operations that do not interfere with control. On the other hand, operations that may change control, such as writing initial set values, cannot be performed. (Set values that cannot be written can still be read.)

In setting area 1, operation is stopped. This makes it possible to perform operations such as writing initial set values, which cannot be written in setting area 0.

When the power is turned ON, setting area 0 is selected. To access setting area 1, use the Move to Setting Area 1 operation command. To return to setting area 0 from setting area 1, turn OFF the power or use the Software Reset operation command.

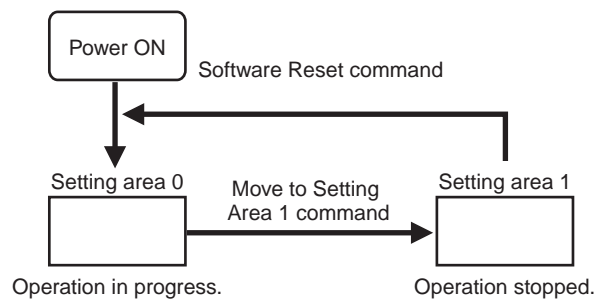

Variable type	Description	Area
C4	Communications Monitor	Setting area 0 (Operation in progress.)
C5	Protect Level	
C6	Operation Level	
C7	Adjustment Level	
C8	Adjustment 2 Level	
C9	Alarm Set Setting Level	
CA	PID Setting Level	
CB	Approximation Setting Level	
D8	Program Setting Level	
D9	Time Signal Setting Level	

Variable type	Description	Area
CC	Input Initial Setting Level	Setting area 1 (Operation stopped.)
CD	Control Initial Setting Level	
CE	Control Initial Setting 2 Level	
CF	Alarm Setting Level	
D0	Display Adjustment Level	
D1	Communications Setting Level	
D2	Advanced Function Setting Level	
D3	Expansion Control Setting Level	

6.9 Commands and Responses

The E5AR-T/ER-T provides a set of commands that read from variable areas, write to variable areas, execute operation commands, and execute other services provided by the CompoWay/F communications protocol. The commands supported by the E5AR-T/ER-T are described below.

■ Reading Monitor Values

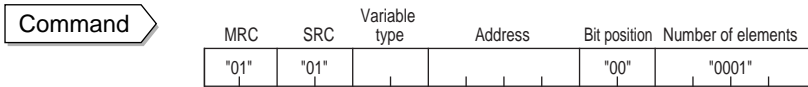

Variable type	Address	Monitor value		Address	Monitor value	
		Ch	Parameter name		Ch	Parameter name
"C0"	"0000"	1	PV	"0200"	3	PV
	"0001"		Status	"0201"		Status
	"0002"		Internal SP	"0202"		Internal SP
	"0003"		None	"0203"		None
	"0004"		MV Monitor (Heating)	"0204"		MV Monitor (Heating)
	"0005"		MV Monitor (Cooling)	"0205"		MV Monitor (Cooling)
	"0100"	2	PV	"0300"	4	PV
	"0101"		Status	"0301"		Status
	"0102"		Internal SP	"0302"		Internal SP
	"0103"		None	"0303"		None
	"0104"		MV Monitor (Heating)	"0304"		MV Monitor (Heating)
	"0105"		MV Monitor (Cooling)	"0305"		MV Monitor (Cooling)
"C1"	"0003"	1	Present Set Point	"0203"	3	Present Set Point
	"0004"		Alarm Set 1 Alarm Value 1	"0204"		Alarm Set 1 Alarm Value 1
	"0005"		Alarm Set 1 Alarm Value Upper Limit 1	"0205"		Alarm Set 1 Alarm Value Upper Limit 1
	"0006"		Alarm Set 1 Alarm Value Lower Limit 1	"0206"		Alarm Set 1 Alarm Value Lower Limit 1
	"0007"		Alarm Set 1 Alarm Value 2	"0207"		Alarm Set 1 Alarm Value 2
	"0008"		Alarm Set 1 Alarm Value Upper Limit 2	"0208"		Alarm Set 1 Alarm Value Upper Limit 2
	"0009"		Alarm Set 1 Alarm Value Lower Limit 2	"0209"		Alarm Set 1 Alarm Value Lower Limit 2
	"0103"	2	Present Set Point	"0303"	4	Present Set Point
	"0104"		Alarm Set 1 Alarm Value 1	"0304"		Alarm Set 1 Alarm Value 1
	"0105"		Alarm Set 1 Alarm Value Upper Limit 1	"0305"		Alarm Set 1 Alarm Value Upper Limit 1
	"0106"		Alarm Set 1 Alarm Value Lower Limit 1	"0306"		Alarm Set 1 Alarm Value Lower Limit 1
	"0107"		Alarm Set 1 Alarm Value 2	"0307"		Alarm Set 1 Alarm Value 2
	"0108"		Alarm Set 1 Alarm Value Upper Limit 2	"0308"		Alarm Set 1 Alarm Value Upper Limit 2
	"0109"		Alarm Set 1 Alarm Value Lower Limit 2	"0309"		Alarm Set 1 Alarm Value Lower Limit 2

Variable type	Address	Monitor value		Address	Monitor value	
		Ch	Parameter name		Ch	Parameter name
"C4"	"0005"	1	PID Set Number Monitor	"0205"	3	PID Set Number Monitor
	"0006"		Status	"0206"		Status
	"0007"		Program Status	"0207"		Program Status
	"0008"		Alarm Set Number Monitor	"0208"		Alarm Set Number Monitor
	"0105"	2	PID Set Number Monitor	"0305"	4	PID Set Number Monitor
	"0106"		Status	"0306"		Status
	"0107"		Program Status	"0307"		Program Status
	"0108"		Alarm Set Number Monitor	"0308"		Alarm Set Number Monitor

This command is used to read present values, status, and other monitor values. The number of elements can be set from 0002 to 0019 to allow reading monitor values in consecutive addresses.

When used in setting area 1, the response for the present value and internal SP will be 0 and the response for the status will be as indicated in the notes in *E5-R-T Status (Communications)* (P. A-8).

Response

MRC	SRC	Response code	Data
"01"	"01"	"0000"	Monitor value

Response Codes:

The response for a normal end is shown above. For the response codes, refer to *6.5 Read from Variable Area* (P. 6-10).

Reading Set Values

Command

MRC	SRC	Variable type	Address	Bit position	Number of elements
"01"	"01"			"00"	"0001"

Variable type	Address	Parameters	
		Ch	Description
"C5"	"0000" to "004F"	1	Parameters in setting area 0
"C6"			Protect Level
"C7"	"0100" to "014F"	2	Operation Level
"C8"			Adjustment Level
"C9"	"0200" to "024F"	3	Adjustment 2 Level
"CA"			Alarm Set Setting Level
"CB"	"0300" to "034F"	4	PID Setting Level
"D8"			Approximation Setting Level
"D9"			Program Setting Level Time Signal Setting Level

Variable type	Address	Parameters	
		Ch	Description
"CC"	"0000" to "003B"	1	Parameters in Setting Area 1 Input Initial Setting Level Control Initial Setting Level Control Initial Setting 2 Level Alarm Setting Level Display Adjustment Level Communications Setting Level Advanced Function Setting Level Expansion Control Setting Level
"CD"	"0100" to "013B"	2	
"CE"			
"CF"			
"D0"	"0200" to "023B"	3	
"D1"			
"D2"			
"D3"	"0300" to "033B"	4	

This command is used to read set values. The number of elements can be set from 0002 to 0019 to allow reading 2 to 25 set values in consecutive addresses.

To specify variable types and addresses, refer to *Appendix Setting Lists* (P. A-6). The upper limit of an address depends on the variable type.

This command can be used in both setting area 0 and setting area 1. When used in setting area 1, the response for the remote SP monitor, ramp SP monitor, and valve opening monitor will be 0 and the response for the status is as indicated in the notes in *E5 R-T Status (Communications)* (P. A-8).

Response

MRC	SRC	Response code	Data
"01"	"01"	"0000"	Set value

Response Codes:

The response for a normal end is shown above. For the response codes, refer to *6.5 Read from Variable Area* (P. 6-10).

■ Composite Read from Variable Area

Command

MRC	SRC	Variable type	Address	Bit position	Variable type	Address	Bit position
"01"	"04"			"00"			"00"
		Variable type	Address	Bit position			"00"

Variable type	Address	Parameters	
		Ch	Description
"C4"	"0000" to "0008"	1	Monitor values
	"0100" to "0108"	2	
	"0200" to "0208"	3	
	"0300" to "0308"	4	

Variable type	Address	Parameters	
		Ch	Description
"C5" to "CB" "D8" to "D9"	"0000" to "004F"	1	Parameters in setting area 0
	"0100" to "014F"	2	
	"0200" to "024F"	3	
	"0300" to "034F"	4	
"CC" to "D3"	"0000" to "003B"	1	Parameters in setting area 1
	"0100" to "013B"	2	
	"0200" to "023B"	3	
	"0300" to "033B"	4	

Multiple monitor values or set values can be read by sending a single command. Up to 20 items can be read even if the addresses are not consecutive.

To specify variable types and addresses, refer to *Appendix Setting Lists* (P. A-6). The upper limit of an address depends on the variable type.

This command can be used in both setting area 0 and setting area 1.

If an area type error or a set value error occurs in any of the data being read, no data will be read.

Response

MRC	SRC	Response code	Variable type	Data
"01"	"04"	"0000"	Type	Monitor value/Set value
			Variable type	Data
			Type	Monitor value/Set value

Response Codes:

The response for a normal end is shown above. For the response codes, refer to *6.5 Read from Variable Area* (P. 6-10).

■ Writing Set Values in Protect Level

Command

MRC	SRC	Variable type	Address	Bit position	Number of elements	Data
"01"	"02"	"C5"		"00"	"0001"	Set values

Address	Parameter
"0000"	Operation Adjustment Protection
"0001"	Initial Setting Protection
"0002"	Setting Change Protection
"0003"	PF Key Protection

This command writes set values in the Protect Level. Refer to 5.5 *Protecting Settings* (P. 5-23) for information on Protect Level.

This command is used in setting area 0. An operation error will occur if it is used in setting area 1.

To use this command, first enable using the communications writing function by executing the Communications Writing operation command, and then move to Protect Level by executing the Move to Protect Level operation command.

Response

MRC	SRC	Response code
"01"	"02"	"0000"

Response Codes:

The response for a normal end is shown above. For the response codes, refer to 6.6 *Write to Variable Area* (P. 6-11).

■ Writing Set Values

Command

MRC	SRC	Variable type	Address	Bit position	Number of elements	Data
"01"	"02"			"00"	"0001"	Set values

Variable type	Address	Parameter	
		Ch	Description
"C5"	"0000" to "004F"	1	Parameters in setting area 0
"C6"			
"C7"	"0100" to "014F"	2	Operation Level
"C8"			
"C9"			
"CA"	"0200" to "024F"	3	Adjustment Level
"CB"			
"D8"	"0300" to "034F"	4	Adjustment 2 Level
"D9"			

Variable type	Address	Parameter	
		Ch	Description
"CC"	"0000" to "003B"	1	Parameters in Setting Area 1 Input Initial Setting Level Control Initial Setting Level Control Initial Setting 2 Level Alarm Setting Level Display Adjustment Level Communications Setting Level Advanced Function Setting Level Expansion Control Setting Level
"CD"	"0100" to "013B"	2	
"CE"			
"CF"	"0200" to "023B"	3	
"D0"			
"D1"			
"D2"			
"D3"	"0300" to "033B"	4	

This command is used to write set values. The number of elements can be set from 2 to 24 to write set values at consecutive addresses.

To specify an address, refer to *Appendix Setting Lists* (P. A-6).

Parameters in setting area 1 can be written from setting area 1. An operation error will occur if parameters are written from setting area 0.

To use this command, the communications writing function must be enabled using the Communications Writing operation command.

To store the set values for Operation, Program Setting, Adjustment, Adjustment 2, Alarm Set Setting, PID Setting, Time Signal Setting, or Approximation Setting Level in EEPROM, select "Backup Mode" and execute the RAM Write Mode command. If "Backup Mode" is not selected, the set values will not remain in memory when the power is turned OFF. For more information on the above levels, refer to *4.1 Setting Levels and Key Operations* (P. 4-2).

Response

MRC	SRC	Response code
"01"	"02"	"0000"

Response Codes:

The response for a normal end is shown above. For the response codes, refer to *6.6 Write to Variable Area* (P. 6-11).

■ Set Value Compound Write

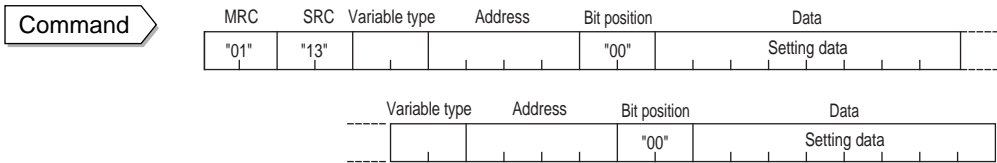

Variable type	Address	Parameters	
		Ch	Description
"C5" to "CB" "D8" to "D9"	"0000" to "004F"	1	Parameters in setting area 0
	"0100" to "014F"	2	
	"0200" to "024F"	3	
	"0300" to "034F"	4	
"CC" to "D3"	"0000" to "003B"	1	Parameters in setting area 1
	"0100" to "013B"	2	
	"0200" to "023B"	3	
	"0300" to "033B"	4	

Multiple set values can be written by sending a single command. Up to 12 items can be written even if the addresses are not consecutive.

To specify variable types and addresses, refer to *Appendix Setting Lists* (P. A-6).

Parameters in setting area 1 is written in setting area 1. An operation error will occur if parameters are written in setting area 0.

To use this command, the communications writing function must be enabled using the Communications Writing operation command.

To store the set values for Operation, Program Setting, Adjustment, Adjustment 2, Alarm Set Setting, PID Setting, Time Signal Setting, or Approximation Setting Level in EEPROM, select "Backup Mode" and execute the RAM Write Mode command. If "Backup Mode" is not selected, the set values will not remain in memory when the power is turned OFF. For more information on the above levels, refer to *4.1 Setting Levels and Key Operations* (P. 4-2).

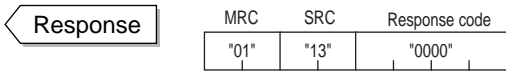

Response Codes:

The response for a normal end is shown above. For the response codes, refer to *6.6 Write to Variable Area* (P. 6-11).

■ Composite Read Registration

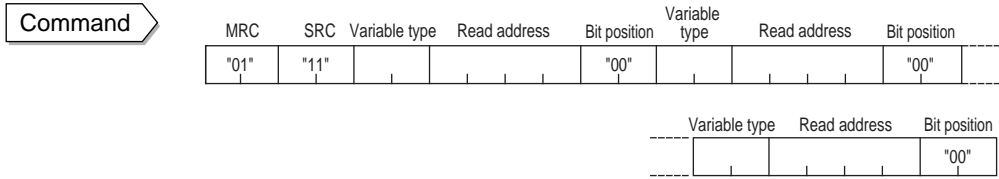

Variable type	Address	Parameters	
		Ch	Description
"C4"	"0000" to "0008"	1	Monitor values
	"0100" to "0108"	2	
	"0200" to "0208"	3	
	"0300" to "0308"	4	
"C5" to "CB" "D8" to "D9"	"0000" to "004F"	1	Parameters in setting area 0
	"0100" to "014F"	2	
	"0200" to "024F"	3	
	"0300" to "034F"	4	
"CC" to "D3"	"0000" to "003B"	1	Parameters in setting area 1
	"0100" to "013B"	2	
	"0200" to "023B"	3	
	"0300" to "033B"	4	

This command is used to store the addresses of multiple monitor values or set values that you wish to read. The stored monitor values or set values can be read by sending a single Composite Read from Variable Area command. Up to 20 items can be stored, even if the addresses are not consecutive.

To specify variable types and addresses, refer to *Appendix Setting Lists* (P. A-6). The upper limit of an address depends on the variable type.

This command can be used in both setting area 0 and setting area 1.

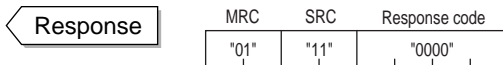

Response Codes:

The response for a normal end is shown above. For the response codes, refer to *6.5 Read from Variable Area* (P. 6-10).

■ Composite Read Registration Confirmation

Command	MRC	SRC
	"01"	"12"

This command is used to check the contents that were stored using the Composite Read Registration command.

Response	MRC	SRC	Response code	Variable type	Read address
	"01"	"12"	"0000"	Type	

Variable type	Read address	Bit position
Type		"00"

Response Codes:

The response for a normal end is shown above. For the response codes, refer to 6.5 Read from Variable Area (P. 6-10).

■ Composite Registration Read

Command	MRC	SRC
	"01"	"10"

This command is used to read the monitor values and set values that were registered using the Composite Read Registration command. This enables reading multiple monitor values and set values with one command.

This command can be used in both setting area 0 and setting area 1.

If an area type error or a set value error occurs in any of the data being read, no data will be read.

Response	MRC	SRC	Response code	Variable type	Data
	"01"	"10"	"0000"	Type	Monitor value/Set value

Variable type	Data
Type	Monitor value/Set value

Response Codes:

The response for a normal end is shown above. For the response codes, refer to 6.5 Read from Variable Area (P. 6-10).

■ Communications Writing

Command

MRC	SRC	Instruction code	Related information
"30"	"05"	"00"	

Related information	Description
"00"	Communications Writing Disabled
"01"	Communications Writing Enabled

This command is used to enable or disable the communications writing function. It changes the setting of the Communications Writing parameter.

When the communications writing function is disabled, communications cannot be used to write set values or send operation commands, such as the Run/Reset operation command.

The default setting is “Communications Writing Disabled.”

This command can be used in both setting area 0 and setting area 1.

Response

MRC	SRC	Response code
"30"	"05"	"0000"

Response Codes:

The response for a normal end is shown above. For the response codes, refer to *6.7 Operation Commands* (P. 6-13).

■ Run/Reset

Command

MRC	SRC	Instruction code	Related information
"30"	"05"	"01"	

Related information	Description	
	Ch	Control state
"00"	1	Run
"01"		Reset
"10"	2	Run
"11"		Reset
"20"	3	Run
"21"		Reset
"30"	4	Run
"31"		Reset
"F0"	All	Run
"F1"		Reset

This command is used to start or reset control.

This command can be used in setting area 0.

If "All" is selected for the channel, only the channels that are enabled will be affected by this command.

To use this command, the communications writing function must be enabled using the Communications Writing operation command.

Response

MRC	SRC	Response code
"30"	"05"	"0000"

Response Codes:

The response for a normal end is shown above. For the response codes, refer to 6.7 *Operation Commands* (P. 6-13).

■ AT Execute

Command

MRC	SRC	Instruction code	Related information
"30"	"05"	"03"	

Related information	Description	
	Ch	Command mode
"00" to "08"	1	00: Current PID set number 01 to 08: PID set number 1 to 8
"10" to "18"	2	10: Current PID set number 11 to 18: PID set number 1 to 8
"20" to "28"	3	20: Current PID set number 21 to 28: PID set number 1 to 8
"30" to "38"	4	30: Current PID set number 31 to 38: PID set number 1 to 8
"F0" to "F8"	All	F0: Current PID set number F1 to F8: PID set number 1 to 8

This command executes AT. On the E5AR-T/ER-T, the PID set number must be specified when executing AT.

To specify the current PID set number (the PID set currently being used for operation), set the lower byte of the related information to 0.

This command is used in setting area 0. An operation error will occur if it is used in setting area 1. An operation error will also occur in the following cases:

- If the Run/Reset parameter is set to "Reset" for the specified channel
- If the Auto/Manual parameter is set to "Manual" for the specified channel

To use this command, the communications writing function must be enabled using the Communications Writing operation command.

Response

MRC	SRC	Response code
"30"	"05"	"0000"

Response Codes:

The response for a normal end is shown above. For the response codes, refer to 6.7 Operation Commands (P. 6-13).

■ AT Cancel

Command

MRC	SRC	Instruction code	Related information
"30"	"05"	"0A"	

Related information	Description	
	Ch	Operation
"00"	1	AT Cancel
"10"	2	AT Cancel
"20"	3	AT Cancel
"30"	4	AT Cancel
"F0"	All	AT Cancel

This command cancels AT.

This command is used in setting area 0. An operating error will occur if it is used in setting area 1. An operation error will also occur in the following cases:

- If the Run/Reset parameter is set to "Reset" for the specified channel
- If the Auto/Manual parameter is set to "Manual" for the specified channel

To use this command, the communications writing function must be enabled using the Communications Writing operation command.

Response

MRC	SRC	Response code
"30"	"05"	"0000"

Response Codes:

The response for a normal end is shown above. For the response codes, refer to 6.7 Operation Commands (P. 6-13).

■ Write Mode

Command

MRC	SRC	Instruction code	Related information
"30"	"05"	"04"	

Related information	Description
"00"	Backup Mode
"01"	RAM Write Mode

This command is used to select the Backup Mode or RAM Write Mode.

The default setting is "Backup Mode."

This command can be used in both setting area 0 and setting area 1. To use this command, the communications writing function must be enabled using the Communications Writing operation command.

Write mode	Description
Backup Mode	When communications are used to write set values in the Operation, Program Setting, Adjustment, Adjustment 2, Alarm Set Setting, PID Setting, Time Signal Setting, or Approximation Setting Level, the data is also written to EEPROM.
RAM Write Mode	When communications are used to write set values in the Operation, Program Setting, Adjustment, Adjustment 2, Alarm Set Setting, PID Setting, Time Signal Setting, or Approximation Setting Level, the data is not written to EEPROM. When SP tracking or PV tracking is ON and the mode is changed to Remote SP Mode or Manual Mode, the SP is not written to EEPROM. When a change is made to a parameter setting using a key operation, the data is written to EEPROM.

When the write mode is changed from RAM Write Mode to Backup Mode, the set values in the Operation Level, Program Setting Level, Adjustment Level, Adjustment 2 Level, Alarm Set Setting Level, PID Setting Level, Time Signal Setting Level, and Approximation Setting Level are written to EEPROM. Each level is described in *4.1 Setting Levels and Key Operations* (P. 4-2).



Important

The time required for RAM backup depends on the number of settings that were changed in RAM Backup Mode. The more settings that were changed, the longer the time required. For example, if all settings in the Operation, Program Setting, Adjustment, Adjustment 2, Alarm Set Setting, PID Setting, Time Signal Setting, and Approximation Levels were changed, the most time would be required, which is about 5 seconds.

Response

MRC	SRC	Response code
"30"	"05"	"0000"

Response Codes:

The response for a normal end is shown above. For the response codes, refer to *6.7 Operation Commands* (P. 6-13).

■ Save RAM Data

Command

MRC	SRC	Instruction code	Related information
"30"	"05"	"05"	"00"

This command writes the set values in the Operation Level, Program Setting Level, Adjustment Level, Adjustment 2 Level, Alarm Set Setting Level, PID Setting Level, Time Signal Setting Level, and Approximation Setting Level to EEPROM. For information on these levels, refer to *4.1 Setting Levels and Key Operations* (P. 4-2).

This command can be used in both setting area 0 and setting area 1.

To use this command, the communications writing function must be enabled using the Communications Writing operation command.

Response

MRC	SRC	Response code
"30"	"05"	"0000"

Response Codes:

The response for a normal end is shown above. For the response codes, refer to *6.7 Operation Commands* (P. 6-13).

■ Software Reset

Command

MRC	SRC	Instruction code	Related information
"30"	"05"	"06"	"00"

A software reset causes the same operation as turning the power OFF and ON.

This command can be used in both setting area 0 and setting area 1.

To use this command, the communications writing function must be enabled using the Communications Writing operation command.

Response

MRC	SRC	Response code
"30"	"05"	"0000"

Response Codes:

The response for a normal end is shown above. For the response codes, refer to *6.7 Operation Commands* (P. 6-13).

■ Move to Setting Area 1

Command

MRC	SRC	Instruction code	Related information
"30"	"05"	"07"	"00"

Use this command to move to setting area 1.

The command is used in setting area 0. Nothing happens if the command is used in setting area 1.

If the command is used when the Initial Setting Protection parameter is set to 2 (Disable Move to Input Initial Setting Level), an operation error will occur.

To use this command, the communications writing function must be enabled using the Communications Writing operation command.

Response

MRC	SRC	Response code
"30"	"05"	"0000"

Response Codes:

The response for a normal end is shown above. For the response codes, refer to 6.7 Operation Commands (P. 6-13).

■ Move to Protect Level

Command

MRC	SRC	Instruction code	Related information
"30"	"05"	"08"	"00"

Use this command to move to Protect Level. Protect Level is described in 5.5 Protecting Settings (P. 5-23).

This command is used in setting area 0. An operating error will occur if it is used in setting area 1.

To use this command, the communications writing function must be enabled using the Communications Writing operation command.

Response

MRC	SRC	Response code
"30"	"05"	"0000"

Response Codes:

The response for a normal end is shown above. For the response codes, refer to 6.7 Operation Commands (P. 6-13).

■ Auto/Manual

Command

MRC	SRC	Instruction code	Related information
"30"	"05"	"09"	

Related information	Description	
	Ch	Operation mode
"00"	1	Auto
"01"		Manual

Related information	Description	
	Ch	Operation mode
"10"	2	Auto
"11"		Manual
"20"	3	Auto
"21"		Manual
"30"	4	Auto
"31"		Manual
"F0"	All	Auto
"F1"		Manual

Use this command to select automatic or manual operation.

This command is used in setting area 0. An operating error will occur if it is used in setting area 1.

To use this command, the communications writing function must be enabled using the Communications Writing operation command.

Response

MRC	SRC	Response code
"30"	"05"	"0000"

Response Codes:

The response for a normal end is shown above. For the response codes, refer to 6.7 *Operation Commands* (P. 6-13).

■ Parameter Initialization

Command

MRC	SRC	Instruction code	Related information
"30"	"05"	"0B"	"00"

This command returns all settings to the default settings.

This command is used in setting area 1. An operating error will occur if it is used in setting area 0.

To use this command, the communications writing function must be enabled using the Communications Writing operation command.

Response

MRC	SRC	Response code
"30"	"05"	"0000"

Response Codes:

The response for a normal end is shown above. For the response codes, refer to 6.7 *Operation Commands* (P. 6-13).

■ Alarm Latch Cancel

Command

MRC	SRC	Instruction code	Related information
"30"	"05"	"0C"	

Related information	Description	
	Ch	Command mode
"00"	1	Alarm Latch Cancel
"10"	2	Alarm Latch Cancel
"20"	3	Alarm Latch Cancel
"30"	4	Alarm Latch Cancel
"F0"	All	Alarm Latch Cancel

This command cancels the alarm latch. The command is used when the alarm latch function is in use.

This command can be used in both setting area 0 and setting area 1.

If AT is being executed for the specified channel, an operation error will occur.

To use this command, the communications writing function must be enabled using the Communications Writing operation command.

Response

MRC	SRC	Response code
"30"	"05"	"0000"

Response Codes:

The response for a normal end is shown above. For the response codes, refer to 6.7 Operation Commands (P. 6-13).

■ SP Mode

Command

MRC	SRC	Instruction code	Related information
"30"	"05"	"0D"	

Related information	Description	
	Ch	Command mode
"00"	1	Program SP
"01"		Remote SP
"02"		Fixed SP
"10"	2	Program SP
"11"		Remote SP (Close Cascade)
"12"		Remote SP (Open Cascade)
"21"	3	Remote SP
"22"		Fixed SP

Related information	Description	
	Ch	Command mode
"31"	4	Remote SP
"32"		Fixed SP
"F1"	All	Remote SP
"F2"		Fixed SP

Use this command to select the SP Mode. Refer to *SP Modes* in 5.7 *Program Operation Functions* (P. 5-31) for details on the SP Mode.

This command can be used in both setting area 0 and setting area 1.

- If AT is being run in the specified channel, an operation error will occur.

To use this command, the communications writing function must be enabled using the Communications Writing operation command.

Response

MRC	SRC	Response code
"30"	"05"	"0000"

Response Codes:

The response for a normal end is shown above. For the response codes, refer to 6.7 *Operation Commands* (P. 6-13).

■ Hold

Command

MRC	SRC	Instruction code	Related information
"30"	"05"	"12"	

Related information	Description	
	Ch	Command mode
"00"	1	Hold Cancel
"01"		Hold
"10"	2	Hold Cancel
"11"		Hold
"20"	3	Hold Cancel
"21"		Hold
"30"	4	Hold Cancel
"31"		Hold
"F0"	All	Hold Cancel
"F1"		Hold

This command starts or cancels the hold operation.

This command is used in setting area 0. An operation error will occur if it is used in setting area 1.

Operation errors will also occur in the following cases:

- If AT is being executed
- If the specified channel is being reset or is on standby

To use this command, the communications writing function must be enabled using the Communications Writing operation command.

Response

MRC	SRC	Response code
"30"	"05"	"0000"

Response Codes:

The response for a normal end is shown above. For the response codes, refer to 6.7 Operation Commands (P. 6-13).

■ Advance

Command

MRC	SRC	Instruction code	Related information
"30"	"05"	"13"	

Related information	Description	
	Ch	Command mode
"00"	1	Advance
"10"	2	Advance
"20"	3	Advance
"30"	4	Advance
"F0"	All	Advance

This command executes an advance operation. Operation will move to the beginning of the next segment.

This command is used in setting area 0. An operation error will occur if it is used in setting area 1.

Operation errors will also occur in the following cases:

- If AT is being executed
- If the specified channel is being reset or is on standby

To use this command, the communications writing function must be enabled using the Communications Writing operation command.

Response

MRC	SRC	Response code
"30"	"05"	"0000"

Response Codes:

The response for a normal end is shown above. For the response codes, refer to 6.7 Operation Commands (P. 6-13).

■ Back

Command

MRC	SRC	Instruction code	Related information
"30"	"05"	"14"	

Related information	Description	
	Ch	Command mode
"00"	1	Back
"10"	2	Back
"20"	3	Back
"30"	4	Back
"F0"	All	Back

This command executes a back operation. Operation will move to the beginning of the current segment.

This command is used in setting area 0. An operation error will occur if it is used in setting area 1.

Operation errors will also occur in the following cases:

- If AT is being executed
- If the specified channel is being reset or is on standby

To use this command, the communications writing function must be enabled using the Communications Writing operation command.

Response

MRC	SRC	Response code
"30"	"05"	"0000"

Response Codes:

The response for a normal end is shown above. For the response codes, refer to 6.7 Operation Commands (P. 6-13).

■ Controller Attribute Read

Command

MRC	SRC
"05"	"03"

This command reads the E5AR-T/ER-T model number and communications buffer size. The command can be used in any state of the E5AR-T/ER-T.

Response

MRC	SRC	Response code	Format	Buffer size
"05"	"03"	"0000"		"00D9"

Response Codes:

The response for a normal end is shown above. For the response codes, refer to 6.5 Read from Variable Area (P. 6-10).

Model Number

0	1	2	3	4	5	6	7	8	9
E	5	①	R	-	②	③			

*Bytes 7 to 9 are not used.

(1) Size

Symbol	Size
A	A size
E	E size

(2) Fixed/Program

Symbol	Fixed/program
T	Program

(3) Standard/Position-proportional

Symbol	Standard/position proportional
(Blank)	Standard
P	Position-proportional

■ Controller Status Read

Command

MRC	SRC
"06"	"01"

This command reads the operating status of the E5AR-T/ER-T. The command can be used in any state of the E5AR-T/ER-T.

Response

MRC	SRC	Response code	Operation state	Related information
"06"	"01"	"0000"		

Response Codes:

The response for a normal end is shown above. For the response codes, refer to 6.5 Read from Variable Area (P. 6-10).

◆ Operating Status

Bit position	7	6	5	4	3	2	1	0
	0	0	0	0				
	ch4		ch3		ch2		ch1	

Bit position	Operating status
00	Operating
01	Error (MV at PV error output)
10	Stopped (including setting area 1)
11	Manual Mode

The operating status of each channel is indicated using a 2-bit code.

◆ Related Information

Bit position	7	6	5	4	3	2	1	0

Bit position	Status	Bit value	
		0	1
0	Not used.	–	–
1	Not used.	–	–
2	Not used.	–	–
3	RSP input error	No error	Error
4	Potentiometer error	No error	Error
5	Exceeds display range	No error	Error
6	Input error	No error	Error
7	Not used.	–	–

Note: The bit value is an OR of all channels set in the Number of Enabled Channels parameter.

If the channel does not exist, "No error (0)" is returned.

If this command is used in setting area 1, the related information is undefined.

■ Echoback Test

Command

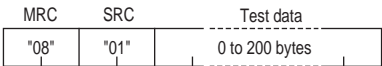

This command is used to perform an echoback test.

The command can be used in any state of the E5AR-T/ER-T.

Keep the test data within the following ranges depending on the communications data length.

Communications data length	Contents
7 bits	ASCII H'20 to H'7E
8 bits	ASCII H'20 to H'7E or H'A1 to H'FE

Response

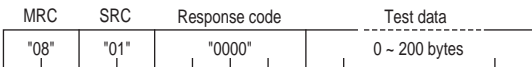

Response Codes:

The response for a normal end is shown above. For the response codes, refer to 6.7 Operation Commands (P. 6-13).

6.10 Program Example

■ N88Basic

This program displays the response from the E5AR-T/ER-T on the screen when command data is entered from the keyboard.

Command data from the unit number to the number of elements must be entered.

The program was created in N88BASIC.

```

1000 '-----
1010 'PROGRAM: Sample E5AR/ER Communications Program for CompoWay/F
1020 'VERSION:1.00
1030 '(c)Copyright OMRON Corporation 2003
1040 All Rights Reserved
1050 '-----
1060 '
1070 '=====Communications port (PARITY=EVEN, DATA=7, STOP=2) ====='
1080 '
1090 OPEN "COM:E73" AS #1
1100 '
1110 *SENDDATA
1120 '
1130 ===== Communications routine=====
1140 '
1150 -----Communications data input-----
1160 INPUT "SEND DATA:",SEND$
1170 '
1180 -----If no input, jump to end routine-----
1190 IF SEND$ = " " THEN *EXITSEND
1200 '
1210 -----BCC calculation-----
1220 BCC = 0
1230 SEND$ = SEND$+CHR$(3)
1240 FOR I=1 TO LEN(SEND$)
1250   BCC = BCC XOR ASC(MID$(SEND$, I, 1))
1260 NEXT I
1270 BCC$ = CHR$(BCC)
1280 '
1290 -----Send-----
1300 SDATA$ = CHR$(2)+SEND$+BCC$
1310 PRINT #1, SDATA$;
1320 '
1330 ===== Receive routine =====
1340 '
1350 RDATA$ = " "
1360 TIMEOUT = 0
1370 *RCVLOOP
1380 -----No response detection-----
1390 TIMEOUT = TIMEOUT+1
1400 IF TIMEOUT > 2000 THEN RESP$ = "No Response":GOTO *RCVEND
1410 IF LOC(1) = 0 THEN *RCVLOOP
1420 '
1430 -----Check for end character (if no end character, continue reading)
1440 RDATA$ = RDATA$+INPUT$(LOC(1),#1)
1450 IF LEN(RDATA$) <2 THEN *RCVLOOP
1460 IF MID$(RDATA$,LEN(RDATA$)-1,1) <> CHR$(3) THEN *RCVLOOP
1470 RESP$ = MID$(RDATA$,2,LEN(RDATA$)-2)
1480 *RCVEND
1490 '
1500 -----Display received data-----
1510 PRINT "RESPONSE: ";RESP$
1520 GOTO *SENDDATA
1530 '
1540 *EXITSEND
1550 =====End routine=====
1560 CLOSE #1
1570 END

```



● **Operation Example** Reading the Present Value of Unit Number 01

```
RUN
SEND DATA:010000101C00000000001
RESPONSE:010000010100000000014F
```

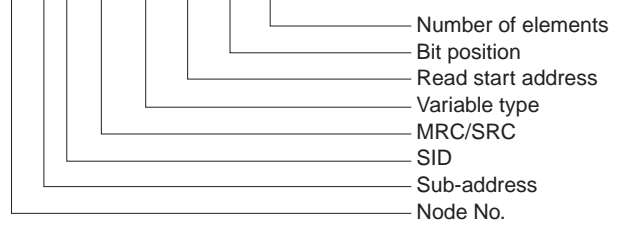
SEND DATA: [STX] 01 00 0 0101 C0 0000 00 0001 [ETX] [BCC]

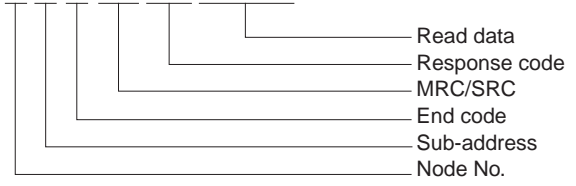

RESPONSE: [STX] 01 00 00 0101 0000 0000014F [ETX] [BCC]



Section 7 Modbus Communications

7.1	Communications Method	7-2
7.2	Frames.....	7-4
7.3	List of Functions	7-7
7.4	Variable Areas	7-8
7.5	Read from Variable Area	7-11
7.6	Write to Variable Area.....	7-13
7.7	Operation Commands.....	7-15
7.8	Setting Areas	7-18
7.9	Commands and Responses	7-20

7.1 Communications Method

■ Modbus Communications

Modbus communications are based on the RTU Mode of the Modbus Protocol of Modicon Inc. (specifications: PI-MBUS-300 Revision J). Detailed specifications for the Modbus protocol are provided below.

Supplement

Communications are implemented by creating a program on the host computer. The descriptions in this section are therefore from the perspective of the host computer. For example, “reading” and “writing” refer to the host computer reading from and writing to the E5AR-T/ER-T.

■ Communications Specifications

Transfer connection	Multi-point
Communications method	RS-485 (2-wire, half duplex)
Synchronization method	Start-stop
Baud rate	9.6, 19.2, or 38.4 Kbit/s
Send code	RTU (Remote Terminal Unit)
Data length	8 bits
Stop bit length	Automatically determined by vertical parity setting.
Error detection	Vertical parity: None, even, or odd CRC-16 (Cyclical Redundancy Check)
Flow control	None
Interface	RS-485
Retry function	None
Communications buffer	217 bytes
Communications response send wait time	0 to 99 ms Default: 20 ms

Note: Default settings are shaded.

Transfer Protocol

The host computer sends a command frame, and the E5AR-T/ER-T returns a response frame based on the contents of the command frame. One response frame is sent in response to one command frame.

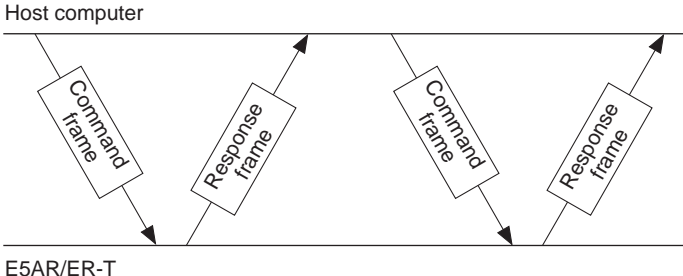

The exchange of the command frame and response frame is described below.

After a receiving a response from the Controller, have the host computer wait at least 5 ms before sending the next command.

When writing multiple sets of parameters in a row, such as when writing to the variable area or performing a compound write, control characteristics may be affected. Observe the following points.

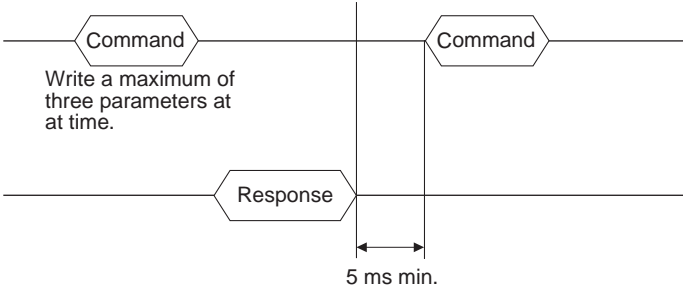

7.2 Frames

Commands from the host computer and responses from the E5AR-T/ER-T take the form of frames that conform to the Modbus (RTU) protocol. The data included in command frames and response frames is described in this section.

In the following descriptions, an "H" before a numeric value (for example H'02) indicates that the value is a hexadecimal number. Numbers or letters enclosed in quotation marks (for example "00") are ASCII characters.

■ Command Frames

In RTU Mode, each frame begins and ends with a silent time interval that is at least 3.5 characters long.

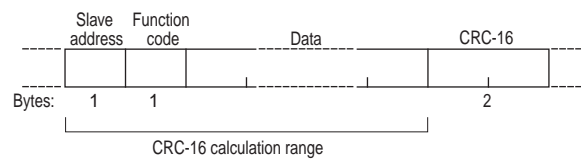

	Silent interval at least 3.5 characters long.
Slave address	Specify the unit number of the E5AR-T/ER-T between H'00 and H'63 (0 to 99). When broadcasting to all nodes, specify H'00. Responses are not returned for broadcasts.
Function code	The function code specifies the command from the host computer. The code is set in hexadecimal and is 1 byte long. For more information, refer to <i>7.3 List of Functions</i> (P. 7-7).
Data	The text of command based on the function code. Specifies variable addresses and the values for set values in hexadecimal.
CRC-16	Cyclical Redundancy Check These two bytes store check code calculated from the slave address to the end of the data in hexadecimal.
	Silent interval at least 3.5 characters long.

● Example of CRC-16 Calculation

A message is processed 1 byte at a time in a 16-bit processing register called the CRC register.

Supplement

CRC-16 Calculation Method:

As described below, the value from the slave address through the end of the data is calculated and the result set as the CRC-16.

- (1) An initial value of H'FFFF is set in the CRC register.
- (2) An XOR is taken of the contents of the CRC register and the 1st byte of the message, and the result is returned to the CRC register.
- (3) The contents of the CRC register is shifted 1 bit to the right, and 0 is placed in the MSB.
- (4) If the bit shifted from the LSB is 0, step 3 is repeated.
If the bit shifted from the LSB is 1, an XOR is taken of the contents of the CRC register and H'A001, and the result is returned to the CRC register.

- (5) Steps 3 and 4 are repeated until the contents of the register have been shifted 8 bits to the right.
- (6) If the end of the message has not been reached, an XOR is taken of the next byte of the CRC register and the message, the result is returned to the CRC register, and the procedure is repeated from step (3).
- (7) The result (the value in the CRC register) is placed in the lower byte of the message.

Example of Appending the Result

If the calculated CRC value is H'1234, this is appended as follows to the command frame:

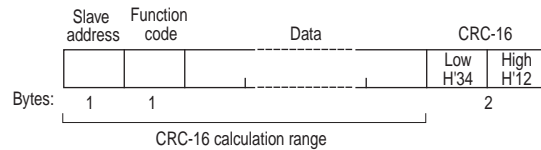

■ Response Frames

● Normal Response Frames

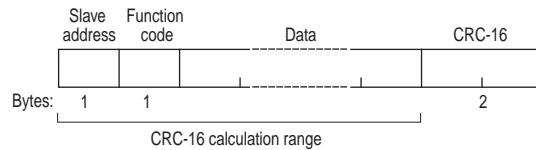

● Error Response Frames

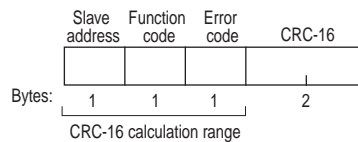

Slave address	The unit number that was specified in the command frame is returned here. This is the unit number of the responding E5AR-T/ER-T.
Function code	The function code that was received is returned here. In an error response frame, "H'80" is added to the value to indicate that this is an error response. Example: Received function code = H'03 Function code in error response frame = H'83
Error code	An end code that indicates the error.
CRC-16	Cyclical Redundancy Check These two bytes are a check code calculated from the slave address through the end of the data in hexadecimal.

● Error Codes

End code	Name	Description	Error detection priority
H'01	Function code error	Received an unsupported function code.	1
H'02	Variable address error	The variable area number specified in the variable address is out of range.	2
H'03	Variable data error	The number of elements does not agree with the number of data items. Number of elements times 2 does not agree with the byte count. The response length exceeds the communications buffer size. The operation code or related information in an operation command is not correct. The written data exceeds the setting range.	3
H'04	Operation error	The setting in the write data is not permitted in the current operating mode. <ul style="list-style-type: none"> • The communications writing function is disabled • Attempted to write to set values in setting area 1 from setting area 0. • Attempted to write to Protect Level set values from another level. • AT is being executed. • The program number was changed during programmed operation. • User calibration is in progress. • The operation command cannot be processed. • Unit error, unit change, display unit error, or EEPROM error. 	4

● No Response

In the following cases, the received command is not processed and a response is not returned. A timeout will occur at the host device.

- The slave address in the received command is different from the communications unit number set in the E5AR-T/ER-T.
- A parity error, framing error, or overrun error occurred due to a transfer error or other error.
- A CRC-16 code error occurred in the received command frame.
- A time interval greater than 3.5 characters occurred between data while receiving a command frame.

7.3 List of Functions

The function codes supported by the E5AR-T/ER-T are listed below.

● Function Codes

Function codes	Name	Description
03 (H'03)	Read from Variable Area	Reads a variable area. Multiple variables that are consecutive can be read.
16 (H'10)	Write to Variable Area	Writes to a variable area. Multiple variables that are consecutive can be written. Broadcasting is possible.
06 (H'06)	Operation Command	Writes an operation command. Broadcasting is possible.
08 (H'08)	Echoback Test	Performs an echoback test.

7.4 Variable Areas

The areas used for data exchange when communicating with the E5AR-T/ER-T are called the variable areas. Present values can be read, and set values can be read and written using the variable areas of the E5AR-T/ER-T.

Operation commands do not use the variable areas.

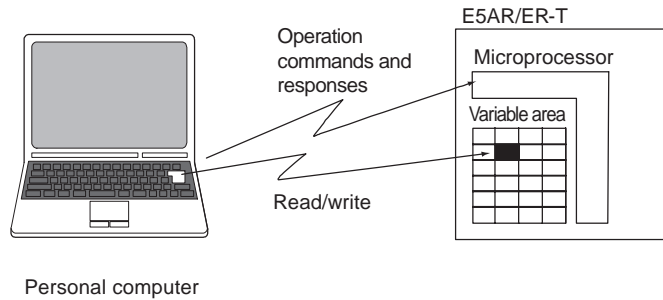

A variable area is accessed by specifying the position of a variable within the variable area using the channel identifier, area number, and address in the area.

■ Addresses

Addresses are allocated within each variable type. Addresses are two bytes long and written in hexadecimal. Addresses are allocated according to access size. Each address consists of a channel identifier, area number, and the address in the area.

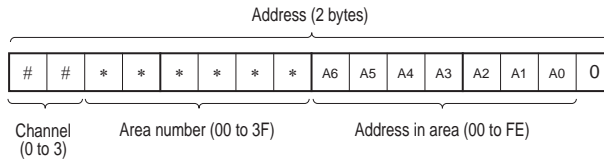

● Area Numbers

Area numbers in the variable area are listed in the following table.

Variable type	Description	Area
04	Communications Monitor	Setting area 0 (Operation in progress.)
05	Protect Level	
06	Operation Level	
07	Adjustment Level	
08	Adjustment 2 Level	
09	Alarm Set Setting Level	
0A	PID Setting Level	
0B	Approximation Setting Level	
18	Program Setting Level	
19	Time Signal Setting Level	

Variable type	Description	Area
0C	Input Initial Setting Level	Setting area 1 (Operation stopped.)
0D	Control Initial Setting Level	
0E	Control Initial Setting 2 Level	
0F	Alarm Setting Level	
10	Display Adjustment Level	
11	Communications Setting Level	
12	Advanced Function Setting Level	
13	Expansion Control Setting Level	

● Channel Identifier

To specify channels 2 to 4 for Controllers with more than one input channel, specify a channel identifier between 1 and 3 to identify the channel. Only 0 (channel 1) can be specified for controllers with only one input channel.

Channel identifier	Channel
0	Channel 1
1	Channel 2
2	Channel 3
3	Channel 4

● Address in Area

This address is allocated a parameter in the variable areas. Addresses are assigned in order beginning from the first parameter.

For more information on addresses, refer to *Appendix Setting Lists (P. A-6)*.

The addresses indicated in the setting list are the addresses for channel 1. To specify an address of channel 2, for example, add H'4000 to the address in the setting list. For channel 3, add H'8000, and for channel 4, add H'C000.

■ Number of Elements

The number of elements is expressed as a 2-byte hexadecimal number. For example, if the number of elements is 0010, the first 8 elements of data (H'10) from the address are specified.

The specification range for the number of elements depends on the command. Refer to *7.9 Commands and Responses (P. 7-20)* for more information.

In the Modbus protocol one element is two bytes of data, however, set values in the E5AR-T/ER-T are four bytes each.

■ Set Values

Values read and written to the variable area are expressed in hexadecimal and disregard the decimal point position. Negative values are expressed as a two's complements.

Example: D'105.0 → H'0000041A

This variable is an 8-digit number in hexadecimal. Negative values are expressed as a two's complement. The decimal is disregarded. If the PV of the E5AR-T/ER-T is 105.0, it will be read as H'0000041A (105.0 → 1050 → H'0000041A). If data that uses the program time unit is read and is displayed as 99.59, the read data will be H'000026E7 (99.59 → 9959 → H'000026E7).

7.5 Read from Variable Area

Read from a variable area by setting the required data in the following command frame.

Command

Command Frame

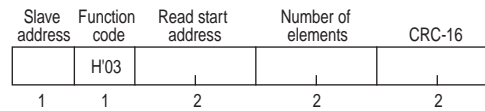

Data name	Description
Slave address	Specify the unit number of the E5AR-T/ER-T. Set in hexadecimal from H'01 to H'63 (1 to 99).
Function code	The function code for Read from Variable Area command is H'03.
Read start address	Specify the address of the set value to read. For more information on addresses, refer to <i>Appendix Setting Lists</i> (P. A-6).
Number of elements	Specify the number of set values to read times 2 for the number of elements. The setting range is H'0002 to H'006A (2 to 106). Example: If the number of set values sets is 2, specify H'0004.
CRC-16	The check code calculated based on the values from the slave address through the end of the data. For the calculation method, refer to <i>Example of CRC-16 Calculation</i> in 7.2 Frames (P. 7-4).

Response

Response Frame

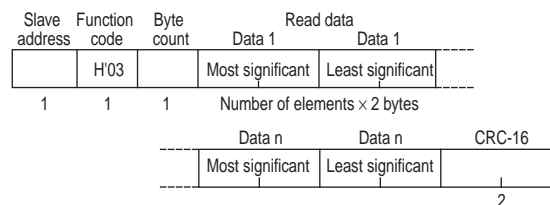

Data name	Description
Slave address	The value from the command frame is returned here.
Function code	The received function code is returned here. In an error response frame, "H'80" is added to the received function code to indicate that it is an error response. Example: Received function code = H'03 Function code in error response frame = H'83
Byte count	Number of bytes of data that were read.
Read data	The set value that was read.
CRC-16	This is the check code calculated from the slave address through the end of the data. For the calculation method, refer to <i>Example of CRC-16 Calculation</i> in 7.2 Frames (P. 7-4).

● Response Codes

Function code	Error code	Error name	Cause
H'83	H'02	Variable address error	Error in the read start address.
	H'03	Variable data error	The number of elements exceeds the specified range.
	H'04	Operation error	Unit error, unit change, display unit error, or EEPROM error (does not occur when number of elements is 0).
H'03	–	Normal end	No error.

● Reading Non-display Data

Set values can be read even if the parameters are set not to be displayed or are not displayed due to the model.

Command/Response Example

Reading the PV of Channel 1

(Slave address: H'01)

PV of channel 1 (read-only data)

Address: H'0404

Data read: H'000003E8 (100.0°C)

Command: 01 03 0404 00 02 (CRC-16)

Response: 01 03 04 00 00 03 E8 (CRC-16)

7.6 Write to Variable Area

Write to a variable area by setting the required data in the following command frame.

Command

Command Frame

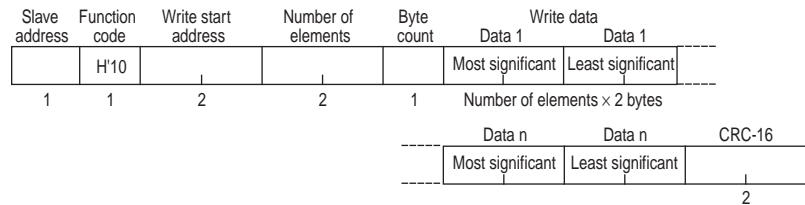

Data name	Description
Slave address	Specify the unit number of the E5AR-T/ER-T. Set in hexadecimal from H'01 to H'63 (1 to 99).
Function code	The function code for the Write to Variable Area command is H' 10.
First address of write	Specify the address of the set value to write. For more information on addresses, refer to <i>Appendix Setting Lists</i> (P. A-6).
Number of elements	Specify the number of set values to write times 2 for the number of elements. The setting range is H'0002 to H'0068 (2 to 104). Example: When the number of set values is 2, specify H'0004.
Byte count	Specify the number of bytes of data to write.

Response

Response Frame

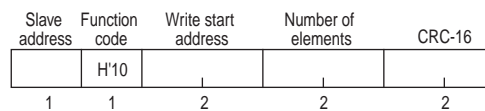

Data name	Description
Slave address	The value from the command frame is returned here.
Function code	The received function code is returned here. In an error response frame, "H'80" is added to the received function code to indicate that it is an error response. Example: Received function code = H'10 Function code in error response frame = H'90
Write start address	The write start address that was received is returned here.
Number of elements	The received number of elements.
CRC-16	This is the check code calculated from the slave address through the end of the data. For the calculation method, refer to <i>Example of CRC-16 Calculation in 7.2 Frames</i> (P. 7-4).

● Response Codes

Function code	Error code	Error name	Cause
H'90	H'02	Variable address error	Error in write start address.
	H'03	Variable data error	<ul style="list-style-type: none"> • Number of elements and number of data items do not agree. • Number of elements times 2 does not agree with byte count. • Write data exceeds the setting range.
	H'04	Operation error	<p>The operating status does not permit writing. The settings for the write data are not permitted in the current operating mode.</p> <ul style="list-style-type: none"> • The communications writing function is disabled. • Attempted to write to set values in setting area 1 from setting area 0. • Attempted to write to Protect Level set values from another level. • AT is being executed. • The program number was changed during programmed operation. • User calibration is in progress. • Unit error, unit change, display unit error, or EEPROM error.
H'10	–	Normal end	No error

● Writing Non-display Data

It is possible to write set values even if they are set to not be displayed or are not displayed due to the model. Exercise caution when writing continuously.

Command/Response Example

Writing the SP Setting Upper Limit and SP Setting Lower Limit parameters in the Control Initial Setting Level for channel 1. (Slave address: H'01)

SP Setting Upper Limit for Channel 1

Address: H'0D1E

Data written: H'00002710 (1000.0°C)

SP Setting Lower Limit for Channel 1

Address: H'0D20

Data written: H'FFFFFFC18 (-100.0°C)

Command: 01 10 0D 1E 00 04 08 00 00 27 10 FF FF FC 18 (CRC-16)

Response: 01 10 0D 1E 00 04 (CRC-16)

7.7 Operation Commands

Operation commands are sent using the following command frame.

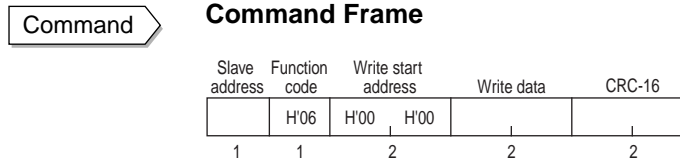

Data name	Description
Slave address	Specify the unit number of the E5AR-T/ER-T. Set in hexadecimal from H'01 to H'63 (1 to 99).
Function code	The function code for an Operation Command is H'06.
Write start address	Specify H'0000 for the Operation Command address.
Write data	Enter the operation code of the operation command and related information (see table below).
CRC-16	This is the check code calculated from the slave address through the end of the data. For the calculation method, refer to <i>Example of CRC-16 Calculation</i> in 7.2 Frames (P. 7-4).

Operation Commands for the E5AR-T/ER-T are listed in the following table.

Operation code	Description	Related information	
		Upper Byte	Lower Byte
H'00	Communications Writing	H'0 *1	H'0: OFF (disabled) H'1: ON (enabled)
H'01	Run/Reset	H'0 to 3, F *2	H'0: Run, H'1: Reset
H'03	AT Execute	H'0 to 3, F *2	H'0: Current PID set number H'1 to 8: PID set number
H'04	Write Mode	H'0 *1	H'0: Backup Mode H'1: RAM Write Mode
H'05	Save RAM Data	H'0 *1	H'0
H'06	Software Reset	H'0 *1	H'0
H'07	Move to Setting Area 1	H'0 *1	H'0
H'08	Move to Protect Level	H'0 *1	H'0
H'09	Auto/Manual	H'0 to 3, F *2	H'0: Auto Mode H'1: Manual Mode
H'0A	AT Cancel	H'0 to 3, F *2	H'0: Cancel
H'0B	Parameter Initialization	H'0 *1	H'0

Operation code	Description	Related information	
		Upper Byte	Lower Byte
H'0C	Alarm Latch Cancel	H'0 to 3, F *2	H'0
H'0D	SP Mode	H'0 to 3, F *2	H'0: PSP, H'1: RSP, H'2: FSP
H'12	Hold	H'0 to 3, F *2	H'0: Hold Cancel H'1: Hold
H'13	Advance	H'0 to 3, F *2	H'0
H'14	Back	H'0 to 3, F *2	H'0

*1: Executed for all channels.

*2: Specify the channel.

0: CH1, 1: CH2, 2: CH3, 3: CH4, F: All channels

Note: When all channels is specified, only enabled channels will respond and processing will begin from channel 1. If an error is detected on any one channel, an operation error will occur. If all channels end normally, a normal end will occur.

Response

Response Frame

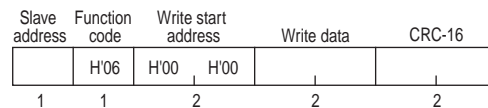

Data name	Description
Slave address	The value from the command frame appears here.
Function code	This is the received function code. In an error response frame, "H'80" is added to the received function code to indicate that it is an error response. Example: Received function code = H'06 Function code in error response frame = H'86
Beginning address of write	Beginning address of write that was received.
Written data	Received operation command data.
CRC-16	This is the check code calculated from the slave address through the end of the data. For the calculation method, refer to <i>Example of CRC-16 Calculation</i> in 7.2 Frames (P. 7-4).

● Response Codes

Function code	Error code	Error name	Cause
H'86	H'02	Variable address error	The variable address is not H'0000.
	H'03	Variable data error	Error in written data. • Incorrect operation code or related information.
	H'04	Operation error	The operating status does not permit writing. • The communications writing function is disabled. The command will be received even if the communications writing function is disabled. • Cannot process. See description of commands in 7.9 <i>Commands and Responses</i> (P. 7-20). • Unit error, unit change, display unit error, or EEPROM error.
H'06	–	Normal end	No error

Command/Response Example

Operation Command to Channel 2 (slave address: H'01)

Channel 2 Operation Command

Address: H'0000

Written data: H'0111 (Reset command to channel 2)

Command: 01 06 00 00 01 11 (CRC-16)

Response: 01 06 00 00 01 11 (CRC-16)

7.8 Setting Areas

The E5AR-T/ER-T has two setting areas for communications: Setting area 0 and setting area 1.

In setting area 0, operation continues. Setting area 0 makes it possible to perform operations that require operation to be in progress, such as reading the PV, writing an SP, and starting/resetting operation (Run/Reset), as well as operations that do not interfere with control. On the other hand, operations that may change control, such as writing Initial set values, cannot be performed. (Set values that cannot be written can still be read.)

In setting area 1, operation is stopped. This makes it possible to perform operations such as writing Initial set values, which cannot be written in setting area 0.

When the power is turned ON, setting area 0 is selected. To access setting area 1, use the Move to Setting Area 1 operation command. To return to setting area 0 from setting area 1, turn OFF the power or use the Software Reset operation command.

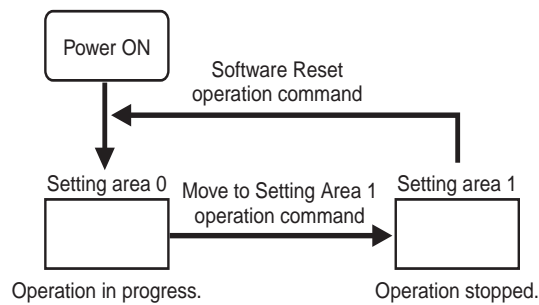

Area number	Description	Area
04	Communications Monitor	Setting area 0 (Operation in progress.)
05	Protect Level	
06	Operation Level	
07	Adjustment Level	
08	Adjustment 2 Level	
09	Alarm Set Setting Level	
0A	PID Setting Level	
0B	Approximation Setting Level	
18	Program Setting Level	
19	Time Signal Setting Level	

Area number	Description	Area
0C	Input Initial Setting Level	Setting area 1 (Operation stopped.)
0D	Control Initial Setting Level	
0E	Control Initial Setting 2 Level	
0F	Alarm Setting Level	
10	Display Adjustment Level	
11	Communications Setting Level	
12	Advanced Function Setting Level	
13	Expansion Control Setting Level	

7.9 Commands and Responses

The E5AR-T/ER-T provides a set of commands that read from variable areas, write to variable areas, execute operation commands, and execute other services provided by the Modbus communications protocol. The commands supported by the E5AR-T/ER-T are described below.

■ Reading Monitor Values

Command

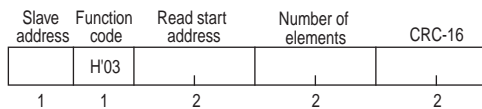

Address	Monitor value		Address	Monitor value	
	Ch	Data name		Ch	Data name
H'0404	1	PV	H'8404	3	PV
H'0406		Present Set Point	H'8406		Present Set Point
H'040A		PID Set Number Monitor	H'840A		PID Set Number Monitor
H'040C		Status	H'840C		Status
H'040E		Program Status	H'840E		Program Status
H'0410		Alarm Set Number Monitor	H'8410		Alarm Set Number Monitor
H'4404	2	PV	H'C404	4	PV
H'4406		Present Set Point	H'C406		Present Set Point
H'440A		PID Set Number Monitor	H'C40A		PID Set Number Monitor
H'440C		Status	H'C40C		Status
H'440E		Program Status	H'C40E		Program Status
H'4410		Alarm Set Number Monitor	H'C410		Alarm Set Number Monitor

This command is used to read the present values, status, and other monitor values. The number of elements can be set from H'0004 to 006A (4 to 106) to allow reading monitor values in consecutive addresses.

When used in setting area 1, the response for the present value and internal SP will be 0 and the response for the status will be as indicated in the notes in *E5AR-T Status (Communications)* in *Appendix Setting Lists* (P. A-8).

Response

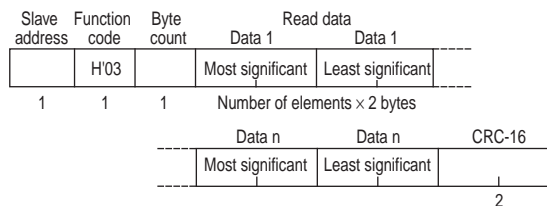

The response for a normal end is shown above. For information on error responses, refer to *7.5 Read from Variable Area* (P. 7-11).

■ Reading Set Values

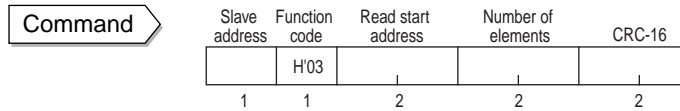

Address	Description		
	Ch		
	1	Set values in setting area 0	
H'0600 to 061C		Operation Level	
H'0700 to 074A		Adjustment Level	
H'0800 to 0818		Adjustment 2 Level	
H'0900 to 096E		Alarm Set Setting Level	
H'0A00 to 0A9E		PID Setting Level	
H'0B00 to 0B6E		Approximation Setting Level	
H'1800 to 183A		Program Setting Level	
H'1900 to 196C		Time Signal Setting Level	
		Set values in setting area 1	
H'0C00 to 0C20		Input Initial Setting Level	
H'0D00 to 0D36		Control Initial Setting Level	
H'0E00 to 0E76		Control Initial Setting 2 Level	
H'0F00 to 0F2C		Alarm Setting Level	
H'1000 to 100E		Display Adjustment Level	
H'1100 to 110C		Communications Setting Level	
H'1200 to 1218		Advanced Function Setting Level	
H'1300 to 133A		Expansion Control Setting Level	
H'4000 added to above addresses		2	Same set values as channel 1
H'8000 added to above addresses		3	Same set values as channel 1
H'C000 added to above addresses	4	Same set values as channel 1	

This command is used to read set values. The number of elements can be set from H'0004 to 006A (4 to 106) to allow successive reading of 2 to 53 set values in consecutive addresses.

To specify the variable type or address, refer to *Appendix Setting Lists* (P. A-6). The upper limit of an address depends on the variable type.

This command can be used in both setting area 0 and setting area 1. When used in setting area 1, the response for the remote SP monitor, ramp SP monitor, and valve opening monitor will be 0 and the response for the status will be as indicated in the notes in *E5□R-T Status (Communications)* in *Appendix Setting Lists* (P. A-8).

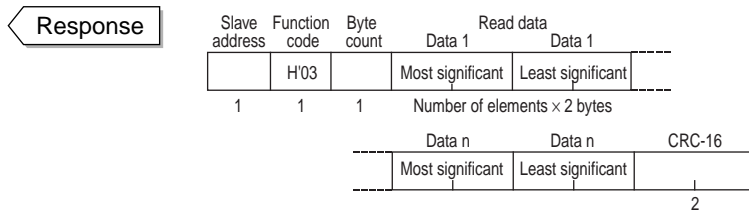

The response for a normal end is shown above. For information on error responses, refer to 7.5 *Read from Variable Area* (P. 7-11).

■ Writing Set Values in Protect Level

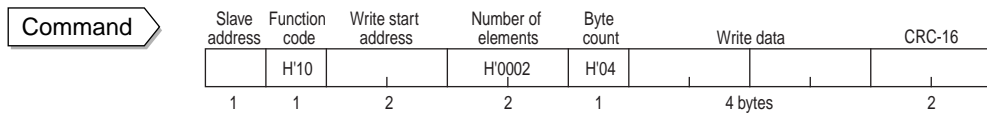

Address	Parameter
H'0500	Operation Adjustment Protection
H'0502	Initial Setting Protection
H'0504	Setting Change Protection
H'0506	PF Key Protection

This command writes set values in the Protect Level. Refer to 4.1 *Setting Levels and Key Operations* (P. 4-2) for information on Protect Level.

This command is used in setting area 0. If used in setting area 1, an error will result.

To use this command, first enable using the communications writing function by executing the Communications Writing operation command, and then move to Protect Level by executing the Move to Protect Level operation command.

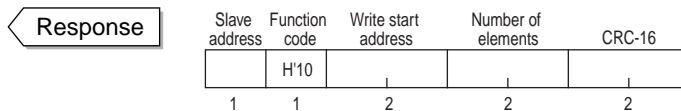

The response for a normal end is shown above. For information on error responses, refer to 7.6 *Write to Variable Area* (P. 7-13).

■ Writing Set Values

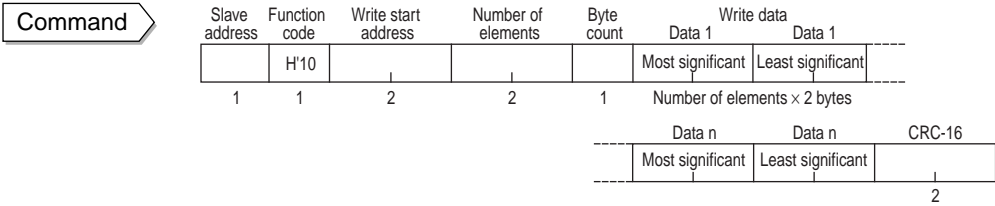

Address	Description		
	Ch		
	1	Set values in setting area 0	
H'0600 to 061C		Operation Level	
H'0700 to 074A		Adjustment Level	
H'0800 to 0818		Adjustment 2 Level	
H'0900 to 096E		Alarm Set Setting Level	
H'0A00 to 0A9E		PID Setting Level	
H'0B00 to 0B6E		Approximation Setting Level	
H'1800 to 183A		Program Setting Level	
H'1900 to 196C		Time Signal Setting Level	
		Set values in setting area 1	
H'0C00 to 0C20		Input Initial Setting Level	
H'0D00 to 0D36		Control Initial Setting Level	
H'0E00 to 0E76		Control Initial Setting 2 Level	
H'0F00 to 0F2C		Alarm Setting Level	
H'1000 to 100E		Display Adjustment Level	
H'1100 to 110C		Communications Setting Level	
H'1200 to 1218		Advanced Function Setting Level	
H'1300 to 133A		Expansion Control Setting Level	
H'4000 added to above addresses		2	Same set values as channel 1
H'8000 added to above addresses		3	Same set values as channel 1
H'C000 added to above addresses	4	Same set values as channel 1	

Modbus Communications

This command is used to write set values. The number of elements can be set from H'0004 to 0068 (4 to 104) to write from 2 to 52 set values at consecutive addresses.

To specify the variable type and address, refer to *Appendix Setting Lists* (P. A-6).

Parameters in setting area 1 can be written from setting area 1. An operation error will occur if parameters are written from setting area 0.

To use this command, the communications writing function must be enabled using the Communications Writing operation command.

To store the set values for Operation or Adjustment Level in EEPROM, select "Backup Mode" and execute the RAM Write Mode command. If "Backup Mode" is not selected, the set values will not remain in memory when the power is turned OFF. For more information on the above levels, refer to *4.1 Setting Levels and Key Operations* (P. 4-2).

Response				
Slave address	Function code	Write start address	Number of elements	CRC-16
1	H'10	2	2	2

The response for a normal end is shown above. For information on error responses, refer to *7.6 Write to Variable Area* (P. 7-13).

■ Communications Writing

Command					
Slave address	Function code	Write start address	Operation code	Related information	CRC-16
1	H'06	H'00 H'00	H'00		2

Related information	Description
H'00	Communications Writing Disabled
H'01	Communications Writing Enabled

This command is used to enable or disable the communications writing function. It changes the setting of the Communications Writing parameter.

When the communications writing function is disabled, communications cannot be used to write set values or send operation commands, such as the Run/Reset operation command.

The default setting is "Communications Writing Disabled."

This command can be used in both setting area 0 and setting area 1.

Response					
Slave address	Function code	Write start address	Operation code	Related information	CRC-16
1	H'06	H'00 H'00	H'00		2

The response for a normal end is shown above. For information on error responses, refer to 7.7 Operation Commands (P. 7-15).

■ Run/Reset

Command

Slave address	Function code	Write start address		Operation code	Related information	CRC-16
	H'06	H'00	H'00	H'01		
1	1	2		2		2

Related information	Description	
	Ch	Control state
H'00	1	Run
H'01		Reset
H'10	2	Run
H'11		Reset
H'20	3	Run
H'21		Reset
H'30	4	Run
H'31		Reset
H'F0	All	Run
H'F1		Reset

This command is used to start or reset control.

This command is used in setting area 0.

When the control mode is set to cascade control, perform the Run/Reset operation command for channel 2.

If "All" is selected for the channel, only the channels that are enabled will be affected by this command.

To use this command, the communications writing function must be enabled using the Communications Writing operation command.

Response

Slave address	Function code	Write start address		Operation code	Related information	CRC-16
	H'06	H'00	H'00	H'01		
1	1	2		2		2

The response for a normal end is shown above. For information on error responses, refer to 7.7 Operation Commands (P. 7-15).

■ AT Execute

Command

Slave address	Function code	Write start address		Operation code	Related information	CRC-16
	H'06	H'00	H'00	H'03		
1	1	2		2		2

Related information	Description	
	Ch	Command mode
H'00 to 08	1	00: Current PID set number 01 to 08: PID set number 1 to 8
H'10 to 18	2	10: Current PID set number 11 to 18: PID set number 1 to 8
H'20 to 28	3	20: Current PID set number 21 to 28: PID set number 1 to 8
H'30 to 38	4	30: Current PID set number 31 to 38: PID set number 1 to 8
H'F0 to F8	All	F0: Current PID set number F1 to F8: PID set number 1 to 8

This command executes AT. On the E5AR-T/ER-T, the PID set number must be specified when executing AT.

To specify the current PID set number (the PID set currently used for operation), set the lower byte of the related information to 0.

This command is used in setting area 0. An operation error will occur if it is used in setting area 1. An operation error will also occur in the following cases:

- If the Run/Reset parameter is set to “Reset” for the specified channel
- If the Auto/Manual parameter is set to “Manual” for the specified channel

To use this command, the communications writing function must be enabled using the Communications Writing operation command.

Response

Slave address	Function code	Write start address		Operation code	Related information	CRC-16
	H'06	H'00	H'00	H'03		
1	1	2		2		2

The response for a normal end is shown above. For information on error responses, refer to 7.7 Operation Commands (P. 7-15).

■ AT Cancel

Command

Slave address	Function code	Write start address		Operation code	Related information	CRC-16
1	H'06	H'00	H'00	H'0A		
1	1	2		2		2

Related information	Description	
	Ch	Command mode
H'00	1	AT Cancel
H'10	2	AT Cancel
H'20	3	AT Cancel
H'30	4	AT Cancel
H'F0	All	AT Cancel

This command cancels AT.

This command is used in setting area 0. An operating error will occur if it is used in setting area 1. An operation error will also occur in the following cases:

- If the Run/Reset parameter is set to “Reset” for the specified channel
- If the Auto/Manual parameter is set to “Manual” for the specified channel

To use this command, the communications writing function must be enabled using the Communications Writing operation command.

Response

Slave address	Function code	Write start address		Operation code	Related information	CRC-16
1	H'06	H'00	H'00	H'0A		
1	1	2		2		2

The response for a normal end is shown above. For information on error responses, refer to *7.7 Operation Commands* (P. 7-15).

■ Write Mode

Command

Slave address	Function code	Write start address		Operation code	Related information	CRC-16
1	H'06	H'00	H'00	H'04		
1	1	2		2		2

Related information	Description
H'00	Backup Mode
H'01	RAM Write Mode

This command is used to select the Backup Mode or RAM Write Mode.

The default setting is “Backup Mode.”

This command can be used in both setting area 0 and setting area 1.

To use this command, the communications writing function must be enabled using the Communications Writing operation command.

Write mode	Description
Backup Mode	When communications are used to write set values in the Operation, Program Setting, Adjustment, Adjustment 2, Alarm Set Setting, PID Setting, Time Signal Setting, or Approximation Setting Level, the data is also written to EEPROM.
RAM Write Mode	When communications are used to write set values in the Operation, Program Setting, Adjustment, Adjustment 2, Alarm Set Setting, PID Setting, Time Signal Setting, or Approximation Setting Level, the data is not written to EEPROM. When SP tracking or PV tracking is ON and the mode is changed to Remote SP Mode or Manual Mode, the SP is not written to EEPROM. When a change is made to a parameter setting using a key operation, the data is written to EEPROM.

When the write mode is changed from RAM Write Mode to Backup Mode, the set values in the Operation, Program Setting, Adjustment, Adjustment 2, Alarm Set Setting, PID Setting, Time Signal Setting, and Approximation Setting Levels are written to EEPROM. Each level is described in *4.1 Setting Levels and Key Operations* (P. 4-2).



Important

The time required for RAM backup depends on the number of settings that were changed in RAM Backup Mode. The more settings that were changed, the longer the time required. For example, if all settings in Operation, Program Setting, Adjustment, Adjustment 2, Alarm Set Setting, PID Setting, Time Signal Setting, and Approximation Levels were changed, the most time would be required, which is about 5 seconds.

Response

Slave address	Function code	Write start address	Operation code	Related information	CRC-16
1	H'06	H'00	H'00	H'04	
1		2	2		2

The response for a normal end is shown above. For information on error responses, refer to *7.7 Operation Commands* (P. 7-15).

■ Save RAM Data

Command

Slave address	Function code	Write start address	Operation code	Related information	CRC-16
1	H'06	H'00	H'00	H'05	H'00
1		2	2		2

This command writes the set values in the Operation and Adjustment Levels to EEPROM. Operation and Adjustment Levels are described in *4.1 Setting Levels and Key Operations* (P. 4-2).

This command can be used in both setting area 0 and setting area 1.

To use this command, the communications writing function must be enabled using the Communications Writing operation command.

Response

Slave address	Function code	Write start address		Operation code		Related information	CRC-16
1	H'06	H'00	H'00	H'05	H'00		
1	1	2		2		2	

The response for a normal end is shown above. For information on error responses, refer to 7.7 Operation Commands (P. 7-15).

Software Reset

Command

Slave address	Function code	Write start address		Operation code		Related information	CRC-16
1	H'06	H'00	H'00	H'06	H'00		
1	1	2		2		2	

A software reset causes the same operation as turning the power OFF and ON.

This command can be used in both setting area 0 and setting area 1.

To use this command, the communications writing function must be enabled using the Communications Writing operation command.

Response

Slave address	Function code	Write start address		Operation code		Related information	CRC-16
1	H'06	H'00	H'00	H'06	H'00		
1	1	2		2		2	

The response for a normal end is shown above. For information on error responses, refer to 7.7 Operation Commands (P. 7-15).

Move to Setting Area 1

Command

Slave address	Function code	Write start address		Operation code		Related information	CRC-16
1	H'06	H'00	H'00	H'07	H'00		
1	1	2		2		2	

Use this command to move to setting area 1.

The command is used in setting area 0. Nothing happens if the command is used in setting area 1.

If the command is used when the Initial Setting Protection parameter is set to 2 (Disable Move to Input Initial Setting Level), an operation error will occur.

To use this command, the communications writing function must be enabled using the Communications Writing operation command.

Response

Slave address	Function code	Write start address	Operation code	Related information	CRC-16
	H'06	H'00	H'00	H'07	H'00
1	1	2	2	2	2

The response for a normal end is shown above. For information on error responses, refer to 7.7 Operation Commands (P. 7-15).

Move to Protect Level

Command

Slave address	Function code	Write start address	Operation code	Related information	CRC-16
	H'06	H'00	H'00	H'08	H'00
1	1	2	2	2	2

Use this command to move to Protect Level. Protect Level is described in 4.1 Setting Levels and Key Operations (P. 4-2).

This command is used in setting area 0. If used in setting area 1, an operation error will result.

To use this command, the communications writing function must be enabled using the Communications Writing operation command.

Response

Slave address	Function code	Write start address	Operation code	Related information	CRC-16
	H'06	H'00	H'00	H'08	H'00
1	1	2	2	2	2

The response for a normal end is shown above. For information on error responses, refer to 7.7 Operation Commands (P. 7-15).

Auto/Manual

Command

Slave address	Function code	Write start address	Operation code	Related information	CRC-16
	H'06	H'00	H'00	H'09	
1	1	2	2	2	2

Related information	Description	
	Ch	Command mode
H'00	1	Auto
H'01		Manual
H'10	2	Auto
H'11		Manual
H'20	3	Auto
H'21		Manual
H'30	4	Auto
H'31		Manual

Related information	Description	
	Ch	Command mode
H'F0	All	Auto
H'F1		Manual

Use this command to select automatic or manual operation.

This command is used in setting area 0. If used in setting area 1, an operation error will result.

To use this command, the communications writing function must be enabled using the Communications Writing operation command.

When the control mode is set to cascade control, perform the Auto/Manual operation command for channel 2.

Response

Slave address	Function code	Write start address		Operation code	Related information	CRC-16
	H'06	H'00	H'00	H'09		
1	1	2		2		2

The response for a normal end is shown above. For information on error responses, refer to *7.7 Operation Commands* (P. 7-15).

Parameter Initialization

Command

Slave address	Function code	Write start address		Operation code	Related information	CRC-16
	H'06	H'00	H'00	H'0B	H'00	
1	1	2		2		2

This command returns all settings to the default settings.

This command is used in setting area 1. If used in setting area 0, an operation error will result.

To use this command, the communications writing function must be enabled using the Communications Writing operation command.

Response

Slave address	Function code	Write start address		Operation code	Related information	CRC-16
	H'06	H'00	H'00	H'0B	H'00	
1	1	2		2		2

The response for a normal end is shown above. For information on error responses, refer to *7.7 Operation Commands* (P. 7-15).

■ Alarm Latch Cancel

Command

Slave address	Function code	Write start address		Operation code	Related information	CRC-16
1	H'06	H'00	H'00	H'0C		
	1	2		2		2

Related information	Description	
	Ch	Command mode
H'00	1	Alarm Latch Cancel
H'10	2	Alarm Latch Cancel
H'20	3	Alarm Latch Cancel
H'30	4	Alarm Latch Cancel
H'F0	All	Alarm Latch Cancel

This command cancels alarm latch. The command is used when the alarm latch function is in use.

This command can be used in both setting area 0 and setting area 1.

If AT is being executed for the specified channel, an operation error will occur.

To use this command, the communications writing function must be enabled using the Communications Writing operation command.

Response

Slave address	Function code	Write start address		Operation code	Related information	CRC-16
1	H'06	H'00	H'00	H'0C		
	1	2		2		2

The response for a normal end is shown above. For information on error responses, refer to 7.7 Operation Commands (P. 7-15).

■ SP Mode

Command

Slave address	Function code	Write start address		Operation code	Related information	CRC-16
1	H'06	H'00	H'00	H'0D		
	1	2		2		2

Related information	Description	
	Ch	Command mode
"00"	1	Program SP
"01"		Remote SP
"02"		Fixed SP
"10"	2	Program SP
"11"		Remote SP (Close Cascade)
"12"		Remote SP (Open Cascade)
"21"	3	Remote SP
"22"		Fixed SP

Related information	Description	
	Ch	Command mode
"31"	4	Remote SP
"32"		Fixed SP
"F1"	All	Remote SP
"F2"		Fixed SP

Use this command to select the SP Mode. Refer to *SP Modes* in 5.7 *Program Operation Functions* (P. 5-31) for details on the SP Mode.

This command can be used in both setting area 0 and setting area 1.

If AT is being run in the specified channel, an operation error will occur.

To use this command, the communications writing function must be enabled using the Communications Writing operation command.

Response

Slave address	Function code	Write start address		Operation code	Related information	CRC-16
	H'06	H'00	H'00	H'0D		
1	1	2		2		2

The response for a normal end is shown above. For information on error responses, refer to 7.7 *Operation Commands* (P. 7-15).

■ Hold

Command

Slave address	Function code	Write start address		Operation code	Related information	CRC-16
	H'06	H'00	H'00	H'12		
1	1	2		2		2

Related information	Description	
	Ch	Command mode
"00"	1	Hold Cancel
"01"		Hold
"10"	2	Hold Cancel
"11"		Hold
"20"	3	Hold Cancel
"21"		Hold
"30"	4	Hold Cancel
"31"		Hold
"F0"	All	Hold Cancel
"F1"		Hold

This command starts or cancels the hold operation.

This command is used in setting area 0. An operation error will occur if it is used in setting area 1.

Operation errors will also occur in the following cases:

- If AT is being executed
- If the specified channel is being reset or is on standby

To use this command, the communications writing function must be enabled using the Communications Writing operation command.

Response

Slave address	Function code	Write start address	Operation code	Related information	CRC-16
1	H'06	H'00	H'00	H'12	
1	1	2	2	2	2

The response for a normal end is shown above. For information on error responses, refer to 7.7 Operation Commands (P. 7-15).

■ Advance

Command

Slave address	Function code	Write start address	Operation code	Related information	CRC-16
1	H'06	H'00	H'00	H'13	
1	1	2	2	2	2

Related information	Description	
	Ch	Command mode
"00"	1	Advance
"10"	2	Advance
"20"	3	Advance
"30"	4	Advance
"F0"	All	Advance

This command executes an advance operation. Operation will move to the beginning of the next segment.

This command is used in setting area 0. An operation error will occur if it is used in setting area 1.

Operation errors will also occur in the following cases:

- If AT is being executed
- If the specified channel is being reset or is on standby

To use this command, the communications writing function must be enabled using the Communications Writing operation command.

Response

Slave address	Function code	Write start address	Operation code	Related information	CRC-16
1	H'06	H'00	H'00	H'13	
1	1	2	2	2	2

The response for a normal end is shown above. For information on error responses, refer to 7.7 Operation Commands (P. 7-15).

■ Back

Command

Slave address	Function code	Write start address		Operation code	Related information	CRC-16
1	H'06	H'00	H'00	H'14		
1	1	2	2	2		2

Related information	Description	
	Ch	Command mode
"00"	1	Back
"10"	2	Back
"20"	3	Back
"30"	4	Back
"F0"	All	Back

This command executes a back operation. Operation will move to the beginning of the current segment.

This command is used in setting area 0. An operation error will occur if it is used in setting area 1.

Operation errors will also occur in the following cases:

- If AT is being executed
- If the specified channel is being reset or is on standby

To use this command, the communications writing function must be enabled using the Communications Writing operation command.

Response

Slave address	Function code	Write start address		Operation code	Related information	CRC-16
1	H'06	H'00	H'00	H'14		
1	1	2	2	2		2

The response for a normal end is shown above. For information on error responses, refer to 7.7 Operation Commands (P. 7-15).

■ Echoback Test

Command

Slave address	Function code	Write start address		Test data	CRC-16
1	H'08	H'00	H'00		
1	1	2	2	2	2

This command is used to perform an echoback test.

The command can be used in any state of the E5AR-T/ER-T.

The test data can be any two bytes of hexadecimal data.

Response

Slave address	Function code	Write start address		Test data	CRC-16
1	H'08	H'00	H'00		
1	1	2	2	2	2

The response for a normal end is shown above. For information on error responses, refer to 7.7 Operation Commands (P. 7-15).

Section 8 Parameters

8.1	Using this Section	8-2
8.2	Protect Level (L.Prk)	8-3
8.3	Operation Level ()	8-6
8.4	Program Setting Level ()	8-16
8.5	Adjustment Level (L.Adj)	8-22
8.6	Adjustment 2 Level (L.Ad2)	8-33
8.7	Alarm Set Setting Level (L.Aln)	8-36
8.8	PID Setting Level (L.Pid)	8-39
8.9	Time Signal Setting Level ()	8-43
8.10	Approximation Setting Level (L.EE)	8-46
8.11	Input Initial Setting Level (L.I)	8-49
8.12	Control Initial Setting Level (L.I)	8-55
8.13	Control Initial Setting 2 Level (L.I2)	8-63
8.14	Alarm Setting Level (L.A)	8-74
8.15	Display Adjustment Level (L.Y)	8-80
8.16	Communications Setting Level (L.S)	8-84
8.17	Advanced Function Setting Level (L.AdF)	8-88
8.18	Expansion Control Setting Level (L.Eu)	8-94

8.1 Using this Section

● Marks Used in this Section



Indicates the description of the meaning and function of the parameter.



Indicates the setting range and initial setting of the parameter.



Indicates parameters used for monitor values.



Indicates the description of a procedure for operating the E5AR-T/ER-T.



Indicates where a parameter is described and notes related to parameters.

● Conditions for Displaying Parameters

A parameter will only appear on the display of the E5AR-T/ER-T when the conditions for use of the parameter are satisfied. (Conditions for use are indicated to the right of the parameter name.) Protected parameters, however, are not displayed regardless of the conditions for use, although they are in effect.

For parameters that can be set separately for each channel on a Controller with more than one input, **CH** appears to upper left of the parameter in this section.

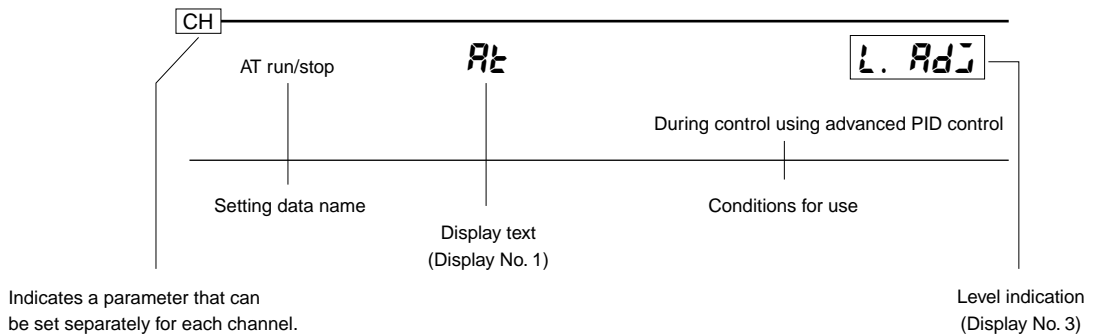

● Order of Parameters

Parameter are described by level.

8.2 Protect Level (L.Pr.t)

Protect Level consists of four types of protection: Operation Adjustment Protection, Initial Setting Protection, Setting Change Protection, and PF Key Protection. Each is used to protect the corresponding settings and prevent accidental changes to the settings.

● Level Changes at Startup Up To Protect Level

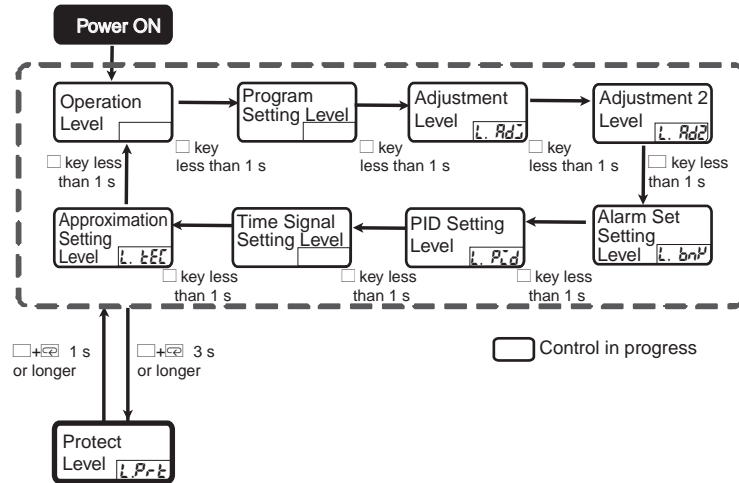

● Parameter Changes within Protect Level

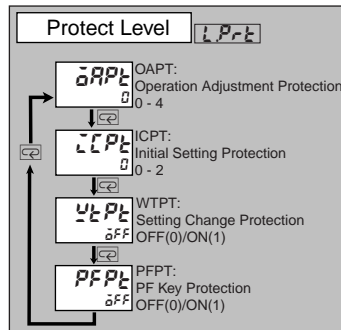

Operation Adjustment Protection	$\Delta R P t$	$L P r t$
Initial Setting Protection	$\bar{L} C P t$	
Setting Change Protection	$\bar{V} t P t$	
PF Key Protection	$P F P t$	

The parameters that are protected are indicated below. Default settings are shaded.



• Operation Adjustment Protection

This function restricts key operation in Operation Level, Program Setting Level, Adjustment Level, Adjustment 2 Level, Alarm Set Setting Level, PID Setting Level, Time Signal Setting Level, Approximation Setting Level, and Monitor Item Level.



Set value	Operation Level		Program Setting Level, Adjustment Level, and Adjustment 2 Level	Alarm Set Setting Level, PID Setting Level, Time Signal Setting Level, Approximation Level and Monitor Item Level
	PV, Fixed SP, or Program Number	Other		
0	Enabled	Enabled	Enabled	Enabled
1	Enabled	Enabled	Enabled	Prohibited
2	Enabled	Enabled	Prohibited	Prohibited
3	Enabled	Prohibited	Prohibited	Prohibited
4	Restrictions *	Prohibited	Prohibited	Prohibited

* The Program No. parameter is prohibited.

Enabled: No restrictions (Parameters can be displayed or changed, and the level can be entered.)

Restrictions: Some restrictions apply. (Parameters can be displayed but not changed.)

Prohibited: The parameters are completely protected. (Parameters cannot be displayed and the level can be entered.)



• Initial Setting Protection

Restricts movement to the Input Initial Setting Level, Control Initial Setting Level, Control Initial Setting 2 Level, Alarm Setting Level, Display Adjustment Level, and Communications Setting Level.





Set value	Move to Input Initial Setting Level	Move to Control initial Setting, Control Initial Setting 2, Alarm Setting, Display Adjustment, and Communications Setting Level
0	Enabled (displays Advanced Function Setting Level)	Enabled
1	Enabled (Does not display Advanced Function Setting Level)	Enabled
2	Prohibited	Prohibited

- When the Initial Setting Protection parameter is set to 2, nothing happens when the Level Key is held down for 1 second or more to move to Input Initial Setting Level from Operation Level, Program Setting Level, Adjustment Level, Adjustment 2 Level, Alarm Set Setting Level, PID Setting Level, Time Signal Setting Level, Approximation Setting Level, or Monitor Item Level. (The display will also not flash to indicate the move.)



• Setting Change Protection

Prevents use of the  and  Keys.



Set value	Changing set values using key operations	Exceptions
OFF	Enabled	–
ON	Prohibited	<ul style="list-style-type: none"> • All parameters in Protect Level • Move to Advanced Function Setting Level • Move to Calibration Level • Program Editing • Segment Editing • Display Set Setting Level • Display PID Selection

- The Setting Change Protection parameter is set to “OFF” by default.



• PF Key Protection

Prevents use of the PF1 and PF2 Keys.



Set value	Changing set values using key operations
OFF	PF1/PF2 Keys are enabled
ON	PF1/PF2 Keys are disabled (operation as a function key and channel key is disabled)

- The PF Key Protection parameter is set to “OFF” by default.

8.3 Operation Level ()

Display this level to operate the control system. The SP can be set and the PV monitored in this level.

● Level Changes at Startup Up To Operation Level

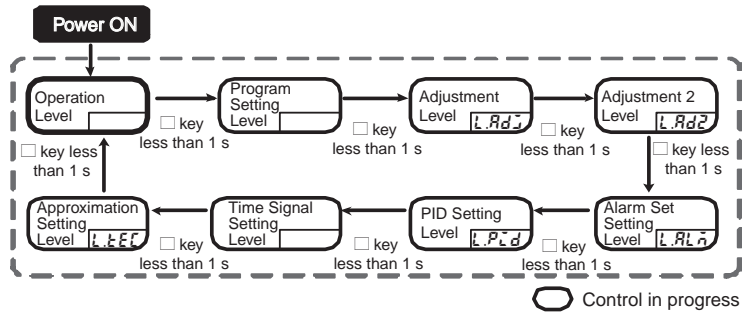

● Parameter Changes within Operation Level

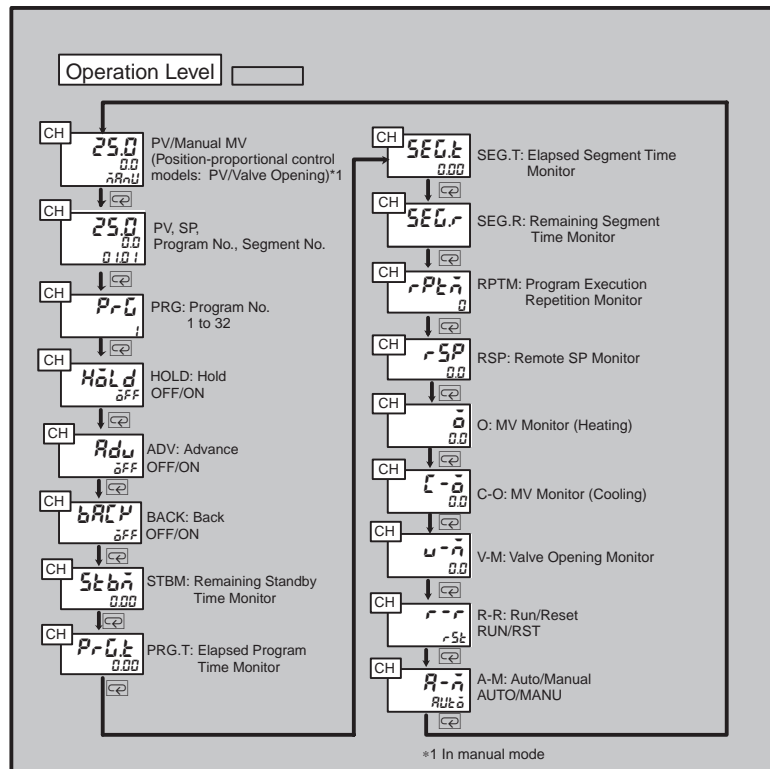

CH

Manual MV

MANU

Manual operation



- This parameter sets the MV or valve opening during manual operation. On a Standard Control Model the MV is changed by pressing the and Keys. On a Position-proportional Control Model, the Key turns ON the open side and the Key turns ON the close side.

- On a Standard Control Model, Display No. 1 shows the PV and Display No. 2 shows the MV.

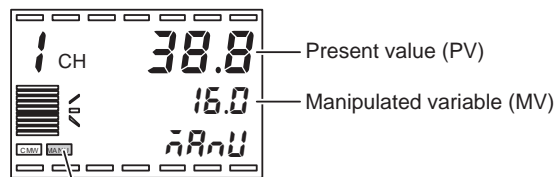

MANU indicator lights.

When changed with the and Keys, the MV is output once every 50 ms.

- When a potentiometer is connected to a Position-proportional Control Model, Display No. 1 shows the PV and Display No. 2 shows the valve opening. When a potentiometer is not connected to a Position-proportional Control Model, Display No. 2 shows "-----."

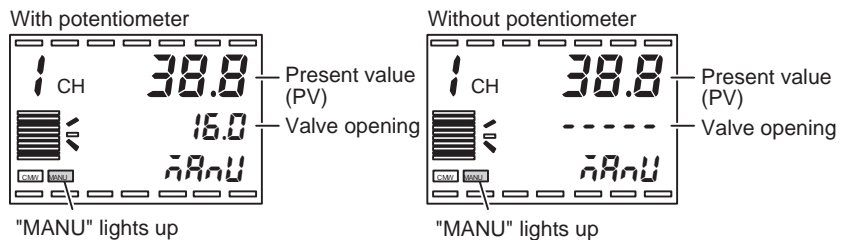

"MANU" lights up

"MANU" lights up

- In Manual Mode, operation is performed manually and the MANU indicator lights.
- The Manual Output Method parameter is used to select the MV that is used when entering Manual Mode. The MV prior to entering Manual Mode can be held, or the Manual MV Initial Value parameter can be used.
- Switching between Manual Mode and Auto Mode is accomplished using the PF Key, or with the Auto/Manual parameter in Operation Level. If either the PF1 Setting parameter or PF2 Setting parameter is set to "A-M," the Auto/Manual parameter will not appear in Operation Level and only the PF Key is used for switching.
- Switching between Auto and Manual with a PF Key
To switch modes, hold down the PF Key for at least one second in Operation Level, Program Setting Level, Adjustment Level, Adjustment 2 Level, Alarm Set Setting Level, PID Setting Level, Time Signal Setting Level, Approximation Setting Level, Monitor Item Level, or Protect Level.

- Switching between Auto and Manual Using the Auto/Manual Parameter
To switch modes, change the setting of the Auto/Manual parameter in Operation Level.
- During cascade control, if the primary loop is switched to Manual Mode when the secondary loop is in any of the following conditions, the manual MV is disabled.
 - The SP mode of the secondary loop is set to “Fixed SP” (cascade open).
 - The secondary loop is in Manual Mode.
 - The operation set to be performed at an error is being performed for the secondary loop.



Setting

• Standard Control Models

Control method	Setting range	Unit	Default value
Standard	-5.0 to 105.0	%	*1
Heating/cooling	-105.0 to 105.0	%	*1

*1 The Manual Output Method parameter (Expansion Control Setting Level) selects the MV that is used when Manual Mode is entered. The MV prior to entering Manual Mode can be held, or the Manual MV Initial Value parameter can be used.

• Position-proportional Control Models

Control method	Monitor range	Unit
Position-proportional	-10.0 to 110.0	%



● Related Parameters

- Auto/Manual (Operation Level) (P. 8-15)
- PF1 Setting and PF2 Setting (Advanced Function Setting Level) (P. 8-89)
- Manual Output Method and Manual MV Initial Value (Expansion Control Setting Level) (P. 8-101)



- Display No. 1 shows the PV and Display No. 2 shows the present set point.
- The Program SP, Fixed SP, or the Remote SP is shown depending on the selected SP mode. For a Remote SP, the value can only be monitored.

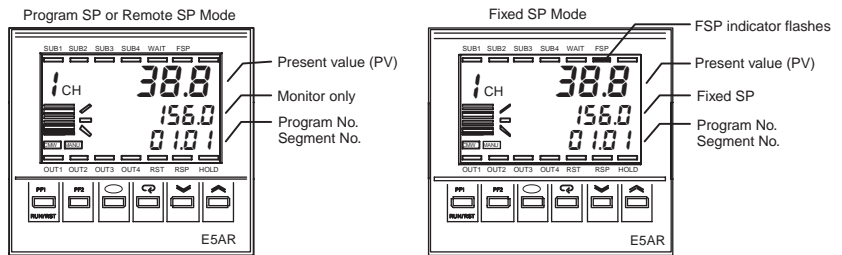

- The decimal point position is determined by the selected sensor for a temperature input, and by scaling for an analog input. If the PV Decimal Point Display parameter is set to “OFF” for a temperature input, digits below the decimal point are not shown.



	Monitor range	Unit
PV	Refer to <i>Appendix Sensor Input Setting Ranges and Display/Control Ranges</i> (P. A-4)	EU

	Setting or monitor range	Unit	Default value
Present Set Point	Program SP or Fixed SP: SP lower limit to SP upper limit	EU	0
	Remote SP: Remote SP lower limit to remote SP upper limit The SP limits are in effect.	EU	-



- Related Parameters
 - Input * Type (Input Initial Setting Level) (P. 8-50)
 - Input* Temperature Units (Input Initial Setting Level) (P. 8-51)
 - Scaling Input Value 1, Scaling Display Value 1, Scaling Input Value 2, Scaling Display Value 2, and Decimal Point Position (Input Initial Setting Level) (P. 8-51)
 - Remote SP Upper Limit and Remote SP Lower Limit (Input Initial Setting Level) (P. 8-52)
 - PV Decimal Point Display (Input Initial Setting Level) (P. 8-53)
 - SP Upper Limit and SP Lower Limit (Control Initial Setting Level) (P. 8-57)
 - SP Mode (Adjustment Level) (P. 8-24)

CH

Program No.

PrG



- This parameter sets the number of the program to be executed.
- This parameter can be set only during a reset.



Setting

Setting or monitor range	Unit	Default value
1 to 32 (See note.)	---	1

Note:The range depends on the values set for the Independent Operation/Coordinated Operation parameter and Number of Segments parameter.



Reference

- Related Parameters
Independent Operation/Coordinated Operation (Control Initial Setting Level) (P. 8-59)
Number of Segments (Control Initial Setting Level) (P. 8-60)

CH

Hold

HöLd

Running



Function

- This parameter is used to hold the timer for program operation.
- The hold is cleared by executing a reset or executing a clear hold command.



Operation

- The hold is enabled when this parameter is set to $\bar{0}n$.
- The default is $\bar{0}FF$: Clear Hold.



Reference

- Related Information
5.7 Program Operation Functions (P. 5-28)

CH

Advance

ADV

Running



- This parameter is used to advance the program to the beginning of the next segment. If the advance operation is executed during a hold, the program is advanced to the beginning of the next segment and the hold status is continued.



- The set value is $\bar{0}FF$ when switching to this parameter.
- Change the set value to $\bar{0}n$ to advance the program to the next segment.
- When the advance command execution has been completed, the set value will automatically return to $\bar{0}FF$.



- Related Information
5.7 Program Operation Functions (P. 5-28)

CH

Back

BACK

Running



- This parameter is used to return the program to the start of the segment being executed. If the back operation is executed during a hold, the program returns to the beginning of the segment being executed and the hold status is continued.



- The set value is $\bar{0}FF$ when switching to this parameter.
- Change the set value to $\bar{0}n$ to return to the beginning of the current segment.
- When the back command execution has been completed, the set value will automatically return to $\bar{0}FF$.



- Related Information
5.7 Program Operation Functions (P. 5-28)

CH

Remaining Standby Time Monitor	Stbñ	<input type="text"/>
Elapsed Program Time Monitor	PrGt	Running
Elapsed Segment Time Monitor	SEGt	
Remaining Segment Time Monitor	SEGr	

These parameters are used to monitor the progress of the program.



- The Remaining Standby Time Monitor parameter monitors how much standby time is remaining.
- The Elapsed Program Time Monitor parameter monitors how much time has elapsed since the start of the current program.
- The Elapsed Segment Time Monitor parameter monitors how much time has elapsed since the start of the current segment.
- The Remaining Segment Time Monitor monitors how much time is left for the current segment.



Control	Monitor range	Unit
Remaining Standby Time Monitor	0.00 to 99.59	h.min
Elapsed Program Time Monitor	0.00 to 99.59 or	program time
Elapsed Segment Time Monitor	0.00.0 to 99.59.9	unit
Remaining Segment Time Monitor		



- Related Information
5.7 Program Operation Functions (P. 5-28)
- Related Parameters
Standby Time (Adjustment Level) (P. 8-28)

CH

Program Execution Repetition Monitor	rPlñ	<input type="text"/>
		Running



- This parameter is used to monitor the number of times a program has been repeated.



Monitor range	Unit
0 to 9,999	times



- Related Information
5.7 Program Operation Functions (P. 5-28)
- Related Parameters
Program Repetitions (Program Setting Level) (P. 8-21)

CH

Remote SP Monitor

rSP

Program SP or Fixed SP Mode with remote SP or
Coordinated operation with fixed SP



- This parameter is used to monitor the remote SP while in Program SP or Fixed SP Mode.
- In Remote SP Mode, the remote SP can be monitored on Display No. 2 of the Present Value (PV)/Present Set Point display.

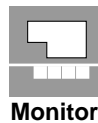

Monitor range	Unit
Remote SP lower limit to remote SP upper limit The SP limits are in effect.	EU



- Related Parameters
Present Value (PV)/Preset Set Point (Operation Level) (P. 8-9)
SP Mode (Adjustment Level) (P. 8-24)
Remote SP Upper Limit and Remote SP Lower Limit (Input Initial Setting Level) (P. 8-52)
Control Mode (Control Initial Setting Level) (P. 8-58)

CH

MV Monitor (Heating)

m

Standard control or heating/cooling control

This parameter monitors the heating MV during operation.



- This parameter monitors the MV of standard control and the heating MV of heating/cooling control.



Control	Monitor range	Unit
Standard	-5.0 to 105.0	%
Heating/ cooling	0.0 to 105.0	%

CH

MV Monitor (Cooling)

[-ā]

Heating/cooling control

This parameter monitors the cooling MV during operation.



- This parameter monitors the cooling MV during heating/cooling control.



Control	Monitor range	Unit
Heating/cooling	0.0 to 105.0	%



- Related Parameters
Control Mode (Control Initial Setting Level) (P. 8-58)

CH

Valve Opening Monitor

μ-ā

Position-proportional Control Model

This parameter monitors the amount of valve opening during operation.



- This parameter monitors the amount of valve opening during position-proportional control.
- A potentiometer can be connected and the Motor Calibration parameter can be executed to monitor the amount of valve opening.



Control	Monitor range	Unit
Position-proportional	-10.0 to 110.0	%



- Related Parameters
Control Mode (Control Initial Setting Level) (P. 8-58)
Motor Calibration (Control Initial Setting 2 Level) (P. 8-72)

CH

Run/Reset

r-r



Function

- Use this parameter to start and stop program operation.
- The default setting is r5t (Reset).



Operation

Press the and Keys to select r5n (Run) or r5t (Reset). When “Reset” is selected, the RST indicator will light.



Reference

- Related Information
4.12 Starting and Stopping Operation (P. 4-41)
- Related Parameters
PF1 Setting and PF2 Setting (Advanced Function Setting Level)
(P. 8-89)

CH

Auto/Manual

A-M

PF1 setting ≠ Auto/Manual
and
PF2 setting ≠ Auto/Manual



Function

- Use this parameter to select Auto or Manual Mode.
- The default setting is AUtō (Auto).



Operation

Press the and Keys to select AUtō (Auto) for Auto Mode, or MAnU (Manual) for Manual Mode. When Manual Mode is selected, the MANU indicator lights.

- This parameter does not appear if either the PF1 Setting or PF2 setting parameter is set to Auto/Manual.



Reference

- Related Information
4.13 Manual Operation (P. 4-47)
- Related Parameters
PF1 Setting and PF2 Setting (Advanced Function Setting Level)
(P. 8-89)

8.4 Program Setting Level ()

The Program Setting Level parameter is used to make the SP, time, rate of rise, and other program settings.

The Program Editing parameter, the first parameter displayed under Program Setting Level, is used to move to each program.

● Level Changes at Startup Up To Program Setting Level

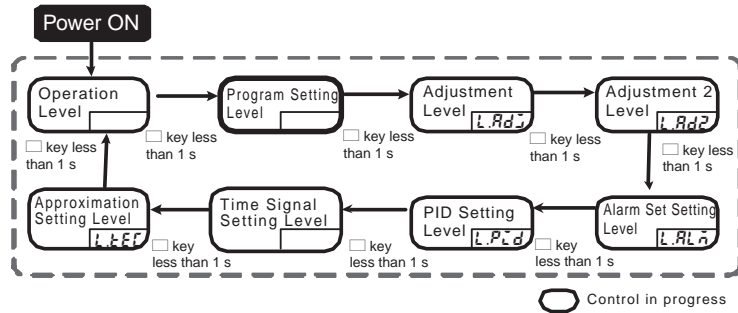

● Parameter Changes within Program Setting Level

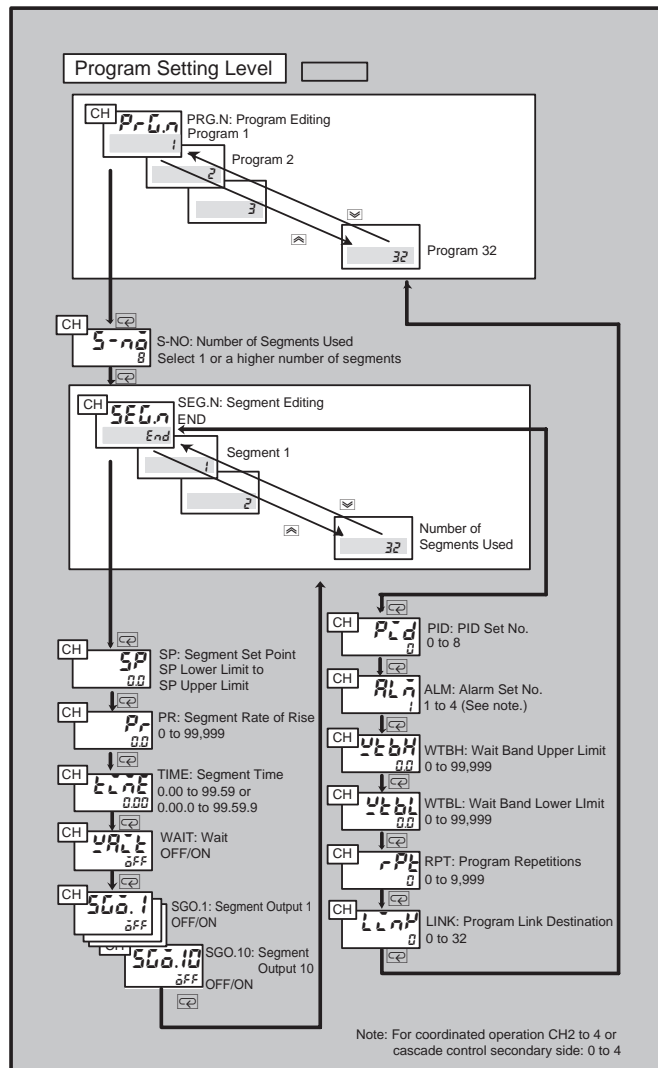

CH

Program Editing

PrG.n

CH1 or
CH2 for independent operation

The Program Editing parameter is used to make program settings.



- This parameter is used to set the program number of the program.



Setting range	Unit	Default value
1 to 32	-	See note.

Setting

Note:The default program is the selected program number.

CH

Number of Segments Used

S-nb

CH1 or
CH2 for independent operation

- This parameter is used to specify the number of program segments.



Setting

Setting range	Unit	Default value
1 to setting of Number of Segments parameter	-	8



- Related Information
4.8 Program Settings (P. 4-23)

CH

Segment Editing	SEGN	<input type="text"/>
Segment Set Point	SP	CH1 or CH2 for independent operation
Segment Rate of Rise	Pr	Segment Rate of Rise during Rate of Rise programming only
Segment Time	TIME	

These parameters are used to make segment settings.



- The Segment Editing parameter is used to set the segment number of the segment to be set.
- The Segment Set Point parameter is used to set the set point for each segment. During rate of rise programming, the Segment Set Point parameter is used to set the destination set point.
- The Segment Rate of Rise parameter is used to set the amount of change per rate of rise programming time unit.
- The Segment Time parameter is used to set the segment time.

For rate of rise programming, the Segment Time parameter is used to set the soak segment time.



Parameter	Setting range	Unit	Default value
Segment Editing	End, 1 to setting of Number of Segments Used parameter	EU	End
Segment Set Point	SP lower limit to SP upper limit	EU	0
Segment Rate of Rise	0 to 99,999	EU	0
Segment Time	0.00 to 99.59 or 0.00.0 to 99.59.9	Program time unit	0.00



- Related Information
4.8 Program Settings (P. 4-23)

CH

Wait	WAIT	<input type="text"/>
		CH1 or CH2 for independent operation



- This parameter is used to set whether or not to use the wait function.



Setting range	Unit	Default value
OFF: Disabled	—	OFF: Disabled
ON: Enabled		



- Related Information
Wait in 5.7 Program Operation Functions (P. 5-32)

CH

Segment Output*

S \bar{O} a.*

(*: 1 to 10)

CH1 or CH2 for independent operation with the Segment Output parameter enabled



- This parameter is used to turn auxiliary outputs ON or OFF for the specified segment.



Setting range	Unit	Default value
off: Segment output OFF	-	off
on: Segment output ON		



- Related Information
Segment Outputs in 5.7 Program Operation Functions (P. 5-34)
- Related Parameters
Auxiliary Output * Assignment (Control Initial Setting 2 Level) (P. 8-67)
Program Output Selection (Control Initial Setting 2 Level) (P. 8-68)

CH

PID Set Number

P \bar{I} d

- This parameter is used to set the PID set number for each program.
- When this parameter is set to 0, the PID set number is automatically selected using the PID Set Automatic Selection function and based on the present value (PV), deviation (DV), and present SP (SP). The PID set number can be set between 1 and 8.
- If this parameter is set to 0 for channels 2 to 4 when using coordinated operation or for the secondary side (CH2) when using cascade control, the PID set number selected for channel 1 will be used for the other channels.
For example, if the channel 1 PID set number is set to 0, the PID set for each channel (i.e., channels 2 to 4) will be selected automatically.



Setting range	Unit	Default value
0 to 8	-	0



- Related Information
PID Sets in 5.2 Control Functions (P. 5-10)

CH

Alarm Set Number

ALn

Alarm function enabled



Function

- This parameter is used to set the alarm set number for each program.
- If this parameter is set to 0 for channels 2 to 4 when using coordinated operation or for the secondary side (channel 2) when using cascade control, the alarm set number selected for channel 1 will be used for the other channels.



Setting

Setting range	Unit	Default value
1 to 4 (See note.)	-	1 (See note.)

Note:The setting range is 0 to 4 for channels 2 to 4 when using coordinated operation and for the secondary side (channel 2) when using cascade control. The default is 0.



Reference

- Related Information
8.7 Alarm Set Setting Level (P. 8-36)

CH

Wait Band Upper Limit

ULbH

Wait Band Lower Limit

ULbL

CH1 or CH 2 for independent operation

These parameters are used to set the wait operation.



Function

- The Wait Band Upper Limit parameter is used to set the upper deviation for the wait operation.
- The Wait Band Lower Limit parameter is used to set the lower deviation for the wait operation.
- The wait function will not operate if the wait band is set to 0.



Setting

Parameter	Setting range	Unit	Default value
Wait Band Upper Limit	0 to 99,999 (0: OFF)	EU	0: OFF
Wait Band Lower Limit	0 to 99,999 (0: OFF)	EU	0: OFF



Reference

- Related Information
Wait in 5.7 Program Operation Functions (P. 5-32)
- Related Parameter
Wait Mode (Expansion Control Setting Level) (P. 8-96)

CH

Program Repetitions

rPt

Program Link Destination

LINK

CH1 or CH2 for independent operation



- The Program Repetitions parameter is used to set the number of times a program is to be repeated. The number of times the program is executed will be the set value for this parameter + 1.
- The Program Link Destination parameter is used to set the link destination for each program. Once a program has been completed, the operation will continue with the program number specified for this parameter.



Setting

Parameter	Setting range	Unit	Default value
Program Repetitions	0 to 9,999	times	0
Program Link Destination	0 to 32 (0: No program link)	-	0: No link



Reference

- Related Information
Program Operations in 5.7 Program Operation Functions (P. 5-30)

8.5 Adjustment Level (L Ad)

This level contains settings for adjusting control, such as auto-tuning (AT), enabling/disabling writing parameters with communications, changing the SP mode, adjusting hysteresis, and input correction settings.

● Level Changes at Startup Up To Adjustment Level

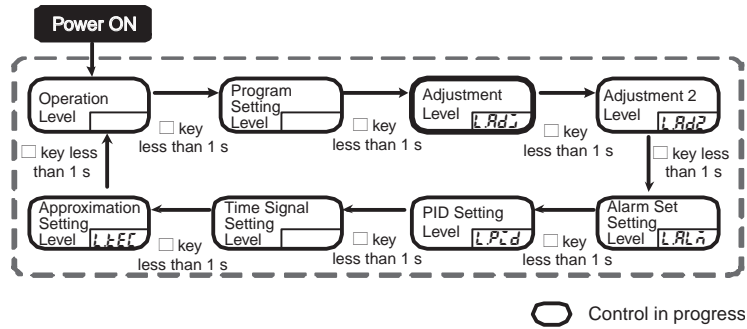

● Parameter Changes within Adjustment Level

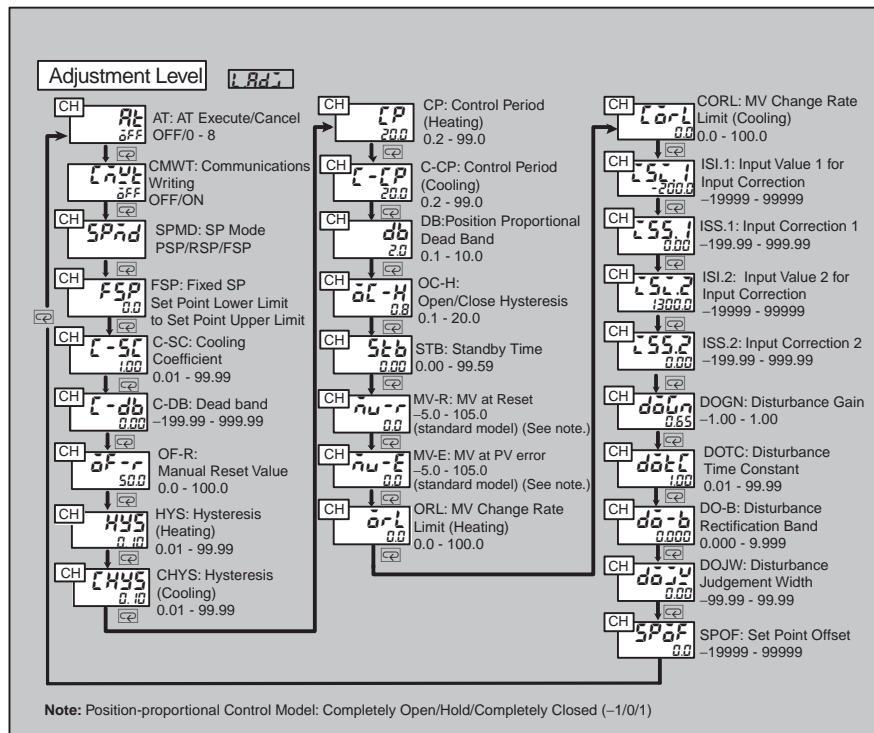

CH

AT Execute/Cancel

At

L.Adj

Auto Mode, running

This parameter is used to execute auto-tuning (AT).



Function

- When auto-tuning is executed, the MV is increased and decreased around the SP to obtain the characteristics of the object of control. The PID constants are calculated from the results and the Proportional Band, Integral Time, and Derivative Time parameters are automatically set.



Operation

- Normally this parameter is $\bar{\alpha}FF$. AT is executed by pressing the  Key to select the PID set number. AT cannot be executed while control is stopped.
- Select 0 to specify the PID set currently being used for control. Select a number from 1 to 8 to specify a PID set number.
- The AT Execute/Cancel parameter automatically returns to $\bar{\alpha}FF$ when finished.
- The SP flashes if the Present Value (PV)/Preset Set Point parameter is monitored during AT.
- The channel cannot be changed during AT.



Reference

- Related Information
4.10 Determining the PID Constants (AT or Manual Settings) (P. 4-33)
- Related Parameters
PID * Proportional Band, PID * Integral Time, and PID * Derivative Time (PID Setting Level) (P. 8-40)

Communications Writing

CnWr

L.Adj

Models that support communications



Function

- This parameter enables or disables the writing of set values from a host (computer) to the Controller.
- The default setting is $\bar{\alpha}FF$ (Disabled).



Operation

Select $\bar{\alpha}n$ to enable or $\bar{\alpha}FF$ to disable writing set values via communications.



Reference

- Related Parameters
Communications Protocol Selection (Communications Setting Level) (P. 8-85)
Communications Unit No (Communications Setting Level) (P. 8-85)
Communications Speed (Communications Setting Level) (P. 8-85)
Communications Data Length (Communications Setting Level) (P. 8-86)
Communications Stop Bit (Communications Setting Level) (P. 8-86)
Communications Parity (Communications Setting Level) (P. 8-86)
Transmission Wait Time (Communications Setting Level) (P. 8-87)

CH

SP Mode

SP^{Mod}

LAdj

Operation at Reset parameter set to “Stop Control” or Control Mode parameter set to “Remote SP” or “Proportional Control”



Function

- Use this parameter to select the SP mode.
- In Program SP Mode, the SP corresponding to the set program will be used for control. In Remote SP Mode, the remote SP specified by an external input (e.g., 4 to 20 mA) will be the SP. In Fixed SP Mode, the value set for the Fixed SP parameter will be used as the SP.
- The default setting for this parameter is “Program SP Mode”. For coordination operation CH2 to CH4 and the cascade control secondary side (CH2), the default is Remote SP Mode. Furthermore, if the Operation at Reset parameter is set to “Fixed Control”, all control will be in Fixed SP Mode except for the cascade control secondary side (CH2).



Operation

- Use the and Keys to select **PSP** (Program SP) for Program SP Mode. Select **RSP** (Remote SP) for Remote SP Mode. When Fixed SP Mode is selected, the RSP indicator lights. Select **FSP** (Fixed SP) for Fixed SP Mode. When Fixed SP Mode is selected, the FSP indicator lights.
- When cascade control is used, cascade open (secondary loop independent control) takes place when the SP mode of channel 2 is Fixed SP Mode, and cascade closed (cascade control) takes place when the SP mode is Remote SP Mode.
- For coordinated operation, channels 2 to 4 will be in Remote SP Mode.



Reference

- Related Information
SP Modes in 5.7 Program Operation Functions (P. 5-31)
- Related Parameters
Control Mode (Control Initial Setting Level) (P. 8-58)

CH

Fixed SP

FSP

LAdj



Function

- This parameter is used to set the SP used in Fixed SP Mode.



Setting

Setting range	Unit	Default value
Set Point Lower Limit to Set Point Upper Limit	EU	0



Reference

- Related Information
SP Modes in 5.7 Program Operation Functions (P. 5-31)
- Related Parameters
SP Mode (Adjustment Level) (P. 8-24)

CH

Cooling Coefficient

[-5]

L.Adj

Heating/cooling control, Advanced PID control
(Proportional band \neq 0.00)

If there is a large difference in the heating and cooling characteristics of the object and satisfactory control is not possible using the same PID constants, the heating P (proportional band) can be multiplied by a coefficient for use in cooling control.



- The cooling P in heating/cooling control is obtained using the following equation and the coefficient is set accordingly.
Cooling P = Cooling coefficient \times P (heating proportional band)



Setting

Setting range	Unit	Default value
0.01 to 99.99	None	1.00



- Related Parameters
PID* Proportional Band (PID Setting Level) (P. 8-40)

CH

Dead Band

[-db]

L.Adj

Heating/cooling control

This parameter sets an output dead band for heating/cooling control. A negative value can also be set to create an overlap band.



- Set an area centered on the SP where the control amount is 0 during heating/cooling control.



Setting

Setting range	Unit	Default value
-19.99 to 99.99	%FS	0.00

CH

Manual Reset Value $\bar{\Delta}F-r$

LAdj

2-PID control (Proportional band $\neq 0.00$), Integral time = 0



- This parameter is used to set an MV for rectification during P and PD control to eliminate an offset.
- This parameter is displayed only when the proportional band $\neq 0.00$ and the integral time = 0.



Setting range	Unit	Default value
0.0 to 100.0	%	50.0



- Related Parameters
PID* Proportional Band and PID* Integral time (PID Setting Level) (P. 8-40)

CH

Hysteresis (Heating)

HYS

LAdj

Hysteresis (Cooling)

[HYS

ON/OFF Control (P = 0.0)

These parameters set the hystereses to enable stable operation when control is switched ON/OFF.



- For standard control, the Hysteresis (Heating) parameter is used. The Hysteresis (Cooling) parameter cannot be used.
- For heating/cooling control, the hysteresis can be set separately for heating and cooling. Use the Hysteresis (Heating) parameter for heating and the Hysteresis (Cooling) parameter for cooling.
- These parameters are displayed when the Proportional Band parameter is set to 0.00.



Setting range	Unit	Default value
0.01 to 99.99	%FS	0.10



- Related Parameters
PID* Proportional Band (PID Setting Level) (P. 8-40)

CH

Control Period (Heating)

[P

L.Adj

Control Period (Cooling)

[-[P



- These parameters set the output periods. When setting these parameters, take controllability and product life (if the connected device is a relay) into consideration.
- The Control Period (Heating) parameter is used for standard control.
- For heating/cooling control, control periods can be set separately for heating and cooling.



Parameter	Setting range	Unit	Default value
Control Period (Heating)	0.2 to 99.0	s	20.0
Control Period (Cooling)	0.2 to 99.0	s	20.0



- Related Parameters
PID* Proportional Band (PID Setting Level) (P. 8-40)

CH

Position-proportional Dead
Band

db

L.Adj

Position-proportional Control Model



- This parameter sets the output hold interval (the interval between switching the open output and close output ON and OFF) during position-proportional control.



Data range	Unit	Default value
0.1 to 10.0	%	2.0



- Related Parameters
Open/Close Hysteresis (Adjustment Level) (P. 8-28)

CH

Open/Close Hysteresis

0C-H

LAdj

Position-proportional Control Model



Function

- This parameter is used to add hysteresis when switching the open output and close output ON and OFF during position-proportional control.



Setting

Data range	Unit	Default value
0.1 to 20.0	%	0.8



Reference

- Related Parameters
Position-proportional Dead Band (Adjustment Level) (P. 8-27)

CH

Standby Time

5tb

LAdj



Function

- This parameter is used to set the time from when the run command is executed until the program starts operation.



Setting

Setting parameter	Unit	Default value
0.00 to 99.59	h.min	0.00



Reference

- Related Information
Operation at Program Start in *5.7 Program Operation Functions* (P. 5-37)

CH

MV at Reset (Standard/Heating/Cooling) $\bar{n}u-r$

L.Adj

MV at PV Error $\bar{n}u-E$ 

Function

- On a Standard Control Model, the MV at Reset parameter is set to the MV to output when operation is stopped. On a Position-proportional Control Model, the MV at Reset parameter is set to the position when operation is stopped (Closed/Hold/Open). If the Operation at Reset parameter is set to "Fixed Control", the MV cannot be used.
- On a Standard Control Model, the MV at PV Error parameter is set to the MV to output when an error occurs. On a Position-proportional Control Model, the MV at Reset parameter is set to the position when an error occurs (Closed/Hold/Open).
- Standard Control Model



Setting

Control method	Setting range	Unit	Default value
Standard	-5.0 to 105.0	%	0.0
Heating/Cooling	-105.0 to 105.0	%	0.0

A negative value is set for the cooling MV for heating/cooling control.

- Position-proportional Control Model

Control method	Setting range	Unit	Default value
Position Proportional	-1: Closed, 0: Hold, 1: Open	-	0: Hold



Reference

- Related Information
4.12 Starting and Stopping Operation (P. 4-41)

CH

MV Change Rate Limit (Heating)

̄rL

LAd

MV Change Rate Limit (Cooling)

[̄rL

2-PID control
(Proportional band ≠ 0.00)



- The MV change rate limits set the maximum allowed change in the MV (or the opening on a Position-proportional Control Model) per second. If a change occurs in the MV that exceeds this limit, the MV will be changed at the set rate limit until the required change is attained. When set to 0.0, the function is disabled.
- For standard control, use the MV Change Rate Limit (Heating) parameter. The MV Change Rate Limit (Cooling) parameter cannot be used.
- For heating/cooling control, the MV change rate limit can be set separately for heating and cooling. Use the MV Change Rate Limit (Heating) parameter for heating and the MV Change Rate Limit (Cooling) parameter for cooling.
- The MV change rate limits cannot be used in the following situations:
 - In Manual Mode
 - When AT is being executed
 - During ON/OFF control (P=0.00)
 - During a reset (i.e., while outputting the value set for the MV at Reset parameter)
 - During an error (i.e., while outputting the value set for the MV at PV Error parameter)



Setting

Parameter	Setting range	Unit	Default value
MV Change Rate Limit (Heating)	0.0 to 100.0	%/s	0.0: Disabled
MV Change Rate Limit (Cooling)	0.0 to 100.0	%/s	0.0: Disabled



Reference

- Related Parameters
 - PID* Proportional Band (PID Setting Level) (P. 8-40)
 - MV Change Rate Limit Mode (Expansion Control Setting Level) (P. 8-102)

CH

Input Value 1 for Input Correction	252.1
Input Correction 1	255.1
Input Value 2 for Input Correction	252.2
Input Correction 2	255.2

L.Adj

The input can be corrected at any two points.



These parameters are used to set correction values (Input Correction 1 and Input Correction 2 parameters) for any two points (Input Value 1 for Input Correction and Input Value 2 for Input Correction parameters) for two-point correction.

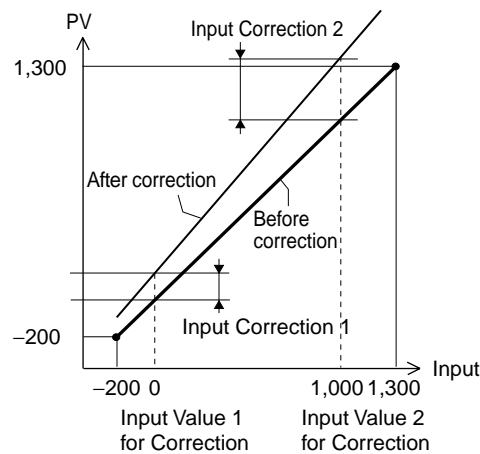

Setting

Parameter	Setting range	Unit	Default value
Input Value 1 for Input Correction	-19999 to 99999 *1	EU	-200.0
Input Correction 1	-199.99 to 999.99	EU	0.00
Input Value 2 for Input Correction	-19999 to 99999 *1	EU	1300.0
Input Correction 2	-199.99 to 999.99	EU	0.00

*1 The decimal point position depends on the input type.

*2 If the input type is changed, the default values of the input value for input calibration will change to the upper and lower-limits of the input range of the sensor type being used.



Reference

- Related Parameters
Input * Type (Input Initial Setting Level) (P. 8-50)

CH

Disturbance Gain	$d\ddot{o}Gn$	LAdj
Disturbance Time Constant	$d\ddot{o}tC$	
Disturbance Rectification Band	$d\ddot{o}-b$	Disturbance overshoot adjustment is enabled
Disturbance Judgment Width	$d\ddot{o}JW$	

These parameters are used to adjust overshooting caused by disturbance.



- Disturbance gain is used to adjust the amount of overshooting caused by disturbance.



Parameter	Setting range	Unit	Default value
Disturbance Gain	-1.00 to 1.00	-	0.65
Disturbance Time Constant	0.01 to 99.99	-	1.00
Disturbance Rectification Band	0.000 to 9.999	%FS	0.000
Disturbance Judgment Width	-99.99 to 99.99	%FS	0.00



- Related Parameters
Disturbance Overshoot Adjustment Function (Expansion Control Setting Level) (P. 8-104)

CH

Set Point Offset	$SP\ddot{o}F$	LAdj
		Coordinated operation



- This parameter is during coordinated operation to offset the channel 1 set point for program operation.



Monitor range	Unit	Default value
-19,999 to 99,999	EU	0



- Related Information
Operating Programs Using Multiple Channels in 5.2 Control Functions (P. 5-11)
- Related Parameters
Set Point Selection (Control Initial Setting Level) (P. 8-62)

8.6 Adjustment 2 Level (L.Ad2)

Adjustment 2 Level contains supplemental parameters for adjusting control, such as time constants for first order lag operations, movement average count, low-cut point for extraction of square root operations, and parameters for proportional control. These functions appear on the display only if they are enabled in Control Initial Setting 2 Level.

● Level Changes at Startup Up To Adjustment 2 Level

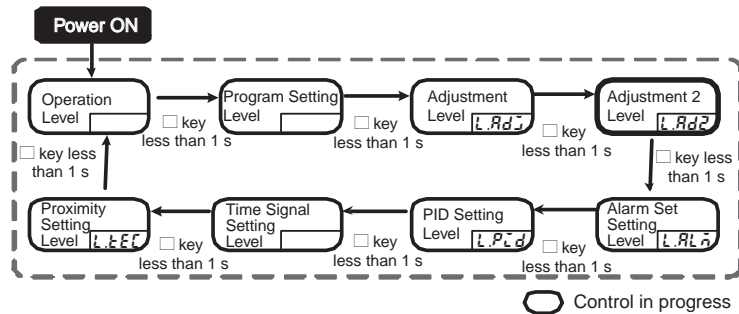

● Parameter Changes within Adjustment 2 Level

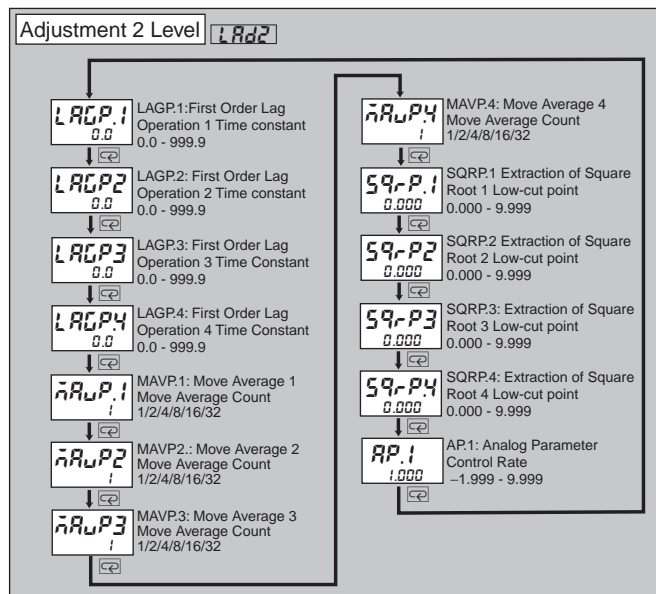

First Order Lag Operation * Time Constant **LADP.***

LAD2

(*: 1 to 4)

First Order Lag Operation *
Function is enabled



- These parameters are used to set the time constant of the first order filter of each input. Data resulting from the first order lag filter is shown below.
- The filter is used to filter out noise elements in the input.

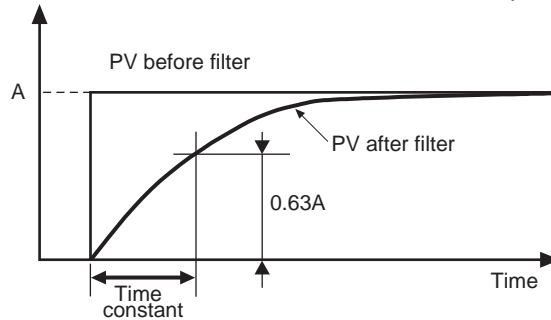

Setting

Setting range	Unit	Default value
0.0 to 999.9	s	0.0



Reference

- Related Information
First Order Lag Operation in 5.1 Input Adjustment Functions (P. 5-5)
- Related Parameters
First Order Lag Operation * Enabled (Control Initial Setting 2 Level) (P. 8-70)

Move Average * Move Average Count **MAUP.***

LAD2

(*: 1 to 4)

Movement Average *
Function is enabled



- These parameters set the move average count for move averaging for each input. Data resulting from the movement average is shown below.

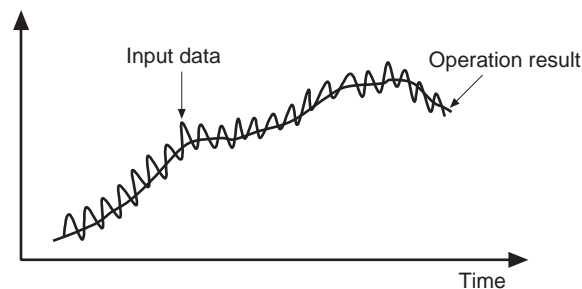

- This function is used to reduce changes in the input due to disturbances in the liquid surface when controlling liquid level.



Setting

Setting range	Unit	Default value
1, 2, 4, 8, 16, 32	Number of times	1



Reference

- Related Information
Movement Average in 5.1 Input Adjustment Functions (P. 5-5)
- Related Parameters
Movement Average * Enabled (Control Initial Setting 2 Level) (P. 8-70)

Extraction of Square Root * Low-cut Point **SP-P.*****L.Ad2**Extraction of Square Root *
Function is enabled

- These parameters are used to set the low-cut point of each input. Data resulting from the extraction of square root operations is shown below.
- This function is used for extraction of square root operations for liquid sensors.

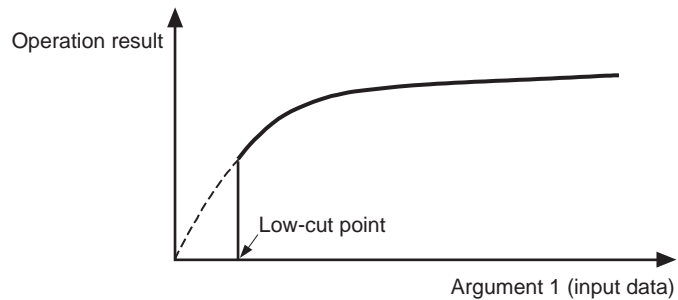
**Setting**

Setting range	Unit	Default value
0.000 to 9.999	–	0.000

**Reference**

- Related Information
Extraction of Square Root in 5.1 *Input Adjustment Functions* (P. 5-7)
- Related Parameters
Extraction of Square Root * Enabled (Control Initial Setting 2 Level) (P. 8-71)

Analog Parameter 1 (Control Rate) **AP. 1****L.Ad2**

Proportional control



This parameter sets the ratio used for proportional control.

**Setting**

Setting range	Unit	Default value
-1.999 to 9.999	–	1.000

**Reference**

- Related Information
Position-proportional Control in 4.6 *Selecting the Control Mode* (P. 4-18)
- Related Parameters
Control Mode (Control Initial Setting Level) (P. 8-58)

8.7 Alarm Set Setting Level (L.AL.n)

The Alarm Set Setting Level is used to make the alarm value settings for each alarm set. The Display Alarm Setting Level parameter, the first parameter displayed under Alarm Set Setting Level, is used to move to each alarm set.

● Level Changes at Startup Up To Adjustment Level

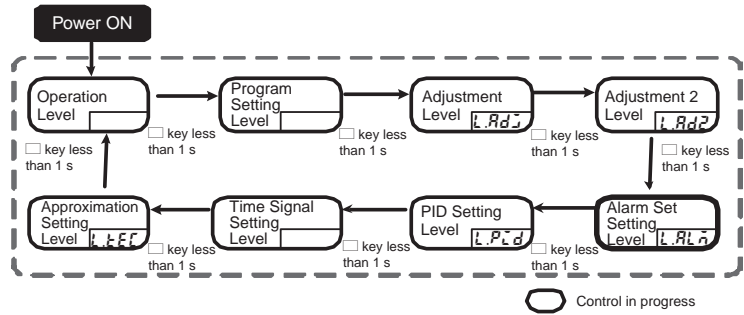

● Parameter Changes within Alarm Set Setting Level

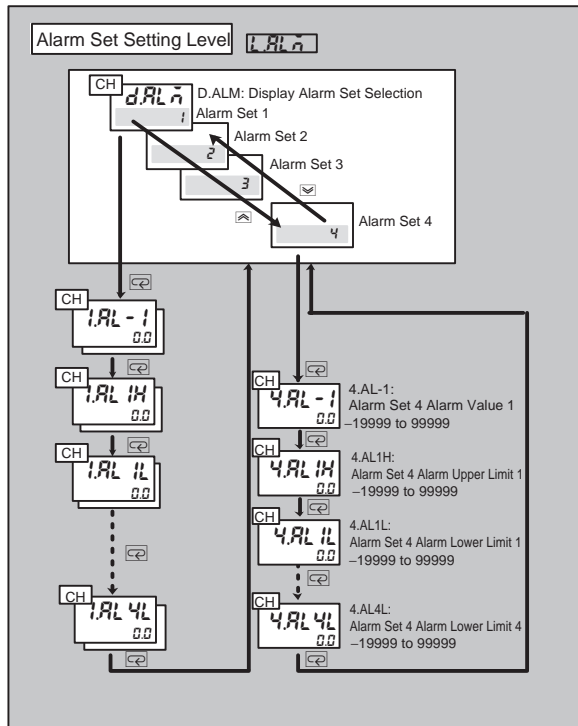

CH

Display Alarm Setting Level

d.AL \bar{n} L.AL \bar{n}

Alarm function enabled

The alarm set number for which display settings are to be made is selected using this parameter.



- The Display Alarm Setting Level parameter is used to select the alarm set number for which display settings are to be made.
- Up to 4 alarm sets, alarm set numbers 1 to 4, to which the alarm values and upper/lower alarm limits have been registered, can be used.



Setting

Setting range	Unit	Default value
1 to 4	–	(See note.)

Note:The selected and executed alarm set number.



Reference

- Related Parameters
Alarm Set Number (Program Setting Level) (P. 8-20)

CH

Alarm Set * Alarm Value 1

*AL - 1

L.AL \bar{n}

Alarm Set * Alarm Value 2

*AL - 2

Alarm Set * Alarm Value 3

*AL - 3

Alarm Set * Alarm Value 4

*AL - 4

(*: 1 to 4)

Alarm function enabled

The alarm values for alarms 1 to 4 can be registered for each alarm set.



- The Alarm Set 1 to 4 Alarm Value 1 to 4 parameters are used to set the alarm values.
- These parameters can be set when the Alarm Type parameter is set to a value other than “No alarm”, “Upper- and lower-limit alarm”, “Upper- and lower-limit of range alarm”, and “Upper- and lower-limit alarm with standby sequence”.



Setting

Setting range	Unit	Default value
–19999 to 99999	EU	0



Reference

- Related Parameters
Alarm * Type (Alarm Setting Level) (P. 8-75)
Alarm * Latch (Alarm Setting Level) (P. 8-76)
Alarm * Hysteresis (Alarm Setting Level) (P. 8-77)
Standby Sequence Reset (Alarm Setting Level) (P. 8-78)
Auxiliary Output * Open in Alarm (Alarm Setting Level) (P. 8-79)
Alarm SP Selection (Expansion Control Setting Level) (P. 8-97)

CH

Alarm Set * Alarm Upper Limit 1 **AL 1H*
 Alarm Set * Alarm Upper Limit 2 **AL 2H*
 Alarm Set * Alarm Upper Limit 3 **AL 3H*
 Alarm Set * Alarm Upper Limit 4 **AL 4H*
 Alarm Set * Alarm Lower Limit 1 **AL 1L*
 Alarm Set * Alarm Lower Limit 2 **AL 2L*
 Alarm Set * Alarm Lower Limit 3 **AL 3L*
 Alarm Set * Alarm Lower Limit 4 **AL 4L*

LALn

(*: 1 to 4)

Alarm Type parameter set to upper- and lower-limit of range alarm

These parameters are used to set the alarm upper limits and alarm lower limits for Alarm 1 Type to Alarm 4 Type (Alarm Setting Level) for which upper/lower limits have been selected.



- These parameters are used to set the upper and lower limits for alarms 1 to 4 in alarm sets 1 to 4.
- These parameters can be used when the Alarm Type parameter has been set to “Upper- and lower-limit alarm”, “Upper- and lower-limit of range alarm”, and “upper- and lower-limit alarm with standby sequence”.



Setting range	Unit	Default value
-19999 to 99999	EU	0



- Related Parameters
 - Alarm * Type (Alarm Setting Level) (P. 8-75)
 - Alarm * Latch (Alarm Setting Level) (P. 8-76)
 - Alarm * Hysteresis (Alarm Setting Level) (P. 8-77)
 - Standby Sequence Reset (Alarm Setting Level) (P. 8-78)
 - Auxiliary Output * Open in Alarm (Alarm Setting Level) (P. 8-79)
 - Alarm SP Selection (Expansion Control Setting Level) (P. 8-97)

8.8 PID Setting Level (L.P.L.d)

This level contains the parameters for the PID constants, MV limits, and alarm settings for each PID set. To move to a PID set, use the Display PID Set Number parameter at the beginning of PID Setting Level.

● Level Changes at Startup Up To PID Setting Level

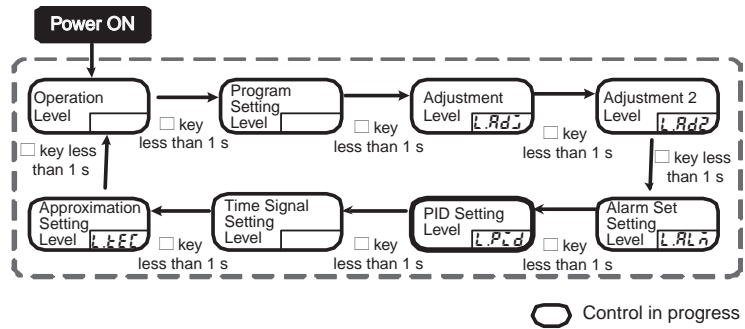

● Parameter Changes within PID Setting Level

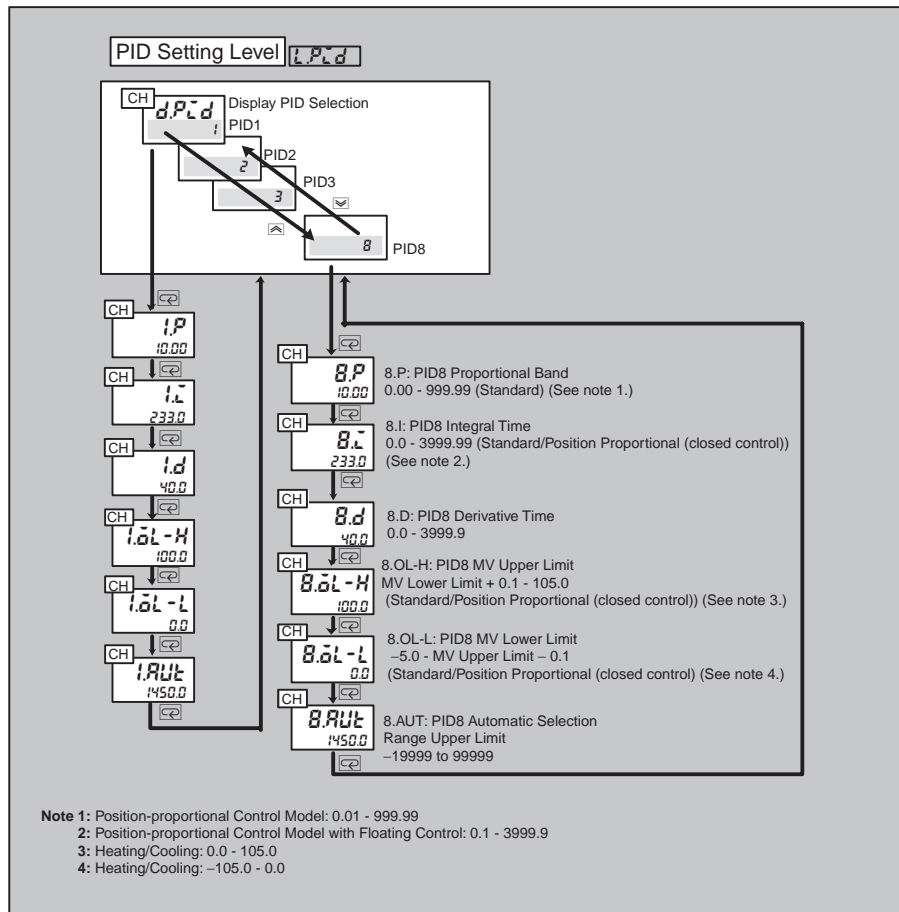

Parameters

CH

Display PID Selection

d.Pid

L.Pid



Use this parameter to select the PID set that you wish to display.

- Set the number of the PID set that you wish to display.
- Up to 8 PID sets (PID Sets 1 to 8) can be used. PID constants, MV upper and lower limits, and automatic selection range upper limits are stored in each PID set.

Parameter	Setting range	Unit	Default value
Display PID Selection	1 to 8	–	*

* Selected PID set.

- Related Parameters
PID Set Number (Program Setting Level) (P. 8-19)

CH

PID * Proportional Band

* .P

L.Pid

PID * Integral Time

* .I

PID * Derivative Time

* .d

(*: 1 to 8)

2-PID control



These parameters are used to store PID constants in each PID set. If AT is executed, the values are set automatically.

P action: Control action using an MV proportional to the deviation.

I action: Control action using an output that is proportional to the time integral of the deviation. The P action causes an offset, and thus it is used in combination with the I action. As time elapses, the offset disappears and the controlled temperature and SP equalize.

D action: Control action using an output that is proportional to the time derivative of the input. The P action and I action serve to correct the control result and thus respond slowly to sudden temperature changes. The D action corrects control by adding an MV that is proportional to the slope of the temperature change.

Parameter	Setting range	Unit	Default value
Proportional Band (P)	0.00 to 999.99	%FS	10.00
Integral Time (I)	0.0 to 3999.9	s	233.0
Derivative Time (D)	0.0 to 3999.9	s	40.0

- For ON/OFF control, set the proportional band to 0.0. The proportional band cannot be set to 0.0 on a Position-proportional Control Model.
- For P control or PD control, set the integral time to 0.0. The integral time cannot be set to 0.0 on a Position-proportional Control Model when performing floating control or when the Operation at Potentiometer Input Error parameter is set to "Continue."

- Related Parameters
AT Execute/Cancel (Adjustment Level) (P. 8-23)

CH

PID* MV Upper Limit

* $\Delta L - H$

L.P.L.d

PID* MV Lower Limit

* $\Delta L - L$

(*: 1 to 8)

2-PID control



- Use the MV Upper Limit and MV Lower Limit parameters to set upper and lower limits for the MV. When the Controller calculates an MV that is outside of the upper and lower limits, the upper or lower-limit is output.
- MV Upper Limit
The setting range differs for standard control and heating/cooling control. The cooling MV of heating/cooling control is expressed as a negative value.
- MV Lower Limit
The setting range differs for standard control and heating/cooling control. The cooling MV of heating/cooling control is expressed as a negative value.
- The MV limit function does not operate on a Position-proportional Control Model during floating control, and thus the setting is not effective.



Parameter	Setting range	Unit	Default value
MV Upper Limit	Standard control: MV lower limit + 0.1 to 105.0	%	100.0
	Heating/cooling control: 0.0 to 105.0	%	100.0
MV Lower Limit	Standard control: -5.0 to MV upper limit - 0.1	%	0.0
	Heating/cooling control: -105.0 to 0.0	%	-100.0

The following MVs take priority over the MV limits:

- Manual MV
- MV at Reset
- MV at PV error



- Related Information
MV Limits in 5.3 Output Adjustment Functions (P. 5-15)

CH

PID* Automatic Selection Range Upper Limit

* *Aut*

LPid

(*: 1 to 8)

When using automatic selection of PID sets, use these parameters to set an upper limit for each PID set.



- Set the automatic selection range upper limit for PID Sets 1 to 8.
- The limit for PID Set 8 is fixed at 110% of the sensor setting range, and thus does not need to be set.
- These upper limits are applied to the PV (present value), DV (deviation), or SP (present SP) set in the PID Set Automatic Selection Data parameter. The default setting is "PV."



Setting

Setting range	Unit	Default value
-19999 to 99999	EU	1450.0



Reference

- Related Information
PID Sets in 5.2 Control Functions (P. 5-10)
- Related Parameters
PID Set Automatic Selection Data (Expansion Control Setting Level) (P. 8-98)

8.9 Time Signal Setting Level ()

The Time Signal Setting Level is used to set time signals. This level is displayed if the Program Output Selection parameter in the Control Initial Setting 2 Level parameter is set to "Time Signal."

● Level Changes at Startup Up To Time Signal Setting Level

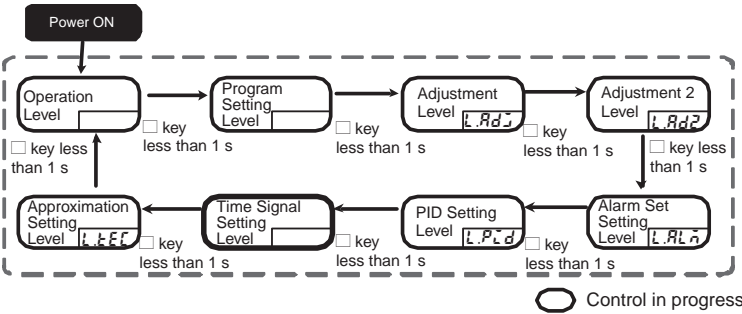

● Parameter Changes within Time Signal Setting Level

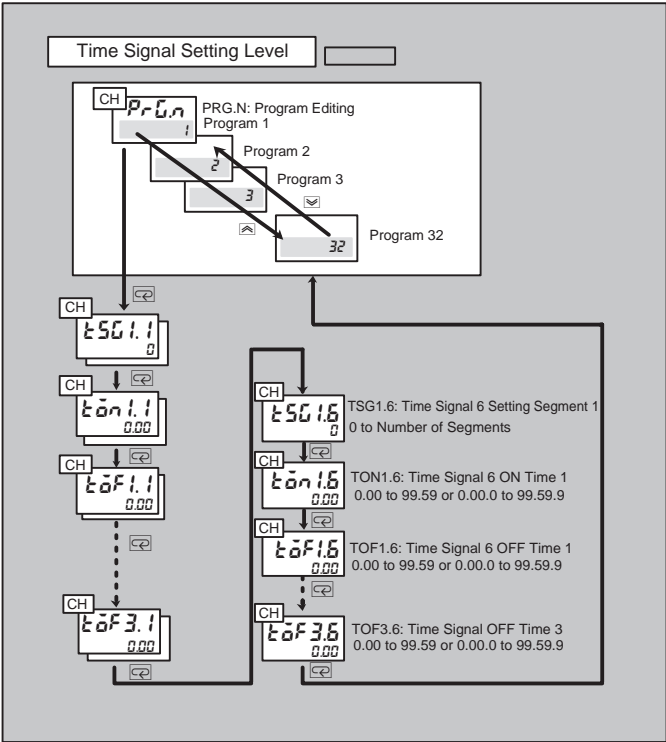

Parameters

CH

Program Editing

PRGn

CH1 or CH2 during independent operation with time signal enabled



- This parameter is used to set the program number of the program to be set.



Setting

Setting range	Unit	Default value
1 to 32	---	(See note.)

Note: The current program number.



Reference

- Related Parameters
 Auxiliary Output * Assignment (Control Initial Setting 2 Level) (P. 8-67)
 Program Output Selection (Control Initial Setting 2 Level) (P. 8-68)

CH

Time Signal * Set Segment 1

tSG1.*

Time Signal * Set Segment 2

tSG2.*

Time Signal * Set Segment 3

tSG3.*

(*: 1 to 6)

CH1 or CH2 (during independent control) with time signal enabled



- Time signals can be set for 6 outputs for each program, with 3 time signals for each output.
- This parameter is used to set the segments for which time signals are used. The default setting is 0 (disabled).



Setting

Setting range	Unit	Default value
0 to Number of Segments (0: Disabled)	---	0: Disabled



Reference

- Related Information
 Time Signal in 5.7 Program Operation Functions (P. 5-33)
- Related Parameters
 Auxiliary Output * Assignment (Control Initial Setting 2 Level) (P. 8-67)
 Program Output Selection (Control Initial Setting 2 Level) (P. 8-68)
 Time Signal * ON Time * (Time Signal Setting Level) (P. 8-45)
 Time Signal * OFF Time * (Time Signal Setting Level) (P. 8-45)

CH

Time Signal * ON Time 1	$t_{\text{on}}^*.1$	
Time Signal * ON Time 2	$t_{\text{on}}^*.1$	
Time Signal * ON Time 3	$t_{\text{on}}^*.1$	
(*: 1 to 6)		CH1 or CH2 (during independent control) with time signal enabled



- These parameters are used to set the ON time for time signals.
- Set the interval between the time signal ON and OFF times to 100 ms minimum. Unexpected operation may occur if the interval is set to less than 100 ms.



Setting range	Unit	Default value
0.00 to 99.59 or 0.00.0 to 99.59.9	Program time unit	0.00



- Related Information
Time Signal in 5.7 Program Operation Functions (P. 5-33)
- Related Parameters
Auxiliary Output * Assignment (Control Initial Setting 2 Level) (P. 8-67)
Program Output Selection (Control Initial Setting 2 Level) (P. 8-68)
Time Signal * Set Segment * (Time Signal Setting Level) (P. 8-44)
Time Signal * OFF Time * (Time Signal Setting Level) (P. 8-45)

CH

Time Signal * OFF Time 1	$t_{\text{of}}^*.1$	
Time Signal * OFF Time 2	$t_{\text{of}}^*.1$	
Time Signal * OFF Time 3	$t_{\text{of}}^*.1$	
(*: 1 to 6)		CH1 or CH2 (during independent control) with time signal enabled



- These parameters are used to set the OFF time for time signals.
- Set the interval between the time signal ON and OFF times to 100 ms minimum. Unexpected operation may occur if the interval is set to less than 100 ms.



Setting range	Unit	Default value
0.00 to 99.59 or 0.00.0 to 99.59.9	Program time unit	0.00



- Related Information
Time Signal in 5.7 Program Operation Functions (P. 5-33)
- Related Parameters
Auxiliary Output * Assignment (Control Initial Setting 2 Level) (P. 8-67)
Program Output Selection (Control Initial Setting 2 Level) (P. 8-68)
Time Signal * Set Segment * (Time Signal Setting Level) (P. 8-44)
Time Signal * OFF Time * (Time Signal Setting Level) (P. 8-45)

8.10 Approximation Setting Level (L.F.F.)

This level contains parameters for straight-line and broken-line approximation settings. These parameters only appear if enabled in Control Initial Setting 2 Level.

● Level Changes at Startup Up To Approximation Setting Level

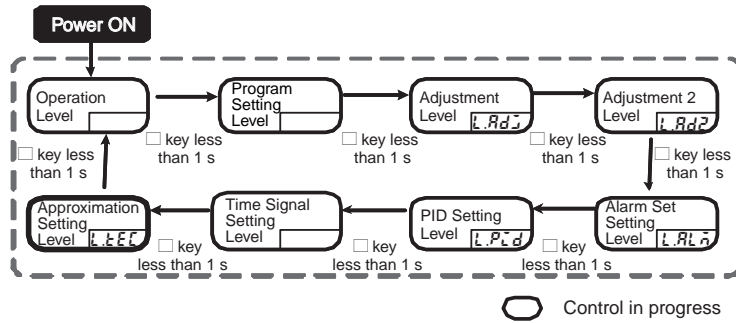

● Parameter Changes within Approximation Setting Level

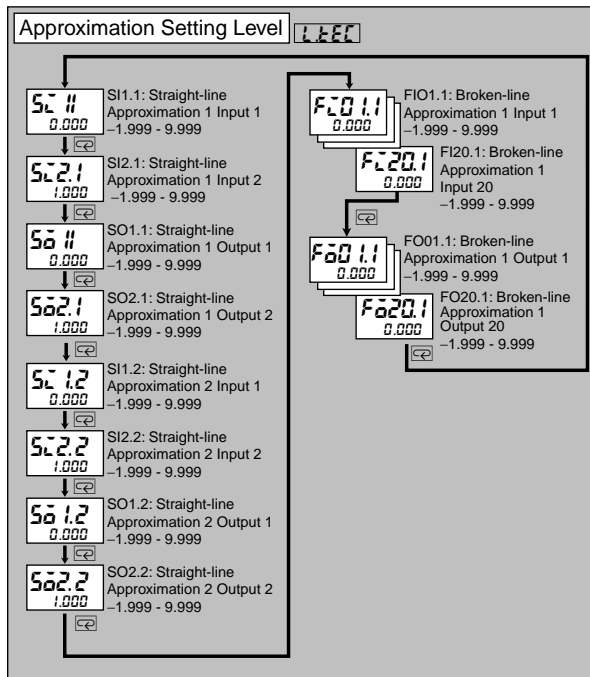

Straight-line Approximation * Input 1 501. *
 Straight-line Approximation * Input 2 502. *
 Straight-line Approximation * Output 1 501. *
 Straight-line Approximation * Output 2 502. *

L.L.E.C

(*: 1 or 2)

Straight-line approximation * is enabled



Use these parameters to configure straight-line approximation 1 and 2.

- Use these parameter to set the values for straight-line approximation. Specify two points: straight-line approximations 1 and 2. Use normalized data for the values.
- If Input 1 = Input 2, the setting will not be effective and will be regarded as straight-line approximation with input data = output data.

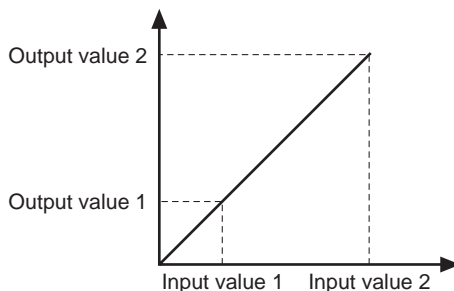

Parameter	Setting range	Unit	Default value
Straight-line Approximation * Input 1	-1.999 to 9.999	-	0.000
Straight-line Approximation * Input 2	-1.999 to 9.999	-	1.000
Straight-line Approximation * Output 1	-1.999 to 9.999	-	0.000
Straight-line Approximation * Output 2	-1.999 to 9.999	-	1.000



- Related Parameters
 Straight-line Approximation 1 Enabled, Straight-line Approximation 2 Enabled (Control Initial Setting 2 Level) (P. 8-71)

Broken-line Approximation 1 Input 1 to	$F_{\bar{C}01.1}$ to $F_{\bar{C}20.1}$	L.E.C
Broken-line Approximation 1 Input 20		
Broken-line Approximation 1 Output 1 to	$F_{\bar{a}01.1}$ to $F_{\bar{a}20.1}$	Broken-line Approximation 1 is enabled
Broken-line Approximation 1 Output 20		

Use these parameters to set values for broken-line approximation 1.



- Use these parameters to set the values for broken-line approximation. Up to 20 points can be specified for one broken line approximation. Use normalized data for the values.
- If Input $n \geq$ Input $n + 1$, the setting of point $n + 1$ will not be effective.

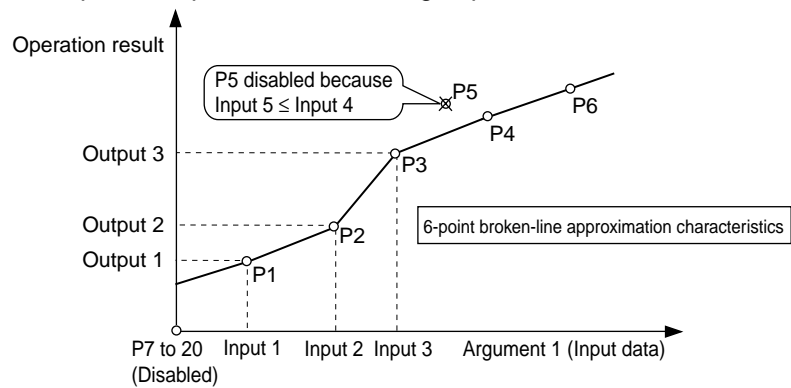

Parameter	Setting range	Unit	Default value
Broken-line Approximation * Input 1 to Broken-line Approximation * Input 20	-1.999 to 9.999	-	0.000
Broken-line Approximation * Output 1 to Broken-line Approximation * Output 20	-1.999 to 9.999	-	0.000



- Related Information
Broken-line Approximation in 5.1 *Input Adjustment Functions* (P. 5-6)
- Related Parameters
Broken-line Approximation 1 Enabled (Control Initial Setting 2 Level) (P. 8-72)

8.11 Input Initial Setting Level (L.0)

This level contains Initial setting parameters for inputs, including input types, temperature units, and scaling settings.

● Level Changes at Startup Up To Input Initial Setting Level

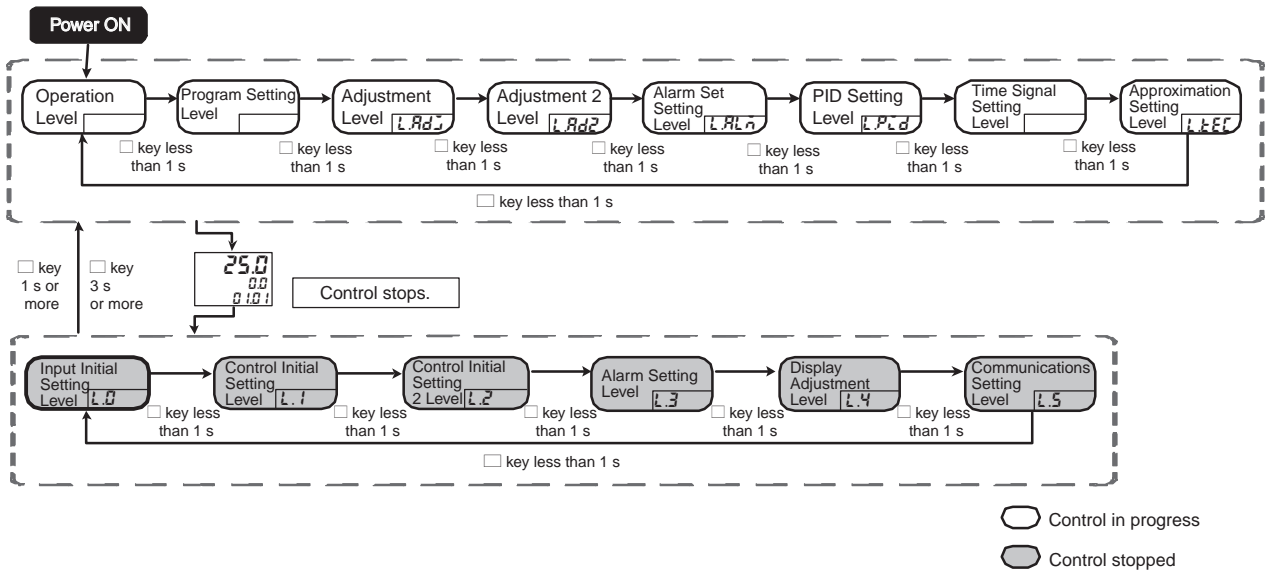

● Parameter Changes within Input Initial Setting Level

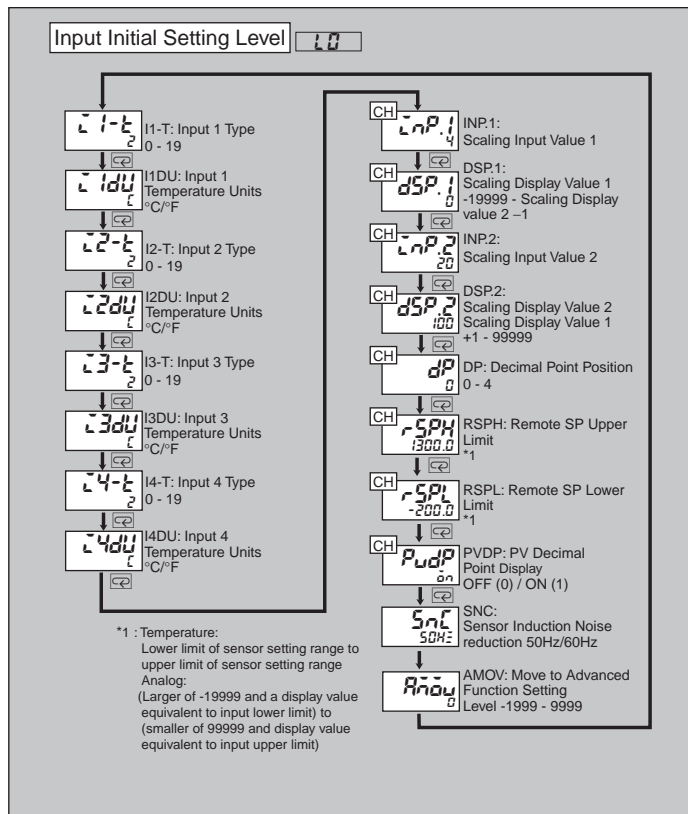

Input * Type
(*: 1 to 4)

□*□□

□□



- These parameters are used to set the sensor types.
- If these parameters are changed, the SP limit settings are returned to the Initial settings. Reset the SP Upper Limit and SP Lower Limit parameters as necessary.
- Refer to the following table to set the parameters. The default setting is shaded.

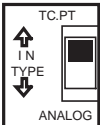
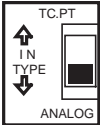

Set value	Input type	Setting range		Input type switch
		(°C)	(°F)	
0	Pt100(1)	-200.0 to 850.0	-300.0 to 1500.0	TC.PT 
1	Pt100(2)	-150.00 to 150.00	-199.99 to 300.00	
2	K(1)	-200.0 to 1300.0	-300.0 to 2300.0	
3	K(2)	-20.0 to 500.0	0.0 to 900.0	
4	J(1)	-100.0 to 850.0	-100.0 to 1500.0	
5	J(2)	-20.0 to 400.0	0.0 to 750.0	
6	T	-200.0 to 400.0	-300.0 to 700.0	
7	E	0.0 to 600.0	0.0 to 1100.0	
8	L	-100.0 to 850.0	-100.0 to 1500.0	
9	U	-200.0 to 400.0	-300.0 to 700.0	
10	N	-200.0 to 1300.0	-300.0 to 2300.0	
11	R	0.0 to 1700.0	0.0 to 3000.0	
12	S	0.0 to 1700.0	0.0 to 3000.0	
13	B	100.0 to 1800.0	300.0 to 3200.0	
14	W	0.0 to 2300.0	0.0 to 4100.0	
15	4 to 20 mA	Depends on scaling		ANALOG 
16	0 to 20 mA	One of the following ranges is displayed depending on the scaling:		
17	1 to 5V	-19999 to 99999		
18	0 to 5V	-1999.9 to 9999.9		
19	0 to 10V	-199.99 to 999.99		

Set the input type switch of each input to match the Input Type parameter of the corresponding input. The default setting is 2 (TC.PT).



- Related Parameters
 Input * Temperature Units (Input Initial Setting Level) (P. 8-51)
 SP Upper Limit and SP Lower Limit (Control Initial Setting Level) (P. 8-57)

Input * Temperature Unit

L*DU

L0

Temperature input



- Select Celsius (°C) or Fahrenheit (°F) for the temperature unit.



Setting

Setting range	Unit	Default value
C: °C F: °F	-	C: °C



Reference

- Related Parameters
Input * Type (Input Initial Setting Level) (P. 8-50)

CH

Scaling Input Value 1

LNP.1

L0

Scaling Display Value 1

DSP.1

Scaling Input Value 2

LNP.2

Scaling Display Value 2

DSP.2

Decimal Point Position

DP

Analog input



Function

- These parameters are used with an analog input.
- Scaling is carried out for the analog input. The display value for the input value specified in the Scaling Input Value 1 parameter is set in the Scaling Display Value 1 parameter, and the display value for input value set in the Scaling Input Value 2 parameter is set in the Scaling Display Value 2 parameter.
- The Decimal Point Position parameter is used to specify the decimal point position of the set values (SP, etc.) given in EU.
- Scaling settings for inputs 2 to 4 of a Controller with more than one inputs are set for channels 2 to 4. Press the **CH** Key to change to the desired analog input channel and then set the scaling.



Setting

Parameter	Setting range	Unit	Default value
Scaling Input Value 1	Input lower limit to input upper limit	*	4
Scaling Display Value 1	-19999 to Scaling upper limit - 1	EU	0
Scaling Input Value 2	Input lower limit to input upper limit	*	20
Scaling Display Value 2	Scaling lower limit + 1 to 99999	EU	100
Decimal Point Position	0 to 4	-	0

* The unit depend on the input type setting.

Important

The operation of E5AR-T/ER-T control functions and alarms is based on the input values. If a value greater than $rSP.2$ (Scaling Input Value 2) is set for $rSP.1$ (Scaling Input Value 1), operation will work in the opposite direction of the display values. The user must confirm compatibility with devices. For details, refer to 4.4 Setting the Input Type (P. 4-10).



- Related Parameters
Input * Type (Input Initial Setting Level) (P. 8-50)

Remote SP Upper Limit	$rSPH$	L.0
Remote SP Lower Limit	$rSPL$	Control with remote SP*



- This parameter sets the upper and lower limits for the remote SP. The remote SP upper limit is set with respect to the upper input range limit of input 2, and the remote SP lower limit is set with respect to the lower input range limit of input 2. For example, if input 2 is set to 4 to 20 mA, the remote SP upper limit is set with respect to 20 mA and the remote SP lower limit is set with respect to 4 mA.
- If the Input Type, Temperature Units, or scaling parameters for input 1 are changed, the upper and lower limit settings are changed to the upper and lower limits of the sensor.
- The decimal point position depends on the selected sensor. For an analog input, the decimal point position depends on the Decimal Point Position parameter.

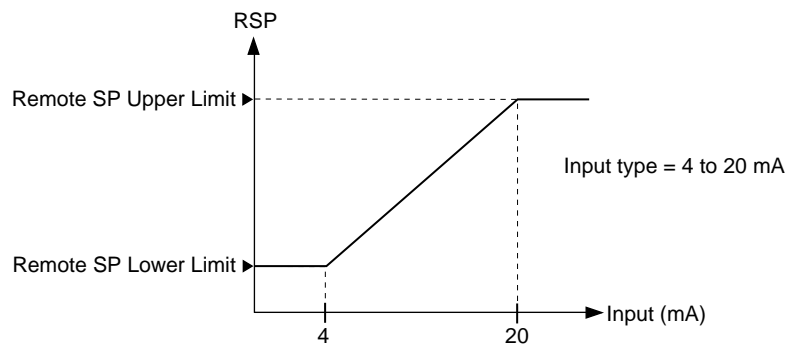

The SP limits are in effect, and therefore if the input remote SP is above or below the SP limits, the SP will be clamped to the upper or lower limit.

* During cascade control, only channel 2 is displayed.



Setting

Parameter	Setting range	Unit	Default value
Remote SP Upper Limit	Temperature: Lower limit of sensor setting range to upper limit of sensor setting range	EU	1300.0
Remote SP Lower Limit	Analog: (Larger of -19999 and display value equivalent to lower input limit) to (smaller of 99999 and display value equivalent to upper input limit)	EU	-200.0

* According to setting of the Input Type parameter.



Reference

● Related Parameters

Input * Type (Input Initial Setting Level) (P. 8-50)

Input * Temperature Units (Input Initial Setting Level) (P. 8-51)

Control Mode (Control Initial Setting Level) (P. 8-58)

SP Upper Limit and SP Lower Limit (Control Initial Setting Level) (P. 8-57)

Note:When the remote SP input is set to a temperature input, be sure to set the input type of the main input to the same setting as the input type of remote SP input.

If the remote SP input is set to a temperature input and the upper and lower limits of the remote SP are not the same as the upper and lower limits of the sensor setting range of the input type of remote SP input, it will not be possible to obtain a correct remote SP value.

CH

PV Decimal Point Display

P_{ud}P

L.0

Temperature input

This parameter can be used to not show the digits of the PV below the decimal point.



Function

- If this parameter is turned OFF, the digits of the PV below the decimal point are not shown. When turned ON, the digits below the decimal point are shown according to the input type setting.



Setting

Setting range	Unit	Default value
ōFF : OFF ōn : ON	-	ōn : ON



Reference

● Related Information

Input * type (Input Initial Setting Level) (P. 8-50)

Sensor Induction Noise Reduction

5nE

LO

This parameter can be set to reduce induction noise from the power source in the input.



- This parameter reduce induction noise in the input according to the frequency of the power source.
- Select 50 Hz or 60 Hz according to the power source used for the Controller.



Setting range	Unit	Default value
50Hz: 50 Hz 60Hz: 60 Hz	-	50Hz: 50 Hz



- Related Information
Input * type (Input Initial Setting Level) (P. 8-50)

Move to Advanced Function Setting Level

Αἰῶν

LO

“Initial Setting Protection” is set to 0.

This function is used to move to the Advanced Function Setting Level.



- Enter a password to move to the Advanced Function Setting Level.
- The password is set to “-169.” After entering “-169,” press the  Key or wait for two seconds and you will move to Advanced Function Setting Level.



Setting range	Unit	Default value
-1999 to 9999	-	0



- Related Parameters
Initial Setting Protection (Protect Level) (P. 8-4)

8.12 Control Initial Setting Level (L. I)

This level contains Initial setting parameters for control, such as the control method, as well as the output types, SP limits, control mode, direct/reverse operation, and closed/floating settings.

● Level Changes at Startup Up To Control Initial Setting Level

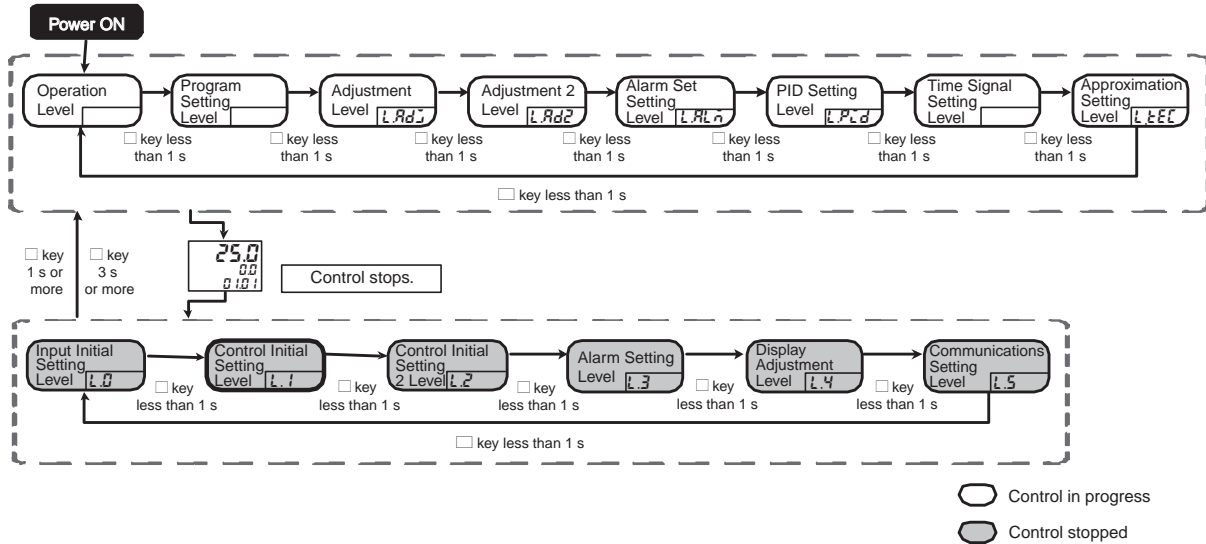

○ Control in progress
 ● Control stopped

● Parameter Changes within Initial Control Setting Level

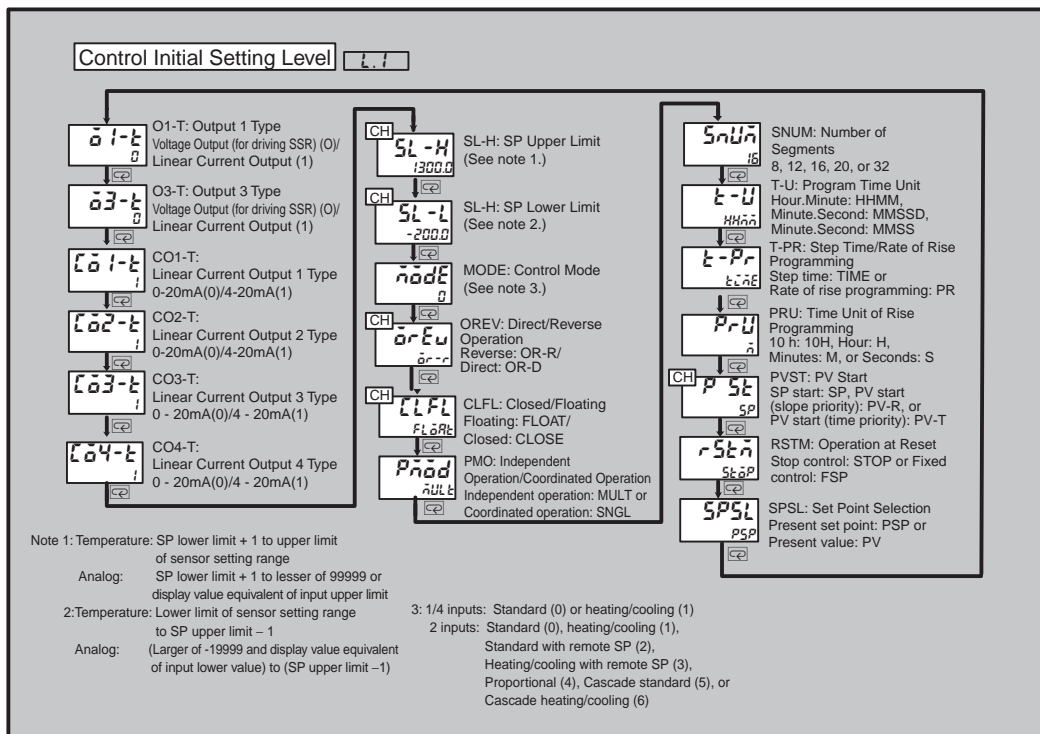

Parameters

Output 1 Type	$\bar{0}1-t$	L.1
Output 3 Type	$\bar{0}3-t$	Model with multi-output

Use these parameters to select the output types for multi-outputs.



- Select a voltage output (for driving SSR) or linear current output.
- When voltage output (for driving SSR) is selected, the output is 12 VDC, 21 mA for the E5AR-TQQ□□WW-□□□ and 12 VDC, 40 mA for all other models.
- When linear current output is selected, use the Linear Current Output Type parameter to select an output of 0 to 20 mA or 4 to 20 mA.



Setting range	Unit	Default value
0: Voltage output (for driving SSR) 1: Linear current output	-	0



- Related Parameters
Linear Current Output * Type (Control Initial Setting Level) (P. 8-56)
Control/Transfer Output * Assignment (Control Initial Setting 2 Level) (P. 8-64)

Linear Current Output * Type (*: 1 to 4)	$\bar{0}^*-t$	L.1
		Current output



Use these parameters to select the linear current output types.

- Select a 0 to 20 mA output or a 4 to 20 mA output.



Setting range	Unit	Default value
0: 0 to 20 mA 1: 4 to 20 mA	-	1



- Related Parameters
Control/Transfer Output * Assignment (Control Initial Setting 2 Level) (P. 8-64)

CH

SP Upper Limit

SL-H

L.I

SP Lower Limit

SL-L



- Use these parameters to set upper and lower limits for the SP setting. The SP can be set only between these limits. If the limits are changed and a previously set SP falls outside of the limits due to the change, the SP will automatically change to the upper or lower limit.
- If the input type and temperature unit are changed, the SP upper and lower limits will change to the upper and lower limits of the sensor.
- The decimal point position depends on the selected sensor. For analog input, the decimal point position is determined by the Decimal Point Position parameter.



Parameter	Setting range	Unit	Default value
SP Upper Limit	Temperature: SP lower limit + 1 to upper limit of input range Analog: (SP lower limit + 1) to (smaller of 99999 and display value equivalent to input upper limit)	EU	1300.0
SP Lower Limit	Temperature: Lower limit of input range to SP upper limit - 1 Analog: (Larger of -19999 and display value equivalent to input lower limit) to SP upper limit - 1	EU	-200.0



- Related Parameters
 - Input * Type (Input Initial Setting Level) (P. 8-50)
 - Input * Temperature Units (Input Initial Setting Level) (P. 8-51)

Control Mode

nōdē

L.1



Function

Use this parameter to select the control mode.

- On single-input or 4-input Controller Models, select standard control or heating/cooling control.
- On two-input Controller Models, select standard control, heating/cooling control, standard control with remote SP, heating/cooling control with remote SP, proportional control, cascade standard control, or cascade heating/cooling control.



Setting

Setting range	Unit	Default value
0: Standard	-	0
1: Heating/cooling		
2: Remote SP standard		
3: Remote SP heating/cooling		
4: Proportional		
5: Cascade standard		
6: Cascade heating/cooling		

The setting range is 0 or 1 on a single- or 4-input Controller Model and 0 to 6 on a 2-input Controller Model.



Reference

- Related Information
4.6 Selecting the Control Mode (P. 4-15)
- Related Parameters
Control/Transfer Output * Assignment (Control Initial Setting 2 Level) (P. 8-64)

CH

Direct/Reverse Operation

ōrēu

L.1



Function

- When direct operation is selected, the MV is increased when the PV increases. When reverse operation is selected, the MV is increased when the PV decreases.



Setting

Setting range	Unit	Default value
<i>ōr-r</i> : Reverse operation	-	<i>ōr-r</i> : Reverse operation
<i>ōr-d</i> : Direct operation		



Reference

- Related Information
Direct Operation (Cooling)/Reverse Operation (Heating) in *4.7 Setting Output Parameters* (P. 4-20)

CH

Closed/Floating

CLFL

L.1

Position-proportional Control Model



- Use this parameter to select the control method for a Position-proportional Control Model.

Setting range	Unit	Default value
FLōPŁ: Floating CLōSE: Closed	-	FLōPŁ: Floating

Independent Operation/
Coordinated Operation

Pñōd

L.1

CH2 standard control or
CH2 heating/cooling control



- This parameter can be used to select independent or coordinated operation for models with two input channels.
- If coordinated operation is selected, coordinated operation based on channel 1 is enabled. The program will be the same for channels 1 and 2.
- Only coordinated operation based on channel 1 is supported for models with four inputs. Even when heating/cooling control is set for the control mode of channel 2, you will not be able to select independent operation.

Setting range	Unit	Default value
ñŃŁŁ Ł: Independent operation SŃŃŁ Ł: Coordinated operation	-	ñŃŁŁ Ł: Independent operation



- Related Information
Operating Programs Using Multiple Channels in *5.2 Control Functions* (P. 5-11)
- Related Parameters
Set Point Offset (Adjustment Level) (P. 8-32)
Set Point Selection (Control Initial Setting Level) (P. 8-62)

Number of Segments $\Sigma n \bar{U} \bar{n}$ L.1



- This parameter is used to set the maximum number of segments that can be set in a program. The default value is 16.



Setting range	Unit	Default value
8, 12, 16, 20, or 32	–	16

Program Time Unit $t-U$ L.1



- This parameter is used to specify the time unit for the program.
- The Program Time Unit parameter specifies the time unit for the following parameters. The Program Time Unit parameter must be set before the following parameters can be set.
 - Segment Time
 - Time Signal ON Time and Time Signal OFF Time parameters



Setting range	Unit	Default value
$HH\bar{m}\bar{n}$: Hours, minutes	–	$HH\bar{m}\bar{n}$: hours, minutes
$mmSS$: Minutes, seconds		
$mmSSd$: Minutes, seconds, deciseconds		

Step Time/Rate of Rise Programming $t-Pr$ L.1



- This parameter is used to specify the programming method.



Setting range	Unit	Default value
$t\bar{L}\bar{n}\bar{E}$: Step Time Pr : Rate of Rise Programming	–	$t\bar{L}\bar{n}\bar{E}$: Step Time



- Related Information
Rate of Rise Programming in *5.7 Program Operation Functions* (P. 5-28)

Time Unit of Ramp Rate

PrU

L. 1

Rate of Rise Programming



Function

- This parameter is used to set the time unit for the ramp rate when rate of rise programming is used.



Setting

Setting range	Unit	Default value
10H : 10 hours H : Hours M : Minutes S : Seconds	–	M : Minutes



Reference

- Related Information
Rate of Rise Programming in 5.7 Program Operation Functions (P. 5-28)
- Related Parameters
Segment Rate of Rise (Program Setting Level) (P. 8-18)
Step Time/Rate of Rise Programming (Control Initial Setting Level) (P. 8-60)

CH

PV Start

PvSt

L. 1



Function

- This parameter is used to set the method for starting the program.
- The following table outlines the start SP and the start point for each method.

Start method	SP at start of operation	Operation start point
SP Start	Segment SP for segment 1	Program operates in order from SP of segment 1.
PV Start (slope priority)	PV at start of operation	Operation starts at the first present SP that matches the PV at the start of operation.
PV Start (time priority)	PV at start of operation	Operation starts with the PV at the start of program operation used as the SP. The operation start point is the beginning of segment 1.



Setting

Setting range	Unit	Default value
SP : SP Start Pv-r : PV Start (slope priority) Pv-t : PV Start (time priority) (See note.)	–	SP : SP Start

Note:This selection is not possible for rate of rise programming.



Reference

- Related Information
Operation at Program Start in 5.7 Program Operation Functions (P. 5-37)

Operation at Reset

rStā

L.1



Function

- This parameter is used to set the operation at reset.



Setting

Setting range	Unit	Default value
StāP: Stop control	-	StāP: Stop control
FSP: Fixed control		

Important

If the Operation at Reset parameter is set to “Fixed Control,” control during reset is executed using the value set for the Fixed SP parameter. Control does not stop.

Set Point Selection

SPSL

L.1

Coordinated operation



Function

- This parameter is used to select whether coordinated operation is executed using the channel 1 present SP or the PV.



Setting

Setting range	Unit	Default value
PSP: Present set point	-	PSP: Present set point
PV: Present value		



Reference

- Related Information
Operating Programs Using Multiple Channels in *5.2 Control Functions* (P. 5-11)
- Related Parameters
Set Point Offset (Adjustment Level) (P. 8-32)
Independent Operation/Coordinated Operation (Control Initial Setting Level) (P. 8-59)

8.13 Control Initial Setting 2 Level (L.2)

This level contains Initial setting parameters for processing functions, including control/transfer output assignments, event input assignments, auxiliary output assignments, and first order lag operation enable/disable settings.

● Level Changes at Startup Up To Control Initial Setting 2 Level

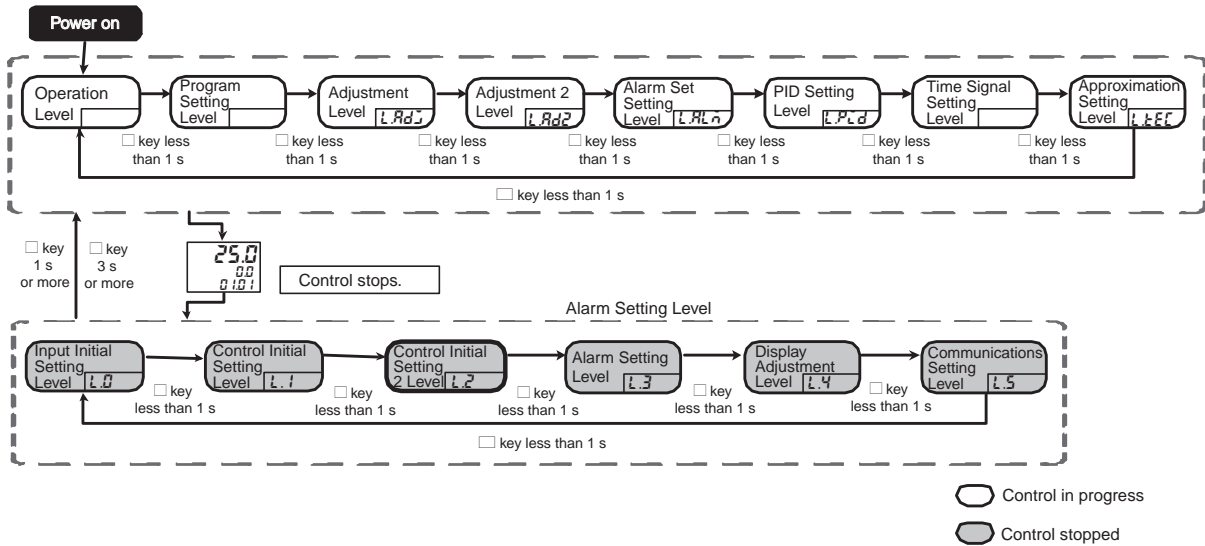

● Parameter Changes within Control Initial Setting Level

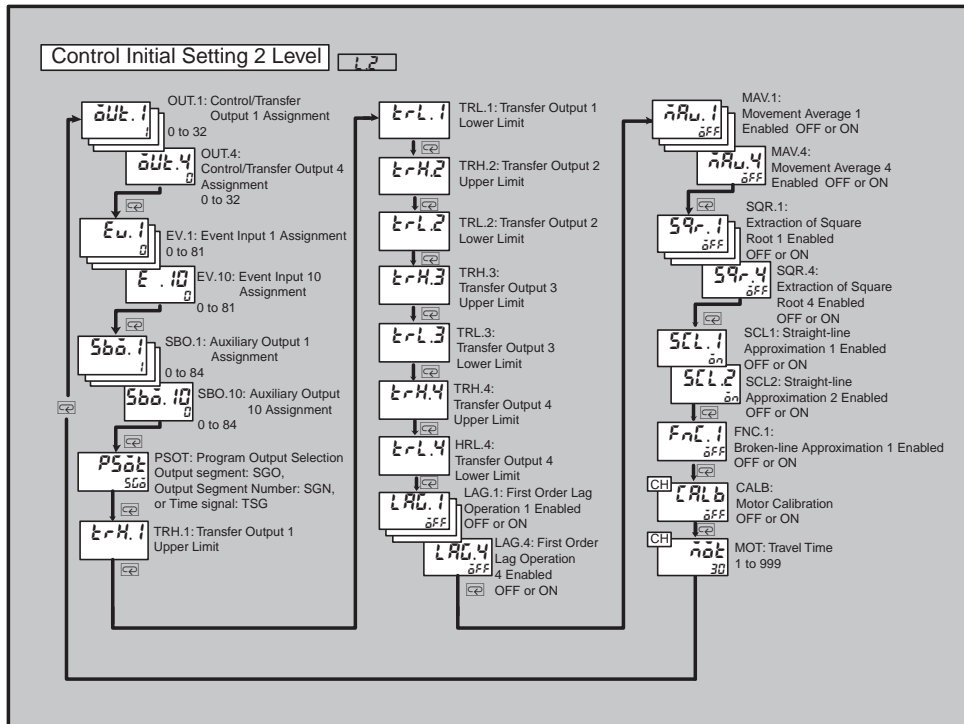

Parameters

Control/Transfer Output * Assignment **OUT.***

1.2

(*: 1 to 4)



- Use this parameter to assign output content to outputs.

Setting range	Unit	Default value
Disable (0) CH1 control output (heating or open) for control output (1) CH1 control output (cooling or close) for control output (2) CH1 disable (3) CH1 present set point (4) CH1 PV (5) CH1 control output (heating or open) for transfer output (6) CH1 control output (cooling or close) for transfer output (7) CH1 valve opening (8) CH2 control output (heating) for control output (9) CH2 control output (cooling) for control output (10) Disable (11) CH2 present set point (12) CH2 PV (13) CH2 control output (heating) for transfer output (14) CH2 control output (cooling) for transfer output (15) Disable (16) Similarly, CH3 (17 to 24) CH4 (25 to 32)	—	*

* The default value is set according to the control mode setting.

Control mode	Input type	Control/Transfer Output 1 Assignment	Control/Transfer Output 2 Assignment	Control/Transfer Output 3 Assignment	Control/Transfer Output 4 Assignment
Standard Control	1 input	1	0	0	0
	2 inputs	1	9	0	0
	4 inputs	1	9	17	25
Heating/Cooling Control	1 input	1	2	0	0
	2 inputs	1	2	9	10
	4 inputs	1	2	9	10
Remote SP Standard Control	1 input	—	—	—	—
	2 inputs	1	0	0	0
	4 inputs	—	—	—	—
Remote SP Heating/cooling Control	1 input	—	—	—	—
	2 inputs	1	2	0	0
	4 inputs	—	—	—	—
Proportional Control	1 input	—	—	—	—
	2 inputs	1	0	0	0
	4 inputs	—	—	—	—
Cascade Standard Control	1 input	—	—	—	—
	2 inputs	9	0	0	0
	4 inputs	—	—	—	—
Cascade Heating/Cooling Control	1 input	—	—	—	—
	2 inputs	9	10	0	0
	4 inputs	—	—	—	—
Position-proportional Control	1 input	—	—	0	0

If a pulse output is set to operate as a transfer output (3 to 8 for channel 1), the output will be OFF.



- Related Parameters

Linear Current Output * Type (Control Initial Setting Level) (P. 8-56)

Output 1 Type and Output 3 Type (Control Initial Setting Level) (P. 8-56)

Event Input * Assignment
 (*: 1 to 10)

Eu.*

1.2



- Use these parameters to assign event input functions.



Setting range	Unit	Default value
Disable (0)		
Communications Writing OFF/ON (1)		
Channel 1 Program No. (bit 0, weight 1) (2)		
Channel 1 Program No. (bit 1, weight 2) (3)		
Channel 1 Program No. (bit 2, weight 4) (4)		
Channel 1 Program No. (bit 3, weight 8) (5)		
Channel 1 Program No. (bit 4, weight 16) (6)		
Channel 1 Program No. (bit 5, weight 32) (7)		
Channel 1 Program No. (bit 0, weight 10) (8)		
Channel 1 Program No. (bit 2, weight 20) (9)		
Channel 1 Run (ON)/Reset (OFF) (10)		
Channel 1 Run (OFF)/Reset (ON) (11)		
Channel 1 Auto (OFF/Manual (ON) (12)		
Channel 1 Program SP (OFF)/Remote SP (ON) (13)	-	0
Channel 1 Remote SP (OFF)/Fixed SP (ON) (14)		
Channel 1 Program SP (OFF)/Fixed SP (ON) (15)		
Channel 1 Program SP (16)		
Channel 1 Remote SP (17)		
Channel 1 Fixed SP (18)		
Channel 1 Hold (ON)/Hold clear (OFF) (19)		
Channel 1 Advance (20)		
Channel 1 Back (21)		
Similarly		
Channel 2 (22 to 41)		
Channel 3 (42 to 61)		
Channel 4 (62 to 81)		

- If the same setting is selected for different Event Input Assignment parameters, the event input for which ON/OFF is determined last will be effective. When the power is turned ON and the same program number assignment is repeated, the event input with the higher number is given priority.

Important

When the control mode is set to cascade control, assign the following channel operation commands:

- CH2 Run/Reset (31)
- CH2 Auto/Manual (32)
- CH2 SP Mode (Remote SP/Fixed SP) (34)
(cascade open/close)



- Related Information
 5.8 Using Event Inputs (P. 5-39)

Auxiliary Output * Assignment

560.*

L2

(*: 1 to 10)



- Use these parameters to assign output content to auxiliary outputs.



Setting range	Unit	Default value
Disable (0)		
CH1 Alarm 1 (1)		
CH1 Alarm 2 (2)		
CH1 Alarm 3 (3)		
CH1 Alarm 4 (4)		
CH1 Input error (5)		
CH1RSP Input error (6)		
Disabled (7)		
CH1 Run output (8)		
CH1 Program end output (9)		
CH1 Program output 1 (10)*1		
CH1 Program output 2 (11)*1		
CH1 Program output 3 (12)*1		
CH1 Program output 4 (13)*1		
CH1 Program output 5 (14)*1		
CH1 Program output 6 (15)*1		
CH1 Program output 7 (16)*1		
CH1 Program output 8 (17)*1		
CH1 Program output 9 (18)*1		
CH1 Program output 10 (19)*1		
U-ALM (20)*1		
Alarm 1 OR output of all channels (21)		
Alarm 2 OR output of all channels (22)		
Alarm 3 OR output of all channels (23)		
Alarm 4 OR output of all channels (24)		
Input error OR output of all channels (25)	—	0 to 4
RSP Input error OR output of all channels (26)		
Disable (27)		
CH2 Alarm 1 (28)		
CH2 Alarm 2 (29)		
CH2 Alarm 3 (30)		
CH2 Alarm 4 (31)		
CH2 Input error (32)		
CH2 RSP Input error (33)		
Disable (34)		
CH2 Run output (35)		
CH3 Program end output (36)		
CH2 Program output 1 (37)*1		
CH2 Program output 2 (38)*1		
CH2 Program output 3 (39)*1		
CH2 Program output 4 (40)*1		
CH2 Program output 5 (41)*1		
CH2 Program output 6 (42)*1		
CH2 Program output 7 (43)*1		
CH2 Program output 8 (44)*1		
CH2 Program output 9 (45)*1		
CH2 Program output 10 (46)*1		
Similarly,		
CH3 (47 to 65)		
CH4 (66 to 84)		

*1 The data that is output depends on the setting of the Program Output Selection parameter and will be program output 1 to 10, segment output 1 to 10, segment number output 1 to 6, or time signal output 1 to 6.

*2 On a Controller with more than one input, assignment data can be set for channels 2 and higher for the number of supported channels. U-ALM output will be OR output of alarm functions 1 to 4 of all channels.



- Related Information
4.11 Using Auxiliary Outputs (P. 4-37)

- Related Parameters
Program Output Selection (Control Initial Setting 2 Level)

Program Output Selection

PSōt

1.2

“Program Output” assigned to Auxiliary Output



- This parameter is used to set what is output when “Program Output” is selected for the Auxiliary Output Assignment parameter.



Setting range	Unit	Default value
<i>50ō</i> : Segment Output		<i>50ō</i> : Segment Output
<i>50n</i> : Segment No. Output	–	
<i>t50</i> : Time Signal		



- Related Information
Time Signal in 5.7 Program Operation Functions (P. 5-33)
Segment Output in 5.7 Program Operation Functions (P. 5-34)
Program Status Outputs in 5.7 Program Operation Functions (P. 5-36)

- Related Parameters
Auxiliary Output * Assignment (Control Initial Setting 2 Level) (P. 8-67)

Transfer Output * Upper Limit *trH* *

L2

Transfer Output * Lower Limit *trL* *

(*: 1 to 4)

Transfer output using output assignment



- These parameters can only be used for outputs selected for transfer output using the output assignment parameters.



Control/ Transfer output assignment data	Setting range	Default value (upper limit/ lower limit of transfer output) *	Decimal point position	units
Present set point	SP lower limit to SP upper limit	1300.0 and -200.0	Depends on input type	EU
PV	Lower limit of sensor setting range to upper limit of sensor setting range (temperature)	Upper and lower limit of sensor setting range	Depends on input type	EU
	-19999 to 99999 (analog)	Scaling display value 2 and 1	Depends on input type	EU
Control output (heating or open)	Standard: -5.0 to 105.0; Heating/ cooling: 0.0 to 105.0	100.0 and 0.0	1	%
Control output (cooling or close)	0.0 to 105.0	100.0 and 0.0	1	%
Valve opening	-10.0 to 110.0	100.0 and 0.0	1	%

- * The parameters will be initialized if the input type, temperature units, scaling display value, SP upper and lower limits, or applicable control/transfer output assignment is changed.



- Related Information
5.9 Using a Transfer Output (P. 5-47)
- Related Parameters
Input * Type (Input Initial Setting Level) (P. 8-50)
Control/Transfer Output * Assignment (Control Initial Setting 2 Level) (P. 8-64)

First Order Lag Operation * Enabled **LAG.***

1.2

(*: 1 to 4)



- Use these parameters to enable or disable first order lag operation for each input.



Setting

Setting range	Unit	Default value
$\bar{\alpha}FF$: Disable	–	$\bar{\alpha}FF$: Disable
$\bar{\alpha}n$: Enable		



Reference

- Related Information
5.1 Input Adjustment Functions (P. 5-2)
- Related Parameters
First Order Lag Operation * Time Constant (Adjustment 2 Level) (P. 8-34)

Movement Average * Enabled **MA.***

1.2

(*: 1 to 4)



- Use these parameters to enable or disable the movement average for each input.



Setting

Setting range	Unit	Default value
$\bar{\alpha}FF$: Disable	–	$\bar{\alpha}FF$: Disable
$\bar{\alpha}n$: Enable		



Reference

- Related Parameters
Move Average * Move Average Count (Adjustment 2 Level) (P. 8-34)

Extraction of Square Root * Enabled

59r.*

L2

(*: 1 to 4)



- Use these parameters to enable or disable the extraction of square root operation for each input.



Setting

Setting range	Unit	Default value
$\bar{a}FF$: Disable $\bar{a}n$: Enable	–	$\bar{a}FF$: Disable



Reference

- Related Parameters
Extraction of Square Root * Low-cut Point (Adjustment 2 Level) (P. 8-35)

Straight-line Approximation * Enabled

5CL.*

L2

(*: 1 or 2)

Proportional control



- Use these parameters to enable or disable straight-line approximation.



Setting

Setting range	Unit	Default value
$\bar{a}FF$: Disable $\bar{a}n$: Enable	–	$\bar{a}n$: Enable



Reference

- Related Parameters
Straight-line Approximation * Input 1, Straight-line Approximation * Input 2, Straight-line Approximation * Output 1, and Straight-line Approximation * Output 2 (Approximation Setting Level) (P. 8-47)

Broken-line Approximation 1 Enabled *Fnc. 1*

L2



- Use this parameter to enable or disable broken-line approximation for input 1.



Setting range	Unit	Default value
$\bar{a}FF$: Disable	-	$\bar{a}FF$: Disable
$\bar{a}n$: Enable		



- Related Parameters
Broken-line Approximation 1 Input 1 to Broken-line Approximation 1 Input 20, Broken-line Approximation 1 Output 1 to Broken-line Approximation 1 Output 20 (Approximation Setting Level) (P. 8-48)

CH

Motor Calibration

CALb

L2

Position-proportional Control Model



- Use this parameter to execute motor calibration. If you are going to monitor the valve opening, be sure to execute this parameter. (During execution the display cannot be changed.)
- Executing this parameter also resets the Travel Time parameter.



Operation

- When this parameter is accessed, the set value is $\bar{a}FF$.
- Select $\bar{a}n$ to execute motor calibration.
- When motor calibration ends, the setting automatically reverts to $\bar{a}FF$.



- Related Parameters
Travel Time (Control Initial Setting 2 Level) (P. 8-73)

CH

Travel Time

移動時間

L2

Position-proportional Control Model



Function

- Set the time from when the valve is completely open to when the valve is completely closed.
- This parameter is automatically set when the Motor Calibration parameter is executed.



Setting

Setting range	Unit	Default value
1 to 999	s	30



Reference

- Related Parameters
Motor Calibration (Control Initial Setting 2 Level) (P. 8-72)

8.14 Alarm Setting Level (L.3)

This level contains parameters for the type and output operation of alarms, including alarm types, close in alarm/open in alarm settings, and latch settings.

● Level Changes at Startup Up To Alarm Setting Level

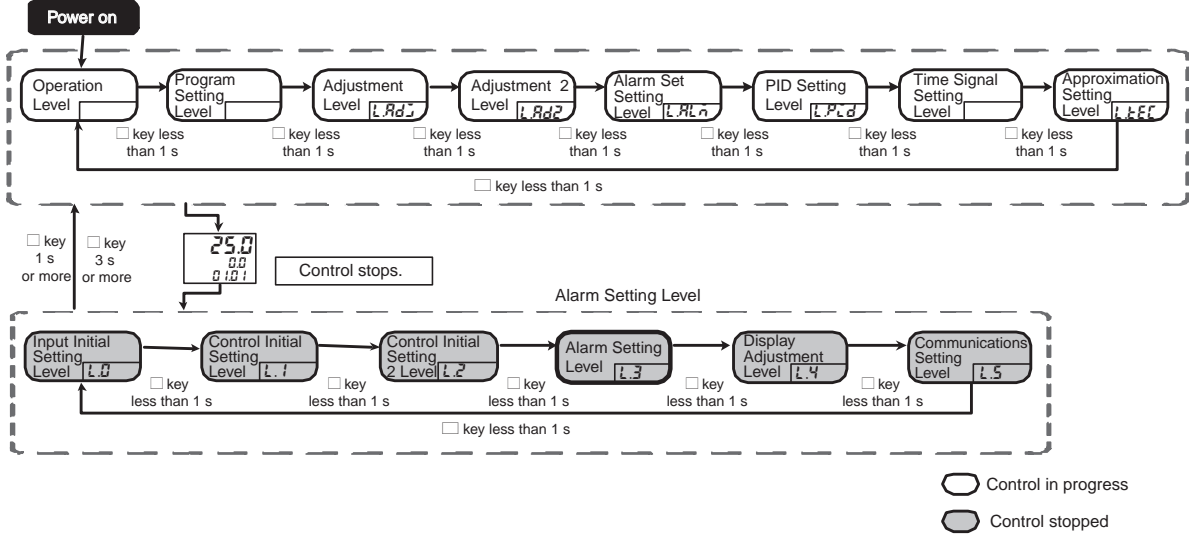

● Parameter Changes within Alarm Setting Level

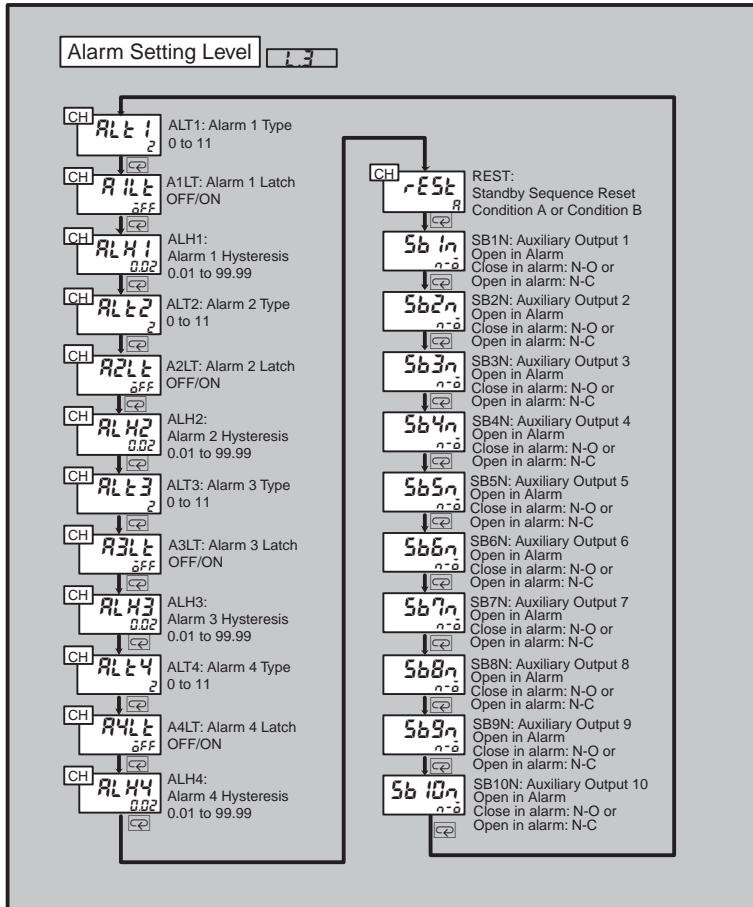

Alarm * Type

AL_L*

L.3

(*: 1 to 4)

Alarm set for Auxiliary Output
Assignment parameter

- These parameters are used to select the alarm types for alarms 1 through 4.



Setting range	Unit	Default value
0: No alarm function		
1: Upper- and lower-limit alarm		
2: Upper limit alarm		
3: Lower limit alarm		
4: Upper- and lower-limit range alarm		
5: Upper- and lower-limit alarm with standby sequence		
6: Upper limit alarm with standby sequence	–	2: Upper limit alarm
7: Lower limit alarm with standby sequence		
8: Absolute-value upper-limit alarm		
9: Absolute-value lower-limit alarm		
10: Absolute-value upper-limit alarm with standby sequence		
11: Absolute-value lower-limit alarm with standby sequence		



- Related Parameters
 - Alarm Set * Alarm Value * (Alarm Set Setting Level) (P. 8-37)
 - Alarm Set * Alarm Upper limit * (Alarm Set Setting Level) (P. 8-38)
 - Auxiliary Output * Assignment (Control Initial Setting 2 Level) (P. 8-67)
 - Alarm * Latch (Alarm Setting Level) (P. 8-76)
 - Alarm * Hysteresis (Alarm Setting Level) (P. 8-77)
 - Standby Sequence Reset (Alarm Setting Level) (P. 8-78)
 - Alarm SP Selection (Expansion Control Setting Level) (P. 8-97)

CH

Alarm * Latch

*RL**

L3

(*: 1 to 4)

Alarm set for Auxiliary Output Assignment parameter and Alarm Type parameter not set to "No alarm."



- When these parameters are set to "ON," a latch function is added to the alarm function. Once an alarm goes ON, the alarm output is held ON until the power is turned OFF. The latch is canceled if you move to setting area 1.
- When the alarm output is set to "Close in alarm," the closed output is held, and when it is set to "Open in alarm," the open output is held.
- After changing an Alarm 1 to 4 Latch parameter setting, a software reset must be executed or the power must be turned OFF and ON to make the new setting take effect.



Setting range	Unit	Default value
$\bar{a}FF$: Disable	-	$\bar{a}FF$: Disable
$\bar{a}n$: Enable		



- Related Parameters
 - Alarm Set * Alarm Value * (Alarm Set Setting Level) (P. 8-37)
 - Alarm Set * Alarm Upper limit * (Alarm Set Setting Level) (P. 8-38)
 - Auxiliary Output * Assignment (Control Initial Setting 2 Level) (P. 8-67)
 - Alarm * Type (Alarm Setting Level) (P. 8-76)
 - Alarm * Hysteresis (Alarm Setting Level) (P. 8-77)
 - Standby Sequence Reset (Alarm Setting Level) (P. 8-78)
 - Alarm SP Selection (Expansion Control Setting Level) (P. 8-97)

Alarm * Hysteresis

ALH*

L.3

(*: 1 to 4)

Alarm set for Auxiliary Output Assignment parameter and Alarm Type parameter not set to "No alarm."



- These parameters are used to enable hysteresis for alarms 1, 2, 3, and 4.



Setting

Setting range	Unit	Default value
0.01 to 99.99	%FS	0.02



Reference

- Related Parameters

Alarm Set * Alarm Value * (Alarm Set Setting Level) (P. 8-37)

Alarm Set * Alarm Upper limit * (Alarm Set Setting Level) (P. 8-38)

Auxiliary Output * Assignment (Control Initial Setting 2 Level) (P. 8-67)

Alarm * Type (Alarm Setting Level) (P. 8-76)

Alarm * Latch (Alarm Setting Level) (P. 8-76)

Standby Sequence Reset (Alarm Setting Level) (P. 8-78)

Alarm SP Selection (Expansion Control Setting Level) (P. 8-97)

CH

Standby Sequence Reset

rESb

L3

Alarm Types 1 to 4
= With standby sequence



- Use this parameter to select the condition for restarting the standby sequence after it has been canceled.
- Conditions A:
 - At the start of operation (including after turning ON power),
 - When the alarm value (alarm upper or lower limit) is changed,
 - When the input correction (Input Value 1 for Input Correction, Input Correction 1, Input Value 2 for Input Correction, or Input Correction 2 parameter) is changed,
 - When the SP of the current segment is changed (including changing the fixed SP in Fixed SP Mode),
 - When program is started (including when the program is started for program repeats or links), or
 - When the segment is changed (including when an advance is executed).
- Condition B: Power ON
- The following example shows operation using a lower-limit alarm with standby sequence.

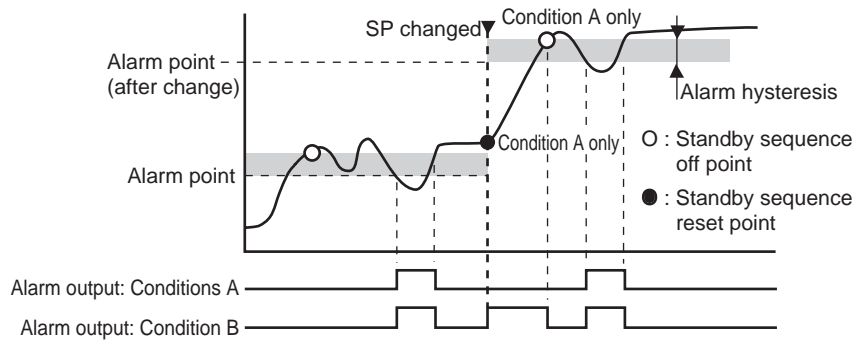

- After changing the standby sequence reset setting, a software reset must be executed or the power turned OFF and ON to make the change take effect.



Setting

Setting range	Unit	Default value
\bar{a} : Condition A \bar{b} : Condition B	—	\bar{a} : Condition A



Reference

- Related Parameters
 - Alarm * Type (Alarm Setting Level) (P. 8-75)
 - Alarm * Latch (Alarm Setting Level) (P. 8-76)

Auxiliary Output * Open in Alarm $5b^*n$

L.3

(*: 1 to 10)



- These parameters are used to select the output state of auxiliary outputs 1 to 10.
- When “Close in alarm” is selected, the state of the alarm output function is output without change. When “Open in alarm” is selected, the state of the output function is inverted before output. The relation between the alarm output function, alarm output, and operation indicator is shown below.

Set value	Auxiliary output function	Auxiliary output	Operation indicator
Close in Alarm	ON	ON	ON
	OFF	OFF	OFF
Open in Alarm	ON	OFF	ON
	OFF	ON	OFF



Setting range	Unit	Default value
$n-\bar{a}$: Close in alarm	-	$n-\bar{a}$: Close in alarm
$n-\bar{f}$: Open in alarm		



- Related Parameters
 - Alarm Set * Alarm Value * (Alarm Set Setting Level) (P. 8-37)
 - Alarm Set * Alarm Upper limit * (Alarm Set Setting Level) (P. 8-38)
 - Auxiliary Output * Assignment (Control Initial Setting 2 Level) (P. 8-67)
 - Alarm * Type (Alarm Setting Level) (P. 8-75)
 - Alarm * Hysteresis (Alarm Setting Level) (P. 8-77)
 - Standby Sequence Reset (Alarm Setting Level) (P. 8-78)
 - Alarm SP Selection (Expansion Control Setting Level) (P. 8-97)

8.15 Display Adjustment Level (L.4)

This level contains parameters for adjustment of the display contents, including selection of the bar graph display items, display refresh period, Monitor Item Level settings, and display scan parameters.

● Level Changes at Startup Up To Display Adjustment Level

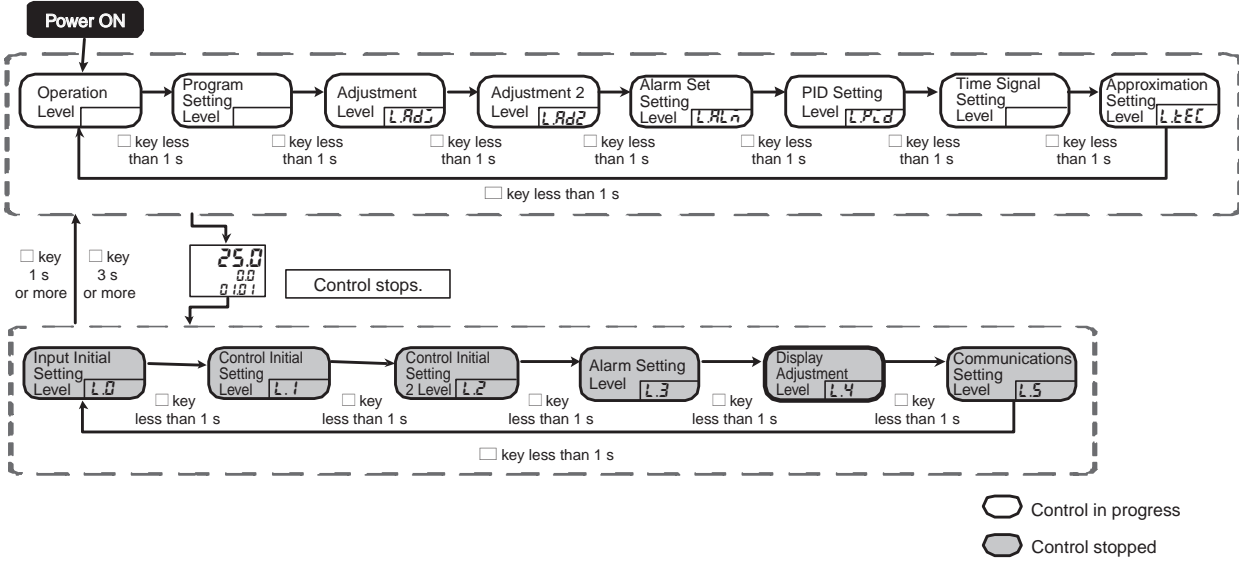

● Parameter Changes within Display Adjustment Level

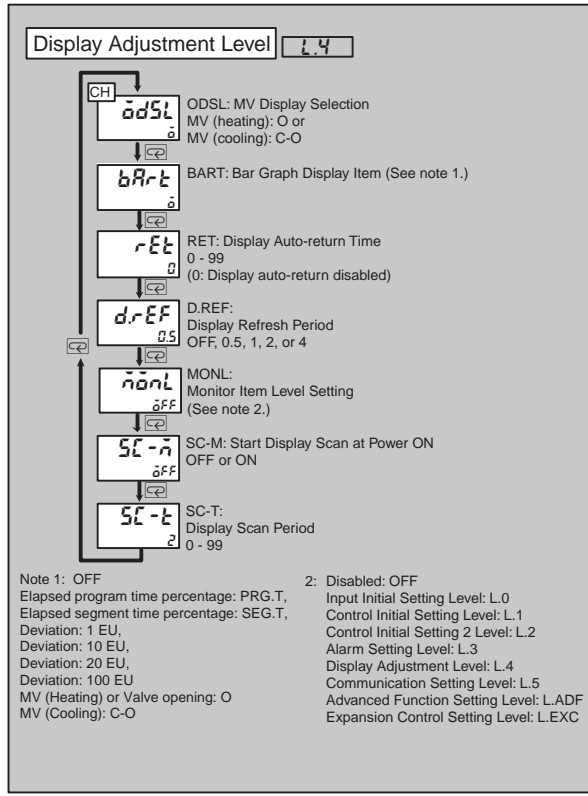

CH

MV Display Selection

0d5L

L.4

Heating/cooling control



- This parameter is used to select which MV is displayed when a PF Key is set to “Present value (PV),” “Present set point,” or “MV” during heating/cooling control.
- “Heating MV” or “Cooling MV” can be selected.



Setting range	Unit	Default value
<i>0</i> : Heating MV	–	<i>0</i> : Heating MV
<i>L-0</i> : Cooling MV		

Bar Graph Display Item

bAr-t

L.4

E5AR-T



- Use this parameter to select the contents of the bar graph display of the E5AR-T.
- The bar graph of the E5AR-T is 10 segments.



Setting range	Unit	Default value
<i>0FF</i> : No bar graph display		<i>0</i> : Standard Control Models: Heating MV, Position-proportional Control Model: Valve opening
<i>1EU</i> : Deviation 1 EU/segment		
<i>10EU</i> : Deviation 10 EU/segment		
<i>20EU</i> : Deviation 20 EU/segment		
<i>100EU</i> : Deviation 100 EU/segment		
<i>0</i> : Standard Control Model: Heating MV Position-proportional Control Model: Valve opening	–	
<i>L-0</i> : Standard Control Model: Cooling MV		

Display Auto-return Time *rEt* L4



- This parameter is used to select the amount of time without key operation that must elapse for the display to revert to the Present Value (PV)/Preset Set Point display when in Operation Level, Program Setting Level, Adjustment Level, Adjustment 2 Level, Alarm Set Setting Level, PID Setting Level, Time Signal Setting Level, Approximation Setting Level, or Monitor Item Level.
- When 0 is selected, the function is disabled (no auto reset).



Setting range	Unit	Default value
0 to 99	s	0

Display Refresh Period *d.rEF* L4



- This parameter is used to lengthen the refresh period of the monitor value display. This only slows the display refresh cycle; it does not affect the update period of the PV during control.
- To disable the function, select OFF.



Setting range	Unit	Default value
OFF, 0.5, 1, 2, 4	s	0.5

Monitor Item Level Setting *nOnL* L4



- One of the following levels can be selected as the Monitor Item Level setting: Input Initial Setting Level, Control Initial Setting Level, Control Initial Setting 2 Level, Alarm Setting Level, Display Adjustment Level, Communications Setting Level, Advanced Function Setting Level, and Expansion Control Setting Level.
- The Monitor Item Level is added after the Approximation Setting Level.
- When OFF is selected, the function is disabled (i.e., the Monitor Item Level is disabled).



Setting range	Unit	Default value
OFF: Monitor Item Level disabled. L0: Input Initial Setting Level L1: Control Initial Setting Level L2: Control Initial Setting 2 Level L3: Alarm Setting Level L4: Display Adjustment Level L5: Communications Setting Level LAdF: Advanced Function Setting Level LEuL: Expansion Control Setting Level	-	OFF

Start Display Scan after Power ON 5C-n

L.4

Display Scan Period 5C-t

Controller with more than one input



- The display scan automatically switches through channels on the display when multiple channels are used on a Controller with more than one input.
- The display scan shows only channels that are enabled using the Number of Enabled Channels parameter.
- The display scan can be started automatically after the power is turned ON or by pressing the **CH** Key.
- To have display scan start automatically after the power is turned ON, set the Start Display Scan after Power ON parameter to ON.
- The display scan period is set in the Display Scan Period parameter. If the period is set to 0, the display scan is disabled.



Parameter	Setting period	Unit	Default value
Start Display Scan after Power ON	0FF: Disable 0n: Enable	–	0FF: Disable
Display Scan Period	0 to 99 (0: Display scan disabled.)	s	2

8.16 Communications Setting Level (L.5)

This level contains Initial setting parameters for communications, such as parameters for the protocol selection, communications unit number, and communications speed.

● Level Changes at Startup Up To Communications Setting Level

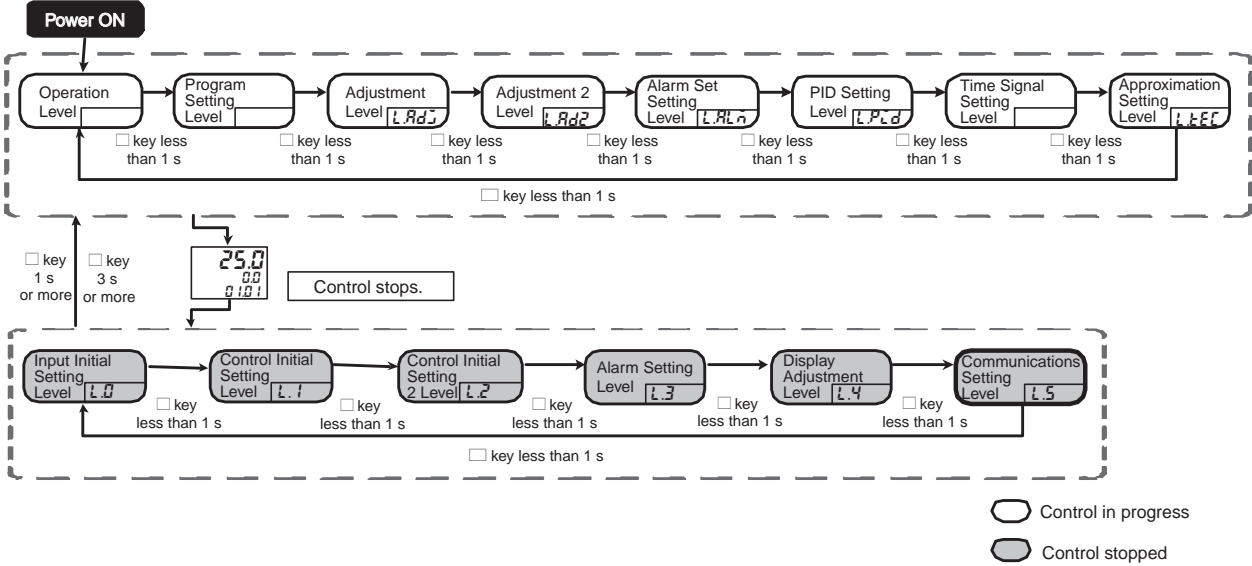

● Parameter Changes within Communications Setting Level

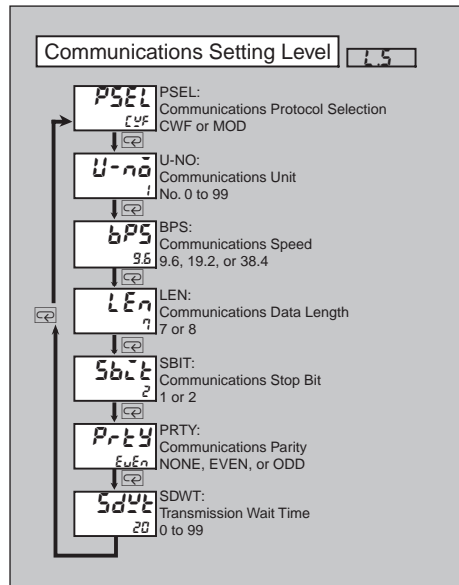

Communications Protocol Selection *PSEL*

L5



- This parameter is used to select the communications protocol. Selections are CompoWay/F, OMRON's unified protocol for general-purpose serial communications, or Modbus, Modicon Inc.'s protocol based on RTU Mode of Modbus Protocol (Specifications: PI-MBUS-300 Rev.J).



Setting range	Unit	Default value
𐄂𐄃𐄄: CompoWay/F 𐄅𐄆𐄇: Modbus	–	𐄂𐄃𐄄: CompoWay/F

Communications Unit No.

U-nō

L5



- After changing the communications unit number setting, execute a software reset or turn the power OFF and ON to make the change effective.



Setting range	Unit	Default value
0 to 99	–	1

Communications Speed

bPS

L5



- After changing the communications speed setting, execute a software reset or turn the power OFF and ON to make the change effective.



Setting range	Unit	Default value
9.6 19.2 38.4	kbps	9.6

Communications Data Length

LEN

1.5

Protocol is CompoWay/F



- After changing the communications data length setting, execute a software reset or turn the power OFF and ON to make the change effective.



Setting range	Unit	Default value
7 to 8	Bits	7

Communications Stop Bits

SBIT

1.5

Protocol is CompoWay/F



- After changing the communications stop bit setting, execute a software reset or turn the power OFF and ON to make the change effective.



Setting range	Unit	Default value
1 to 2	Bits	2

Communications Parity

PRTY

1.5



- After changing the communications parity setting, execute a software reset or turn the power OFF and ON to make the change effective.



Setting range	Unit	Default value
<i>nōnE</i> : None <i>EVEN</i> : Even <i>ōdd</i> : Odd	–	<i>EVEN</i> : Even

Transmission Wait Time

5d4t

L5



- After changing the transmission wait time setting, execute a software reset or turn the power OFF and ON to make the change effective.



Setting

Setting range	Unit	Default value
0 to 99	ms	20

8.17 Advanced Function Setting Level (L.AdF)

This level includes parameters for parameter initialization, PF Key assignments, and the number of enabled channels.

● Level Changes at Startup Up To Advanced Function Setting Level

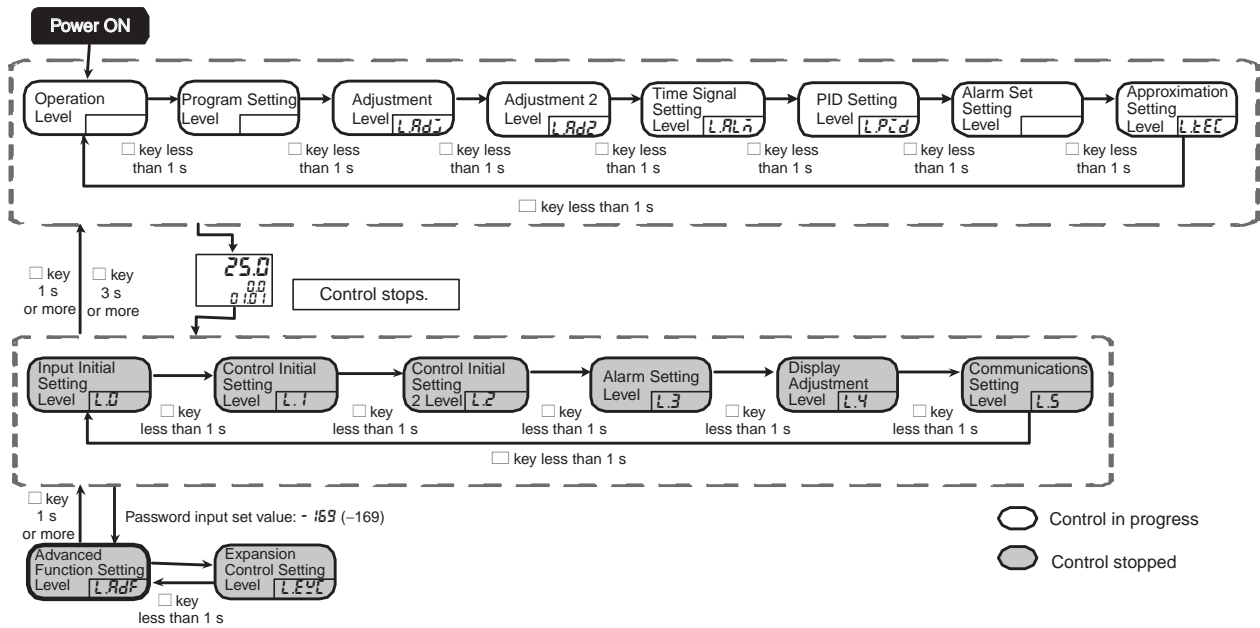

● Parameter Changes within Advanced Function Setting Level

To move to the Advanced Function Setting Level, set the Initial Setting Protection parameter in Protect Level to 0, and then enter the password (-169) in the Move to Advanced Function Setting Level parameter (Input Initial Setting Level).

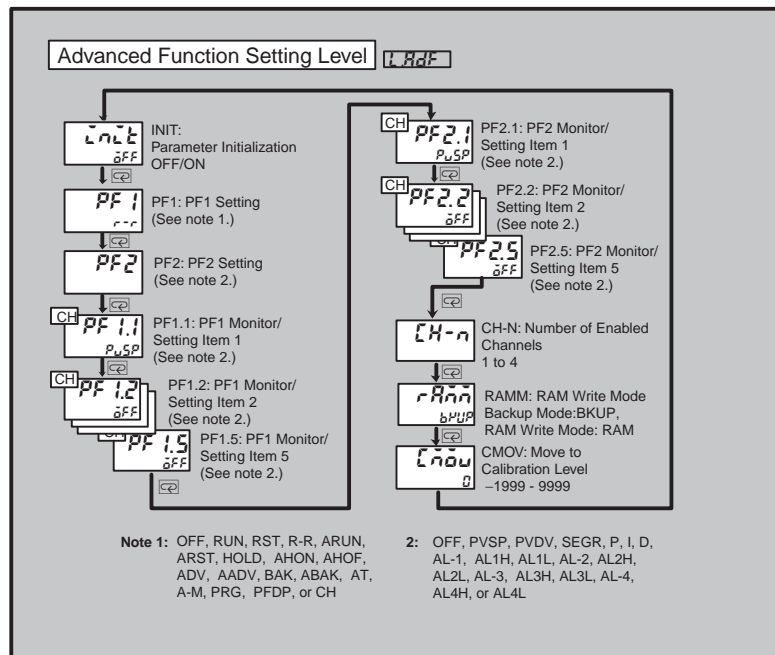

Parameter Initialization

L.AdF

L.AdF



- Use this parameter to return all settings to their default values.



Operation

ON (ON): Initialize all settings.

OFF (OFF): The Parameter Initialization parameter will return to "OFF" after the parameters have been initialized.

PF1 Setting

PF1

L.AdF

PF2 Setting

PF2





- These parameters are used to assign functions to the PF1 and PF2 Keys to enable them to be used as function keys.

Set value	Description	Function
OFF: OFF	Disabled	Does not function as a function key.
RUN: RUN	Run	Executes the currently displayed channel.
RST: RST	Reset	Resets the currently displayed channel.
R-R: R-R	Run/Reset toggle	Switches between execution and resetting for the currently displayed channel.
ARUN: ARUN	Run all	Executes all channels.
ARST: ARST	Reset all	Resets all channels.
HOLD: HOLD	Hold/Hold cancel toggle	Switches between holding and clearing the hold for the currently displayed channel.
AHON: AHON	All hold	Holds all channels.
AHOF: AHOF	All hold cancel	Cancels holding all channels.
ADV: ADV	Advance	Advances the currently displayed channel.
AADV: AADV	All advance	Advanced all channels.
BAK: BAK	Back	Backs the currently displayed channel.
ABAK: ABAK	All back	Backs all channels.
AT: AT	AT Execute/Cancel toggle	Switches between executing and canceling AT. AT is executed for the currently selected PID set.
A-M: A-M	Auto/Manual toggle	Switches between auto and manual.
PRG: PRG	Program Selection	Specifies the program number (increments program number by 1).
PFDP: PFDP	Monitor/Setting Item	Displays the monitor/setting items. Set the Monitor/Setting Item 1 to Monitor/Setting Item 5 parameter (Advanced Function Setting Level).
CH: CH	CH Key	Functions as the CH Key.

- Hold down the PF1 or PF2 Key for at least 1 second to execute the function selected in the PF1 Setting or PF2 Setting parameter. If “Program Selection,” “Monitor/Setting Item,” or “  Key” is selected, the display will scroll through monitor/setting items 1 to 5 each time you press the key.



Setting

Parameter	Setting range	Unit	Default value
PF1 setting	<i>ōFF</i> : Disabled <i>rUn</i> : Run <i>rSt</i> : Reset <i>r-r</i> : Run/Reset toggle <i>RrUn</i> : Run All <i>RrSt</i> : Reset All <i>HōLd</i> : Hold/Cancel Hold toggle <i>RHōn</i> : All Hold <i>RHōF</i> : All Hold Clear	–	<i>r-r</i> : Reset/Run toggle
PF2 setting	<i>Rdu</i> : Advance <i>RRdu</i> : Advance All <i>bAP</i> : Back <i>RbAP</i> : Back All <i>Rt</i> : AT Execute/Cancel toggle <i>R-n</i> : Auto/Manual toggle <i>PrL</i> : Program Selection <i>PFdP</i> : Monitor/Setting Item <i>CH</i> :  Key	–	Controllers with One Input <i>PrL</i> : Program selection Controllers with More Than One Input <i>CH</i> :  Key

CH

PF1 Monitor/setting Item 1 to *PF 1.1* to *PF 1.5*
 PF1 Monitor/setting Item 5 *PF2.1* to *PF2.5*
 PF2 Monitor/setting Item 1 to
 PF2 Monitor/setting Item 5

L.AdF

PF Key set to monitor/setting item



- When one or both PF Keys are set to “Monitor/setting item,” the Monitor/Setting Item 1 to Monitor/Setting Item 5 parameters for each key must be set according to the following table.
- Each time a PF Key is pressed, the display scrolls to the next monitor/setting item in order from the item set for the Monitor/Setting Item 1 parameter to the item set for the Monitor Setting Item 5 parameter.



Setting	Setting range	Unit	Default value
PF1 Monitor/Setting Item 1	<i>OFF</i> : Disabled		
PF1 Monitor/Setting Item 2	<i>PVSP</i> : PV/Present Set Point/MV (settable) (Fixed SP)		
PF1 Monitor/Setting Item 3	<i>PVdV</i> : PV/DV (monitor only)		
PF1 Monitor/Setting Item 4	<i>SEGr</i> : Remaining Segment Time Monitor (monitor only)		
PF1 Monitor/Setting Item 5	<i>P</i> : Proportional Band (P) (settable)		<i>PVSP</i> : PV/ Present Set Point/ MV (settable) (Fixed SP)
PF2 Monitor/Setting Item 1	<i>I</i> : Integral Time (I) (settable)		
PF2 Monitor/Setting Item 2	<i>d</i> : Derivative Time (D) (settable)		
PF2 Monitor/Setting Item 3	<i>AL-1</i> : Alarm 1 (settable)		
PF2 Monitor/Setting Item 4	<i>AL 1H</i> : Alarm Upper Limit 1 (settable)		
PF2 Monitor/Setting Item 5	<i>AL 1L</i> : Alarm Lower Limit 1 (settable)		
PF2 Monitor/Setting Item 6	<i>AL-2</i> : Alarm 2 (settable)		
PF2 Monitor/Setting Item 7	<i>AL 2H</i> : Alarm Upper Limit 2 (settable)		
PF2 Monitor/Setting Item 8	<i>AL 2L</i> : Alarm Lower Limit 2 (settable)		
PF2 Monitor/Setting Item 9	<i>AL-3</i> : Alarm 3 (settable)		
PF2 Monitor/Setting Item 10	<i>AL 3H</i> : Alarm Upper Limit 3 (settable)		
PF2 Monitor/Setting Item 11	<i>AL 3L</i> : Alarm Lower Limit 3 (settable)		
PF2 Monitor/Setting Item 12	<i>AL-4</i> : Alarm 4 (settable)		
PF2 Monitor/Setting Item 13	<i>AL 4H</i> : Alarm Upper Limit 4 (settable)		
PF2 Monitor/Setting Item 14	<i>AL 4L</i> : Alarm Lower Limit 4 (settable)		



- Related Parameters
 PF1 Setting and PF2 Setting (Advanced Function Setting Level) (P. 8-89)

Parameters

Number of Enabled Channels

$\overline{CH-n}$

\overline{LAdF}

Controller with more than one input



Function

- This parameter is used to set the number of enabled channels when using multiple channels on a Controller with more than one input.



Setting

Setting range	Unit	Default value
1 to 4	–	*

- * The default value and setting range depend on the control mode setting of the Controller with more than one input.

2-input model: Proportional control, standard control with remote SP, heating/cooling control with remote SP: 1

Other modes: 2

4-input model: 4



Reference

- Related Parameters
Start Display Scan after Power ON and Display Scan Period (Display Adjustment Level) (P. 8-83)

RAM Write Mode

\overline{rRn}

\overline{LAdF}



Function

- Use this parameter to select the write mode.

Write mode	Explanation
Backup Mode	When writing set values to setting area 0 by communications, the data is also written to internal EEPROM.
RAM Write Mode	When writing set values to setting area 0 by communications, the data is not written to internal EEPROM. However, changes to set values made by key operation are written to EEPROM.

- When the write mode is changed from RAM Write Mode to Backup Mode, the set values in setting area 0 are written to internal EEPROM.



Setting

Setting range	Unit	Default value
\overline{bPUP} : Backup Mode \overline{rRn} : RAM Write Mode	–	\overline{bPUP} : Backup Mode



Reference

- Related Information
5.10 Using Communications (P. 5-49)

Move to Calibration Level

L.AdF

L.AdF

This parameter is used to move to Calibration Level.



- Use this parameter to enter the password to access Calibration Level.



Setting

Setting range	Unit	Default value
-1999 to 9999	-	0



Reference

- Related Information
Section 9 User Calibration (P. 9-1)

8.18 Expansion Control Setting Level (L.E.U.C)

This level includes parameters for advanced control settings, such as operation after turning ON power, PID set automatic selection settings, and position-proportional settings.

● Level Changes at Startup Up To Expansion Control Setting Level

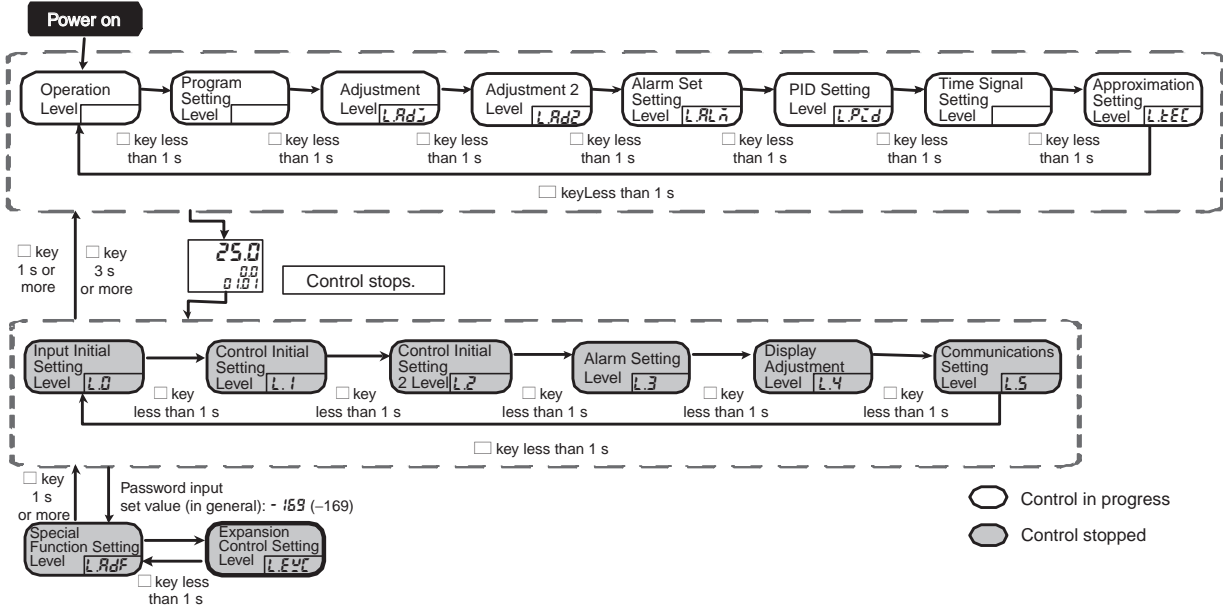

● Parameter Changes within Expansion Control Setting Level

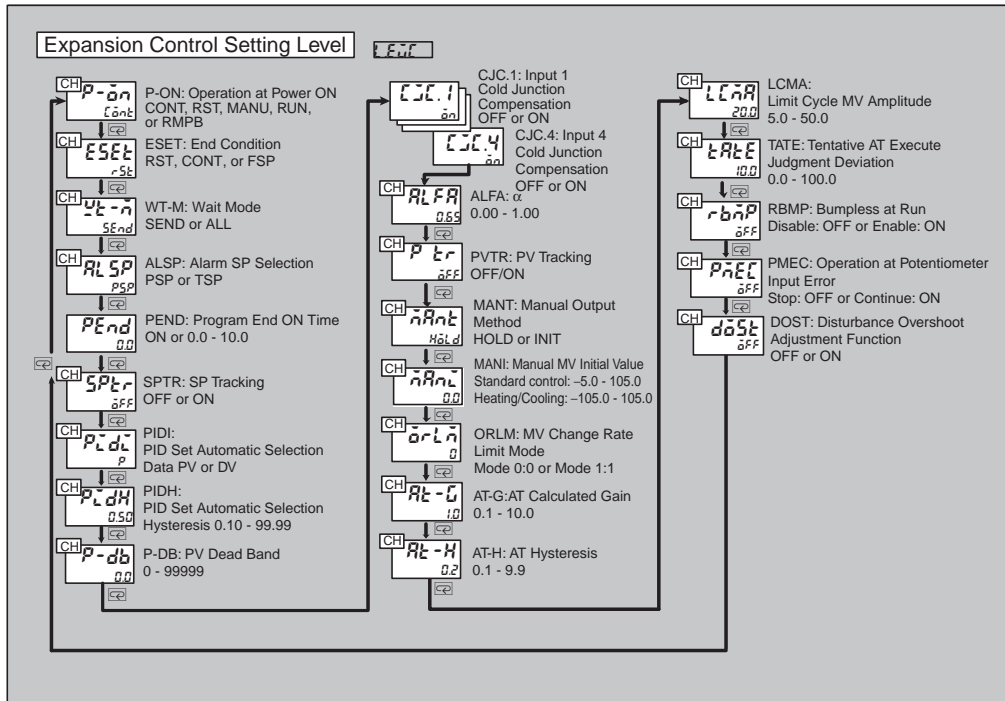

CH

Operation at Power ON

P-on

L.E.U.C



- Select “Continue,” “Reset,” “Manual Mode,” “Run Status,” or “Ramp Back” for operation after the power is turned ON.
- Operation after a software reset or when moving from the Initial Setting Level to the Operation Level is also determined by this parameter.



Setting range	Unit	Default value
L-onk: Continue rSk: Reset nPnM: Manual Mode rUn: Run Status rnPb: Ramp Back	–	L-onk: Continue



- Related Information
4.12 Starting and Stopping Operation (P. 4-41)

CH

End Condition

ESEt

L.E.U.C

This parameter is used to specify the operation status after the program has been completed.



- Reset: Operation ends
- Continue: Operation is continued using the SP of the last segment.
The number of the last segment is held as the segment number, and the elapsed program time, elapsed segment time, and remaining segment time values are held. The time singles will hold status when operation ends.
- Fixed SP Mode: Operation continues in Fixed SP Mode when the program has been completed.
The segment number, elapsed program time, elapsed segment time, and remaining segment time are held at the values for the beginning of the segment.
The Time Signal parameter is set to OFF.



Setting range	Unit	Default value
rSk: Reset Status L-onk: Continue FSP: Fixed SP Mode	–	rSk: Reset Status



- Related Information
End Condition in 5.7 Program Operation Functions (P. 5-38)

CH

Wait Mode

5E-n

L.E.U.C

This parameter is used to specify the Wait operating mode.



- Wait at Segment End
When this set value is selected, the program will not move to the next segment when one segment is completed unless the difference (deviation) between the PV and SP are within the wait band. The program will move to the next segment as soon as the deviation is within the wait band.
- Always Wait
The difference (deviation) between the PV and SP are constantly compared during program operation. If the deviation is not within the wait band the SP is held at the point that the deviation went outside the wait band and the program does not move on. The program moves on as soon as the deviation enters the wait band.



Setting range	Unit	Default value
SEnd: Wait at Segment End AL: Always Wait	-	SEnd: Wait at Segment End



- Related Information
Wait in 5.7 Program Operation Functions (P. 5-32)
- Related Parameters
Wait Band Upper Limit and Wait Band Lower Limit (Program Setting Level) (P. 8-20)

CH

Alarm SP Selection

AL SP

L.E.C.C

Alarm Type 1 to 4 parameters set to
"Deviation Alarm"

- This parameter is used to select whether the alarm value deviation will be based on the present SP or the target SP.



Setting range	Unit	Default value
<i>PSP</i> : Present SP <i>TSP</i> : Target SP	–	<i>PSP</i> : Present SP



- Related Information
Alarm SP Selection in 5.6 *Alarm Adjustment Functions* (P. 5-26)
- Related Parameters
Alarm Set * Alarm Value * (Alarm Set Setting Level) (P. 8-37)
Alarm Set * Alarm Upper Limit * (Alarm Set Setting Level) (P. 8-38)
Auxiliary Output * Assignment (Control Initial Setting 2 Level) (P. 8-67)
Alarm * Type (Alarm Setting Level) (P. 8-75)
Alarm * Latch (Alarm Setting Level) (P. 8-76)
Alarm * Hysteresis (Alarm Setting Level) (P. 8-77)
Standby Sequence Reset (Alarm Setting Level) (P. 8-78)

Program End ON Time

PEnd

L.E.C.C



- This function is used to set the pulse width for program end output.
- The setting range is ON, 0.0 to 10.0 s. The default is 0.0.
- When this parameter is set to ON, the ON status continues during a reset until operation starts.



Setting range	Unit	Default value
<i>ōn</i> : Continue ON output 0.0: No output 0.1 to 10.0	s	0.0



- Related Information
Program Status Outputs in 5.7 *Program Operation Functions* (P. 5-36)
- Related Parameters
Auxiliary Output * Assignment (Control Initial Setting 2 Level) (P. 8-67)

CH

SP Tracking

SPTr

LEDC



Function

- This parameter is used to specify operation when switching from Program SP Mode or Remote SP Mode to Fixed SP Mode.
- When remote SP tracking is enabled (ON), the value of the program SP or remote SP is inherited as the fixed SP.
- When remote SP tracking is disabled (OFF), the fixed SP is not affected by the program SP or by the remote SP.



Setting

Setting range	Unit	Default value
ōFF: Disable	-	ōFF
ōn: Enable		



Reference

- Related Information
SP Modes in 5.7 Program Operation Functions (P. 5-31)
- Related Parameters
Control Mode (Control Initial Setting Level) (P. 8-58)
SP Mode (Adjustment Level) (P. 8-24)

CH

PID Set Automatic Selection Data

PIdc

LEDC

PID Set Automatic Selection Hysteresis

PIdH

CH



Function

- This parameter is used for automatic selection of the PID set.
- The PID set number to be used is automatically selected based on the value set in PID Set Automatic Selection Data parameter. The switching range is specified in the PID Set Automatic Select Range parameter (PID Setting Level).
- The PID Set Automatic Selection Hysteresis parameter is used to prevent chattering when the PID is changed.



Setting

Parameter	Setting range	Unit	Default value
PID Set Automatic Selection Data	P _u : Present value d _w : Deviation SP: Present set point	-	P _u : Present value
PID Set Automatic Selection Hysteresis	0.10 to 99.99	%FS	0.50



Reference

- Related Information
PID Sets in 5.2 Control Functions (P. 5-10)
- Related Parameters
PID Set Number (Program Setting Level) (P. 8-19)
PID * Automatic Selection Range Upper Limit (PID Setting Level) (P. 8-42)

CH

PV Dead Band

P-db

L.E.C.

Position-proportional Control Model



- This parameter is used on a Position-proportional Control Model so that PV = SP when the PV is within the PV dead band.
- This function prevents unnecessary output when the PV is near the SP.



Setting

Setting range	Unit	Default value
0 to 99999	EU	0



Reference

- Related Parameters
 - Closed/Floating (Control Initial Setting Level) (P. 8-59)
 - Motor Calibration (Control Initial Setting 2 Level) (P. 8-72)
 - Travel Time (Control Initial Setting 2 Level) (P. 8-73)
 - Position-proportional Dead Band (Adjustment Level) (P. 8-27)
 - Open/Close Hysteresis (Adjustment Level) (P. 8-28)
 - Operation at Potentiometer Input Error (Expansion Control Setting Level) (P. 8-104)

Input * Cold Junction Compensation

C.C.*

L.E.C.

(*: 1 to 4)

Thermocouple input



Function

- When using a thermocouple input, these parameters are used to specify whether cold junction compensation is performed inside the Controller or outside the Controller.
- Select "External" when two thermocouples are used to measure the temperature difference or when an external cold junction compensator is used for increased accuracy.



Setting

Setting range	Unit	Default value
0FF: External	-	00: Internal
00: Internal		



Reference

- Related Parameters
 - Input * Type (Input Initial Setting Level) (P. 8-50)

CH α *ALFA* L.E.U.C



- This parameter is normally used at the default value.
- This parameter sets the 2-PID constant α .



Setting range	Unit	Default value
0.00 to 1.00	–	0.65

CH PV Tracking *Pvtr* L.E.U.C



- This parameter is used so have the fixed SP track the PV when in Manual Mode.
- The setting prevents abrupt changes in the MV when switching from Manual Mode to Auto Mode.

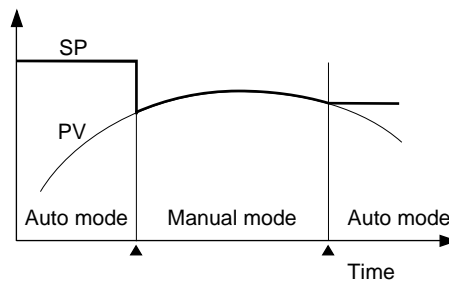

Setting range	Unit	Default value
$\bar{a}FF$: Disabled $\bar{a}n$: Enabled	–	$\bar{a}FF$: Disabled

If an input error occurs during PV tracking, the fixed SP will change to the upper limit of the sensor setting range.

CH

Manual Output Method

ክዳብቲ

L.E.C

Manual MV Initial Value

ክዳብቲ

Standard Control Model

These parameters are used to specify how the MV is output when switching from Auto Mode to Manual Mode.



- When “Hold MV” is selected, the MV at the time of switching is held, after which it can be changed using the Manual MV parameter (Operation Level).
- When “Output default value” is selected, the value specified in the Manual MV Initial Value parameter is used. This can then be changed using the Manual MV parameter (Operation Level).

Examples of how the MV changes using the two methods are shown below.

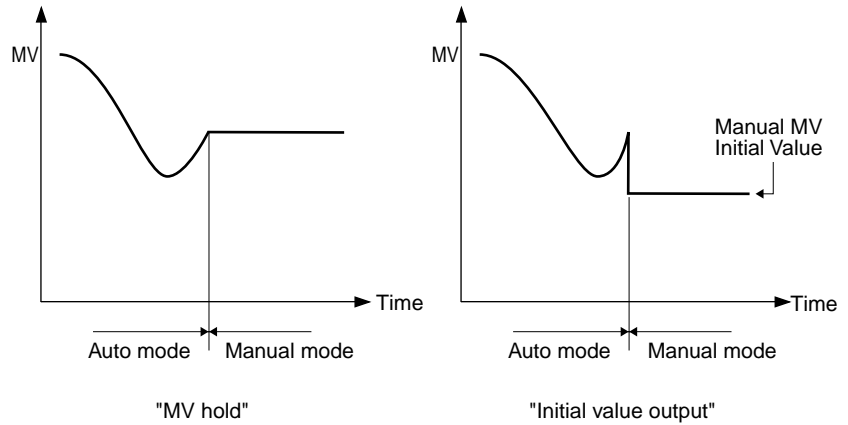

Parameter	Setting range	Unit	Default value
Manual Output Method	MV hold: ክዳብቲ Default value output: ሲንቲ	-	ክዳብቲ
Manual MV Initial Value	-5.0 to 105.0 (Standard) -105.0 to 105.0 (Heating/cooling)	%	0.0



- Related Information
4.13 Manual Operation (P. 4-47)
- Related Parameters
Manual MV (Operation Level) (P. 8-7)

Parameters

CH

MV Change Rate Limit Mode

ārlā

LEUC



Function

- Use this parameter to select Mode 0 or Mode 1 for the MV change rate limit.
- When Mode 1 is selected, the MV change of rate limit functions only with respect to increases in the MV.



Setting

Setting range	Unit	Default value
0: Mode 0 1: Mode 1	-	0



Reference

- Related Information
PID Sets in 5.2 Control Functions (P. 5-10)
- Related Parameters
MV Change Rate Limit (Heating) and MV Change Rate Limit (Cooling) (Adjustment Level) (P. 8-30)

CH

AT Calculated Gain

āġ-G

LEUC

AT Hysteresis

āġ-H

Limit Cycle MV Amplitude

LEAA*

Temporary AT Execution Judgement

ġāġE*

Deviation

*Control mode key: heating/cooling control and position-proportional control (floating). During cascade heating/cooling control, only channel 1 is displayed.



Function

- These parameters are normally used at the default values.
- The AT Calculated Gain parameter specifies the gain used when PID constants are calculated during AT. A smaller gain provides greater adaptability, while a larger gain provides greater stability.
- The AT Hysteresis parameter is used to set the hysteresis when switching ON/OFF during the limit cycle while AT is being executed.
- The Limit Cycle MV Amplitude parameter is used to set the MV amplitude during the limit cycle while AT is being executed. This is effective when P ≠ 0.00 in standard control, or when closed is selected in proportional control.
- The Temporary AT Execution Judgement Deviation parameter is used to determine whether temporary AT is executed when executing AT. If AT is executed when the deviation is greater than the set value, temporary AT is executed. This is effective when P ≠ 0.00 in standard control, or when closed is selected in proportional control.



Setting	Setting range	Unit	Default value
AT Calculated Gain	0.1 to 10.0	–	1.0
AT Hysteresis	0.1 to 9.9	%FS	0.2
Limit Cycle MV Amplitude	5.0 to 50.0	%	20.0
Temporary AT Execution Judgement Deviation	0.0 to 100.0	%FS	10.0



- Related Information
4.10 Determining the PID Constants (AT or Manual Settings) (P. 4-33)
- Related Parameters
AT Execute/Cancel (Adjustment Level) (P. 8-23)

CH

Bumpless at RUN

rbrP

L.E.U.C

Operation at Reset parameter set to "Stop Control"



- When the Bumpless at RUN parameter is enabled, an integral MV correction (bumpless) is performed to prevent abrupt changes in the MV when switching from reset to run.
- Even when the setting is disabled, the bumpless correction is performed when PID constants change (including changing the PID set) and when AT ends or is stopped.



Setting range	Unit	Default value
0FF: Disabled 0n: Enabled	–	0FF: Disabled



- Related Parameters
Operation at Reset (Control Initial Setting Level) (P. 8-62)

CH

Operation at Potentiometer Input Error *PnEC*

LEUC

Position-proportional Control Model
Closed control



- This parameter is used to select whether control is stopped or changed to floating control when a potentiometer error occurs during closed position-proportional control.



Setting range	Unit	Default value
$\bar{a}FF$: Stop	–	$\bar{a}FF$: Stop
$\bar{a}n$: Continue		



- Related Parameters
Closed/Floating (Control Initial Setting Level) (P. 8-59)

CH

Disturbance Overshoot Adjustment Function *dōSt*

LEUC



- This parameter is used to enable or disable disturbance overshoot adjustment.



Setting range	Unit	Default value
$\bar{a}FF$: Disabled	–	$\bar{a}FF$: Disabled
$\bar{a}n$: Enabled		



- Related Information
Disturbance Overshoot Adjustment in 5.2 Control Functions (P. 5-13)

Section 9 User Calibration

9.1	Parameters for User Calibration	9-2
9.2	User Calibration	9-4
9.3	Thermocouple Input Calibration	9-5
9.4	Analog Input Calibration	9-8
9.5	Resistance Thermometer Calibration	9-10
9.6	Output Calibration.....	9-12
9.7	Inspecting Indicator Accuracy.....	9-14

9.1 Parameters for User Calibration

- To perform user calibration, enter 1201 for the Move to Calibration Level parameter in the Advanced Function Setting Level. The Controller will enter Calibration Mode and **Adj** will be displayed on the display.
- If the Move to Calibration Level parameter does not appear, set the Initial Setting Protection parameter to 0 in the Protect Level and then move to Advanced Function Setting Level.
- Calibration is ended by turning OFF the power.
- The parameters for input calibration are shown below.
(The last digit of Display No. 1 shows the input number. The example below shows 1 for input 1. For input 2, the display would show **P390.2**.)

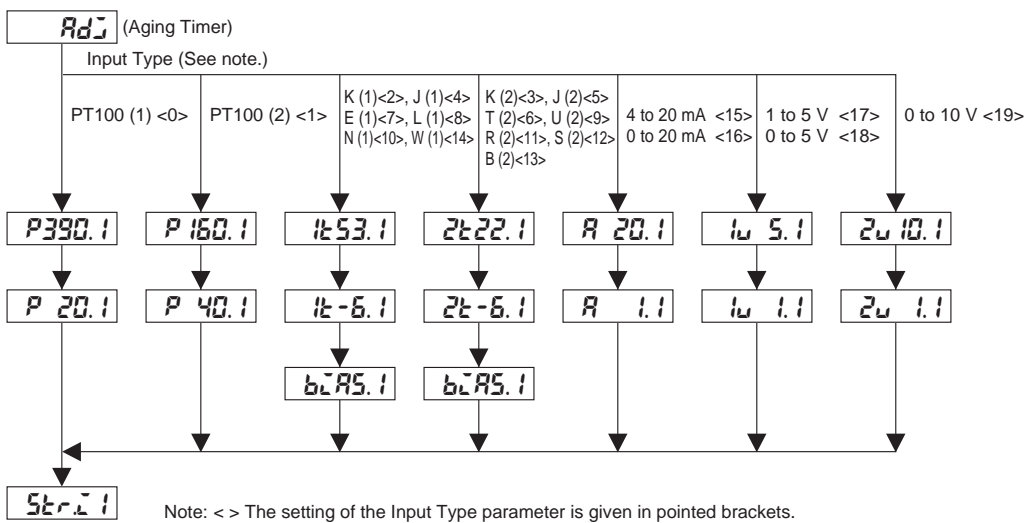

■ Output Calibration Parameters

The parameters for output calibration are shown below. The display depends on the output type setting for each output.
(In the following example, the last digit of Display No. 1 shows 1 for output 1. For output 2, this would be **oR20.2**.)

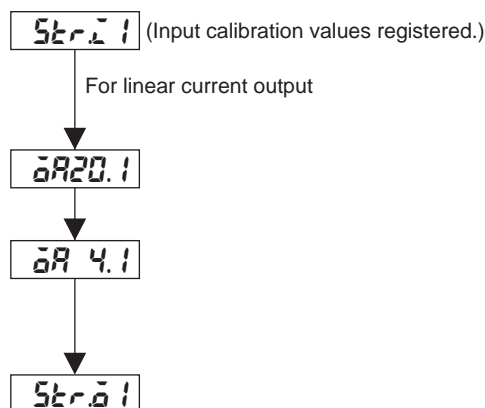

If user calibration was performed on any of inputs 1 to 4 or outputs 1 to 6 following purchase of the Controller, user calibration information will be displayed as shown below when you move to Calibration Level.

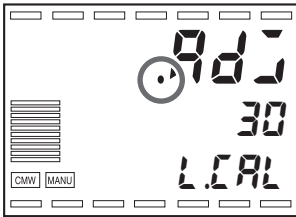

Displays dots.

9.2 User Calibration

The E5AR-T/ER-T is calibrated before shipment from the factory and thus there is normally no need for the user to perform calibration.

If user calibration is necessary, use the calibration functions for temperature inputs, analog inputs, and outputs that are provided in the Controller. Be aware, however, that OMRON cannot ensure the results of calibration by the user.

Important

The calibration data is overwritten each time calibration is performed. You cannot return to the factory-calibrated data after performing user calibration.

■ Input Calibration

Calibration is performed for the input type set in the Input Type parameter. Input types consist of the following 20 types:

- Thermocouples: 13 types
- Analog input: 5 types
- Resistance thermometers: 2 types

■ Output Calibration

Calibration is performed for the output type set in the Output Type parameter. There is only one output type that can be selected:

- Linear current output

■ Registering Calibration Data

The new calibration data for each item is temporarily registered. It can be permanently registered as calibration data only when all items have been calibrated to new values. Be sure to temporarily register all items when you calibrate the E5AR-T/ER-T.

When calibration data is registered, user execution of calibration is also registered.

Prepare separate measuring devices and equipment for calibration. For details on how to handle measuring devices and equipment, refer to the respective instruction manuals.

9.3 Thermocouple Input Calibration

- Thermocouples are calibrated in two groups according to thermocouple type: Group 1 (input types 2, 4, 7, 8, 10, 14) and Group 2 (input types 3, 5, 6, 9, 11, 12, 13).
- Do not obstruct the bottom of the Controller during calibration. Also, do not touch the input terminals or compensating leads.

■ Preparations

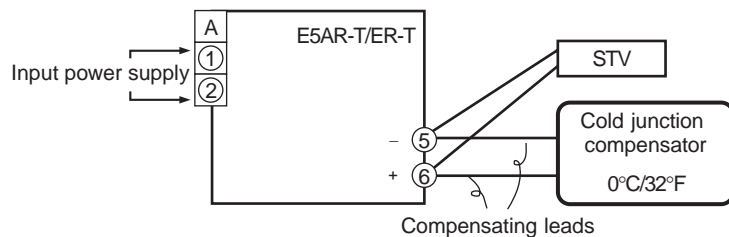

- Use a cold junction compensator for calibration of internal thermocouples and set it to 0°C. The internal thermocouple should be disabled (end open).
- “STV” in the diagram is a DC reference current/voltage generator.
- Prepare compensating leads appropriate for the selected thermocouple. A cold junction compensator and compensating leads for a K thermocouple can be used for thermocouples R, S, E, B and W.



Connecting the cold junction compensator

A correct input value cannot be obtained if the compensation wire connector is touched during thermocouple calibration. Therefore, to connect or disconnect the cold junction compensator, short-circuit (enable) or open-circuit (disable) the tip of the thermocouple inside the cold junction compensator, while keeping the compensation wire connected as shown in the diagram.

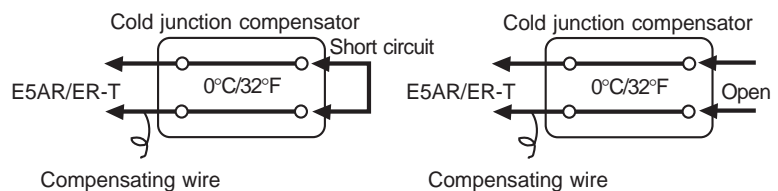

Follow these steps to perform calibration when thermocouple input is selected.

1. Connect the power supply.
2. Connect the DC reference current/voltage generator (STV below), precision digital meter (DMM below), and cold junction compensator (a ZERO-CON is used as an example below) to the input terminals of the thermocouple as shown below.

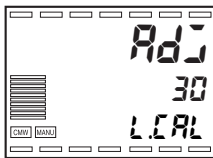
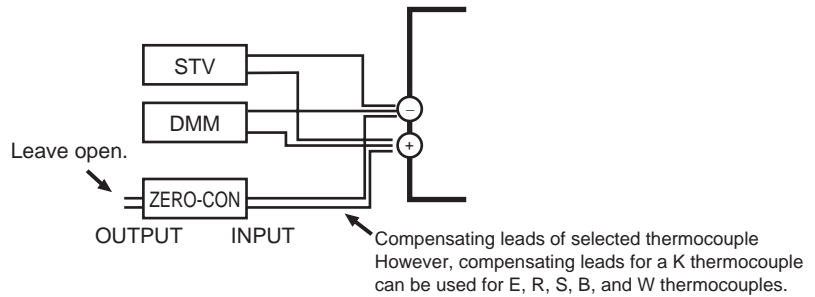

3. Turn ON the power.
4. Move to Calibration Level.
A 30-minute aging timer will begin. Perform aging using this timer as a guideline. When 30 minutes has elapsed, Display No. 2 will show 0.
You can proceed to the next step before the display shows 0.

Input types 2, 4, 7, 8, 10, 14

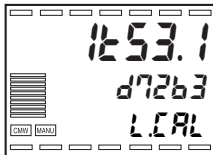

Input types 3, 5, 6, 9, 11, 12, 13

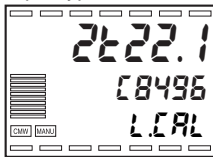

Input types 2, 4, 7, 8, 10, 14

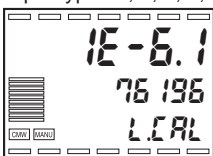

5. Press the Key. The display at the left will appear.
The count value that was input will be displayed on Display No. 2 in hexadecimal. Set the STV as follows:
 - For input types 2, 4, 7, 8, 10, and 14: 53 mV
 - For input types 3, 5, 6, 11, 12, and 13: 22 mV
 Wait until the count on Display No. 2 is sufficiently stable and then press the Key. This tentatively registers the calibration data at this point.
6. Press the Key. The display at the left will appear.
Set the STV to -6 mV.
Wait until the count on Display No. 2 is sufficiently stable and then press the Key. This tentatively registers the calibration data at this point.

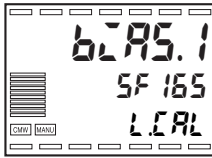



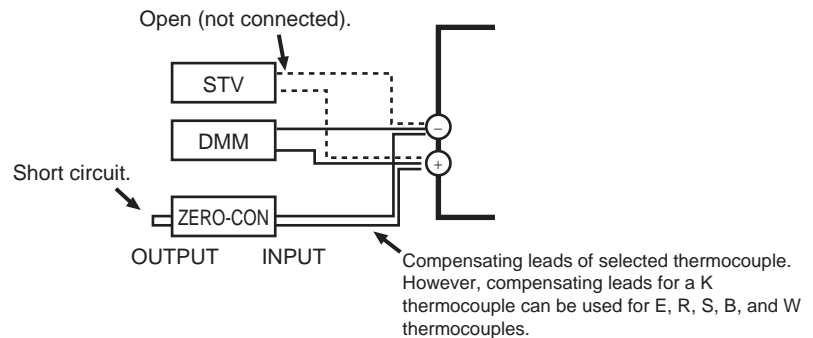



7. Press the  Key. The display at the left will appear.
8. Change the wiring as shown below.

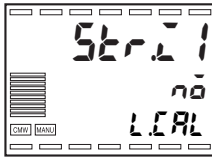

Disconnect the STV and enable the thermocouple in the cold junction compensator. Make sure that the STV is disconnected at this time.

9. Wait until the count on Display No. 2 is sufficiently stable and then press the  Key. This tentatively registers the calibration data at this point.



10. Press the  Key. The display at the left will appear. This display will not appear if all of the required data has not been tentatively registered. Press the  Key. Display No. 2 will show 4E5. Two seconds after the Key is released or when the  Key is pressed, the tentatively registered calibration data will be stored in EEPROM. If you do not wish to save the data in EEPROM, press the  Key instead of the  Key.

- For a Controller with more than one input, connect as explained in step 2 and repeat steps 5 to 10.
- If a linear current output is selected, continue with the procedure in 9.6 *Output Calibration* (P. 9-12).

11. Turn OFF the power to leave Calibration Mode.

9.4 Analog Input Calibration

Analog inputs are calibrated in the following groups according to the analog input type: current input group (15, 16), voltage input group 1 (17, 18), and voltage input group 2 (19).

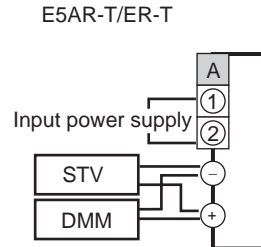

1. Connect the power supply.
2. Connect the STV and DMM to the input terminals of the analog input as shown above.
Different input terminals are used for current input and voltage input. Make sure the connections are correct.
3. Turn ON the power.
4. Move to Calibration Level.

A 30-minute aging timer will begin. Perform aging using this timer as a guideline. When 30 minutes has elapsed, Display No. 2 will show 0. You can proceed to the next stop before the display shows 0.

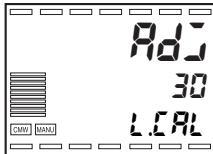

Input types 15 and 16

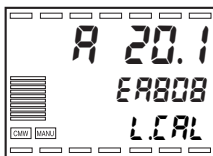

Input types 17 and 18

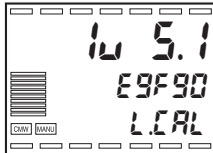

Input type 19

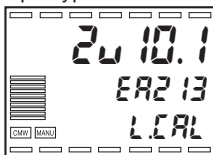

5. Press the Key. The display at left will appear.
The count value that was input will be displayed on Display No. 2 in hexadecimal. Set the STV as follows:
 - For input types 15 and 16: 20 mA
 - For input types 17 and 18: 5 V
 - For input type 19: 10 V

6. Wait until the count on Display No. 2 is sufficiently stable and then press the Key. This tentatively registers the calibration data at this point.

Input types 15 and 16

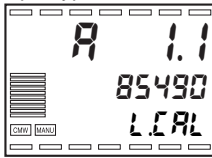

Input types 17 and 18

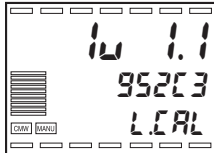

Input type 19

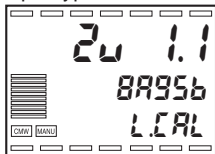





7. Press the Key . The display at the left will appear.

Set the STV as follows:

- Input types 15 and 16: 1 mA
- Input types 17 and 18: 1 V
- Input type 19: 1 V

8. Wait until the count on Display No. 2 is sufficiently stable and then press the  Key. This tentatively registers the calibration data at this point.

9. Press the  Key. The display at the left will appear. This display will not appear if all of the required data has not been tentatively registered.

Press the  Key. Display No. 2 will show **YES**. Two seconds after the Key is released or when the  Key is pressed, the tentatively registered calibration data will be stored in EEPROM. If you do not wish to save the data in EEPROM, press the  Key instead of the  Key.

- For a Controller with more than one input, connect as explained in step 2 and repeat steps 5 to 9.
- If linear current output is selected, continue with the procedure in 9.6 *Output Calibration* (P. 9-12).

10. Turn OFF the power to leave Calibration Mode.

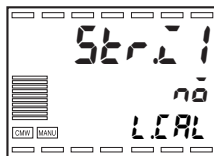

9.5 Resistance Thermometer Calibration

The procedure for calibrating a resistance thermometer is provided in this section.

Use wiring of the same thickness for the connections.

1. Connect the power supply.

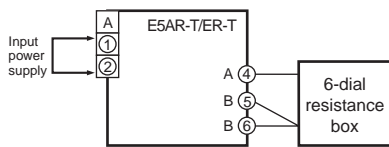

2. Connect a precision resistance box (a 6-dial model in this procedure) to the input terminal of the resistance thermometer as shown at left.

3. Turn ON the power.

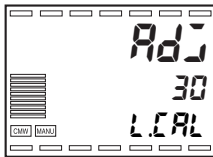

4. Move to Calibration Level.

A 30-minute aging timer will begin. Perform aging using this timer as a guideline. When 30 minutes has elapsed, Display No. 2 will show 0. You can proceed to the next stop before the display shows 0.

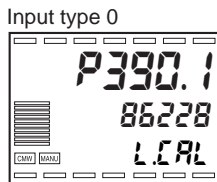

5. Press the Key  to display the count value for each input type.

At this time, the count value that was input will be displayed on Display No. 2 in hexadecimal. Set the 6-dial resistance box as follows:

- Input type 0: 390 Ω
- Input type 1: 160 Ω

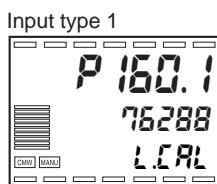

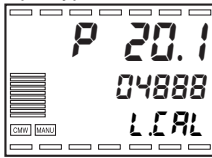

6. Wait until the count on Display No. 2 is sufficiently stable and then press the  Key. This tentatively registers the calibration data at this point.

Input type 0

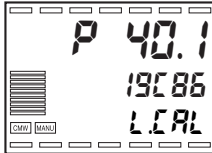

Input type 1





7. Press the  Key. The display at the left will appear.



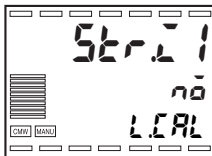

Set the 6-dial resistance box as follows:

- Input type 0: 20 Ω
- Input type 1: 40 Ω

8. Wait until the count on Display No. 2 is sufficiently stable and then press the  Key. This tentatively registers the calibration data at this point.



9. Press the  Key. The display at the left will appear. This display will not appear if all of the required data has not been tentatively registered.

Press the  Key. Display No. 2 will show **YES**. Two seconds after the Key is released or when the  is pressed, the tentatively registered calibration data will be stored in EEPROM. If you do not wish to save the data in EEPROM, press the  Key instead of the  Key.

- For a Controller with more than one input, connect as explained in step 2 and repeat steps 5 to 9.
- If linear current output is selected, continue with the procedure in 9.6 *Output Calibration* (P. 9-12).

10. Turn OFF the power to leave Calibration Mode.

9.6 Output Calibration

- The procedure for calibration when linear current output is selected is provided in this section.
- Output calibration is displayed after input calibration has been finished (i.e., after the input calibration values are registered). (Perform aging for at least 30 minutes.)

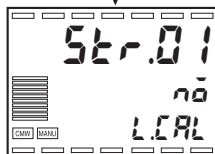
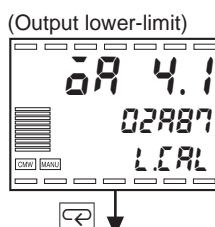
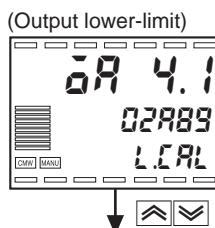
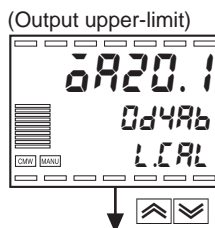
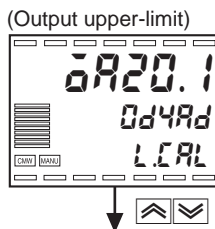
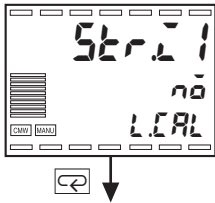

1. The registered input calibration value state is displayed as shown at left.
2. Connect a precision digital meter (DMM) to the output terminal of the linear current output as shown below.

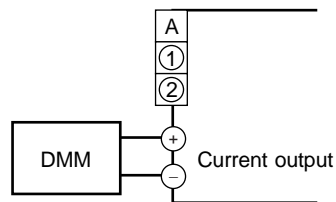

3. Press the Key. The display at left will appear and 20 mA calibration will begin.

4. While viewing the output on the DMM, use the and Keys to set the output to 20 mA. In the example at left, 20 mA is displayed at a value 2 digits smaller than before calibration.

5. Press the Key. The display at left will appear and 4 mA calibration will begin.

6. While viewing the output on the DMM, use the and Keys to set the output to 4 mA. In the example at left, 4 mA is displayed at a value 2 digits smaller than before calibration.

7. Press the Key. The display at the left will appear. This display will not appear if all of the required data has not been tentatively registered, or if the data has not been changed.
Press the Key. Display No. 2 will show **YES**. Two seconds after the Key is released or when the is pressed, the tentatively registered calibration data will be stored in EEPROM. If you do not wish to save the data in EEPROM, press the Key instead of the Key.

- If there is another output, connect the output as explained in step 2, and repeat steps 3 to 7.
8. Turn OFF the power to quit Calibration Mode.

9.7 Inspecting Indicator Accuracy

- After calibrating an input, always inspect the indicator accuracy to verify that the input was calibrated correctly.
- Operate the E5AR-T/ER-T in the PV/SP state.
- Check the indicator at three points: the upper limit, lower limit, and mid-range limit of the indicator range.

■ Thermocouples

● Preparations

Connect the required devices as shown below. Be sure to connect the E5AR-T/ER-T to the cold junction compensator using the compensating leads that you intend to use for the thermocouple.

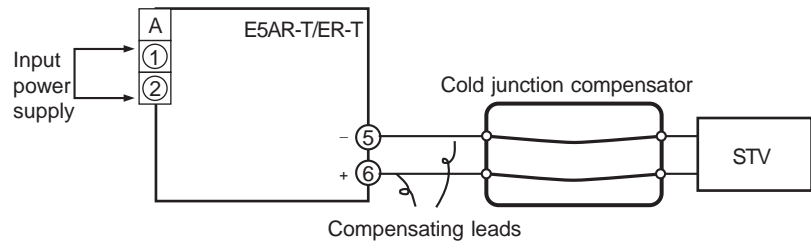

● Operation

Make sure that the cold junction compensator is at 0°C, and set the STV output to the voltage that is equivalent to the inspection value startup power.

If the cold junction compensating system uses an external setting, a cold junction compensator and compensating leads are not needed.

■ Resistance Thermometers

● Preparations

Connect the required devices as shown below.

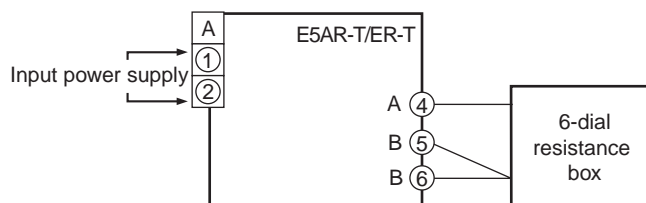

● Operation

Set the 6-dial resistance box to the resistance that is equivalent to the inspection value.

■ Analog Inputs

● Preparations

Connect the required devices as shown below.

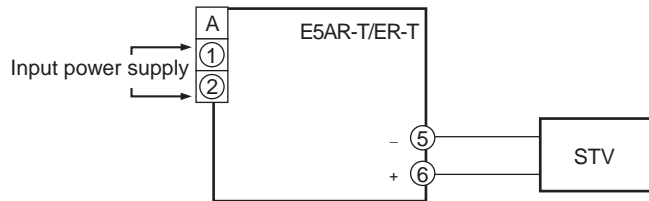

● Operation

Set the STV output to the inspection value voltage or current.

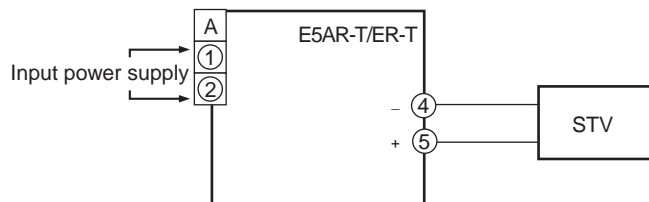

Section 10 Troubleshooting

10.1	Troubleshooting Checklist.....	10-2
10.2	Error Messages	10-3
10.3	Inferring Causes from Conditions: Abnormal Measured Values	10-5
10.4	Inferring Causes from Conditions: Abnormal Control	10-7
10.5	Inferring Causes from Conditions: Abnormal Outputs ...	10-10
10.6	Inferring Causes from Conditions: Communications Problems.....	10-11
10.7	Inferring Causes from Conditions: Reset Operation	10-12

10.1 Troubleshooting Checklist

If you encounter difficulty with the Controller, use the following checklist to troubleshoot the problem.

Check the display

Check the operating state of the E5AR-T/ER-T as indicated by the display.

Error messages and indicators are described in *10.2 Error Messages* (P. 10-3). If an error message is displayed, refer to this section to troubleshoot the problem.

Check switches and wiring

Check switch settings and wiring

- Power Supply
 - Is the power turned ON?
 - Is the terminal voltage within the specified range?
- Input Type Switch
 - Is the switch set to the correct setting for the sensor you are using?
- Wiring
 - Are the terminal connections correct?
 - Are the polarities correct?
 - Are any wires loose?
 - Are any wires or cables broken or not making contact?
- Communications Settings
 - Do the communications settings match those of the host system?

If you are unable to identify the problem from the above or cannot solve the problem, investigate in more detail.

Check parameters

- Are the parameters set correctly?
- Check for restrictions on the function you are using.
See if the cause of the problem lies in your settings.

Infer from conditions

If you were not able to identify the cause of the problem by checking the above, refer to the tables starting in *10.2 Error Messages* (P. 10-3).

10.2 Error Messages

When an error occurs, Displays No. 1 and 2 show error messages. Refer to the following table to check the meaning of the message and troubleshoot the problem.

Display No. 1	Display No. 2	Error	Correction	Output state at error	
				Control outputs	Alarm output
Unit	Err	Unit error	The unit requires servicing. Contact your OMRON representative.	OFF	OFF
Unit	CHG	Unit change		OFF	OFF
dLSP	Err	Display unit error		OFF	OFF
SYS	Err	Unit error		OFF	OFF
EEP	Err	EEPROM error	First, turn the power OFF then back ON again. If the display remains the same, hold down the <input type="checkbox"/> Key for at least 5 seconds in the error display to initialize. (See <i>Caution</i> .)	OFF	OFF
SErr	Normal display	Input error	Check for an incorrect input connection, broken wire, or short-circuit. Check the Input Type parameter and input type switch settings.	MV output according to MV at PV Error parameter.	Operation will be performed in the same way as when the upper limit is exceeded.
cccc	Normal display	Exceeded bottom of display range	Not an error. One of these messages is displayed when the PV exceeds the display range (–19999 to 99999).	Normal operation	Normal operation
bbbb		Exceeded top of display range			
Normal display	RSP operation indicator flashes	RSP input error	Is the wire connected to the RSP input broken or short-circuited? For coordinated operation, check the input type for the RSP input from channel 1 to be sure it's correct and check to see if the display range has been exceeded for the channel due to a SP offset setting.	MV at PV error	OFF
Normal display	-----	Potentiometer input error	Check the potentiometer wiring.	If the Closed/Floating parameter is set to "Closed" and the Operation at Potentiometer Input Error parameter is set to "OFF," the value set for the MV at PV Error parameter is output; otherwise, normal operation takes place.	Normal operation
ALb	Err	Motor calibration error	Check the wiring to the potentiometer and valve drive motor, and then try motor calibration again.	OFF	OFF
1-t 2-t 3-t 4-t	Set value flashes	Input type switch error	Set the input type switch to type of input you are using so that it agrees with the setting of the Input Type parameter.	OFF	OFF

If the system does not operate as expected after setting the parameters, check the wiring and set values once again. If there is still a problem, unintended set values may have been accidentally set in the parameters. In this case, you may want to initialize the Controller and redo your settings.

 **Caution**

Initializing the Controller will return all parameters to their default settings. The default settings may cause unexpected outputs, so disconnect all output wires and eliminate the effects to the system before initializing the parameters. In addition, write down your settings prior to initialization.

10.3 Inferring Causes from Conditions: Abnormal Measured Values

■ The Measured Value Is Abnormal or Measurement Is Not Possible

	Possible cause	Solution
Connections	The polarity or connections to the temperature sensor are not correct.	Connect the wires correctly.
	A temperature sensor that cannot be used with the E5AR-T/ER-T is connected.	Change to a temperature sensor that can be used with the E5AR-T/ER-T.
	The temperature sensor has a broken wire, a short-circuit, or has deteriorated.	Replace the temperature sensor.
	A temperature sensor is not connected.	Connect a temperature sensor.
	Compensating leads that are incompatible with the thermocouple are being used.	<ul style="list-style-type: none"> • Directly connect a thermocouple with long leads. • Use compatible compensating leads.
	A metal device other than the thermocouple or compensating leads is connected between the terminals of the E5AR-T/ER-T and thermocouple.	Connect with a device that is designed for use with thermocouples.
	The terminal connection screws are loose, resulting in a bad connection.	Tighten the screws securely.
	The leads or compensating leads of the thermocouple is too long and resistance is affecting the system.	<ul style="list-style-type: none"> • Use thick compensating leads. • Change the wiring and locations to allow shorter lengths.
	The 3 wires between the terminals of the E5AR-T/ER-T and the platinum resistance thermometer have different resistances.	Use wires of the same resistance for terminals A, B, and B.
Installation	The E5AR-T/ER-T is receiving noise from peripheral devices.	<ul style="list-style-type: none"> • Separate the E5AR-T/ER-T from noise-emitting devices. • Install a surge absorber or noise filter in noise-emitting devices.
	The leads and power line of the temperature sensor are too close, and induction noise is being received from the power line.	<ul style="list-style-type: none"> • Separate the leads from the power line. • Run the leads and power line through separate conduits or ducts. • Do not wire the leads in parallel with the power line. • Change the wiring to allow shorter leads. • Use shielded cable for the leads.
	The mounting location of the temperature sensor is too far from the point of control and the thermal response is slow.	Mount the sensor so that the end of the protective tubing approaches the point of control.
	The ambient operating temperature of the E5AR-T/ER-T exceeds the rated temperature.	Keep the ambient operating temperature within the specified range: -10 to 55°C.
	Wireless devices are used near the E5AR-T/ER-T.	Shield the E5AR-T/ER-T.
	The temperature of the terminal plate is not uniform due to heat dissipation from peripheral devices.	Install the E5AR-T/ER-T in a location where it is not exposed to heat dissipation.
	The terminal plate of the E5AR-T/ER-T is exposed to a strong air flow.	Prevent air flows from blowing on the terminal plate.
Settings	The input type switch setting is not correct.	Set the input type switch to the correct setting for the input.
	The Input Type parameter is not set correctly.	Set the correct input type.
	The temperature unit setting is not correct.	Set the correct temperature unit.
	The measured temperature appears to deviate after setting an input correction.	Set the input correction to 0.0.
	The units of the parameter settings are not correct.	Correct the host system program.
The host system program is not correct.		

	Possible cause	Solution
Method of use	The input terminals for thermocouple input are short-circuited.	Connect the thermocouple.
	A temperature sensor was replaced or a switch setting was changed while the power was ON.	Turn the power OFF and then ON.

Supplement

Simple Method for Checking Input

Platinum Resistance Thermometer:

- 1) Connect a 100 Ω resistor between input terminals A-B and short-circuit B-B.
- 2) If the measured temperature is approximately 0.0°C or 32.0°F, the E5AR-T/ER-T is operating normally.

Thermocouple:

- 1) Short-circuit the input terminals of the temperature sensor.
- 2) If the temperature close to the terminal plate is measured, the E5AR-T/ER-T is operating normally.

Analog Input:

Use a reference voltage/current generator (e.g., an STV) to supply the specified current or voltage and check the measurement.

10.4 Inferring Causes from Conditions: Abnormal Control

■ The PV Does Not Increase

	Possible cause	Solution
Connections	Abnormal measured value.	Troubleshoot as described in <i>10.3 Inferring Causes from Conditions: Abnormal Measured Values</i> (P. 10-5).
	A load is not connected to the control output terminals.	Connect a load.
	Incorrect load polarity or incorrect terminal connections.	Wire correctly.
	The terminal connection screws are loose, resulting in a bad connection.	Tighten the screws securely.
	The heater power is not turned ON.	Turn ON the heater power.
	The heater has a broken wire or has deteriorated.	Replace the heater.
	The heater has a low heat capacity.	<ul style="list-style-type: none"> • Change to a heater with a high heat capacity. • If using two or more heaters, replace any heaters that have broken wires.
	The overheating prevention device has activated.	Increase the temperature setting of the overheating prevention device to a value higher than the SP of the E5AR-T/ER-T.
Settings	Direct operation and reverse operation settings are incorrect.	Set the correct settings.
	The PID constants are not suitable.	<ul style="list-style-type: none"> • Execute AT. • Set suitable PID constants.
	Control has not been started.	Start control.
	The output does not increased due to MV limits.	Change the MV limits to suitable values.
	The cooling fan is running.	Stop the cooling fan.

■ The Measured Value Increases Above the SP

	Possible cause	Solution
Connections	Abnormal measured value.	Troubleshoot as described in <i>10.3 Inferring Causes from Conditions: Abnormal Measured Values</i> (P. 10-5).
	The load is connected to the wrong channel and the heater is being controlled by the control output of another channel.	Wire correctly.
	The contact of the control output drive relay has melted.	Replace the relay.
	Short-circuit failure in SSR.	Replace the SSR.
	Current flows to heater due to SSR leakage current.	Connect a bleeder resistor to prevent operation due to leakage current.

	Possible cause	Solution
Settings	Direct operation and reverse operation settings are incorrect.	Set the correct settings.
	The PID constants are not suitable.	<ul style="list-style-type: none"> • Execute AT. • Set suitable PID constants.
	The output does not decrease due to MV limits.	Change the MV limits to suitable values.
	Output is taking place in Manual Mode.	Leave Manual Mode.
Method of use	The controlled object generates heat.	Use heating/cooling control.
	Large overshoot.	See the <i>Overshooting or Undershooting Occurs</i> troubleshooting table.

■ Overshooting or Undershooting Occurs

	Possible cause	Solution
Connections	Abnormal measured value.	Troubleshoot as described in <i>10.3 Inferring Causes from Conditions: Abnormal Measured Values</i> (P. 10-5).
	A regular slow thermal response temperature sensor is connected to a fast thermal response control system.	Change to a sheathed temperature sensor.
Settings	The proportional band is too narrow, i.e., the P constant is too small.	<ul style="list-style-type: none"> • Increase the P constant to within the point where the response speed becomes too slow. • Execute AT.
	The integral time is too short, i.e., the I constant is too small.	<ul style="list-style-type: none"> • Increase the I constant to within the point where the response speed becomes too slow. • Execute AT.
	The derivative time is too short, i.e., the D constant is too small.	<ul style="list-style-type: none"> • Increase the D constant to within the point where stability during rectification deteriorates. • Execute AT.
	ON/OFF control is being performed.	Use P control or PID control.
	The control period is too long in a fast thermal response control system.	Shorten the control period.
	The overlap band is mistakenly set as a dead band in heating/cooling control.	Set an overlap band.

■ Hunting Occurs

Check connections and settings as explained above in *Overshooting or Undershooting Occurs*.

	Possible cause	Solution
Method of use	The heat capacity of the heater is too large for the heat capacity of the controlled object.	Use a heater with a heat capacity suitable for the controlled object.
	Periodic disturbances occur that cause the heat capacity of the controlled object to change.	Establish an environment with minimal disturbances.
	AT is being executed.	Hunting will stop when AT has been completed.

■ SP Does Not Change as Programmed

	Possible cause	Solution
Settings	Remote SP Mode or Fixed SP Mode is set.	Set Program SP Mode.

■ The Segment Does Not Advance

	Possible cause	Solution
Settings	The wait operation is enabled.	Set the Wait Mode, Wait Band Upper Limit, and Wait Band Lower Limit correctly.
	The SP is being held.	Check the HOLD indicator. If it is lit, change the Hold parameter to "OFF."

■ The Program Is Reset in the Middle

	Possible cause	Solution
Settings	The Number of Segments Used parameter is set to a smaller value than the final segment number.	Correct the setting of the Number of Segments Used parameter.

10.5 Inferring Causes from Conditions: Abnormal Outputs

■ No Control Output or No Alarm Output

	Possible cause	Solution
Connections	Abnormal temperature measurement.	See 10.3 <i>Inferring Causes from Conditions: Abnormal Measured Values</i> (P. 10-5).
	Incorrect load polarity or incorrect terminal connections.	Wire correctly.
	The connected load exceeds the output specifications.	<ul style="list-style-type: none"> Do not exceed the specifications. Repair in the event of a failure.
	A load power supply is not connected to a transistor output.	Use a power supply suitable for the output specifications and load.
	The polarity of the load power supply connected to the transistor output is incorrect.	Wire correctly.
Settings	Operation stops after the power is turned ON.	<ul style="list-style-type: none"> Send the Run command after turning ON the power. Set operation to continue at startup.
	Control has not been started.	Send the Run command.
	The wrong channel is specified.	Set the correct channel number.
	The wrong SP is set.	Set the correct SP.
	The wrong program number is set.	Set the correct program number
	When using event inputs to set the program number, the inputs are not held ON or OFF.	Keep the contacts ON or OFF to specify the program number.
	An attempt was made to use communications to set the program number when using event inputs were being used to set the program number.	The latest specification takes priority regardless of the program number specification method.
	The alarm mode is set to 0 (No Alarm).	Set the correct alarm mode.
	An alarm with a standby sequence is specified.	Specify an alarm without a standby sequence.
A deviation alarm is mistakenly set for an absolute-value alarm, or vice-versa.	Set the correct alarm mode.	

10.6 Inferring Causes from Conditions: Communications Problems

■ Cannot Communicate or No Response

	Possible causes	Solution
Communications conditions	The baud rate differs from the host system.	Make sure that the baud rates are the same.
	The communications settings are different from the host system.	Make sure that the communications settings are the same.
Connections	The number of parallel connections exceeds the specifications.	Do not exceed the specifications. • For RS-485, a maximum of 31 nodes can be connected.
	The length of the transmission path exceeds the specifications.	Do not exceed the specifications. • For RS-485, the total maximum length is 500 m.
	Another Controller has the same unit number.	Make sure each unit number is set only once.
	Noise is corrupting the communications data.	<ul style="list-style-type: none"> • Separate the communications cable from the noise source. • Use shielded communications cables. • Use an optical interface. • Have the program resend the command when a problem is detected in the response.
	Incorrect use of communications devices: • Optical interface • RS-232C/RS-485 converter	Check application methods in the instructions for each device.
	Incorrect installation of RS-485 terminators.	Install terminators only on the devices on the ends of the transmission path.
Program	Communications begin as soon as the power of the E5AR-T/ER-T is turned ON.	Wait at least 2 seconds before beginning communications after the power is turned ON.
	Unstable signals that occur when the E5AR-T/ER-T is turned ON or OFF are read as host system data.	Initialize the host system reception buffer at the following times: • Before sending the first command. • After the power of the E5AR-T/ER-T is turned OFF.
	The host system sends a command before receiving a response from the E5AR-T/ER-T.	Make sure that the program always reads the response after sending a command.
	The interval between receiving a response and sending the next command from the host system is too short.	Allow an interval of at least 5 ms after receiving a response before sending the next command.
	Mistake in host system program.	<ul style="list-style-type: none"> • Correct the program. • Check the command in a line monitor. • Try executing a sample program.
Settings	The unit number setting is different from the unit number specified in the command.	Make sure the unit numbers match.

10.7 Inferring Causes from Conditions: Reset Operation

■ Outputs Are Made While Resetting (Operation Will Not Stop)

	Possible cause	Solution
Settings	The MV at Reset parameter (Adjustment Level) is set to a value greater than 0%.	Set the MV at Reset parameter to 0.0.
	Manual Mode is in effect.	Set the manual output to 0% or switch to Auto Mode.
	The Operation at Reset parameter (Control Initial Setting Mode) is set to "Fixed Control."	Set the Operation at Reset parameter to "Stop Control."

Appendix

Specifications.....	A-2
Sensor Input Setting Ranges and Display/Control Ranges	A-4
ASCII Table	A-5
Setting Lists	A-6
Parameter Charts.....	A-48

Specifications

■ Unit Ratings

Power supply voltage for CE marking (See note 1.)		100 to 240 VAC, 50/60 Hz	24 VAC, 50/60 Hz or 24 VDC
Power supply voltage for UL certification (See note 1.)		100 to 120 VAC, 50/60 Hz	24 VAC, 50/60 Hz or 24 VDC
Allowable voltage fluctuation range		85% to 110% of rated voltage	
Power consumption		E5AR-T: 22 VA max. E5ER-T: 17 VA max.	E5AR-T: 15 VA/10 W max. E5ER-T: 11 VA/7 W max.
Sensor inputs (See note 2.)		Thermocouples: K, J, T, E, L, U, N, R, S, B, W Platinum resistance thermometers: Pt100 Current input: 4 to 20 mA DC or 0 to 20 mA DC (including remote SP input) Voltage input: 1 to 5 VDC, 0 to 5 VDC, or 0 to 10 VDC (including remote SP input) (Input impedance: 150 Ω using current input, approx. 1 MΩ using voltage input)	
Control outputs	Voltage outputs (for driving SSRs)	12 VDC, 40 mA max. (See note 3.), with short-circuit protection circuit	
	Current outputs	0 to 20 mA DC or 4 to 20 mA DC, load: 500 Ω max. (including transfer output) (Resolution: Approx. 54,000 at 0 to 20 mA DC, approx. 43,000 at 4 to 20 mA DC)	
	Relay outputs	Position-proportional Control Model (open, close) SPST-NO, 250 VAC, 1 A (including inrush current) (inductive load), electrical life: approx. 100,000 operations	
Auxiliary outputs	Relay outputs	SPST-NO, 250 VAC, 1 A (resistive load), electrical life: approx. 100,000 operations	
	Transistor outputs	Maximum load voltage: 30 VDC, maximum load current: 50 mA Residual voltage: 1.5 V max., leakage current: 0.4 mA max.	
Event inputs	Contact inputs	Input ON: 1 kΩ max., OFF: 100 kΩ max.	
	Non-contact inputs	Input ON: Residual voltage of 1.5 V max., input OFF: Leakage current of 0.1 mA max.	
		Short-circuit current: Approx. 4 mA	
Remote SP input		See <i>Sensor inputs</i> .	
Potentiometer input		100 Ω to 2.5 kΩ	
Transfer output		See <i>Control outputs</i> .	
Control method		2-PID or ON/OFF	
Setting method		Digital setting using front panel keys or setting via serial communications	
Indication method		7-segment digital display and LED indicators E5AR-T character height: PV: 12.8 mm, SV: 7.7 mm, PRG.SEG: 7.7 mm E5ER-T character height: PV: 9.5 mm, SV: 7.2 mm, PRG.SEG: 7.2 mm	
Other functions		Varies by model.	
Ambient operating temperature		-10 to 55°C (no condensation or icing), 3-year warranty: -10 to 50°C	
Ambient operating humidity		25% to 85%	
Storage temperature		-25 to 65°C (no condensation or icing)	

Note 1. 100 to 240 VAC and 24 VAC/VDC are on different models. Please specify the desired model when ordering.

2. Multi-inputs. Switch between temperature and analog input using the input type switch.
Basic insulation between power supply and input terminals and between power supply and output terminals.

3. Voltage outputs for the E5AR-TQQ□□□WW-□□□ are 21 mA max.

■ Controller Performance Specifications

Indication accuracy	Thermocouple input: ($\pm 0.1\%$ of indicated value or $\pm 1^\circ\text{C}$, whichever is greater) ± 1 digit max. (See note 1.) [Not using internal cold junction compensation] ($\pm 0.1\%$ of indicated value or $\pm 1^\circ\text{C}$, whichever is smaller) ± 1 digit max. (See note 2.) Analog input: (0.1% FS) ± 1 digit max. Platinum resistance temperature sensor input: ($\pm 0.1\%$ of indicated value or $\pm 0.5^\circ\text{C}$, whichever is greater) ± 1 digit max. Position-proportional potentiometer input: ($\pm 5\%$ FS) ± 1 digit max.	
Temperature variation influence (See note 3.)	R, S, B, or W thermocouple input: ($\pm 1\%$ of PV or $\pm 10^\circ\text{C}$, whichever is greater) ± 1 digit max. Other thermocouple input: ($\pm 1\%$ of PV or $\pm 4^\circ\text{C}$, whichever is greater) ± 1 digit max. *K thermocouple at -100°C max: $\pm 10^\circ\text{C}$ max.	
Voltage variation influence (See note 3.)	Platinum resistance thermometer: ($\pm 1\%$ of PV or $\pm 2^\circ\text{C}$, whichever is greater) ± 1 digit max. Analog input: ($\pm 1\%$ FS) ± 1 digit max.	
Control mode	Standard Control (Heating Control or Cooling Control), Heating/cooling Control Standard Control with Remote SP (Models with 2 Input Channels only) Heating/Cooling Control with Remote SP (Models with 2 Input Channels only) Cascade Standard Control (Models with 2 Input Channels only) Cascade Heating/Cooling Control (Models with 2 Input Channels only) Proportional Control (Models with 2 Input Channels only) Position-proportional Control (Position-proportional Control Model only)	
Control period	0.2 to 99.0 s (increments of 0.1 seconds): During time-divided proportional control output	
Proportional band (P)	0.00% to 999.99% FS (increments of 0.01% FS)	
Integral time (I)	0.0% to 3999.9 s (increments of 0.1 second)	
Derivative time (D)	0.0% to 3999.9 s (increments of 0.1 second)	
Hysteresis	0.01% to 99.99% FS (increments of 0.01% FS)	
Manual reset value	0.0% to 100.0% (increments of 0.1% FS)	
Alarm setting range	-19999 to 99999^4 (Decimal point position depends on input type and decimal point position setting)	
Input sampling period	50 ms	
Insulation resistance	20 M Ω or higher (at 500 VDC)	
Voltage resistance	2,000 VAC 50/60 Hz 1 min (charged terminals of different polarity)	
Vibration resistance	Vibration frequency: 10 to 55 Hz Acceleration: 20 m/s ²	
Shock resistance	150 m/s ² (relay contacts: 100 m/s ²) 3 times each on 3 axes and in 6 directions	
Inrush current	100 to 240 VAC Model: 50 A max. 24 VAC/VDC Model: 30 A max.	
Weight	E5AR-T	Approx. 450 g (Controller only), Fittings: Approx. 60 g, Terminal cover: Approx. 30 g
	E5ER-T	Approx. 330 g (Controller only), Fittings: Approx. 60 g, Terminal cover: Approx. 16 g
Degree of protection	Front: NEMA4X indoor, rear case: IP20, terminal plate: IP00	
Memory protection	EEPROM (Write count: 100,000 times)	

Note 1. K, T, N at -100°C max.: $\pm 2^\circ\text{C} \pm 1$ digit max.
 U and L: $\pm 2^\circ\text{C} \pm 1$ digit max.
 B at 400°C max. is not specified.
 R and S at 200°C max.: $\pm 3^\circ\text{C} \pm 1$ max.
 W: (Larger of $\pm 0.3\%$ PV and $\pm 3^\circ\text{C}$) ± 1 digit max.

- U and L: $\pm 1^\circ\text{C} \pm 1$ digit
 R and S at 200°C max.: $\pm 1.5^\circ\text{C} \pm 1$ digit
- Ambient temperature: -10°C to 23°C to 55°C
 Voltage range: -15% to $+10\%$ of rated voltage
- EU stands for Engineering Unit and is the unit after scaling. For a temperature sensor, it is $^\circ\text{C}$ or $^\circ\text{F}$.

Sensor Input Setting Ranges and Display/Control Ranges

Input type	Specification	Setting	Input setting range		Display/control range	
			°C	°F	°C	°F
Platinum resistance temperature sensor	Pt100	0	-200.0 to 850.0	-300.0 to 1500.0	-305.0 to 955.0	-480.0 to 1680.0
	Pt100	1	-150.00 to 150.00	-199.99 to 300.00	-180.00 to 180.00	-249.99 to 350.00
Thermocouple	K	2	-200.0 to 1300.0	-300.0 to 2300.0	-350.0 to 1450.0	-560.0 to 2560.0
	K	3	-20.0 to 500.0	0.0 to 900.0	-72.0 to 552.0	-90.0 to 990.0
	J	4	-100.0 to 850.0	-100.0 to 1500.0	-195.0 to 945.0	-260.0 to 1660.0
	J	5	-20.0 to 400.0	0.0 to 750.0	-62.0 to 442.0	-75.0 to 825.0
	T	6	-200.0 to 400.0	-300.0 to 700.0	-260.0 to 460.0	-400.0 to 800.0
	E	7	0.0 to 600.0	0.0 to 1,100.0	-60.0 to 660.0	-110.0 to 1210.0
	L	8	-100.0 to 850.0	-100.0 to 1,500.0	-195.0 to 945.0	-260.0 to 1660.0
	U	9	-200.0 to 400.0	-300.0 to 700.0	-260.0 to 460.0	-400.0 to 800.0
	N	10	-200.0 to 1,300.0	-300.0 to 2,300.0	-350.0 to 1,450.0	-560.0 to 2,560.0
	R	11	0.0 to 1,700.0	0.0 to 3,000.0	-170.0 to 1,870.0	-300.0 to 3,300.0
	S	12	0.0 to 1,700.0	0.0 to 3,000.0	-170.0 to 1,870.0	-300.0 to 3,300.0
	B	13	100.0 to 1,800.0	300.0 to 3,200.0	-70.0 to 1,970.0	-10.0 to 3,490.0
W	14	0.0 to 2,300.0	0.0 to 4,100.0	-230.0 to 2,530.0	-410.0 to 4,510.0	
Analog	4 to 20 mA 0 to 20 mA 1 to 5 V 0 to 5 V 0 to 10 V	15 16 17 18 19	One of following ranges depending on scaling: -19,999 to 99,999 -1,999.9 to 9,999.9 -199.99 to 999.99 -19.999 to 99.999 -1.9999 to 9.9999		-10% to 110% of setting range Maximum range: -19,999 to 99,999	

- Applicable input type standards are as follows:
K, J, T, E, N, R, S, B: JIS C1602-1995
L: Fe-CuNi, DIN 43710-1985
U: Cu-CuNi, DIN 43710-1985
W: W5Re/W26Re, ASTM E988-1990
Pt100: JIS C1604-1997, ICE751

ASCII Table

Upper Lower	0	1	2	3	4	5	6	7
0	NUL	DLE	SPACE	0	@	P	`	p
1	SOH	DC1	!	1	A	Q	a	q
2	STX	DC2	“	2	B	R	b	r
3	ETX	DC3	#	3	C	S	c	s
4	EOT	DC4	\$	4	D	T	d	t
5	ENQ	NAK	%	5	E	U	e	u
6	ACK	SYN	&	6	F	V	f	v
7	BEL	ETB	‘	7	G	W	g	w
8	BS	CAN	(8	H	X	h	x
9	HT	EM)	9	I	Y	i	y
A	LF	SUB	*	:	J	Z	j	z
B	VT	ESC	+	;	K	[k	{
C	FF	FS	,	<	L	¥	l	
D	CR	GS	-	=	M]	m	}
E	SO	RS	.	>	N	^	n	~
F	SI	US	/	?	O	_	o	DEL

Setting Lists

The setting lists give the addresses for CompoWay/F communications and Modbus communications. Refer to the addresses of the protocol that you are using.

The hexadecimal values in the *Setting/monitor value* column are the setting ranges in CompoWay/F and Modbus communications, and the values in parentheses () are the actual setting ranges.

Monitor and set values can be specified for each channel. Addresses include a channel identifier. The addresses in the variable area maps are for channel 1. To specify addresses of other channels on a Controller with more than one input channel, refer to the table below.

Channel	Address	
	CompoWay/F	Modbus
1	Address in setting list	Address in setting list
2	Address in setting list + 0100	Address in setting list + 4000
3	Address in setting list + 0200	Address in setting list + 8000
4	Address in setting list + 0300	Address in setting list + C000

Communications Monitor Settings (C0 to C1)

Setting/monitor values prefixed by "H" are for setting and monitoring via communications.

CompoWay/F Variable type	Modbus Address	Parameter	Attribute	Display	Setting/monitor range	Display	Default setting	Decimal point position	Unit
C0	0000	Present Value (PV)	CH	—	According to specified input range	—	—	According to input type	EU
	0001	Status	CH	—	Refer to following section.	—	—	—	—
	0002	SP	CH	—	SP Lower Limit to SP Upper Limit	—	—	According to input type	EU
	0004	MV Monitor (Heating)	CH	—	Standard: H'FFFFFFCE to H'0000041A (-5.0 to 105.0) Heating/cooling: H'00000000 to H'0000041A (0.0 to 105.0)	-5.0 to 105.0 0.0 to 105.0	—	1	%
C1	0005	MV Monitor (Cooling)	CH	—	H'00000000 to H'0000041A (0.0 to 105.0)	0.0 to 105.0	—	1	%
	0003	Present Set Point	CH	—	SP Lower Limit to SP Upper Limit	—	0	According to input type	EU
	0004	Alarm Set 1 Alarm Value 1	CH	!RL - 1	H'FFFFFFB1E1 to H'0001869F (-19999 to 99999)	-19999 to 99999	0	According to input type	EU
	0005	Alarm Set 1 Alarm Upper Limit 1	CH	!RL H	H'FFFFFFB1E1 to H'0001869F (-19999 to 99999)	-19999 to 99999	0	According to input type	EU
	0006	Alarm Set 1 Alarm Lower Limit 1	CH	!RL L	H'FFFFFFB1E1 to H'0001869F (-19999 to 99999)	-19999 to 99999	0	According to input type	EU
	0007	Alarm Set 1 Alarm Value 2	CH	!RL - 2	H'FFFFFFB1E1 to H'0001869F (-19999 to 99999)	-19999 to 99999	0	According to input type	EU
	0008	Alarm Set 1 Alarm Upper Limit 2	CH	!RL 2H	H'FFFFFFB1E1 to H'0001869F (-19999 to 99999)	-19999 to 99999	0	According to input type	EU
	0009	Alarm Set 1 Alarm Lower Limit 2	CH	!RL 2L	H'FFFFFFB1E1 to H'0001869F (-19999 to 99999)	-19999 to 99999	0	According to input type	EU

■ E5□R-T Status (Communications)

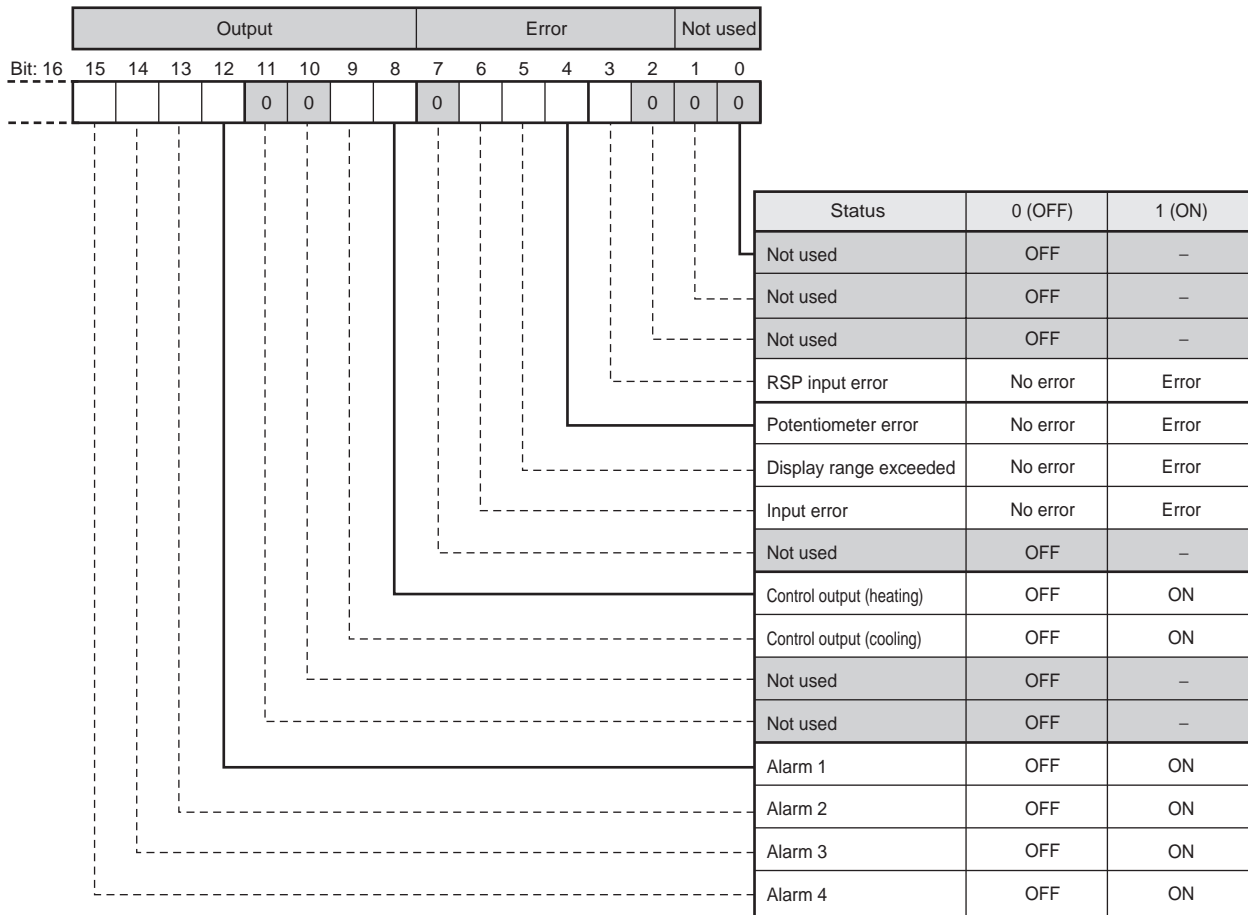

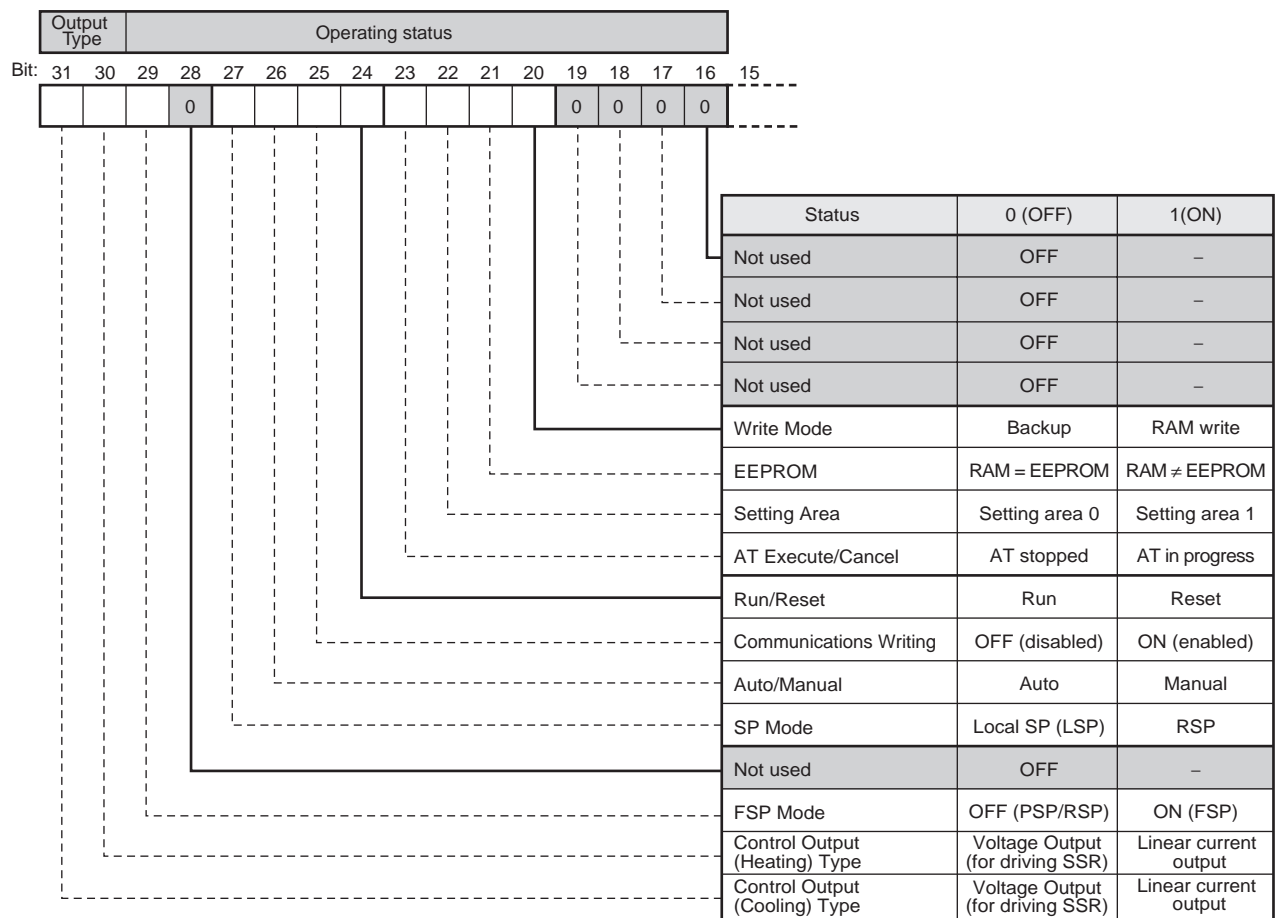

Note 1. Status is as follows when reading from setting area 1:

- RSP input error: Cleared
 - Potentiometer error: Cleared
 - Display range exceeded: Cleared
 - Input error: Cleared
 - Control output (heating), control output (cooling): Cleared
 - Alarm 1, Alarm 2, Alarm 3, Alarm 4: Cleared
 - AT: Cleared
 - Run/Reset: ON (Reset)
 - Auto/Manual: Previous value held
 - SP mode, MV tracking: Updated
 - Control output (heating) type, control output (cooling) type: Updated
2. If the FSP Mode is set to "ON," the SP Mode parameter setting (RSP/RSP) is ignored. If the FSP Mode is set to "OFF," the SP Mode parameter setting (RSP/RSP) is valid and the Program SP Mode and Remote SP Mode can be used as required.
 3. The control output (heating) status and control output (cooling) status are the open output status and close output status, respectively, during position-proportional control.
 4. The control output (heating) status and control output (cooling) status are OFF during linear output.
 5. The control output (heating) type status and control output (cooling) type status are OFF when the corresponding output is a voltage output (for driving SSR).

■ E5□R-T Program Status (Communications)

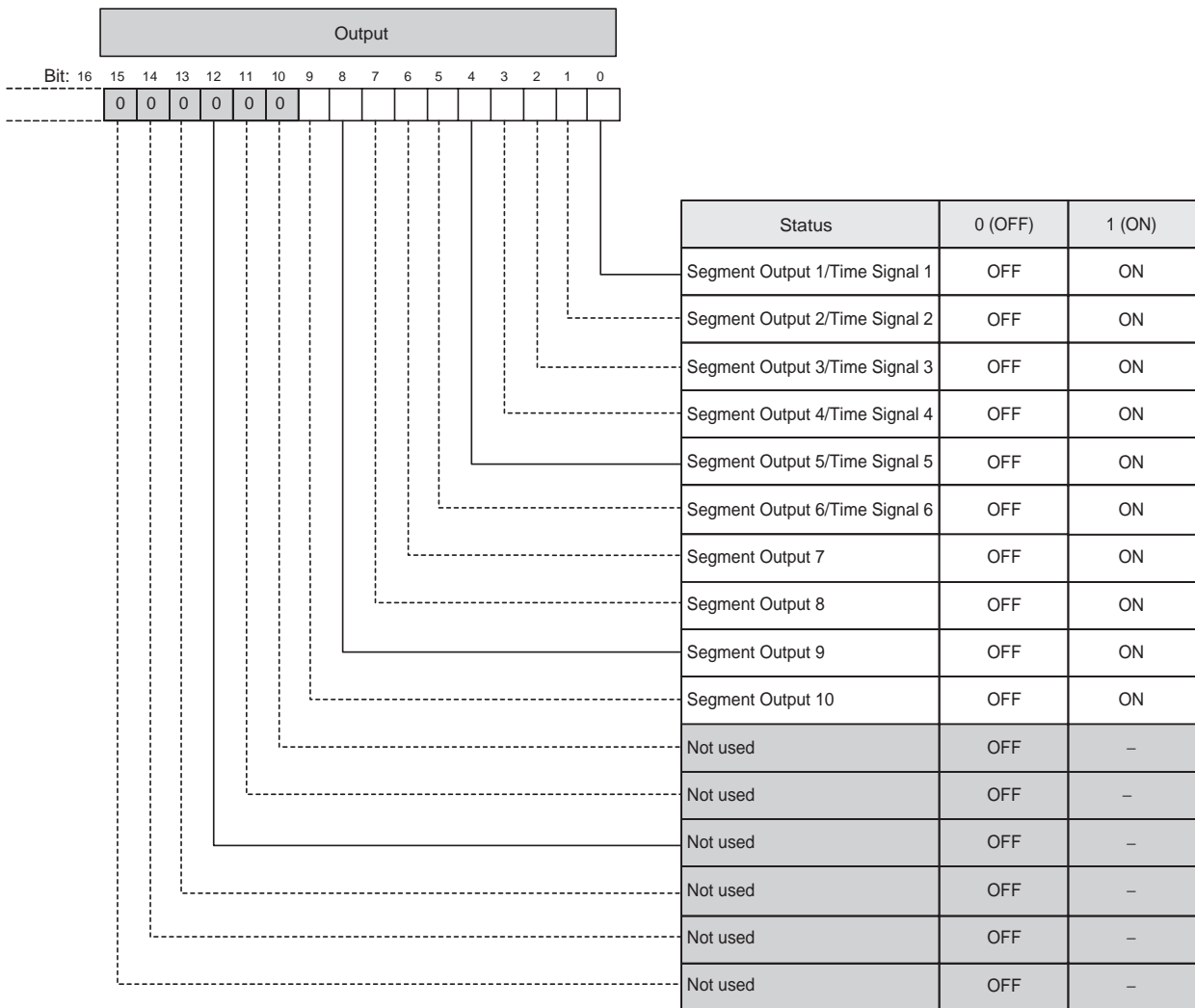

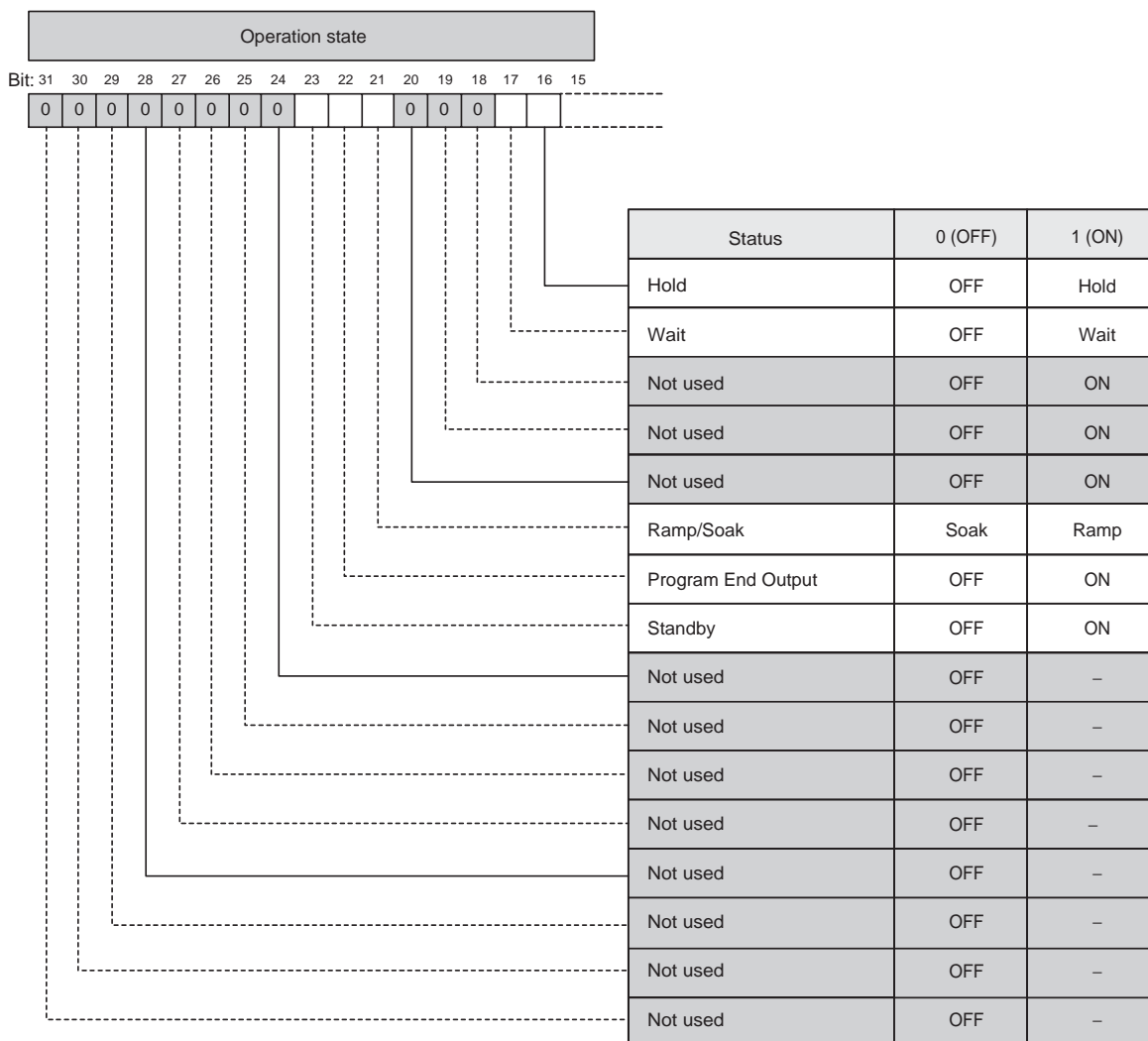

Note 1. Status is as follows when reading from setting area 1:

- Segment Outputs 1 to 10 and Time Signals 1 to 6: Cleared
 - Hold and Wait: Clear
 - Program End Output: Previous value held
 - Standby: Clear
2. Segment Outputs 1 to 10 and Time Signals 1 to 6 status depend on the setting of the Program Output Selection parameter.
 3. The Program End Output status will be ON when the display shows *P.End.*

Communications Monitor (C4)

Setting/monitor values prefixed by "H" are for setting and monitoring via communications.

CompoWay/F Variable type Address	Modbus Address	Parameter	Attrib- ute	Display	Setting/monitor range	Display	Default setting	Decimal point position	Unit
C4	0000	Version	Com- mon	—	H'00000000 to H'FFFFFFF*1	—	—	—	—
	0001	Modified Type	Com- mon	—	H'00000000 to H'FFFFFFF	—	—	—	—
	0002	Present Value (PV)	CH	—	According to specified input range	—	—	According to input type	EU
	0003	Present Set Point	CH	—	SP Lower Limit to SP Upper Limit	—	—	According to input type	EU
	0005	PID Set Number Monitor	CH	—	H'00000001 to H'00000008 (1 to 8)	1 to 8	—	—	—
	0006	Status	CH	—	Refer to previous section.	—	—	—	—
	0007	Program Status	CH	—	Refer to previous section.	—	—	—	—
	0008	Alarm Set Number Monitor	CH	—	H'00000001 to H'00000004 (1 to 4)	1 to 4	—	—	—

*1 00000123 for Ver. 1.23

Protect Level

Setting/monitor values prefixed by "H" are for setting and monitoring via communications.

CompoWay/F Variable type Address	Modbus Address	Parameter	Attrib- ute	Display	Setting/monitor range	Display	Default setting	Decimal point position	Unit	Set value
C5	0000	Operation Adjustment Protection	Com- mon	OPPL	H'00000000 to H'00000004 (0 to 4)	0 to 4	0	-	-	
	0001	Initial Setting Protection	Com- mon	ISPL	H'00000000 to H'00000002 (0 to 2)	0 to 2	0	-	-	
	0002	Setting Change Protection	Com- mon	SCPL	H'00000000: OFF (0) H'00000001: ON (1)	OFF, ON	OFF	-	-	
	0003	PF Key Protection	Com- mon	PFPL	H'00000000: OFF (0) H'00000001: ON (1)	OFF, ON	OFF	-	-	

Operation Level

Variable type	CompoWay/F Address	Modbus Address	Parameter	Attribute	Display	Setting/monitor range	Display	Default setting	Decimal point position	Unit	Set value
C6	-	-	PV	CH	-	Specified range of sensor input	-	-	*1	EU	
	0000	0600	Manual MV*2	CH	-	Standard: H'FFFFFFCE to H'0000041A (-5.0 to 105.0) Heat/cooling: H'FFFFFFBE6 to H'0000041A (-105.0 to 105.0) Position-proportional: -10.0 to 110.0	-5.0 to 105.0 - 105.0 to 105.0 - 10.0 to 110.0	-	1	%	
	0001	0602	SP*3	CH	-	SP Lower Limit to SP Upper Limit	Same as at left	0	According to input type	EU	
	0008	0610	Program No.	CH	P-r-L	H'00000001 to H'00000020 (1 to 32)*4	1 to 32*4	1	-	-	
	0009	0612	Segment No. Monitor	CH	-	H'00000001 (1) to Number of Segments Used	-	-	-	-	
	-	-	Hold	CH	HöLd	OFF, ON	öFF, öh	OFF	-	-	-
	-	-	Advance	CH	Adw	OFF, ON	öFF, öh	OFF	-	-	-
	-	-	Back	CH	bREw	OFF, ON	öFF, öh	OFF	-	-	-
	000A	0614	Remaining Standby Time Monitor	CH	SEbñ	H'00000000 to H'000026E7 (0.00 to 99.59)	0.00 to 99.59	-	2	hh:mm	
	000B	0616	Elapsed Program Time Monitor	CH	P-r-L	H'00000000 to H'000026E7(0.00 to 99.59) or H'00000000 to H'0001850F(0.00.0 to 99.59.9)	0.00 to 99.59 or 00.00 to 99.59.9	-	According to program unit		
	000C	0618	Elapsed Segment Time Monitor	CH	SEEL	H'00000000 to H'000026E7(0.00 to 99.59) or H'00000000 to H'0001850F(0.00.0 to 99.59.9)	0.00 to 99.59 or 00.00 to 99.59.9	-	According to program unit		
	000D	061A	Remaining Segment Time Monitor	CH	SEELr	H'00000000 to H'000026E7(0.00 to 99.59) or H'00000000 to H'0001850F(0.00.0 to 99.59.9)	0.00 to 99.59 or 00.00 to 99.59.9	-	According to program unit		
	000E	061C	Program Execution Repetition Monitor	CH	rPEñ	H'00000000 to H'0000270F (0 to 9999)	0.00 to 99.999	-	-	times	
	0002	0604	Remote SP Monitor	CH	r-SP	Remote SP Lower Limit to Remote SP Upper Limit*5	Same as at left	-	According to input type	EU	
	0005	060A	MV Monitor (Heating)	CH	ö	H'FFFFFFCE to H'00000041A (-5.0 to 105.0)	-5.0 to 105.0 0.0 to 105.0	-	1	%	
	0006	060C	MV Monitor (Cooling)	CH	ö-a	H'00000000 to H'00000041A (0.0 to 105.0)	0.0 to 105.0	-	1	%	
0007	060E	Valve Opening Monitor	CH	w-ñ	H'FFFFFF9C to H'00000044C (-10.0 to 110.0)	- 10.0 to 110.0	-	1	%		
-	-	Run/Reset	CH	r-r	RUN, RST	r-ñ, r-ñ	RST	-	-	-	
-	-	Auto/Manual	CH	R-r	AUTO, MANU	R-ñ, r-ñ	AUTO	-	-	-	

*1 ... Determined by Input Type and PV Decimal Point Display parameter settings.
 *2 ... When using position-proportional control, change is possible only from HMI.
 *3 ... Communications can be used only to monitor the present set point.
 *4 ... Depends on the number of inputs and the settings of the Control Mode, Independent Operation/Coordinated Operation, and Number of Segments parameters.
 *5 ... SP limits are in effect.

Program Setting Level

Setting/monitor values prefixed by "H" are for setting and monitoring via communications.

CompoWay/F Variable type	Modbus Address	Parameter	Attribute	Display	Setting/monitor range	Display	Default setting	Decimal point position	Unit	Set value
D8	0000	Program Editing*1	CH	PrLn	H'00000001 to H'00000020 (1 to 32)*2	i to 32 *2	*3	-	-	-
	0001	Number of Segments Used	CH	5-nā	H'00000001 (1) to Number of Segments	Same as at left	8	-	-	-
	0002	Segment Editing*4	CH	SELn	H'00000000 (0) to Number of Segments Used (0:END)	Same as at left	END (0)	-	-	-
	0010	Segment Set Point	CH	SP	SP Lower Limit to SP Upper Limit	Same as at left	0	According to input type	EU	-
	0011	Segment Rate of Rise	CH	Pr	H'00000000 to H'0001869F (0 to 99999)	0 to 99999	0	According to input type	EU	-
	0012	Segment Time	CH	L-nE	H'00000000 to H'000026E7(0.00 to 99.59) or H'00000000 to H'0001850F(0.00.0 to 99.59.9)	0.00 to 99.59 or 0.00.0 to 99.59.9	0.00	According to program time unit	-	-
	0013	Wait	CH	WnLk	H'00000000: OFF (0) H'00000001: ON (1)	OFF, ān	OFF	-	-	-
	0014	Segment Output 1	CH	SEā.1	H'00000000: OFF (0) H'00000001: ON (1)	OFF, ān	OFF	-	-	-
	0015	Segment Output 2	CH	SEā.2	H'00000000: OFF (0) H'00000001: ON (1)	OFF, ān	OFF	-	-	-
	0016	Segment Output 3	CH	SEā.3	H'00000000: OFF (0) H'00000001: ON (1)	OFF, ān	OFF	-	-	-
	0017	Segment Output 4	CH	SEā.4	H'00000000: OFF (0) H'00000001: ON (1)	OFF, ān	OFF	-	-	-
	0018	Segment Output 5	CH	SEā.5	H'00000000: OFF (0) H'00000001: ON (1)	OFF, ān	OFF	-	-	-
	0019	Segment Output 6	CH	SEā.6	H'00000000: OFF (0) H'00000001: ON (1)	OFF, ān	OFF	-	-	-
	001A	Segment Output 7	CH	SEā.7	H'00000000: OFF (0) H'00000001: ON (1)	OFF, ān	OFF	-	-	-
	001B	Segment Output 8	CH	SEā.8	H'00000000: OFF (0) H'00000001: ON (1)	OFF, ān	OFF	-	-	-
	001C	Segment Output 9	CH	SEā.9	H'00000000: OFF (0) H'00000001: ON (1)	OFF, ān	OFF	-	-	-
001D	Segment Output 10	CH	SEā.10	H'00000000: OFF (0) H'00000001: ON (1)	OFF, ān	OFF	-	-	-	
0003	PID Set Number*5	CH	PnLd	H'00000000 to H'00000008 (0 to 8) (0:Automatic)	0 to 8	0	-	-	-	
0004	Alarm Set Number*5	CH	RnLn	H'00000001 to H'00000004 (1 to 4)	i to 4	1	-	-	-	
0005	Wait Band Upper Limit	CH	Wn-bH	H'00000000 to H'0001869F (0 to 99999 (0: OFF))	0 to 99999	0	According to input type	EU	-	
0006	Wait Band Lower Limit	CH	Wn-bL	H'00000000 to H'0001869F (0 to 99999 (0: OFF))	0 to 99999	0	According to input type	EU	-	
0007	Program Repetitions	CH	rPL	H'00000000 to H'0000270F (0 to 9999)	0 to 9999	0	-	-	times	
0008	Program Link Destination	CH	L-nP	H'00000000 to H'0000020F (0 to 32 (0:No Link))*2	0 to 32 *2	0	-	-	-	

Variable type	CompoWay/F Address	Modbus Address	Parameter	Attribute	Display	Setting/monitor range	Display	Default setting	Decimal point position	Unit	Set value
D8	0009	1812	PID Set Number*6	CH	P.L.d	H100000000 to H1000000008 (0 to 8 (0: Link))	0 to 8	0	-	-	
	000A	1814	Alarm Set Number*6	CH	R.L.r	H100000000 to H1000000004 (0 to 4 (0: Link))	0 to 4	0	-	-	

- *1 Set the program number in the Program Editing parameter before setting parameters for individual programs.
- *2 Depends on the number of inputs and the settings of the Control Mode, Independent Operation/Coordinated Operation, and Number of Segments parameters.
- *3 The currently selected program number.
- *4 Set the segment number in the Segment Editing parameter before setting parameters for individual segments.
- *5 Addresses are different for channels 2 to 4 for coordinated operation and channel 2 (secondary side) for cascade control.
- *6 For channels 2 to 4 for coordinated operation and channel 2 (secondary side) for cascade control.
- *7 Use channel 1 when setting program data for coordinated operation or cascade control, except for PID set numbers and alarm set numbers.

Adjustment Level

Setting/monitor values prefixed by "H" are for setting and monitoring via communications.

CompoWay/F Variable type	Modbus Address	Parameter	Attribute	Display	Setting/monitor value	Display	Default setting	Decimal point position	Unit	Set value
C7	-	AT Execute/Cancel	CH	RL	OFF, 0 to 8	0FF, 0 to 8	OFF	-	-	
	-	Communications Writing	Common	LnLk	OFF, ON	0FF, 0n	OFF	-	-	
	-	SP Mode	CH	SPMd	PSP, RSP, FSP	PSP, rSP, FSP	PSP*1	-	-	
	0023	Fixed SP	CH	FSP	SP Lower Limit to SP Upper Limit	Same as at left	0	According to input type	EU	
	0000	Cooling Coefficient	CH	C-Sc	H00000001 to H0000270F (0.01 to 99.99)	00.1 to 99.99	1.00	2	-	
	0004	Dead Band	CH	C-dB	HFFFFF831 to H0000270F (-19.99 to 99.99)	-19.99 to 99.99	0.00	2	%FS	
	0005	Manual Reset Value	CH	MR-r	H00000000 to H000003E8 (0.0 to 100.0)	00 to 100.0	50.0	1	%	
	0006	Hysteresis (Heating)	CH	HYS	H00000001 to H0000270F (0.01 to 99.99)	00.1 to 99.99	0.10	2	%FS	
	0007	Hysteresis (Cooling)	CH	C-HYS	H00000001 to H0000270F (0.01 to 99.99)	00.1 to 99.99	0.10	2	%FS	
	0008	Control Period (Heating)	CH	CP	H00000002 to H000003DE (0.2 to 99.0)	0.2 to 99.0	20.0	1	Seconds	
	0009	Control Period (Cooling)	CH	C-CP	H00000002 to H000003DE (0.2 to 99.0)	0.2 to 99.0	20.0	1	Seconds	
	000A	Position Proportional Dead Band	CH	db	H00000001 to H00000064 (0.1 to 10.0)	0.1 to 10.0	2.0	1	%	
	000B	Open/Close Hysteresis	CH	oc-H	H00000001 to H000000C8 (0.1 to 20.0)	0.1 to 20.0	0.8	1	%	
	0024	Standby Time	CH	Stb	H00000000 to H000026E7 (0.00 to 99.59)	000 to 99.59	0.00	2	hh.mm	
	000F	MV at Reset (Standard/Heating/Cooling)	CH	MV-r	Standard: HFFFFFFFCE to H0000041A (-5.0 to 105.0) Heating/cooling: HFFFFFFBE6 to H0000041A (-105.0 to 105.0)	000 to 105.0 -5.0 to 105.0 -105.0 to 105.0	0.0	1	%	
	0010	MV at Reset (Position Proportional)	CH	MV-r	HFFFFFFF: -1 (closed) H00000000: 0 (hold) H00000001: 1 (open)	-1, 0, 1	0	-	-	
	0011	MV at PV Error (Standard/Heating/Cooling)	CH	MV-E	Standard: HFFFFFFFCE to H0000041A (-5.0 to 105.0) Heating/cooling: HFFFFFFBE6 to H0000041A (-105.0 to 105.0)	-5.0 to 105.0 -105.0 to 105.0	0.0	1	%	
	0012	MV at PV Error (Position Proportional)	CH	MV-E	HFFFFFFF: -1 (closed) H00000000: 0 (hold) H00000001: 1 (open)	-1, 0, 1	0	-	-	
	0013	MV Change Rate Limit (Heating)	CH	CR-L	H00000000 to H000003E8 (0.0 to 100.0 (0.0: Limiter disabled))	00 to 100.0	0.0	1	%/s	
	0014	MV Change Rate Limit (Cooling)	CH	C-CR-L	H00000000 to H000003E8 (0.0 to 100.0 (0.0: Limiter disabled))	00 to 100.0	0.0	1	%/s	

CompoWay/F Variable type / Address	Modbus Address	Parameter	Attribute	Display	Setting/monitor range	Display	Default setting	Decimal point position	Unit	Set value
C7	0015	Input Value 1 for Input Correction	CH	LS.L	H'FFFFB1E1 to H'0001869F (-19999 to 99999)	- 19999 to 99999	-200.0 *2	According to input type	EU	
	0016	Input Correction 1	CH	LS.L	H'FFFFB1E1 to H'0001869F (-199.99 to 999.99)	- 199.99 to 999.99	0.00	2	EU	
	0017	Input Value 2 for Input Correction	CH	LS.L	H'FFFFB1E1 to H'0001869F (-19999 to 99999)	- 19999 to 99999	1300.0 *2	According to input type	EU	
	0018	Input Correction 2	CH	LS.L	H'FFFFB1E1 to H'0001869F (-199.99 to 999.99)	- 199.99 to 999.99	0.00	2	EU	
	001F	Disturbance Gain	CH	da.L	H'FFFFF9C to H'00000064 (-1.00 to 1.00)	- 1.00 to 1.00	0.65	2	-	
	0020	Disturbance Time Constant	CH	da.L	H'00000001 to H'0000270F (0.01 to 99.99)	0.01 to 99.99	1.00	2	-	
	0021	Disturbance Rectification Band	CH	da-b	H'00000000 to H'0000270F (0.000 to 9.999)	0.000 to 9.999	0.000	3	%FS	
	0022	Disturbance Judgement Width	CH	da.L	H'FFFFD8F1 to H'0000270F (-99.99 to 99.99)	- 99.99 to 99.99	0.00	2	%FS	
	0025	Set Point Offset	CH	SP.O	H'FFFFB1E1 to H'0001869F (-19999 to 99999)	- 19999 to 99999	0	According to input type	EU	

*1 RSP is the default for channels 2 to 4 for coordinated operation and channel 2 (secondary side) for cascade control.
 If the Operation at Reset parameter is set to fixed control, FSP is the default for channel 2 (secondary side) for cascade control.
 *2 When the input type, temperature unit, or scaling display values are changed, settings are initialized as follows:
 Temperature input: Set upper and lower limits of sensor input
 Analog input: Scaling Display Value 1 (lower limit), Scaling Display Value 2 (upper limit)

Adjustment 2 Level

CompoWay/F Variable type / Address	Modbus Address	Parameter	Attribute	Display	Setting/monitor range	Display	Default setting	Decimal point position	Unit	Set value
C8	0800	First Order Lag Operation 1 Time Constant	Com* mon	L.R.P.1	H'00000000 to H'0000270F (0.0 to 999.9)	0.0 to 999.9	0.0	1	Seconds	
	0801	First Order Lag Operation 2 Time Constant	Com* mon	L.R.P.2	H'00000000 to H'0000270F (0.0 to 999.9)	0.0 to 999.9	0.0	1	Seconds	
	0802	First Order Lag Operation 3 Time Constant	Com* mon	L.R.P.3	H'00000000 to H'0000270F (0.0 to 999.9)	0.0 to 999.9	0.0	1	Seconds	
	0803	First Order Lag Operation 4 Time Constant	Com* mon	L.R.P.4	H'00000000 to H'0000270F (0.0 to 999.9)	0.0 to 999.9	0.0	1	Seconds	
	0804	Move Average 1 Move Average Count	Com* mon	MA.P.1	H'00000000 to H'00000005 (1/2/4/8/16/32 times (Setting values for communications are 0/1/2/3/4/5))	1, 2, 4, 8, 16, 32	1	1	times	
	0805	Move Average 2 Move Average Count	Com* mon	MA.P.2	H'00000000 to H'00000005 (1/2/4/8/16/32 times (Setting values for communications are 0/1/2/3/4/5))	1, 2, 4, 8, 16, 32	1	1	times	
	0806	Move Average 3 Move Average Count	Com* mon	MA.P.3	H'00000000 to H'00000005 (1/2/4/8/16/32 times (Setting values for communications are 0/1/2/3/4/5))	1, 2, 4, 8, 16, 32	1	1	times	
	0807	Move Average 4 Move Average Count	Com* mon	MA.P.4	H'00000000 to H'00000005 (1/2/4/8/16/32 times (Setting values for communications are 0/1/2/3/4/5))	1, 2, 4, 8, 16, 32	1	1	times	
	0808	Extraction of Square Root 1 Low-cut Point	Com* mon	SR.P.1	H'00000000 to H'0000270F (0.0 to 9.999)	0.000 to 9.999	0.000	0.000	3	-*1
	0809	Extraction of Square Root 2 Low-cut Point	Com* mon	SR.P.2	H'00000000 to H'0000270F (0.0 to 9.999)	0.000 to 9.999	0.000	0.000	3	-*1
	0810	Extraction of Square Root 3 Low-cut Point	Com* mon	SR.P.3	H'00000000 to H'0000270F (0.0 to 9.999)	0.000 to 9.999	0.000	0.000	3	-*1
	0811	Extraction of Square Root 4 Low-cut Point	Com* mon	SR.P.4	H'00000000 to H'0000270F (0.0 to 9.999)	0.000 to 9.999	0.000	0.000	3	-*1
	0812	Analog Parameter (Control Rate)	Com* mon	RP.1	H'FFFFF831 to H'0000270F (-1.999 to 9.999)	- 1.999 to 9.999	1.000	1.000	3	-

*1 Set normalized values based on the input data for the extraction of square root function.
 When straight-line approximation is included in the input stage of a K type input for -200.0 to 1300.0°C, -200.0 to 1300.0°C is equivalent to the normalized range 0.000 to 1.000.

Alarm Set Setting level

Setting/monitor values prefixed by "H" are for setting and monitoring via communications.

Variable type	CompoWay/F Address	Modbus Address	Parameter	Attribute	Display	Setting/monitor range	Display	Default setting	Decimal point position	Unit	Set value
C9	-	-	Display Alarm Set Selection	CH	<i>d.RL n</i>	1 to 4	0 to 4	*1	-	-	-
	0002	0904	Alarm Set 1 Alarm Value 1	CH	<i>i.RL - i</i>	H'FFFFFFB1E1 to H'0001869F (-19999 to 99999)	- 19999 to 99999	0	According to input type	EU	
	0003	0906	Alarm Set 1 Alarm Upper Limit 1	CH	<i>i.RL iH</i>	H'FFFFFFB1E1 to H'0001869F (-19999 to 99999)	- 19999 to 99999	0	According to input type	EU	
	0004	0908	Alarm Set 1 Alarm Lower Limit 1	CH	<i>i.RL iL</i>	H'FFFFFFB1E1 to H'0001869F (-19999 to 99999)	- 19999 to 99999	0	According to input type	EU	
	0005	090A	Alarm Set 1 Alarm Value 2	CH	<i>i.RL - 2</i>	H'FFFFFFB1E1 to H'0001869F (-19999 to 99999)	- 19999 to 99999	0	According to input type	EU	
	0006	090C	Alarm Set 1 Alarm Upper Limit 2	CH	<i>i.RL 2H</i>	H'FFFFFFB1E1 to H'0001869F (-19999 to 99999)	- 19999 to 99999	0	According to input type	EU	
	0007	090E	Alarm Set 1 Alarm Lower Limit 2	CH	<i>i.RL 2L</i>	H'FFFFFFB1E1 to H'0001869F (-19999 to 99999)	- 19999 to 99999	0	According to input type	EU	
	0008	0910	Alarm Set 1 Alarm Value 3	CH	<i>i.RL - 3</i>	H'FFFFFFB1E1 to H'0001869F (-19999 to 99999)	- 19999 to 99999	0	According to input type	EU	
	0009	0912	Alarm Set 1 Alarm Upper Limit 3	CH	<i>i.RL 3H</i>	H'FFFFFFB1E1 to H'0001869F (-19999 to 99999)	- 19999 to 99999	0	According to input type	EU	
	000A	0914	Alarm Set 1 Alarm Lower Limit 3	CH	<i>i.RL 3L</i>	H'FFFFFFB1E1 to H'0001869F (-19999 to 99999)	- 19999 to 99999	0	According to input type	EU	
	000B	0916	Alarm Set 1 Alarm Value 4	CH	<i>i.RL - 4</i>	H'FFFFFFB1E1 to H'0001869F (-19999 to 99999)	- 19999 to 99999	0	According to input type	EU	
	000C	0918	Alarm Set 1 Alarm Upper Limit 4	CH	<i>i.RL 4H</i>	H'FFFFFFB1E1 to H'0001869F (-19999 to 99999)	- 19999 to 99999	0	According to input type	EU	
	000D	091A	Alarm Set 1 Alarm Lower Limit 4	CH	<i>i.RL 4L</i>	H'FFFFFFB1E1 to H'0001869F (-19999 to 99999)	- 19999 to 99999	0	According to input type	EU	
	0010	0920	Alarm Set 2 Alarm Value 1	CH	<i>2.RL - i</i>	The following are the same as Alarm Set 1.					
	001B	0936	Alarm Set 2 Alarm Lower Limit 4	CH	<i>2.RL 4L</i>						
	001E	093C	Alarm Set 3 Alarm Value 1	CH	<i>3.RL - i</i>						
	0029	0952	Alarm Set 3 Alarm Lower Limit 4	CH	<i>3.RL 4L</i>						
	002C	0958	Alarm Set 4 Alarm Value 1	CH	<i>4.RL - i</i>						
	0037	096E	Alarm Set 4 Alarm Lower Limit 4	CH	<i>4.RL 4L</i>						

*1 Alarm Set Number selected for execution.

Setting/monitor values prefixed by "H" are for setting and monitoring via communications.

PID Setting Level

CompoWay/F Variable type /Address	Modbus Address	Parameter	Attribute	Display	Setting/monitor range	Display	Default setting	Decimal point position	Unit	Set value
CA										
0000	0A00	Display PID Selection	CH	d.P.L.d	H'00000001 to H'00000008 (1 to 8)	1 to 8	*1	-	-	
		PID 1 Proportional Band	CH	i.P	Standard/heating/cooling: H'00000000 to H'0001869F (0.00 to 999.99) Position-proportional: H'00000001 to H'0001869F (0.01 to 999.99)	0.00 to 999.99	10.00	2	%FS	
0001	0A02	PID 1 Integral Time	CH	i.L	Standard/heating/cooling/Position-proportional (closed, operation stops at potentiometer input error): H'00000000 to H'00009C3F (0.0 to 3999.9) Position-proportional (closed, operation continues or floats at potentiometer input error): H'00000001 to H'00009C3F (0.1 to 3999.9)	0.0 to 3999.9	233.0	1	Seconds	
0002	0A04	PID 1 Derivative Time	CH	i.d	H'00000000 to H'00009C3F (0.0 to 3999.9)	0.0 to 3999.9	40.0	1	Seconds	
0003	0A06	PID 1 Integral Time*2	CH	-	Standard/heating/cooling/Position-proportional (closed, operation stops at potentiometer input error): H'00000000 to H'00061A76 (0.00 to 3999.90) Position-proportional (closed, operation continues or floats at potentiometer input error): H'0000000A to H'00061A76 (0.10 to 3999.90)	-	233.00	2	Seconds	
0004	0A08	PID 1 Derivative Time*2	CH	-	H'00000000 to H'00061A76 (0.00 to 3999.90)	-	40.00	2	Seconds	
0005	0A0A	PID 1 MV Upper Limit	CH	i.d.L.H	Standard/Position-proportional (closed): MV Lower Limit +0.1 to H'0000041A (105.0) Heating/cooling: H'00000000 to H'0000041A (0.0 to 105.0)	Same as at left	100.0	1	%	
0006	0A0C	PID 1 MV Lower Limit	CH	i.d.L.L	Standard/Position-proportional (closed): H'FFFFFFE (-5.0) to MV Upper Limit -0.1 Heating/cooling: H'FFFFFFE6 to H'00000000 (-105.0 to 0.0)	Same as at left	0.0	1	%	
0007	0A0E	PID 1 Automatic Selection Range Upper Limit (PV)	CH	i.P.L.L	H'FFFFFFE1 to H'0001869F (-19999 to 99999)	- 19999 to 99999	1450.0	According to input type	EU	
0008	0A10	PID 1 Automatic Selection Range Upper Limit (DV)	CH	i.P.L.L	H'FFFFFFE1 to H'0001869F (-19999 to 99999)	- 19999 to 99999	1650.0	According to input type	EU	
0048	0A90	PID 1 Automatic Selection Range Upper Limit (SP)	CH	i.P.L.L	H'FFFFFFE1 to H'0001869F (-19999 to 99999)	- 19999 to 99999	1450.0	According to input type	EU	
0009	0A12	PID 2 Proportional Band	CH	P.P	The following are the same as PID1.					
0011	0A22	PID 2 Automatic Selection Range Upper Limit (DV)	CH	P.P.L.L						
0049	0A92	PID 2 Automatic Selection Range Upper Limit (SP)	CH	P.P.L.L						
0012	0A24	PID 3 Proportional Band	CH	P.P						
001A	0A34	PID 3 Automatic Selection Range Upper Limit (DV)	CH	P.P.L.L						
004A	0A94	PID 3 Automatic Selection Range Upper Limit (SP)	CH	P.P.L.L						

CompoWay/F Variable type	Modbus Address	Parameter	Attribute	Display	Setting/monitor range	Display	Default setting	Decimal point position	Unit	Set value
CA	001B	0A36	PID 4 Proportional Band	CH	4,P					
		~		CH						
	0023	0A46	PID 4 Automatic Selection Range Upper Limit (DV)	CH	4,RLLE					
	004B	0A96	PID 4 Automatic Selection Range Upper Limit (SP)	CH	4,RLLE					
	0024	0A48	PID 5 Proportional Band	CH	5,P					
		~		CH						
	002C	0A58	PID 5 Automatic Selection Range Upper Limit (DV)	CH	5,RLLE					
	004C	0A98	PID 5 Automatic Selection Range Upper Limit (SP)	CH	5,RLLE					
	002D	0A5A	PID 6 Proportional Band	CH	6,P					
		~		CH						
	0035	0A6A	PID 6 Automatic Selection Range Upper Limit (DV)	CH	6,RLLE					
	004D	0A9A	PID 6 Automatic Selection Range Upper Limit (SP)	CH	6,RLLE					
	0036	0A6C	PID 7 Proportional Band	CH	7,P					
		~		CH						
	003E	0A7C	PID 7 Automatic Selection Range Upper Limit (DV)	CH	7,RLLE					
	004E	0A9C	PID 7 Automatic Selection Range Upper Limit (SP)	CH	7,RLLE					
003F	0A7E	PID 8 Proportional Band	CH	8,P						
	~		CH							
0046	0A8C	PID 8 Automatic Selection Range Upper Limit (PV)*5	CH	8,RLLE	HFFFFFFB1E1 to H'0001869F (-19999 to 99999)	- 99999 to 99999	1450.0	According to input type	EU	
0047	0A8E	PID 8 Automatic Selection Range Upper Limit (DV)*5	CH	8,RLLE	HFFFFFFB1E1 to H'0001869F (-19999 to 99999)	- 99999 to 99999	1650.0	According to input type	EU	
004F	0A9E	PID 8 Automatic Selection Range Upper Limit (SP)*5	CH	8,RLLE	HFFFFFFB1E1 to H'0001869F (-19999 to 99999)	- 99999 to 99999	1450.0	According to input type	EU	

*1 The currently selected PID Set Number.

*2 Not displayed in HMI.

*3 Specified upper limit of input

The maximum is -19999 to 99999.

*4 Temperature input: Specified range width of sensor input

Analog input: -110% to 110% of scaling range width

The maximum is -19999 to 99999.

*5 The upper limit of the automatic selection range of PID set 8 is fixed at 999.99% FS for internal data. This can be changed but it will not affect operation.

Time Signal Setting Level

Setting/monitor values prefixed by "H" are for setting and monitoring via communications.

CompoWay/F Variable type /Address	Modbus Address	Parameter	Attribute	Display	Setting/monitor range	Display	Default setting	Decimal point position	Unit	Set value
D9	0000	Program Editing*1	CH	Pr. Ed.	H'00000001 to H'00000020 (1 to 32)*2	1 to 32 *2	*3	-	-	-
	0001	Time Signal 1 Set Segment 1	CH	TS1.1	H'00000000 (0) to Number of Segments (0: Disabled)	Same as at left	0	-	-	-
	0002	Time Signal 1 ON Time 1	CH	TS1.1	H'00000000 to H'000026E7(0.00 to 99.59) or H'00000000 to H'0001850F(0.00.0 to 99.59.9)	0.00 to 99.59 or 0.00.0 to 99.59.9	0.00	According to program time unit	program	
	0003	Time Signal 1 OFF Time 1	CH	TS1.1	H'00000000 to H'000026E7(0.00 to 99.59) or H'00000000 to H'0001850F(0.00.0 to 99.59.9)	0.00 to 99.59 or 0.00.0 to 99.59.9	0.00	According to program time unit	program	
	0004	Time Signal 1 Set Segment 2	CH	TS2.1	H'00000000 (0) to Number of Segments (0: Disabled)	Same as at left	0	-	-	-
	0005	Time Signal 1 ON Time 2	CH	TS2.1	H'00000000 to H'000026E7(0.00 to 99.59) or H'00000000 to H'0001850F(0.00.0 to 99.59.9)	0.00 to 99.59 or 0.00.0 to 99.59.9	0.00	According to program time unit	program	
	0006	Time Signal 1 OFF Time 2	CH	TS2.1	H'00000000 to H'000026E7(0.00 to 99.59) or H'00000000 to H'0001850F(0.00.0 to 99.59.9)	0.00 to 99.59 or 0.00.0 to 99.59.9	0.00	According to program time unit	program	
	0007	Time Signal 1 Set Segment 3	CH	TS3.1	H'00000000 (0) to Number of Segments (0: Disabled)	Same as at left	0	-	-	-
	0008	Time Signal 1 ON Time 3	CH	TS3.1	H'00000000 to H'000026E7(0.00 to 99.59) or H'00000000 to H'0001850F(0.00.0 to 99.59.9)	0.00 to 99.59 or 0.00.0 to 99.59.9	0.00	According to program time unit	program	
	0009	Time Signal 1 OFF Time 3	CH	TS3.1	H'00000000 to H'000026E7(0.00 to 99.59) or H'00000000 to H'0001850F(0.00.0 to 99.59.9)	0.00 to 99.59 or 0.00.0 to 99.59.9	0.00	According to program time unit	program	
	000A	Time Signal 2 Set Segment 1	CH	TS1.2	The following are the same as Time Signal 1.					
	0013	Time Signal 3 Set Segment 1	CH	TS1.3						
	001C	Time Signal 4 Set Segment 1	CH	TS1.4						
	0025	Time Signal 5 Set Segment 1	CH	TS1.5						
	002E	Time Signal 6 Set Segment 1	CH	TS1.6						
	0036	Time Signal 6 OFF Time 3	CH	TS3.6						

*1 The same as the Program Editing parameter in Program Setting Level.

*2 Depends on the number of inputs and the settings of the Control Mode, Independent Operation/Coordinated Operation, and Number of Segments parameters.

*3 The currently selected program number.

*4 Specify channel 1 when setting time signals for coordinated operation or cascade control.

Approximation Setting Level

Setting/monitor values prefixed by "H" are for setting and monitoring via communications.

CompoWay/F Variable type	Modbus Address	Parameter	Attribute	Display	Setting/monitor range	Display	Default setting	Decimal point position	Unit	Set value
CB	0000	Straight-line Approximation 1 Input 1	Com- mon	5.1.1	H'FFFFFF831 to H'0000270F (-1.999 to 9.999)	- 9.999 to 9.999	0.000	3	-*1	
	0001	Straight-line Approximation 1 Input 2	Com- mon	5.2.1	H'FFFFFF831 to H'0000270F (-1.999 to 9.999)	- 9.999 to 9.999	1.000	3	-*1	
	0002	Straight-line Approximation 1 Output 1	Com- mon	5.1.1	H'FFFFFF831 to H'0000270F (-1.999 to 9.999)	- 9.999 to 9.999	0.000	3	-*1	
	0003	Straight-line Approximation 1 Output 2	Com- mon	5.2.1	H'FFFFFF831 to H'0000270F (-1.999 to 9.999)	- 9.999 to 9.999	1.000	3	-*1	
	0004	Straight-line Approximation 2 Input 1	Com- mon	5.1.2	H'FFFFFF831 to H'0000270F (-1.999 to 9.999)	- 9.999 to 9.999	0.000	3	-*1	
	0005	Straight-line Approximation 2 Input 2	Com- mon	5.2.2	H'FFFFFF831 to H'0000270F (-1.999 to 9.999)	- 9.999 to 9.999	1.000	3	-*1	
	0006	Straight-line Approximation 2 Output 1	Com- mon	5.1.2	H'FFFFFF831 to H'0000270F (-1.999 to 9.999)	- 9.999 to 9.999	0.000	3	-*1	
	0007	Straight-line Approximation 2 Output 2	Com- mon	5.2.2	H'FFFFFF831 to H'0000270F (-1.999 to 9.999)	- 9.999 to 9.999	1.000	3	-*1	
	0010	Broken-line Approximation 1 Input 1	Com- mon	F.1.1	H'FFFFFF831 to H'0000270F (-1.999 to 9.999)	- 9.999 to 9.999	0.000	3	-*1	
		~								
	0023	Broken-line Approximation 1 Input 20	Com- mon	F.2.1	H'FFFFFF831 to H'0000270F (-1.999 to 9.999)	- 9.999 to 9.999	0.000	3	-*1	
	0024	Broken-line Approximation 1 Output 1	Com- mon	F.1.1	H'FFFFFF831 to H'0000270F (-1.999 to 9.999)	- 9.999 to 9.999	0.000	3	-*1	
		~								
	0037	Broken-line Approximation 1 Output 20	Com- mon	F.2.1	H'FFFFFF831 to H'0000270F (-1.999 to 9.999)	- 9.999 to 9.999	0.000	3	-*1	

*1 ... These are set values for each of the operation functions. Set normalized values based on the input data for the operation function.
When straight-line approximation is included in the input stage of a type K input for -200.0 to 1300.0°C, -200.0 to 1300.0°C is equivalent to the normalized range 0.000 to 1.000.

Input Initial Setting Level

Setting/monitor values prefixed by "H" are for setting and monitoring via communications.

CompoWay/F Variable type / Address	Modbus Address	Parameter	Attribute	Display	Setting/monitor range	Display	Default setting	Decimal point position	Unit	Set value
CC 0000	0C00	Input 1 Type	Common	1-1-1	H'00000000: P1100 (0)*1 H'00000001: P1100 (1) H'00000002: K (2) H'00000003: K (3) H'00000004: J (4) H'00000005: J (5) H'00000006: T (6) H'00000007: E (7) H'00000008: L (8) H'00000009: U (9) H'0000000A: N (10) H'0000000B: R (11) H'0000000C: S (12) H'0000000D: B (13) H'0000000E: W (14) H'0000000F: 4 to 20 mA (15) H'00000010: 0 to 20 mA (16) H'00000011: 1 to 5V (17) H'00000012: 0 to 5V (18) H'00000013: 0 to 10 V (19)	0 to 19	2*2	-	-	-
0001	0C02	Input 1 Temperature Units	Common	1-1-1	H'00000000: °C (0) H'00000001: °F (1)	1, F	°C	-	-	-
0002	0C04	Input 2 Type	Common	1-2-1	Same as Input 1 Type	0 to 19	2*2	-	-	-
0003	0C06	Input 2 Temperature Units	Common	1-2-1	H'00000000: °C (0) H'00000001: °F (1)	1, F	°C	-	-	-
0004	0C08	Input 3 Type	Common	1-3-1	Same as Input 1 Type	0 to 19	2*2	-	-	-
0005	0C0A	Input 3 Temperature Units	Common	1-3-1	H'00000000: °C (0) H'00000001: °F (1)	1, F	°C	-	-	-
0006	0C0C	Input 4 Type	Common	1-4-1	Same as Input 1 Type	0 to 19	2*2	-	-	-
0007	0C0E	Input 4 Temperature Units	Common	1-4-1	H'00000000: °C (0) H'00000001: °F (1)	1, F	°C	-	-	-
0008	0C10	Scaling Input Value 1	CH	1-5-1	Input lower limit to input upper limit	Same as at left	4*3	0	*4	-
0009	0C12	Scaling Display Value 1	CH	1-5-1	H'FFFFB1E1 (-19999) to Scaling Display Value 2 - 1	Same as at left	0	-	EU	-
000A	0C14	Scaling Input Value 2	CH	1-5-2	Input lower limit to input upper limit	Same as at left	20*3	0	*4	-
000B	0C16	Scaling Display Value 2	CH	1-5-2	Scaling Display Value 1 + 1 to H'000D1869F (99999)	Same as at left	100	-	EU	-
000C	0C18	Decimal Point Position	CH	1-5-2	H'00000000 to H'00000004 (0 to 4)	0 to 4	0	-	-	-
000D	0C1A	Remote SP Upper Limit	CH	1-5-2	Temperature: Lower limit of sensor setting range to upper limit of sensor setting range	Same as at left	1300	According to input type	EU	-
000E	0C1C	Remote SP Lower Limit	CH	1-5-2	Analog: Larger of -19999 and display value equivalent to input lower limit to smaller of 99999 and display value equivalent to upper input limit	Same as at left	-200	According to input type	EU	-
000F	0C1E	PV Decimal Point Display	CH	1-5-2	Sensor setting range to upper limit of sensor setting range	Same as at left	-200	According to input type	EU	-
0010	0C20	Sensor Induction Noise Reduction	Common	1-5-2	Analog: Larger of -19999 and display value equivalent to input lower limit to smaller of 99999 and display value equivalent to input upper limit	OFF, ON	ON	-	-	-
-	-	Move to Advanced Function Setting Level	Common	1-5-2	H'00000000: OFF (0) H'00000001: ON (1)	50Hz, 60Hz	50 Hz	-	-	-
-	-	Move to Advanced Function Setting Level	Common	1-5-2	-19999 to 99999	-19999 to 99999	0	-	-	-

*1 Input type settings are 0 to 14 for a temperature input and 15 to 19 for an analog input, depending on the input type switch (on the bottom of the Controller).

*2 The default value for the Input Type parameter is "2" regardless of the setting of the input type switch.

*3 Initialized to the upper and lower limits of the input type when the input type is changed.

*4 Determined by Input Type parameter setting.

Control Initial Setting Level

Setting/monitor values prefixed by "H" are for setting and monitoring via communications.

CompoWay/F Variable type	Modbus Address	Parameter	Attribute	Display	Setting/monitor range	Display	Default setting	Decimal point position	Unit	Set value	
CD	0000	Output 1 Type	Com ⁺ mon	ᄁ ᄁ ᄁ	H'00000000: Voltage output (for driving SSR) (0) H'00000001: Linear current output (1)	ᄁ to ᄁ	0	-	-		
	0001	Output 3 Type	Com ⁺ mon	ᄁ ᄁ ᄁ	H'00000000: Voltage output (for driving SSR) (0) H'00000001: Linear current output (1)	ᄁ to ᄁ	0	-	-		
	0003	Linear Current Output 1 Type	Com ⁺ mon	ᄁ ᄁ ᄁ	H'00000000: 0 to 20 mA (0) H'00000001: 4 to 20 mA (1)	ᄁ to ᄁ	1	-	-		
	0004	Linear Current Output 2 Type	Com ⁺ mon	ᄁ ᄁ ᄁ	H'00000000: 0 to 20 mA (0) H'00000001: 4 to 20 mA (1)	ᄁ to ᄁ	1	-	-	-	
	0005	Linear Current Output 3 Type	Com ⁺ mon	ᄁ ᄁ ᄁ	H'00000000: 0 to 20 mA (0) H'00000001: 4 to 20 mA (1)	ᄁ to ᄁ	1	-	-	-	
	0006	Linear Current Output 4 Type	Com ⁺ mon	ᄁ ᄁ ᄁ	H'00000000: 0 to 20 mA (0) H'00000001: 4 to 20 mA (1)	ᄁ to ᄁ	1	-	-	-	
	000F	SP Upper Limit	CH	ᄁ ᄁ ᄁ	Temperature: SP Lower Limit + 1 Upper limit of sensor setting range Analog: SP Lower Limit + 1 to 9999 and minimum display value corresponding to the input upper limit	Same as at left	1300.0 *1	According to input type	EU		
	0010	SP Lower Limit	CH	ᄁ ᄁ ᄁ	Temperature: Lower limit of sensor setting range to upper limit of sensor setting range Analog: -19999 and maximum display value corresponding to the input lower limit to SP upper limit -1	Same as at left	-200.0 *1	According to input type	EU		
	0011	Control Mode	Com ⁺ mon	ᄁ ᄁ ᄁ	Models with 1 or 4 Input Channels H'00000000: Standard (0) H'00000001: Heating/cooling (1) Models with 2 Input Channels H'00000000: Standard (0) H'00000001: Heating/cooling (1) H'00000002: Remote SP standard (2) H'00000003: Remote SP heating/cooling (3) H'00000004: Proportional (4) H'00000005: Cascade standard (5) H'00000006: Cascade heating or cooling (6)	-	0	-	-		
	0012	Direct/Reverse Operation	CH	ᄁ ᄁ ᄁ	H'00000000: Reverse operation: OR-R (0) H'00000001: Direct operation: OR-D (1)	ᄁ ᄁ ᄁ, ᄁ ᄁ ᄁ	Reverse operation	-	-		
	0013	Closed/Floating	CH	ᄁ ᄁ ᄁ	H'00000000: Floating: FLOAT (0) H'00000001: Close: CLOSE (1)	ᄁ ᄁ ᄁ, ᄁ ᄁ ᄁ	Floating	-	-		
	0014	Independent Operation/ Coordinated Operation	Com ⁺ mon	ᄁ ᄁ ᄁ	H'00000000: Independent operation: MULT (0) H'00000001: Coordinated operation: SINGL (1)	ᄁ ᄁ ᄁ, ᄁ ᄁ ᄁ	Independent operation	-	-		

CompoWay/F Variable type Address	Modbus Address	Parameter	Attribute	Display	Setting/monitor range	Display	Default setting	Decimal point position	Unit	Set value
CD	0015	0D2A	Number of Segments*2	Com* mon	50000000	H'00000000: 8 Segments: 8 (0) H'00000001: 12 Segments: 12 (1) H'00000002: 16 Segments: 16 (2) H'00000003: 20 Segments: 20 (3) H'00000004: 32 Segments: 32 (4)	16 segments	-	-	-
	0016	0D2C	Program Time Unit	Com* mon	hh-mm	HHMM, hhmm, MMSS, mmSSsd	hh.mm	-	-	-
	0017	0D2E	Step Time/Rate of Rise Programming	Com* mon	Step Time	hh-mm-ss, Pr	Step Time	-	-	-
	0018	0D30	Time Unit of Ramp Rate	Com* mon	min	hh, H, m, S	min	-	-	-
	0019	0D32	PV Start	CH	SP	SP, PV-r, PV-t	SP Start	-	-	-
	001A	0D34	Operation at Reset	Com* mon	Control Stop	SP, FSP	Control Stop	-	-	-
	001B	0D36	Set Point Selection	Com* mon	Present Set Point	PSP, PU	Present Set Point	-	-	-

*1 ... When the input type, temperature unit, or scaling display values are changed, settings are initialized as follows:

Temperature input: Set upper and lower limits of sensor input

Analog input: Scaling Display Value 1 (lower limit), Scaling Display Value 2 (upper limit)

*2 ... The maximum number of programs that can be set depends on the setting of the Number of Segments parameter.

8 segments: 32 programs max.

12 segments: 20 programs max.

16 segments: 16 programs max.

20 segments: 12 programs max.

32 segments: 8 programs max.

Control Initial Setting 2 Level

Setting/monitor values prefixed by "H" are for setting and monitoring via communications.

CompoWay/F Variable type/ Address	Modbus Address	Parameter	Attribute	Display	Setting/monitor range	Display	Default setting	Decimal point position	Unit	Set value
CE 0006	0E0C	Control/Transfer Output 1 Assignment	Com- mon	0 to 32	H'00000000: Disabled (0) H'00000001: CH1 Control Output (Heating or Open) for control output (1) H'00000002: CH1 Control Output (Heating or Closed) for control output (2) H'00000003: CH1 SP (3) H'00000004: CH1 Present Set Point (4) H'00000005: CH1 Present Value (PV) (5) H'00000006: CH1 Control Output (Heating or Open) for transfer output (6) H'00000007: CH1 Control Output (Cooling or Closed) for transfer output (7) H'00000008: CH1 Valve Opening (8) Similarly, CH2 (9 to 16) CH3 (17 to 24) CH4 (25 to 32)	0 to 32	*1	-	-	
0007	0E0E	Control/Transfer Output 2 Assignment	Com- mon	0 to 32	Same as above	Same as above	Same as above	-	-	
0008	0E10	Control/Transfer Output 3 Assignment	Com- mon	0 to 32	Same as above	Same as above	Same as above	-	-	
0009	0E12	Control/Transfer Output 4 Assignment	Com- mon	0 to 32	Same as above	Same as above	Same as above	-	-	
000A	0E14	Event Input 1 Assignment	Com- mon	0 to 32	H'00000000: Disabled (0) H'00000001: Communications Writing OFF/ON (1) H'00000002: Program No. (Bit 0, Weight 1) (2) H'00000003: Program No. (Bit 1, Weight 2) (3) H'00000004: Program No. (Bit 2, Weight 4) (4) H'00000005: Program No. (Bit 3, Weight 8) (5) H'00000006: Program No. (Bit 4, Weight 16) (6) H'00000007: Program No. (Bit 5, Weight 32) (7) H'00000008: CH1 Program No. (Bit 0, Weight 10) (8) H'00000009: CH1 Program No. (Bit 1, Weight 20) (9) H'0000000A: CH1 Run (ON)/Reset (OFF) (10) H'0000000B: CH1 Run (OFF)/Reset (ON) (11) H'0000000C: CH1 Auto (OFF)/Manual (ON) (12) H'0000000D: CH1 Program SP (OFF)/Remote SP (ON) (13) H'0000000E: CH1 Remote SP (OFF)/Fixed SP (ON) (14) H'0000000F: CH1 Program SP (OFF)/Fixed SP (ON) (15) H'00000010: CH1 Program SP (16) H'00000011: CH1 Remote SP (17) H'00000014: CH1 Advance (20) H'00000015: CH1 Back (21)	0 to 32	0	-	-	

CompoWay/F Variable type / Address	Modbus Address	Parameter	Attribute	Display	Setting/monitor range	Display	Default setting	Decimal point position	Unit	Set value
CE	000A	Event Input 1 Assignment	Com- mon	E . 1	Similarly, H'00000016 to H'00000029: CH2 (22 to 41) H'0000002A to H'0000003D: CH3 (42 to 61) H'0000003E to H'00000051: CH4 (62 to 81)	0 to 81	0	-	-	
	000B	Event Input 2 Assignment	Com- mon	E . 2	Same as above	Same as above	0	-	-	
	000C	Event Input 3 Assignment	Com- mon	E . 3	Same as above	Same as above	0	-	-	
	000D	Event Input 4 Assignment	Com- mon	E . 4	Same as above	Same as above	0	-	-	
	000E	Event Input 5 Assignment	Com- mon	E . 5	Same as above	Same as above	0	-	-	
	000F	Event Input 6 Assignment	Com- mon	E . 6	Same as above	Same as above	0	-	-	
	0031	Event Input 7 Assignment	Com- mon	E . 7	Same as above	Same as above	0	-	-	
	0032	Event Input 8 Assignment	Com- mon	E . 8	Same as above	Same as above	0	-	-	
	0033	Event Input 9 Assignment	Com- mon	E . 9	Same as above	Same as above	0	-	-	
	0034	Event Input 10 Assignment	Com- mon	E . 10	Same as above	Same as above	0	-	-	
	0010	Auxiliary Output 1 Assignment	Com- mon	5ba . 1	H'00000000: Disabled (0) H'00000001: CH1 Alarm 1 (1) H'00000002: CH1 Alarm 2 (2) H'00000003: CH1 Alarm 3 (3) H'00000004: CH1 Alarm 4 (4) H'00000005: CH1 Input Error (5) H'00000006: CH1RSP Input Error (6) H'00000007: CH1 Disabled (7) H'00000008: CH1 Run Output (8) H'00000009: CH1 Program End Output (9) H'0000000A: CH1 Program Output 1 (10) H'0000000B: CH1 Program Output 2 (11) H'0000000C: CH1 Program Output 3 (12) H'0000000D: CH1 Program Output 4 (13) H'0000000E: CH1 Program Output 5 (14) H'0000000F: CH1 Program Output 6 (15) H'00000010: CH1 Program Output 7 (16) H'00000011: CH1 Program Output 8 (17) H'00000012: CH1 Program Output 9 (18) H'00000013: CH1 Program Output 10 (19) H'00000014: U-ALM (20) H'00000015: Alarm 1 OR Output of All Channels (21) H'00000016: Alarm 2 OR Output of All Channels (22) H'00000017: Alarm 3 OR Output of All Channels (23) H'00000018: Alarm 4 OR Output of All Channels (24) H'00000019: Input Error 1 OR Output of All Channels (25) H'0000001A: RSP Input Error 1 OR Output of All Channels (26) H'0000001B: Disabled (27)	0 to 84	1	-	-	

CompoWay/F Variable type, Address	Modbus Address	Parameter	Attribute	Display	Setting/monitor range	Display	Default setting	Decimal point position	Unit	Set value
CE 0010	0E20	Auxiliary Output 1 Assignment	Common	5bā. i	H'0000001C: CH2 Alarm 1 (28) H'0000001D: CH2 Alarm 2 (29) H'0000001E: CH2 Alarm 3 (30) H'0000001F: CH2 Alarm 4 (31) H'00000020: CH1 Input error (32) H'00000021: CH2 RSP Input error (33) H'00000022: CH2 Disabled (34) H'00000023: CH2 Run Output (35) H'00000024: CH2 Program End Output (36) H'00000025: CH2 Program Output 1 (37) H'00000026: CH2 Program Output 2 (38) H'00000027: CH2 Program Output 3 (39) H'00000028: CH2 Program Output 4 (40) H'00000029: CH2 Program Output 5 (41) H'0000002A: CH2 Program Output 6 (42) H'0000002B: CH2 Program Output 7 (43) H'0000002C: CH2 Program Output 8 (44) H'0000002D: CH2 Program Output 9 (45) H'0000002E: CH2 Program Output 10 (46) Similarly. H'0000002F to H'00000041: CH3 (47 to 65) H'00000042 to H'00000054: CH4 (66 to 84)	0 to 84	1	-	-	
0011	0E22	Auxiliary Output 2 Assignment	Common	5bā. 2	Same as above	Same as above	2	-	-	
0012	0E24	Auxiliary Output 3 Assignment	Common	5bā. 3	Same as above	Same as above	3	-	-	
0013	0E26	Auxiliary Output 4 Assignment	Common	5bā. 4	Same as above	Same as above	4	-	-	
0035	0E6A	Auxiliary Output 5 Assignment	Common	5bā. 5	Same as above	Same as above	-	-	-	
0036	0E6C	Auxiliary Output 6 Assignment	Common	5bā. 6	Same as above	Same as above	-	-	-	
0037	0E6E	Auxiliary Output 7 Assignment	Common	5bā. 7	Same as above	Same as above	-	-	-	
0038	0E70	Auxiliary Output 8 Assignment	Common	5bā. 8	Same as above	Same as above	-	-	-	
0039	0E72	Auxiliary Output 9 Assignment	Common	5bā. 9	Same as above	Same as above	-	-	-	
003A	0E74	Auxiliary Output 10 Assignment	Common	5bā. 10	Same as above	Same as above	-	-	-	
000B	0E76	Program Output Selection	Common	PSbē	H'00000000: Segment Output: SGO (0) H'00000001: Segment Number Output: SGN (1) H'00000002: Time Signal: TSG (2)	5bā, 5bā, 5bā	Segment Output	-	-	
0014	0E28	Transfer Output 1 Upper Limit	Common	ē-r-H. i	*2	Same as at left	Same as at left	Same as at left	Same as at left	
0015	0E2A	Transfer Output 1 Lower Limit	Common	ē-r-L. i	*2	Same as at left	Same as at left	Same as at left	Same as at left	
0016	0E2C	Transfer Output 2 Upper Limit	Common	ē-r-H. 2	*2	Same as at left	Same as at left	Same as at left	Same as at left	
0017	0E2E	Transfer Output 2 Lower Limit	Common	ē-r-L. 2	*2	Same as at left	Same as at left	Same as at left	Same as at left	
0018	0E30	Transfer Output 3 Upper Limit	Common	ē-r-H. 3	*2	Same as at left	Same as at left	Same as at left	Same as at left	
0019	0E32	Transfer Output 3 Lower Limit	Common	ē-r-L. 3	*2	Same as at left	Same as at left	Same as at left	Same as at left	
001A	0E34	Transfer Output 4 Upper Limit	Common	ē-r-H. 4	*2	Same as at left	Same as at left	Same as at left	Same as at left	
001B	0E36	Transfer Output 4 Lower Limit	Common	ē-r-L. 4	*2	Same as at left	Same as at left	Same as at left	Same as at left	

CompoWay/F Variable type / Address	Modbus Address	Parameter	Attribute	Display	Setting/monitor range	Display	Default setting	Decimal point position	Unit	Set value
CE 001C	0E38	First Order Lag Operation 1 Enabled	Com* mon	LRL.1	H'00000000: OFF (0) H'00000001: ON (1)	OFF, ON	OFF	-	-	
001D	0E3A	First Order Lag Operation 2 Enabled	Com* mon	LRL.2	H'00000000: OFF (0) H'00000001: ON (1)	OFF, ON	OFF	-	-	
001E	0E3C	First Order Lag Operation 3 Enabled	Com* mon	LRL.3	H'00000000: OFF (0) H'00000001: ON (1)	OFF, ON	OFF	-	-	
001F	0E3E	First Order Lag Operation 4 Enabled	Com* mon	LRL.4	H'00000000: OFF (0) H'00000001: ON (1)	OFF, ON	OFF	-	-	
0020	0E40	Movement Average 1 Enabled	Com* mon	NR.1	H'00000000: OFF (0) H'00000001: ON (1)	OFF, ON	OFF	-	-	
0021	0E42	Movement Average 2 Enabled	Com* mon	NR.2	H'00000000: OFF (0) H'00000001: ON (1)	OFF, ON	OFF	-	-	
0022	0E44	Movement Average 3 Enabled	Com* mon	NR.3	H'00000000: OFF (0) H'00000001: ON (1)	OFF, ON	OFF	-	-	
0023	0E46	Movement Average 4 Enabled	Com* mon	NR.4	H'00000000: OFF (0) H'00000001: ON (1)	OFF, ON	OFF	-	-	
0024	0E48	Extraction of Square Root 1 Enabled	Com* mon	SR.1	H'00000000: OFF (0) H'00000001: ON (1)	OFF, ON	OFF	-	-	
0025	0E4A	Extraction of Square Root 2 Enabled	Com* mon	SR.2	H'00000000: OFF (0) H'00000001: ON (1)	OFF, ON	OFF	-	-	
0026	0E4C	Extraction of Square Root 3 Enabled	Com* mon	SR.3	H'00000000: OFF (0) H'00000001: ON (1)	OFF, ON	OFF	-	-	
0027	0E4E	Extraction of Square Root 4 Enabled	Com* mon	SR.4	H'00000000: OFF (0) H'00000001: ON (1)	OFF, ON	OFF	-	-	
002A	0E54	Straight-line Approximation 1 Enabled	Com* mon	SL.1	H'00000000: OFF (0) H'00000001: ON (1)	OFF, ON	OFF	-	-	
002B	0E56	Straight-line Approximation 2 Enabled	Com* mon	SL.2	H'00000000: OFF (0) H'00000001: ON (1)	OFF, ON	OFF	-	-	
002E	0E5C	Broken-line Approximation 1 Enabled	Com* mon	FL.1	H'00000000: OFF (0) H'00000001: ON (1)	OFF, ON	OFF	-	-	
-	-	Motor Calibration	CH	LRL	OFF, ON	OFF, ON	OFF	-	-	
0030	0E60	Travel Time	CH	NR	H'00000001 to H'000003E7 (1 to 999)	1 to 999	30	0	Sec- onds	

Note 1. The default settings for each control mode are given below.

Control mode	Input type	Control transfer output 1 assignment	Control transfer output 2 assignment	Control transfer output 3 assignment	Control transfer output 4 assignment
Standard control	1 input	1	0	0	0
	2 inputs	1	9	0	0
	4 inputs	1	9	17	25
Heating/cooling control	1 input	1	2	0	0
	2 inputs	1	2	9	10
	4 inputs	1	2	9	10
Standard control with remote SP	1 input	-	-	-	-
	2 inputs	1	0	0	0
	4 inputs	-	-	-	-
Heating/cooling control with remote SP	1 input	-	-	-	-
	2 inputs	1	2	0	0
	4 inputs	-	-	-	-
Ratio control	1 input	-	-	-	-
	2 inputs	1	0	0	0
	4 inputs	-	-	-	-
Cascade standard control	1 input	-	-	-	-
	2 inputs	9	0	0	0
	4 inputs	-	-	-	-
Cascade heating/cooling control	1 input	-	-	-	-
	2 inputs	9	10	0	0
	4 inputs	-	-	-	-
Position-proportional control	1 input	-	-	0	0

Note 2.

	Setting/monitor value	Default value (transfer output upper-limit / lower-limit)	Decimal point position/unit
Present Set Point Present Value (PV)	SP Lower Limit to SP Upper Limit	1300.0/-200.0	According to input type/EU
	Temperature: Lower limit of sensor setting range to upper limit of sensor setting range Analog: H'FFFFFFE1 to H'0001869F (-19999 to 99999)	Upper/lower limit of sensor setting range	According to input type/EU
Control Output (Heating or Open) Control Output (Cooling or Closed) Valve Opening	Standard: H'FFFFFFCE to H'0000041A (-5.0 to 105.0)	Scaling Display Value 2/1	According to input type/EU
	H'00000000 to H'0000041A (0.0 to 105.0)	100.0/0.0	1/%
	H'00000000 to H'0000041A (0.0 to 105.0)	100.0/0.0	1/%
	H'FFFFFF9C to H'0000044C (-10.0 to 110.0)	100.0/0.0	1/%

The Input Type, Temperature Unit, Scaling Display Value, and SP Upper/Lower Limit parameters are initialized when the corresponding control/transfer output assignment is changed.

Alarm Setting Level

Setting/monitor values prefixed by "H" are for setting and monitoring via communications.

Variable type	CompoWay/F Address	Modbus Address	Parameter	Attribute	Display	Setting/monitor range	Display	Default setting	Decimal point position	Unit	Set value
CF	0000	0F00	Alarm 1 Type	CH	<i>RLt i</i>	H'00000000: No alarm (0) H'00000001: Upper-and lower-limit alarm (1) H'00000002: Upper-limit alarm (2) H'00000003: Lower-limit alarm (3) H'00000004: Upper-and lower-limit range alarm (4) H'00000005: Upper-and lower-limit alarm with standby sequence (5) H'00000006: Upper-limit alarm with standby sequence (6) H'00000007: Lower-limit alarm with standby sequence (7) H'00000008: Absolute-value upper-limit alarm (8) H'00000009: Absolute-value lower-limit alarm (9) H'0000000A: Absolute-value upper-limit with standby sequence (10) H'0000000B: Absolute-value lower-limit with standby sequence (11)		2	-	-	
	0001	0F02	Alarm 1 Latch	CH	<i>R lLt</i>	H'00000000: OFF (0) H'00000001: ON (1)	<i>OFF, ON</i>	OFF	-	-	
	0002	0F04	Alarm 1 Hysteresis	CH	<i>RLH i</i>	H'00000001 to H'0000270F: 0.01 to 99.99	<i>0.01 to 99.99</i>	0.02	2	%FS	
	0003	0F06	Alarm 2 Type	CH	<i>RLt 2</i>	Same as alarm type 1	<i>0 to i i</i>	2	-	-	
	0004	0F08	Alarm 2 Latch	CH	<i>R 2Lt</i>	H'00000000: OFF (0) H'00000001: ON (1)	<i>OFF, ON</i>	OFF	-	-	
	0005	0F0A	Alarm 2 Hysteresis	CH	<i>RLH 2</i>	H'00000001 to H'0000270F: 0.01 to 99.99	<i>0.01 to 99.99</i>	0.02	2	%FS	
	0006	0F0C	Alarm 3 Type	CH	<i>RLt 3</i>	Same as alarm type 1	<i>0 to i i</i>	2	-	-	
	0007	0F0E	Alarm 3 Latch	CH	<i>R 3Lt</i>	H'00000000: OFF (0) H'00000001: ON (1)	<i>OFF, ON</i>	OFF	-	-	
	0008	0F10	Alarm 3 Hysteresis	CH	<i>RLH 3</i>	H'00000001 to H'0000270F: 0.01 to 99.99	<i>0.01 to 99.99</i>	0.02	2	%FS	
	0009	0F12	Alarm 4 Type	CH	<i>RLt 4</i>	Same as alarm type 1	<i>0 to i i</i>	2	-	-	
	000A	0F14	Alarm 4 Latch	CH	<i>R 4Lt</i>	H'00000000: OFF (0) H'00000001: ON (1)	<i>OFF, ON</i>	OFF	-	-	
	000B	0F16	Alarm 4 Hysteresis	CH	<i>RLH 4</i>	H'00000001 to H'0000270F: 0.01 to 99.99	<i>0.01 to 99.99</i>	0.02	2	%FS	
	000C	0F18	Standby Sequence Reset	CH	<i>rESt</i>	H'00000000: Condition A (0) H'00000001: Condition B (1)	<i>R, b</i>	A	-	-	
	000D	0F1A	Auxiliary Output 1 Open in Alarm	Com- mon	<i>5b 1n</i>	H'00000000: Close in alarm: N-O (0) H'00000001: Open in alarm: N-C (1)	<i>n-0, n-1</i>	Close in alarm	-	-	
	000E	0F1C	Auxiliary Output 2 Open in Alarm	Com- mon	<i>5b 2n</i>	H'00000000: Close in alarm: N-O (0) H'00000001: Open in alarm: N-C (1)	<i>n-0, n-1</i>	Close in alarm	-	-	
	000F	0F1E	Auxiliary Output 3 Open in Alarm	Com- mon	<i>5b 3n</i>	H'00000000: Close in alarm: N-O (0) H'00000001: Open in alarm: N-C (1)	<i>n-0, n-1</i>	Close in alarm	-	-	
	0010	0F20	Auxiliary Output 4 Open in Alarm	Com- mon	<i>5b 4n</i>	H'00000000: Close in alarm: N-O (0) H'00000001: Open in alarm: N-C (1)	<i>n-0, n-1</i>	Close in alarm	-	-	
	0011	0F22	Auxiliary Output 5 Open in Alarm	Com- mon	<i>5b 5n</i>	H'00000000: Close in alarm: N-O (0) H'00000001: Open in alarm: N-C (1)	<i>n-0, n-1</i>	Close in alarm	-	-	

CompoWay/F Variable type Address	Modbus Address	Parameter	Attribute	Display	Setting/monitor range	Display	Default setting	Decimal point position	Unit	Set value
CF	0012	Auxiliary Output 6 Open in Alarm	Com* mon	5b5n	H'00000000: Close in alarm: N-O (0) H'00000001: Open in alarm: N-C (1)	n-ā, n-ē	Close in alarm	-	-	
	0013	Auxiliary Output 7 Open in Alarm	Com* mon	5b7n	H'00000000: Close in alarm: N-O (0) H'00000001: Open in alarm: N-C (1)	n-ā, n-ē	Close in alarm	-	-	
	0014	Auxiliary Output 8 Open in Alarm	Com* mon	5b8n	H'00000000: Close in alarm: N-O (0) H'00000001: Open in alarm: N-C (1)	n-ā, n-ē	Close in alarm	-	-	
	0015	Auxiliary Output 9 Open in Alarm	Com* mon	5b9n	H'00000000: Close in alarm: N-O (0) H'00000001: Open in alarm: N-C (1)	n-ā, n-ē	Close in alarm	-	-	
	0016	Auxiliary Output 10 Open in Alarm	Com* mon	5b;n	H'00000000: Close in alarm: N-O (0) H'00000001: Open in alarm: N-C (1)	n-ā, n-ē	Close in alarm	-	-	

Display Adjustment Level

Setting/monitor values prefixed by "H" are for setting and monitoring via communications.

Variable type	CompoWay/F Address	Modbus Address	Parameter	Attribute	Display	Setting/monitor range	Display	Default setting	Decimal point position	Unit	Set value
D0	0001	1002	MV Display Selection	CH	005L	H'00000000: MV (Heating) (0) H'00000001: Mv (Cooling) (1)	00 0-0	Heating			
	0002	1004	Bar Graph Display Item	Com ⁻ mon	0000	H'00000000: OFF (0) H'00000001: Elapsed Program Time Percentage: PRG.T (1) H'00000002: Elapsed Segment Time Percentage: SEG.T (2) H'00000003: Deviation: 1 EU/Segment (3) H'00000004: Deviation: 10 EU/Segment (4) H'00000005: Deviation: 20 EU/Segment (5) H'00000006: Deviation: 100 EU/Segment (6) H'00000007: MV (Heating)/Valve Opening: O (7) H'00000008: MV (Cooling): C-O (8)	00FF, 0000, 1000EU, 0, 0-0	MV/Valve opening	-	-	
	0003	1006	Display Auto-return Time	Com ⁻ mon	0000	H'00000000 to H'00000063 (0 to 99 (0: Display auto. reset disabled))	0 to 99	0	-	Seconds	
	0004	1008	Display Refresh Period	Com ⁻ mon	0000	H'00000000: OFF (0) H'00000001: 0.5 s (1) H'00000002: 1 s (2) H'00000003: 2 s (3) H'00000004: 4 s (4)	00FF, 0.5, 1, 2, 4	0.5	-	Seconds	
	0005	100A	Monitor Item Level Setting	Com ⁻ mon	0000	H'00000000: Disabled: OFF (0) H'00000001: Input Initial Setting Level: L.0 (1) H'00000002: Control Initial Setting Level: L.1 (2) H'00000003: Control Initial Setting 2 Level: L.2 (3) H'00000004: Alarm Setting Level: L.3 (4) H'00000005: Display Adjustment Level: L.4 (5) H'00000006: Communications Setting Level: L.5 (6) H'00000007: Advanced Function Setting Level: L.ADF (7) H'00000008: Expansion Control Setting Level: L.EXC (8)	00FF, 0.0, 1.1, 1.2, 1.3, 1.4, 1.5, 1.ADF, 1.EXC	OFF	-	-	
	0006	100C	Start Display Scan at Power ON	Com ⁻ mon	0000	H'00000000: OFF (0) H'00000001: ON (1)	00FF, 00	OFF	-	-	
	0007	100E	Display Scan Period	Com ⁻ mon	0000	H'00000000 to H'00000063 (0 to 99 (0: Display scan disabled))	0 to 99	2	-	Seconds	

Communications Setting Level

Setting/monitor values prefixed by "H" are for setting and monitoring via communications.

Variable type	CompoWay/F Address	Modbus Address	Parameter	Attribute	Display	Setting/monitor range	Display	Default setting	Decimal point position	Unit	Set value	
D1	0000	1100	Protocol Selection	Com* mon	PSEL	H'00000000: CompoWay/F: CWF (0) H'00000001: Modbus: MOD (1)	CWF, MOD	CWF (0)	-	-		
	0001	1102	Communications Unit No.	Com* mon	U-NO	H'00000000 to H'00000063 (0 to 99)	0 to 99	1	-	-		
	0002	1104	Communications Speed	Com* mon	SPS	H'00000000: 9.6 (0) H'00000001: 19.2 (1) H'00000002: 38.4 (2)	9.6, 19.2, 38.4	9.6	-	kbps		
	0003	1106	Communications Data Length	Com* mon	LEN	H'00000000: 7 (0) H'00000001: 8 (1)	7, 8	7	-	-	Bit	
	0004	1108	Communications Stop Bits	Com* mon	SBITS	H'00000000: 1 (0) H'00000001: 2 (1)	1, 2	2	-	-	Bit	
	0005	110A	Communications Parity	Com* mon	PRTY	H'00000000: None: NONE (0) H'00000001: Even: EVEN (1) H'00000002: Odd: ODD (2)	NONE, EVEN, ODD	EVEN (1)	-	-	-	
0006	110C	Transmission Wait Time	Com* mon	SDWT	H'00000000 to H'00000063 (0 to 99)	0 to 99	20	-	-	ms		

*1 ... Changes in communications parameter settings become effective after resetting.

Advanced Function Setting Level

Setting/monitor values prefixed by "H" are for setting and monitoring via communications.

CompoWay/F Variable type	Modbus Address	Parameter	Attribute	Display	Setting/monitor range	Display	Default setting	Decimal point position	Unit	Set value
D2	0000	Parameter Initialization	Com-mon	PF1	OFF, ON	OFF, ON	OFF	-	-	
	1200	PF1 Setting	Com-mon	PF1	H'00000000: OFF (0) H'00000001: RUN (1) H'00000002: RST (2) H'00000003: R-R (3) H'00000004: ARUN (4) H'00000005: ARST (5) H'00000006: HOLD (6) H'00000007: AHON (7) H'00000008: AHOF (8) H'00000009: ADV (9) H'0000000A: AADV (10) H'0000000B: BAK (11) H'0000000C: ABAK (12) H'0000000D: AT (13) H'0000000E: A-M (14) H'0000000F: PRG (15) H'00000010: PFDP (16) H'00000011: CH (17)	OFF, ON OFF, ON RST, RUN ARUN, ARST HOLD, AHON AHOF, ADV ARUN, ARST AHON, AHOF ADV, AADV BAK, ABAK AT, A-M PRG PFDP, CH	OFF R-R (3)	-	-	
0001	1202	PF2 Setting	Com-mon	PF2	Same as above	Same as above	*1	-	-	
0002	1204	PF1 Monitor/Setting Item 1	CH	PF1	H'00000000: Disabled: OFF (0) H'00000001: PV/Present Set Point/MV: PVSP Only a fixed SP can be set. (1) H'00000002: PV/Deviation: PVSP Monitor only (2) H'00000003: Remaining Standby Time Monitor: SEG.R monitor only (3) H'00000004: Proportional Band (P): P setting is enabled (4) H'00000005: Integral Time (I): I setting is enabled (5) H'00000006: Differential Time (D): D setting is enabled (6) H'00000007: Alarm 1: AL-1 setting is enabled (7) H'00000008: Alarm Upper Limit 1: AL1H setting is enabled (8) H'00000009: Alarm Upper Limit 1: AL1L setting is enabled (9) H'0000000A: Alarm 2: AL-2 setting is enabled (10) H'0000000B: Alarm Upper Limit 2: AL2H setting is enabled (11) H'0000000C: Alarm Upper Limit 2: AL2L setting is enabled (12) H'0000000D: Alarm 3: AL-3 setting is enabled (13) H'0000000E: Alarm Upper Limit 3: AL3H setting is enabled (14) H'0000000F: Alarm Upper Limit 3: AL3L setting is enabled (15) H'00000010: Alarm 4: AL-4 setting is enabled (16) H'00000011: Alarm Upper Limit 4: AL4H setting is enabled (17) H'00000012: Alarm Upper Limit 4: AL4L setting is enabled (18)	Same as above OFF, PVSP PVSP, SEG.R P, I, D AL-1, AL1H, AL1L AL-2, AL2H, AL2L AL-3, AL3H, AL3L AL-4, AL4H, AL4L	PVSP (1)	-	-	

CompoWay/F Variable type	Address	Modbus Address	Parameter	Attribute	Display	Setting/monitor value	Display	Default setting	Decimal point position	Unit	Set value
D2	0003	1206	PF1 Monitor/Setting Item 2	CH	PF 1.2	Same as above	Same as above	OFF	-	-	
	0004	1208	PF1 Monitor/Setting Item 3	CH	PF 1.3	Same as above	Same as above	OFF	-	-	
	0005	120A	PF1 Monitor/Setting Item 4	CH	PF 1.4	Same as above	Same as above	OFF	-	-	
	0006	120C	PF1 Monitor/Setting Item 5	CH	PF 1.5	Same as above	Same as above	OFF	-	-	
	0007	120E	PF2 Monitor/Setting Item 1	CH	PF 2.1	Same as above	Same as above	PVSP (1)	-	-	
	0008	1210	PF2 Monitor/Setting Item 2	CH	PF 2.2	Same as above	Same as above	OFF	-	-	
	0009	1212	PF2 Monitor/Setting Item 3	CH	PF 2.3	Same as above	Same as above	OFF	-	-	
	000A	1214	PF2 Monitor/Setting Item 4	CH	PF 2.4	Same as above	Same as above	OFF	-	-	
	000B	1216	PF2 Monitor/Setting Item 5	CH	PF 2.5	Same as above	Same as above	OFF	-	-	
	000C	1218	Number of Enabled Channels	Common	1H-n	H00000001 to H00000004 (1 to 4)	1 to 4	*2	-	-	
	-	-	RAM Write Mode	Common	rRññ	Backup Mode: BKUP RAM Write Mode: RAM	BKUP, rRñ	BKUP	-	-	
	-	-	Move to Calibration Level	Common	1ñññ	-1999 to 9999	- 9999 to 9999	0	-	-	

*1 The default is "PRG" for models with one input channel and "CH" for models with 2 or 4 input channels.

*2 The initial setting for the number of enabled channels depends on the model, and is the maximum value of the configuration.

Expansion Control Setting Level

Setting/monitor values prefixed by "H" are for setting and monitoring via communications.

CompoWay/F Variable type	Modbus Address	Parameter	Attribute	Display	Setting/monitor range	Display	Default setting	Decimal point position	Unit	Set value
D3	0000	1300	Operation at Power ON	CH	H'00000000: Continue: CONT (0) H'00000001: Reset Status: RST (1) H'00000002: Manual Mode: MANU (2) H'00000003: Ramp Status: RUN (3) H'00000004: Ramp Back: RMPB (4)	CONT, StPb, nRnU	CONT (0)	-	-	
	001A	1334	End Condition	CH	H'00000000: Reset: RST (0) H'00000001: Continue: CONT (1) H'00000002: Fixed SP Mode: FSP (2)	rSE, Cont, FSP	RST (0)	-	-	
	001B	1336	Wait Mode	CH	H'00000000: Wait at Segment End: SEND (0) H'00000001: Always Wait: ALL (1)	SEnd, ALL	SEND (0)	-	-	
	001C	1338	Alarm SP Selection	CH	H'00000000: Present Set Point: PSP (0) H'00000001: Target SP: TSP (1)	PSP, tSP	PSP (0)	-	-	
	001D	133A	Program End ON Time	Common	H'FFFFFFF to H'00000064 (-0.1 to 10.0 (-0.1: ON output continued))	PEnd, 0.0 to 10.0	0.0	1	Seconds	
	0001	1302	SP Tracking	CH	H'00000000: OFF: OFF (0) H'00000001: ON: ON (1)	SPTr, on	OFF	-	-	
	0002	1304	PID Set Automatic Selection Data	CH	H'00000000: PV (0) H'00000001: DV (1) H'00000002: SP (2)	Pu, du	PV (0)	-	-	
	0003	1306	PID Set Automatic Selection Hysteresis	CH	H'0000000A to H'0000270F (0.10 to 99.99)	PdH, 0.10 to 99.99	0.50	2	%FS	
	0004	1308	PV Dead Band	CH	H'00000000 to H'0001869F (0 to 99999)	P-dB, 0 to 99999	0	According to input type	EU	
	0005	130A	Input 1 Cold Junction Compensation	Common	H'00000000: OFF (0) H'00000001: ON (1)	IC1, on	ON	-	-	
	0006	130C	Input 2 Cold Junction Compensation	Common	H'00000000: OFF (0) H'00000001: ON (1)	IC2, on	ON	-	-	
	0007	130E	Input 3 Cold Junction Compensation	Common	H'00000000: OFF (0) H'00000001: ON (1)	IC3, on	ON	-	-	
	0008	1310	Input 4 Cold Junction Compensation	Common	H'00000000: OFF (0) H'00000001: ON (1)	IC4, on	ON	-	-	
	000A	1314	α	CH	H'00000000 to H'00000064 (0.00 to 1.00)	alpha, 0.00 to 1.00	0.65	2	-	
	000B	1316	PV Tracking	CH	H'00000000: OFF: OFF (0) H'00000001: ON: ON (1)	PVTr, on	OFF	-	-	
	000C	1318	Manual Output Method	CH	H'00000000: MV Hold: HOLD (0) H'00000001: Default Value Output: INIT (1)	Hold, Init	HOLD (0)	-	-	
	000D	131A	Manual MV Initial Value	CH	Standard: H'FFFFFFE to H'0000041A (-5.0 to 105.0) Heating/Cooling: H'FFFFFFE6 to H'0000041A (-105.0 to 105.0)	ManMV, -5.0 to 105.0 - 105.0 to 105.0	0.0	1	%	
	000E	131C	MV Change Rate Limit Mode	CH	H'00000000: Mode 0: 0 H'00000001: Mode 1: 1	MR, 0, 1	0	-	-	

Variable type	CompoWay/F Address	Modbus Address	Parameter	Attribute	Display	Setting/monitor range	Display	Default setting	Decimal point position	Unit	Set value	
D3	000F	131E	AT Calculated Gain	CH	AT-CL	H'00000001 to H'00000064 (0.1 to 10.0)	0.1 to 10.0	1.0	1	-		
	0010	1320	AT Hysteresis	CH	AT-H	H'00000001 to H'00000063 (0.1 to 9.9)	0.1 to 9.9	0.2	1	%FS		
	0011	1322	Limit Cycle MV Amplitude	CH	LC-AM	H'00000032 to H'000001F4 (5.0 to 50.0)	5.0 to 50.0	20.0	1	%		
	0012	1324	Temporary AT Excitation Judgement Deviation	CH	TR-ED	H'00000000 to H'0000003E8 (0.0 to 100.0)	0.0 to 100.0	10.0	10.0	1	%FS	
	0013	1326	Bump-less at RUN	CH	RL-ON	H'00000000: OFF (0) H'00000001: ON (1)	OFF, ON	OFF	-	-		
	0018	1330	Operation at Potentiometer Input Error	CH	PN-EE	H'00000000: Stop: (0) H'00000001: Continue: (1)	OFF, ON	OFF	-	-		
	0019	1332	Disturbance Overshoot Adjustment Function	CH	DS-SE	H'00000000: OFF (0) H'00000001: ON (1)	OFF, ON	OFF	-	-		

Program Data

Setting is possible only with CompoWay/F communications.

CompoWay/F Variable type	Modbus Address	Parameter	Attribute	Display	Setting/monitor range	Display	Default setting	Decimal point position	Unit	Set value
DA	0000	Program 1 Number of Segments Used	CH	-	H'00000001 (1) to Number of Segments	-	8	-	-	
	0001	Program 1 PID Set Number	CH	-	H'00000000 to H'00000008 (0 to 8 (0: automatic selection))	-	0	-	-	
	0002	Program 1 Alarm Set Number	CH	-	H'00000001 to H'00000004 (1 to 4)	-	1	-	-	
	0003	Program 1 Wait Band Upper Limit	CH	-	H'00000000 to H'0001869F (0 to 9999 (0: OFF))	-	0	According to input type	EU	
	0004	Program 1 Wait Band Lower Limit	CH	-	H'00000000 to H'0001869F (0 to 9999 (0: OFF))	-	0	According to input type	EU	
	0005	Program 1 Program Repetitions	CH	-	H'00000000 to H'0000270F (0 to 99999)	-	0	-	times	
	0006	Program 1 Program Link Destination	CH	-	H'00000000 to H'00000020 (0 to 32 (0: No Link))	-	0	-	-	
	0010	Program 1 Time Signal 1 Set Segment 1	CH	-	H'00000000 (0) to Number of Segments (0: Disabled)	-	0	-	-	
	0011	Program 1 Time Signal 1 ON Time 1	CH	-	H'00000000 to H'000026E7 (0.00 to 99.59) or H'00000000 to H'0001850F (0.00.0 to 99.59.9)	-	0.00	According to program time unit	According to program time unit	
	0012	Program 1 Time Signal 1 OFF Time 1	CH	-	H'00000000 to H'000026E7 (0.00 to 99.59) or H'00000000 to H'0001850F (0.00.0 to 99.59.9)	-	0.00	According to program time unit	According to program time unit	
	0013	Program 1 Time Signal 1 Set Segment 2	CH	-	H'00000000 (0) to Number of Segments (0: Disabled)	-	0	-	-	
	0014	Program 1 Time Signal 1 ON Time 2	CH	-	H'00000000 to H'000026E7 (0.00 to 99.59) or H'00000000 to H'0001850F (0.00.0 to 99.59.9)	-	0.00	According to program time unit	According to program time unit	
	0015	Program 1 Time Signal 1 OFF Time 2	CH	-	H'00000000 to H'000026E7 (0.00 to 99.59) or H'00000000 to H'0001850F (0.00.0 to 99.59.9)	-	0.00	According to program time unit	According to program time unit	
	0016	Program 1 Time Signal 1 Set Segment 3	CH	-	H'00000000 (0) to Number of Segments (0: Disabled)	-	0	-	-	
	0017	Program 1 Time Signal 1 ON Time 3	CH	-	H'00000000 to H'000026E7 (0.00 to 99.59) or H'00000000 to H'0001850F (0.00.0 to 99.59.9)	-	0.00	According to program time unit	According to program time unit	
	0018	Program 1 Time Signal 1 OFF Time 3	CH	-	H'00000000 to H'000026E7 (0.00 to 99.59) or H'00000000 to H'0001850F (0.00.0 to 99.59.9)	-	0.00	According to program time unit	According to program time unit	
	0020	Program 1 Time Signal 2 Set Segment 1	CH	-	The following are the same as Time Signal 1.	-				
	~	~	CH	-		-				
	0060	Program 1 Time Signal 6 Set Segment 1	CH	-		-				
	~	~	CH	-		-				
	0068	Program 1 Time Signal 6 OFF Time 3	CH	-		-				

Program Data

Setting is possible only with CompoWay/F communications.

Variable type	CompoWay/F Address	Modbus Address	Parameter	Attribute	Display	Setting/monitor range	Display	Default setting	Decimal point position	Unit	Set value
DA	0400	-	Program 1 Segment 1 Segment Set Point	CH	-	SP setting lower limit to SP setting upper limit	-	0	According to input type	EU	
	0401	-	Program 1 Segment 1 Segment Rate of Rise	CH	-	H'00000000 to H'0001869F (0 to 99999)	-	0	According to input type	EU	
	0402	-	Program 1 Segment 1 Segment Time	CH	-	H'00000000 to H'0001850F (0.00.0 to 99.59.9)	-	0.00	According to program time unit	According to program	
	0403	-	Program 1 Segment 1 Wait	CH	-	H'00000000: OFF (0) H'00000001: ON (1)	-	OFF	-	-	
	0410	-	Program 1 Segment 1 Segment Output 1	CH	-	H'00000000: OFF (0) H'00000001: ON (1)	-	OFF	-	-	
	0411	-	Program 1 Segment 1 Segment Output 2	CH	-	H'00000000: OFF (0) H'00000001: ON (1)	-	OFF	-	-	
	0412	-	Program 1 Segment 1 Segment Output 3	CH	-	H'00000000: OFF (0) H'00000001: ON (1)	-	OFF	-	-	
	0413	-	Program 1 Segment 1 Segment Output 4	CH	-	H'00000000: OFF (0) H'00000001: ON (1)	-	OFF	-	-	
	0414	-	Program 1 Segment 1 Segment Output 5	CH	-	H'00000000: OFF (0) H'00000001: ON (1)	-	OFF	-	-	
	0415	-	Program 1 Segment 1 Segment Output 6	CH	-	H'00000000: OFF (0) H'00000001: ON (1)	-	OFF	-	-	
	0416	-	Program 1 Segment 1 Segment Output 7	CH	-	H'00000000: OFF (0) H'00000001: ON (1)	-	OFF	-	-	
	0417	-	Program 1 Segment 1 Segment Output 8	CH	-	H'00000000: OFF (0) H'00000001: ON (1)	-	OFF	-	-	
	0418	-	Program 1 Segment 1 Segment Output 9	CH	-	H'00000000: OFF (0) H'00000001: ON (1)	-	OFF	-	-	
	0419	-	Program 1 Segment 1 Segment Output 10	CH	-	H'00000000: OFF (0) H'00000001: ON (1)	-	OFF	-	-	
	0800	-	Program 1 Segment 2 Segment Set Point	CH	-	The following is the same as Segment 1	-				
	~	-	~	CH	-		-				
	0C00	-	Program 1 Segment 3 Segment Set Point	CH	-		-				
	~	-	~	CH	-		-				
	1000	-	Program 1 Segment 4 Segment Set Point	CH	-		-				
	~	-	~	CH	-		-				
	1400	-	Program 1 Segment 5 Segment Set Point	CH	-		-				
	~	-	~	CH	-		-				

CompoWay/F Variable type	Modbus Address	Parameter	Attrib- ute	Display	Setting/monitor range	Display	Default setting	Decimal point position	Unit	Set value
DA	1800	Program 1 Segment 6 Segment Set Point	CH	-		-				
	~	~	CH	-		-				
	1C00	Program 1 Segment 7 Segment Set Point	CH	-		-				
	~	~	CH	-		-				
	2000	Program 1 Segment 8 Segment Set Point	CH	-		-				
	~	~	CH	-		-				
	2400	Program 1 Segment 9 Segment Set Point	CH	-		-				
	~	~	CH	-		-				
	2800	Program 1 Segment 10 Segment Set Point	CH	-		-				
	~	~	CH	-		-				
	2C00	Program 1 Segment 11 Segment Set Point	CH	-		-				
	~	~	CH	-		-				
	3000	Program 1 Segment 12 Segment Set Point	CH	-		-				
	~	~	CH	-		-				
	3400	Program 1 Segment 13 Segment Set Point	CH	-		-				
	~	~	CH	-		-				
	3800	Program 1 Segment 14 Segment Set Point	CH	-		-				
	~	~	CH	-		-				
	3C00	Program 1 Segment 15 Segment Set Point	CH	-		-				
	~	~	CH	-		-				
	4000	Program 1 Segment 16 Segment Set Point	CH	-		-				
	~	~	CH	-		-				
	4400	Program 1 Segment 17 Segment Set Point	CH	-		-				
	~	~	CH	-		-				
	4800	Program 1 Segment 18 Segment Set Point	CH	-		-				
	~	~	CH	-		-				

Variable type	CompoWay/F Address	Modbus Address	Parameter	Attribute	Display	Setting/monitor range	Display	Default setting	Decimal point position	Unit	Set value
DA	4C00	-	Program 1 Segment 19 Segment Set Point	CH	-		-				
	~	-	~	CH	-		-				
	5000	-	Program 1 Segment 20 Segment Set Point	CH	-		-				
	~	-	~	CH	-		-				
	5400	-	Program 1 Segment 21 Segment Set Point	CH	-		-				
	~	-	~	CH	-		-				
	5800	-	Program 1 Segment 22 Segment Set Point	CH	-		-				
	~	-	~	CH	-		-				
	5C00	-	Program 1 Segment 23 Segment Set Point	CH	-		-				
	~	-	~	CH	-		-				
	6000	-	Program 1 Segment 24 Segment Set Point	CH	-		-				
	~	-	~	CH	-		-				
	6400	-	Program 1 Segment 25 Segment Set Point	CH	-		-				
	~	-	~	CH	-		-				
	6800	-	Program 1 Segment 26 Segment Set Point	CH	-		-				
	~	-	~	CH	-		-				
	6C00	-	Program 1 Segment 27 Segment Set Point	CH	-		-				
	~	-	~	CH	-		-				
	7000	-	Program 1 Segment 28 Segment Set Point	CH	-		-				
	~	-	~	CH	-		-				
	7400	-	Program 1 Segment 29 Segment Set Point	CH	-		-				
	~	-	~	CH	-		-				
	7800	-	Program 1 Segment 30 Segment Set Point	CH	-		-				
	~	-	~	CH	-		-				
	7C00	-	Program 1 Segment 31 Segment Set Point	CH	-		-				
	~	-	~	CH	-		-				

CompoWay/F Variable type	Address	Modbus Address	Parameter	Attri- bute	Display	Setting/monitor range	Display	Default setting	Decimal point position	Unit	Set value
DA	8000	-	Program 1 Segment 32 Segment Set Point	CH	-		-				
	~	-	~	CH	-		-				
DB	8019	-	Program 1 Segment 32 Segment Output 10	CH	-		-				
	0000	-	Program 2 Number of Segments Used	CH	-	The following is the same as Program 1	-				
~	~	-	~	CH	-		-				
F9	~	-	~	CH	-		-				
~	0000	-	Program 32 Number of Segments Used	CH	-		-				
	~	-	~	CH	-		-				

Initialization Due to Changing Parameter Settings

Parameters that are initialized when the settings of related parameters are changed are listed in the *Related parameter* column.

Meaning of Symbols: O: Initialized, -: Not initialized, Δ: Added channels initialized

Changed parameter	Common	CH	CH	CH	CH	Common	CH	CH	Common	CH	CH
Related parameters											
Condition for not initializing parameters	No assignment		Temperature input			• No assignment • Analog input			Position-proportional control		
Scaling Input Values 1 and 2	O (*2)										
SP Upper Limit	O (Upper limit of sensor setting range or Scaling Display Value 2)										
SP Lower Limit	O (Lower limit of sensor setting range or Scaling Display Value 1)										
Automatic Selection Range Upper Limit (PV/DV/SP) (PID 1 to 8)	O (*3)										
Remote SP Upper Limit	O (Upper limit of input setting range or Scaling Display Value 2)										
Remote SP Lower Limit	O (Lower limit of input setting range or Scaling Display Value 1)										
Control/Transfer Output Assignment 1 to 4											
Event Input Assignment 1 to 10											
Auxiliary Output Assignment 1 to 4											
Transfer Output to 1 to 4 Upper Limit	O (*5)										
Transfer Output to 1 to 4 Lower Limit	O (*5)										
Manual MV (Standard/Heating/Cooling)											
SP Mode											
Fixed SP	O										
Dead Band	O										
MV at Reset (Standard/Heating/Cooling)											
MV at PV Error (Standard/Heating/Cooling)											
Input Adjustment Values 1 and 2	O (*5)										
Input Correction 1 and 2	O										
Alarm Values 1 to 4 (Alarm Set 1 to 4)											
Alarm Upper Limit 1 to 4 (Alarm Set 1 to 4)	O (*6)										
Alarm Lower Limit 1 to 4 (Alarm Set 1 to 4)											
Integral Time											
MV Upper Limit (PID 1 to 8)											
MV Lower Limit (PID 1 to 8)											
MV Display Selection											
Bar Graph Display Item											
Number of Enabled Channels											
PV Dead Band	O										
Manual MV Initial Value (Standard/Heating/Cooling)											

Changed parameter	Common	CH	CH	Common	Common	Common	Common	Common	Common	Common	Common
Related parameters	No assignment		Temperature input		Position proportional control						
Condition for not initializing parameters	No assignment										
PV Start	-	-	-	-	-	-	-	-	-	-	O
Program No.	-	-	-	-	O (*11)	O (*11)	O (*11)	O (*11)	O (*11)	O (*11)	O
Number of Segments Used	-	-	-	-	O (*11)	O (*11)	O (*11)	O (*11)	O (*11)	O (*11)	O (*10)
Segment Editing	-	-	-	-	-	-	-	-	-	-	-
Segment Set Point	● (*13)	O	O	O	O (*11)	O (*11)	O (*11)	O (*11)	O (*11)	O (*11)	O (*10)
Segment Time	-	-	-	-	O (*11)	O (*11)	O (*11)	O (*11)	O (*11)	O (*11)	O (*10)
Segment Rate of Rise	● (*13)	O (*13)	O (*13)	O (*13)	O (*11)	O (*11)	O (*11)	O (*11)	O (*11)	O (*11)	O (*10)
Wait	-	-	-	-	O (*11)	O (*11)	O (*11)	O (*11)	O (*11)	O (*11)	O (*10)
Segment Output 1 to 10	-	-	-	-	O (*11)	O (*11)	O (*11)	O (*11)	O (*11)	O (*11)	O (*10)
PID Set Number	-	-	-	-	O (*11)	O (*11)	O (*11)	O (*11)	O (*11)	O (*11)	O (*10)
Alarm Set Number	-	-	-	-	O (*11)	O (*11)	O (*11)	O (*11)	O (*11)	O (*11)	O (*10)
Wait Band Upper Limit	● (*13)	O	O	O	O (*11)	O (*11)	O (*11)	O (*11)	O (*11)	O (*11)	O (*10)
Wait Band Lower Limit	-	-	-	-	O (*11)	O (*11)	O (*11)	O (*11)	O (*11)	O (*11)	O (*10)
Program Repetitions	-	-	-	-	O (*11)	O (*11)	O (*11)	O (*11)	O (*11)	O (*11)	O (*10)
Program Link Destination	-	-	-	-	O (*11)	O (*11)	O (*11)	O (*11)	O (*11)	O (*11)	O (*10)
SP Mode	-	-	-	-	O	O	O	O	O	O	O (*10)
Set Point Offset	●	-	O	O	Δ	Δ	Δ	Δ	Δ	Δ	-
Time Signal 1 to 6 Set Segment 1 to 3	-	-	-	-	O (*11)	O (*11)	O (*11)	O (*11)	O (*11)	O (*11)	O (*10)
Time Signal 1 to 6 ON Segment 1 to 3	-	-	-	-	-	-	-	-	-	-	-
Time Signal 1 to 6 OFF Segment 1 to 3	-	-	-	-	-	-	-	-	-	-	-
Operation at Power ON	-	-	-	-	-	-	-	-	-	-	-
End Condition	-	-	-	-	-	-	-	-	-	-	-

- *1: When the control mode is changed, added channels are initialized in the same way as the related parameters for the Input Type parameter (Δ on the previous page).
- *2: This is the upper and lower limit of the sensor setting range. For a temperature input, this is 4 to 20 mA.
- *3: If this is PV or SP based on the PID Set Automatic Selection Data parameter, then (setting upper limit + setting range \times 0.1); if it is DV, then (setting range \times 1.1).
- *4: Initialized only if the control mode is changed to proportional control (Temperature: Initializes to upper and lower limits of sensor setting range. Analog: Initializes to values set for Scaling Display Values 1 and 2 parameters).
- *5: Upper/lower limit of sensor setting range and Scaling Display Values 1 and 2 parameters are initialized.
- *6: The default setting is 0.
- *7: The corresponding alarm type numbers in all alarm sets are initialized to 0.
- *8: If the Closed/Floating parameter is set to "Float" for position-proportional control, or if the Operation at Potentiometer Input Error parameter is set to "Continue," this is initialized if the integral time is 0.
- *9: If the applicable channel is used for heating/cooling control, this is -100% , otherwise it is 0% . (Therefore in cascade heating/cooling control, the primary loop is 0% and the secondary loop is -100% .)
- *10 All programs and segment parameters will be initialized.
- *11 All programs and segment parameters will be initialized when the Number of Segments parameter is changed.
- *12 The following segments will be initialized when the Step Time/Rate of Rise Programming parameter is set to rate of rise programming. (Nothing will be initialized when this parameter is set to step time.)
When Operation at Reset parameter is set to "Control Stop": All odd segments
When Operation at Reset parameter is set to "Fixed Control": All even segments
- *13 The following segments will be initialized when the Step Time/Rate of Rise Programming parameter is set to rate of rise programming. All segments will be initialized when this parameter is set to step time.
When Operation at Reset parameter is set to "Control Stop": All odd segments
When Operation at Reset parameter is set to "Fixed Control": All even segments
- *14 Initialized only when the Program Output Selection parameter is set for segment outputs.
- *15 Initialized only when the Program Output Selection parameter is set for time signals.

Time Setting and Program List

Program Name: _____
 Program No.: _____ Program Repeats: _____ /2: _____ /3: _____ /4: _____ Program Link Destination: _____ Program Time Unit: HH:MM, MM:SS, MM:SS.D
 Alarm Value 1: _____

Segment	SP	Time	ON	OFF	ON	OFF	ON	OFF	ON	OFF	ON	OFF	ON	OFF
Program Output 1			ON	OFF										
Program Output 2			ON	OFF										
Program Output 3			ON	OFF										
Program Output 4			ON	OFF										
Program Output 5			ON	OFF										
Program Output 6			ON	OFF										
Program Output 7			ON	OFF										
Program Output 8			ON	OFF										
Program Output 9			ON	OFF										
Program Output 10			ON	OFF										
Program														

Parameter Charts

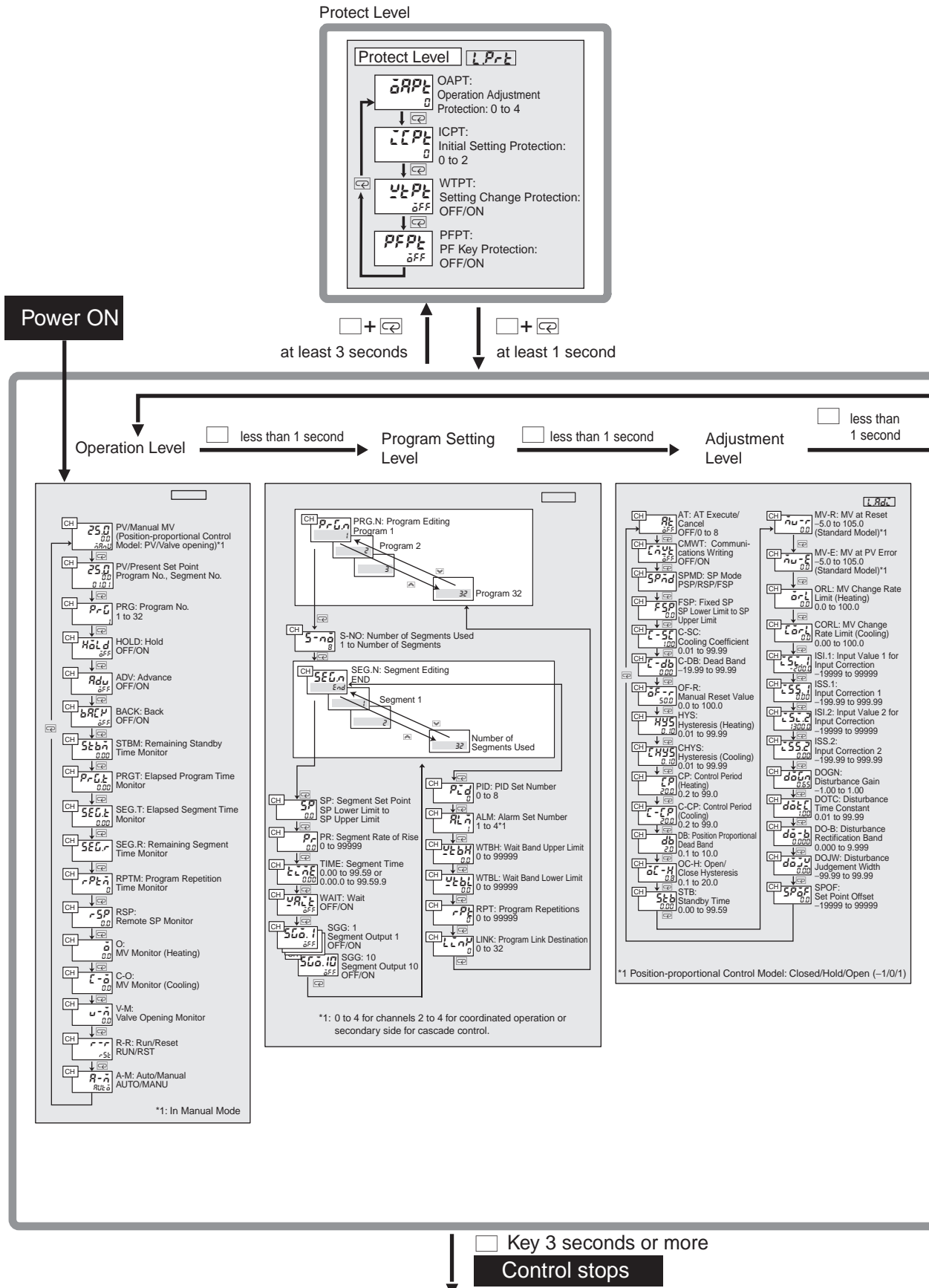

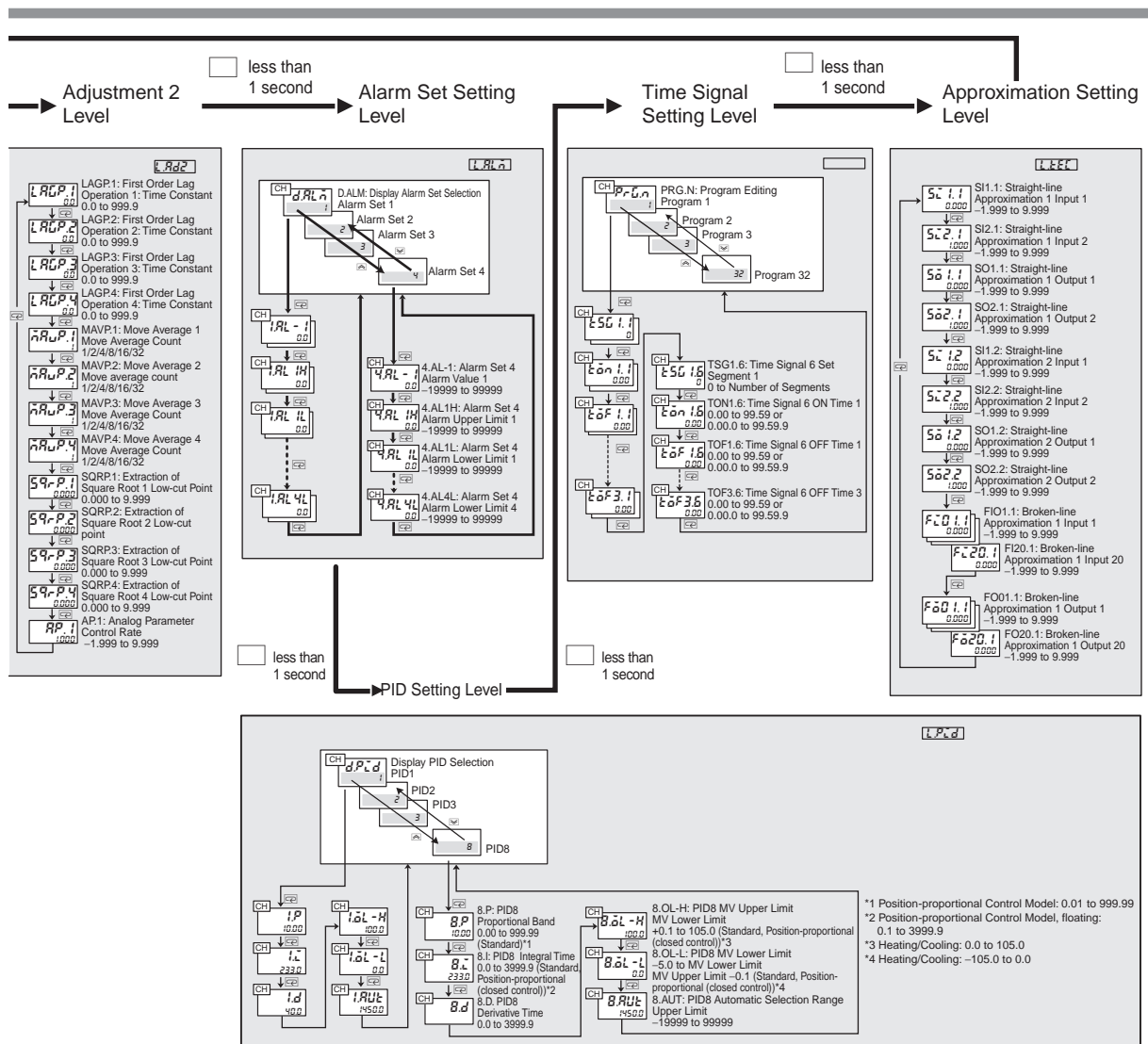
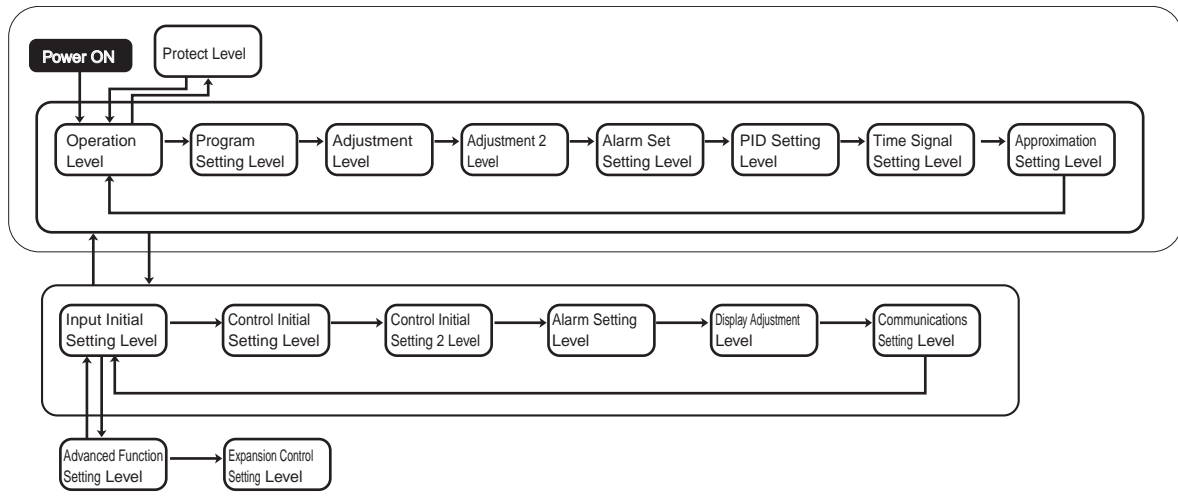

↑ Key 1 second or more
Control starts

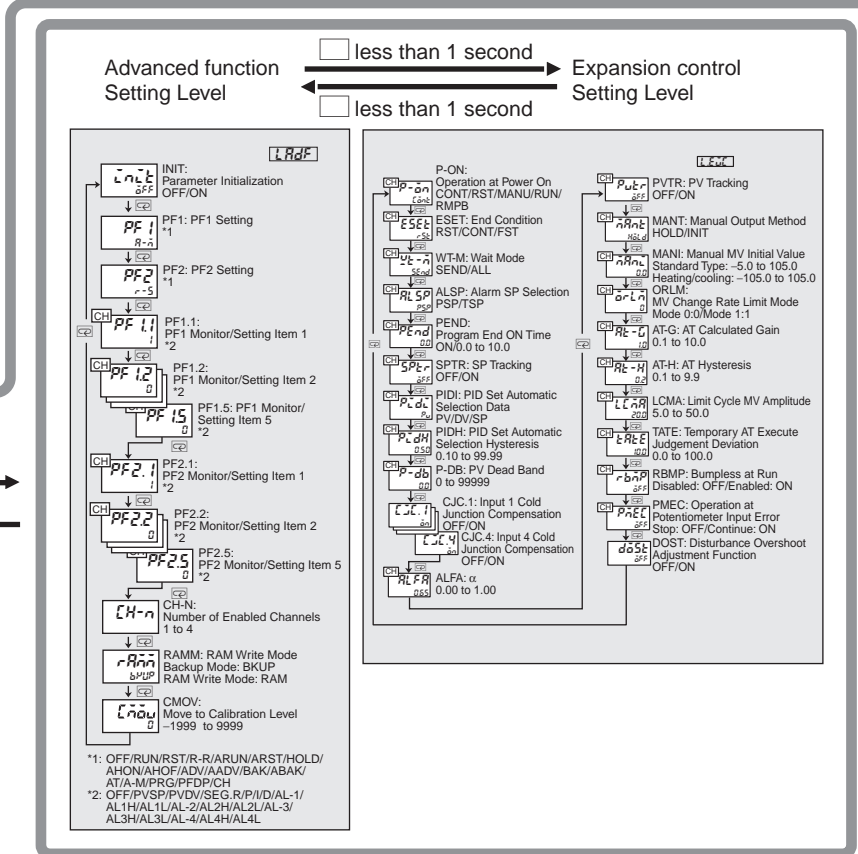
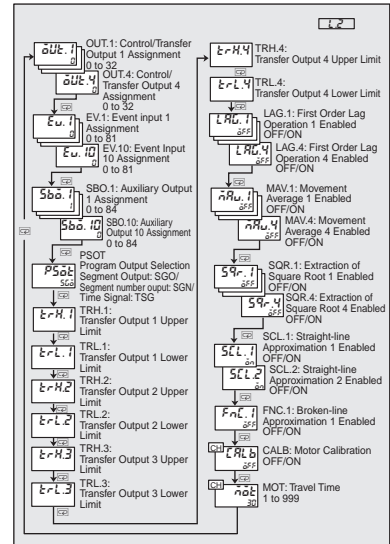
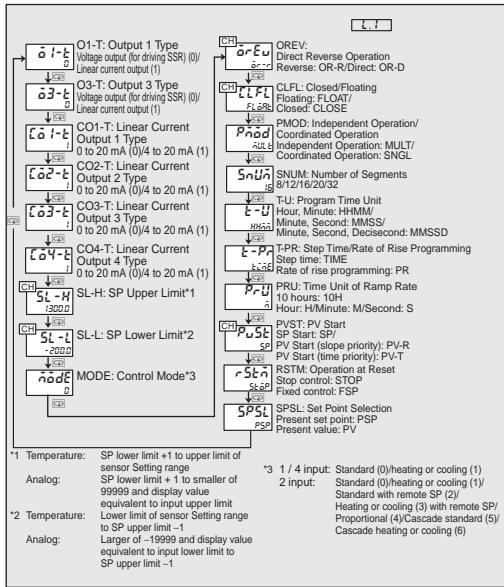
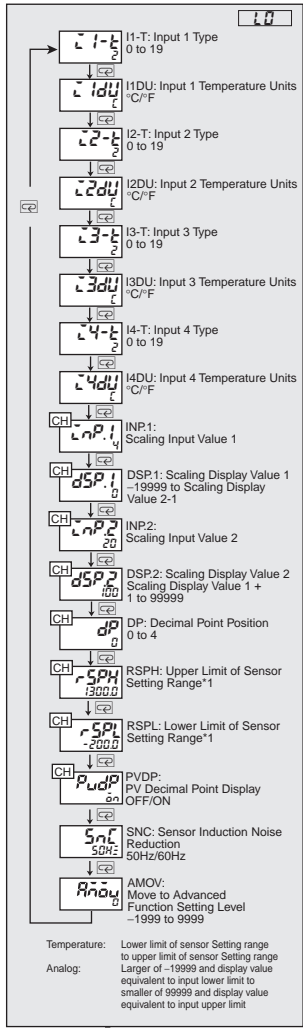
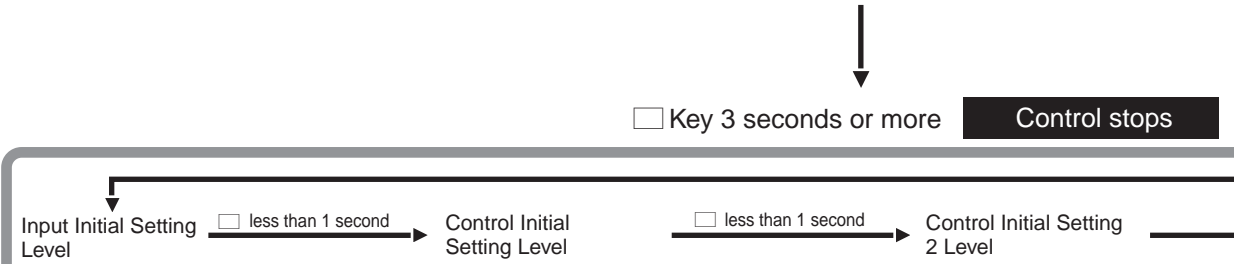

Password: -169

□ less than 1 second

For Input Initial Setting Level, refer to page A-50.

key 1 second or more

Control starts

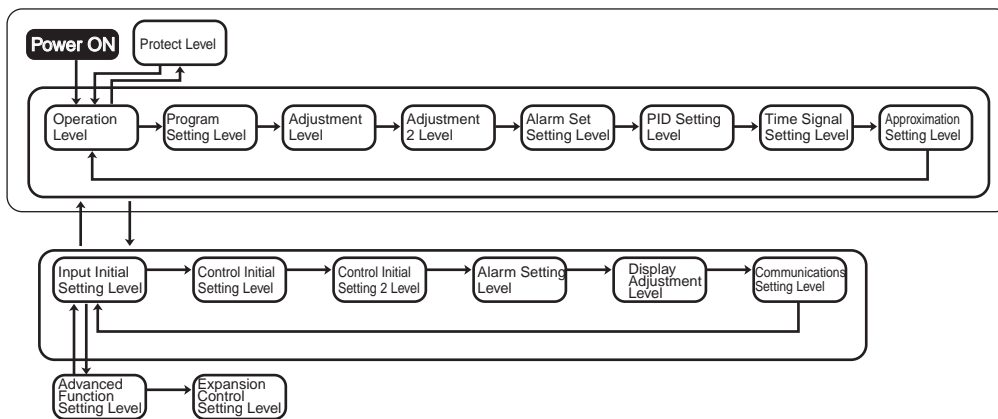
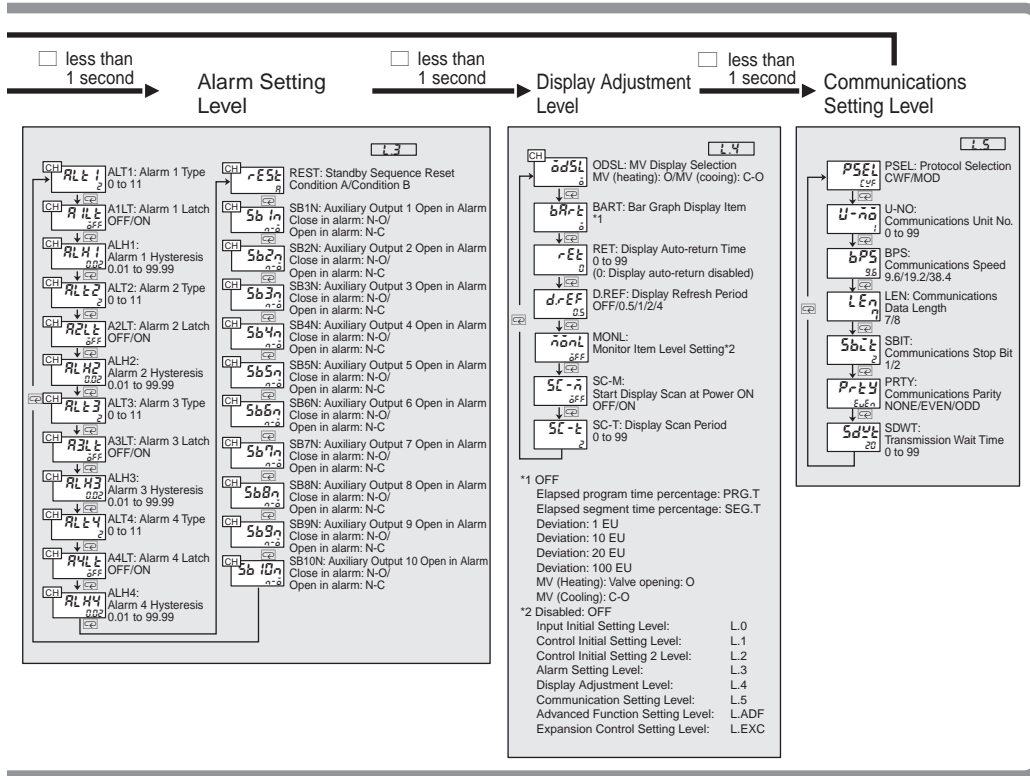

Index

A

- addresses
 - CompoWay/F communications, 6-8, A-6
 - Modbus communications, 7-8, A-6
- Adjustment 2 Level, 8-33, A-17
- Adjustment Level, 8-22, A-16
- Advance, 5-30, 8-11
 - CompoWay/F communications, 6-35
- Advanced Function Setting Level, 8-88, A-35
- advancing program operations, 5-30
- Alarm * Hysteresis, 8-77
- Alarm * Latch, 8-76
- Alarm * Type, 8-75
- alarm hysteresis, 5-25
- alarm latch, 5-26
- Alarm Latch Cancel
 - CompoWay/F communications, 6-33
 - Modbus communications, 7-32
- Alarm Set * Alarm Lower Limits, 8-38
- Alarm Set * Alarm Upper Limits, 8-38
- Alarm Set * Alarm Values, 8-37
- Alarm Set Number, 8-20
- Alarm Set Setting Level, 8-36, A-18
- alarm sets, 4-39, 5-8
- Alarm Setting Level, 8-74, A-31
- Alarm SP Selection, 8-97
- alarm types, 4-38
- alarm values, 4-39
- alarms
 - close in alarm/open in alarm, 5-27
 - SP selection, 5-26
- Alpha, 8-100
- analog input calibration, 9-8
- Analog Parameter 1 (Control Rate), 8-35
- Approximation Setting Level, 8-46, A-22
- ASCII table, A-5
- AT
 - See auto-tuning
- AT Calculated Gain, 8-102
- AT Cancel
 - CompoWay/F communications, 6-28
 - Modbus communications, 7-27
- AT Execute
 - CompoWay/F communications, 6-27
 - Modbus communications, 7-26
- AT Execute/Cancel, 8-23
- AT Hysteresis, 8-102
- Auto/Manual, 4-43, 4-49, 5-42, 8-15
 - CompoWay/F communications, 6-31
 - Modbus communications, 7-30
- Automatic Selection Range Upper Limit, 5-10, 8-42
- auto-tuning, 4-33, 8-23
- Auxiliary Output * Assignment, 8-67
- Auxiliary Output * Open in Alarm, 5-27, 8-79
- Auxiliary Output Assignments, 1-12, 4-37
- auxiliary outputs
 - terminals, 2-12

B

- Back, 8-11
 - CompoWay/F communications, 6-36
- backing program operations, 5-31
- Bar Graph Display Item, 8-81
- broken-line approximation, 5-6, 8-48
- Broken-line Approximation 1 Enabled, 8-72
- Bumpless at RUN, 8-103

C

- calibration data
 - registering, 9-4
- cascade heating/cooling control, 1-10, 4-17
- cascade open/cascade close control, 8-24
- cascade standard control, 1-10, 4-17
- CH2 operation indicator, 1-6
- changing channels, 4-50
- channel indicator, 1-5
- close in alarm/open in alarm, 5-26
- closed control, 4-18
- Closed/Floating, 4-18, 8-59
- CMW operation indicator, 1-6
- cold junction compensator
 - connecting, 9-5
- commands and responses
 - CompoWay/F communications, 6-17
 - Modbus communications, 7-20
- communications
 - monitor settings, A-7
 - program status, A-10
 - status, A-8
 - terminals, 2-16
- Communications Data Length, 8-86
- Communications Monitor, A-12
- Communications Parity, 8-86
- Communications Protocol Selection, 8-85
- Communications Setting Level, 8-84, A-34
- Communications Speed, 8-85
- Communications Stop Bits, 8-86
- Communications Unit No., 8-85
- Communications Writing, 5-50, 8-23
 - CompoWay/F communications, 6-26
 - Modbus communications, 7-24
- Communications Writing OFF/ON, 5-39
- Composite Read from Variable Area
 - CompoWay/F communications, 6-19
- Composite Read Registration
 - CompoWay/F communications, 6-24
- Composite Read Registration Confirmation
 - CompoWay/F communications, 6-25
- Composite Registration Read
 - CompoWay/F communications, 6-25
- CompoWay/F communications, 6-2
- Control Initial Setting 2 Level, 8-63, A-26
- Control Initial Setting Level, 8-55, A-24
- Control Mode, 8-58

- control modes, 4-15
- Control Period, 4-20
- Control Period (Cooling), 8-27
- Control Period (Heating), 8-27
- control ranges, A-4
- Control/Transfer Output Assignments, 1-11, 4-21, 8-64
- control/transfer outputs
 - terminals, 2-11
- Controller Attribute Read
 - CompoWay/F communications, 6-36
- Controller Status Read
 - CompoWay/F communications, 6-38
- Cooling Coefficient, 8-25
- cooling coefficient, 4-16
- coordinated operation, 3-7, 5-12
- correction
 - two-point, 5-3

D

- Dead Band, 8-25
- dead band, 4-15, 4-18
- Decimal Point Position, 8-51
- Derivative Time, 8-40
- dimensions, 2-2
- direct operation, 4-20
- direct operation (cooling), 1-10
- Direct/Reverse Operation, 8-58
- Display Adjustment Level, 8-80, A-33
- Display Alarm Setting Level, 8-37
- Display Auto-return Time, 8-82
- display No. 1, 1-5
- display No. 2, 1-5
- display No. 3, 1-5, 4-5
- Display PID Selection, 8-40
- display ranges, A-4
- Display Refresh Period, 8-82
- display scan, 5-18
- Display Scan Period, 8-83
- Disturbance Gain, 5-13, 8-32
- Disturbance Judgment Width, 8-32
- disturbance overshoot adjustment, 5-13
- Disturbance Overshoot Adjustment Function, 8-104
- Disturbance Rectification Band, 8-32
- Disturbance Time Constant, 5-13, 8-32
- Down Key, 1-7

E

- Echoback Test
 - CompoWay/F communications, 6-39
 - Modbus communications, 7-35
- EEPROM error, 10-3
- Elapsed Program Time Monitor, 8-12
- Elapsed Segment Time Monitor, 8-12
- end codes
 - CompoWay/F communications, 6-5
- End Condition, 5-38, 8-95
- error messages, 10-3
- Event Input Assignments, 1-9, 5-39, 8-66

- event inputs, 5-39
 - terminals, 2-14
- examples
 - typical control, 3-1
- Expansion Control Setting Level, 8-94, A-37
- Extraction of Square Root * Enabled, 8-71
- Extraction of Square Root * Low-cut Point, 8-35
- extraction of square root operations, 5-7

F

- FINS command error, 6-5
- FINS-mini Commands
 - CompoWay/F, 6-6
- first order lag operation, 5-5
- First Order Lag Operation * Enabled, 8-70
- First Order Lag Operation * Time Constant, 8-34
- Fixed SP, 8-24
- floating control, 4-18
- frames
 - CompoWay/F communications, 6-4
- front panel, 1-4
- function codes
 - Modbus communications, 7-7
- Function Key 1, 1-7
- Function Key 2, 1-7
- functions
 - Modbus communications, 7-7

H

- heating/cooling control, 1-10, 4-15
- heating/cooling control with remote SP, 1-10, 4-16
- Hold, 8-10
- holding program operations, 5-30
- hysteresis, 4-31
- Hysteresis (Cooling), 8-26
- Hysteresis (Heating), 8-26

I

- I/O configuration, 1-8
- independent operation, 5-11
- Independent Operation/Coordinated Operation, 8-59
- inferring causes from conditions
 - abnormal measured values, 10-5
- Initial Setting Protection, 5-24, 8-4
- initialization due to setting changes, A-44
- Input * Cold Junction Compensation, 8-99
- Input * Temperature Units, 8-51
- Input * Type, 8-50
- input correction, 5-2
- Input Correction 1, 8-31
- Input Correction 2, 8-31
- input error, 10-3
- Input Initial Setting Level, 8-49, A-23
- input type, 4-10
- input type switch
 - error, 10-3
 - location, 1-9
- Input Value 1 for Input Correction, 8-31
- Input Value 2 for Input Correction, 8-31

- inputs
 - terminals, 2-10
- inspecting indicator accuracy, 9-14
- installation procedure, 2-3
- insulation blocks, 2-17
- Integral Time, 8-40

K

- key operation, 5-39
- keys
 - description, 1-7
 - using, 1-7

L

- Level Key, 1-7
- limit cycle, 4-35
- Limit Cycle MV Amplitude, 8-102
- Linear Current Output * Type, 8-56
- list of services
 - CompoWay/F communications, 6-6

M

- MANU operation indicator, 1-6
- Manual Mode, 4-47
- Manual MV, 8-7
- Manual MV Initial Value, 8-101
- manual operation, 4-47
- Manual Output Method, 8-101
- Manual Reset Value, 8-26
- manual settings, 4-36
- Modbus communications, 7-2
- Mode Key, 1-7
- Monitor Item Level Setting, 8-82
- monitor values
 - reading
 - CompoWay/F communications, 6-17
 - Modbus communications, 7-20
- monitor/setting items, 5-21
- Motor Calibration, 8-72
- motor calibration, 4-18
- motor calibration error, 10-3
- Move Average * Move Average Count, 8-34
- Move to Advanced Function Setting Level, 8-54
- Move to Calibration Level, 8-93
- Move to Protect Level
 - CompoWay/F communications, 6-31
 - Modbus communications, 7-30
- Move to Setting Area 1
 - CompoWay/F communications, 6-30
 - Modbus communications, 7-29
- Movement Average * Enabled, 8-70
- moving average, 5-5
- MV at Error, 5-17
- MV at PV Error, 5-17, 8-29
- MV at Reset, 5-17, 8-29
- MV change rate limit, 5-16
- MV Change Rate Limit (Cooling), 8-30
- MV Change Rate Limit (Heating), 8-30
- MV Change Rate Limit Mode, 8-102
- MV Display Selection, 8-81

- MV limits, 5-15
- MV Lower Limit, 8-41
- MV Monitor (Cooling), 8-14
- MV Monitor (Heating), 8-13
- MV Upper Limit, 8-41

N

- Number of Enabled Channels, 8-92
- Number of Segments, 4-23, 8-60
- Number of Segments Used, 4-24, 8-17

O

- obtaining input shift values, 5-3
- ON/OFF control, 4-31
- Open/Close Hysteresis, 4-18, 8-28
- Operation Adjustment Protection, 5-23, 8-4
- Operation at Potentiometer Error, 8-104
- Operation at Potentiometer Input Error, 4-19
- Operation at Power ON, 4-42, 8-95
- Operation at Reset, 4-41, 8-62
- operation commands
 - CompoWay/F communications, 6-13
 - Modbus communications, 7-15
- operation indicators, 1-6
- Operation Level, 8-6, A-13
- OUT1 operation indicator, 1-6
- OUT2 operation indicator, 1-6
- OUT3 operation indicator, 1-6
- OUT4 operation indicator, 1-6
- Output * Type, 8-56
- Output Assignments, 4-21
- output calibration, 9-12
- output state at error, 10-3
- output type, 4-21
- overlap band, 4-15, 8-25, 10-8

P

- panel cutout dimensions, 2-2
- Parameter Initialization, 8-89
 - CompoWay/F communications, 6-32
 - Modbus communications, 7-31
- parameters
 - saving, 4-4
- part names and functions, 1-4
- PF Key Protection, 5-24, 8-4, 8-5
- PF settings, 5-20
- PF1 Monitor/Setting Items, 8-91
- PF1 Setting, 8-89
- PF2 Monitor/Setting Items, 8-91
- PF2 Setting, 8-89
- PID set automatic selection, 5-10
- PID Set Automatic Selection Data, 8-98
- PID Set Automatic Selection Hysteresis, 8-98
- PID Set Number, 8-19
- PID sets, 1-2, 5-10
- PID Setting Level, 8-39, A-19
- PID* Automatic Selection Range Upper Limit, 8-42
- position-proportional control, 4-16
- Position-proportional Dead Band, 4-18, 8-27

- potentiometer input
 - terminals, 2-14
- potentiometer input error, 10-3
- power supply
 - terminals, 2-10
- precautions
 - operating precautions, 4-52
 - wiring, 2-9
- Present Value (PV)/Present Set Point, 8-9
- procedures
 - using two-point correction, 5-3
- program data, A-39
- Program Editing, 8-17, 8-44
- Program End ON Time, 8-97
- program end output, 5-36
- Program Execution Repetition Monitor, 8-12
- Program Link Destination, 8-21
- program links, 5-31
- Program No., 8-10
- program number, 5-40
- Program Output Selection, 8-68
- Program Repetitions, 8-21
- program repetitions, 5-31
- Program Setting Level, 8-16, A-14
- program settings, 3-5, 4-23
- program status
 - communications, A-10
- Program Time Unit, 8-60
- Proportional Band, 8-40
- proportional control, 1-10, 4-16
- Protect Key, 1-7
- Protect Level, 8-3, A-12
- protection, 5-23
- pulling out the Controller, 2-3
- PV Dead Band, 8-99
- PV Decimal Point Display, 8-53
- PV Start, 8-61
- PV start, 5-37
- PV Tracking, 8-100

R

- RAM Write Mode, 8-92
- ramp back, 4-42
- rate of rise programming, 5-28
- ratings, A-2
- reading
 - monitor values
 - CompoWay/F communications, 6-17
 - Modbus communications, 7-20
 - set values
 - CompoWay/F communications, 6-18
 - Modbus communications, 7-21
- Remaining Segment Time Monitor, 8-12
- Remaining Standby Time Monitor, 8-12
- Remote SP Lower Limit, 8-52
- Remote SP Monitor, 8-13
- Remote SP Upper Limit, 8-52
- resetting
 - operation, 4-41
- resistance thermometer calibration, 9-10
- reverse operation, 4-20

- reverse operation (heating), 1-10
- RS-485, 2-16
- RSP input error, 10-3
- RSP operation indicator, 1-6
- RST operation indicator, 1-6
- Run/Reset, 8-15
 - CompoWay/F communications, 6-26
 - Modbus communications, 7-25
- Run/Reset Key, 1-7

S

- Save RAM Data
 - CompoWay/F communications, 6-30
 - Modbus communications, 7-28
- scaling, 4-11
- Scaling Display Values, 8-51
- Scaling Input Values, 8-51
- Segment Editing, 8-18
- segment number output, 5-36
- Segment Output, 8-19
- segment outputs, 5-34
- Segment Rate of Rise, 8-18
- Segment Set Point, 4-24
- Segment Time, 4-24, 8-18
- Sensor Induction Noise Reduction, 8-54
- sensor input setting ranges, A-4
- Set Point Offset, 8-32
- Set Point Selection, 8-62
- Set Value Compound Write
 - CompoWay/F communications, 6-23
- set values, 4-6
 - reading
 - CompoWay/F communications, 6-18
 - Modbus communications, 7-21
 - writing
 - CompoWay/F communications, 6-21
 - Modbus communications, 7-23
 - writing in Protect Level
 - CompoWay/F communications, 6-21
 - Modbus communications, 7-22
- setting and changing the SP, 4-23
- setting areas, 6-15
- Setting Change Protection, 5-24, 8-4
- setting communications parameters, 5-49
- setting examples
 - initial settings, 4-7
- setting levels, 4-2
- settings
 - list, A-6
 - saving, 4-6
- Software Reset
 - CompoWay/F communications, 6-30
 - Modbus communications, 7-29
- SP limits, 5-9, 8-57
- SP Mode, 8-24
 - CompoWay/F communications, 6-33
 - Modbus communications, 7-32
- SP mode, 5-43
- SP modes, 5-31
- SP Tracking, 5-32, 8-98
- specifications, A-2

- standard control, 1-10, 3-2, 4-15
- standard control with remote SP, 1-10, 4-16
- standby, 5-38
- standby sequence, 5-25
- Standby Sequence Reset, 5-25, 8-78
- Standby Time, 8-28
- Start Display Scan after Power ON, 8-83
- status
 - communications, A-8
- Step Time/Rate of Rise Programming, 8-60
- straight-line approximation, 8-47
- Straight-line Approximation * Enabled, 8-71
- SUB1 operation indicator, 1-6
- SUB2 operation indicator, 1-6
- SUB3 operation indicator, 1-6
- SUB4 operation indicator, 1-6

T

- temperature unit, 4-14
- Temporary AT Execution Judgement Deviation, 8-102
- terminal arrangements, 2-4
- thermocouple calibration, 9-5
- three-position control, 4-31
- Time Signal, 5-33
- Time Signal * OFF Times, 8-45
- Time Signal * ON Times, 8-45
- Time Signal * Set Segments, 8-44
- Time Signal Setting Level, 8-43, A-21
- Time Unit of Ramp Rate, 8-61
- transfer output, 5-47
 - scaling, 5-48
 - using, 5-47
- Transfer Output * Lower Limit, 8-69
- Transfer Output * Upper Limit, 8-69
- transfer protocol
 - CompoWay/F communications, 6-3
 - Modbus communications, 7-3
- Transmission Wait Time, 8-87
- Travel Time, 8-73
- troubleshooting, 10-1

U

- Up Key, 1-7
- user calibration, 9-1, 9-4
 - completion information, 9-3
- using auxiliary outputs, 4-37

V

- Valve Opening Monitor, 8-14
- variable areas, 6-7
- variable types, 6-7

W

- Wait, 8-18
- Wait Band Lower Limit, 8-20
- Wait Band Upper Limit, 8-20
- Wait Mode, 8-96
- wait operation, 5-32
- wiring, 2-10

- Write Mode
 - CompoWay/F communications, 6-28
 - Modbus communications, 7-27
- Write via communication, 5-50
- writing
 - set values
 - CompoWay/F communications, 6-21
 - Modbus communications, 7-23
- writing in Protect Level
 - set values
 - CompoWay/F communications, 6-21
 - Modbus communications, 7-22

OMRON Corporation Industrial Automation Company

Tokyo, JAPAN

Contact: www.ia.omron.com

Regional Headquarters

OMRON EUROPE B.V.

Wegalaan 67-69-2132 JD Hoofddorp
The Netherlands

Tel: (31)2356-81-300/Fax: (31)2356-81-388

OMRON ELECTRONICS LLC

One Commerce Drive Schaumburg,
IL 60173-5302 U.S.A.

Tel: (1) 847-843-7900/Fax: (1) 847-843-7787

OMRON ASIA PACIFIC PTE. LTD.

No. 438A Alexandra Road # 05-05/08 (Lobby 2),
Alexandra Technopark,
Singapore 119967

Tel: (65) 6835-3011/Fax: (65) 6835-2711

OMRON (CHINA) CO., LTD.

Room 2211, Bank of China Tower,
200 Yin Cheng Zhong Road,
PuDong New Area, Shanghai, 200120, China

Tel: (86) 21-5037-2222/Fax: (86) 21-5037-2200

Authorized Distributor:

© OMRON Corporation 2006 All Rights Reserved.
In the interest of product improvement,
specifications are subject to change without notice.

Cat. No. H201-E1-03

0913