

E3X-DA-N

Digital Fiber Amplifier

Amplifier

- Select from Three Clear Display Methods:
Digital incident level
Digital percent level
LED Bar Display
- Save-wiring Connector
- Auto Power Control

Mobile Console

- Remote Tuning and Adjustment
- "Copy and Paste" Function
- "Mode Lock" Function



Ordering Information:

Amplifier Units, Connectors, Mobile Console, and Accessories

■ Amplifier Units

Amplifier Units with Cables

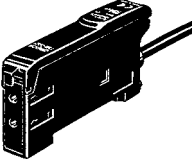
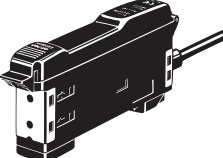
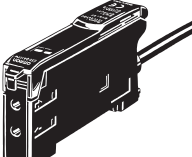
Item		Appearance	Control output	Model	
				NPN output	PNP output
Standard models			ON/OFF output	E3X-DA11-N	E3X-DA41-N
Monitor-output models			ON/OFF output Monitor output	E3X-DA21-N	E3X-DA51-N
Mark-detecting models	Blue LED		ON/OFF output	E3X-DAB11-N	E3X-DAB41-N
	Green LED			E3X-DAG11-N	E3X-DAG41-N
Infrared models			E3X-DAH11-N	E3X-DAH41-N	
Water-resistant models				E3X-DA11V	E3X-DA41V
Twin-output models				E3X-DA11TW	E3X-DA41TW

Amplifier Units with Standard Connectors

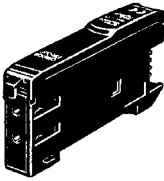
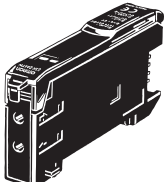
Item		Appearance	Applicable Connector (order separately)		Control output	Model	
						NPN output	PNP output
Standard models			Master	E3X-CN11	ON/OFF output	E3X-DA6	E3X-DA8
			Slave	E3X-CN12			
Monitor-output models			Master	E3X-CN21	ON/OFF output Monitor output	E3X-DA7	E3X-DA9
			Slave	E3X-CN22			
Mark-detecting models	Blue LED		Master	E3X-CN11	ON/OFF output	E3X-DAB6	E3X-DAB8
	Green LED		Slave	E3X-CN12			
			Master	E3X-CN11		E3X-DAG6	E3X-DAG8
			Slave	E3X-CN12			
Infrared models			Master	E3X-CN11		E3X-DAH6	E3X-DAH8
			Slave	E3X-CN12			
Twin-output models			Master	E3X-CN21	E3X-DA6TW	E3X-DA8TW	
			Slave	E3X-CN22			

Amplifier Units with M8 Connectors

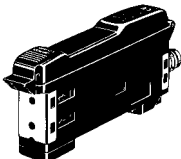

Item		Appearance	Applicable Connector (order separately)		Control output	Model	
						NPN output	PNP output
Standard models			XS3F-M421-40□-A	XS3F-M422-40□-A	ON/OFF output	E3X-DA14V	E3X-DA44V

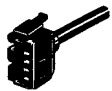
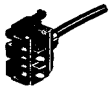
Amplifier Unit Connectors (Order Separately)

Item	Appearance	Cable length	No. of conductors	Model
Master Connector		2 m	3	E3X-CN11
			4	E3X-CN21
Slave Connector			1	E3X-CN12
			2	E3X-CN22

Note Stickers for Connectors are included as accessories.

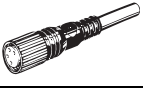
Sensor I/O Connectors (Order Separately)

Size	Cable specifications	Appearance	Cable type		Model
M8	Standard cable	Straight connector 	2 m	Four-core cable	XS3F-M421-402-A
			5 m		XS3F-M421-405-A
		L-shaped connector 	2 m		XS3F-M422-402-A
			5 m		XS3F-M422-405-A

■ Mobile Console (Order Separately)

Appearance	Model	Remarks
	E3X-MC11	Mobile Console with head, cable, and AC adapter provided as accessories. Power supply method: chargeable battery
	E3X-MC11-C1	Mobile Console
	E3X-MC11-H1	Head
	E39-Z12-1	Cable (1.5 m)

■ Combining Amplifier Units and Connectors

Refer to the following tables when placing an order. Basically Amplifier Units and Connectors are sold separately.

Amplifier Units		
Type	NPN	PNP
Standard models	E3X-DA6	E3X-DA8
Mark-detecting models	E3X-DAB6	E3X-DAB8
	E3X-DAG6	E3X-DAG8
Infrared models	E3X-DAH6	E3X-DAH8
Monitor-output models	E3X-DA7	E3X-DA9
Twin-output models	E3X-DA6TW	E3X-DA8TW

+

Applicable Connectors (Order Separately)	
Master Connector	Slave Connector
E3X-CN11 (3-wire)	E3X-CN12 (1-wire)
E3X-CN21 (4-wire)	E3X-CN22 (2-wire)

+

When Using 5 Amplifier Units

Amplifier Units (5 Units)

1 Master Connector + 4 Slave Connectors

■ Accessories (Order Separately)

Mounting Brackets

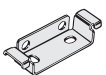
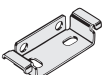
Appearance	Applicable model	Model	Quantity
	E3X-DA□-N E3X-DA□	E39-L143	1
	E3X-DA□V	E39-L148	1

End Plate

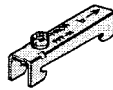
Appearance	Model	Quantity
	PFP-M	1

Operating Instructions Sticker

Model	Remarks
E39-Y1	Attach near the sensor.

Specifications: Amplifier Units

■ Ratings/Characteristics

Amplifier Units with Cables

Item		Standard models	Monitor-output models	Mark-detecting models		Infrared models	Water-resistant models	Twin-output models	
Output type	NPN output	E3X-DA11-N	E3X-DA21-N	E3X-DAB11-N	E3X-DAG11-N	E3X-DAH11-N	E3X-DA11V	E3X-DA11TW	
	PNP output	E3X-DA41-N	E3X-DA51-N	E3X-DAB41-N	E3X-DAG41-N	E3X-DAH41-N	E3X-DA41V	E3X-DA41TW	
Light source (wavelength)		Red LED (660 nm)		Blue LED (470 nm)	Green LED (525 nm)	Infrared LED (870 nm)	Red LED (660 nm)		
Supply Voltage		12 to 24 VDC ± 10%, ripple (p-p) 10% max.							
Power consumption		Normally: 960 mW max. (current consumption: 40 mA max. at power supply voltage of 24 VDC) Eco Mode: 720 mW max. (current consumption: 30 mA max. at power supply voltage of 24 VDC) Digital display not lit: 600 mW max. (current consumption: 25 mA max. at power supply voltage of 24 VDC)							
Control output	ON/OFF output	NPN/PNP (depends on model) open collector; load current: 50 mA max.; residual voltage: 1 V max.; Light ON/Dark ON mode selector							
	Monitor output	---	Load 1 to 5 VDC, 10 kΩ min.	---					
Circuit protection		Reverse polarity, output short-circuit, mutual interference prevention (supported for up to 10 Units)							
Response time		Super-high-speed mode: 0.25 ms for operation and reset respectively Standard mode: 1 ms for operation and reset respectively Super-long-distance mode: 4 ms for operation and reset respectively						Super-high-speed mode: 0.5 ms for operation and reset respectively Standard mode: 2 ms for operation and reset respectively Super-long-distance mode: 7 ms for operation and reset respectively	
Sensitivity setting		Teaching or manual method							
Functions	Timer function	OFF-delay timer: 0 to 200 ms, 1 to 20 ms (set in 1 ms units); 20 to 200 ms (set in 5 ms units)							
	Automatic power control (APC)	Fiber-optic current digital control				---			Fiber-optic current digital control
	Zero-reset	Display can be reset to zero when required (negative values can be displayed).							
	Initial reset	Settings can be returned to defaults as required.							
	Monitor focus	---	Upper and lower limits can be set as required for every 100 digital values.	---					
Display		Operation indicator (orange), 7-segment digital incident level display (red), 7-segment digital incident level percentage display (red), threshold and excess gain 2-color indication bar (green and red), 7-segment digital threshold display (red)							
Display timing		Switching between normal/peak-hold/bottom-hold possible							
Display orientation		Switching between normal/reverse possible							
Optical axis adjustment		Optical axis adjustment possible (hyper-flashing function)							
Ambient illumination (receiver side)		Incandescent lamp: 10,000 lux max. Sunlight: 20,000 lux max.							
Ambient temperature		Operating: Groups of 1 to 3 Amplifiers: -25°C to 55°C Groups of 4 to 11 Amplifiers: -25°C to 50°C Groups of 12 to 16 Amplifiers: -25°C to 45°C (with no icing or condensation) Storage: -30°C to 70°C (with no icing or condensation)							
Ambient humidity		Operating and storage: 35% to 85% (with no condensation)							
Insulation resistance		20 MΩ min. (at 500 VDC)							
Dielectric strength (destruction)		1,000 VAC at 50/60 Hz for 1 minute							
Vibration resistance (destruction)		10 to 55 Hz with a 1.5-mm double amplitude for 2 hrs each in X, Y and Z directions							
Shock resistance (destruction)		500 m/s ² , for 3 times each in X, Y and Z directions							
Enclosure rating		IEC 60529 IP50 (with Protective Cover attached)					IEC 60529 IP66 (with Protective Cover attached)	IEC 60529 IP50 (with Protective Cover attached)	
Connection method		Pre-wired (standard cable length: 2 m)							
Weight (packed state)		Approx. 100 g					Approx. 110 g	Approx. 100 g	
Material	Case	Polybutylene terephthalate (PBT)							
	Cover	Polycarbonate					Polyethersulfone	Polycarbonate	
Accessories		Instruction sheet							

Amplifier Units with Connectors

(Specifications different to those for Amplifier Units with cables)

Item		Standard models	Monitor-output models	Mark-detecting models		Infrared models	Water-resistant models (See note.)	Twin-output models
Output type	NPN output	E3X-DA6	E3X-DA7	E3X-DAB6	E3X-DAG6	E3X-DAH6	E3X-DA14V	E3X-DA6TW
	PNP output	E3X-DA8	E3X-DA9	E3X-DAB8	E3X-DAG8	E3X-DAH8	E3X-DA44V	E3X-DA8TW
Connection method		Standard connector					M8 connector	Standard connector
Weight (packed state)		Approx. 55 g					Approx. 65 g	Approx. 55 g

Note: The dielectric strength for water-resistant models is 500 VAC at 50/60 Hz for 1 minute.

Connectors

Item		E3X-CN11/21/22	E3X-CN12
Rated current		2.5 A	
Rated voltage		50 V	
Contact resistance		20 mΩ max. (20 mVDC max., 100 mA max.) (See note 1.)	
No. of insertions		50 times (See note 2.)	
Material	Housing	Polybutylene terephthalate (PBT)	
	Contacts	Phosphor bronze/gold-plated nickel	
Weight (packed state)		Approx. 55 g	Approx. 25 g

- Note:**
1. The figure is for connection to the Amplifier Unit and the adjacent Connector. It does not include the conductor resistance of the cable.
 2. The figure for the number of insertions is for connection to the Amplifier Unit and the adjacent Connector.

Mobile Console

Item	E3X-MC11
Supply voltage	Charged with AC adapter
Connection method	Connected via adapter
Weight (packed state)	Approx. 580 g (Console only: 120 g)

Ordering Information: Fiber Units











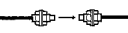
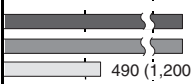
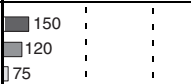
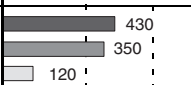

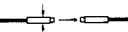
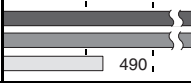

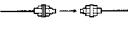
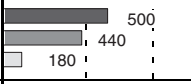

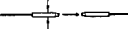

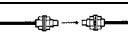
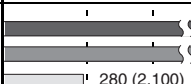
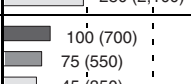
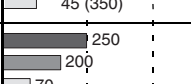
Through-beam Fiber Units

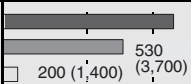

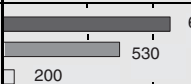
Refer to the end of the following table for notes and precautions.

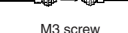
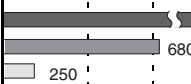

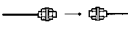
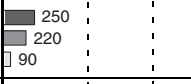
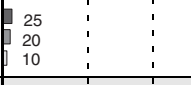

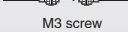
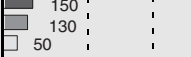

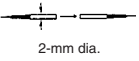
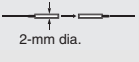
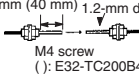
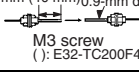
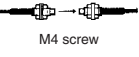
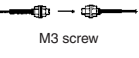
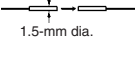

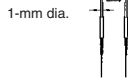
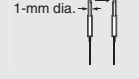
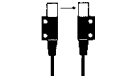

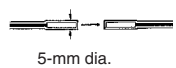
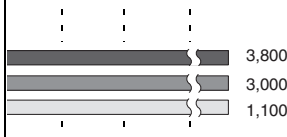
Note: Specifications for the E3X-DA□V and E3X-DA□TW are included in those for the E3X-DA□N, and specifications for the E3X-DAG□-N are included in those for the E3X-DAB□-N.

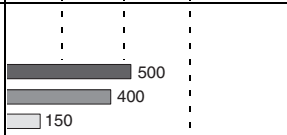
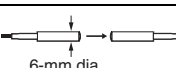
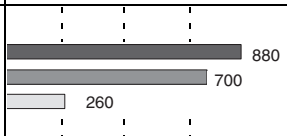
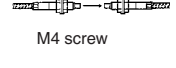
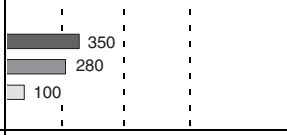
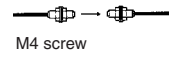
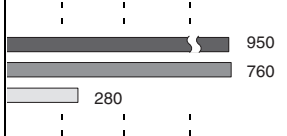
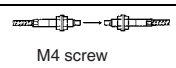
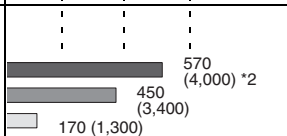
 Indicates models that allow free cutting. Models without this mark do not allow free cutting.

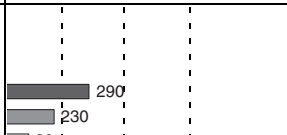
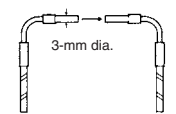
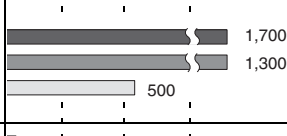
 : Super-long-distance mode  : Standard mode  : Super-high-speed mode

Application	Features	Appearance	Applicable Amplifier Unit	Sensing distance (mm) (Values in parentheses: when using the E39-F1 Lens Unit)	Standard object *3 (min. sensing object: opaque)	Model	Permissible bending radius
Long distance	M4 	 M4 screw	E3X-DA□-N	 1,660 (4,000) 1,330 (3,200) 490 (1,200)	1.4-mm dia. (0.02-mm dia.)	E32-T11L	25 mm
			E3X-DAB11-N	 150 120 75			
			E3X-DAH□-N	 430 350 120			
	3-mm dia. 	 3-mm dia.	E3X-DA□-N	 1,660 (4,000) 1,330 (3,200) 490 (1,200)	1.4-mm dia. (0.01-mm dia.)	E32-T12L	
	M3 	 M3 screw	E3X-DA□-N	 500 440 180	0.9-mm dia. (0.01-mm dia.)	E32-T21L	10 mm
2-mm dia.; small diameter 	 2-mm dia.	E3X-DA□-N	 500 440 180	E32-T22L			
General-purpose	M4 	 M4 screw	E3X-DA□-N	 950 (4,000) *2 760 (4,000) *2 280 (2,100)	1.0-mm dia. (0.01-mm dia.)	E32-TC200	25 mm
			E3X-DAB11-N	 100 (700) 75 (550) 45 (350)			
			E3X-DAH□-N	 250 200 70			
	M4 screw 	 M4 screw	E3X-DA□-N	 670 (4,000) *2 530 (3,700) 200 (1,400)		E32-T11R	1 mm
	3-mm dia. 	 3-mm dia.	E3X-DA□-N	 670 530 200		E32-T12R	
	M3; possible to mount the reflective side-view conversion attachment E39-F5 	 M3 screw	E3X-DA□-N	 850 680 250		E32-TC200A	25 mm
	M3; for detecting minute sensing objects 	 M3 screw	E3X-DA□-N	 250 220 90	0.5-mm dia. (0.01-mm dia.)	E32-TC200E	10 mm
			E3X-DAB11-N	 25 20 10			
	M3 screw; small diameter 	 M3 screw	E3X-DA□-N	 150 130 50		E32-T21R	1 mm

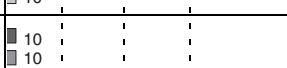
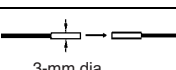
Application	Features	Appearance	Applicable Amplifier Unit	Sensing distance (mm) (Values in parentheses: when using the E39-F1 Lens Unit)	Standard object *3 (min. sensing object: opaque)	Model	Permissible bending radius
Thin fiber	2-mm dia.; for detecting minute sensing objects (Free-cut)	 2-mm dia.	E3X-DA□-N	250 220 90	0.5-mm dia. (0.01-mm dia.)	E32-T22	10 mm
	2-mm dia.; small diameter (Free-cut)	 2-mm dia.	E3X-DA□-N	150 130 50		E32-T22R	1 mm
	1.2-mm dia.; with sleeve (Free-cut)	90 mm (40 mm) 1.2-mm dia.  M4 screw (): E32-TC200B4	E3X-DA□-N E3X-DAB11-N	950 760 280 100 75 45	1.0-mm dia. (0.01-mm dia.)	E32-TC200B E32-TC200B4	25 mm
	0.9-mm dia.; with sleeve (Free-cut)	90 mm (40 mm) 0.9-mm dia.  M3 screw (): E32-TC200F4	E3X-DA□-N	250 220 90	0.5-mm dia. (0.01-mm dia.)	E32-TC200F E32-TC200F4	10 mm
Flexible (resists break-ing) (R4)	Ideal for mounting on moving sections (R4) (Free-cut)	 M4 screw	E3X-DA□-N	850 (4,000) *2 680 (3,600) 250 (1,300)	1.0-mm dia. (0.01-mm dia.)	E32-T11	4 mm
		 M3 screw	E3X-DA□-N	220 200 80	0.5-mm dia. (0.01-mm dia.)	E32-T21	
		 1.5-mm dia.	E3X-DA□-N	220 200 80		E32-T22B	
Side-view	Long distance; space-saving (Free-cut)	 3-mm dia.	E3X-DA□-N	570 460 170	1.0-mm dia. (0.01-mm dia.)	E32-T14L	25 mm
			E3X-DAB11-N	50 40 25			
			E3X-DAH□-N	150 120 40			
	Space-saving (Free-cut)	 3-mm dia.	E3X-DA□-N	270 210 90		E32-T14LR	1 mm
	Suitable for detecting minute sensing objects (Free-cut)	 1-mm dia.	E3X-DA□-N	150 130 55	0.5-mm dia. (0.01-mm dia.)	E32-T24	10 mm
	Suitable for detecting minute sensing objects; small diameter (Free-cut)	 1-mm dia.	E3X-DA□-N	60 50 25		E32-T24R	1 mm
	Screw-mounting type (Free-cut)		E3X-DA□-N E3X-DAB11-N E3X-DAH□-N	4,000 3,400 1,250 320 260 160 1,120 900 330	4.0-mm dia. (0.01-mm dia.)	E32-T14	25 mm

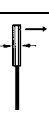
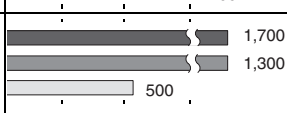
Application	Features	Appearance	Applicable Amplifier Unit	Sensing distance (mm) (Values in parentheses: when using the E39-F1 Lens Unit)	Standard object *3 (min. sensing object: opaque)	Model	Permissible bending radius
Chemical-resistant	Fluorescein-covered; withstands chemicals and harsh environments (operating ambient temperature: -30°C to 70°C) (Free-cut)	 5-mm dia.	E3X-DA□-N		4.0-mm dia. (0.01-mm dia.)	E32-T12F	40 mm
	Fluorescein covered; side-view; withstands chemicals and harsh environments (operating ambient temperature: -30°C to 70°C) (Free-cut)	 5-mm dia.	E3X-DA□-N		3.0-mm dia. (0.01-mm dia.)	E32-T14F	
	Fluorescein; withstands chemicals and harsh environments (operating ambient temperature: -40°C to 200°C)	 6-mm dia.	E3X-DA□-N		1.0-mm dia. (0.01-mm dia.)	E32-T81F	10 mm
Heat-resistant	Resists 200°C; flexible (R10); fiber sheath material: fluororesin (operating ambient temperature: -40°C to 200°C)	 M4 screw	E3X-DA□-N		1.0-mm dia. (0.01-mm dia.)	E32-T81R	10 mm
	Resists 150°C *4; fiber sheath material: fluororesin (operating ambient temperature: -40°C to 150°C) (Free-cut)	 M4 screw	E3X-DA□-N		1.5-mm dia. (0.01-mm dia.)	E32-T51	35 mm
	Resists 300°C *5, with spiral tube; high mechanical strength; fiber sheath material: stainless steel (operating ambient temperature: -40°C to 300°C)	 M4 screw	E3X-DA□-N		1.0-mm dia. (0.01-mm dia.)	E32-T61	25 mm
	Side-view; resists 150°C *4; suitable for detecting minute sensing objects; fiber sheath material: fluororesin (operating ambient temperature: -40°C to 150°C) (Free-cut)	 2-mm dia.	E3X-DA□-N			E32-T54	35 mm
	Resists 200°C *5; L-shaped; fiber sheath material: stainless steel	 3-mm dia.	E3X-DA□-N		1.7-mm dia. (0.01-mm dia.)	E32-T84S	25 mm
Slot Sensor	Suitable for film sheet detection; no optical axis adjustment required; easy to mount (Free-cut)		E3X-DA□-N		4.0-mm dia. (2.0-mm dia.)	E32-G14	25 mm
			E3X-DAB11-N				
			E3X-DAH□-N				
Narrow vision field	Suitable for detecting wafers; (Free-cut)	 3-mm dia.	E3X-DA□-N		1.7-mm dia. (0.01-mm dia.)	E32-T22S	10 mm
	Side-view; suitable for detecting wafer (Free-cut)	 3.5 x 3-mm dia.	E3X-DA□-N		2.0-mm dia. (0.01-mm dia.)	E32-T24S	

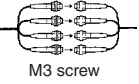
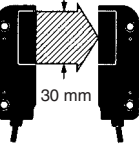
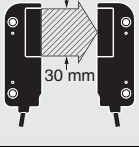
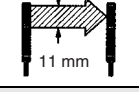
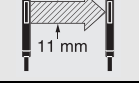
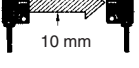
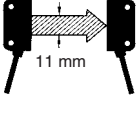
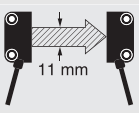
Application	Features	Appearance	Applicable Amplifier Unit	Sensing distance (mm) (Values in parentheses: when using the E39-F1 Lens Unit)	Standard object *3 (min. sensing object: opaque)	Model	Permissible bending radius
Area sensing	Multi-point detection (4-head)	 M3 screw	E3X-DA□-N	700 610 250	2.0-mm dia. (0.01-mm dia.)	E32-M21	25 mm
	Detects in a 30-mm area (Free-cut)	 30 mm	E3X-DA□-N	2,300 1,800 660	(0.3-mm dia.) *6	E32-T16W	10 mm
		 30 mm	E3X-DA□-N	1,700 1,300 500		E32-T16WR	1 mm
	Side-view; suitable for applications with limited spatial depth (Free-cut)	 11 mm	E3X-DA□-N	1,300 1,000 280	(0.2-mm dia.) *6	E32-T16J	10 mm
		 11 mm	E3X-DA□-N	980 750 210		E32-T16JR	1 mm
	Suitable for detecting over a 10-mm area; long distance (Free-cut)	 10 mm	E3X-DA□-N	3,500 2,800 1,000	(0.6-mm dia.) *7	E32-T16	25 mm
	Stable for detecting minute sensing objects in a wide area; degree of protection: IEC60529 IP50 (Free-cut)	 11 mm	E3X-DA□-N	1,400 1,100 420	(0.2-mm dia.) *6	E32-T16P	10 mm
		 11 mm	E3X-DA□-N	1,050 840 320		E32-T16PR	1 mm

*1The E32-T17L allows a longer sensing distance because its optical fiber length is 10 m.

*2These models allow a longer sensing distance because their optical fiber length is 2 m.

*3Indicates values for standard mode.

*4For continuous operation, use the products within a temperature range of -40°C to 130°C.

*5Indicates the heat-resistant temperature at the fiber tip.

*6These figures are for a sensing distance of 300 mm. (Figures for the diameter of sensing objects are in the still state.)

*7These figures are ones for which detection is possible in each sensing area at a digital incident level of 1,000. (Figures for the diameter of sensing objects are in the still state.)

- Note:**
1. The size of standard sensing object is the same as the fiber core diameter (lens diameter for models with lens).
 2. The values of the minimum sensing object for the through-beam models indicate those obtained where the models are set to receive light when the digital incident level exceeds 1,000 (set to digital incident level display).
 3. Greater freedom with wiring at no loss in light intensity enabled by a comprehensive lineup of flexible fiber models (permissible bending radius: 1 mm). Refer to the following illustration.

Flexible fiber models are indicated by an "R" at the end of the model number.

Flexible fiber contains multiple cores. These cores are all surrounded by cladding, giving a minimum bending radius of 1 mm. The fiber can be bent at right angles without affecting the light intensity. Handle it just like any other cable.

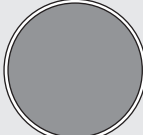

Conventional Fiber
Conventional fiber uses just one core and one cladding section. Bending the fiber may break it or reduce the light intensity.

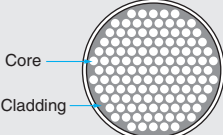

Flexible Fiber
Flexible fiber contains multiple independent cores all surrounded by cladding. The fiber can be bent without breaking or reducing the light intensity.













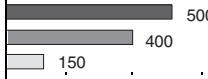
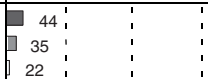
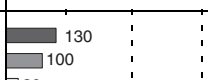

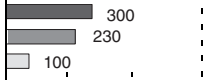

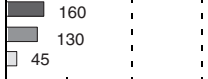
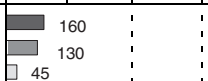



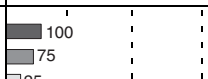

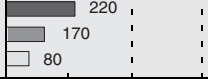
■ Fiber Units with Reflective Sensors

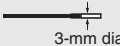
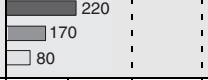
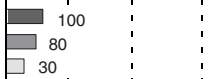

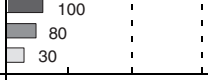



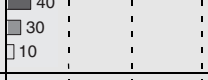



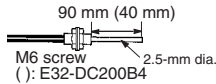
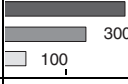
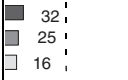

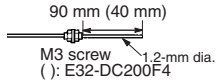
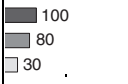

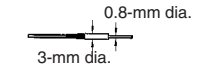
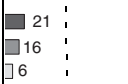

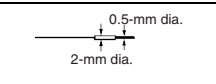
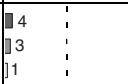

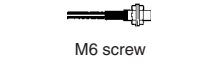
Refer to the end of the following table for notes and precautions.

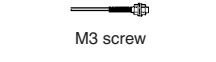
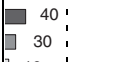
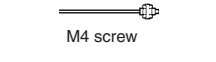
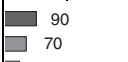
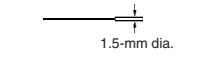
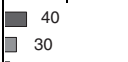

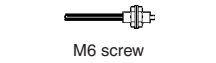
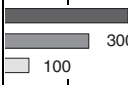
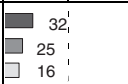
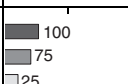

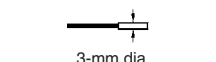
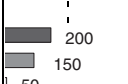

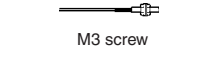
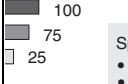
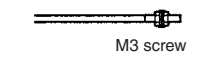
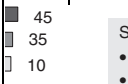
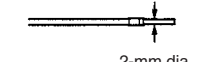
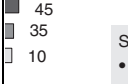

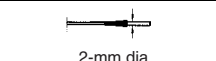
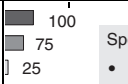





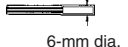

Note: Specifications for the E3X-DA□V and E3X-DA□TW are included in those for the E3X-DA□N, and specifications for the E3X-DAG□-N are included in those for the E3X-DAB□-N.



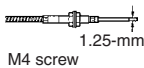



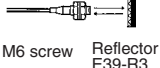

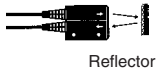

 Indicates models that allow free cutting. Models without this mark do not allow free cutting.

 : Super-long-distance mode  : Standard mode  : Super-high-speed mode

Application	Features	Appearance	Applicable Amplifier Unit	Sensing distance (mm) *1	Standard object (min. sensing object *2: Gold wire)	Model	Permissible bending radius	
Long distance	M6 	 M6 screw	E3X-DA□-N		500×500 (0.01-mm dia.)	E32-D11L	25 mm	
			E3X-DAB11-N		100×100 (0.1-mm dia.)			
			E3X-DAH□-N		200×200 (0.01-mm dia.)			
	3-mm dia.; small diameter 	 3-mm dia.	E3X-DA□-N		300×300 (0.01-mm dia.)	E32-D12		
M4 	 M4 screw	E3X-DA□-N		200×200 (0.01-mm dia.)	E32-D21L	10 mm		
							E32-D22L	
General-purpose	M6 	 M6 screw	E3X-DA□-N		400×400 (0.01-mm dia.)	E32-DC200	25 mm	
			E3X-DAB11-N					100×100 (0.1-mm dia.)
			E3X-DAH□-N					100×100 (0.01-mm dia.)
	M6 	 M6 screw	E3X-DA□-N		300×300 (0.01-mm dia.)	E32-D11R	1 mm	
								E32-D12R
	3-mm dia. 	 3-mm dia.	E3X-DA□-N		100×100 (0.01-mm dia.)	E32-DC200E	10 mm	
								25×25 (0.2-mm dia.)
	M3; small diameter 	 M3 screw	E3X-DA□-N		50×50 (0.01-mm dia.)	E32-D21R	1 mm	
								E32-D22R
	M3; small diameter 	 M3 screw	E3X-DA□-N		50×50 (0.01-mm dia.)	E32-D21R	1 mm	
				E32-D22R				

Application	Features	Appearance	Applicable Amplifier Unit	Sensing distance (mm) *1	Standard object (min. sensing object *2: Gold wire)	Model	Permissible bending radius	
Thin fiber	2.5-mm dia.; with sleeve 	 90 mm (40 mm) M6 screw (): E32-DC200B4	E3X-DA□-N	 400 300 100	400×400 (0.01-mm dia.)	E32-DC200B E32-DC200B4	25 mm	
			E3X-DAB11-N	 32 25 16	100×100 (0.1-mm dia.)			
	1.2-mm dia.; with sleeve 	 90 mm (40 mm) M3 screw (): E32-DC200F4	E3X-DA□-N	 100 80 30	100×100 (0.01-mm dia.)	E32-DC200F E32-DC200F4	10 mm	
	0.8-mm dia.; for detecting minute sensing objects 	 0.8-mm dia. 3-mm dia.	E3X-DA□-N	 21 16 6	25×25 (0.01-mm dia.)	E32-D33	4 mm	
0.5-mm dia.; for detecting minute sensing objects 	 0.5-mm dia. 2-mm dia.	E3X-DA□-N	 4 3 1	E32-D331				
Flexible (resists breaking) (R4)	Ideal for mounting on moving sections (R4) 	 M6 screw	E3X-DA□-N	 220 170 80	300×300 (0.01-mm dia.)	E32-D11	4 mm	
		 M3 screw	E3X-DA□-N	 40 30 10		E32-D21		
		 M4 screw	E3X-DA□-N	 90 70 25		E32-D21B		
		 1.5-mm dia.	E3X-DA□-N	 40 30 10		E32-D22B		
Coaxial	M6 coaxial; high-precision positioning 	 M6 screw	E3X-DA□-N	 400 300 100	500×500 (0.01-mm dia.)	E32-CC200	25 mm	
			E3X-DAB11-N	 32 25 16				100×100 (0.1-mm dia.)
			E3X-DAH□-N	 100 75 25				100×100 (0.01-mm dia.)
	3-mm dia.; small diameter; coaxial; high-precision positioning 	 3-mm dia.	E3X-DA□-N	 200 150 50	300×300 (0.01-mm dia.)	E32-D32L		
	M3 coaxial; high-precision positioning 	 M3 screw	E3X-DA□-N	 100 75 25	100×100 (0.01-mm dia.)	E32-C31		
	M3 coaxial; high-precision positioning	 M3 screw	E3X-DA□-N	 45 35 10				50×50 (0.01-mm dia.)
	2-mm dia. coaxial; high-precision positioning	 2-mm dia.	E3X-DA□-N	 45 35 10	Spot diameter*6 • Adjustable in the range 0.1 to 0.6-mm dia.	E32-C42		
2-mm dia. coaxial; high-precision positioning 	 2-mm dia.	E3X-DA□-N	 100 75 25	Spot diameter*6 • Adjustable in the range 0.5 to 1.0-mm dia.				E32-D32

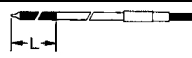
Application	Features	Appearance	Applicable Amplifier Unit	Sensing distance (mm) *1	Standard object (min. sensing object *2: Gold wire)	Model	Permissible bending radius
Side-view	6-mm dia.; long distance 	6-mm dia. 	E3X-DA□-N	150 110 50	200×200 (0.01-mm dia.)	E32-D14L	25 mm
			E3X-DAH□-N	35 25 10			
	6-mm dia. 	6-mm dia. 	E3X-DA□-N	60 45 25	100×100 (0.01-mm dia.)	E32-D14LR	1 mm
				2-mm dia.; small diameter space-saving 			
	2-mm dia. 	E3X-DA□-N	25 15 6		E32-D24R	1 mm	
Chemical-resistant	Fluororesin-covered; withstands chemicals and harsh environments (operating ambient temperature: -30°C to 70°C) 	 6-mm dia.	E3X-DA□-N	120 95 45	200×200 (0.01-mm dia.)	E32-D12F	40 mm
Heat-resistant	Resists 150°C *3; fiber sheath material: fluororesin (operating ambient temperature: -40°C to 150°C) 	 M6 screw	E3X-DA□-N	300 230 100	200×200 (0.01-mm dia.)	E32-D51	35 mm
	Resists 300°C *4; fiber sheath material: stainless steel (operating ambient temperature: -40°C to 300°C)	 M6 screw	E3X-DA□-N	120 90 30		E32-D61	25 mm
	Resists 400°C *4; fiber sheath material: stainless steel (operating ambient temperature: -40°C to 400°C)	 M4 screw 1.25-mm dia.	E3X-DA□-N	80 60 20		100×100 (0.01-mm dia.)	E32-D73
Area sensing	Side-view; detection over wide areas 		E3X-DA□-N	200 150 50	300×300 (0.01-mm dia.)	E32-D36P1	25 mm
Retroreflective	Transparent object detection 	 M6 screw Reflector E39-R3	E3X-DA□-N	10 to 250 10 to 250 10 to 250	35-mm dia. (0.1-mm dia.)	E32-R21 + E39-R3 (Attachment)	10 mm
	Transparent object detection (operating ambient temperature: -25°C to 55°C); degree of protection: IEC60529 IP66 	 Reflector E39-R1	E3X-DA□-N	150 to 1,500	35-mm dia. (0.2-mm dia.)	E32-R16 + E39-R1 (Attachment)	25 mm

Application	Features	Appearance	Applicable Amplifier Unit	Sensing distance (mm) *1	Standard object (min. sensing object *2: Gold wire)	Model	Permissible bending radius
Limited reflective	Suitable for positioning crystal glass 		E3X-DA□-N	4 to 12	100×100 Soda glass with reflection factor of 7%	E32-L56E1 E32-L56E2	35 mm
	Detects wafers and small differences in height; (operating ambient temperature: -40°C to 105°C); degree of protection: IEC60529 IP50 		E3X-DA□-N	4±2 4±2 4±2	25×25 (0.01-mm dia.)	E32-L24L E32-L25L	10 mm
			E3X-DA□-N	7.2±1.8 7.2±1.8 7.2±1.8			
	Detects wafers and small differences in height; degree of protection: IEC60529 IP50 		E3X-DA□-N	3.3 3.3 3.3			
			E3X-DA□-N	3.3 3.3 3.3			
Fluid-level detection	Fluid contact type: unbendable section L 150 mm, 350 mm (two types)		E3X-DA□-N	---	Pure water at 25°C	E32-D82F1 E32-D82F2	40 mm
	Tube-mounting type 		E3X-DA□-N	---	Fluid	E32-L25T	10 mm

*1Sensing distance indicates values for white paper.

*2Indicates values for standard mode.

*3For continuous operation, use the products within a temperature range of -40°C to 130°C.

*4Indicates the heat-resistant temperature at the fiber tip.

*5The values indicated are for use with a Lens Unit (order separately).

- Note:**
1. The values of the minimum sensing object indicate those obtained at a distance where the smallest object can be sensed with the Reflective Fiber Unit.
 2. When set to the maximum sensitivity setting for the internal reflective light, incident light may continue to be received. In such case, use under two-point teaching or without-object teaching.

Output Circuits

Refer to the end of the following table for notes and precautions.

Output	Model	Mode selector	Timing chart	State of output transistor	Output circuit
NPN	E3X-DA11-N E3X-DAB11-N E3X-DAG11-N E3X-DAH11-N E3X-DA11V E3X-DA6 E3X-DAB6 E3X-DAG6 E3X-DAH6 E3X-DA14V	LIGHT ON (L/ON)		Light ON	<p>Connector Pin Arrangement</p> <p>Note: Pin 2 is not used.</p>
		DARK ON (D/ON)		Dark ON	
E3X-DA21-N E3X-DA7		LIGHT ON (L/ON)		Light ON	<p>Note: Load resistance: 10 kΩ min.</p>
		DARK ON (D/ON)		Dark ON	
E3X-DA11TW E3X-DA6TW		LIGHT ON (L/ON)		Light ON	
		DARK ON (D/ON)		Dark ON	

Output	Model	Mode selector	Timing chart	State of output transistor	Output circuit
PNP	E3X-DA41-N E3X-DAB41-N E3X-DAG41-N E3X-DAH41-N E3X-DA41V E3X-DA8 E3X-DAB8 E3X-DAG8 E3X-DAH8 E3X-DA44V	LIGHT ON (L/ON)		Light ON	<p>Connector Pin Arrangement</p> <p>Note: Pin 2 is not used.</p>
		DARK ON (D/ON)		Dark ON	
E3X-DA51-N E3X-DA9		LIGHT ON (L/ON)		Light ON	<p>Note: Load resistance: 10 kΩ min.</p>
		DARK ON (D/ON)		Dark ON	
E3X-DA41TW E3X-DA8TW		LIGHT ON (L/ON)		Light ON	
		DARK ON (D/ON)		Dark ON	

Note: With E3X-DA□TW models, only channel 1 is output when set for area sensing operation.

LIGHT ON: ON when the incident level is between the thresholds for channels 1 and 2.

DARK ON: OFF when the incident level is between the thresholds for channels 1 and 2. (Channel 2 is always OFF.)

Connectors (Sensor I/O Connectors)

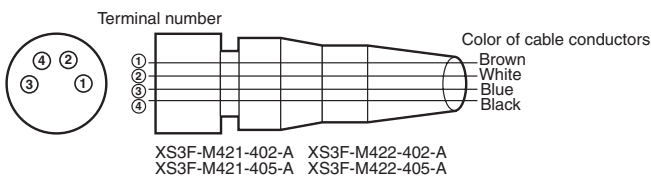

Classification	Color of cable conductors	Connection pin number	Application
DC	Brown	1	Power supply (+V)
	White	2	---
	Blue	3	Power supply (0 V)
	Black	4	Output

Note: Pin 2 is not used.

Connection

Connection with K3NX-VD2 Process Meter

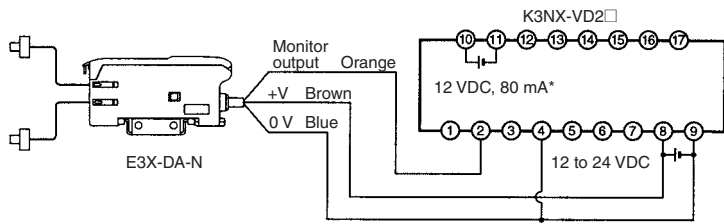

* Use this service power supply for the Sensor with reference to the power consumption of each Sensor.

- Note:**
1. Various I/O Units are available for the K3NX. Select an appropriate output type depending on the application.
 2. For details about the K3NX, refer to the K3NX Datasheet (N084) or the K3NX Operation Manual (N090).
 3. This wiring is for the K3NX with DC power supply specifications and the Monitor (Analog) Sensor with DC power supply specifications. Check respective power supply specifications before wiring them.

Engineering Data (Typical)

■ E3X-DA□-N/E3X-DA□V/E3X-DA□TW

Parallel Operating Range

At max. sensitivity. (Use for optical axis adjustment at installation.)

E32-TC200 (Through-beam)

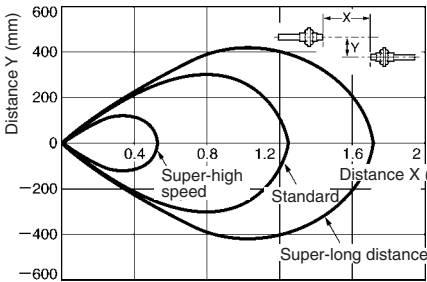

E32-T11R (Through-beam)

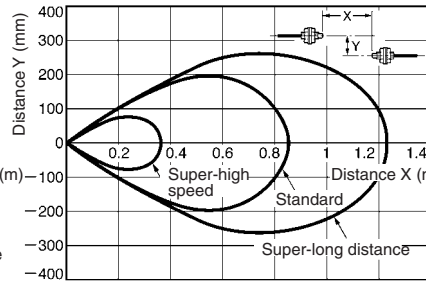

E32-T11 (Through-beam)

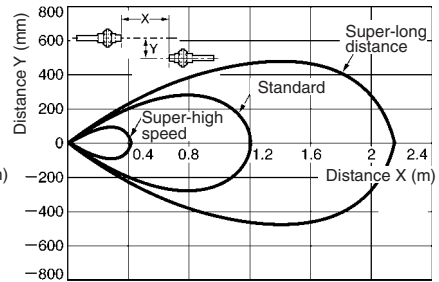

Operating Range

With standard sensing object at max. sensitivity. (Use for the positioning of the object and Sensor.)

E32-DC200 (Reflective)

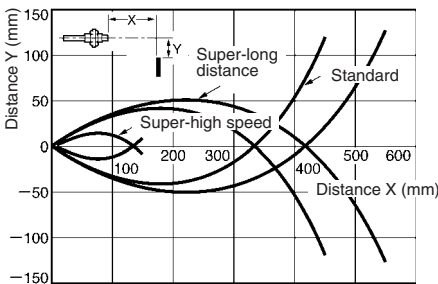

E32-D33 (Reflective)

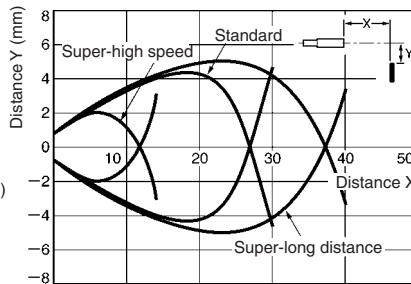

E32-L25L (Limited Reflective)

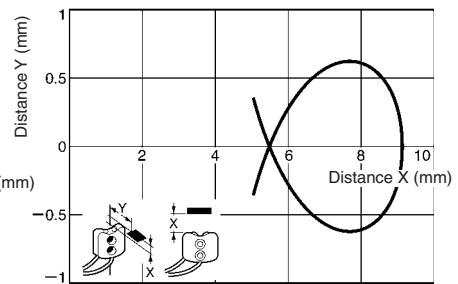

Excess Gain Ratio vs. Distance

With standard sensing object. At max. sensitivity.

E32-TC200 (Through-beam)

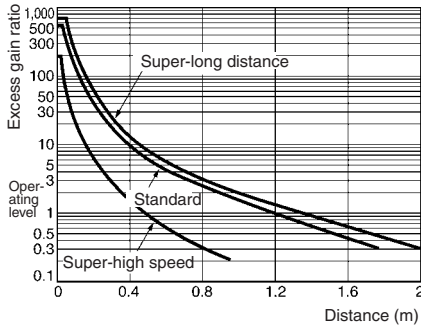

E32-DC200 (Reflective)

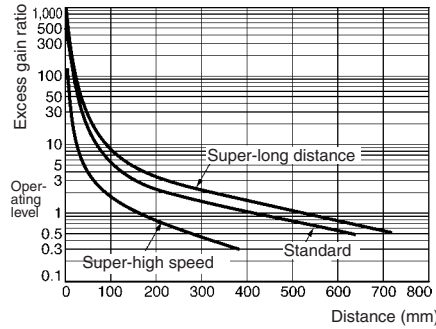

E32-D21L (Reflective)

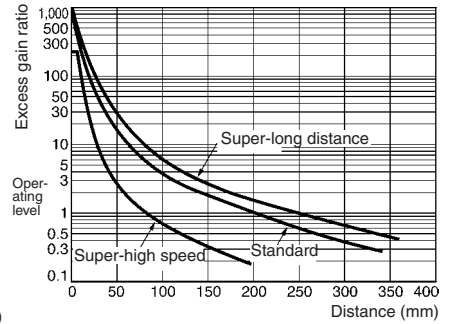

E3X-DA□-N/E3X-DA□V/E3X-DA□TW

**Sensing Distance vs. Operating Range
E32-DC200 (Reflective)**

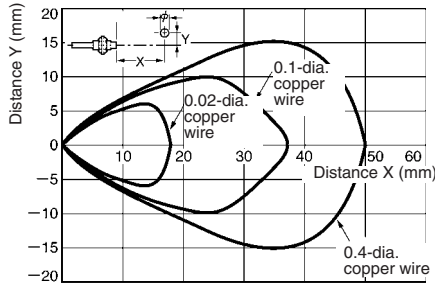

**Hysteresis vs. Sensing Distance
E32-D11L (Reflective)**

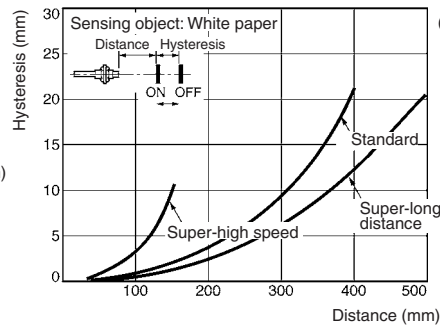

**Repeat Accuracy vs. Sensing Distance
E32-DC200 (Reflective)**

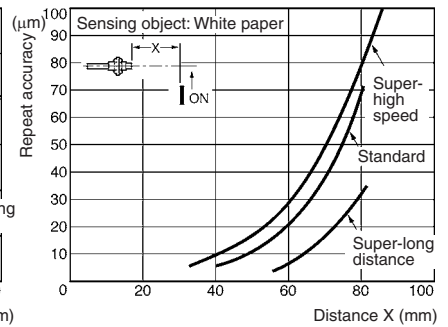

Monitor Output vs. Distance (Standard Mode)

E32-TC200 (Through-beam)

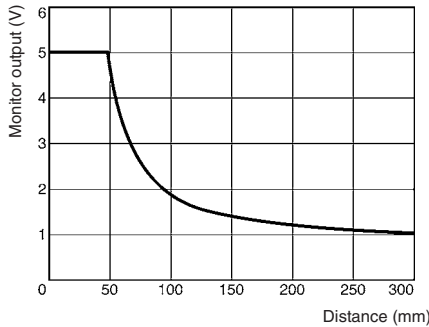

E32-DC200 (Reflective)

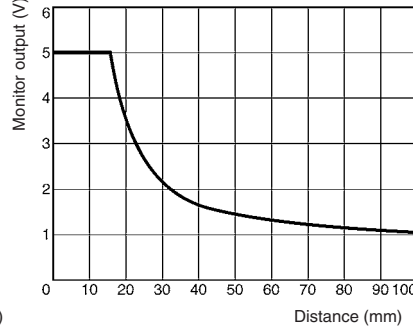

■ E3X-DAB□-N/E3X-DAG□-N

Parallel Operating Range

At max. sensitivity. (Use for optical axis adjustment at installation.)

E32-TC200 (Through-beam)

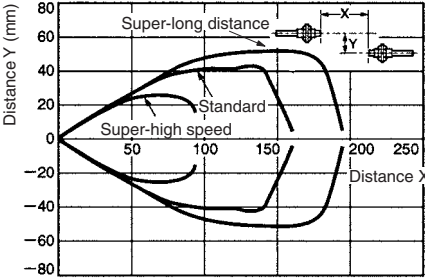

E32-TC200+E39-F1 (Through-beam)

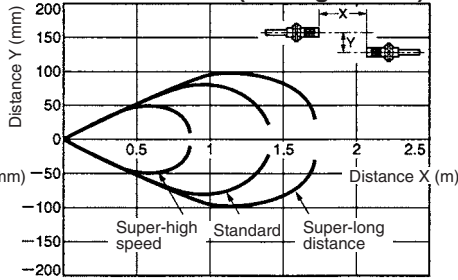

Operating Range

With standard sensing object at max. sensitivity. (Use for the positioning of the object and Sensor.)

E32-DC200 (Reflective)

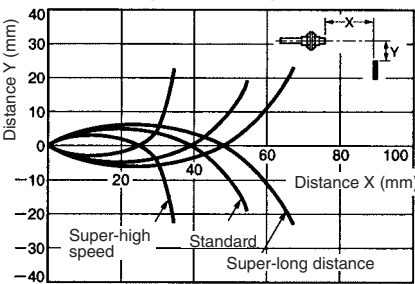

E32-CC200 (Reflective)

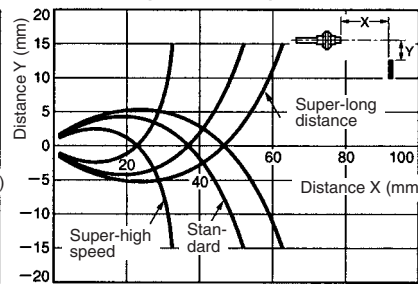

E32-D11L (Limited Reflective)

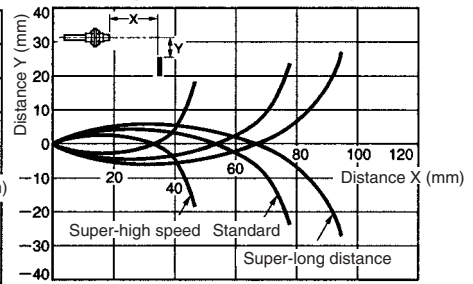

■ E3X-DAH-N

Parallel Operating Range

At max. sensitivity. (Use for optical axis adjustment at installation.)

E32-TC200 (Through-beam)

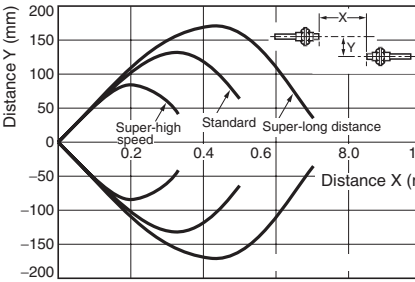

E32-T11L (Through-beam)

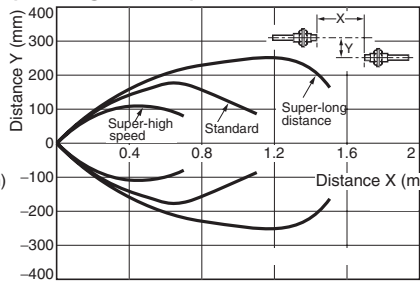

E32-T14 (Through-beam)

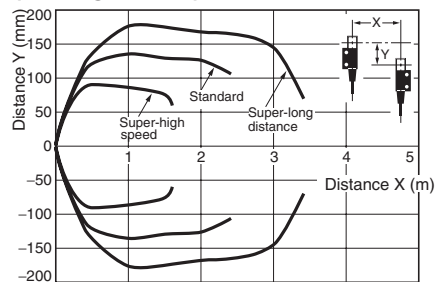

Operating Range

With standard sensing object at max. sensitivity. (Use for the positioning of the object and Sensor.)

E32-DC200 (Reflective)

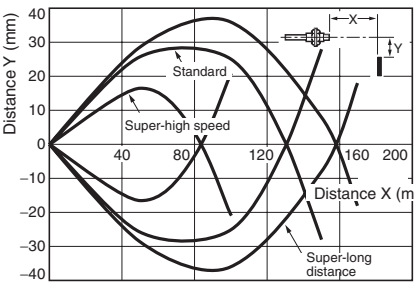

E32-D11L (Reflective)

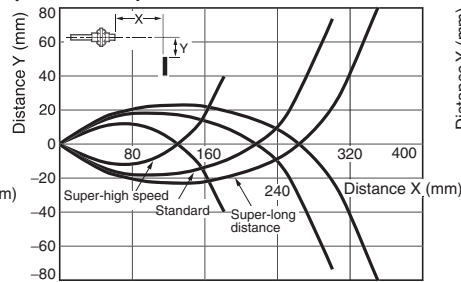

E32-CC200 (Reflective)

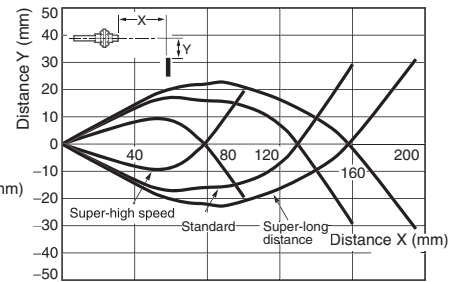

Technical Reference (for E3X-DA-TW Twin-output Models)

Output Patterns for Normal Operation

Outputs 1 and 2 can be set to operate independently and either Light ON mode or Dark ON mode can be selected (independently) for channels 1 and 2 making a total of 4 possible output patterns (In the following examples, threshold 1 is set to 3,000, and threshold 2 is set to 1,000.)

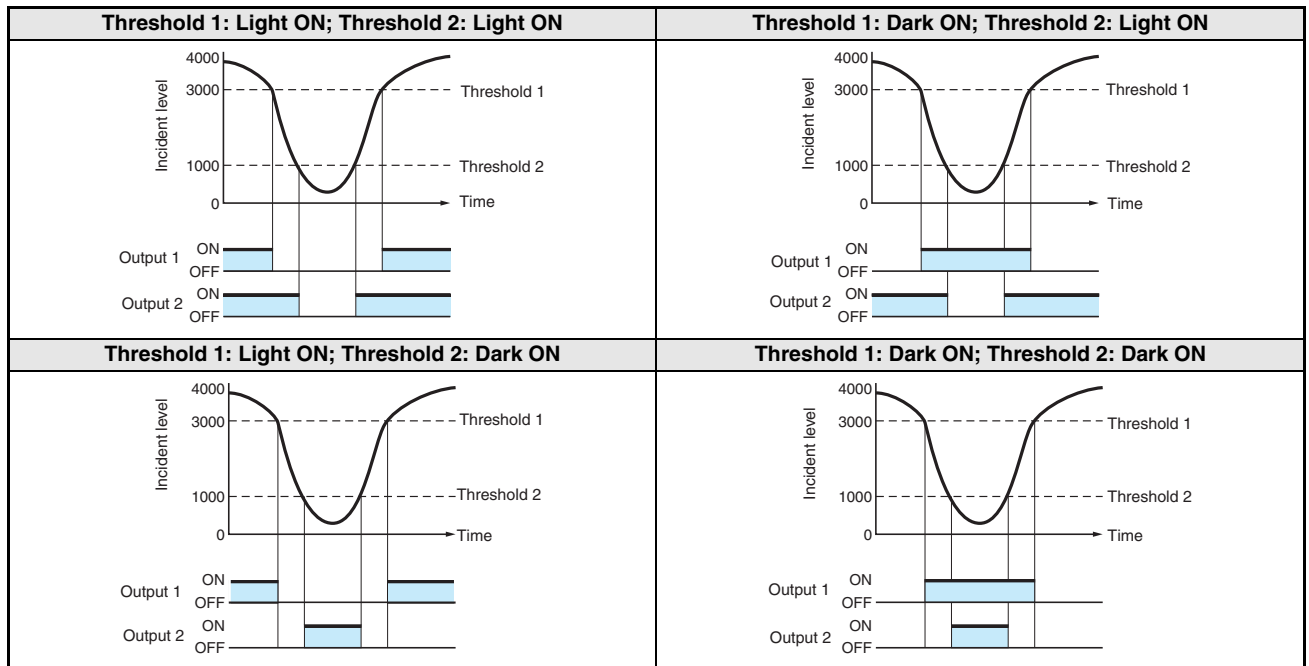

Output Patterns for Area Sensing

This series includes models equipped with area sensing functionality, a first for Digital Fiber Amplifiers. This functionality can be used to monitor whether the incident level is inside or outside the threshold area. The 2 output patterns below are possible for this kind of operation.

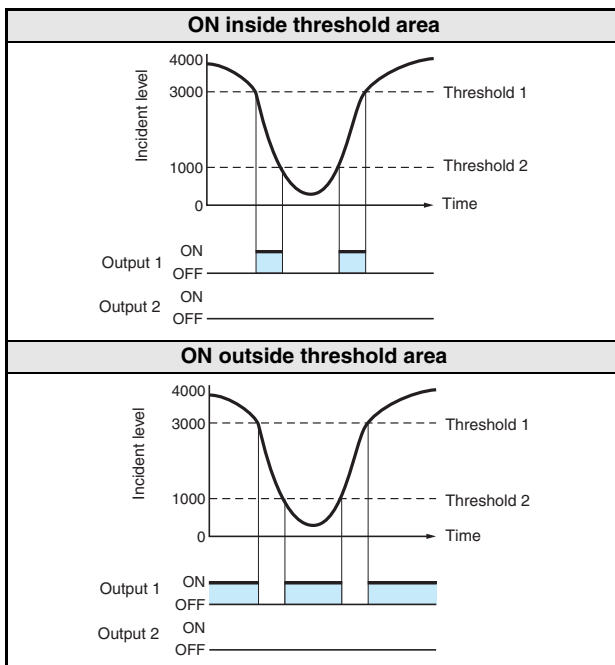

Note: Output 2 is always OFF.

Application

■ Wiring Precautions

Read the following before using the Amplifier Unit and Sensor to ensure safety.

Power Supply Voltage

Do not impose any voltage exceeding the rated voltage on the E3X-DA-N. Do not impose AC power (100 VAC) on models that operate with DC. In both cases, the E3X-DA-N may rupture or burn.

Load Short-circuits

Do not short-circuit the load connected to the E3X-DA-N, otherwise the E3X-DA-N may rupture or burn.

Polarity

When supplying power to the E3X-DA-N, make sure that the polarity of the power is correct, otherwise the E3X-DA-N may rupture or burn.

No-load Operation

A load must be connected to the E3X-DA-N during operation, otherwise internal elements may rupture or burn. Always wire through a load.

Operating Environment

- Do not use the Amplifier Unit or Sensor in places with flammable or explosive gas.
- Do not use the Amplifier Unit or Sensor underwater.
- Do not disassemble, repair, or modify the Amplifier Unit or Sensor.

■ Amplifier Units

Nomenclature: Standard, Monitor-output, Mark-detecting, Infrared, and Water-resistant Models

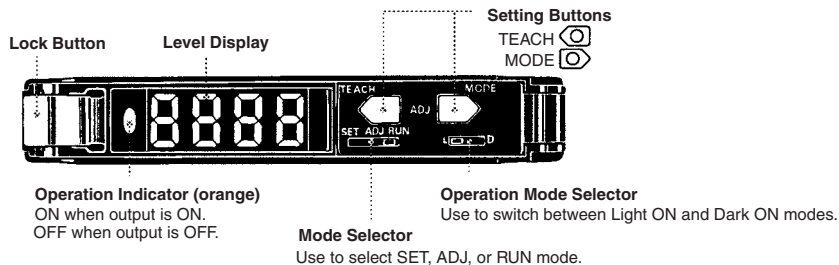

Nomenclature: Twin-output Models

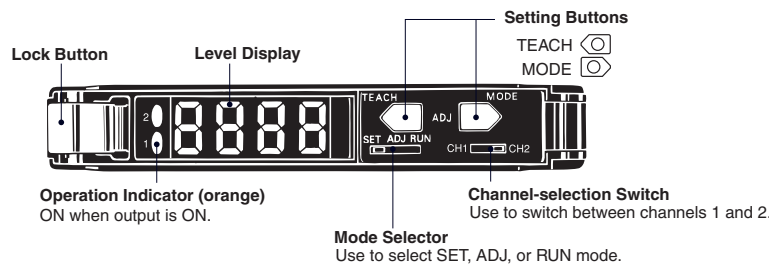

Installation

Turning Power ON

The Sensor is ready to operate within 200 ms after the power supply is turned ON. If the Sensor and load are connected to power supplies separately, be sure to turn ON the power supply to the Sensor first.

Power Supply Type

A full or half-wave rectifying power supply without a smoothing circuit cannot be used.

Wiring

Cable

The cable can be extended, provided that the extension wire applied is at least 0.3 mm² thick and the total distance no more than 100 m.

Do not pull the cable with a force exceeding 30 N.

Separation from Power or High-tension Lines

Do not wire power lines or high-tension lines alongside the lines of the Amplifier Unit in the same conduit, otherwise the Amplifier Unit may be damaged or malfunction due to induction. Be sure to wire the lines of the Amplifier Unit separated as far as possible from power lines or high-tension lines or laid in an exclusive, shielded conduit.

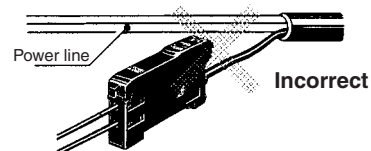

Power Supply

If a standard switching regulator is used as a power supply, the frame ground (FG) terminal and the ground (G) terminal must be grounded, otherwise faulty operation may result from the switching noise of the power supply.

M8 Metal Connectors (Water-resistant Models)

- Turn OFF the power before inserting or removing connectors.
- Hold the connector cover when inserting or removing the connector.
- Tighten the fixing screws by hand. Using tools such as pliers may cause damage.
- The applicable tightening torque range is 0.3 to 0.4 N·m. If tightening is insufficient, the enclosure rating may not be maintained, and vibrations may cause the connector to come loose.

Mounting

Joining Amplifier Units

1. Mount the Amplifier Units one at a time onto the DIN track.

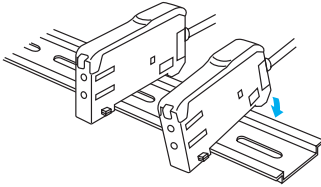

2. Slide the Amplifier Units together, line up the clips, and press the Amplifier Units together until they click into place.

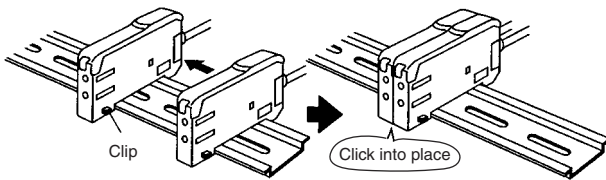

Separating Amplifier Units

Slide Amplifier Units away from each other, and remove from the DIN track one at a time. (Do not attempt to remove Amplifier Units from the DIN track without separating them first.)

- Note:**
1. The specifications for ambient temperature will vary according to the number of Amplifier Units used together. For details, refer to *Ratings/Characteristics*.
 2. Always turn OFF the power supply before joining or separating Amplifier Units.

Mounting the Mobile Console Head

Leave a gap of at least 20 mm between the nearest Amplifier Unit and the Mobile Console head.

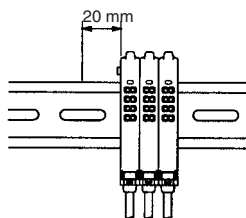

Mounting

1. Mount the front part on the mounting bracket (order separately) or a DIN track.
2. Press the back part onto the mounting bracket or the DIN track.

Note: Do not mount the back of the Amplifier Unit onto the mounting bracket or the DIN track first, otherwise the mounting strength of the Amplifier Unit may be reduced. Always mount the front of the Amplifier Unit first.

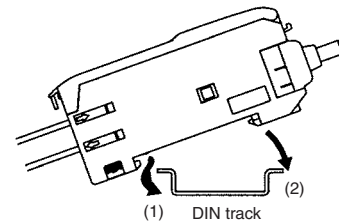

Dismounting

By pressing the Amplifier Unit in direction (3) and lifting the fiber insertion part in direction (4) as shown in the following diagram, the Amplifier Unit can be dismounted with ease.

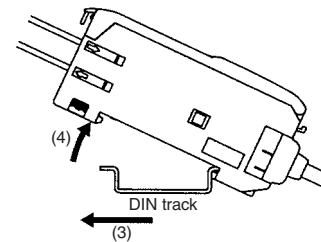

When side-mounting using a mounting bracket, secure the mounting bracket to the Amplifier Unit and then mount using M3 screws. Use plain washers of diameter 6 mm or less when mounting.

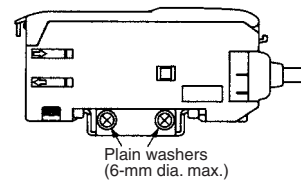

Adjustment

Mutual Interference Protection Function

There may be some instability in the digital display values due to light from other sensors. If this occurs, decrease the sensitivity (i.e., increase the threshold) to perform stable detection.

EEPROM Writing Error

If the data is not written to the EEPROM correctly due to a power failure during teaching or static-electric noise, repeat the whole teaching procedure.

Optical Communications

Several Amplifier Units can be slid together and used in groups. Do not, however, slide the Amplifier Units or attempt to remove any of the Amplifier Units during operation.

Hysteresis Adjustment

The hysteresis setting can be adjusted using the Mobile Console. Do not, however, set the hysteresis to a value lower than the factory setting. Using a setting less than the factory setting may result in incorrect operation.

Operating Environment

Water Resistance

Although the E3X-DA□V has water-resistant specifications, if dirt (via water) adheres to the hole for optical communications, it may prevent normal communications. As a countermeasure, regularly (e.g., when performing inspections) wipe the area around the hole with a dry cloth.

Ambient Conditions

If dust or dirt adheres to the hole for optical communications, it may prevent normal communications. Be sure to remove any dust or dirt before using the Units.

Miscellaneous

Ratings and Specifications

The ratings and performance specifications for items such as the minimum sensing object and characteristics are based on products taken at random from certain production lots. Use this data as reference only.

Amplifier Adjustments: All Models

Changing the Display (RUN Mode)

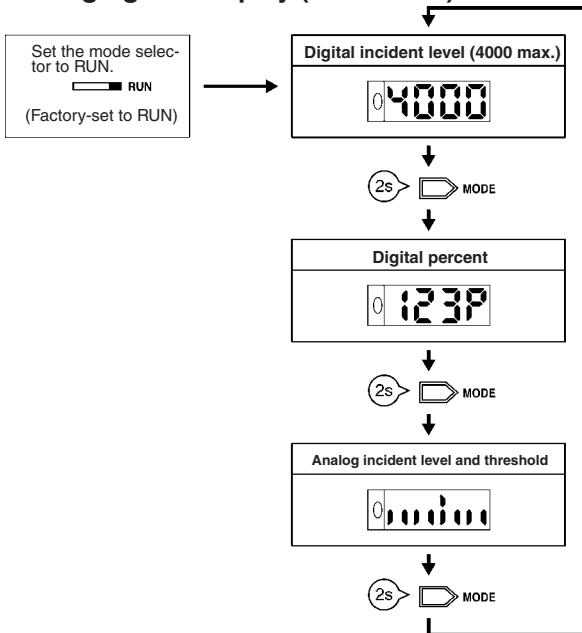

Zero-reset (RUN Mode)

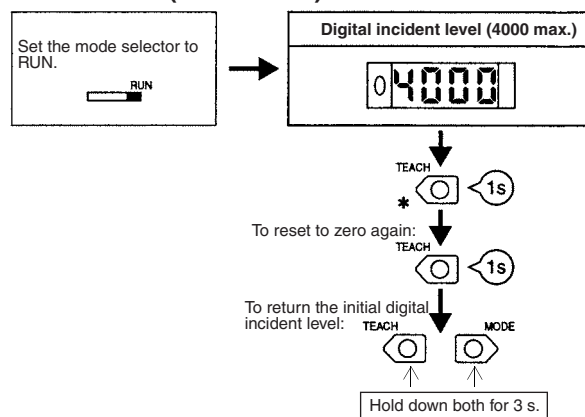

Note: There is no limit on the number of times zero-reset can be used.

Initial Reset (SET Mode)

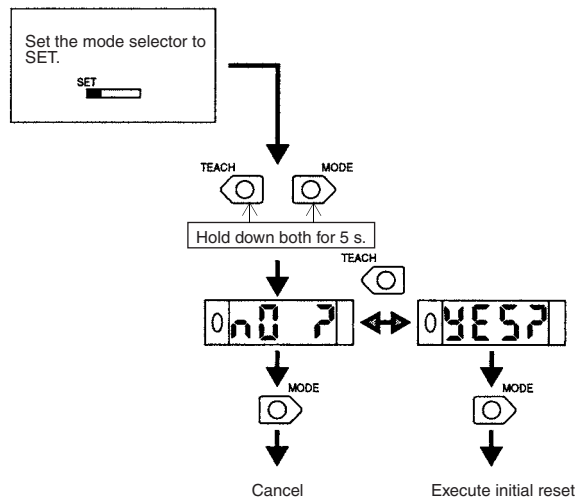

Manual Tuning (Fine Sensitivity Adjustment) in ADJ Mode

Perform fine sensitivity adjustment after teaching and manual tuning (without using the teaching function) in the way shown below:

Twin-output Models

First, select the channel to be adjusted using the channel selection switch.

CH1 CH2



The items displayed in ADJ mode vary with the display setting in RUN mode.

RUN mode	ADJ mode
Digital incident level	Digital threshold
Digital percent	Digital percent
Analog value	Analog value

Setting Functions in SET Mode

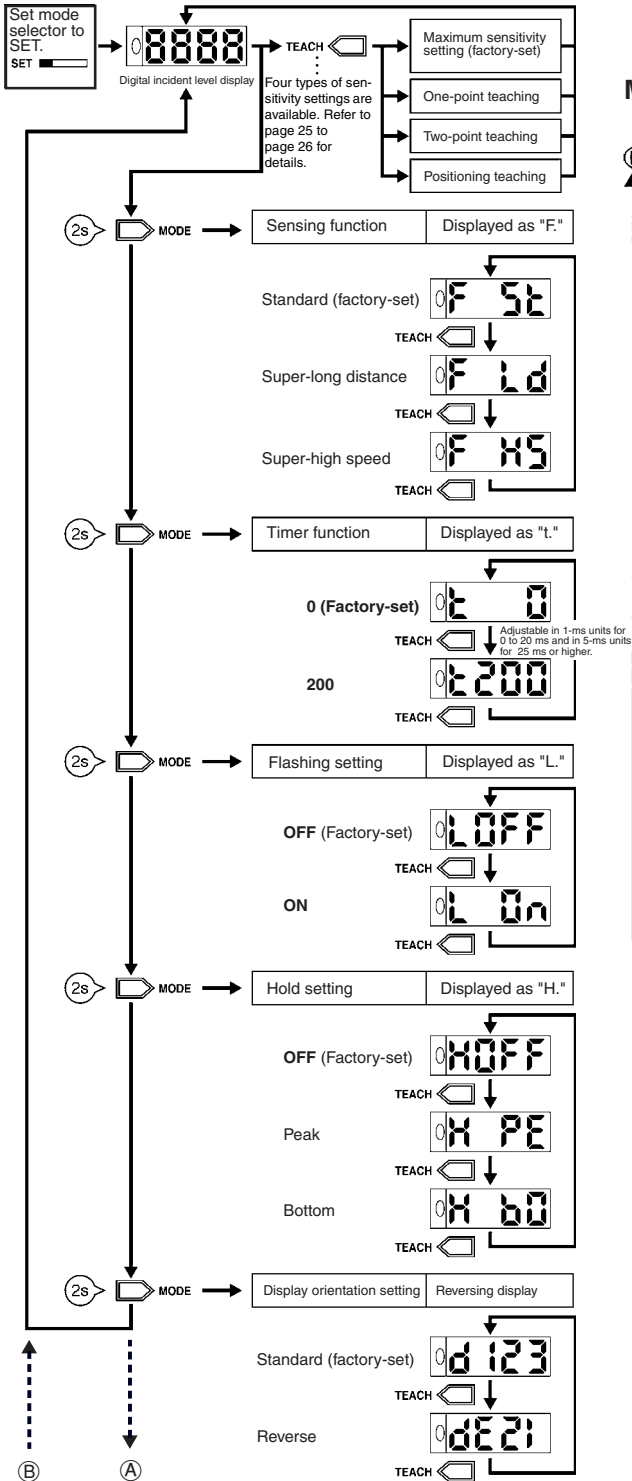

Monitor Focus

Available with:
E3X-DA21-N
E3X-DA51-N
E3X-DA7
E3X-DA9

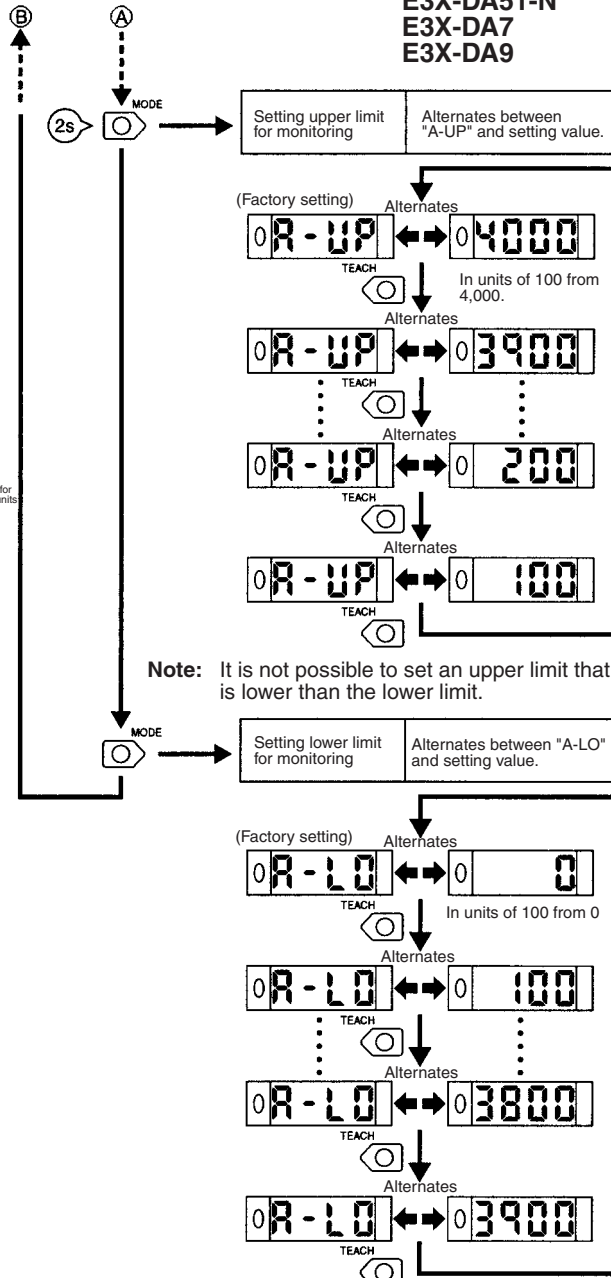

Note: It is not possible to set an upper limit that is lower than the lower limit.

Note: It is not possible to set a lower limit that is greater than the upper limit.

Adjustments: Twin-output Models Only

Setting Functions (SET Mode)

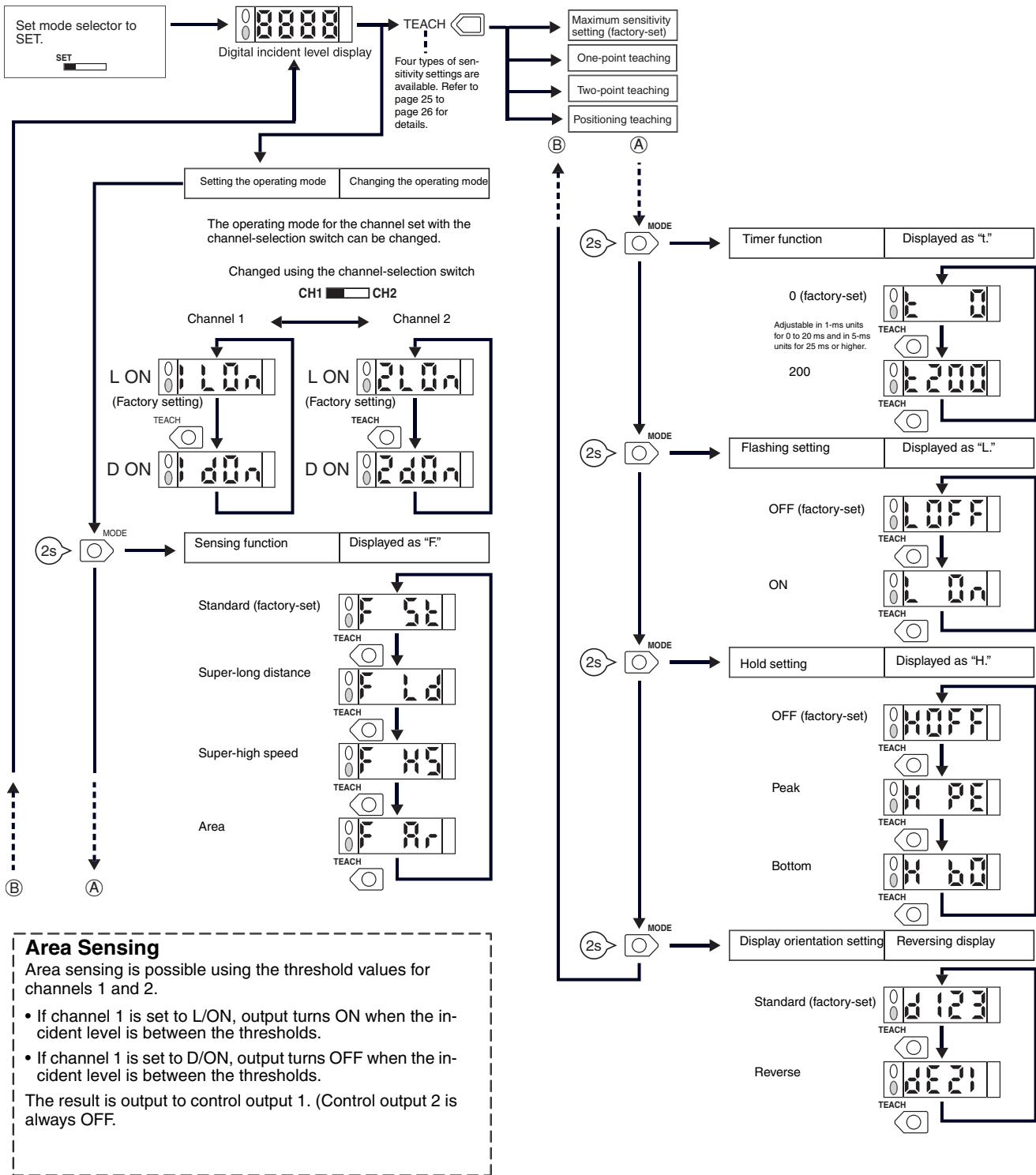

Adjustments: Teaching (All Models, SET Mode)

The four types of teaching given below are available.

Once the setting is made, the Amplifier Unit operates according to the settings. The red level display will flash if a teaching error occurs. In that case, repeat the whole teaching procedure.

With twin-output models, switch to the channel to be adjusted using the channel-selection switch.



Set the mode selector to SET to start teaching. SET

Maximum Sensitivity Setting

1. Set the mode selector to SET.



2. Press the TEACH button for 3 seconds min.

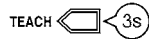

3. Setting is complete when the level display changes from red to green.
The level display will display the digital incident level later.

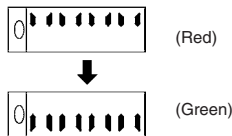

4. Set to RUN mode.



One-point Without-object Teaching

1. Set the mode selector to SET.



2. Press the TEACH button for approximately 1 second.

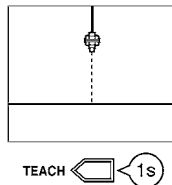

3. Teaching is complete when the red level display is lit.
The level display will display the digital incident level later.



4. Set to RUN mode.



5. The threshold is automatically set with the object.

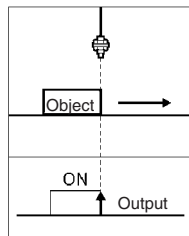

Note: If one-point teaching is not available because the difference in level is too fine, try two-point teaching.

Operation Mode Selector

Operation mode		Operation
Light ON	L• ON	L (Factory-set)
Dark ON	D• ON	D

Note: There is no operation mode selector for twin-output models.

Two-point With/Without-object Teaching

1. Set the mode selector to SET.



2. Press the TEACH button for approximately 1 second when the object is at the sensing position.

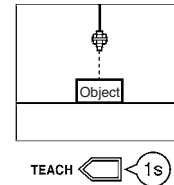

3. The red level display is lit.



4. Press the TEACH button for approximately 1 second with no object.

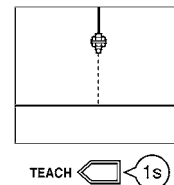

5. Teaching is complete when the green level display is lit.
The level display will display the digital incident level later.



6. Set to RUN mode.



Note: The order of “with-object” and “without-object” setting procedures above can be reversed.

Pin-point Teaching (for Positioning)

1. Set the mode selector to SET.



2. Press the TEACH button for approximately 1 second with no object.

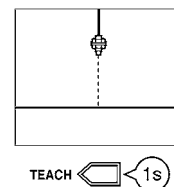

3. The red level display is lit.



4. Place the object in the desired position, and press the TEACH button for 3 seconds min.

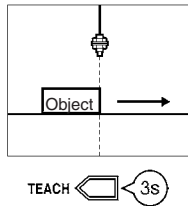

5. Teaching is complete when the green level display is lit. The level display will display the digital incident level later. (The red level display will flash if a teaching error occurs.)



6. Set to RUN mode.



Fiber Units

Mounting

Tightening Force

The tightening force applied to the Fiber Unit should be as follows:

Screw-mounting Model

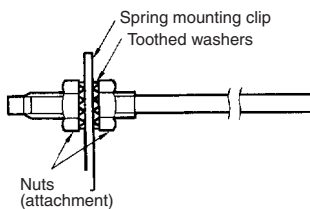

Cylindrical Model

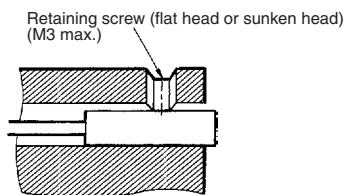

Use a proper-sized wrench.

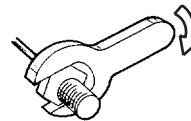

Fiber Connection and Disconnection

The E3X Amplifier Unit has a lock button. Connect or disconnect the fibers to or from the E3X Amplifier Unit using the following procedures:

1. Connection

Open the protective cover, insert the fibers according to the fiber insertion marks on the side of the Amplifier Unit, and lower the lock button.

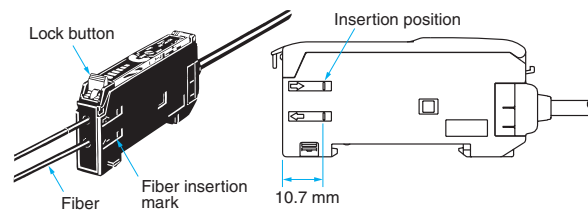

2. Disconnection

Remove the protective cover and raise the lock button to pull out the fiber.

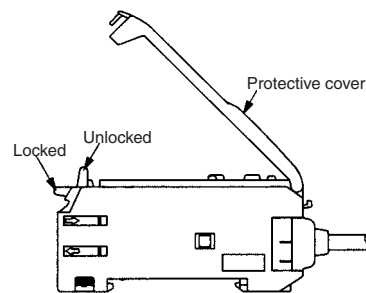

Note: To maintain the fiber properties, confirm that the lock is released before removing the fiber.

3. Precautions for Fiber Connection/Disconnection

Be sure to lock or unlock the lock button within an ambient temperature range between -10°C and 40°C .

Fiber Units	Clamping torque
M3/M4 screw	0.78 N • m max.
M6 screw/ 6-mm dia. column	0.98 N • m max.
1.5-mm dia. column	0.2 N • m max.
2-mm dia./3-mm dia. column	0.29 N • m max.
E32-T12F 5-mm dia. fluororesin model	0.78 N • m max.
E32-D12F 6-mm dia. fluororesin model	
E32-T16	0.49 N • m max.
E32-R21	0.39 N • m max.
E32-M21	Up to 5 mm to the tip: 0.49 N • m max. More than 5 mm from the tip: 0.78 N • m max.
E32-L25A	0.78 N • m max.
E32-T16P E32-T24S E32-L24L E32-L25L	0.29 N • m max.

Cutting Fiber

Insert a fiber into the Fiber Cutter and determine the length of the fiber to be cut.

Press down the Fiber Cutter in a single stroke to cut the fiber.

The cutting holes cannot be used twice. If the same hole is used twice, the cutting face of the fiber will be rough and the sensing distance will be reduced. Always use an unused hole.

Cut a thin fiber as follows:

1. An attachment is temporarily fitted to a thin fiber before shipment.

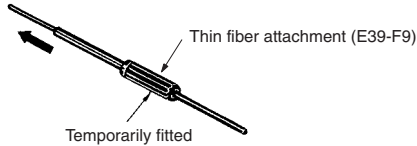

2. Secure the attachment after adjusting the position of it in the direction indicated by the arrow.



3. Insert the fiber to be cut into the E39-F4.

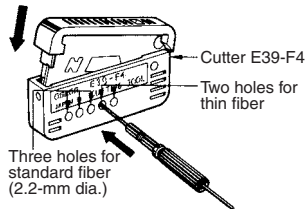

4. Finished state (proper cutting state)

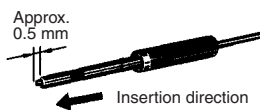

Note: Insert the fiber in the direction indicated by the arrow.

Connection

Do not pull or press the Fiber Units. The Fiber Units have a withstand force of 9.8 N or 29.4 N max. (pay utmost attention because the fibers are thin).

Do not bend the Fiber Unit beyond the permissible bending radius given under *Specifications: Amplifier Units* on page 4.

Do not bend the edge of the Fiber Units (excluding the E32-T□R and E32-D□R).

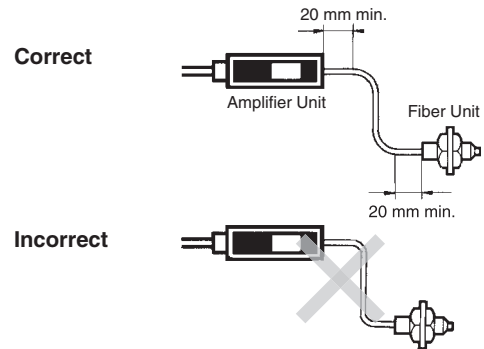

Do not apply excess force on the Fiber Units.

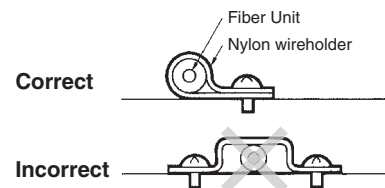

The Fiber Head could be break by excessive vibration. To prevent this, the following is effective:

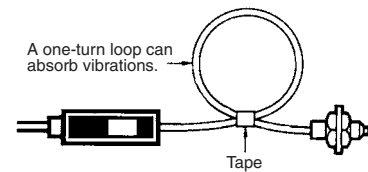

Bending Radius

E39-F11 Sleeve Bender

The bending radius of the stainless steel tube should be as large as possible. The smaller the bending radius becomes, the shorter the sensing distance will be.

Insert the tip of the stainless steel tube to the Sleeve Bender and bend the stainless steel tube slowly along the curve of the Sleeve Bender (refer to the figure).

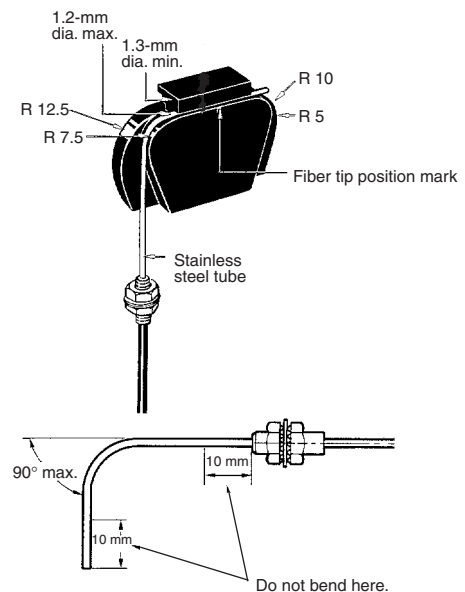

■ Amplifier Units with Connectors

Mounting

Mounting Connectors

1. Insert the Master or Slave Connector into the Amplifier Unit until it clicks into place.

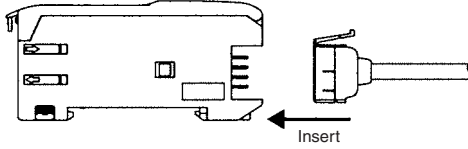

2. Join Amplifier Units together as required after all the Master and Slave Connectors have been inserted.
3. Attach the stickers (provided as accessories) to the sides of Master and Slave Connectors that are not connected to other Connectors.

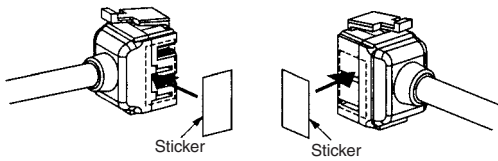

Note: Attach the stickers to the sides with grooves.

Removing Connectors

1. Slide the slave Amplifier Unit(s) for which the Connector is to be removed away from the rest of the group.
2. After the Amplifier Unit(s) has been separated, press down on the lever on the Connector and remove it. (Do not attempt to remove Connectors without separating them from other Amplifier Units first.)

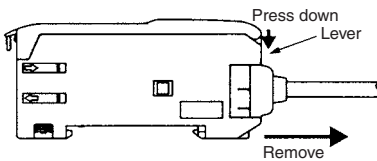

Mounting End Plate (PFP-M)

Depending on how it is mounted, an Amplifier Unit may move during operation. In this case, use an End Plate.

Before mounting an End Plate, remove the clip from the master Amplifier Unit using a nipper or similar tool.

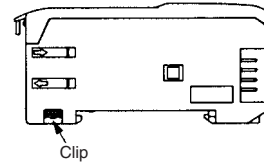

The clip can also be removed using the following mechanism, which is incorporated in the construction of the section underneath the clip.

1. Insert the clip to be removed into the slit underneath the clip on another Amplifier Unit.

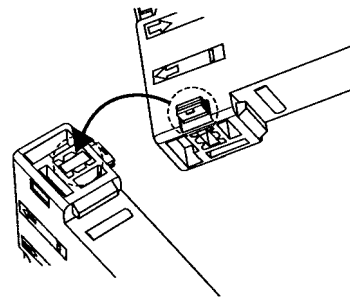

2. Remove the clip by rotating the Amplifier Unit.

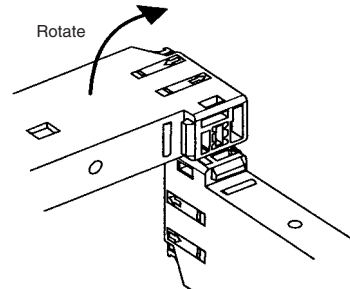

When using the E3X-DA-N with the Mobile Console, mount the End Plate in the way shown below.

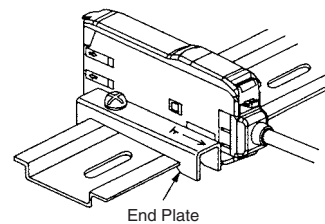

Pull Strengths for Connectors (Including Cables)

E3X-CN11, E3X-CN21, E3X-CN22: 30 N max.
E3X-CN12: 12 N max.

■ Reflector

Use of E39-R3 Reflector

Use detergent, etc., to remove any dust or oil from the surfaces where tape is applied. Adhesive tape will not be attached properly if oil or dust remains on the surface.

The E39-R3 cannot be used in places where it is exposed to oil or chemicals.

E39-F32 □ Protective Spiral Tubes

Insert a fiber to the Protective Spiral Tube from the head connector side (screwed) of the tube.

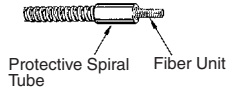

Push the fiber into the Protective Spiral Tube. The tube should be straight so that the fiber is not twisted when inserted. Then turn the end cap of the spiral tube.

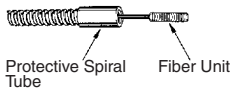

Secure the Protective Spiral Tube on a suitable place with the attached nut.

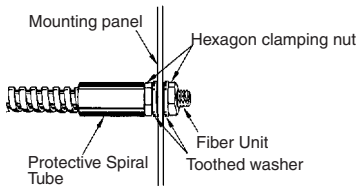

Use the attached saddle to secure the end cap of the Protective Spiral Tube. To secure the Protective Spiral Tube at a position other than the end cap, apply tape to the tube so that the portion becomes thicker in diameter.

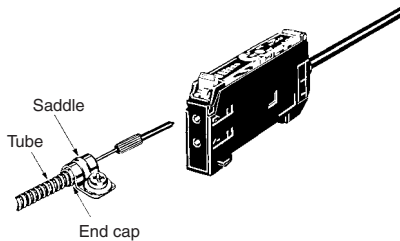

E39-F10 Fiber Connector

Mount the Fiber Connector as shown in the following illustration.

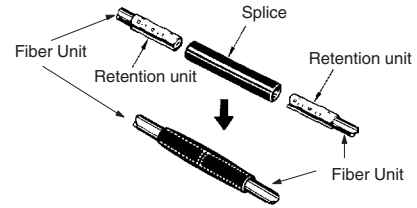

The Fiber Units should be as close as possible when they are connected.

Sensing distance will be reduced by approximately 25% when fibers are connected.

Only 2.2-mm-dia. fibers can be connected.

Dimensions

Note: All units are in millimeters unless otherwise indicated.

Amplifier Units

Amplifier Units with Cables

E3X-DA11-N	E3X-DAG11-N
E3X-DA21-N	E3X-DAH11-N
E3X-DAB11-N	E3X-DAB41-N
E3X-DA41-N	E3X-DAG41-N
E3X-DA51-N	E3X-DAH41-N

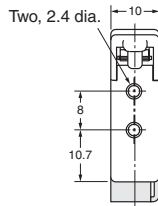
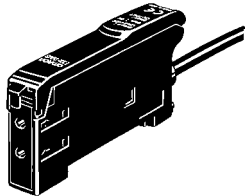

With Mounting Bracket Attached

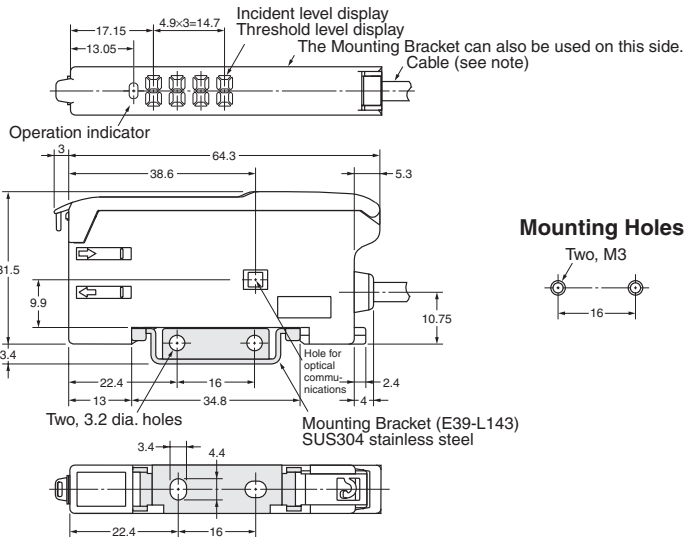

Note: E3X-DA11-N/DA41-N/DAB11-N: A 4-dia., 3-conductor, vinyl-insulated round cable (conductor cross-sectional area: 0.2 mm^2 ; insulation diameter: 1.1 mm) is used. Standard length: 2 m.

E3X-DA21-N/DA51-N: A 4-dia., 4-conductor, vinyl-insulated round cable (conductor cross-sectional area: 0.2 mm^2 ; insulation diameter: 1.1 mm) is used. Standard length: 2 m.

Amplifier Units with Cables, Water-resistant Models

E3X-DA11V
E3X-DA41V

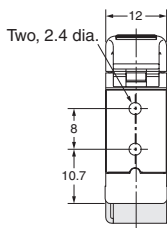
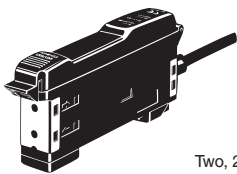

With Mounting Bracket Attached

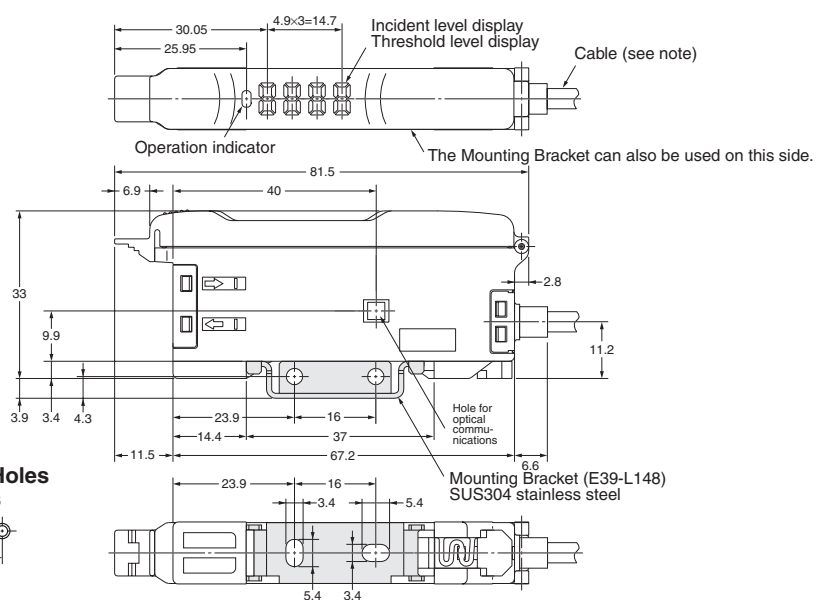

Note: A 4-dia., 3-conductor, vinyl-insulated round cable (conductor cross-sectional area: 0.2 mm^2 ; insulation diameter: 1.1 mm) is used. Standard length: 2 m.

Amplifier Units with Cables, Twin-output Models

E3X-DA11TW
E3X-DA41TW

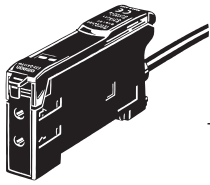

With Mounting Bracket Attached

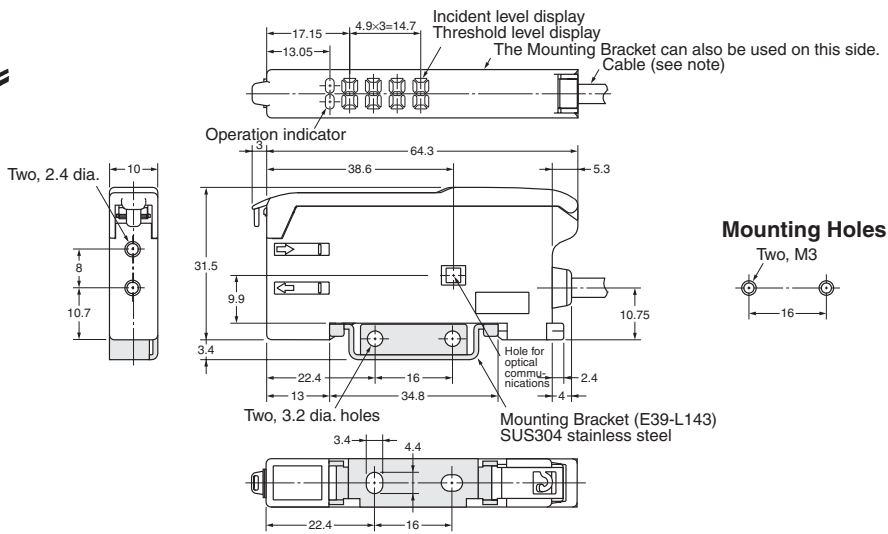

Note: A 4-dia., 4-conductor, vinyl-insulated round cable (conductor cross-sectional area: 0.2 mm²; insulation diameter: 1.1 mm) is used. Standard length: 2 m.

Amplifier Units with Standard Connectors

E3X-DA6 E3X-DAG6
E3X-DA7 E3X-DAH6
E3X-DA8 E3X-DAB8
E3X-DA9 E3X-DAG8
E3X-DAB6 E3X-DAH8

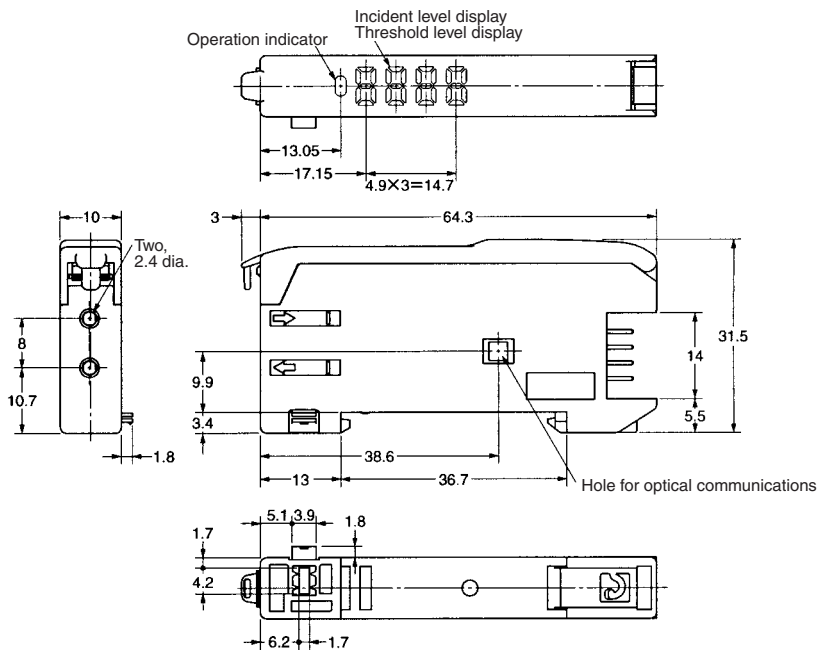
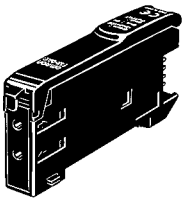

Dimensions with Master Connector Connected

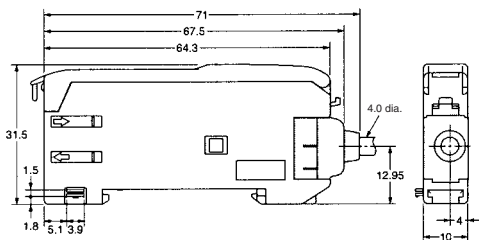

Dimensions with Slave Connector Connected

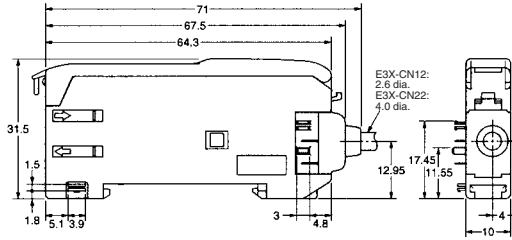

E3X-DA-N Digital Fiber Amplifier

Amplifier Units with M8 Connectors, Water-resistant Models

E3X-DA14V
E3X-DA44V

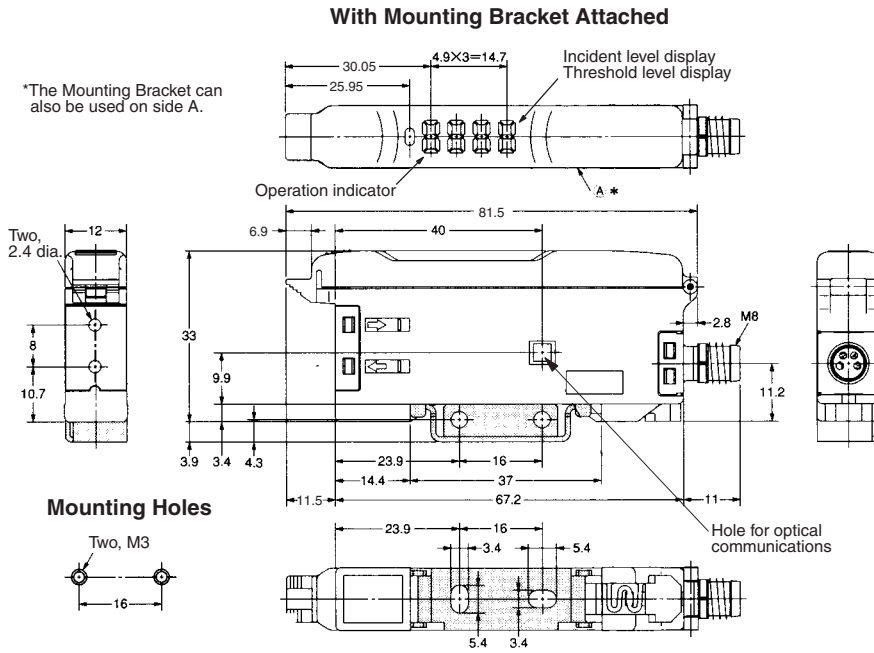
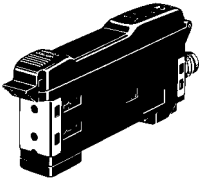

Amplifier Units with Standard Connectors, Twin-output Models

E3X-DA6TW
E3X-DA8TW

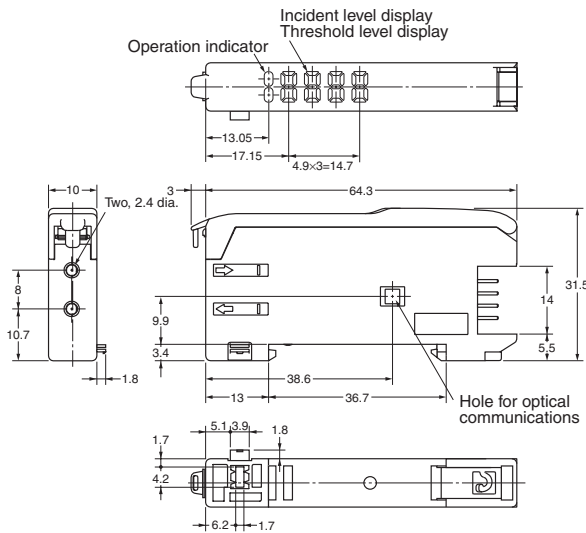
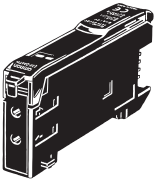

Dimensions with Master Connector Connected

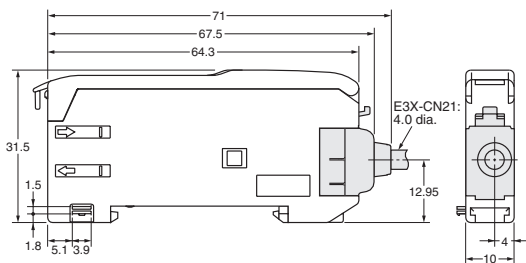

Dimensions with Slave Connector Connected

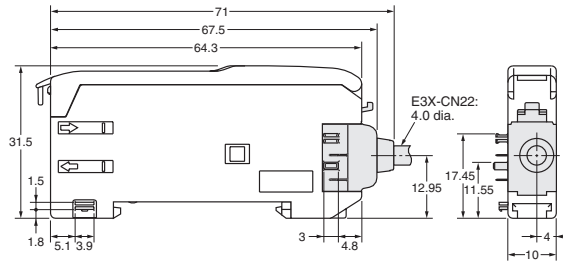

Amplifier Units with Connectors

Master Connectors

E3X-CN11
E3X-CN21

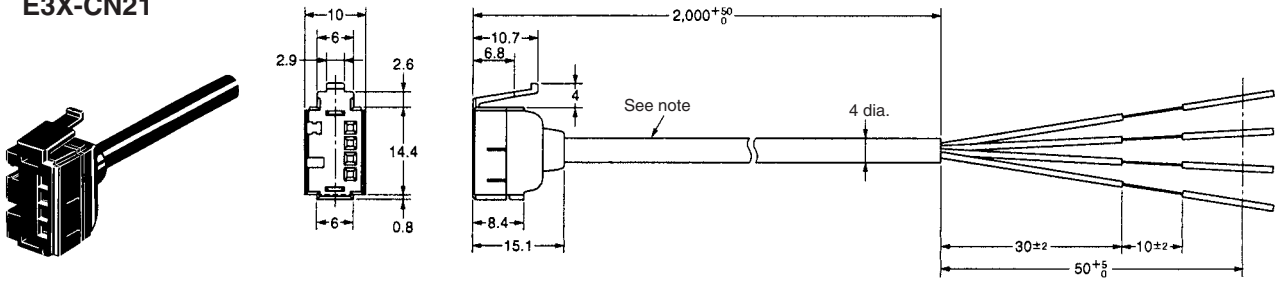

Note: E3X-CN11: A 4-dia., 3-conductor, vinyl-insulated round cable (conductor cross-sectional area: 0.2 mm²; insulation diameter: 1.1 mm) is used.

E3X-CN21: A 4-dia., 4-conductor, vinyl-insulated round cable (conductor cross-sectional area: 0.2 mm²; insulation diameter: 1.1 mm) is used.

Slave Connectors

E3X-CN12
E3X-CN22

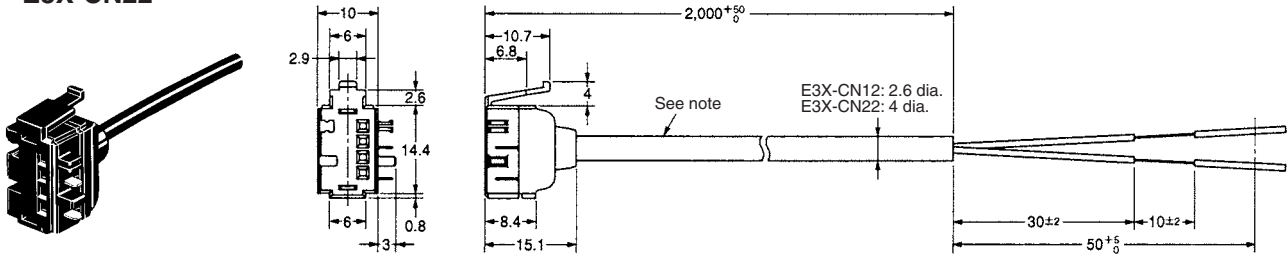

Note: E3X-CN12: A 2.6-dia., single-conductor, vinyl-insulated round cable (conductor cross-sectional area: 0.2 mm²; insulation diameter: 1.1 mm) is used.

E3X-CN22: A 4-dia., 2-conductor, vinyl-insulated round cable (conductor cross-sectional area: 0.2 mm²; insulation diameter: 1.1 mm) is used.

Sensor I/O Connectors

Straight Connector (at One End of Cable)

XS3F-M421-402-A (L=2 m)
XS3F-M421-405-A (L=5 m)

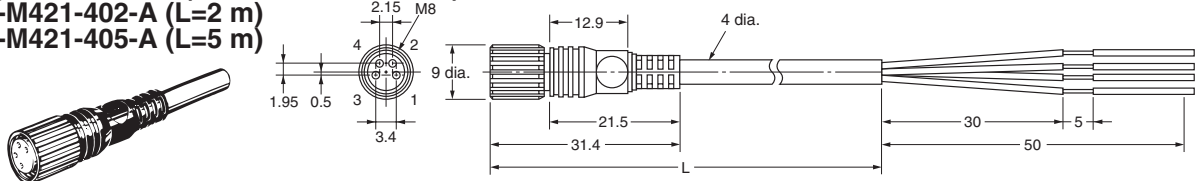

L-shaped Connector (at One End of Cable)

XS3F-M422-402-A (L=2 m)
XS3F-M422-405-A (L=5 m)

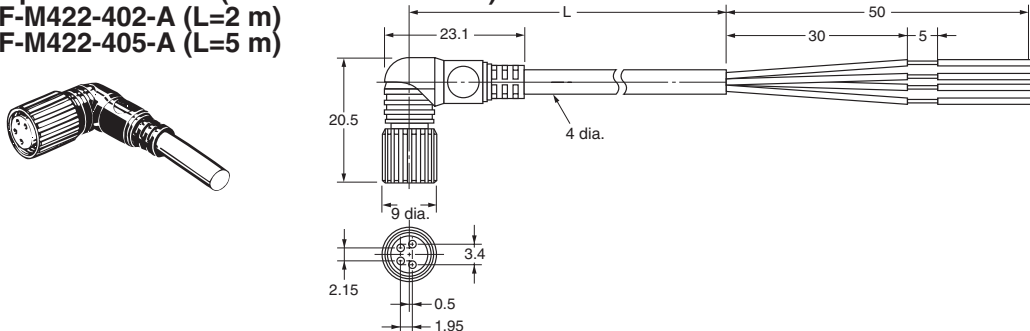

Mobile Console

(Set: E3X-MC11)
(Console only: E3X-MC11-C1)

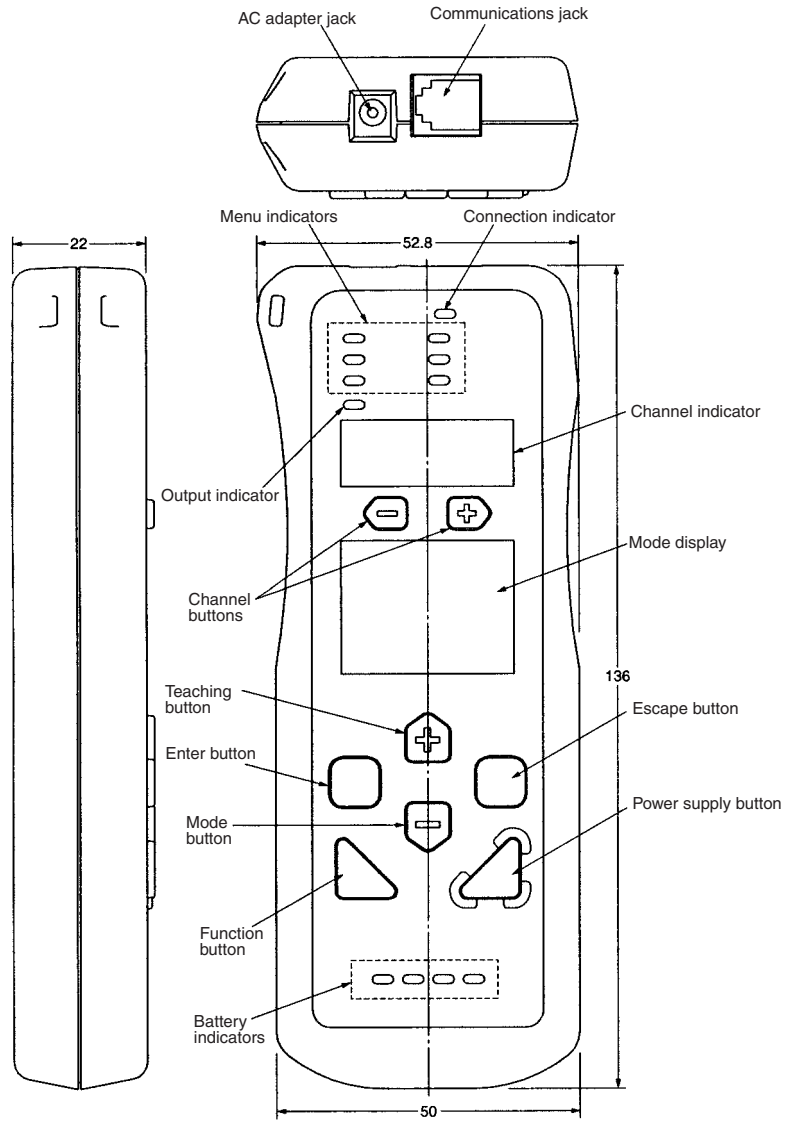

Mobile Console Head (E3X-MC11-H1)

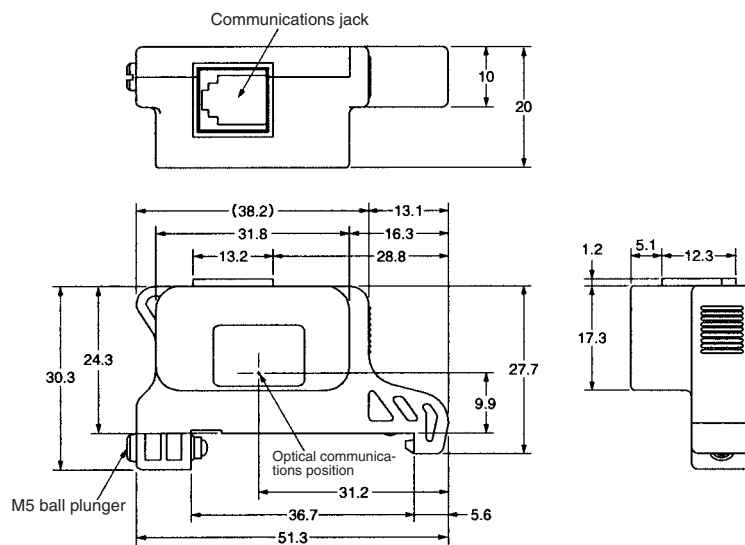
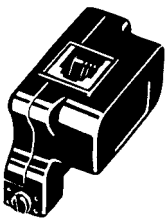

Mounting Brackets

E39-L143

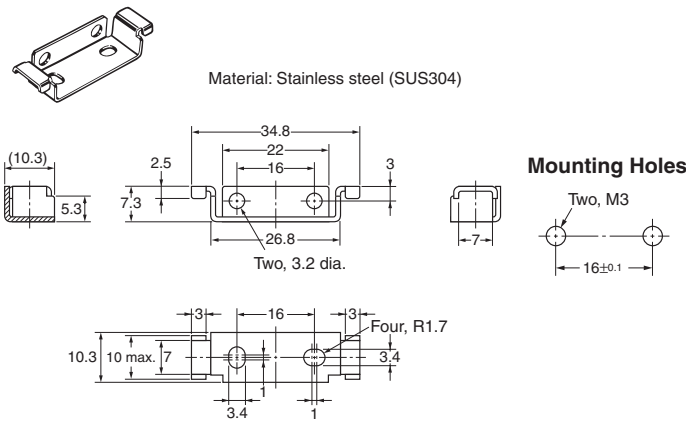

E39-L148

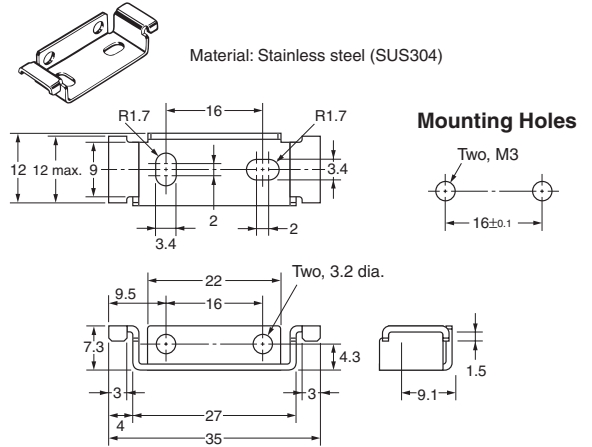

End Plate

PFP-M

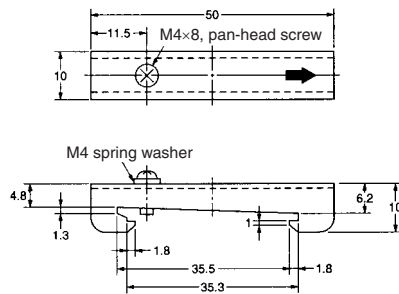
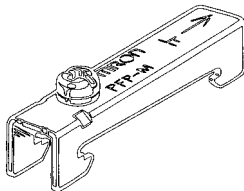

Operating Instructions Sticker

E39-Y1 (1 English and 1 Japanese sticker per set)

Material

Front side: Paper

Reverse side: Adhesive tape

Japanese Sticker

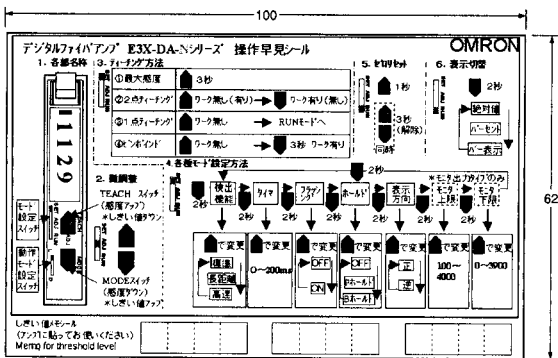

English Sticker

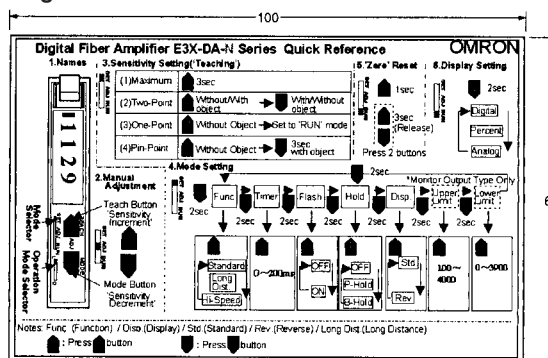

■ Fiber Units

Through-beam Fiber Units (Sold in Pairs)

(Free-cut) Indicates models that allow free cutting. Models without this mark do not allow free cutting.

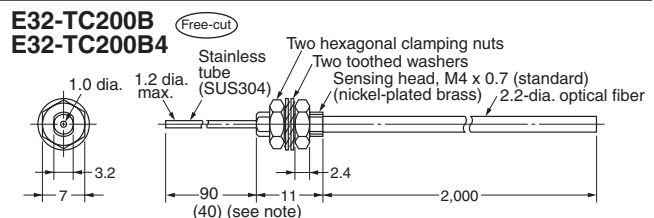
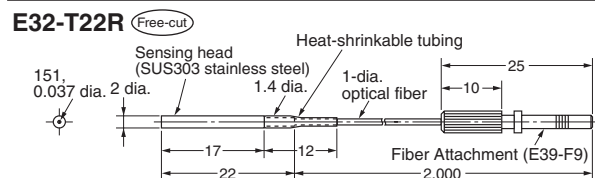
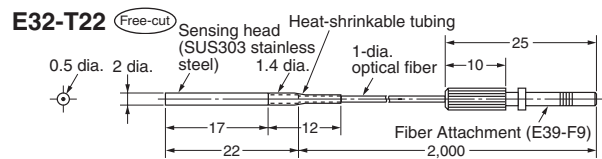
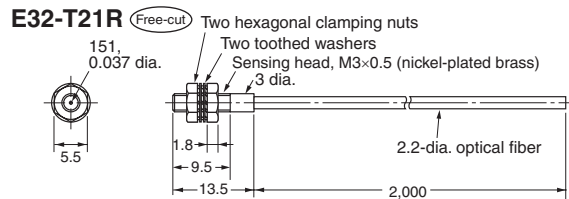
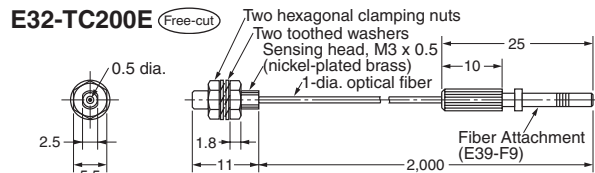
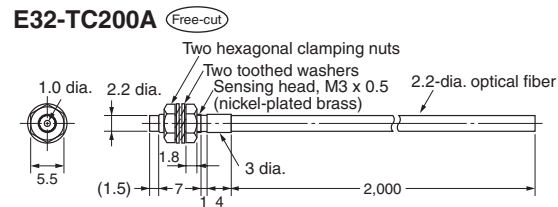
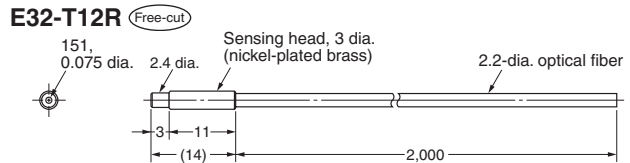
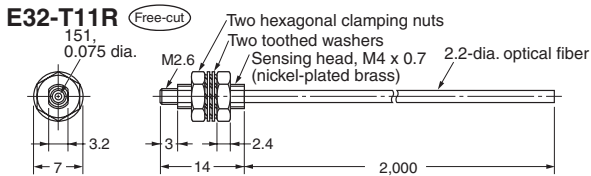
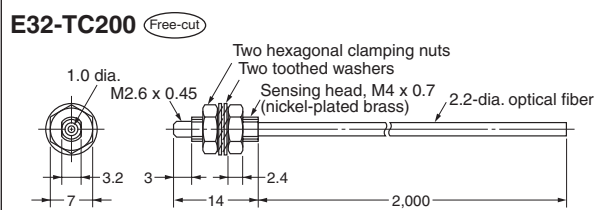
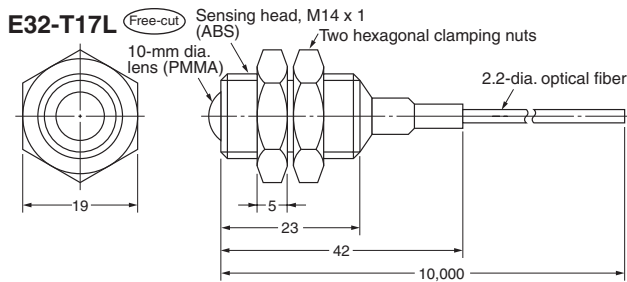
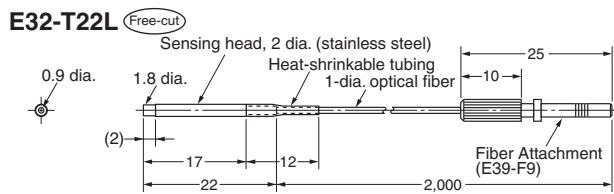
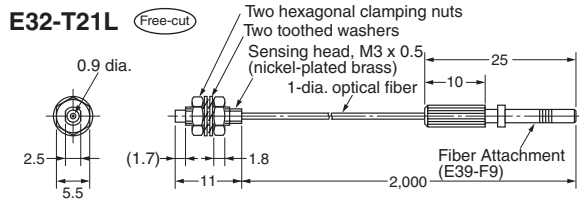
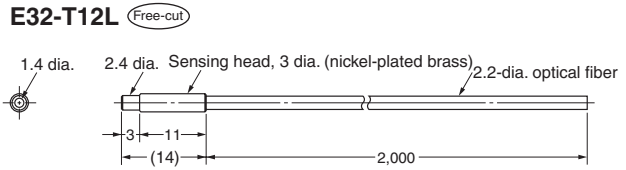
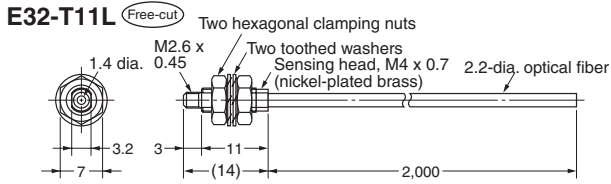

Note: The value in the parentheses is for the E32-TC200B4.

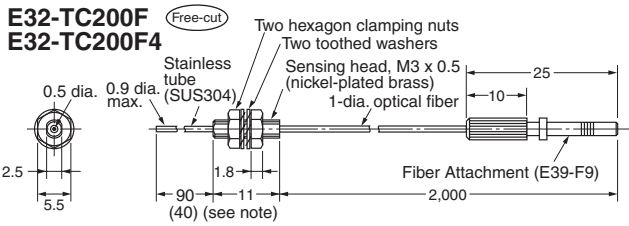

Note: The value in the parentheses is for the E32-TC200F4.

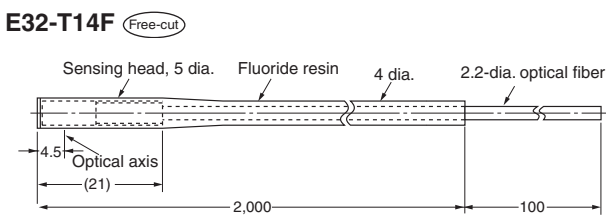
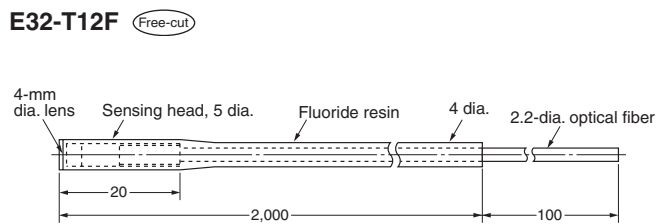
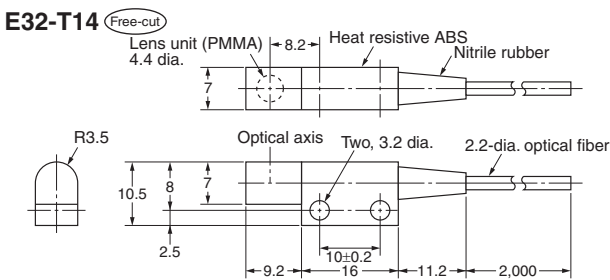
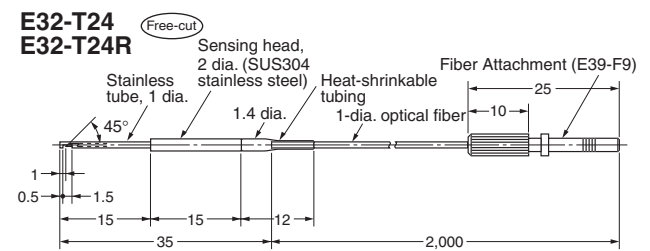
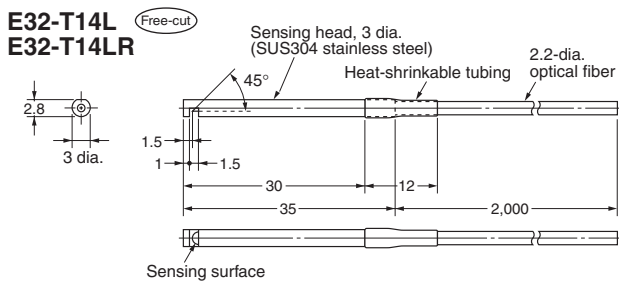
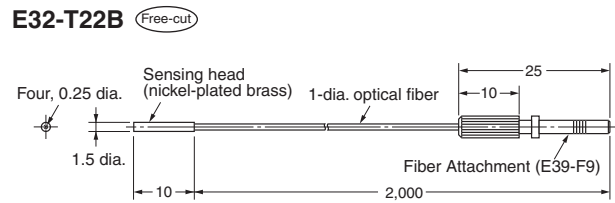
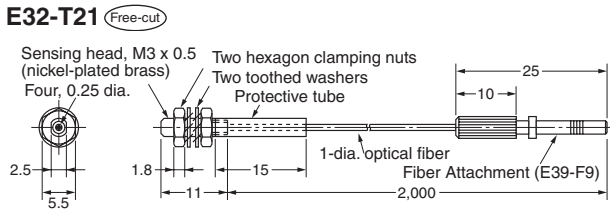
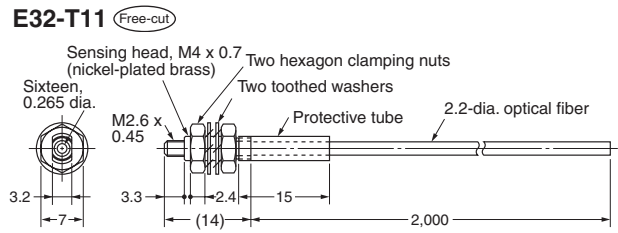

E32-T81F

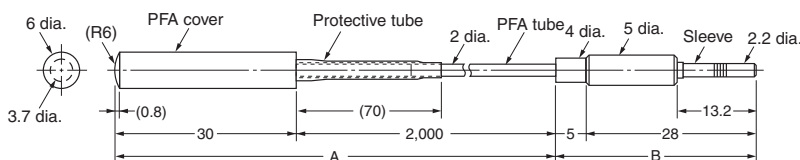

Note: Section A resists 200°C and section B resists 110°C.

E32-T81R

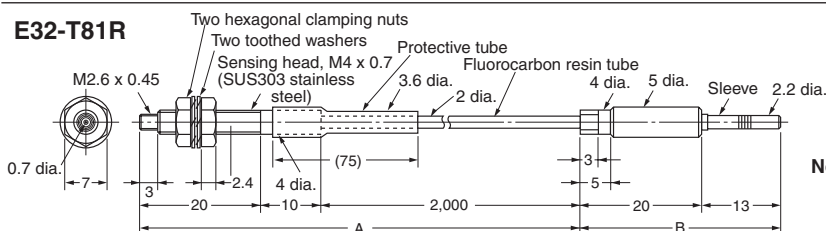

Note: Section A resists 200°C and section B resists 110°C.

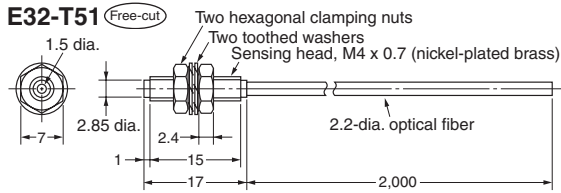

Note: Resistant temperature is 150°C.
Resistant temperature is 130°C when used continuously.

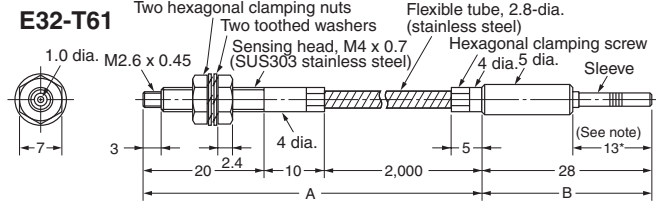

Note: Section A resists 300°C and section B (which is inserted to the Amplifier) resists 110°C.
The operating temperature of the section to be inserted into the Sensor (marked with *) must be within the operating temperature range of the Amplifier.

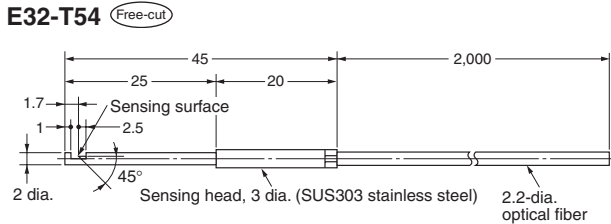

Note: Resistant temperature is 150°C.
Resistant temperature is 130°C when used continuously.

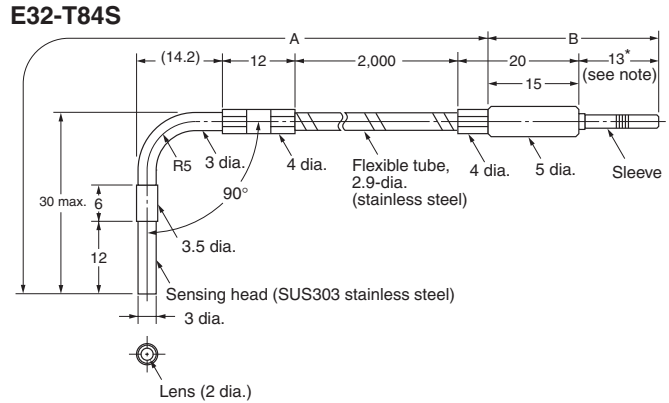

Note: Section A resists 200°C and section B (which is inserted to the Amplifier) resists 110°C.
The operating temperature of section to be inserted into the Sensor (marked with *) must be within the operating temperature range of the Amplifier.

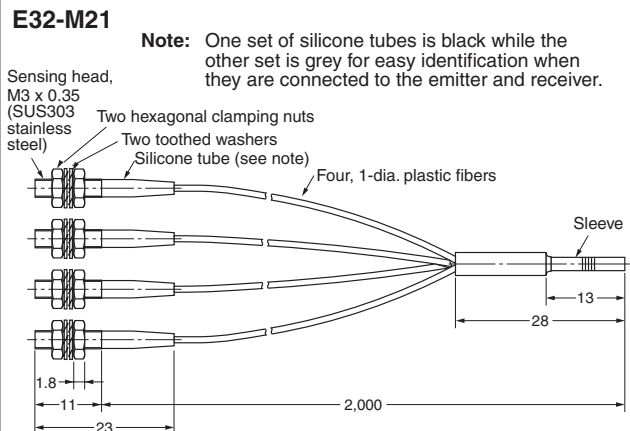
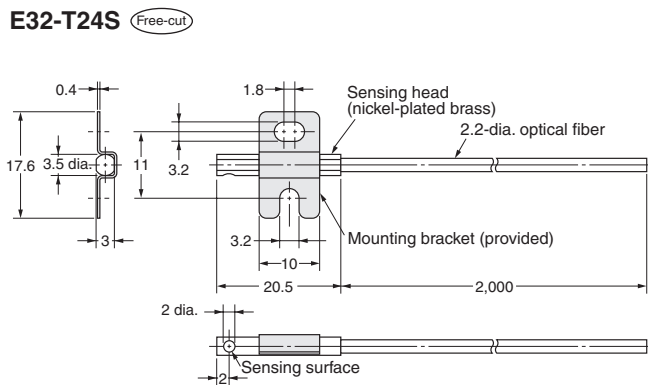
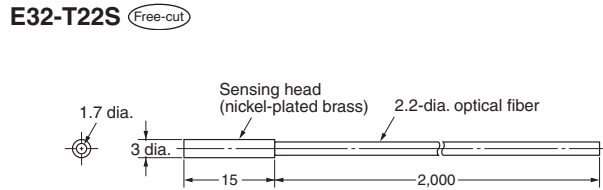
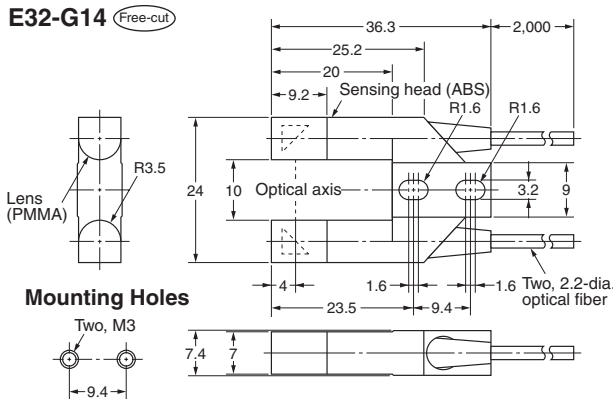

E32-T16W
E32-T16WR

(Free-cut)

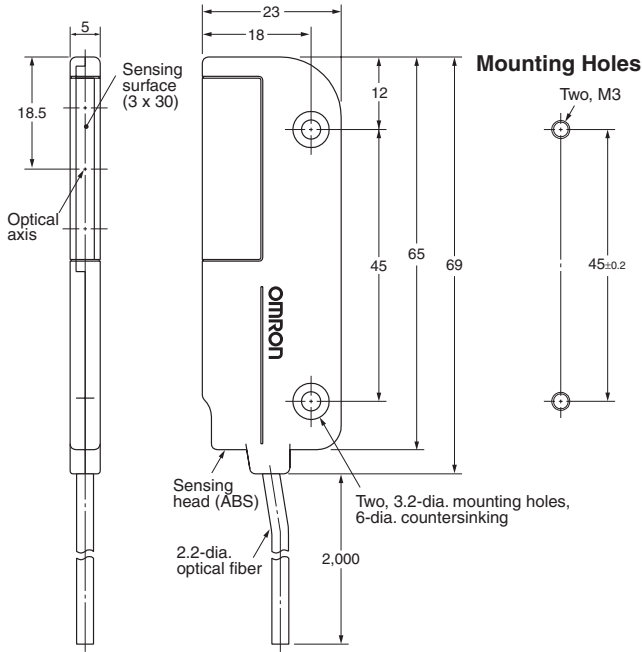

E32-T16J
E32-T16JR

(Free-cut)

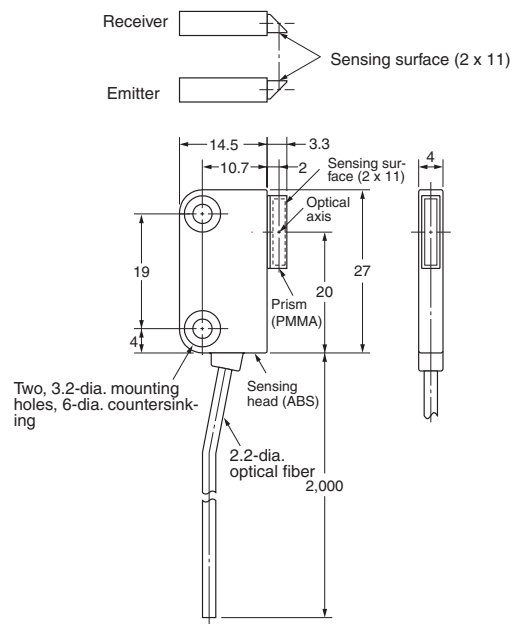

E32-T16

(Free-cut)

With Mounting Bracket

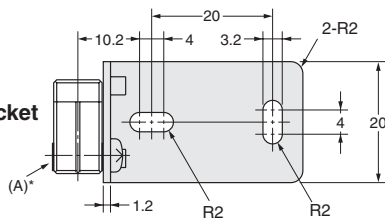

Mounting Holes

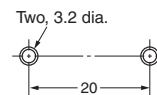

0.5-mm-wide Slit Seal
(Supplied with the Unit in Pairs)

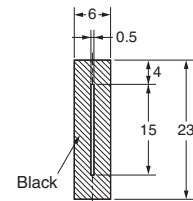

* Mounting bracket can be attached to side A.

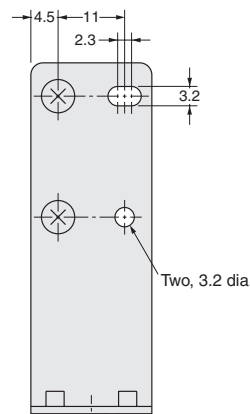
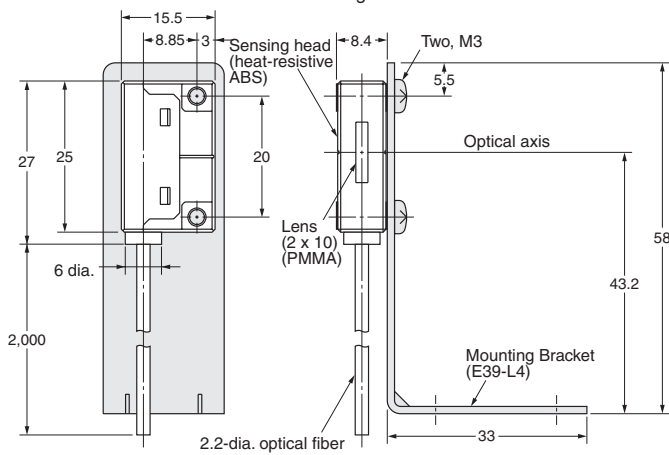

1-mm-wide Slit Seal
(Supplied with the Unit in Pairs)

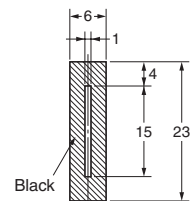

E3X-DA-N Digital Fiber Amplifier

E32-T16P Free-cut
E32-T16PR

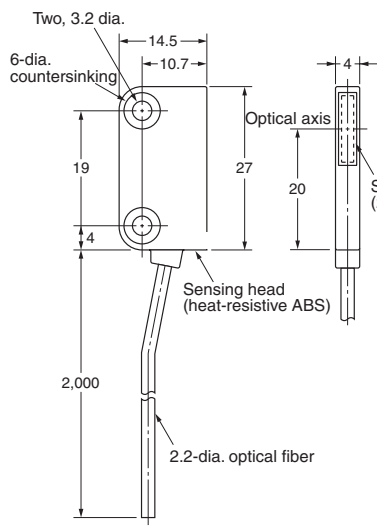

**0.5-mm-wide Slit Seal
 (Supplied with the Unit
 in Pairs)**

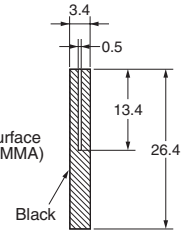

**1-mm-wide Slit Seal
 (Supplied with the Unit
 in Pairs)**

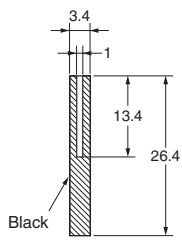

With Mounting Bracket

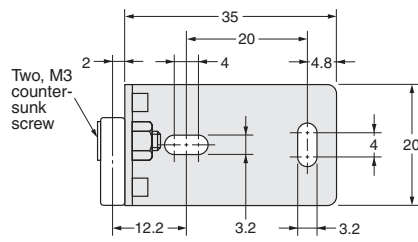

Mounting Holes

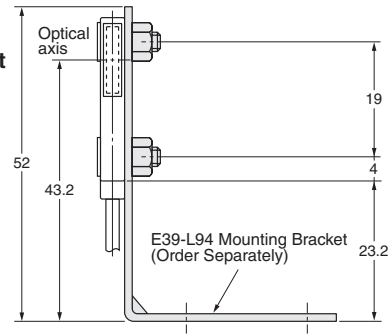
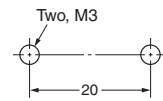

Reflective Fiber Units

Free-cut Indicates models that allow free cutting. Models without this mark do not allow free cutting.

E32-D11L **Free-cut**

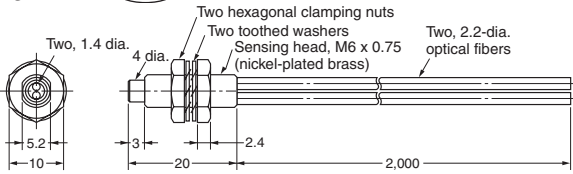

E32-D12 **Free-cut**

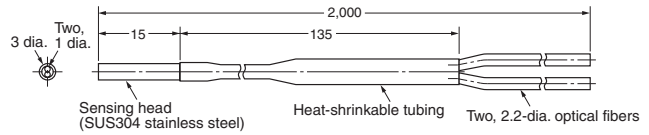

E32-D21L **Free-cut**

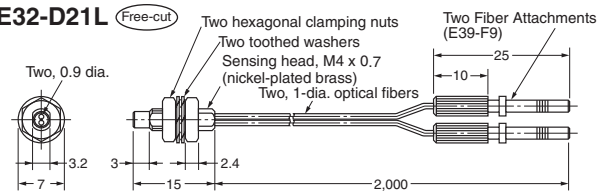

E32-D22L **Free-cut**

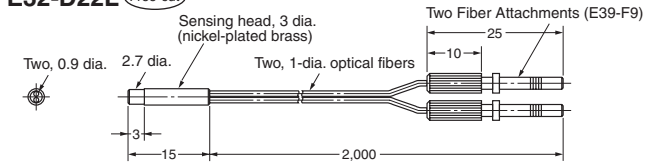

E32-DC200 **Free-cut**

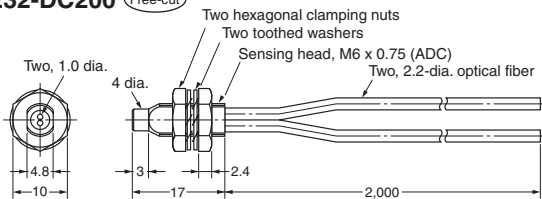

E32-D11R **Free-cut**

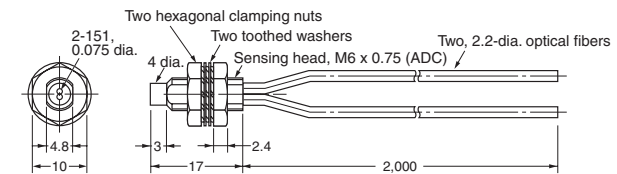

E32-D12R **Free-cut**

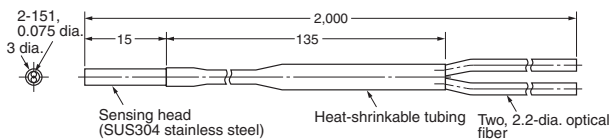

E32-DC200E **Free-cut**

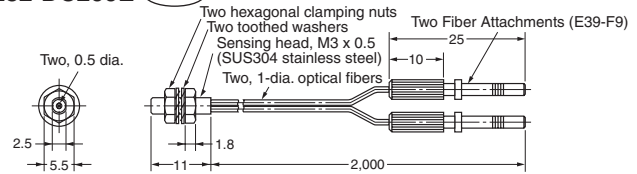

E32-D21R **Free-cut**

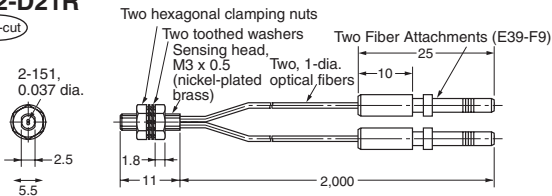

E32-D22R **Free-cut**

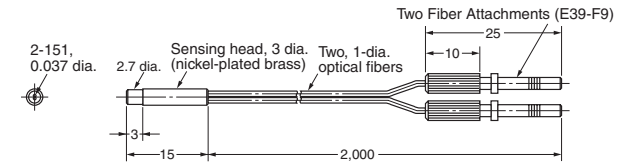

E32-DC200B **Free-cut**
E32-DC200B4

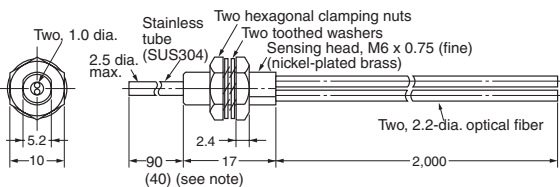

Note: The value in the parentheses is for the E32-DC200B4.

E32-DC200F **Free-cut**
E32-DC200F4

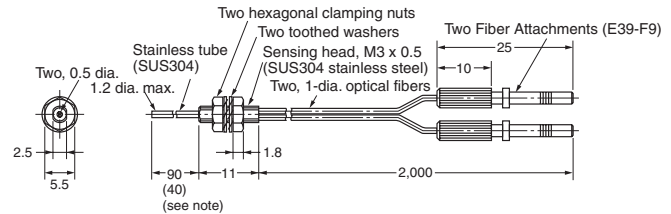

Note: The value in the parentheses is for the E32-DC200F4.

E32-D33 (Free-cut)

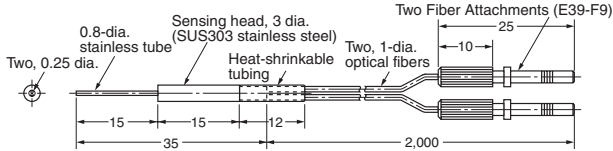

E32-D331

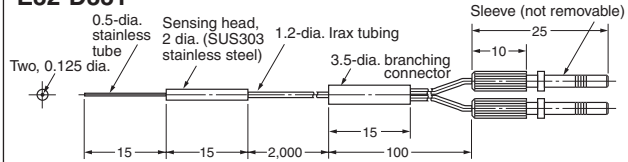

E32-D11 (Free-cut)

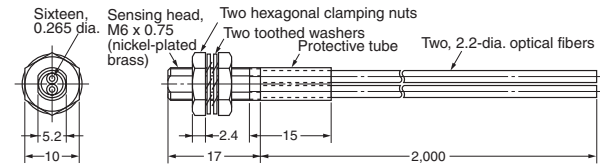

E32-D21 (Free-cut)

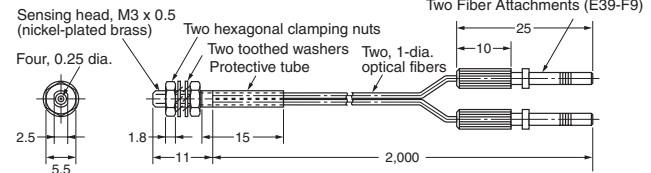

E32-D21B (Free-cut)

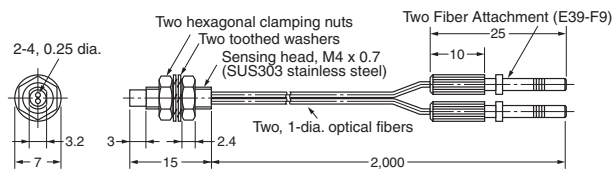

E32-D22B

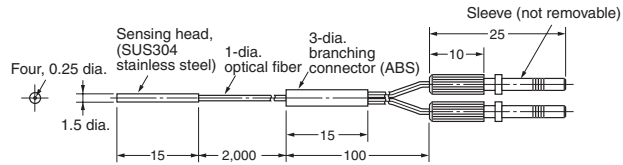

E32-CC200 (Free-cut)

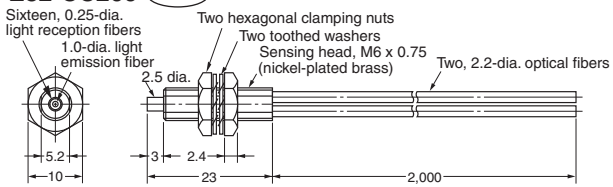

E32-D32L (Free-cut)

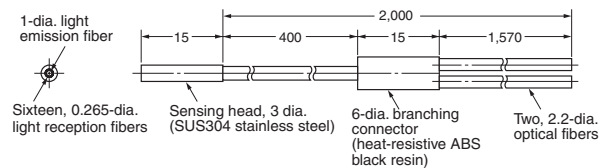

Note: The fiber for the emitter is identified by a white line.

Note: The fiber for the emitter is identified by a yellow dotted line.

E32-C31 (Free-cut)

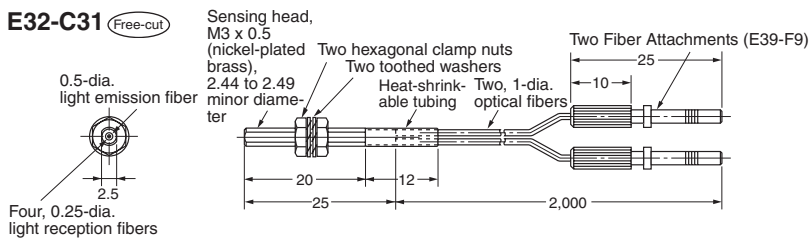

Note: The fiber for the emitter is identified by a white line.

E32-C41

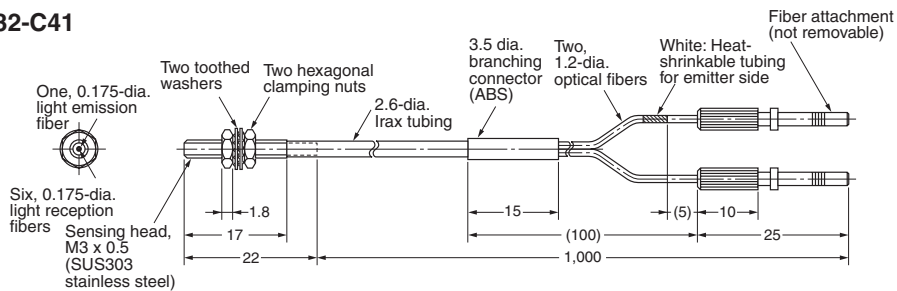

E32-C42

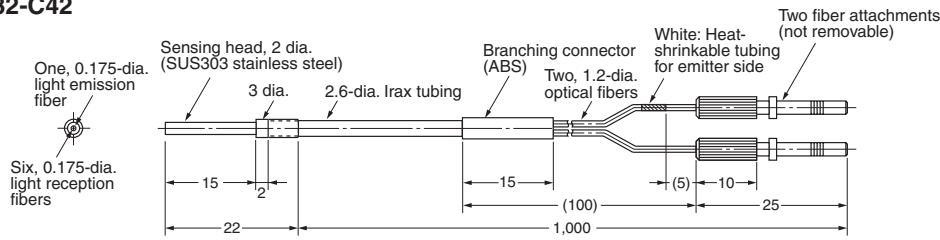

E32-D32 (Free-cut)

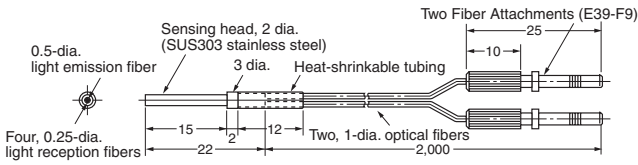

Note: The fiber for the emitter is identified by a white line.

E32-D14L (Free-cut) E32-D14LR

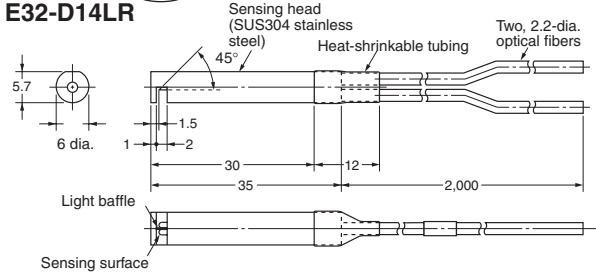

E32-D24 (Free-cut) E32-D24R

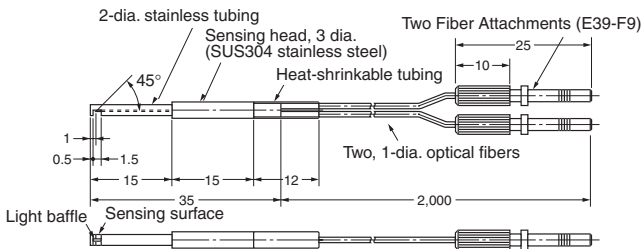

E32-D12F (Free-cut)

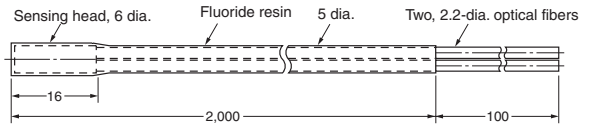

E32-D51 (Free-cut)

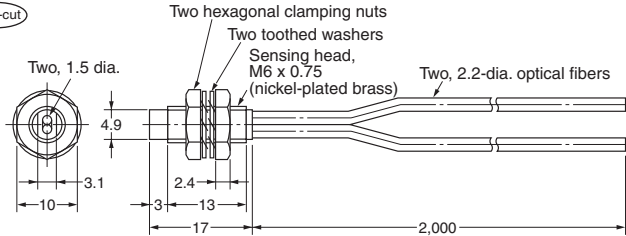

Note: Resistant temperature is 150°C.
Resistant temperature is 130°C
when used continuously.

E32-D61

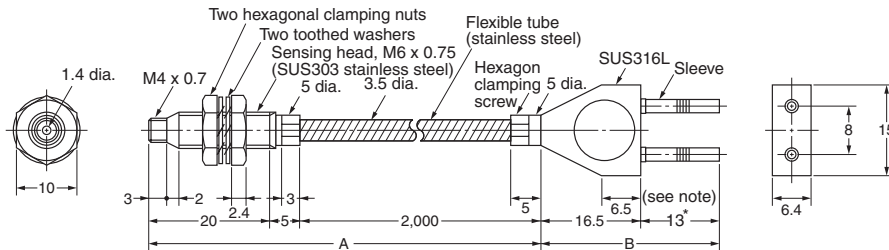

Note: Section A resists 300°C and section B (which is inserted to the Amplifier) resists 110°C. The operating temperature of the section to be inserted into the Sensor (marked with *) must be within the operating temperature range of the Amplifier.

E32-D73

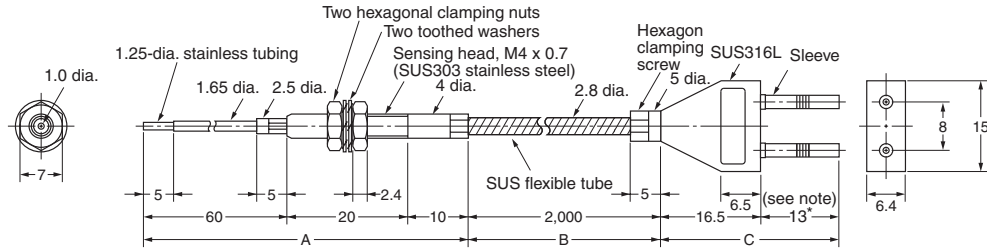

Note: Section A resists 400°C, section B resists 300°C, and section C (which is inserted to the Amplifier) resists 110°C. The operating temperature of the section to be inserted into the Sensor (marked with *) must be within the operating temperature range of the Amplifier.

E32-D36P1

(Free-cut)

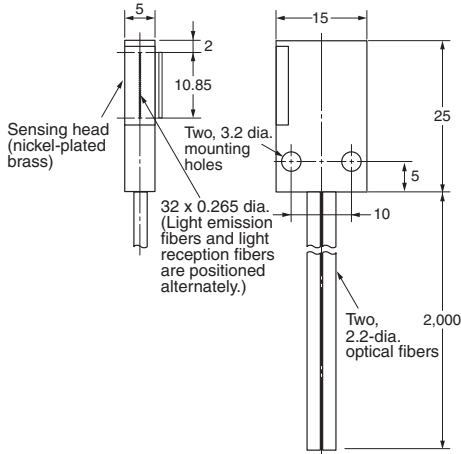

Mounting Holes

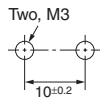

E32-R21 (One E39-R3 Reflector is Supplied with the Sensor)

(Free-cut)

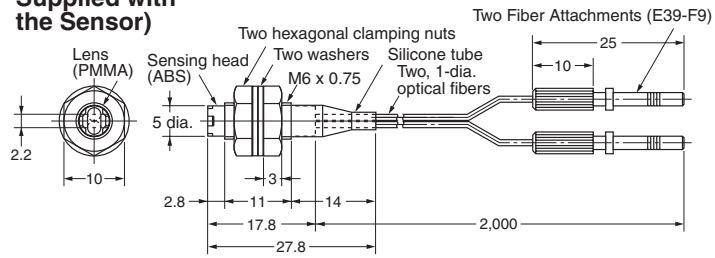

E32-R16 (One E39-R1 Reflector is Supplied with the Sensor)

(Free-cut)

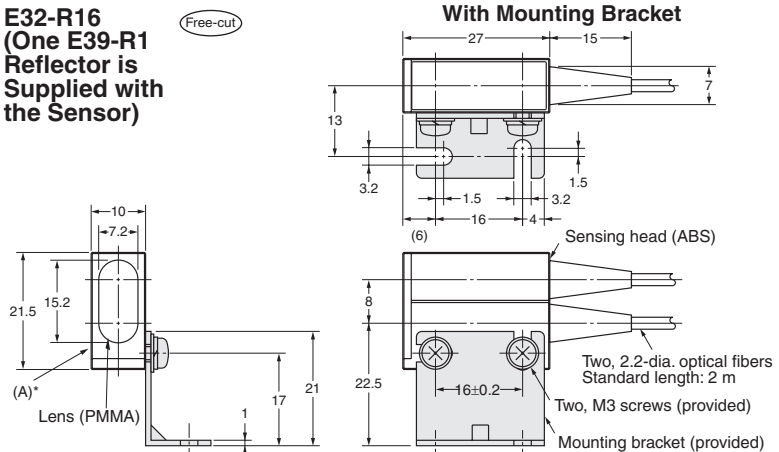

* Mounting bracket can be attached to side A.

E32-L56E1 E32-L56E2

(Free-cut)

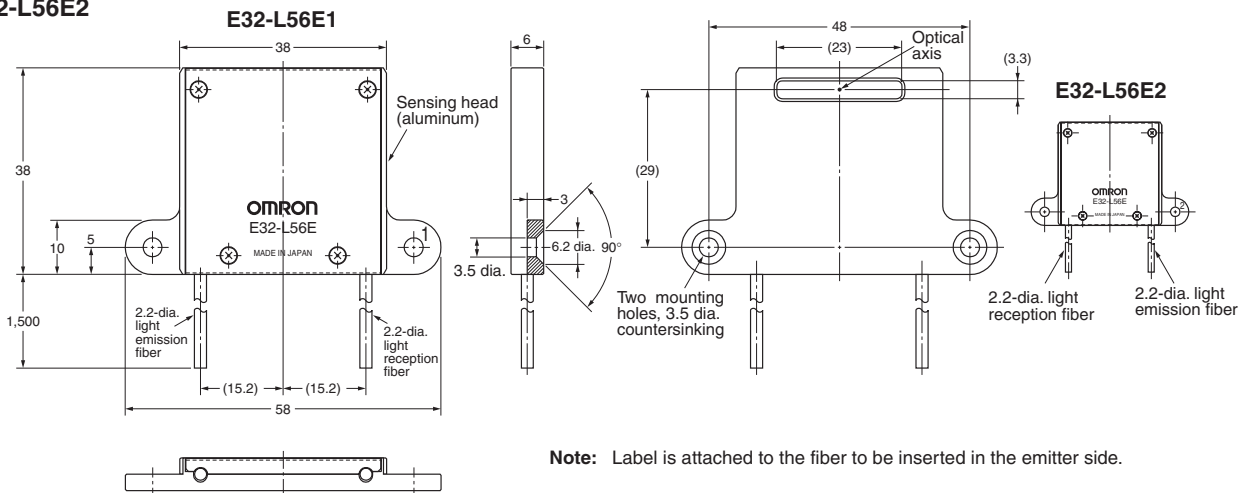

Note: Label is attached to the fiber to be inserted in the emitter side.

E32-L24L (Free-cut)

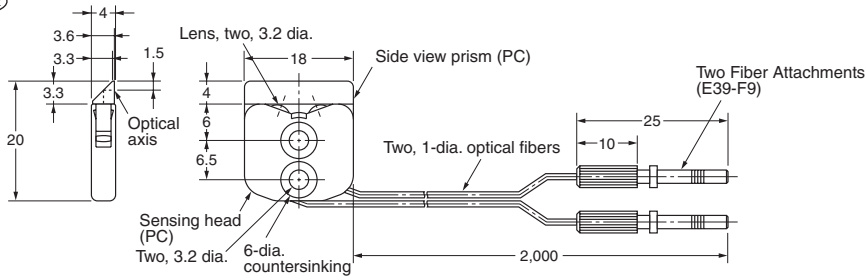

E32-L25L (Free-cut)

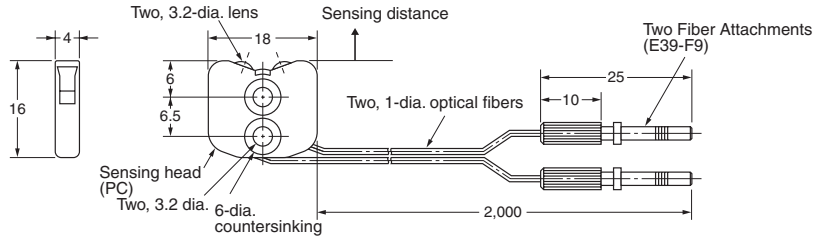

E32-L25 (Free-cut)

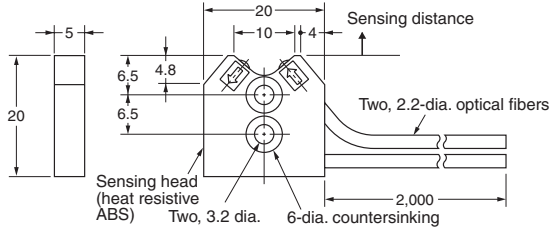

Note: The fiber for the emitter is identified by a white line.

E32-L25A (Free-cut)

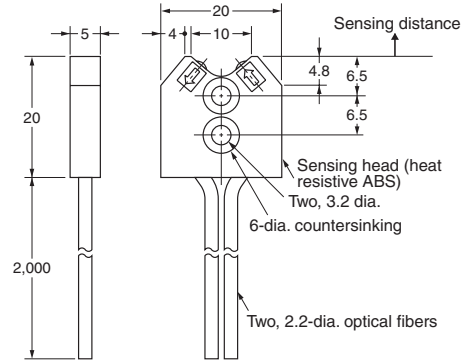

Note: The fiber for the emitter is identified by a white line.

Accessories (Order Separately)

Reflectors

Reflector E39-R1



Material:
Reflective surface:
acrylic
Back: ABS

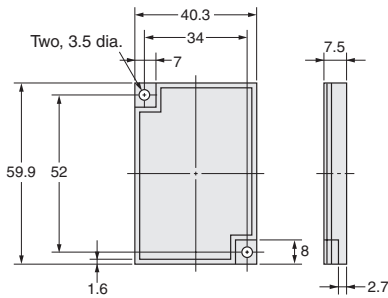

Reflector (Miniature) E39-R3



Material:
Reflective surface:
acrylic
Back: ABS

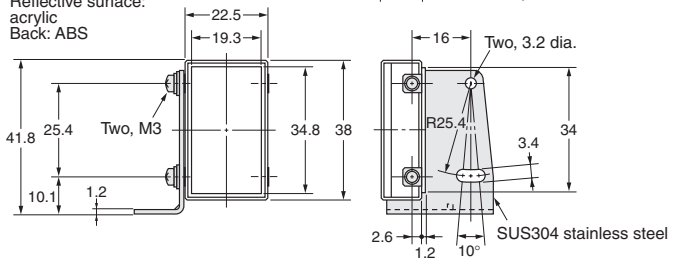

E39-L4

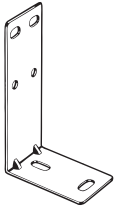

Material: iron

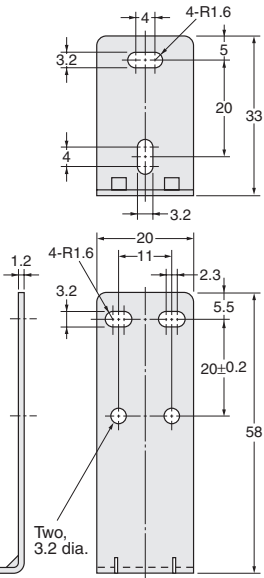

E39-L94

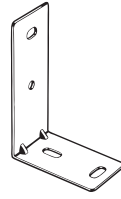

Material: iron

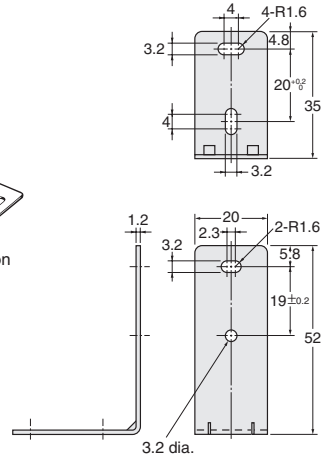

Lens Units

E39-F1 Long Distance Lens Unit



Material:
Tube: Brass
Lens: Optical glass

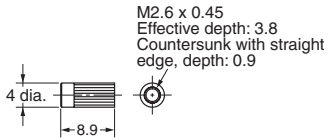

Note: One set includes two units.

E39-F2 Side-view Unit



Material:
Tube: Brass
Lens: Optical glass

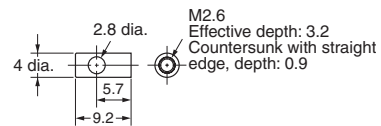

Note: One set includes two units.

E39-F3 Lens-equipped Reflective Unit

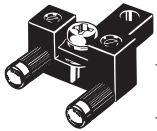

Material:
Tube: Brass
Base: Aluminum

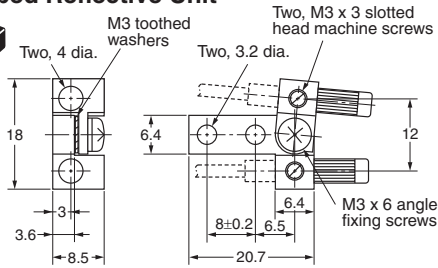

Note: Fix the fiber head using the slotted head machine screw. Do not insert the E39-F1 Lens.

E39-F5 Side-view Reflective Unit

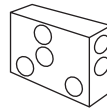

Material:
Base: Brass
Reflector: Stainless steel

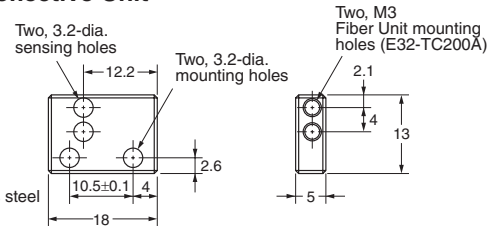

Note: Only E32-TC200A can be mounted. When mounting, remove all of the accompanying screws first and then screw the E32-TC200A into the E39-F5 until the stopper comes into contact.

**E39-F3A
Small Spot Lens Unit**

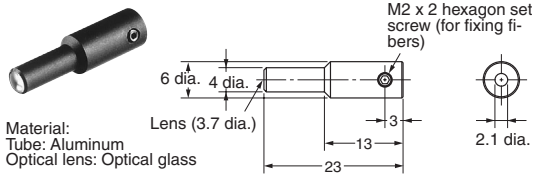

Note: E39-F3A is a Lens Unit for the E32-D32 and E32-C42.

**E39-F3A-5
Small Spot Lens Unit**

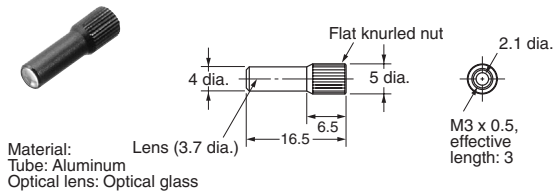

Note: E39-F3A-5 is a Lens Unit for the E32-C31 and E32-C41.

**E39-F3B
Small Spot Lens Unit**

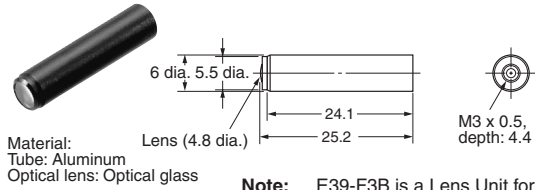

Note: E39-F3B is a Lens Unit for the E32-C31 and E32-C41.

**E39-F3C
Small Spot Lens Unit**

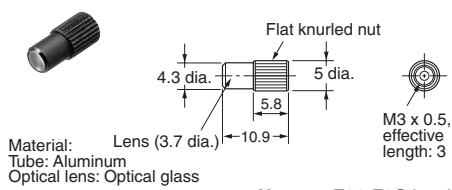

Note: E39-F3C is a Lens Unit for the E32-C31 and E32-C41.

Protective Spiral Tubes

**E39-F32A, E39-F32A5
E39-F32B, E39-F32B5**

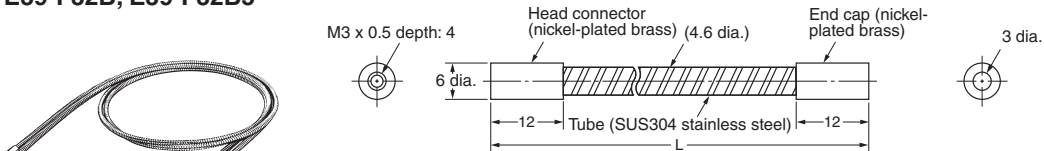

Note: 1. L is as follows:
E39-F32A and E39-F32B: 1,000
E39-F32A5, E39-F32B5: 500
2. A pair of E39-F32A(5)'s is sold as E39-F32B(5).

E39-F32C, E39-F32C5

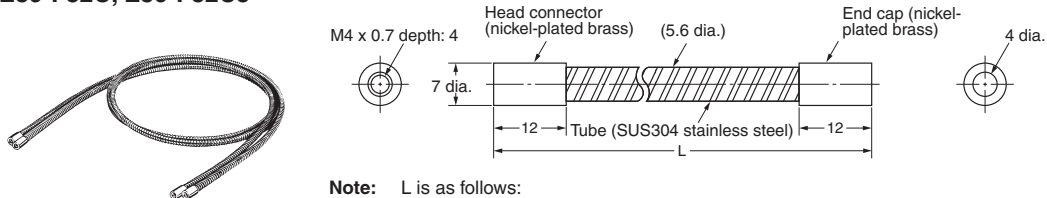

Note: L is as follows:
E39-F32C: 1,000
E39-F32C5: 500

E39-F32D, E39-F32D5

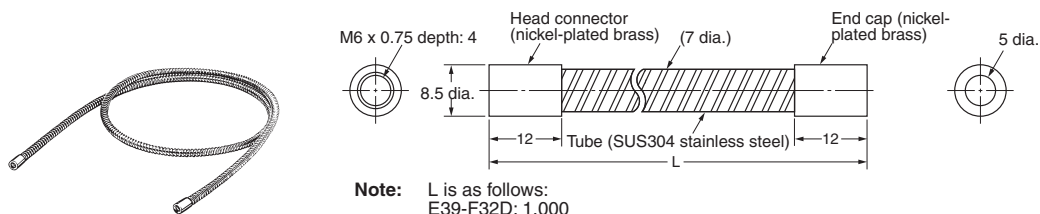

Note: L is as follows:
E39-F32D: 1,000
E39-F32D5: 500

Other Accessories

E39-F4 Fiber Cutter

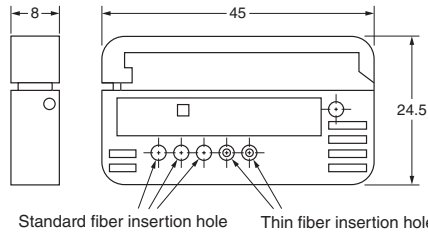
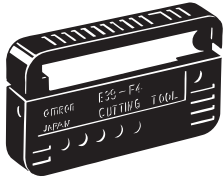

E39-F9 Attachment for Thin Fiber

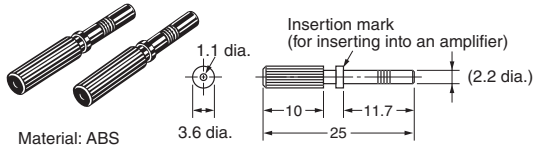

Material: ABS

Note: One set includes two units.
Included with Thin Fiber Unit.

E39-F10 Fiber Connector

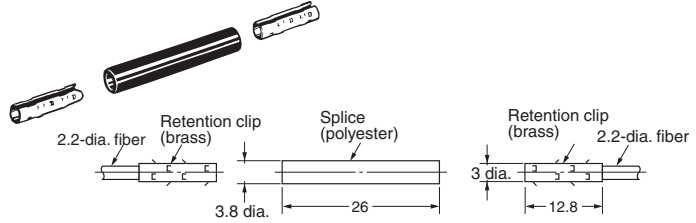

E39-F11 Sleeve Bender

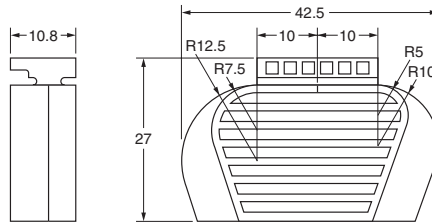

E39-K2 Protective Attachment



Material: ABS

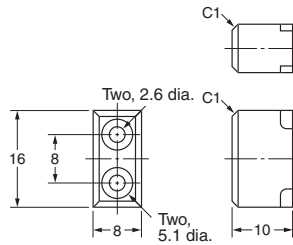

Application Example

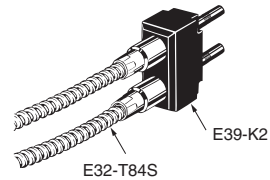

READ AND UNDERSTAND THIS DOCUMENT

Please read and understand this document before using the products. Please consult your OMRON representative if you have any questions or comments.

WARRANTY

OMRON's exclusive warranty is that the products are free from defects in materials and workmanship for a period of one year (or other period if specified) from date of sale by OMRON.

OMRON MAKES NO WARRANTY OR REPRESENTATION, EXPRESS OR IMPLIED, REGARDING NON-INFRINGEMENT, MERCHANTABILITY, OR FITNESS FOR PARTICULAR PURPOSE OF THE PRODUCTS. ANY BUYER OR USER ACKNOWLEDGES THAT THE BUYER OR USER ALONE HAS DETERMINED THAT THE PRODUCTS WILL SUITABLY MEET THE REQUIREMENTS OF THEIR INTENDED USE. OMRON DISCLAIMS ALL OTHER WARRANTIES, EXPRESS OR IMPLIED.

LIMITATIONS OF LIABILITY

OMRON SHALL NOT BE RESPONSIBLE FOR SPECIAL, INDIRECT, OR CONSEQUENTIAL DAMAGES, LOSS OF PROFITS OR COMMERCIAL LOSS IN ANY WAY CONNECTED WITH THE PRODUCTS, WHETHER SUCH CLAIM IS BASED ON CONTRACT, WARRANTY, NEGLIGENCE, OR STRICT LIABILITY.

In no event shall responsibility of OMRON for any act exceed the individual price of the product on which liability is asserted.

IN NO EVENT SHALL OMRON BE RESPONSIBLE FOR WARRANTY, REPAIR, OR OTHER CLAIMS REGARDING THE PRODUCTS UNLESS OMRON'S ANALYSIS CONFIRMS THAT THE PRODUCTS WERE PROPERLY HANDLED, STORED, INSTALLED, AND MAINTAINED AND NOT SUBJECT TO CONTAMINATION, ABUSE, MISUSE, OR INAPPROPRIATE MODIFICATION OR REPAIR.

SUITABILITY FOR USE

THE PRODUCTS CONTAINED IN THIS DOCUMENT ARE NOT SAFETY RATED. THEY ARE NOT DESIGNED OR RATED FOR ENSURING SAFETY OF PERSONS, AND SHOULD NOT BE RELIED UPON AS A SAFETY COMPONENT OR PROTECTIVE DEVICE FOR SUCH PURPOSES. Please refer to separate catalogs for OMRON's safety rated products.

OMRON shall not be responsible for conformity with any standards, codes, or regulations that apply to the combination of products in the customer's application or use of the product.

At the customer's request, OMRON will provide applicable third party certification documents identifying ratings and limitations of use that apply to the products. This information by itself is not sufficient for a complete determination of the suitability of the products in combination with the end product, machine, system, or other application or use.

The following are some examples of applications for which particular attention must be given. This is not intended to be an exhaustive list of all possible uses of the products, nor is it intended to imply that the uses listed may be suitable for the products:

- Outdoor use, uses involving potential chemical contamination or electrical interference, or conditions or uses not described in this document.
- Nuclear energy control systems, combustion systems, railroad systems, aviation systems, medical equipment, amusement machines, vehicles, safety equipment, and installations subject to separate industry or government regulations.
- Systems, machines, and equipment that could present a risk to life or property.

Please know and observe all prohibitions of use applicable to the products.

NEVER USE THE PRODUCTS FOR AN APPLICATION INVOLVING SERIOUS RISK TO LIFE OR PROPERTY WITHOUT ENSURING THAT THE SYSTEM AS A WHOLE HAS BEEN DESIGNED TO ADDRESS THE RISKS, AND THAT THE OMRON PRODUCT IS PROPERLY RATED AND INSTALLED FOR THE INTENDED USE WITHIN THE OVERALL EQUIPMENT OR SYSTEM.

PERFORMANCE DATA

Performance data given in this document is provided as a guide for the user in determining suitability and does not constitute a warranty. It may represent the result of OMRON's test conditions, and the users must correlate it to actual application requirements. Actual performance is subject to the OMRON Warranty and Limitations of Liability.

CHANGE IN SPECIFICATIONS

Product specifications and accessories may be changed at any time based on improvements and other reasons.

It is our practice to change model numbers when published ratings or features are changed, or when significant construction changes are made. However, some specifications of the product may be changed without any notice. When in doubt, special model numbers may be assigned to fix or establish key specifications for your application on your request. Please consult with your OMRON representative at any time to confirm actual specifications of purchased products.

DIMENSIONS AND WEIGHTS

Dimensions and weights are nominal and are not to be used for manufacturing purposes, even when tolerances are shown.

ERRORS AND OMISSIONS

The information in this document has been carefully checked and is believed to be accurate; however, no responsibility is assumed for clerical, typographical, or proofreading errors, or omissions.

PROGRAMMABLE PRODUCTS

OMRON shall not be responsible for the user's programming of a programmable product, or any consequence thereof.

COPYRIGHT AND COPY PERMISSION

This document shall not be copied for sales or promotions without permission.

This document is protected by copyright and is intended solely for use in conjunction with the product. Please notify us before copying or reproducing this document in any manner, for any other purpose. If copying or transmitting this document to another, please copy or transmit it in its entirety.

ALL DIMENSIONS SHOWN ARE IN MILLIMETERS.

To convert millimeters into inches, multiply by 0.03937. To convert grams into ounces, multiply by 0.03527.

Cat. No. E313-E1-03

In the interest of product improvement, specifications are subject to change without notice.

OMRON Corporation

Industrial Automation Company

Sensing Devices Division H.Q.

Industrial Sensors Division

Shiokoji Horikawa, Shimogyo-ku,

Kyoto, 600-8530 Japan

Tel: (81)75-344-7022/Fax: (81)75-344-7107

1205