

Superminiaturized Basic Switch with Angle-terminal Models

- Miniature size (6.5 x 8.2 x 2.7 mm) and weight as light as 0.3 g contribute to miniaturization of devices.
- PCB mounting and angle terminals for side operation are available.
- Excels in electric characteristics with the snap-action mechanism despite superminiaturized design.
- Gold-plated (Au-P) contacts for micro load switching available in addition to the standard silver-plated contacts (Ag-P).
- Ideal for applications where size and weight requirements are crucial, such as in electronic wristwatches and miniaturized optical and audio equipment.



Ordering Information

■ Model Number Legend:

D2MQ-1 □ - □ - □ - □
1 2 3 4

1. Ratings

1: 0.5 A, 30 VDC: Silver-plated contact type,
 0.05 A, 30 VDC: Gold-plated contact type

2. Actuator

None: Pin plunger
 L: Leaf lever

3. Terminal Direction

None: Straight
 TL: Left
 TR: Right

4. Contact Material

None: Silver-plated copper alloy
 105: Gold-plated copper alloy

D2MQ-4L-□-1-□
1 2 3 4

1. Actuator

4L: Hinge leaf lever

2. Contact Material (Rating)

None: Silver-plated copper alloy (0.5 A, 30 VDC)
 105: Gold-plated copper alloy (0.05 A, 30 VDC)



3. Operating Position

1: 7.1 mm

4. Terminal Direction

None: Straight
 L: Left angle
 R: Right angle

■ List of Models

Actuator	Terminal direction						
	Standard model (Ag-plated)			Microvoltage/ Current load model (Au-plated)	Micro load model (Au-plated)		
	Straight	Left Angle	Right Angle	Straight	Straight	Left Angle	Right Angle
Pin plunger 	D2MQ-1	D2MQ-1-TL	D2MQ-1-TR	D2MQ-1-105	---	---	---
Leaf lever 	D2MQ-1L	D2MQ-1L-TL	D2MQ-1L-TR	D2MQ-1L-105	---	---	---
Hinge leaf lever 	D2MQ-4L-1	D2MQ-4L-1-L	D2MQ-4L-1-R	---	D2MQ-4L-105-1	D2MQ-4L-105-1-L	D2MQ-4L-105-1-R

Note: The terminal profiles shown above are ones viewed from the right side of the Switch.

Specifications

■ Ratings

Item	Standard model	Microvoltage/current load model
Electrical ratings	50 to 500 mA at 30 VDC ($\cos \phi = 1$)	5 to 50 mA at 30 VDC ($\cos \phi = 1$)

Note: The ratings values hold under the following test conditions:

Ambient temperature: 20±2°C

Ambient humidity: 65±5%

Operating frequency: 20 operations/min

■ Characteristics

Operating speed	0.1 mm to 0.5 m/s (see note 1)
Operating frequency	Mechanical: 60 operations/min Electrical: 20 operations/min
Contact resistance	100 mΩ max. (initial value)
Insulation resistance	100 MΩ min. (at 250 VDC)
Dielectric strength	500 VAC, 50/60 Hz for 1 min between terminals at the same polarity 500 VAC, 50/60 Hz for 1 min between current-carrying metal parts and ground
Vibration resistance	Malfunction: 10 to 55 Hz, 1.5-mm double amplitude (see note 2)
Shock resistance	Destruction: 1,000 m/s ² {approx. 100G} max. Malfunction: 300 m/s ² {approx. 30G} max.
Life expectancy	Mechanical: 30,000 operations min. (at full OT value) Electrical: 10,000 operations min. (at full OT value)
Degree of protection	IP00
Degree of protection against electric shock	Class I
Proof tracking index (PTI)	175
Ambient temperature	Operating: -15°C to 70°C (with no icing)
Ambient humidity	Operating: 35% to 85%
Weight	Approx. 0.3 g

Note: 1. The values are for the pin plunger model. (For different models, contact your OMRON representative.)

2. Malfunction: 1 ms max.

■ Contact Specifications

Item		Silver plating	Gold plating
Contact	Specification	Rivet	
	Material	Silver plating	Gold plating
	Gap (standard value)	0.15 mm	
Inrush current	NC	0.5 A max.	0.05 A max.
	NO	0.5 A max.	0.05 A max.

■ Contact Form (SPDT)

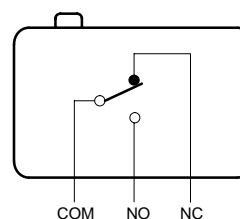

Engineering Data

Mechanical Life Expectancy (D2MQ-1)

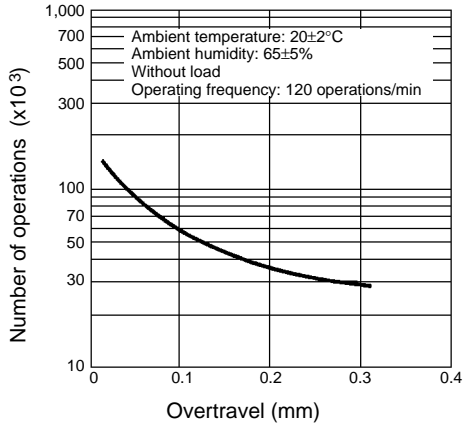

Electrical Life Expectancy (D2MQ-1)

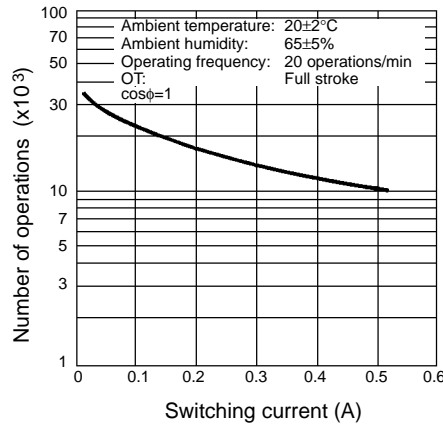

Dimensions

■ Terminals

Straight Terminal

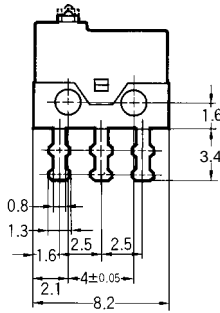

Left-angle Terminal

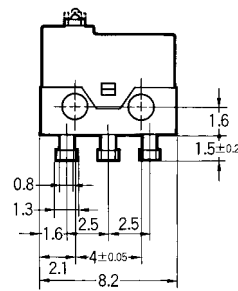

Right-angle Terminal

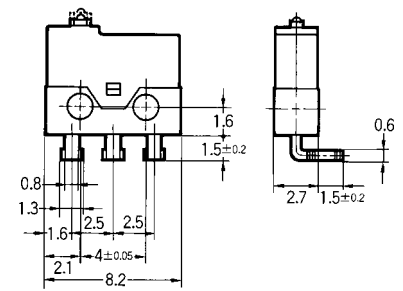

■ Dimensions and Operating Characteristics

- Note:**
- All units are in millimeters unless otherwise indicated.
 - Unless otherwise specified, a tolerance of 0.15 mm applies to all dimensions.
 - The following illustrations are for the straight terminal models. Those for the left-angle terminals and right-angle terminals are different from straight terminal models in terminal size only. Refer to *Terminals* on page 149 for these terminals.

Pin Plunger

- D2MQ-1 (Straight Terminal)
- D2MQ-1-TL (Left Angle)
- D2MQ-1-TR (Right Angle)
- D2MQ-1-105 (Straight Terminal)

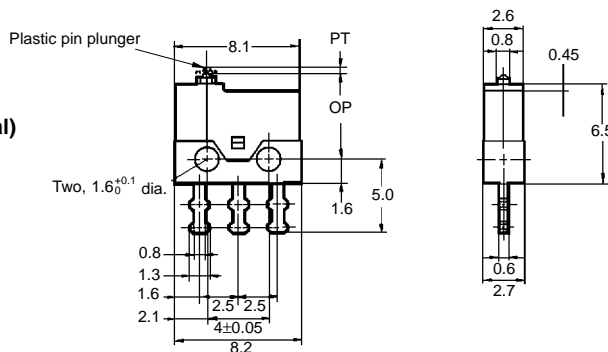
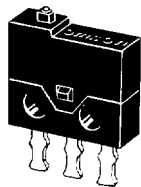

OF max.	1.18 N {120 gf}
RF min.	0.19 N {20 gf}
PT max.	0.4 mm
OT min.	0.1 mm
MD max.	0.1 mm
OP	5.7 ± 0.2 mm

Leaf Lever

- D2MQ-1L (Straight Terminal)
- D2MQ-1L-TL (Left Angle)
- D2MQ-1L-TR (Right Angle)
- D2MQ-1L-105 (Straight Terminal)

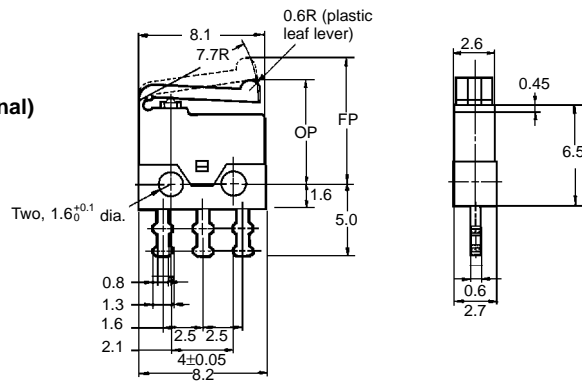
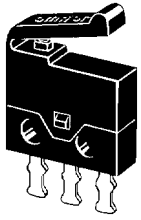

OF max.	0.59 N {60 gf}
RF min.	0.08 N {8 gf}
PT max.	2.4 mm
OT min.	0.3 mm
MD max.	0.7 mm
FP max.	9.6 mm
OP	6.7±0.5 mm

Hinge Leaf Lever

- D2MQ-4L-1 D2MQ-4L-105-1
- D2MQ-4L-1-L D2MQ-4L-105-1-L
- D2MQ-4L-1-R D2MQ-4L-105-1-R

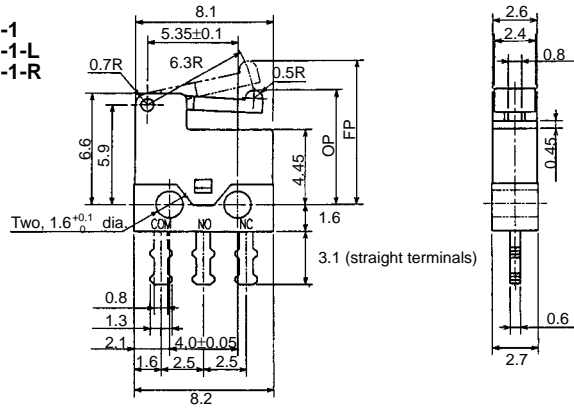
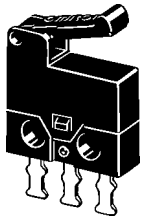

OF max.	0.39 N {40 gf}
RF min.	0.04 N {4 gf}
PT max.	2.1 mm
OT min.	0.3 mm
MD max.	0.7 mm
FP max.	8.7 mm
OP	7.1±0.5 mm

Precautions

■ Cautions

Mounting Dimensions

Use M1.4 mounting screws with screws to mount the Switch. Tighten the screws to a torque of $0.1 \text{ N} \cdot \text{m}$ ($1 \text{ kgf} \cdot \text{cm}$).

Mounting Holes

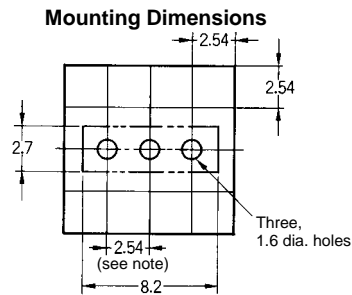
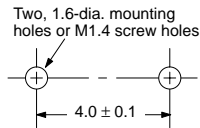

Note: Terminal gap: 1 pitch

Terminal Connections

When soldering a lead wire to a terminal of the D2MQ, use a soldering iron with a maximum capacity of 15 W maximum (iron tip temperature: 250° max.) with the actuator at the free position and do not take more than 3 s to solder the lead wire, otherwise the characteristics of the Switch may change.

Applying a soldering iron for too long a time or using one that is rated at more than 15 W may degrade the Switch characteristics.

■ Correct Use

Refer to pages 22 to 29 for common precautions.

Operation

Do not apply a force more than two times the rated operating force to the actuator and leaf lever.

Make sure that the actuator is not hindered by any object from moving to or beyond the rated overtravel.

Do not change the operating position by modifying the actuator.

Do not use the Switch in an application where the operating speed is extremely slow or the actuator is set in the midpoint between the free position and operating position.

Install the pin plunger switch so that the operating force is applied in alignment with the stroke of the actuator.

Do not apply a shock to the actuator, otherwise, the Switch may be damaged.

Do not apply excessive force to the actuator of the Leaf Lever Switch in the operating, releasing, and horizontal directions.

Separator

When mounting the Switch on a metallic surface, be sure to provide a Separator between the Switch and mounting plate.

The Separator must be made of hard material and must be processed as shown below.

Dimensions of Separator

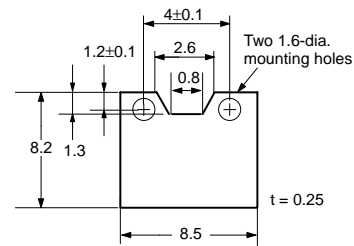

ALL DIMENSIONS SHOWN ARE IN MILLIMETERS.

To convert millimeters into inches, multiply by 0.03937. To convert grams into ounces, multiply by 0.03527.