

Safety-door Switch

D4GS

Slim Safety-door Switches with IP67 Rating

- The slim safety-door switches are of three-terminal contact construction.
- Reversible design allowing either front or rear mounting.
- Built-in switches with two- or three-terminal contact construction are available.
- Operation key with rubber mounting hole to absorb vibration and shock.

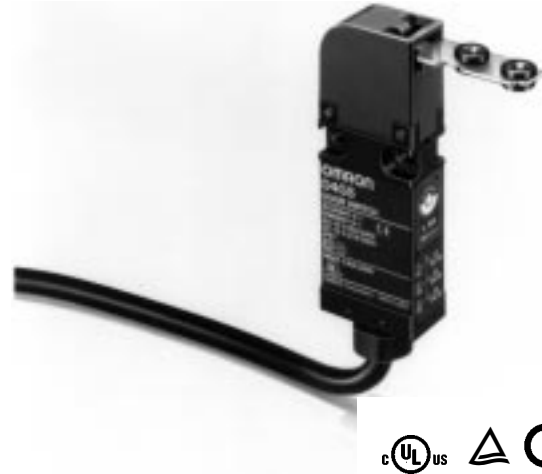

■ Features

Slim Safety-door Switches with 3-terminal Contact Construction

Thin and 1/2 the size as OMRON's previous models.

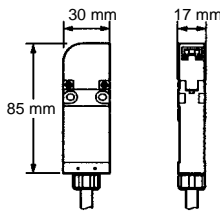

Reversible Construction

Front and rear mounting are both possible.

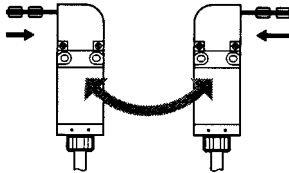

Built-in Switches

Two- and three-terminal contact models are available.

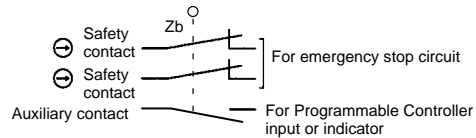

Note: The safety contacts are positive-opening contacts approved by EN and each of them is indicated with the mark

Key Mounting Hole

The key mounting hole is designed with rubber to absorb vibration and shock.

IP67 Enclosure Rating

(Applicable to Main Body Only; Operation Key Insertion Face Meets IP00.)

The D4GS uses rust-resistant materials and incorporates a drain opening as effective countermeasures against problems caused by water.

Note: IP67 is based on the test method specified in EN60947-5-1. Be sure to confirm in advance the sealing performance under the actual operating environment and conditions.

Safety Standards

Meeting EN (TÜV) Standards and CE marking requirements along with a variety of international standard requirements, such as UL and CSA requirements. All NC contacts satisfy requirements for the positive opening mechanism.

■ International Standards and EC Directives

Approved EC Directives and Standards

- Machine Directives
- LVD (Low-voltage Directives)
- EN1088
- EN60204-1

Approved Standards

Agency	Standard	File No.
TÜV Rheinland	EN60947-5-1 (Positive opening mechanism)	J9950579-1
UL (see note)	UL508 CSA C22.2 No. 14	E76675
BIA	GS-ET-15	Pending



Note: Approval has been obtained for CSA C22.2 No. 14 under UL.

Ordering Information

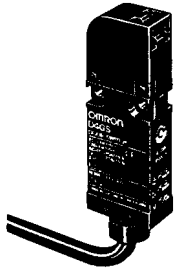
Switches

Appearance	Cable length	1NC/1NO (Slow-action)	2NC (Slow-action)	2NC/1NO (Slow-action)	3NC (Slow-action)
	1 m	D4GS-1	D4GS-2	D4GS-3	D4GS-4

Operation Keys (Sold Separately)

Type	Model
Horizontal mounting 	D4GS-K1
Vertical mounting 	D4GS-K2

Specifications

Contact Specifications

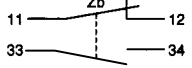
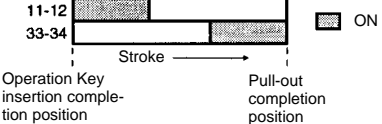
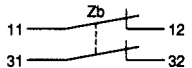
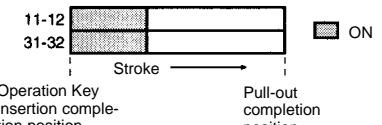
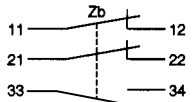
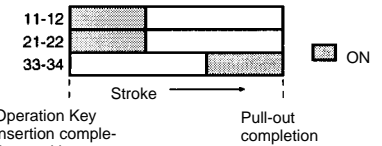
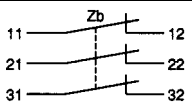
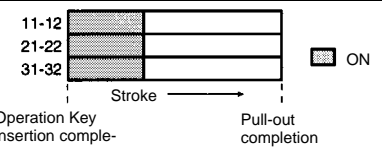
Model	Contact	Contact form	Diagram	Remarks
D4GS-1	1NC/1NO			Only terminals 11-12 have an positive opening mechanism. (→) The terminals 11-12 and 33-34 can be used as opposing poles.
D4GS-2	2NC			Only terminals 11-12 and 31-32 have an positive opening mechanism. (→) The terminals 11-12 and 31-32 can be used as opposing poles.
D4GS-3	2NC/1NO			Only terminals 11-12 and 21-22 have an positive opening mechanism. (→) The terminals 11-12, 21-22 and 33-34 can be used as opposing poles.
D4GS-4	3NC			Only terminals 11-12, 21-22 and 31-32 have an positive opening mechanism. (→) The terminals 11-12, 21-22 and 31-32 can be used as opposing poles.

■ Approved Standards

TÜV (EN60947-5-1)

Item	AC-15	DC-13
Rated operating current (I_e)	0.75 A	0.27 A
Rated operating voltage (U_e)	240 V	250 V

Note: Use a 10-A fuse type gI or gG that conforms to IEC60269 as a short-circuit protection device.

UL/CSA (UL508, CSA C22.2 No. 14)

C300

Rated voltage	Carry current	Current (A)		Voltage (VA)	
		Make	Break	Make	Break
120 VAC	2.5A	15	1.5	1,800	180
240 VAC		7.5	0.75		

Q300

Rated voltage	Carry current	Current (A)		Voltage (VA)	
		Make	Break	Make	Break
125 VDC	2.5A	0.55	0.55	69	69
250 VDC		0.27	0.27		

■ Characteristics

Degree of protection (see note 1)	Body: IP67 (EN60947-5-1) (Operation key insertion face: IP00)
Life expectancy (see note 2)	Mechanical: 1,000,000 times min. Electrical: 100,000 times min. (1-A resistive load at 125 VAC) (see note 3)
Operating speed	0.1 to 0.5 m/s
Contact gap	2 × 2 mm min.
Operating frequency	30 operations/minute
Positive opening force (see note 4)	60 N min.
Positive opening travel (see note 4)	10 mm min.
Insulation resistance	100 MΩ min. (at 500 VDC) between terminals of the same polarities, between terminals of different polarities, and between each terminal and non-current carrying metal parts
Contact resistance	300 mΩ max. (Initial value with 1-m cable)
Dielectric strength	Between terminals of same polarities: Uimp 2.5 kV (EN60947-5-1) Between terminals of different polarities: Uimp 4 kV (EN60947-5-1) Between each terminal and non-current carrying metal parts: Uimp 6 kV (EN60947-5-1)
Conditional short-circuit current	100 A (EN60947-5-1)
Pollution degree (operating environment)	3 (EN60947-5-1)
Conventional free air thermal current (I_{th})	2.5 A (EN60947-5-1)
Protection against electric shock	Class II (double insulation) (IEC60536)
Vibration resistance	Malfunction: 10 to 55 Hz, 0.35-mm single amplitude
Shock resistance	Malfunction: 300 m/s ² {30G} min.
Ambient temperature	Operating: -30°C to 70°C (with no icing)
Ambient humidity	Operating: 95% max.
Cable	1 m (UL2464 No. 22 AWG, finishing O.D.: 7.2 mm)
Weight	Approx. 120 g (D4GS-1, with 1-m cable)

Note: 1. The degree of protection shown above is based on the test method specified in EN60947-5-1. Be sure to confirm in advance the sealing performance under the actual operating environment and conditions.

Although the switch box is protected from dust or water penetration, do not use the D4GS in places where foreign material may penetrate through the key hole on the head, otherwise switch damage or malfunctioning may occur.

2. The above mechanical or electrical life is ensured at an ambient temperature of 5°C to 35°C and an ambient humidity of 40% to 70%.
3. When the ambient temperature is 35°C or higher, do not apply 1 A at 125 VAC to more than one circuit.
4. These values must be satisfied to ensure safe operation.

Dimensions

- Note:** 1. All units are in millimeters unless otherwise indicated.
 2. Each dimension has a tolerance of 0.4 mm unless otherwise specified.

Switches

D4GS-□

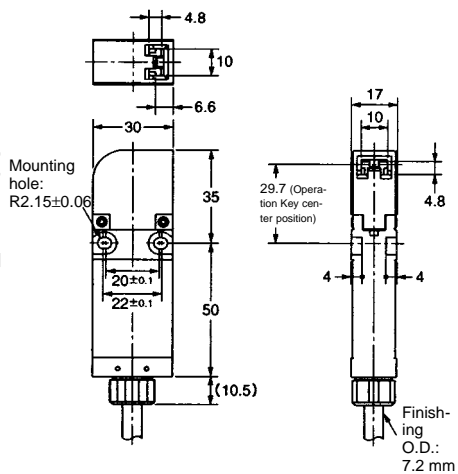

Operating characteristics	Model
Key insertion force	15 N max.
Key extraction force	30 N max.
Movement before being locked	22 mm min.
Positive opening force	60 N min.
Positive opening stroke	10 mm min.

Operation Keys

D4GS-K1

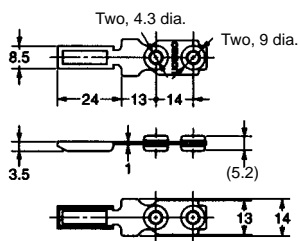

D4GS-K2

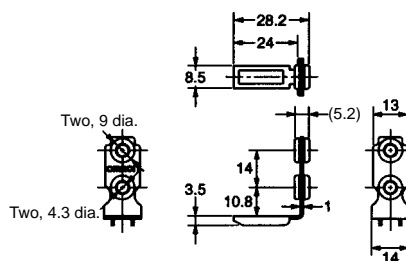

Operation Key Inserted

D4GS-□ + D4GS-K1

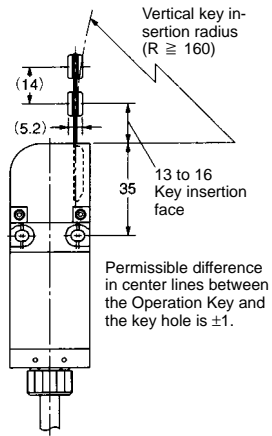
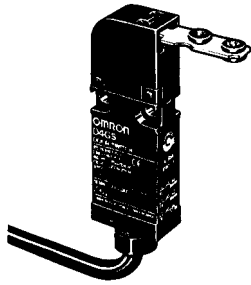

(When Operation Key is inserted from the top)

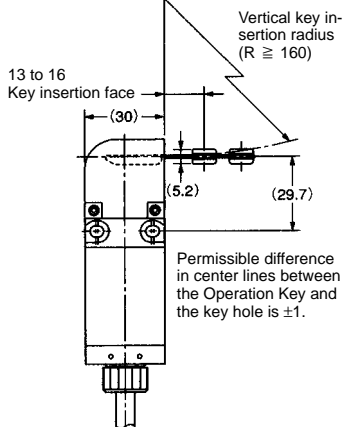
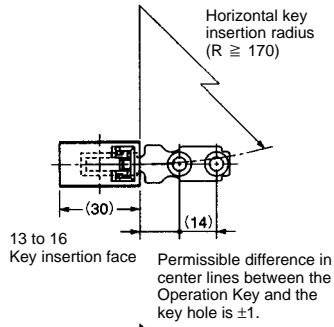

(When Operation Key is inserted from the right side)

D4GS-□ + D4GS-K2

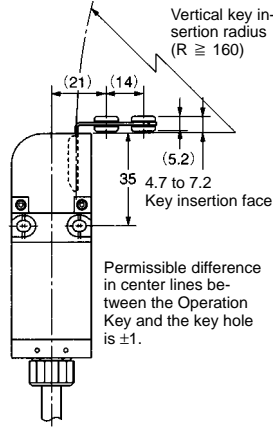
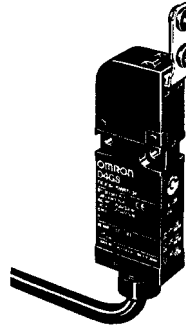

(When Operation Key is inserted from the top)

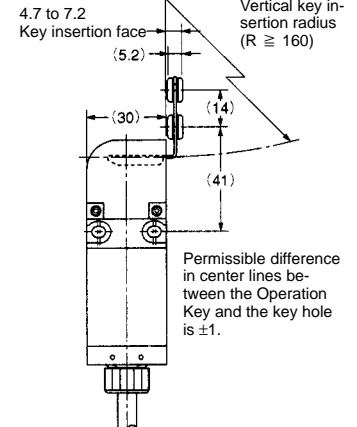
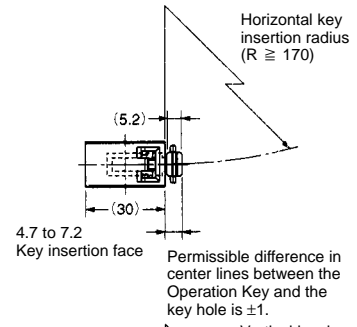

(When Operation Key is inserted from the right side)

Note: Dimensions in parentheses are reference values.

Precautions



WARNING

Do not insert the operation key to the switch with the door open. Machine may start operating and injury may be caused.

NOTICE

1. Mount the Operation Key at a location where it will not come in contact with users when the door is opened or closed.
2. When operating the Switch as a part of a safety circuit or an emergency stop circuit to prevent injury, operate the NC contacts that have a positive-opening mechanism in positive mode. For safety purposes, tighten the switch body and Operation Key with one-way screws or equivalents or install a switch protection cover and warning label for safety purposes to prevent easy removal of the Switch.
3. Connect the fuse to the Switch in series to prevent it from short-circuit damage. The value of the breaking current of the fuse must be calculated by multiplying rated current by 150% to 200%. When using the Switch with EN ratings, use 10-A fuse Type gI or gG that complies with IEC60269.
4. Do not supply electric power when wiring.
5. Do not use the Switch where explosive gas, flammable gas, or any other dangerous gas may be present.
6. Keep the electrical load below the rated value.
7. Never wire to a wrong terminal.
8. Be sure to evaluate the Switch under actual working conditions after installation.
9. Do not drop the Switch. Excessive shock or vibration can cause malfunction or damage to Switch characteristics. Do not disassemble the internal switch, there are no user-serviceable parts inside.
10. Do not use the Switch as a stopper. When mounting the Switch, be sure to locate a stopper as shown in the following illustration to prevent the top of the Operation Key from hitting the switch head.

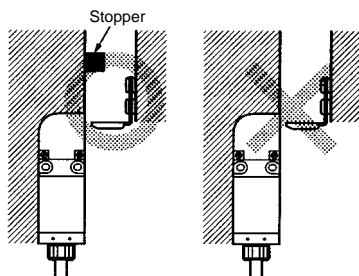

11. A cable is fixed with sealing materials on the bottom of the Switch. When excessive force may be imposed on the cable, fix the cable with a fixing unit at the distance of 5 cm from the bottom of the Switch as shown. When bending the cable, secure the cable with more than 45-mm bending radius so as not to cause damage to the insulator or sheath of the cable. Do not fasten or loosen the conduit at the bottom of the Switch. When wiring, be sure not to allow a liquid such as water or oil into the tip of cable.

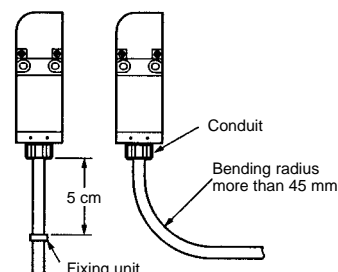

Operating Environment

Do not use the D4GS in the following locations:

- Locations with severe changes in temperature
- Locations with excessive humidity that may cause condensation
- Locations with excessive vibration
- Locations where metal dust, oil, or chemical may be sprayed onto the D4GS

Life Expectancy

The life of the D4GS will vary with the switching conditions. Before applying the D4GS, test the D4GS under actual operating conditions and be sure to use the D4GS in actual operation within switching times that will not lower the performance of the D4GS.

Mounting

Mounting hole dimensions for mounting the main body are as shown below.

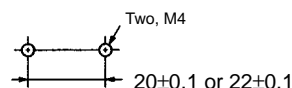

Tightening Torque

Be sure to tighten each screw of the D4GS properly, otherwise the D4GS may malfunction.

Type	Proper tightening torque	Size
Body mounting screw	0.75 to 1.15 N • m	M4 screw
Operation Key mounting screw	0.75 to 1.15 N • m	M4 screw

Operation Key Mounting Holes

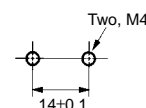

Operation Key

Be sure to use the dedicated Operation Key only.
 Do not operate the D4GS with anything other than the dedicated Operation Key. Otherwise, the Switch may be damaged.
 As shown below, mount the Operation Key after matching the concave surface of the Operation Key with the convex surface of the insertion face.

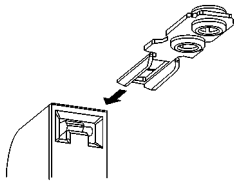

The position deviation between the center of Operation Key and insertion face must be within ± 1 mm.

Do not impose excessive force on the Operation Key inserted into the D4GS or drop the D4GS with the Operation Key inserted. Doing so may deform or damage the Operation Key.

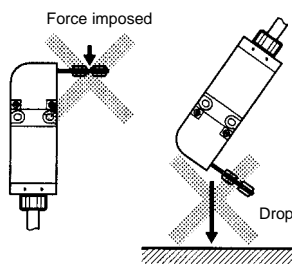

Securing the Door

When the door is closed (with the Operation Key inserted), the door (or the Operation Key) may be pushed back across the set zone due to the door's weight, the door cushion rubber, or other factor. If a load is applied to the Operation Key, the door may fail to unlock. Secure the door with hooks so that it will stay within in the set zone.

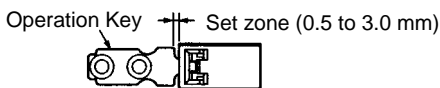

Wiring

Identifying Wires

Identify wires according to the color (with or without white lines) of the insulation on the wire.

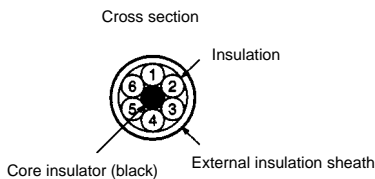

Wire Colors

No.	Color of insulation	No.	Color of insulation
1	Blue/white	4	Orange
2	Brown/white	5	Brown
3	Orange/white	6	Blue

Note: "Blue/white, brown/white, or orange/white" means that the cover is blue, brown, or orange with a white line.

Terminal Numbers

Identify terminal numbers based on the color of the insulation on the wire.
 The safety and auxiliary contacts of D4GS models of three-terminal contact construction and those of two-terminal contact construction are described below.
 The auxiliary contacts (orange) can be used as safety contacts.
 The safety contacts are positive-opening contacts approved by EN and each of them is indicated with the mark \ominus .

<3NC>

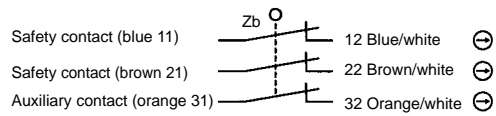

<2NC/1NO>

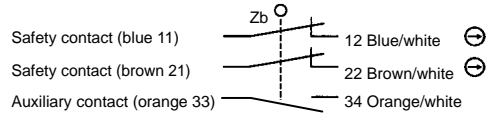

<2NC>

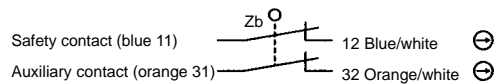

<1NC/1NO>

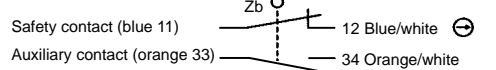

Cut the black core insulator and all unused wires at the end of the external insulation sheath when wiring the cable.

SI Units

To conform to the international standards, this datasheet adopts the SI international system for units (SI: Systeme International d'Unites). Refer to the following tables to convert values indicated in conventional units.

SI Unit Conversion

(Shaded units are non-SI units.)

Acceleration	m/s ²	G
	1	1.01972×10^{-1}
	9.80665	1

Force	N	kgf
	1	1.01972×10^{-1}
	9.80665	1

Torque	N•m	kgf•cm	kgf•m
	1	1.01972×10	1.01972×10^{-1}
	9.80665×10^2	1	1×10^{-2}
	9.80665	1×10^2	1

Pressure	Pa	kPa	kgf/cm ²	mmHg (Torr)	mmH ₂ O
	1	1×10^{-3}	1.01972×10^{-5}	7.50062×10^{-3}	1.01972×10^{-1}
	1×10^3	1	1.01972×10^{-2}	7.50062	1.01972×10^2
	9.80665×10^4	9.80665×10	1	7.35559×10^2	1×10^4
	1.33322×10^2	1.33322×10^{-1}	1.35951×10^{-3}	1	1.35951×10

ALL DIMENSIONS SHOWN ARE IN MILLIMETERS.

To convert millimeters into inches, multiply by 0.03937. To convert grams into ounces, multiply by 0.03527.

Cat. No. C111-E1-1 **In the interest of product improvement, specifications are subject to change without notice.**

OMRON Corporation

Industrial Automation Company

Industrial Control Components Division
28th Fl., Crystal Tower Bldg.,
1-2-27, Shiromi, Chuo-ku,
Osaka 540-6028 Japan
Phone: (81)6-6949-6025 Fax: (81)6-6949-6029

Printed in Japan
0799-2M (0799)