

Emergency Stop Switch

A22E

Install in 22-dia. or 25-dia. Panel Cutout

- Positive opening mechanism with minimum contact separation of 3 mm in accordance with EN60947-5-1, (→).
- Safety Lock Mechanism prevents misuse. (No tampering – in accordance with EN 418)
- Easy mounting and removal of Switch Unit using an incorporated lever.
- Increase wiring efficiency with three-row mounting for the Switch Unit.
- Finger protection mechanism on Switch Unit provided as a standard feature.
- Install using either round, forked crimp terminals, or ferrules.

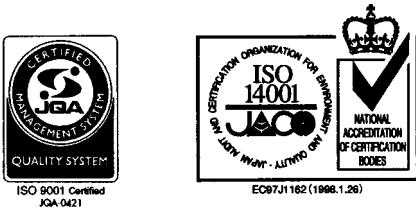

This product was manufactured at OMRON Izumo. OMRON Izumo has obtained approvals from international certification bodies for its quality system and environmental control system.

Ordering Information

■ Construction

Switch Unit

Non-lighted Models

Lighted Models

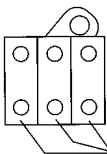

Contact Blocks

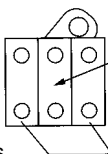

Lamp Socket

Contact Blocks

SPST-NC, SPST-NO/SPST-NC, DPST-NC

Note: For non-lighted models, up to three Switch Units can be mounted. When adding other contacts such as SPST-NO/DPST-NC, order Switch Units separately.

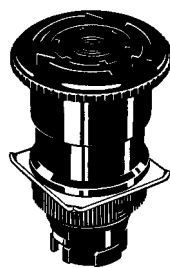

Operational Unit

Push-lock Turn-reset System

Available Color: Red

Non-lighted

Lighted



Lamp

• **Light source**

LED Lamp

Incandescent Lamp

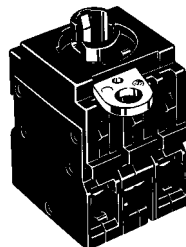

• **Contact Ratings**

110 VAC, 10 A (resistive load)

24 VDC, 10 A (resistive load)

• **Lighting Method**

Non-lighted

Lighted (Without transformer)

Lighted (With transformer)

(The above figures are examples of the lighted model.)

Refer to the pages 48 to 64 for specifications, accessories, installation, and precautions.

Safety Lock Mechanism to Prevent Misuse

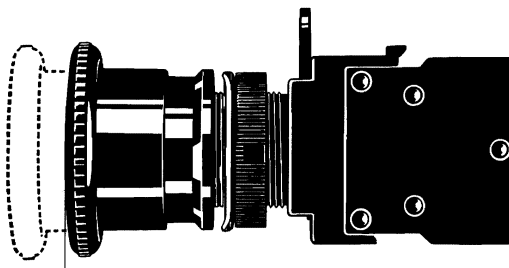

Lock position

This Switch can be intentionally used to stop equipment in an emergency. Even if an object or person touches the Pushbutton by mistake, the contact will not be released unless the Pushbutton reaches the lock position.

Contacts are arranged in a row to provide more space depthwise for multi-contact applications.

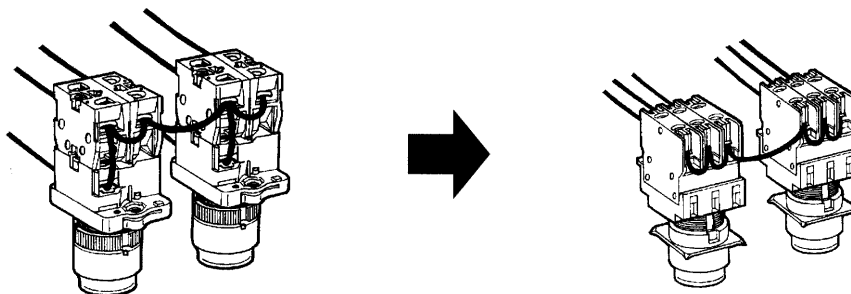

DPST-NO monoblock and DPST-NC monoblock models are available as options. See page 51. (With non-lighted models, combination with 4PST-NC/DPST-NC or 6PST-NC is possible.)

This Switch uses a finger protection mechanism to prevent electrical shocks. Moreover, it is provided with a mechanism to prevent terminal screws from coming off and also allows connection to either round or forked crimp terminals.

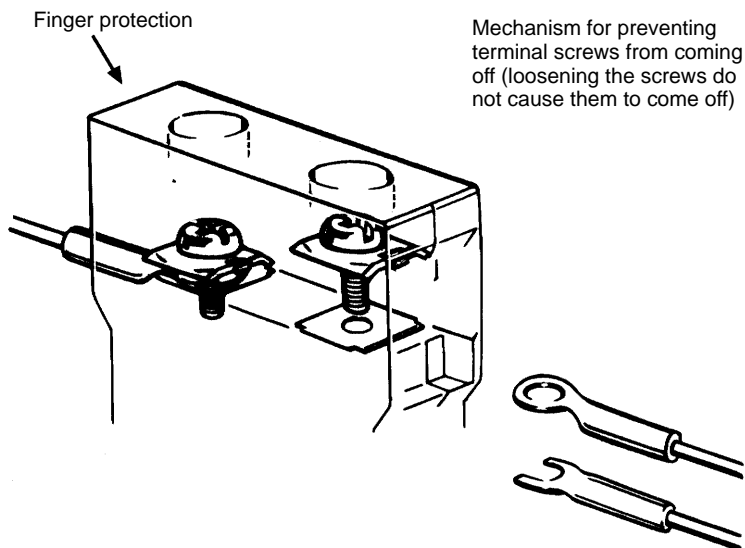

■ Model Number Legend (Completely Assembled)

Shipped as a set which includes the Operational Unit and Switch Unit.

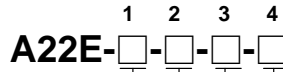

1 Lighted/Non-lighted

Code	Description
None	Non-lighted
L	Lighted (see note)

Note: Lighted Emergency Stop Switches are available only for the 40-dia. push-lock turn-reset models.

2 Head Size

Code	Description	
MP	40 dia.	Push-pull
LP	60 dia.	
S	30 dia.	Push-lock, turn-reset
M	40 dia.	
L	60 dia.	
SK	30 dia.	
MK	40 dia.	Push-lock key reset

3 Light Source

Without Transformer		
Code	Operating Voltage	
None	Non-lighted	
6D	LED	6 VDC
6A		6 VAC
12A		12 VAC/DC
24A		24 VAC/DC
With Transformer		
None	Non-lighted	
T1	LED	110 VAC*1
T2		220 VAC*2

Note: The LED lamp (24 VAC/DC) can be lit by directly applying 110 VAC/DC (220 VAC/DC) to the lamp terminal. LED incorporates the 24-VAC/DC type.

*1) Operational voltage: 95 to 110 VAC







*2) Operational voltage: 190 to 230 VAC

4 Contacts

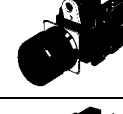
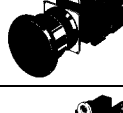

Code	Description
01	SPST-NC
11	SPST-NO + SPST-NC
02	DPST-NC

■ Emergency Stop Switch (Completely Assembled)

Non-lighted Models

Appearance	Output	Push-lock turn-reset system	Color of cap
40-dia. head Push-pull  A22E-MP	SPST-NC	A22E-MP-01	Red
	SPST-NO/SPST-NC	A22E-MP-11	
	DPST-NC	A22E-MP-02	
60-dia. head Push-pull  A22E-LP	SPST-NC	A22E-LP-01	
	SPST-NO/SPST-NC	A22E-LP-11	
	DPST-NC	A22E-LP-02	
30-dia. head Push-lock Turn-reset  A22E-S	SPST-NC	A22E-S-01	
	SPST-NO/SPST-NC	A22E-S-11	
	DPST-NC	A22E-S-02	
40-dia. head Push-lock Turn-reset  A22E-M	SPST-NC	A22E-M-01	
	SPST-NO/SPST-NC	A22E-M-11	
	DPST-NC	A22E-M-02	
60-dia. head Push-lock Turn-reset  A22E-L	SPST-NC	A22E-L-01	
	SPST-NO/SPST-NC	A22E-L-11	
	DPST-NC	A22E-L-02	
30-dia. head Push-lock Key-reset  A22E-SK	SPST-NC	A22E-SK-01	
	SPST-NO/SPST-NC	A22E-SK-11	
	DPST-NC	A22E-SK-02	
40-dia. head Push-lock Key-reset  A22E-MK	SPST-NC	A22E-MK-01	
	SPST-NO/SPST-NC	A22E-MK-11	
	DPST-NC	A22E-MK-02	

Lighted Models

Appearance	Output	Lighting	Rated voltage	Push-lock turn-reset system	Color of cap
40-dia. head Push-lock Turn-reset 	SPST-NC	LED	6 VDC	A22EL-M-6D-01	Red
			6 VAC/DC	A22EL-M-6A-01	
			12 VAC/DC	A22EL-M-12A-01	
			24 VAC/DC	A22EL-M-24A-01	
	SPST-NO/SPST-NC		6 VDC	A22EL-M-6D-11	
			6 VAC/DC	A22EL-M-6A-11	
			12 VAC/DC	A22EL-M-12A-11	
			24 VAC/DC	A22EL-M-24A-11	
	DPST-NC		6 VDC	A22EL-M-6D-02	
			6 VAC/DC	A22EL-M-6A-02	
			12 VAC/DC	A22EL-M-12A-02	
			24 VAC/DC	A22EL-M-24A-02	
40-dia. head Push-lock Turn-reset with transformer 	SPST-NC	110 VAC	A22EL-M-T1-01		
	SPST-NO/SPST-NC	220 VAC	A22EL-M-T2-01		
		110 VAC	A22EL-M-T1-11		
	DPST-NC	220 VAC	A22EL-M-T2-11		
		110 VAC	A22EL-M-T1-02		
		220 VAC	A22EL-M-T2-02		

■ Model Number Legend (Subassembly)

The Operational Unit, Lamp, or Switch Unit can be ordered separately. Use them in combination for models that are not available as assembled units. These can also be used as inventory for maintenance parts.

Unit Combinations

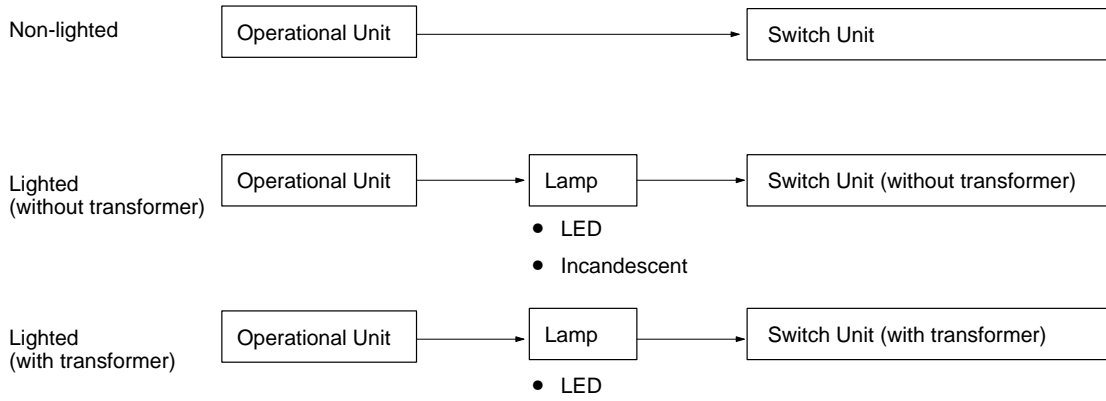

1. Operational Unit
Lighted/Non-lighted

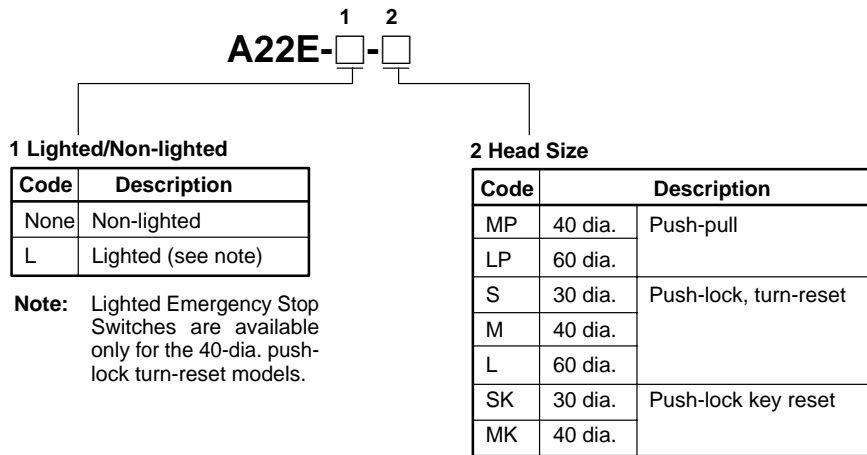

2. Lamp

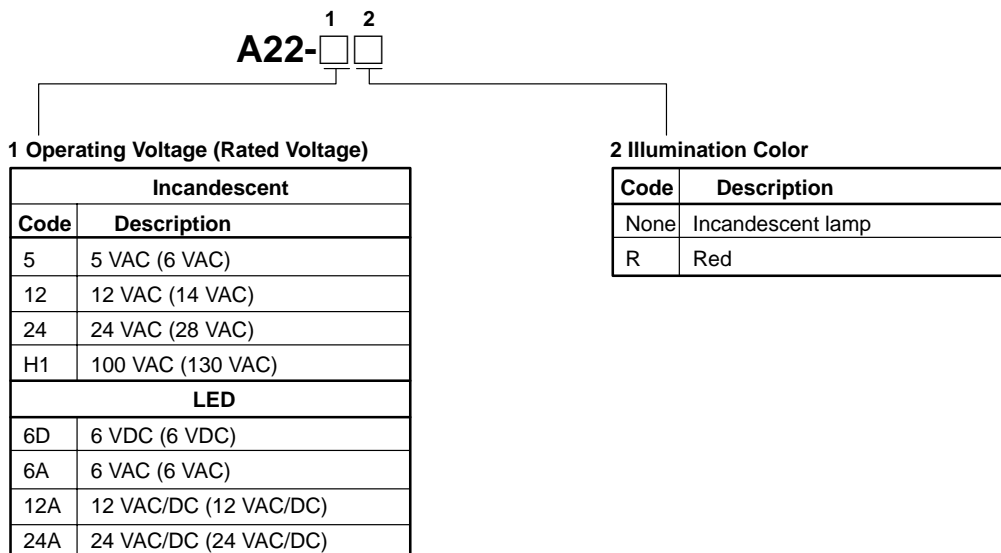



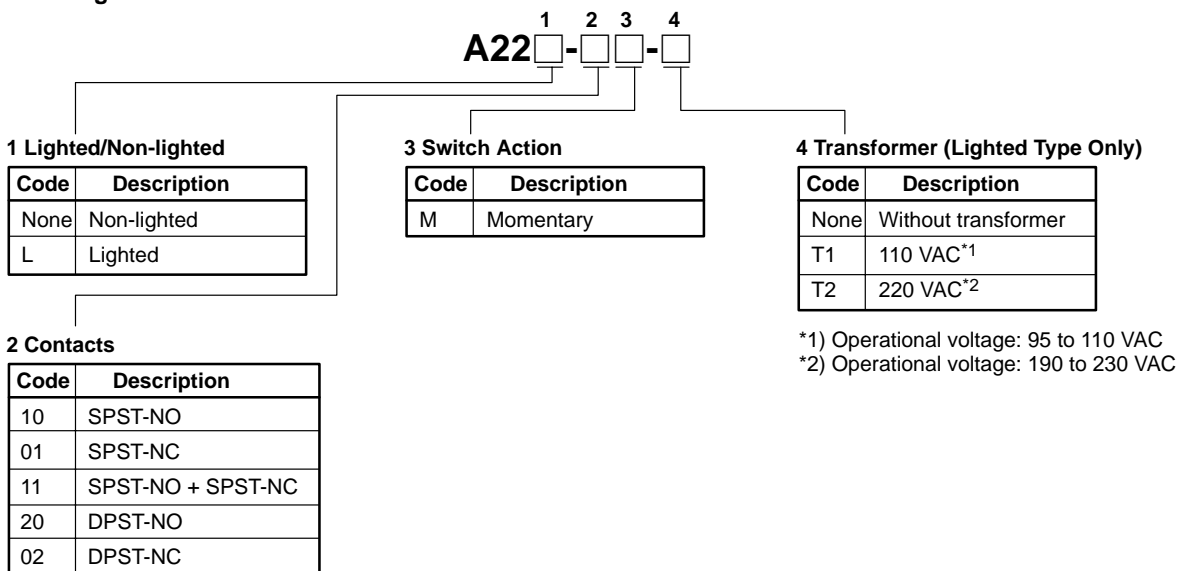

3. Switch Unit
Lighted/Non-lighted



■ Emergency Stop Switch (Subassembly)

Operational Units

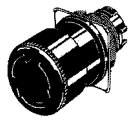
Non-lighted

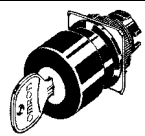
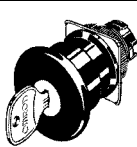
Sealing capability and size	IP65 oil-resistant models		
	Small (30 dia.)	Medium (40 dia.)	Large (60 dia.)
Push-pull	---	A22E-MP 	A22E-LP 
Push-lock, Turn-reset	A22E-S 	A22E-M 	A22E-L 
Push-lock, Key-reset	A22E-SK 	A22E-MK 	---

Lighted

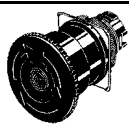
Sealing capability and size	IP65
	Medium (40 dia.)
Push-lock, Turn-reset	A22EL-M 

■ Lamp

LED

Rated voltage	6 VDC	6 VAC	12 VAC/DC	24 VAC/DC
 LED light				
Red	A22-6DR	A22-6AR	A22-12AR	A22-24AR

Note: For transformer lighting, use the A22-24AR.

Incandescent

Rated voltage	5 VAC	14 VAC	28 VAC	130 VAC
	A22-5	A22-12	A22-24	A22-H1

Switch Unit (General-purpose Load)

Non-lighted

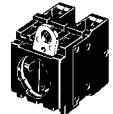
Switch Action	Contacts	Model
	SPST-NO	A22-10M
	SPST-NC	A22-01M
	SPST-NO + SPST-NC	A22-11M
	DPST-NO	A22-20M
	DPST-NC	A22-02M

Lighted

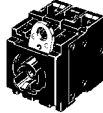
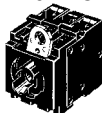
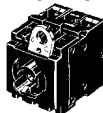
Switch Action	Contacts	Transformer circuits		
		Without transformer	With transformer	
			110 VAC 	220 VAC 
Momentary	SPST-NO	A22L-10M	A22L-10M-T1	A22L-10M-T2
	SPST-NC	A22L-01M	A22L-01M-T1	A22L-01M-T2
	SPST-NO + SPST-NC	A22L-11M	A22L-11M-T1	A22L-11M-T2
	DPST-NO	A22L-20M	A22L-20M-T1	A22L-20M-T2
	DPST-NC	A22L-02M	A22L-02M-T1	A22L-02M-T2

Note: The above illustrations are for the DPST-NO contact.

Dimensions

Note: All units are in millimeters unless otherwise indicated.

■ Non-lighted Models

**40-dia. Push-pull
A22E-MP**

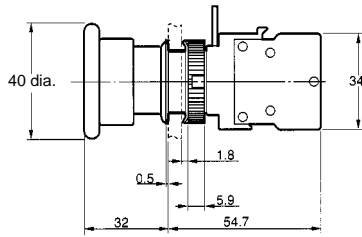
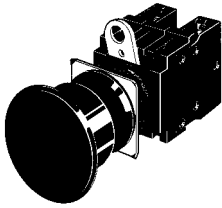

**60-dia Push-pull
A22E-LP**

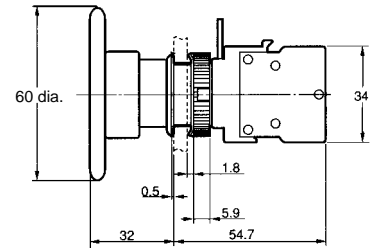
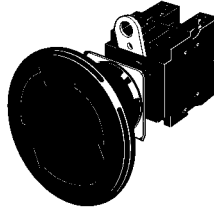

**30-dia. Push-lock, Turn-reset
A22E-S**

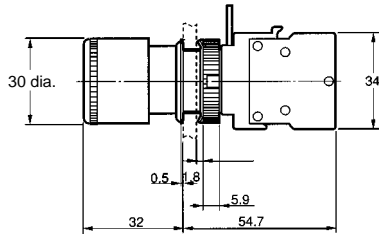
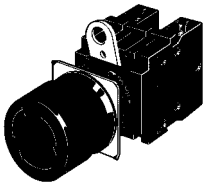

**40-dia. Push-lock, Turn-reset
A22E-M**

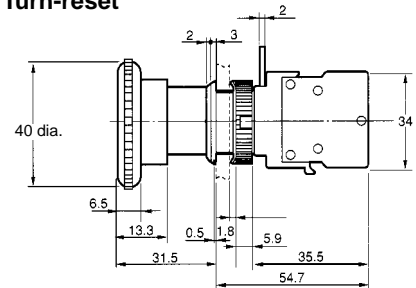
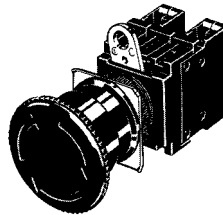

**60-dia. Push-lock, Turn-reset
A22E-L**

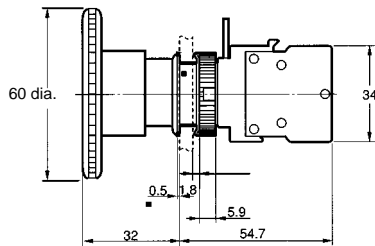
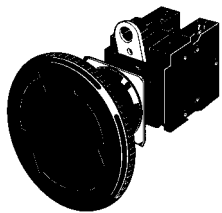

**30-dia. Push-lock, Key-reset
A22E-SK**

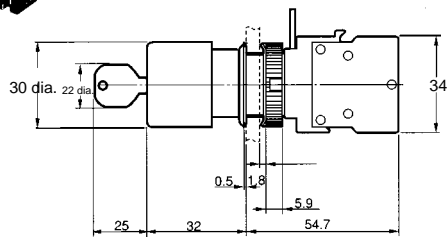
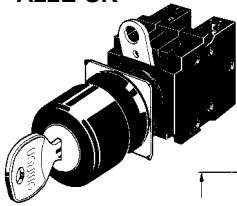

**40-dia. Push-lock, Key-reset
A22E-MK**

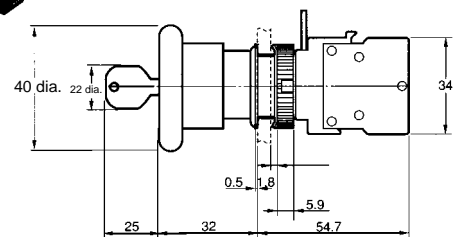
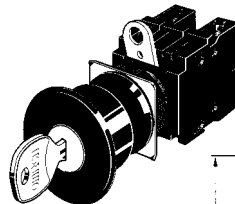

■ Lighted Model

40-dia. Push-lock, Turn-reset
A22EL-M

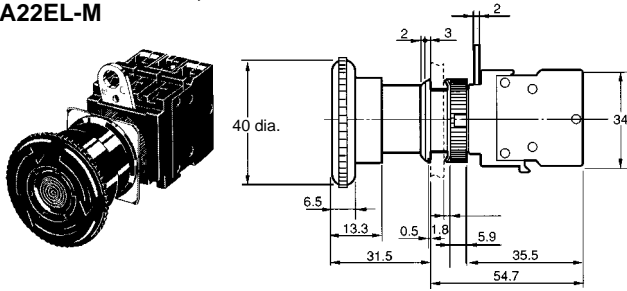

■ Terminal Arrangement

Terminal Arrangement (Bottom View)

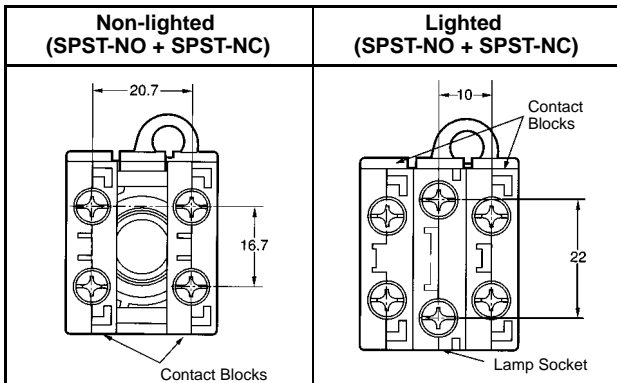

Panel Cutout Dimensions

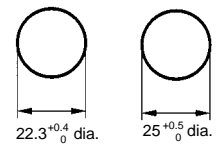

Note: When applying coating such as paint to the panel, the dimensions should be those after the application of coating. Lock fitting is provided as a standard item.

Terminal Connection

Type	Terminal connection
Non-lighted	<p>Bottom view</p>
Lighted without transformer	<p>Bottom view</p>
Lighted with transformer	<p>Bottom view</p>

Note: The above terminal connection diagrams are examples for SPST-NO + SPST-NC.

ALL DIMENSIONS SHOWN ARE IN MILLIMETERS.

To convert millimeters into inches, multiply by 0.03937. To convert grams into ounces, multiply by 0.03527.