

Knob-type Selector Switch

A165S / W

Mounting Aperture of 16 mm

- Modular construction
- Oil-resistant IP65 models
- UL and CSA approved, VDE pending
- Conforms to EN60947-5-1, IEC947-5-1
- Short mounting depth, less than 28.5 mm below panel
- Wide range of switching capacity from general to microload
- Lighted and non-lighted models
- 2 and 3-notch models
- Manual and automatic reset models



Ordering Information

■ Construction

Flange Shape

Protective Structure and Terminal Type

- **Protective Structure**
Oil-resistant IP65
- **Terminal Type**
Solder terminals
(tab terminals #110)

Lamp

- LED
- Neon lamp

Available Colors

- For LED
Red, green, yellow

Number of Notches and Reset Method

- **2 Notches**
Manual reset
Automatic reset
- **3 Notches**
Manual reset
Automatic reset

Switch Unit Specifications

- **General-purpose Loads**
125 VAC: 5 A
250 VAC: 3 A
30 VDC 3 A
Minimum applicable load: 1 mA at 5 VDC

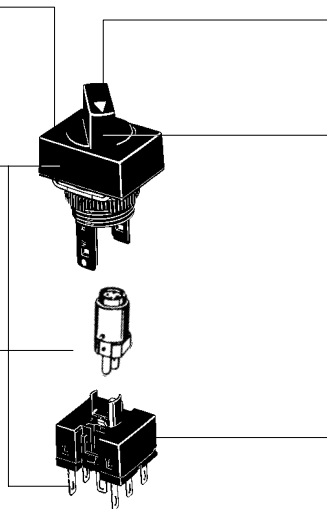

■ Model Number Legend

1. Selector

A165□-□□□□
 1 2 3 4

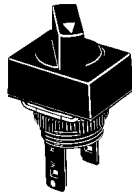

1. Lighted/Non-lighted

S: Non-lighted
 W: Lighted

2. Flange Shape

J: Rectangular
 A: Square
 T: Round

3. Number of Notches/Reset Method

2M: 2 notches/Latching
 2A: 2 notches/Momentary
 3M: 3 notches/Latching
 3A: 3 notches/Momentary/Latching

4. Illumination Color

None: Non-lighted
 R: Red
 G: Green
 Y: Yellow

2. Switch (Common Use with Key-type Selector Switch)

A16S-□□□□-□
 1 2 3 4 5

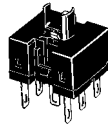

1. Number of Notches

2N: 2 notches
 3N: 3 notches

2. Contacts

1: SPDT
 2: DPDT

3. Lighted/Non-lighted

None: Non-lighted
 L: Lighted

4. Terminals

None: Solder terminals (tab terminals #110)

5. Transformer Circuit

None: Without transformer circuit
 T1: 100 VAC/110 VAC (Release: September 1999)
 T2: 200 VAC/220 VAC (Release: September 1999)

3. Lamp

A16-□□
 1 2



1. Operating Voltage (Rated Voltage)

LED

5D: 5 VDC (5 VDC)
 12D: 12 VDC (12 VDC)
 24D: 24 VDC (24 VDC)







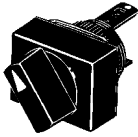

Neon Lamp

1N: 100 VAC 110 VAC
 2N: 200 VAC (220 VAC)

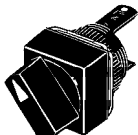
2. Illumination Color

None: Incandescent Lamp
 R: Red (LED)
 G: Green (LED)
 Y: Yellow (LED)
 RN: Red (Neon Lamp)
 GN: Green (Neon Lamp)

Functional Units

Shape	Number of notches	Reset method	Illumination	Rated voltage	Model	Functional unit color code
Rectangular (A165□-J) 	2 notches	Latching	LED	24 VDC	A165W-J2M□	R (red), Y (yellow), G (green)
		Non-lighted	---	A165S-J2M		
	3 notches	Momentary 	LED	24 VDC	A165W-J2A□	
			Non-lighted	---	A165S-J2A	
		Latching	LED	24 VDC	A165W-J3M□	
			Non-lighted	---	A165S-J3M	
Momentary 	LED	24 VDC	A165W-J3A□			
	Non-lighted	---	A165S-J3A			
Square (A165□-A) 	2 notches	Latching	LED	24 VDC	A165W-A2M□	R (red), Y (yellow), G (green)
		Non-lighted	---	A165S-A2M		
	3 notches	Momentary 	LED	24 VDC	A165W-A2A□	
			Non-lighted	---	A165S-A2A	
		Latching	LED	24 VDC	A165W-A3M□	
			Non-lighted	---	A165S-A3M	
Momentary 	LED	24 VDC	A165W-A3A□			
	Non-lighted	---	A165S-A3A			
Round (A165□-T) 	2 notches	Latching	LED	24 VDC	A165W-T2M□	R (red), Y (yellow), G (green)
		Non-lighted	---	A165S-T2M		
	3 notches	Momentary 	LED	24 VDC	A165W-T2A□	
			Non-lighted	---	A165S-T2A	
		Latching	LED	24 VDC	A165W-T3M□	
			Non-lighted	---	A165S-T3M	
Momentary 	LED	24 VDC	A165W-T3A□			
	Non-lighted	---	A165S-T3A			

■ Switch Units

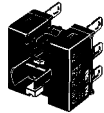
Shape	Classification				Model	
	Lighted	Socket (without transformer circuit)	2 notches	SPDT	Solder terminal	A16S-2N1L
				DPDT		A16S-2N2L
			3 notches	DPDT		A16S-3N2L
	Non-lighted		2 notches	SPDT		A16S-2N1
				DPDT		A16S-2N2
			3 notches	DPDT		A16S-3N2

Accessories (Order Separately)

■ Accessories

Name	Shape	Classification	Model	Remarks
Panel Plugs		Rectangular	A3BJ-3003	Used for covering the panel cutouts for future panel expansion.
		Square	A3BA-3003	
		Round	A3BT-3003	

■ Tools

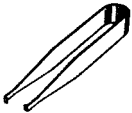
Name	Shape	Model	Applicable types					Remarks
			Pushbutton Switch	Knob-type Selector Switch	Key-type Selector Switch	Emergency Stop Switch	Indicator	
Screw Fitting		A3B-3004	Yes	Yes	Yes	Yes	Yes	Convenient for ganged installation. Tighten to a torque of 0.39 N • m (5 kgf • cm) min.
Extractor		A16Z-5080	Yes	Yes	Yes	Yes	Yes	Convenient for extracting the Switch Unit and Lamps.

Specifications

■ Approved Standards

UL, cUL (File No. E41515)

5 A at 125 VAC, 3 A at 250 VAC (general use)

3 A at 30 VDC (resistive)

EN60947-5-1 (Low Voltage Directive)

■ Ratings

AC resistive load (AC15)	DC resistive load (DC13)
3 A, 250 VAC 5 A, 125 VAC	3 A, 30 VDC

Minimum applicable load: 1 mA at 5 VDC

Rated values are obtained from tests conducted under the following conditions according to JIS C4505 and C4520.

1. Load: Resistive load
2. Mounting conditions: No vibration and no shock
3. Temperature: 20°±2°C
4. Operating frequency: 20 times/min

Contact

Name	Contact
SPDT	

LED

Rated voltage	Rated current	Operating voltage	Internal limiting resistor
5 VDC	30 mA	5 VDC±5%	33 Ω
12 VDC	15 mA	12 VDC±5%	270 Ω
24 VDC	10 mA	24 VDC±5%	1600 Ω

■ Characteristics

Item		Knob-type Selector Switch
Allowable operating frequency	Mechanical	20 operations/min max.
	Electrical	10 operations/min max.
Insulation resistance		100 MΩ min. (at 500 VDC)
Dielectric strength		1,000 VAC, 50/60 Hz for 1 min between terminals of same polarity 2,000 VAC, 50/60 Hz for 1 min between terminals of different polarity and also between each terminal and ground 1,000 VAC, 50/60 Hz for 1 min between lamp terminals (see note 2)
Vibration resistance	Malfuction	10 to 55 Hz, 1.5-mm double amplitude (malfuction within 1 ms)
Shock resistance	Mechanical	500 m/s ² (50G)
	Malfuction	150 m/s ² (15G) max. (malfuction within 1 ms)
Life expectancy	Mechanical	250,000 operations min.
	Electrical	100,000 operations min.
Ambient temperature		Operating: -10°C to 55°C (with no icing or condensation) Storage: -25°C to 65°C (with no icing or condensation)
Ambient humidity		Operating: 35% to 85%
Electric shock protection class		Class II
PTI (tracking characteristic)		175
Degree of contamination		3 (IEC947-5-1)
Weight		Approx. 13 g (in the case of a lighted DPDT switch)

- Note:** 1. Set and reset constitute one operation.
 2. With LED and incandescent lamp not mounted.

■ **Operating Characteristics**

Features	Type	Knob-type Selector Switch	
		2 notches	3 notches
Operating force (OF) max.	0.1 N • m (1,000 gf • cm)		
Set position (SP)	90±5°	45 ^{+10°} ₀	

■ **Operation Angle**

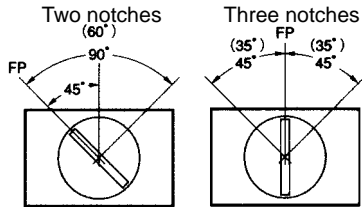

Note: The angle used for automatic reset is shown in parentheses.

■ **Contacts**

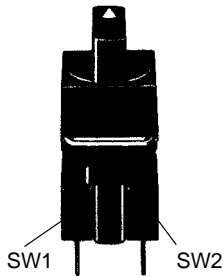

Notch	Contact				
	SPDT		DPDT		
	Position	SW	Position	SW1	SW2
2 notches					
3 notches	---				

Dimensions

Note: All units are in millimeters unless otherwise indicated.

■ Knob-type Selector Switches without Transformer

Rectangular A165□-J

Solder terminals

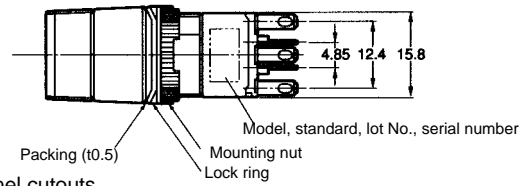
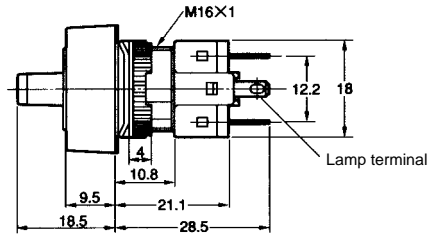
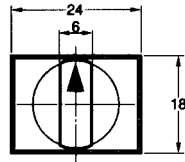
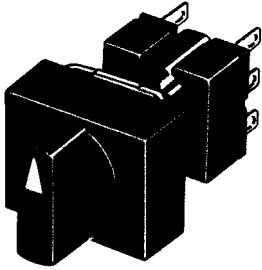

Note: See page 31 for panel cutouts.

Square A165□-A

Solder terminals

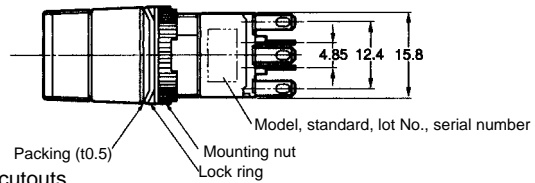
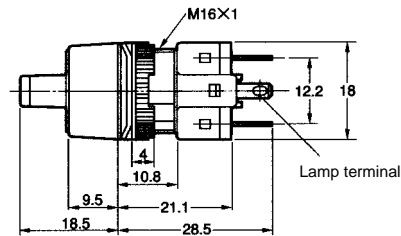
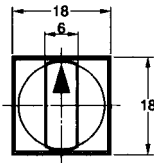
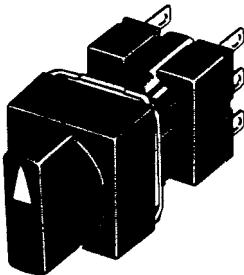

Note: See page 31 for panel cutouts.

Round A165□-T

Solder terminals

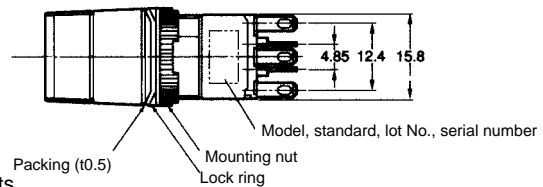
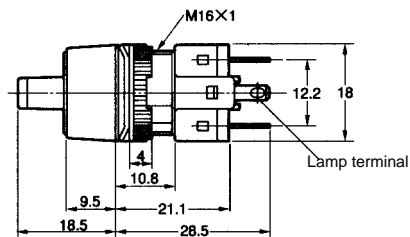
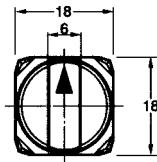
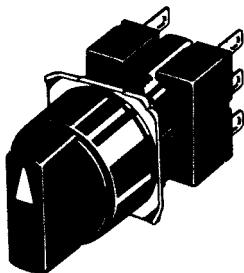

Note: See page 31 for panel cutouts.

■ Panel Cutouts

Rectangular
A165□-J

(Top View)

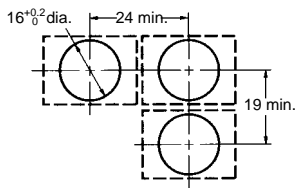

Square A165□-A
Round A165□-T

(Top View)

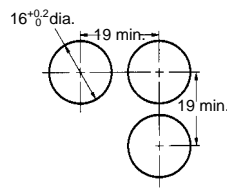

- Note:**
1. Make sure the thickness of the mounting panel is between 0.5 and 3.2 mm. If, however, a Switch Guard or Dust Cover is used, the thickness of the mounting panel must be between 0.5 and 2 mm.
 2. If the panel is to be finished with coating, etc., make sure that the panel meets the specified dimensions after coating.

■ Terminal Arrangement

Without Transformer

Lamp terminals are not provided with the Non-lighted Knob-type Selector Switches and Key-type Selector Switches.

SPDT Switches

Lighted type

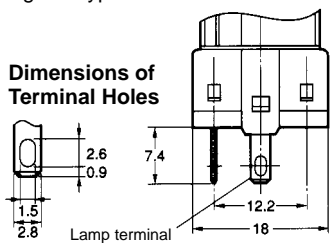

Terminal Arrangement
(Bottom View)

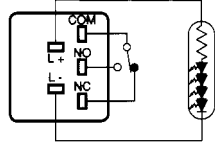

Note: The L+ is not shown on the Switch Unit.

DPDT Switches

Lighted type

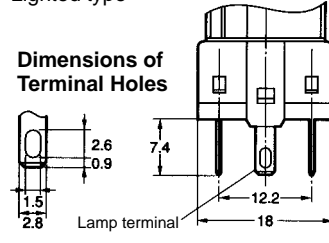

Terminal Arrangement
(Bottom View)

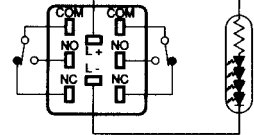

Note: The L+ is not shown on the Switch Unit.

Installation

For details on mounting the Switch to a panel, and mounting and dismantling the Switch Unit, refer to installation details for the A16 Pushbutton Switch.

Flange Rotation

A165 Knob-type Selector Switch

Fix the Switch screw and rotate the flange in 45° turns.

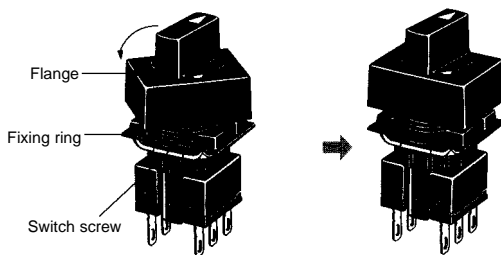

ALL DIMENSIONS SHOWN ARE IN MILLIMETERS.

To convert millimeters into inches, multiply by 0.03937. To convert grams into ounces, multiply by 0.03527.