

OMRON

Vision Sensor

FZ3 Series

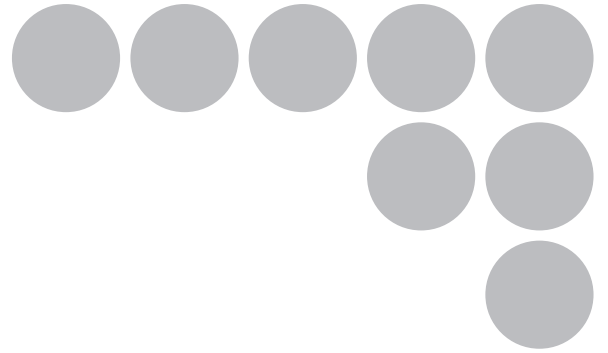

User's Manual

Introduction

Thank you for purchasing the FZ3 Series.

This manual provides information regarding functions, performance and operating methods that are required for using the FZ3 Series.

When using the FZ3 Series, be sure to observe the following:

- The FZ3 Series must be operated by personnel knowledgeable in electrical engineering.
- To ensure correct use, please read this manual thoroughly to deepen your understanding of the product.
- Please keep this manual in a safe place so that it can be referred to whenever necessary.

Contents

1. Before Operation	9
Operation Flow	10
Layouts of Screens/Windows	11
Layout of Main Screen (ADJUST Window)	11
Layout of Main Screen (RUN Window)	14
Layout of Edit Flow Window	17
Layout of Property Setting Window	19
Checking System Configuration	20
Basic Configuration of FZ3 Series	20
Description of Model-specific Functions	21
Preparing Controllers and Cameras	23
Preparing Controllers	23
Adjusting Cameras	23
Intelligent Camera (with Lighting Function)	24
Input Operations	25
Operation of Touch Pen	25
Basic Operation of Mouse and Trackball	25
Returning Controller to Factory Settings	27
Initializing Controller [System Initialization]	27
Restarting Controller [System Restart]	27
Saving Settings and Turning Power Off	28
Turning Off LCD	28
Setting Operation Mode	30
Operation Mode Selection Guidelines	32
High-speed Logging Mode	32
Parallel-operation High-speed Mode	32
Single-line High-speed Mode	35
Multi-line Random-trigger Mode	37
Non-stop Adjustment Mode	38
2. Setting Scenes (Measurement Flow)	41
What Is a Scene?	42
Scene Examples	42
What Is a Scene Group?	46
Creating a Scene	47
Processing Item Selection Guidelines	49
Selecting Measurement Processing Items Using a Chart	49
Selecting Measurement Processing Items According to the Measurement Method and Purpose	56
Editing Processing Units in Scenes	63
Switching Scenes and Scene Groups	65
Switching Scenes	65
Switching Scene Groups	65
Editing Scenes	67
Copying a Scene	67
Clearing a Scene	67

Renaming a Scene and Adding a Description	68
Editing Scene Groups	70
Copying a Scene Group	70
Deleting a Scene Group	71
Renaming a Scene Group	71
3. Performing Test Measurement/Starting Operation	73
ADJUST Window and RUN Window	74
ADJUST Window	74
RUN Window	74
Switching to the RUN Window	76
Switching to the ADJUST Window	76
Performing Test Measurement	77
Key Points for Adjustment	79
Stabilizing Measurement	79
Shortening Processing Time	81
Arranging the RUN Window	82
Displaying Multiple Windows Together	82
Changing Display Contents	83
Enlarging Measurement Images [Zoom Images]	87
Displaying Flow and Detailed Results	87
Switching the RUN Window to Fast View Mode [Select RUN Mode]	88
Changing Display Contents on the RUN Window Measurement Information Display Area	89
Changing Functions That Can Be Operated from the RUN Window Tool Box	89
Useful Functions for Operation	90
Remeasuring Saved Images	90
Improving Adjustment Efficiency	91
Changing Judgement Conditions without Stopping Measurement	93
Changing Regions as a Batch [Shift area]	94
Monitoring Measurement Value Trends	95
Logging Measurement Values and Measurement Images	96
Analyzing Logging Data	102
Clearing Measurement Results	104
Clearing Saved Images	104
Capturing Screens	105
4. Using Tool	107
Using NG Analyser	108
Layouts of NG Analyser Screens	109
Using Method of NG Analyser	111
5. Saving/Loading Data	115
Basic Knowledge about Data Saving	116
About Saving Areas	116
About USB Drive Names	116
Saving Settings Data to Controller Memory	118
When Using Scene Group 0	118
When Using Scene Groups 1 to 31	118
Saving Settings Data to RAMDisk/USB Device	120

Saving Logging Images to RAMDisk/USB Device	122
How to Use USB Memory (FZ3-9/H9only).....	123
Copying/Moving Files	124
Loading Settings Data to Controller	126
6. Changing the System Environment	127
Setting Conditions for Camera Use	128
Checking Camera Connections [Camera Connection]	128
Setting Trigger Delay [Inter-camera Setting].....	128
Setting Conditions Related to Operation during Measurement	130
Setting the System Operation Environment	131
Setting the Date and Time [Date-time Setting]	131
Selecting the Language [Language Setting]	131
Setting the Fan Rotation Speed [Fan Control Setting].....	132
Setting the Start-up Status [Startup Setting]	133
Setting the RUN Window Display [RUN mode View Setting]	138
Setting the RUN Window Shortcut [Create Shortcut]	138
Setting the Encoder Trigger [Encoder Trigger Setting]	139
Setting the STEP Input Detection Pulse Width [STEP Setting]	141
Setting the RUN Window Password [Password Setting].....	142
Setting a Network Drive [Network Drive Setting]	143
Checking System Information [System Information]	145
7. Methods for Connecting and Communicating with External Devices	148
About Connecting with External Devices	149
Communicating through Serial Communication (PLC Link)	152
Communication Processing Flow (PLC Link)	152
Setting Communication Specifications (Ethernet - PLC Link)	152
Setting Communication Specifications (RS-232C/422-PLC Link).....	157
Memory Allocation (PLC Link).....	161
Command Control (PLC Link)	163
Data Output (PLC Link)	174
Timing Chart (PLC Link)	174
Ladder Program Example (PLC Link).....	178
Controlling/Outputting through Serial Communication (Non-procedure)	179
Communication Processing Flow (Non-procedure)	179
Setting Communication Specifications (Ethernet - Non-procedure)	179
Setting Communication Specifications (RS-232C/422 - Non-procedure).....	183
Checking Communication Status (Non-procedure)	184
Command Format (Non-procedure)	185
Command List (Non-procedure)	186
Output Format (Non-procedure)	211
Control/Output through EtherNet/IP	214
Communication Processing Flow (EtherNet/IP)	214
Setting Communication Specifications (EtherNet/IP)	215
Memory Allocation (EtherNet/IP).....	217
Command Control (EtherNet/IP).....	219
Data Output (EtherNet/IP)	219
Timing Chart (EtherNet/IP)	219

Controlling/Outputting through Parallel Communication	221
Setting Communication Specifications (Parallel Interface)	221
Checking Communication Status (Parallel Interface)	223
I/O Format (Parallel Interface)	224
Timing Chart	228
Externally Outputting Data through FTP	241
Setting Communication Specifications	241
Communication Example	243
8. External Reference Tables	244
Input image	247
Measurement Image Switching	247
Measurement	248
Search	248
Flexible Search	249
Sensitive Search	250
ECM Search	252
EC Circle Search	253
Shape Search+	255
Classification	257
Edge Position	258
Edge Pitch	259
Scan Edge Position	260
Scan Edge Width	261
Color Data	262
Gravity and Area	263
Labeling	265
Label Data	267
Labeling+	268
Defect	272
Precise Defect	273
Fine Matching	274
Character Inspection	275
Date Verification	276
Model Dictionary	277
Barcode+	277
2D Code+	279
Circle Angle	280
Compensate image	282
Position Compensation	282
Trapezoidal Correction+	282
Filtering	283
Background Suppression	283
Color Gray Filter	284
Extract Color Filter	285
Anti Color Shading	286
Stripes Removal Filter+	286
Halation Cut+	287
Panorama+	287
Polar Transformation	288

Support measurement	289
Calculation	289
Line Regression	289
Circle Regression	290
Calibration+	290
Set Unit Data	291
Get Unit Data	291
Set Unit Figure	291
Get Unit Figure	291
Trend Monitor	292
Image Logging	293
Data Logging	293
Elapsed Time	294
Wait	294
Focus	294
Iris	294
Branch	296
Conditional Branch	296
DI Branch	296
Output result	297
Data Output	297
Parallel Data Output	297
Parallel Judgement Output	298
Fieldbus Data Output	299
Display result	300
Result Display	300
Display Image File	300
Display Last NG Image	300
9. Appendixes	302
About Lenses	303
Error Messages and Troubleshooting	309
FAQ	313
During Start-up	313
During Operation	313
For Measurement	314
About Parallel Interface	315
About Serial Interface (RS-232C/422 Connection)	315
Measurement Mechanism	316
Color Processing Mechanism	316
Search Processing Mechanism	316
Edge Detection Measurement	320
Defect Detection Measurement	322
Handling Coordinates	323
Terminology Explanations	325
Basic Knowledge about Operations	329
Inputting Values	329
Inputting Text	329
Selecting Files and Folders	330

Available Operations in Select File Window	332
Using the Zoom Function	333
Setting Figures	335
Layout of Figure Setting Area	335
Setting Methods	336
About OR Setting/NOT Setting	344
About Number of Logging Images	346
About Limits on the Number of Image Input Processing Items Used	347
About Max. Number of Loading Images during Multiple Image Input	349
Character Code Table	350
Upper Limits of Processing Item Parameters	351
About Memories Usable with FZ Series	352
Memory Display Image on PLC I/O	353
Manual Revision History	356
Index	357



How This Manual Is Organized

This manual includes two manuals: the "User's Manual", which describes basic operations and settings for vision sensors, and the "Processing Item List Manual", which describes the setting options for each processing item.

Conventions Used in This Manual

Symbols

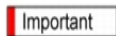
The symbols used in this manual have the following meanings.

	Indicates relevant operational precautions that must be followed.
	Indicates operation-related suggestions from OMRON.

Use of Quotation Marks and Brackets

In this manual, menus and other items are indicated as follows.

[]	Menu	Indicates the menu names or processing items shown in the menu bar.
" "	Item name	Indicates the item names displayed on the screen.

Version Upgrade Information

The newly added functions are described here.

Revision history

Newly added function	Description of newly added functions	Reference in manual
EtherNet/IP	EtherNet/IP communication is now supported. Supported software version: 3.30 or later	Reference: ▶ "User's Manual", "Control/Output via EtherNet/IP" (p.214)
Network drive	Saving to a network drive is now supported. Supported software version: 3.30 or later	Reference: ▶ "User's Manual", "Setting a Network Drive [Network Drive Setting]" (p.143)
Barcode+	Pharmacode was added to the code types readable with Barcodes+. Supported software version: 3.30 or later	Reference: ▶ "Processing Items List Manual", "Barcode+" (p.267)
Camera Image Input HDR	Camera image input HDR is now usable with the FZ3-300/700/900 series. Supported software version: 3.30 or later	Reference: ▶ "Processing Items List Manual", "Camera Image Input HDR" (p.34)
Camera addition	The intelligent compact camera FZ-SQ is now supported. Supported software version: 3.30 or later	Reference: ▶ "User's Manual", "Checking System Configuration" (p.20) Reference: ▶ "Processing Items List Manual", "Camera Image Input" (p.12) Reference: ▶ "Processing Items List Manual", "Camera Image Input HDR Lite" (p.40)

Before Operation

This chapter describes the basic flow and preparations before beginning operation.

- ▶ Reference: Operation Flow (p.10)
- ▶ Reference: Layouts of Screens/Windows (p.11)
- ▶ Reference: Checking System Configuration (p.20)
- ▶ Reference: Preparing Controllers and Cameras (p.23)
- ▶ Reference: Input Operations (p.25)
- ▶ Reference: Returning Controller to Factory Settings (p.27)
- ▶ Reference: Saving Settings and Turning Power Off (p.28)
- ▶ Reference: Setting Operation Mode (p.30)

Operation Flow

Here describes the operation flow.

1 Before Operation

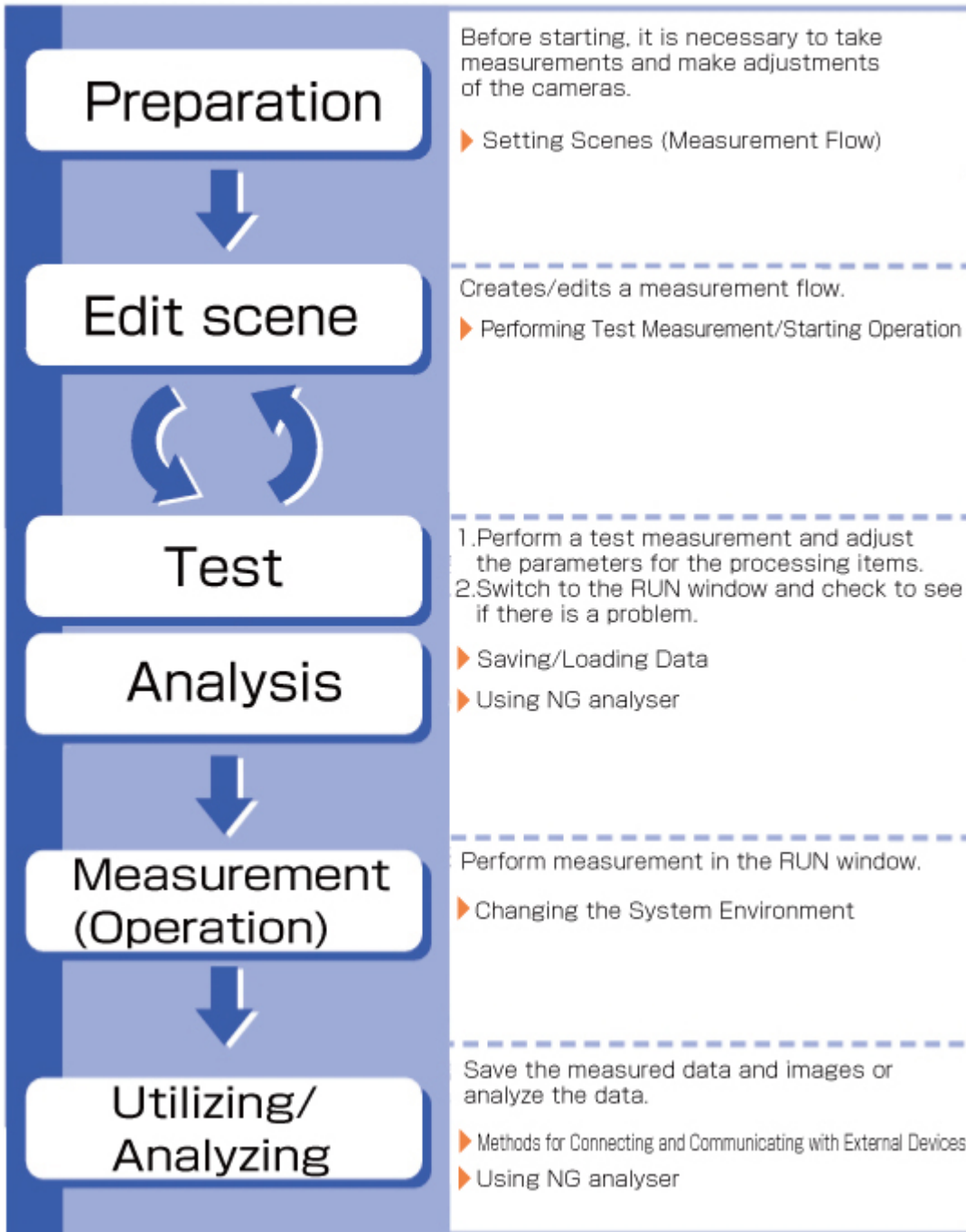

Layouts of Screens/Windows

Screens vary with the status of the operation being performed. The structure of some typical screens and the functions for the various buttons are described here.

Main screen (ADJUST window)

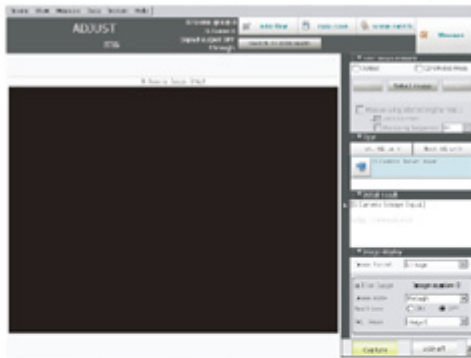

Screen for confirming measurement status and for performing adjustment. When the power is first turned on, the ADJUST window is displayed after the Language Setting window. To set the measurement conditions, move to the Edit Flow window. If there is no problem with the measurement conditions, move to the RUN window.



Edit flow window

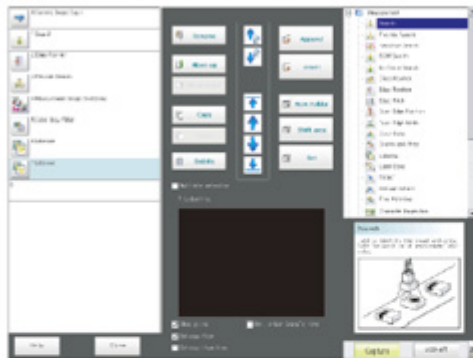

Window for assembling the measurement flow. Flow parts (processing items) are displayed on the right side, and the measurement flow (scene) is displayed on the left side. When the measurement trigger is activated, processing is executed in sequence starting from the top of the flow.

Main screen (RUN window)

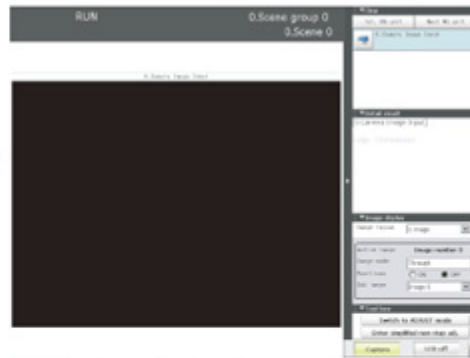

This is the window for actually starting operation. Only information necessary during operation is displayed.

Property window

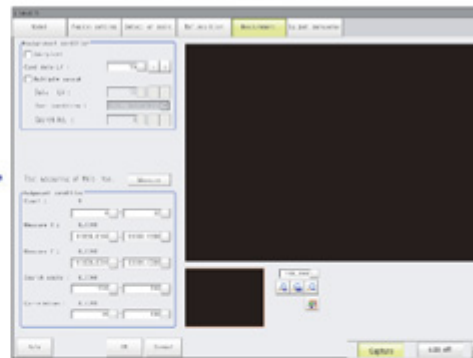

Window for setting conditions for processing units (processing items registered in the scene) set in the flow. This window can also be displayed directly from the Main screen (ADJUST window).

Layout of Main Screen (ADJUST Window)

This screen is used to check whether measurement is being performed correctly according to the set conditions.

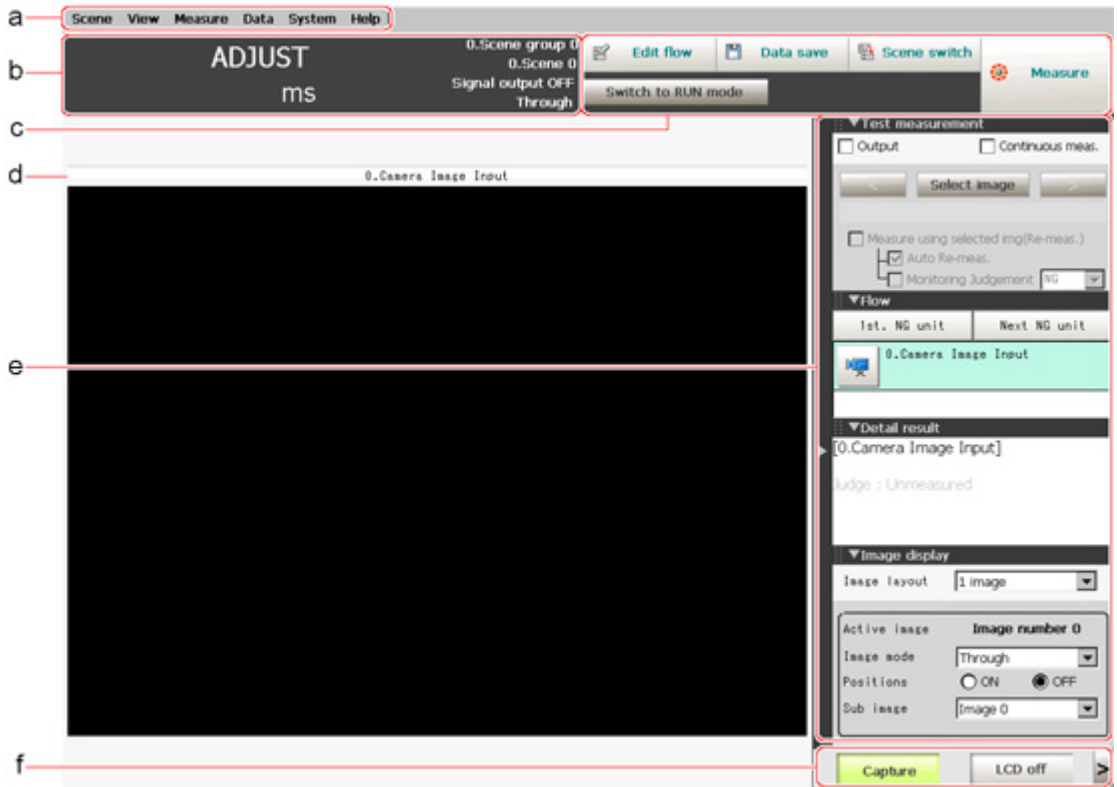

- a. Menu Bar
Select operations and settings menus related to measurement.
- b. Measurement Information Display Area

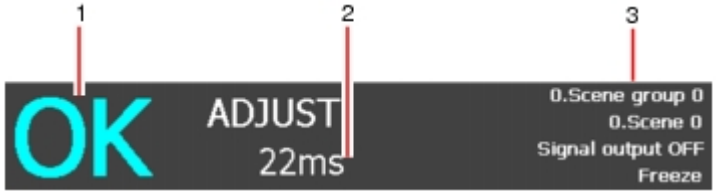

- 1. Overall judgement
Displays a scene's overall judgement result ([OK]/ [NG]).
- 2. Processing time
Displays the time required for the measurement process.
- 3. Status display
Displays the scene group number, scene number, external output status, and image mode for the currently displayed scene.

- c. Toolbar
Commonly-used functions appear in the toolbar.
 - Edit flow
The Edit Flow window is displayed. Addition and deletion of processing units and switching of the processing sequence is performed in the Edit Flow window.
 - Data save
Setting data is saved into the internal flash memory in the controller. Make sure to save when settings have been modified.
 - Scene switch
To switch a scene group or scene.
 - Measure/Stop meas.

- Starts/stops measurement.
- Switch to RUN mode
- Switches to the RUN window.

d. Image Display Area

Displays the measured image.



1. Property setting buttons

Displays the name of the currently selected processing item. Moving to the property setting window can be done by tapping here.

e. Control Area

Displays "Test measurement", "Flow", "Detail result", and "Image display".

- Test measurement
 - Use when test measurement conditions and images that have been acquired are used for remeasurement.



- Flow
 - Displays the judgement results for the flow and each unit.

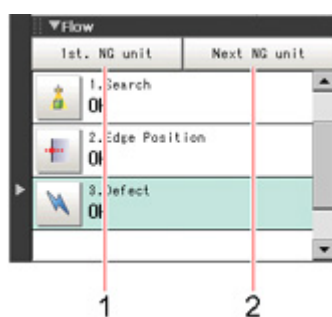

1. Moves to the top processing unit with an NG error.

2. Moves to the next processing unit with an NG error.

- Detail result
 - The detailed measurement results of the processing units selected in the measurement flow are displayed as text.



- Image display
 Sets the display method for the Image Display area.

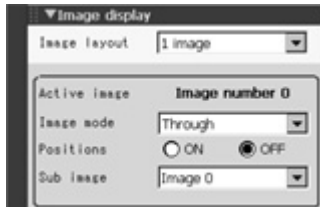

f. Measurement Manager Bar

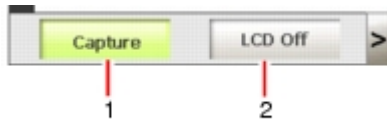

- [Capture]
 Saves the content displayed on the monitor as an image.
 Reference: ▶ Set the save destination for captured images. (p.106)
- [LCD Off] (Displayed only with LCD-integrated controllers.)
 Turns off power to the LCD monitor. Tap the bottom of the monitor screen to turn on power to the LCD monitor again.

Layout of Main Screen (RUN Window)

This window is used during operation.

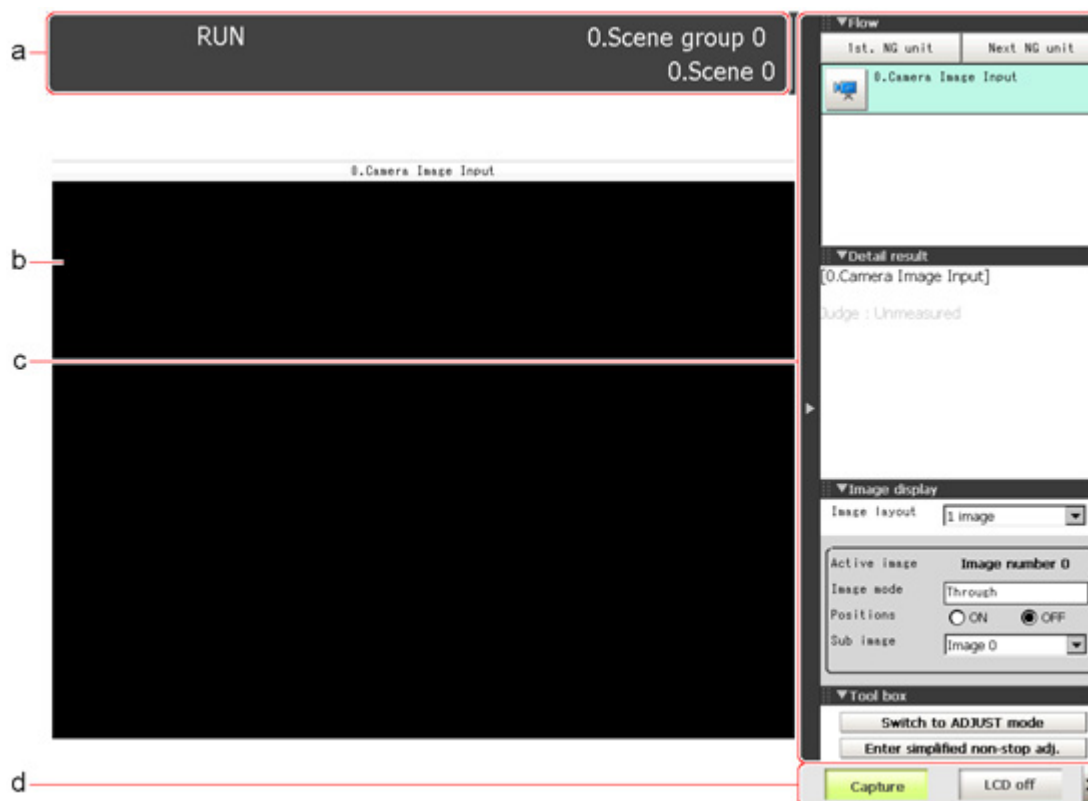

a. Measurement Information Display Area



1. Overall judgement
Displays a scene's overall judgement result ([OK]/ [NG]).
The judgement results for each processing unit are displayed in the Control area.
2. Processing time
Displays the time required for the measurement process.
3. Scene Group Name, Scene Name
Displays the scene group number and the scene number of the currently displayed scene.

b. Image Display Area

Displays the measured image.

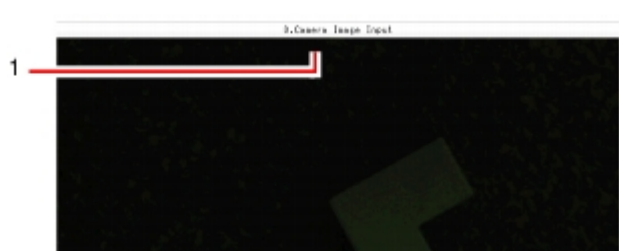

1. Property setting buttons
Displays the name of the currently selected processing item.

C. Control Area

Displays [Flow], [Detail result], [Image display], and [Tool box].

- Flow

Displays the judgement results for the flow and each unit.

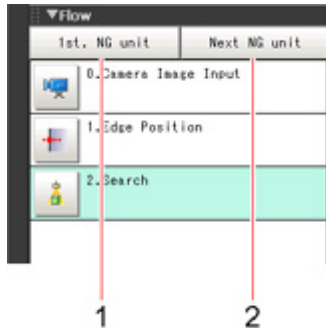

1. Moves to the top processing unit with an NG error.

2. Moves to the next processing unit with an NG error.

Note

- The size of the processing unit buttons can be changed through [View] menu - [Display the enlarged flow] in the ADJUST Window.

- Detail result

The detailed measurement results of the processing units selected in the measurement flow are displayed as text.

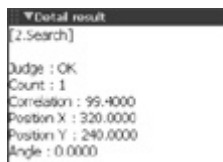

- Image display

Sets the display method for the Image Display area.

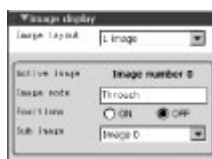

- Tool box

Starts and stops simplified non-stop adjustment, and switches to the ADJUST window.

Items for which operation is performed in the ADJUST window can be allocated to buttons, and they can then be executed in the RUN window.



d. Measurement Manager Bar



1. [Capture]
Saves the content displayed on the monitor as an image.
Reference: ▶ Set the save destination for captured images. (p.106)
2. [LCD Off] (Displayed only with LCD-integrated controllers.)
Turns off power to the LCD monitor. Tap the bottom of the monitor screen to turn on power to the LCD monitor again.

Layout of Edit Flow Window

This window is for compiling the measurement flow. Flow parts are displayed on the right side and the measurement flow is displayed on the left. If the measurement trigger is activated, processing is executed in sequence starting from the top of the flow.

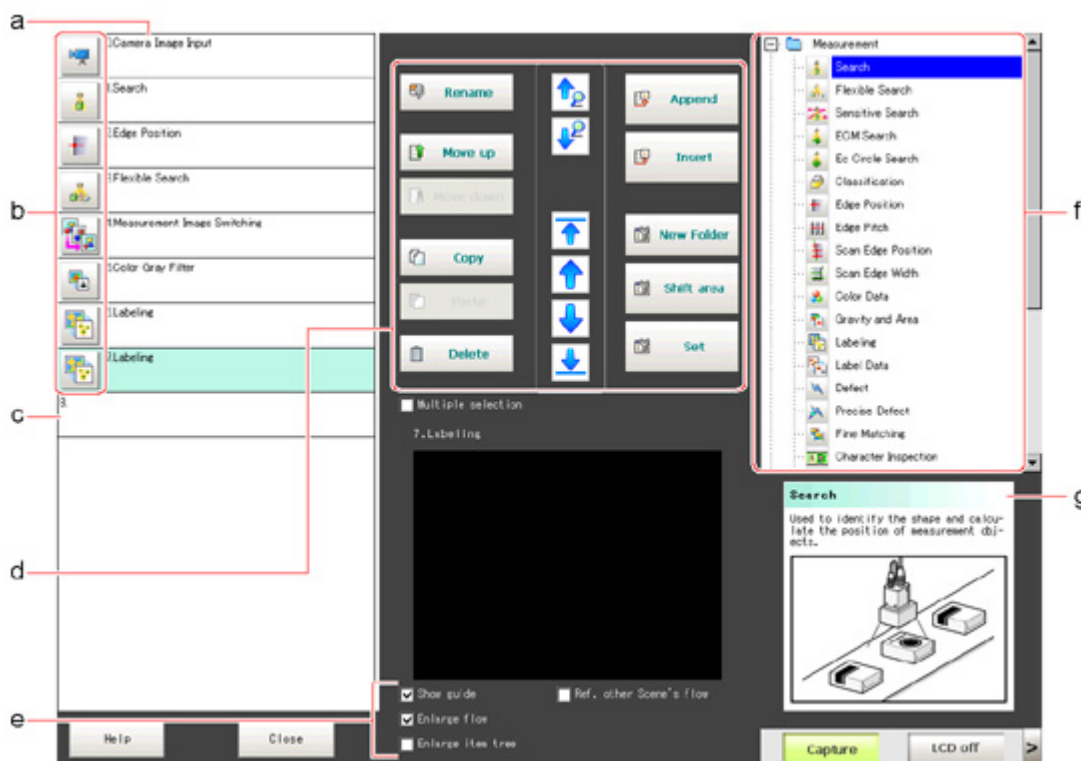

- a. Unit List
Lists the processing units included in the flow.
You can create a flow for a scene by adding processing items to the unit list.
- b. Property Setting Buttons
Displays the property setting window where detailed settings can be performed.
- c. End Marker
Indicates the end of the flow.
- d. Edit Flow Buttons





Search up/Search down

Searching can be performed to find out what position a processing item occupies in the unit list.

The icon for the processing item to be searched for is selected in the processing item tree and clicked.

This function is convenient when setting long flows.

-  Select top/Select bottom
 Selects the processing unit at the top or bottom of the flow.
-  Select above/Select below
 Selects the processing unit located one above or one below the currently selected processing unit.
- Rename
 Displays a window for renaming the selected processing unit.
- Move up/Move down
 Moves the selected processing unit upward or downward.
- Copy
 Copies the selected processing unit.
- Paste
 Pastes the copied processing unit immediately before the selected processing unit. Pasting cannot be performed if any operations other than paste are performed after copying.
- Delete
 Deletes the selected processing unit.
- Append (Bottom)
 Adds a processing unit to the bottom of the flow.
- Insert
 Inserts a new processing unit immediately before the selected processing unit.
- New folder
 Used when multiple processing units are managed as one group.
- Shift area
 Changes related figure data in one batch.
- Multiple selection
 Used when processing units are copied or deleted together.
- Set
 Displays the processing item setting window for the selected processing unit.

e. Display Options

- Show guide
 When checked, explanations for processing items are displayed.
- Enlarge flow
 When checked, the "a Unit list" flow is displayed with large icons.
- Enlarge item tree
 When checked, the "f Processing item tree" is displayed with large icons.
- Ref. other Scene's flow
 When checked, other scene flows within the same scene group can be referred to.

f. Processing Item Tree

This area is for selecting processing items to add to the flow. Processing items are classified by type and displayed as a tree. Tapping the plus sign "+" of any item displays expanded contents

below that item. Tapping the minus sign "-" of any item collapses the expanded contents. When "Ref. other Scene's flow" is checked, the scene select box and other scene flows are displayed.

g. Guide

Shows an explanation for the processing item selected in the processing item tree. These are used as reference when selecting processing items. To display guides, check "Show guide" in "e Display options".

Layout of Property Setting Window

This window is used for detailed setting of measurement parameters and judgement conditions for processing items.

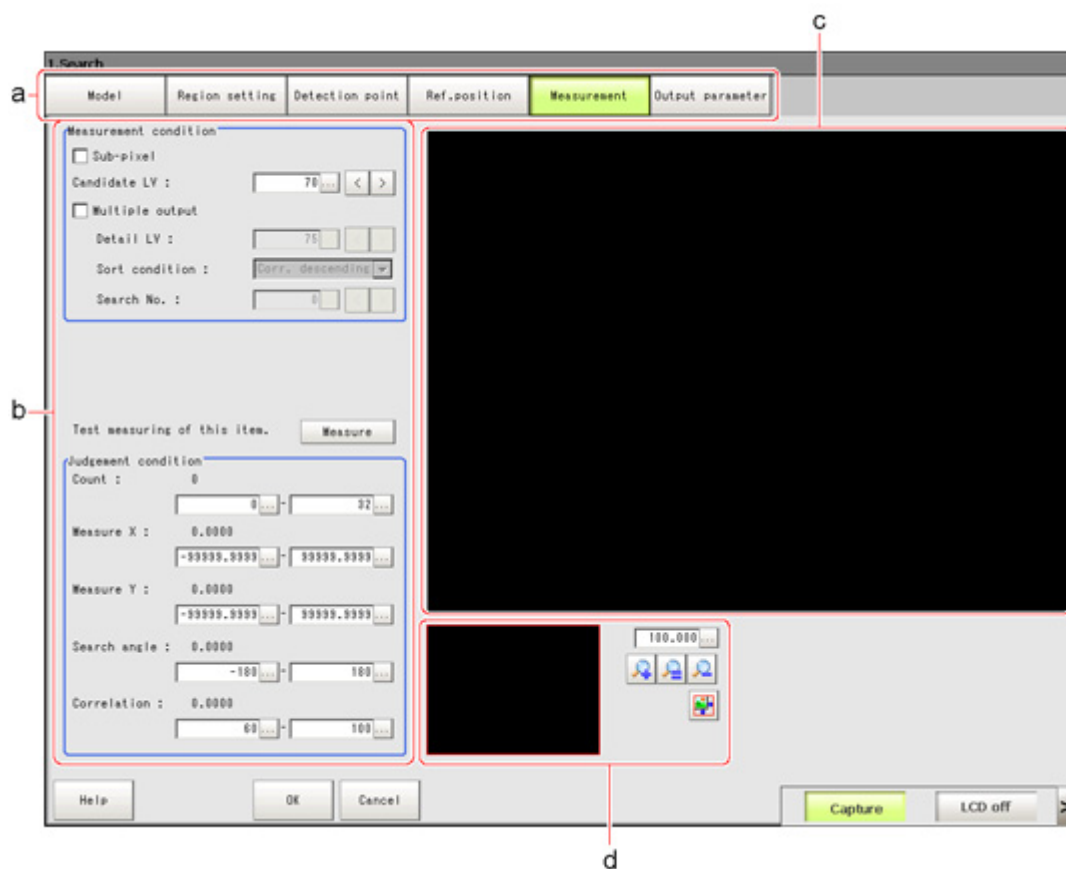

a. Item Tab Area

Displays the settings items for the processing unit currently being set. Perform settings starting with the item on the left.

b. Detail Area

Set detailed items.

c. Image Display Area

Displays camera images, figures, and coordinates.

d. Zoom Browser Area

Zooms in and out from the displayed image.

Checking System Configuration

This product is a vision sensor for performing image processing measurement through a controller of objects photographed using a camera. By connecting an external device such as a PC, measurement commands can be input and measurement results can be output from the external device.

Basic Configuration of FZ3 Series

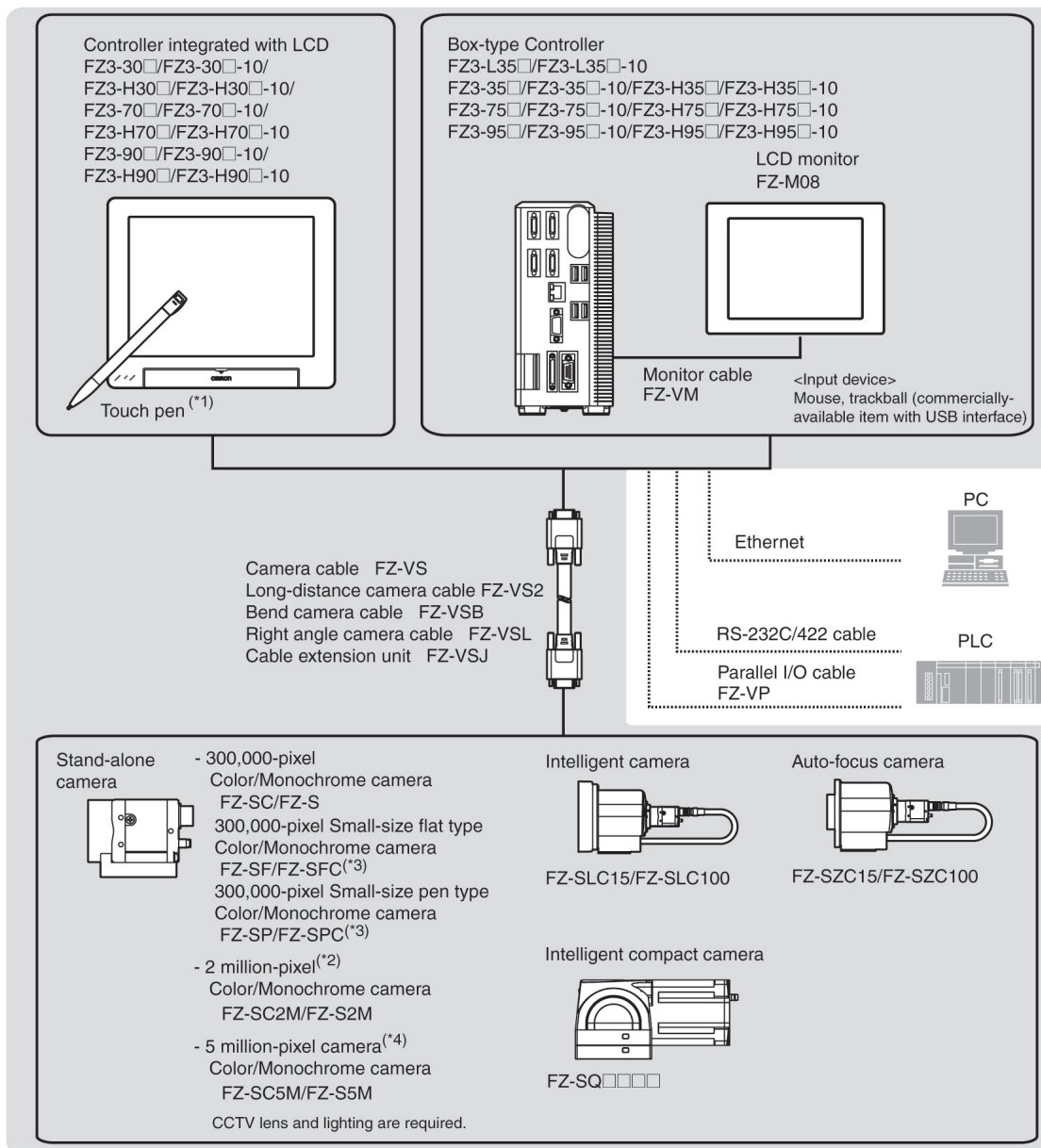

*1: The touch pen is a controller accessory.

*2: FZ-SC2M and FZ-S2M cannot be connected with the FZ3-3□□ /FZ3-H3□□ series.

*3: Lenses for small-size cameras are required for small-size 0.3 megapixel cameras.

*4: FZ-SC5M/FZ-S5M cannot be connected with the FZ3-3□□ /FZ3-H3□□ series.

Reference

- For details on connector specifications, etc., see the "Operator's Manual (Setup)" of each model.

Description of Model-specific Functions

Functions added after software version 3.xx

Operation mode

Thanks to the dual core CPU, different operation modes can be set to meet different purposes of use. A desired operation mode can be selected from [Parallel-operation high-speed mode], [Single-line high-speed mode], [High-speed logging mode], [Non-stop adjustment mode] and [Multi-line random-trigger mode].

Reference: ▶ Setting Operation Mode (p.30)

Useful processing items when setting up camera

[Focus] (focus adjustment) and [Iris] (iris adjustment) have been added to support camera adjustment during startup.

Reference: ▶ "Processing Item List Manual", "Focus" (p.397)

Reference: ▶ "Processing Item List Manual", "Iris" (p.400)

NG analyser

This tool supports various analysis tasks at startup and during operation, such as identifying optimal thresholds using sample images and finding the causes of problems occurring on the line by analyzing logging images.

Reference: ▶ Using NG Analyser (p.108)

PLC link Support of Mitsubishi Electric Corporation PLC

The MELSEC Q series (by Mitsubishi Electric Corporation) has been added to the list of devices this sensor can communicate with via PLC link.

Reference: ▶ Setting Communication Specifications (Ethernet - PLC Link) (p.152)

Reference: ▶ Setting Communication Specifications (RS-232C/422 - PLC Link) (p.157)

List of model-specific new functions

New function	Type of controller					
	FZ3 -3 □□ FZ3 -L35 □	FZ3 -H3 □□	FZ3 -7 □□	FZ3 -H7 □□	FZ3 -9 □□	FZ3 -H9 □□
Function						
Operation mode Reference: ▶ Setting Operation Mode (p.30)	-	-	-	-	○	○
NG Analyser Reference: ▶ Using NG Analyser (p.108)	○	○	○	○	○	○

Support of PLC link (MELSEC Q series) Reference: ▶ Setting Communication Specifications (Ethernet - PLC Link) (p.152) Reference: ▶ Setting Communication Specifications (RS-232C/422 - PLC Link) (p.157)	○	○	○	○	○	○
Processing item						
Standard processing item	○	○	○	○	○	○
Sophisticated processing item (processing item having + at the end of the item name)	-	○	-	○	-	○
Useful processing items when setting up camera Reference: ▶ "Processing Item List Manual", "Focus" (p.397) Reference: ▶ "Processing Item List Manual", "Iris" (p.400)	○	○	○	○	○	○

Preparing Controllers and Cameras

Preparing Controllers

No special preparation is required with this product as processing items are pre-installed. Please check that the controller is switched on and that the Main screen is displayed.

For details, see the User's Manual.

The first time the program is started up, the Language Setting window is displayed, so select the language.

Reference: ▶ Selecting the Language [Language Setting] (p.131)

Adjusting Cameras

Confirm what kind of images are being taken.

Adjust the position of measurement objects and the focus of the lens.

1. Tap [▼] of "Image mode" in [Image display] of the Main screen Control area, and select "Through".

The through images captured from the camera are viewed in the Image Display area.

Reference: ▶ Changing Display Contents (p.83)

Note

- The same operation is available by tapping [View] - [Image mode] - [Through].

2. Adjust the position of measurement objects so that they display at the center of the monitor.



Adjust the positions of objects to be measurement

3. Adjust the focal distance of the lens.

When using an auto-focus camera or an intelligent camera, focus and the iris can be automatically adjusted.

Note

- If a camera is used together with a lens, turn the focus ring of the lens to adjust the focus.
Reference: ▶ "Processing Item List Manual", "Lens Setting" (p.23)
- The light intensity of an intelligent camera can be adjusted from the controller.
Reference: ▶ "Processing Item List Manual", "Lighting Control" (p.19)

Important

- When using a small-size digital camera, check that the model and serial number of the camera head and camera amplifier match. When a camera head and camera amplifier of different models and serial numbers are connected, they may not operate correctly.

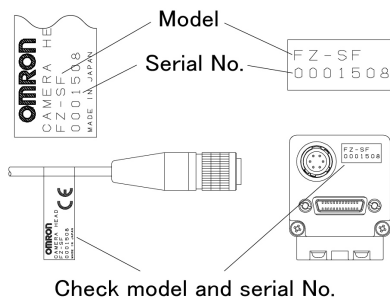

Intelligent Camera (with Lighting Function)

Proper lighting is of crucial importance to vision sensors.

If an intelligent camera is connected, lighting can be controlled from the controller.

Features of intelligent cameras are as follows:

- A single camera enables testing of illumination from various angles, so it is possible to shorten the lighting setting time and test measurement time.
- The controller controls lighting, so lighting can be adjusted depending upon the product type.
- Reproducibility of lighting settings is improved.
- Settings can be modified without changing lighting.

Reference: ▶ "Processing Items List Manual", "Screen Adjust Settings (Camera Image Input)" (p.19)

Input Operations

Input operations differ depending on the type of controller.

- Controller integrated with LCD: Operation with touch pen
- BOX-type controller: Operation with mouse and trackball

Operation of Touch Pen

With a Controller integrated with LCD, perform the following operations when operating the touch screen with the touch pen.

Tapping

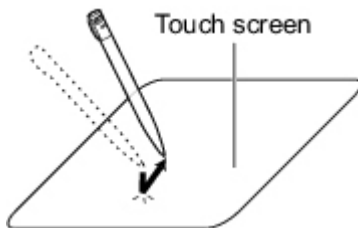

Lightly touch the screen once with the touch pen and immediately take it off. Perform when selecting items, etc.

Drag

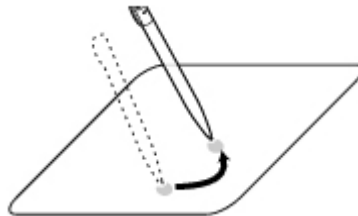

Draw while pressing on the screen lightly with the touch pen.

Important

- Be sure to use the supplied touch pen for touch screen operations. Using a pencil or ballpoint pen may damage the touch screen.
- In addition, response to operations may be delayed if the screen is tapped continuously and rapidly.

Basic Operation of Mouse and Trackball

With a BOX-type controller, use a mouse with a USB interface or commercially-available trackball. (See the list for recommended products. Please refer to the product catalog.)

Note

- Do not use the right mouse button, scroll wheel, or other buttons.

Click

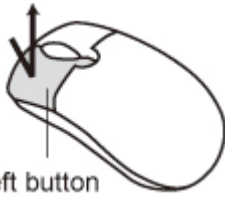

Left button

Press the left mouse button once. Perform when selecting items, etc.

Note

- This document primarily describes operations using the term "tapping". When using a mouse or trackball, read "Tapping" to mean "Clicking".

Drag

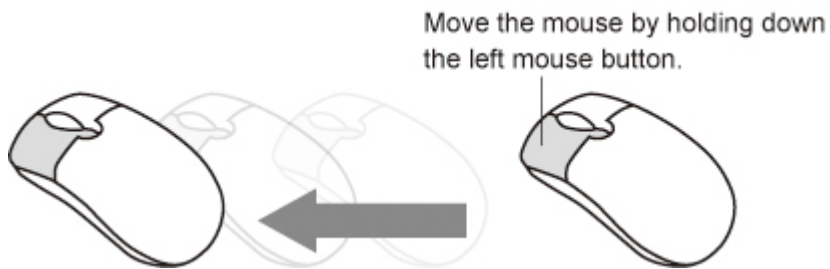

Move the mouse with the left mouse button held down.

Returning Controller to Factory Settings

All controller settings can be restored to factory default status (initialization).

In addition, the controller can be restarted.

- Reference: ▶ Initializing Controller [System Initialization] (p.27)
- Reference: ▶ Restarting Controller [System Restart] (p.27)

Initializing Controller [System Initialization]

Restores the controller to factory default status. Before initialization, back up required data such as scene data and system data.

Reference: ▶ Saving Settings Data to RAMDisk/USB Device (p.120)

1. On the Main screen, tap [System] - [Controller] - [System initialization].
The System Initialization window is displayed.
2. Tap [Execute].

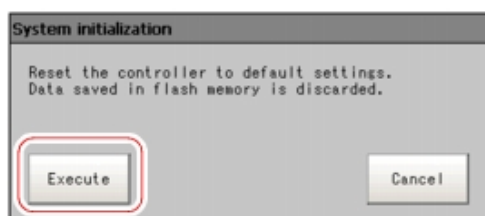

A confirmation window is displayed.

3. Tap [Yes].

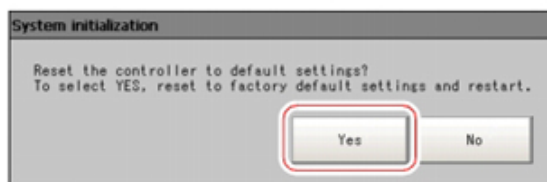

The controller is initialized and restarts.

Restarting Controller [System Restart]

Restart the controller. Before restarting, back up required data such as scene data and system data.

Reference: ▶ Saving Settings Data to Controller Memory (p.118)

1. On the Main screen, tap [System] - [Controller] - [System restart].
The System Restart window is displayed.
2. Tap [OK].



The controller restarts.

Saving Settings and Turning Power Off

Before turning off power to the controller, perform the following operations to save the data that you have set.

The controller loads scene data from the flash memory each time during start-up. Therefore, if the power is turned off without saving data to the flash memory, any changes made will not be saved.

1. On the Main screen (ADJUST window), tap [Data save] in the toolbar to save the setting data.



2. Exit after powering off the controller.

Note

- Data to be saved
Scene data and system data are saved in the controller. Logging images and data saved in the RAMDisk are not saved. Perform any of the following procedures to keep this data.
 - Copy data saved in the RAMDisk to the USB memory.
Reference: ▶ Copying/Moving Files (p.124)
 - Change the save destination of logging data to USB memory.
Reference: ▶ Saving Logging Images to RAMDisk/USB Device (p.122)
- When using the scene group function
The scene data set in Scene group 0 is saved in the controller. The scene data from scene groups 1 to 31 is saved to the USB memory and overwrites previous saved data. (For FZ3-9 □□ /H9 □□ , all data are saved in the controller.)

Turning Off LCD

This function is specific to FZ3-300/700/900 series LCD-integrated controllers.

Turn off the LCD only without turning off the controller.

1. Open the measurement manager bar at the bottom right of the Main screen and tap [LCD Off].



A confirmation message is displayed.

2. Tap [OK].

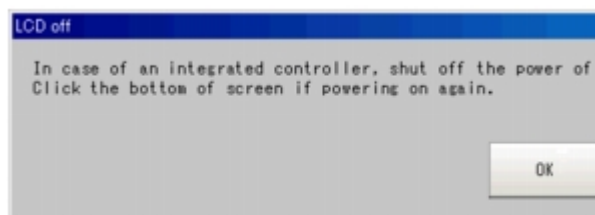

Power to the LCD is turned off.

Turning LCD On Again

This function is specific to FZ3-300/700/900 series LCD-integrated controllers.

Tap the lower part of the monitor screen.

Then, the LCD will be switched on.

Setting Operation Mode

This section describes the operation mode (FZ3-9 □□ /H9 □□ only). Utilize the dual core CPU to set an operation mode appropriate for the condition of use. This function is effective in improving the takt time and reducing the downtime. For setting, use Startup setting.

Reference: ▶ Setting the Start-up Status "Startup Setting" (p.133)

1. On the Main screen, tap the [System] menu - [Controller] - [Startup setting].

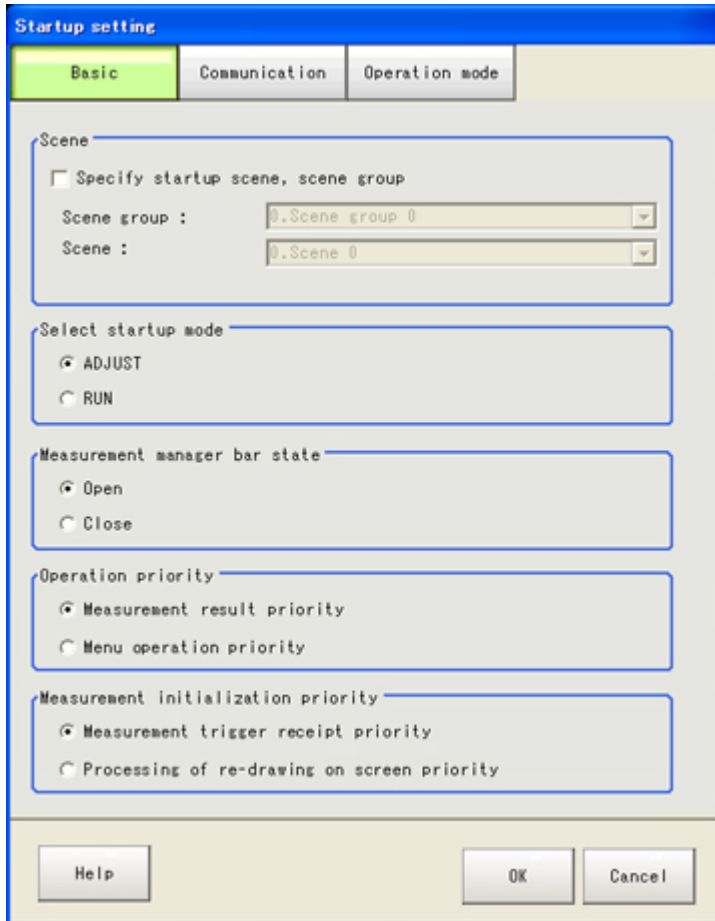

2. Tap [Operation mode].

3. Tap [▼] and select a desired operation mode.



4. Tap [OK].
5. On the Main screen (ADJUST window), tap [Data save] in the toolbar to save the setting data.



6. On the Main screen, tap [System] menu - [Controller] - [System restart].
The System Restart window is displayed.
7. Tap [OK].



Operation Mode Selection Guidelines

This section describes how to set an operation mode suitable for your specific purpose.

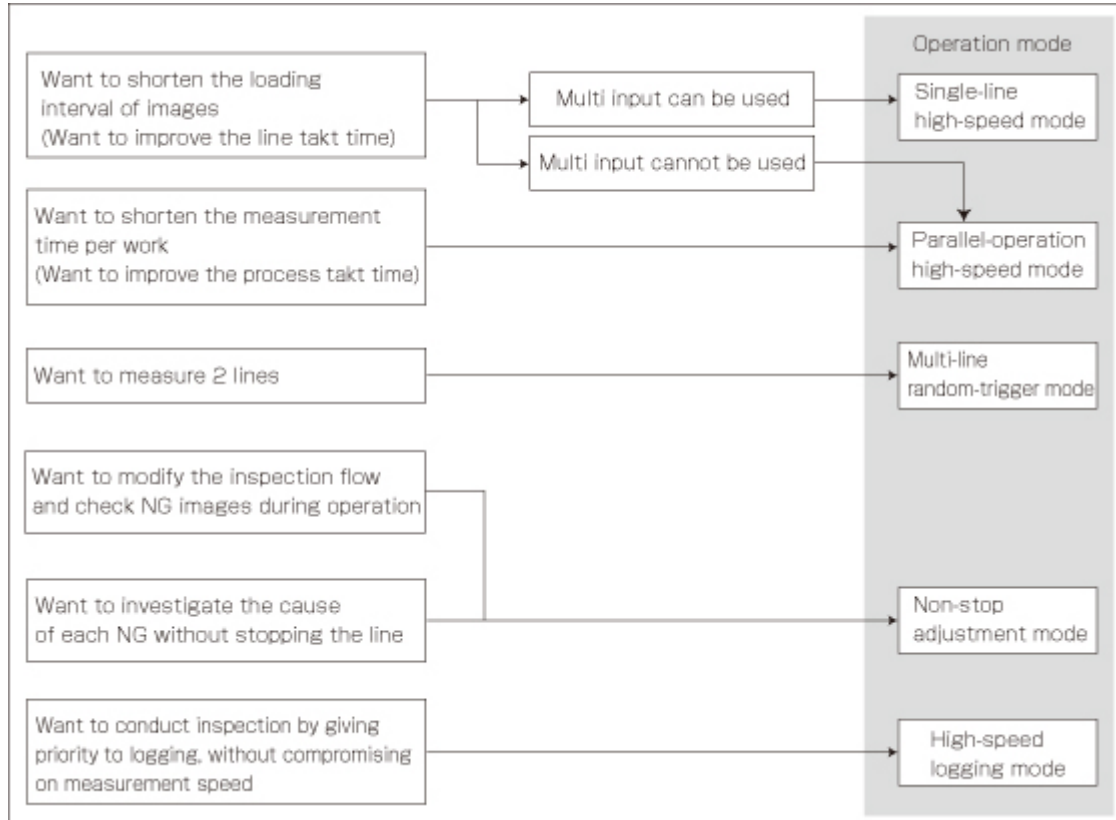

[Note 1]: Reference: ▶ About Multiple Image Input Function (p.228)

High-speed Logging Mode

Normally one CPU is used to perform measurement, image logging and image display. The FZ3-9 □□ / H9 □□ series performs processing using two CPUs, with one CPU used exclusively for measurement and the other performing non-measurement processing. This ensures maximum measurement performance at all times.

Parallel-operation High-speed Mode

Two CPUs are used to share and process measurement tasks internally. Processing is executed in parallel to shorten the measurement time to maximal 50%.

Parallel processing is performed for each processing unit to shorten the total processing time.

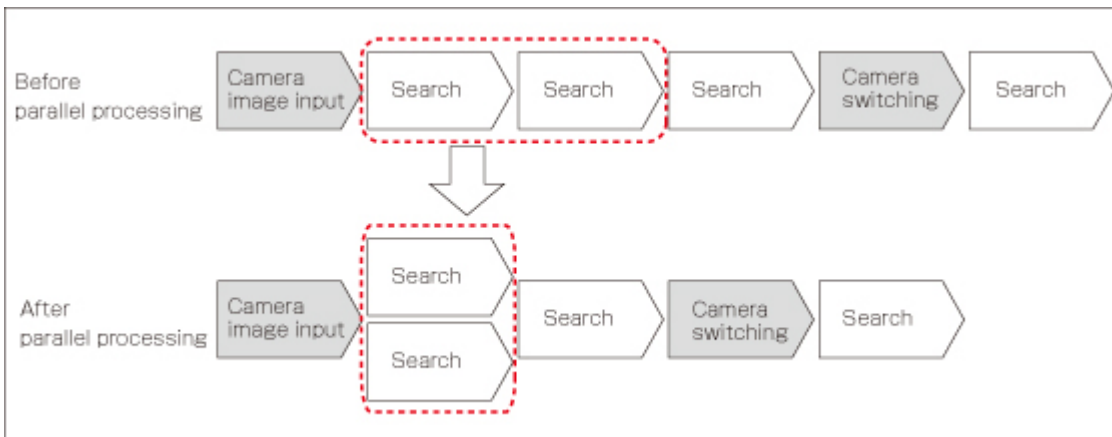
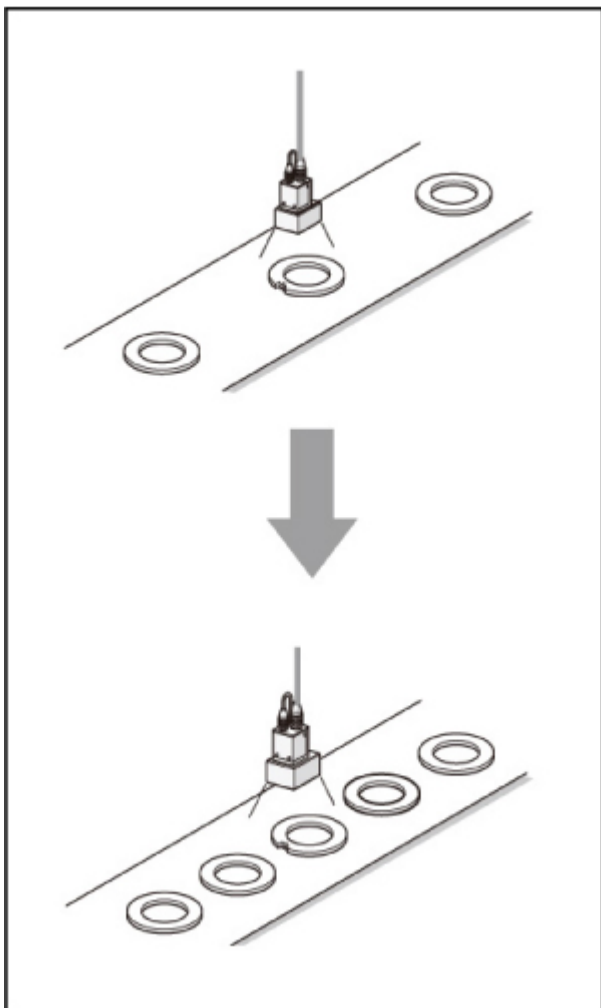

Processing items supporting the aforementioned parallel processing are specified below. You can improve the takt time effectively by combining the applicable units using an ingenious processing flow.

-: Not supported ○ : Supported

Processing item	Parallel processing	Processing item	Parallel processing	Processing item	Parallel processing
Camera image input	-	Fine matching	○	Set unit data	-
Camera image input HDR	-	Character inspection	○	Get unit data	-
Camera switching	-	Date verification	-	Set unit figure	-

Measurement image switching	-	Model dictionary	-	Get unit figure	-
Search	○	Barcodes+	○	Trend monitor	-
Flexible search	○	2D codes+	○	Image logging	-
Sensitive search	○	Circle angle	○	Data logging	-
ECM search	○	Position compensation	-	Elapsed time	-
EC circle search	○	Trapezoidal correction+	-	Wait	-
Shape search+	○	Filtering	-	Conditional branch	-
Classification	○	Background suppression	-	End	-
Edge position	○	Color gray filter	-	DI branch	-
Edge pitch	○	Color extraction filter	-	Data output	-
Scan edge position	○	Anti color shading	-	Parallel data output	-
Scan edge width	○	Stripes removal filter+	-	Parallel judgement output	-
Color data	○	Halation cut+	-	Result display	-
Gravity and area	○	Panorama+	-	Display image file	-
Labeling	○	Polar transformation	-	Display last NG image	-
Label data	-	Calculation	-	Focus	○
Labeling+	○	Line regression	-	Iris	○
Defects	○	Circle regression	-		
Precise defect	○	Calibration+	-		

Reference

- Depending on the processing unit, the processing speed of the unit itself can be raised.

Single-line High-speed Mode

Measurement is performed using 2 CPUs, which means that compared to conventional models twice the number of measurement targets can be inspected in the same time. In this Single-line High-speed Mode, CPU0 and CPU1 execute the same inspection flow alternately for each STEP input, to improve the multiple image input performance and reduce the takt time to as much as one half.

Reference: ▶ About Multiple Image Input Function (p.239)

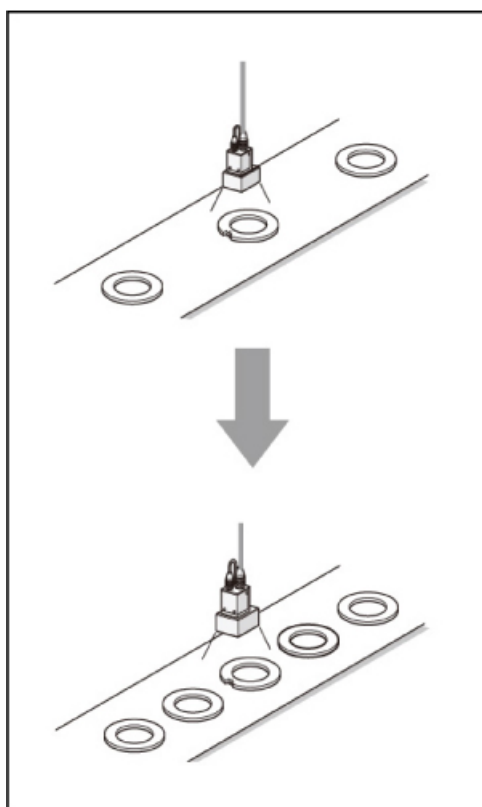

Important

- The time needed to measure one work is shorter when [Parallel-operation High-speed mode] is selected.
- [Single-line High-speed mode] is only effective when the multiple image input function is used. If the multiple image input function cannot be used, consider using [Parallel-operation High-speed mode].
Reference: ▶ About Multiple Image Input Function (p.239)
- Presence of certain processing items such as [Data Output], [Parallel Data Output] and [Parallel Judgement Output] in the first half of the flow may cause the performance to drop when [Single-line High-speed mode] is selected. If the performance drops markedly, consider using [Parallel-operation High-speed mode].
- In the Single-line High-speed Mode, certain processing items such as [Trend Monitor] and [Display Last NG Image] may not function properly. Do not use these items. Also with the processing item [Calculation], calculations that use values in previous steps do not function properly.
- When [Single-line High-speed mode] is selected, [Enter simplified non-stop adj.] cannot be used.
- The functions to set/get measured values using external commands do not operate correctly. Do not use these items.

1 CPU

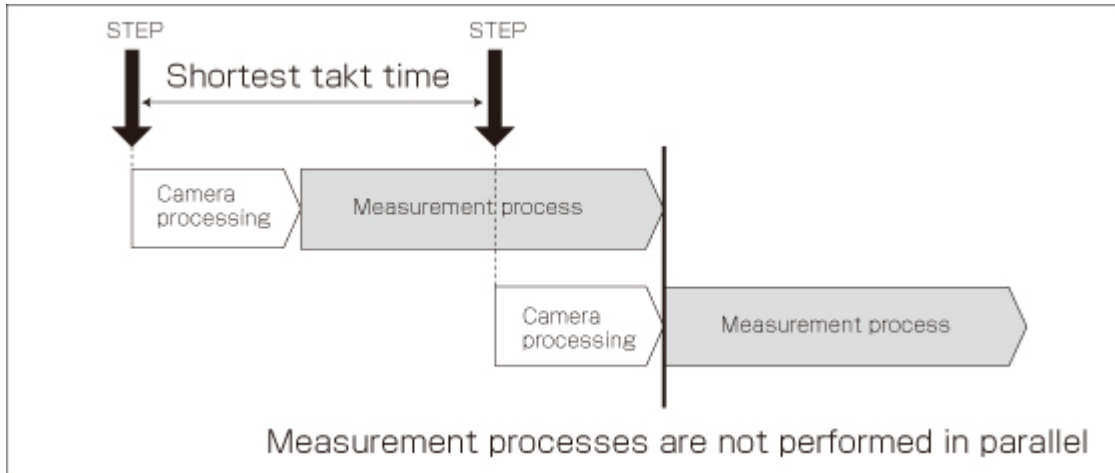

2 CPUs (FZ3-9 □□ /H9 □□ only)

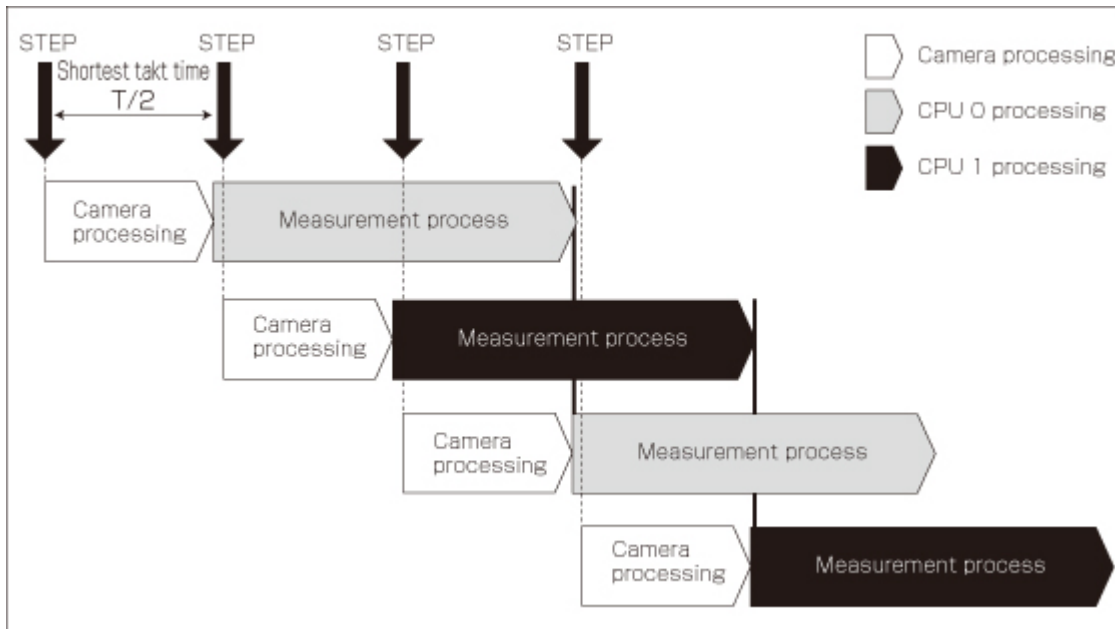

Multi-line Random-trigger Mode

Use this mode if you want to measure 2 lines using 1 controller. Measurement can be performed independently on line 0 and line 1 in response to inputs from different cameras.

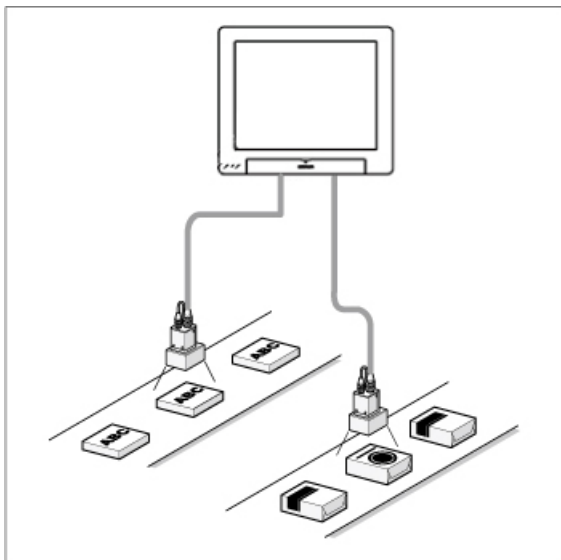

You can switch the monitoring target between line 0 and line 1 using the Line button in the Image display setting area.

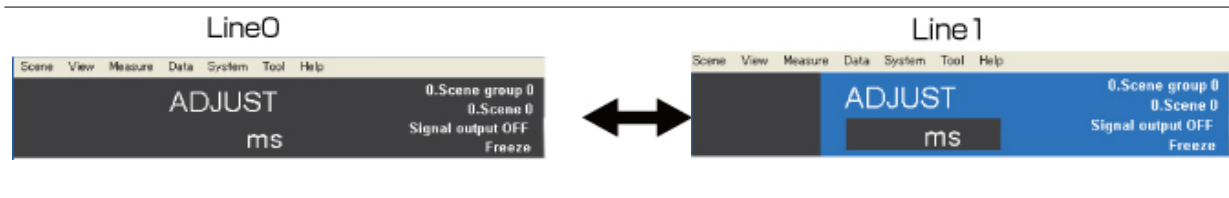
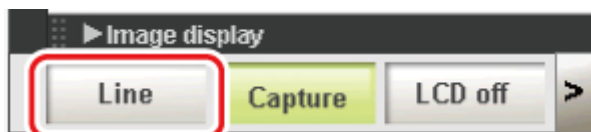

Camera No.	Recognition in software
Camera 0	Camera 0 on line 0
Camera 1	Camera 0 on line 1
Camera 2	Camera 1 on line 0
Camera 3	Camera 1 on line 1

Important

- If Ethernet is used, set a different port number for each line.
- RS-232C/422 can be set at line 0 only.
- If parallel communication is used, the I/O format changes.
Reference: ▶ I/O Format (Parallel Interface) (p.224)
- Parallel communication can only be set at line 0. Line 1 uses the settings of line 0.
- Date-time setting, language setting and operation mode setting can be set at line 0 only.
- If STEP is input to line 0 and line 1 at exactly the same time, measurement on one side may be delayed (approximately by a time corresponding to the camera image input unit).
- Error messages are the same. If an error occurs on either line, an error message is displayed.
- If logging is performed for line 0 and line 1 at the same time, measurement may take a longer time.
- User data of line 1 is saved in the controller.

Non-stop Adjustment Mode

The measurement flow can be changed and adjusted during operation without stopping the measurement process.

Set images using saved image files. The modified measurement flow can be reflected during operation.

Utilization example of non-stop adjustment

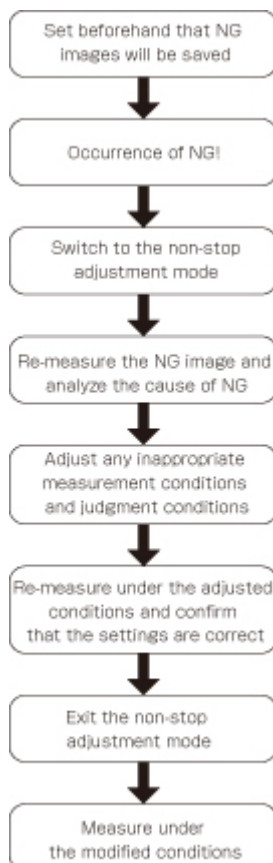

1. In the "Control" area of the Main screen (RUN window), tap [Tool box].
2. Tap [Enter non-stop adj.].
Transfers to non-stop adjustment mode. Measurement will continue without stopping.



3. Tap the icon of the processing unit to be adjusted.
To change the flow, do so by selecting [Edit flow] in the toolbar.

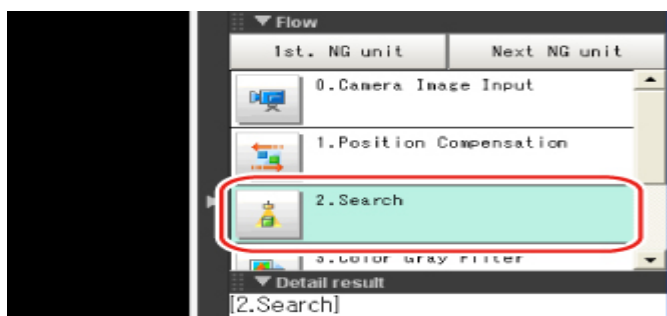

The setting window for the selected unit appears.

4. Change each processing unit.

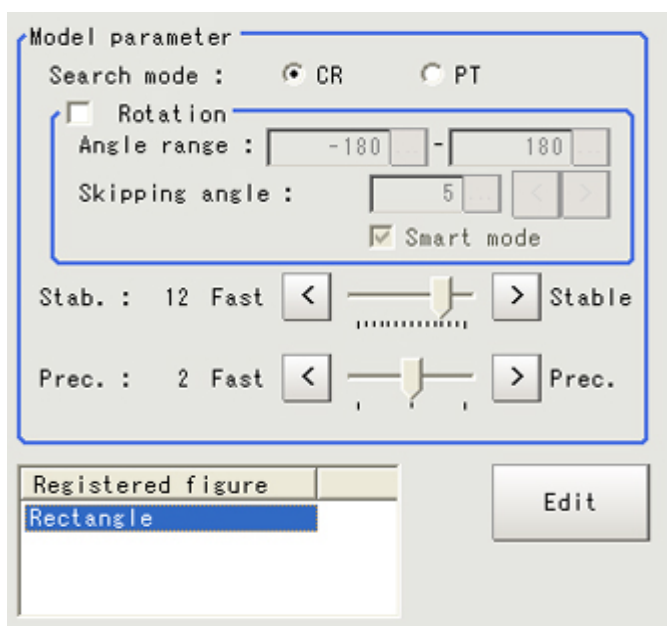

5. Tap [OK].
The setting window closes, and the screen returns to the Main screen.
When changing judgement conditions for multiple processing units, repeat steps
Reference: ▶ 3 (p.39) to Reference: ▶ 5 (p.39) .
The changes are not yet reflected at this point.
6. Tap [Transfer data] in the toolbar on the Main screen.
The changes are reflected.

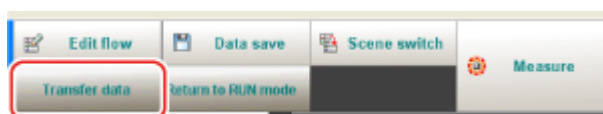

7. Tap [Return to RUN mode] in the toolbar on the Main screen.

The screen returns to the RUN window.



Important

- When [Transfer data] is executed, the results of [Trend Monitor] and [Expression], etc. are cleared.
- If the scene or scene group was switched or any setting of a processing unit was changed during operation using an external command, the result is not yet reflected when you switch to the non-stop adjustment window.
- If non-stop adjustment is performed after changing the scene group during operation, scene group data may be overwritten against your wish.
- Measurement commands (parallel, non-procedure, PLC link) and continuous measurement commands (parallel only) are the only communication commands that are accepted during data transfer.
- Data transfer takes a longer time when the scene group file size is larger.
- If the RUN window is displayed in the fast view mode, non-stop adjustment cannot be performed.
- Communication settings cannot be changed on the non-stop adjustment window.
- Do not register any new camera image input unit on the non-stop adjustment window.
- If RAMDisk does not have enough free disk capacity, data may not be transferred. Specify an image logging destination other than RAMDisk or otherwise set applicable items to minimize the usage of RAMDisk.
- Performing non-stop adjustment changes the display mode to freeze.
- If image logging is performed in the non-stop adjustment mode, data transfer may be disabled. To prevent this from happening, set the trigger interval longer than the logging time.

Setting Scenes (Measurement Flow)

A measurement flow consisting of a series of combined processing items is called a scene. This chapter explains how to create and edit scenes.

- ▶ Reference: What Is a Scene? (p.42)
- ▶ Reference: What Is a Scene Group? (p.46)
- ▶ Reference: Creating a Scene (p.47)
- ▶ Reference: Processing Item Selection Guidelines (p.49)
- ▶ Reference: Editing Processing Units in Scenes (p.63)
- ▶ Reference: Switching Scenes and Scene Groups (p.65)
- ▶ Reference: Editing Scenes (p.67)
- ▶ Reference: Editing Scene Groups (p.70)

What Is a Scene?

Processing items for use with various measurement objects and measurement objectives are provided in this product. By combining and executing these processing items, measurement adapted to the purpose can be implemented. A combination of processing items is called a "scene" and scenes can be easily created by combining processing items that are suited to the measurement purpose from the list of processing items provided.

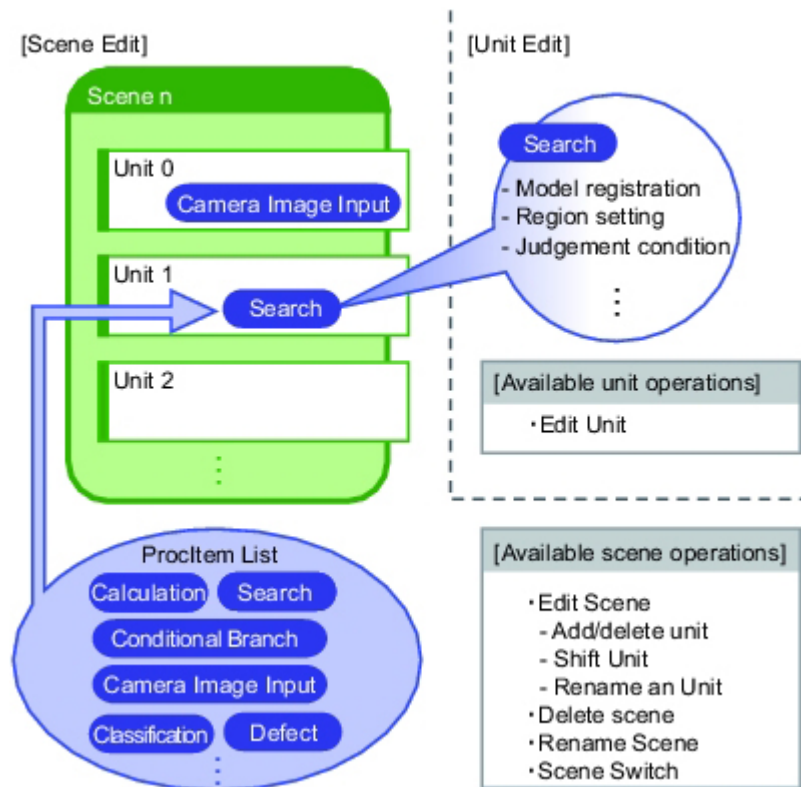

Changing the set-up using the scene function

Multiple scenes can be created. For example, by creating scenes for each measurement object such as using "Scene 0" to inspect an "ABC" label and "Scene 1" to inspect an "XYZ" label, changing the set-up can be performed smoothly just by changing the scene even when the measurement object and measurement objective have changed.

Reference: ▶ Switching Scenes and Scene Groups (p.65)

Up to 32 scenes can be set. In case where over 32 scenes are required, these can be divided into scene groups for easier management.

Reference: ▶ What Is a Scene Group? (p.46)

Scene Examples

The processing items registered to the scene are called processing units. In the Edit Flow window where scenes are created, select processing items required for measurement and add them to the flow. The number at the top of the processing unit is called the "Unit No.". If the measurement trigger is activated, processing is executed in the numerical sequence of the processing unit numbers.

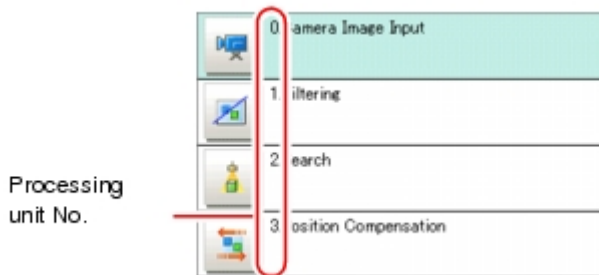

Example) Normal measurement

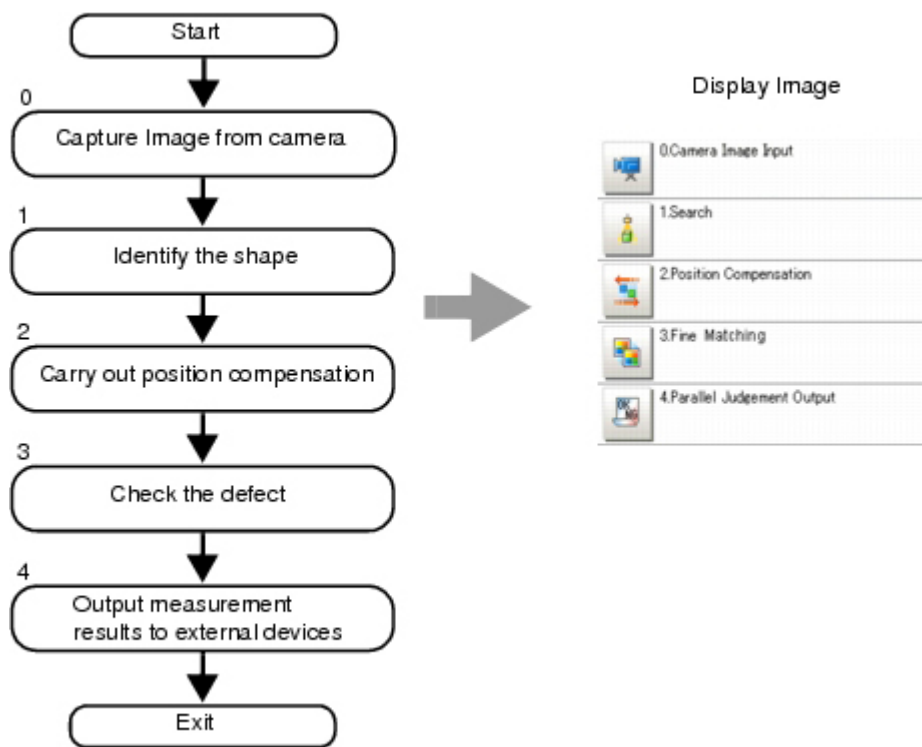

Note

- The processing item "Camera Image Input" is set in processing unit 0 beforehand.

Example) When adding Position Compensation for two measurement objects in the same field of view

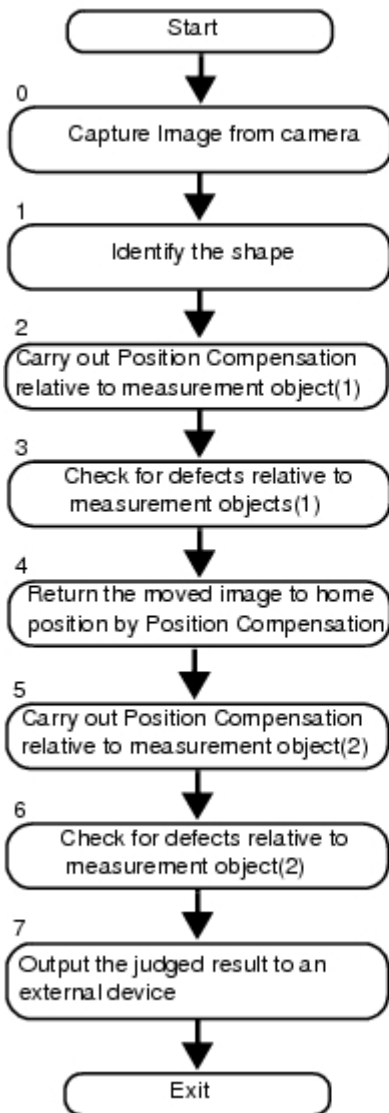
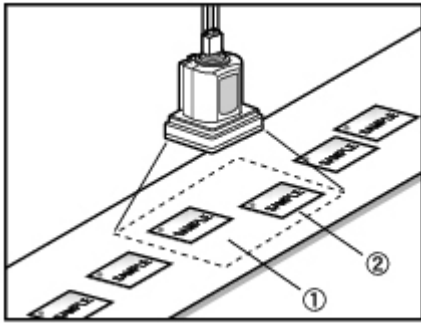

Display Image	
	0.Camera Image Input
	1.Search
	2.Position Compensation
	3.Fine matching
	4.Position Compensation
	5.Position Compensation
	6.Fine Matching
	7.Parallel Judgement Output

Example) When judging type from the image and dividing later inspection conditions according to type (branch processing)

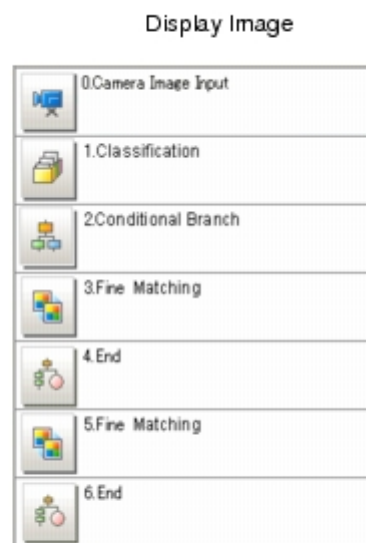
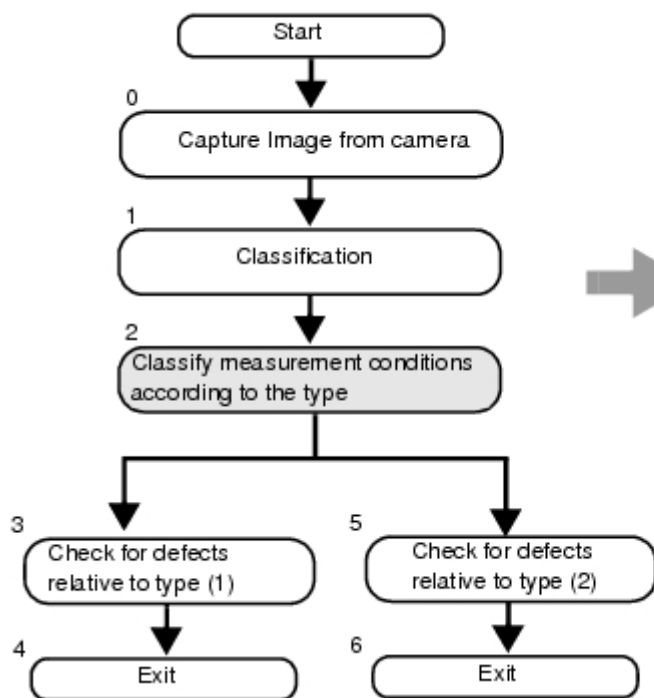
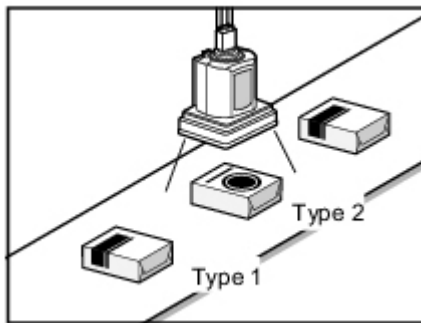

What Is a Scene Group?

A "scene group" refers to a grouping of 32 individual scenes. Creating a scene group is convenient when increasing the number of scenes and when managing a number of scenes according to category. USB memory is required for creating a scene group. Scene group 0 is saved in the controller while scene groups 1 to 31 are saved in USB memory. (For FZ3-9 □□ /H9 □□ , all data are saved in the controller.)

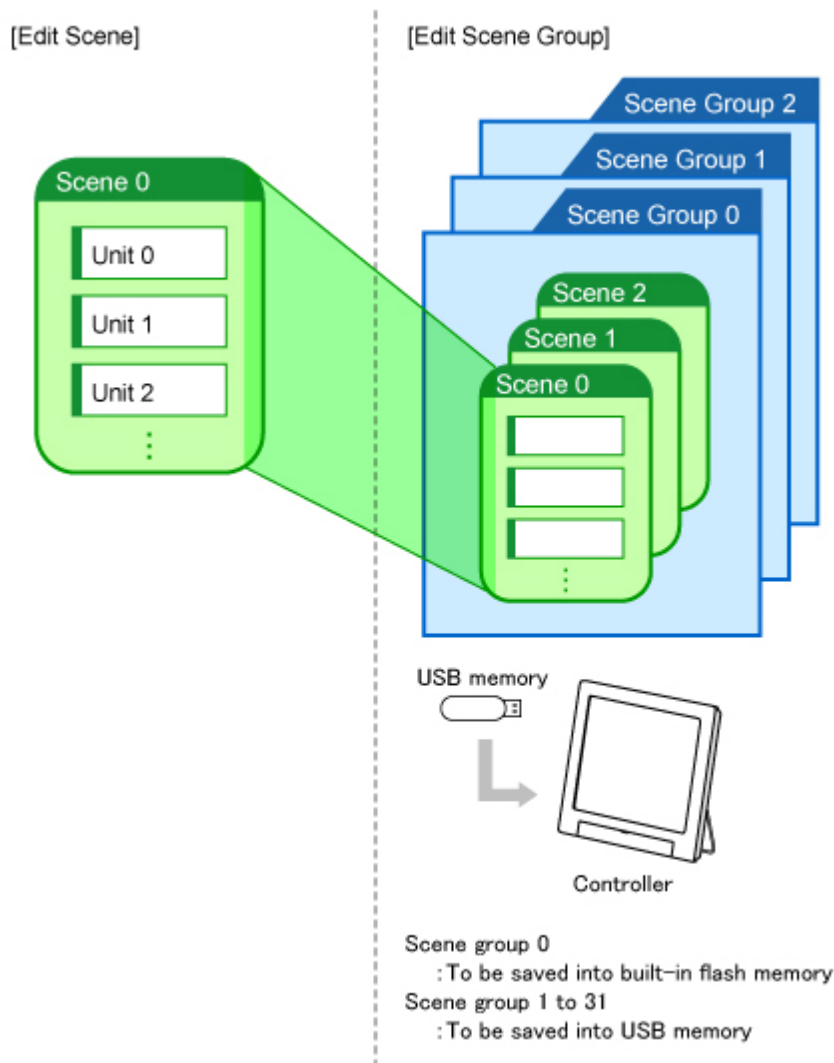

Note

- The maximum number of scenes that can be used is 1024. 32 scenes are handled as 1 scene group, and up to 32 scene groups can be set. In other words, 32 scenes x 32 scene groups = 1,024 scenes, which is the maximum number that can be used.
- There are multiple USB ports on the controller, but it is necessary to assign the drive name "USBdisk" to the USB memory in which the scene group data being used is stored. When other USB memory devices are already inserted, perform this operation after removing all USB memory devices other than the one in which the scene group data is stored.
- If the USB memory capacity is insufficient for the data size, it is possible that the number of scenes can be set is lower than 1,024. The scene data size varies depending on the contents of settings.
- The data size that can be set (available data memory) can be checked in the system menu.
Reference: ▶ Checking System Information [System Information] (p.145)

Creating a Scene

This section explains methods for adding a new processing unit to a scene.

1. Display the scene to edit on the Main screen.
Reference: ▶ Switching Scenes and Scene Groups (p.65)
2. Tap [Edit flow] in Toolbar.

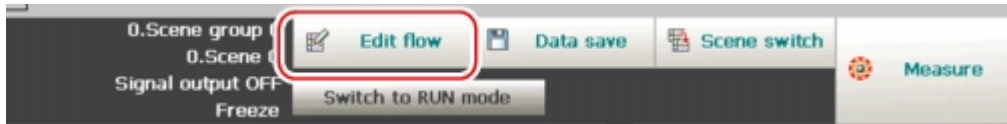

The Edit Flow window is displayed.

3. Select a processing item to be added from the processing item tree.

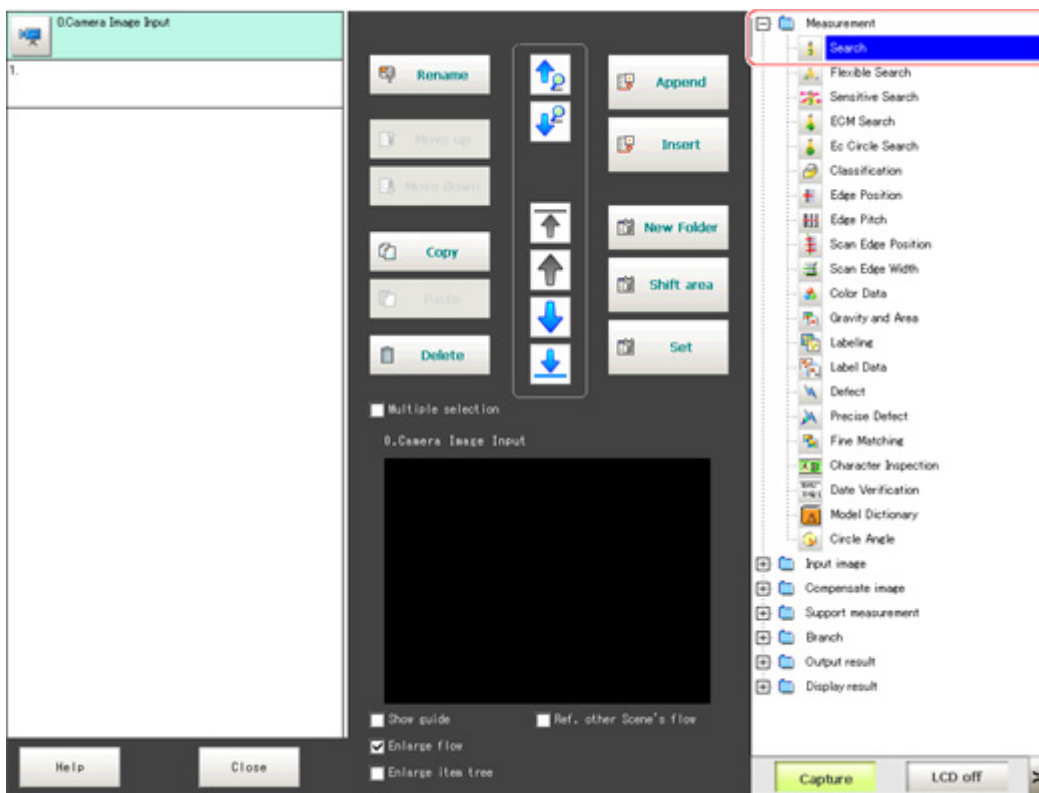

4. Tap [Append].

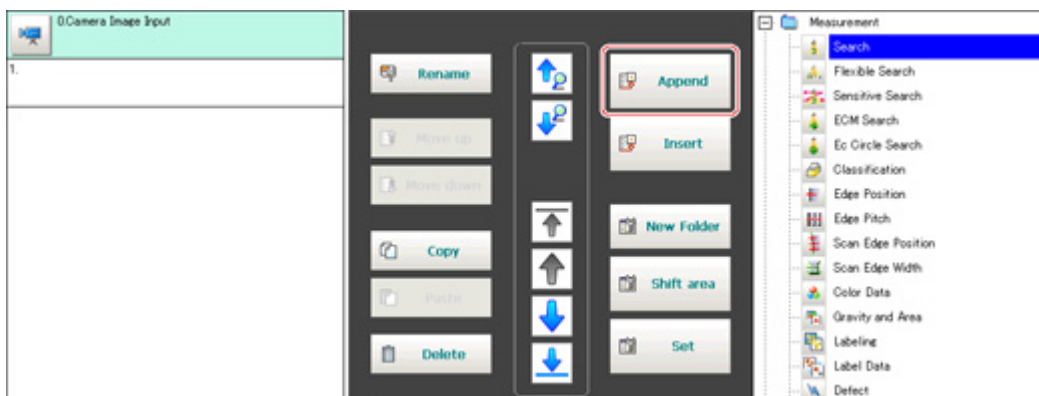

The selected processing item is appended at the bottom of the unit list (flow).

- Continue to add processing units. Repeat the steps after Reference: ▶ 3 (p.47) .

Note

- Limitations on settings
The number of image input processing items that can be used is limited.
Reference: ▶ About Limits on the Number of Image Input Processing Items Used (p.347)

- Either tap the icon of the processing unit to be set or tap the Set button.

Procltem setting button

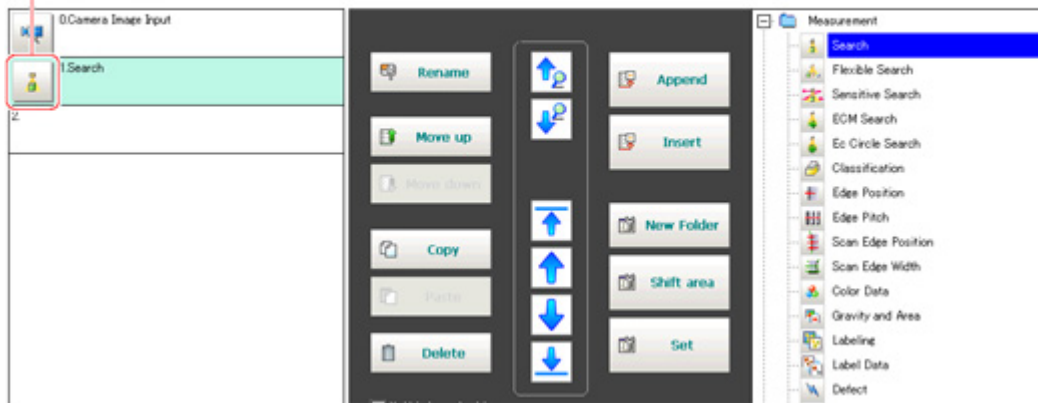

The property setting window is displayed. Set detailed conditions. The displayed contents vary depending on the processing item.

- Set conditions.
The displayed contents vary depending on the processing item.

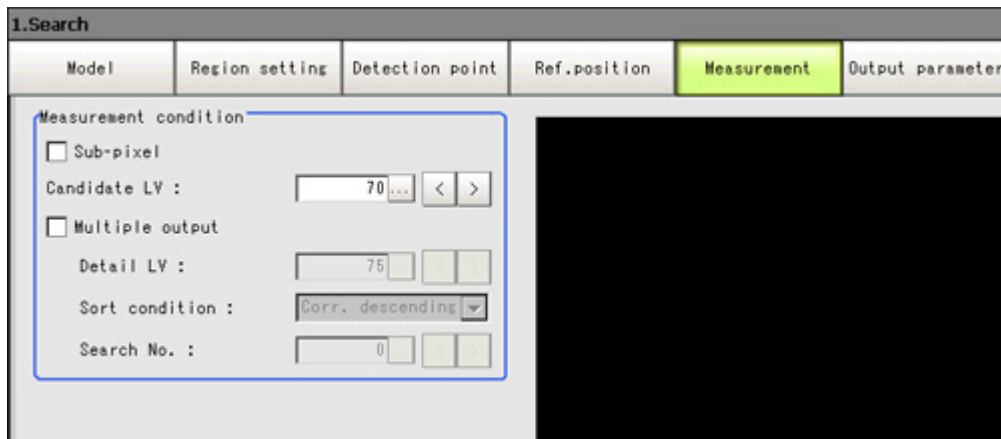

Processing Item Selection Guidelines

Processing items for performing measurement are provided with this product. Application-oriented measurement can be configured by combining processing items or changing the settings of processing items.

The method for searching for processing items appropriate to the target measurement is shown here.

- Reference: ▶ Selecting Measurement Processing Items Using a Chart (p.49)
- Reference: ▶ Selecting Measurement Processing Items According to the Measurement Method and Purpose (p.56)

Selecting Measurement Processing Items Using a Chart

Select processing items appropriate to the target using the chart.

Item	References
Performing position compensation for objects	Reference: ▶ Position Compensation (p.50)
Measuring the position of objects	Reference: ▶ Locating (Measurement Objects Not Inclined) (p.51) Reference: ▶ Locating (Measurement Objects Inclined) (p.52)
Inspecting the status of objects	Reference: ▶ Internal and External Inspection (p.52) Reference: ▶ Presence Inspection (p.53) Reference: ▶ Dimension Inspection/Measurement (p.53) Reference: ▶ Text Comparison/Inspection (p.54) Reference: ▶ Quantity Inspection/Measurement (p.55)
Inspecting for defective products	Reference: ▶ Defect/Contamination Inspection (p.55) Reference: ▶ Burr Inspection (p.54) Reference: ▶ Inspection for Presence of Different Objects (p.56)

Position Compensation

Marking for position compensation?

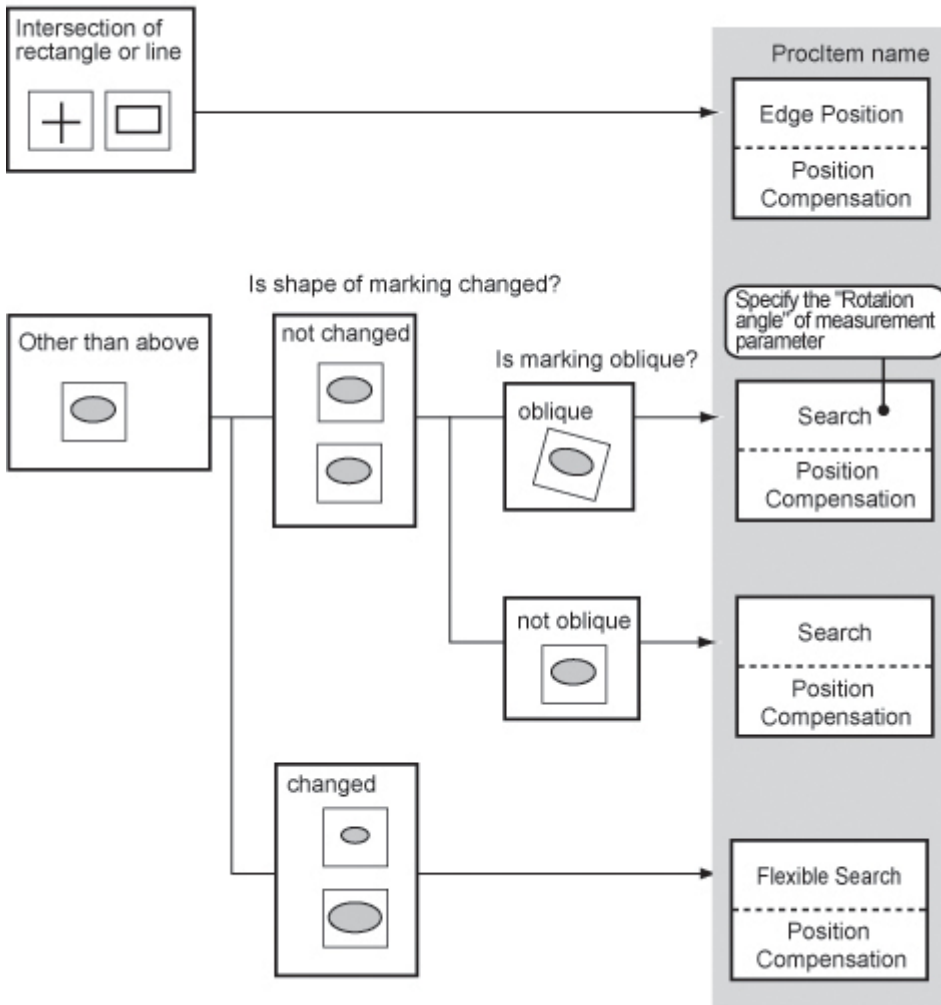

Locating (Measurement Objects Not Inclined)

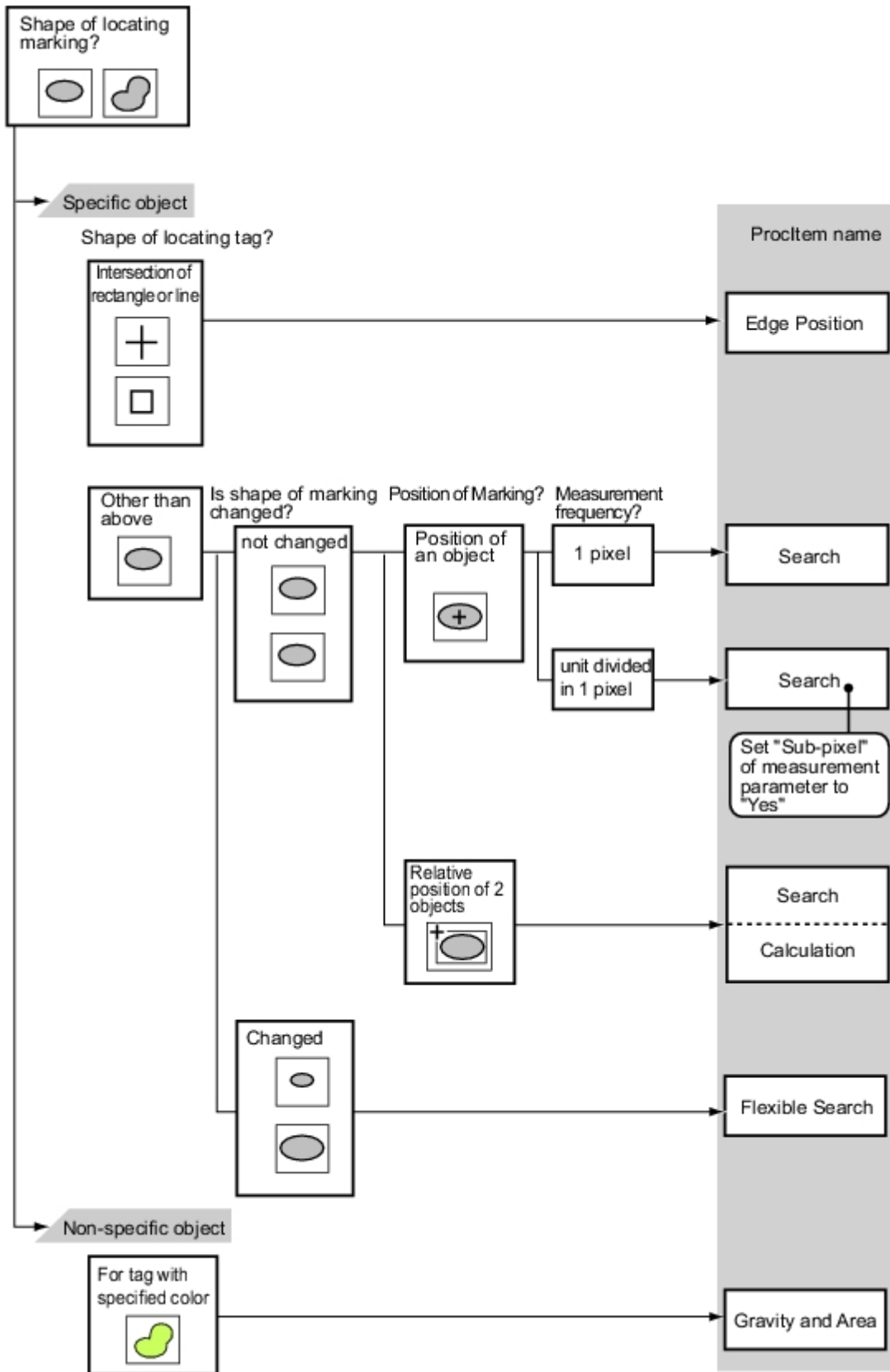

Locating (Measurement Objects Inclined)

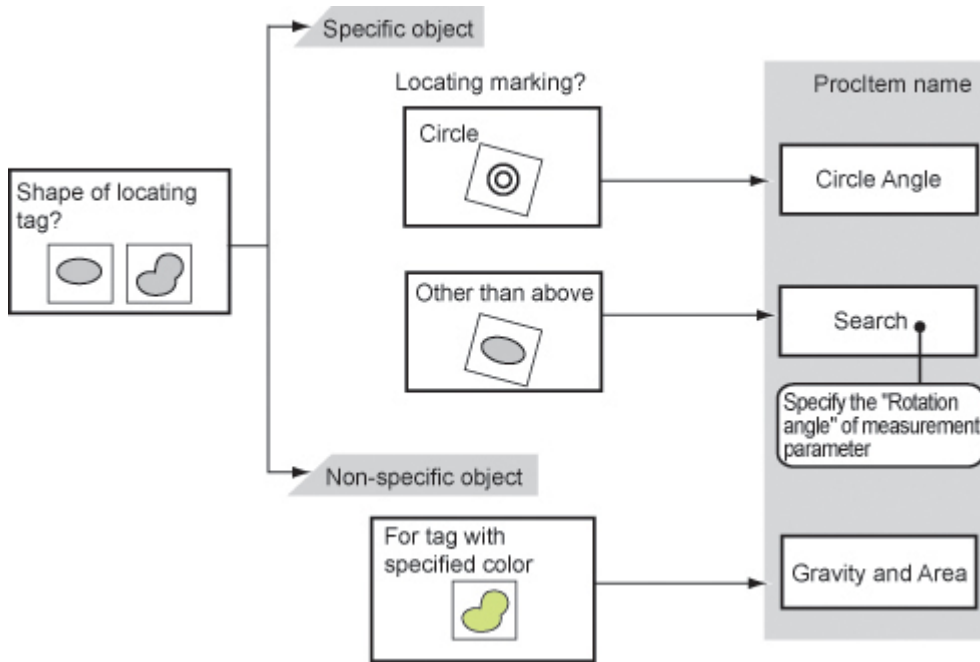

Internal and External Inspection

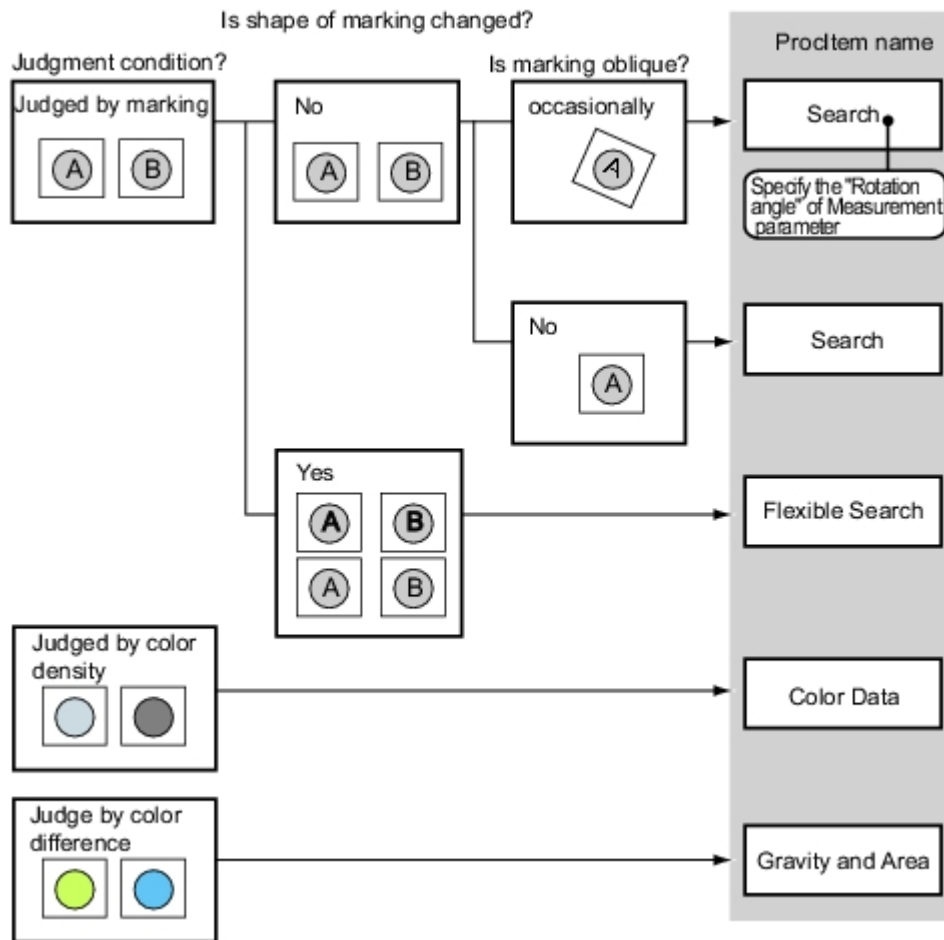

Presence Inspection

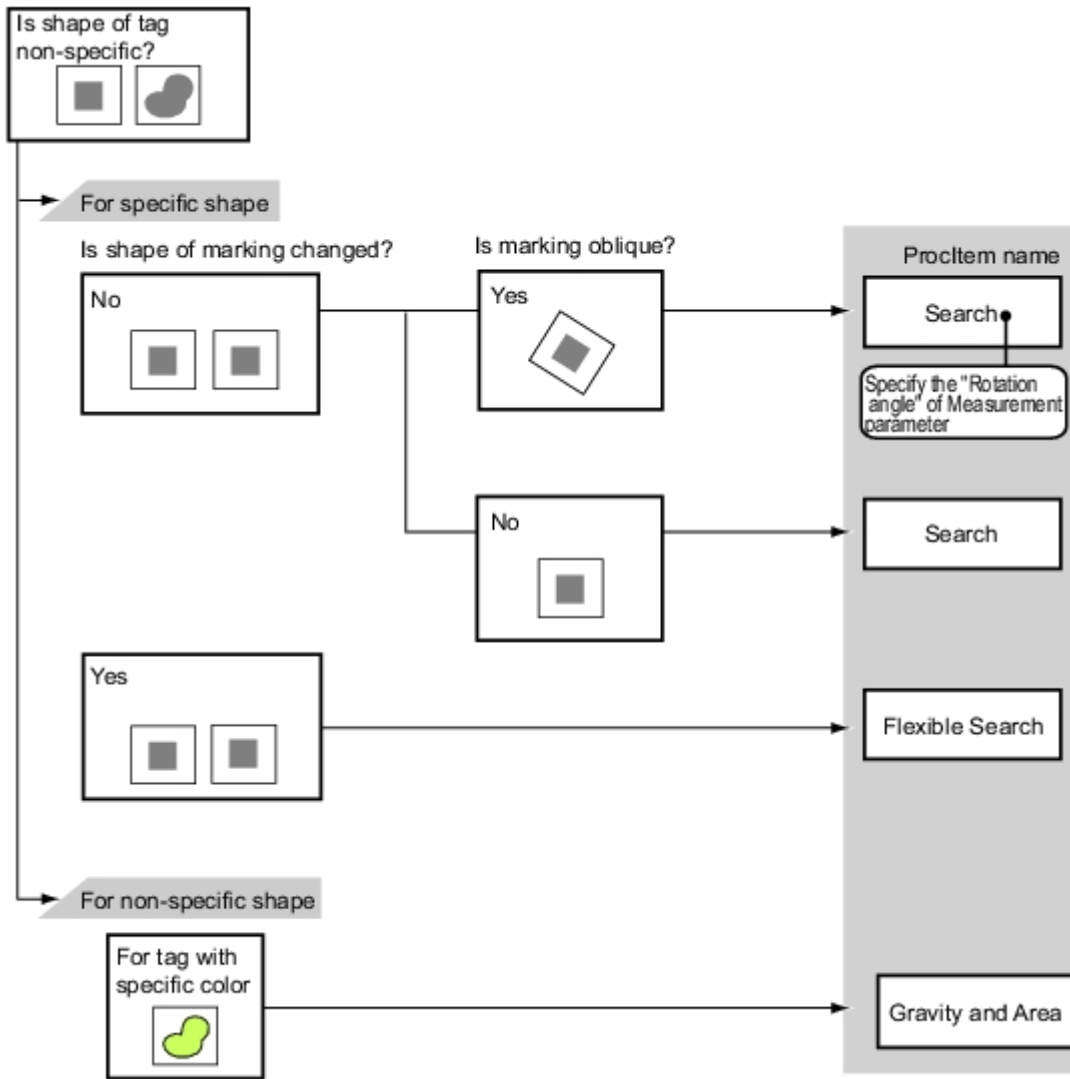

Dimension Inspection/Measurement



Burr Inspection

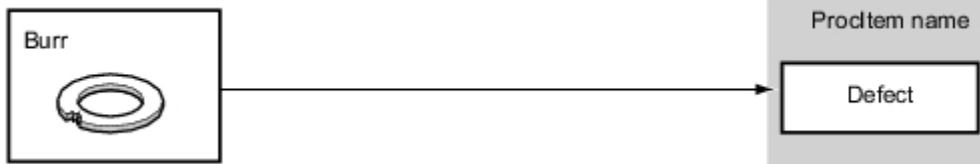

Text Comparison/Inspection

Do you want to set the date to be checked automatically?



Are the character types more than two?

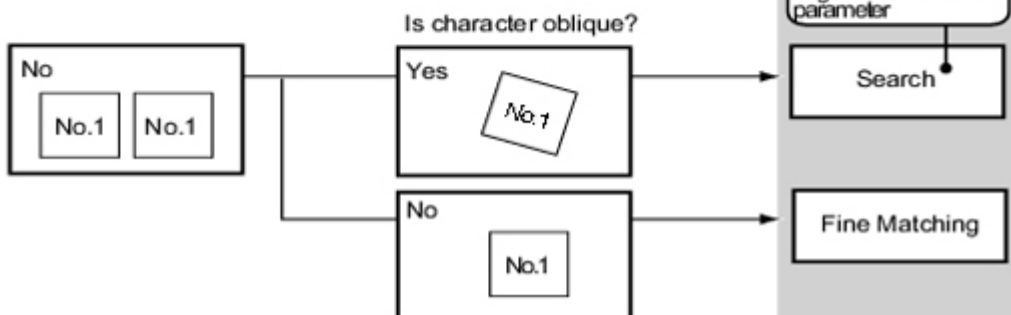
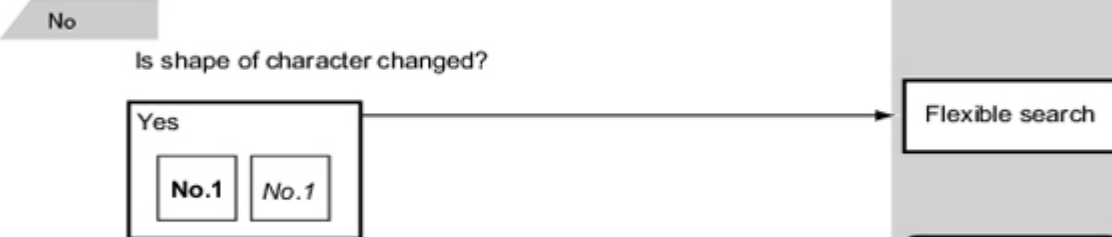

Defect/Contamination Inspection

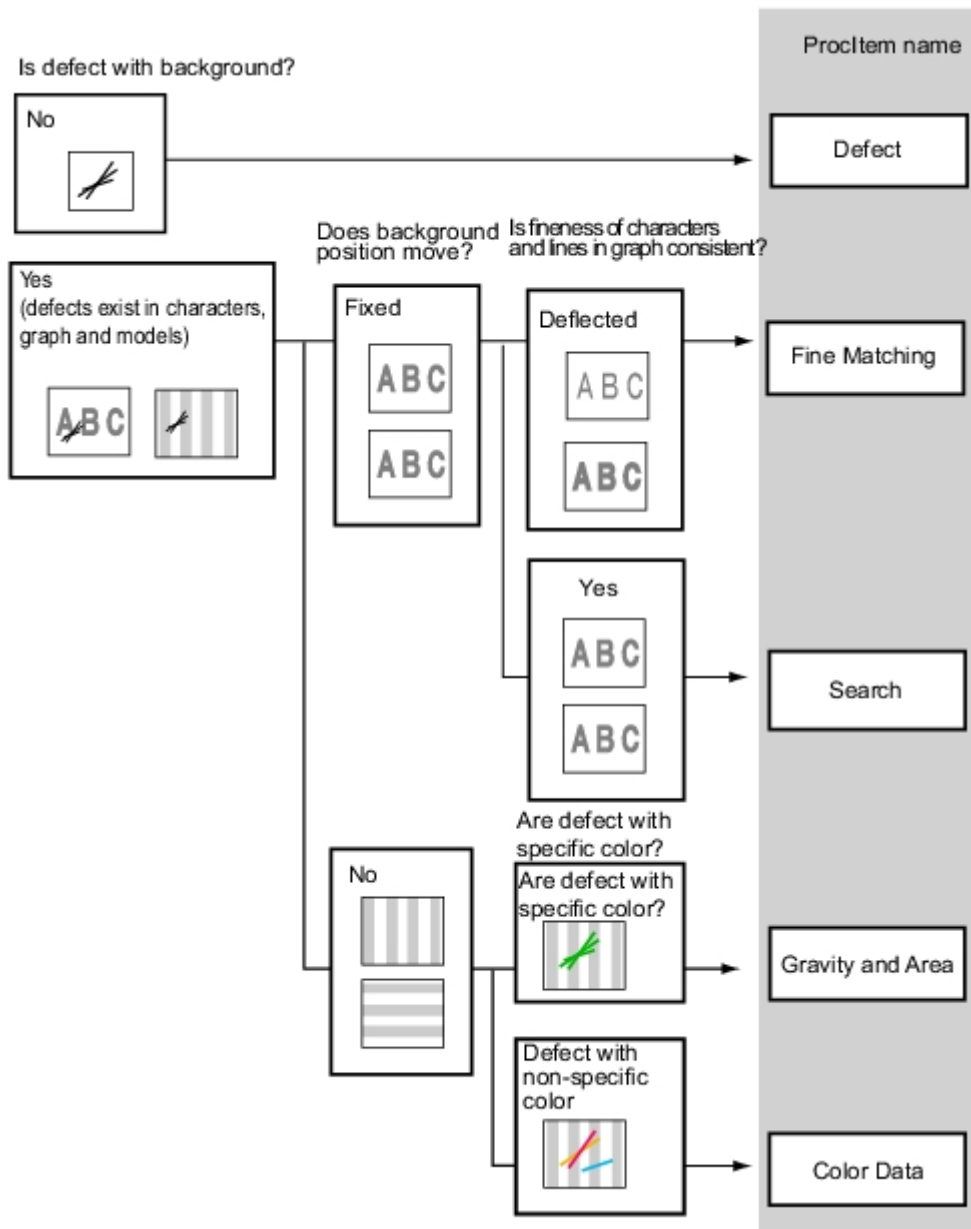

Quantity Inspection/Measurement



Inspection for Presence of Different Objects

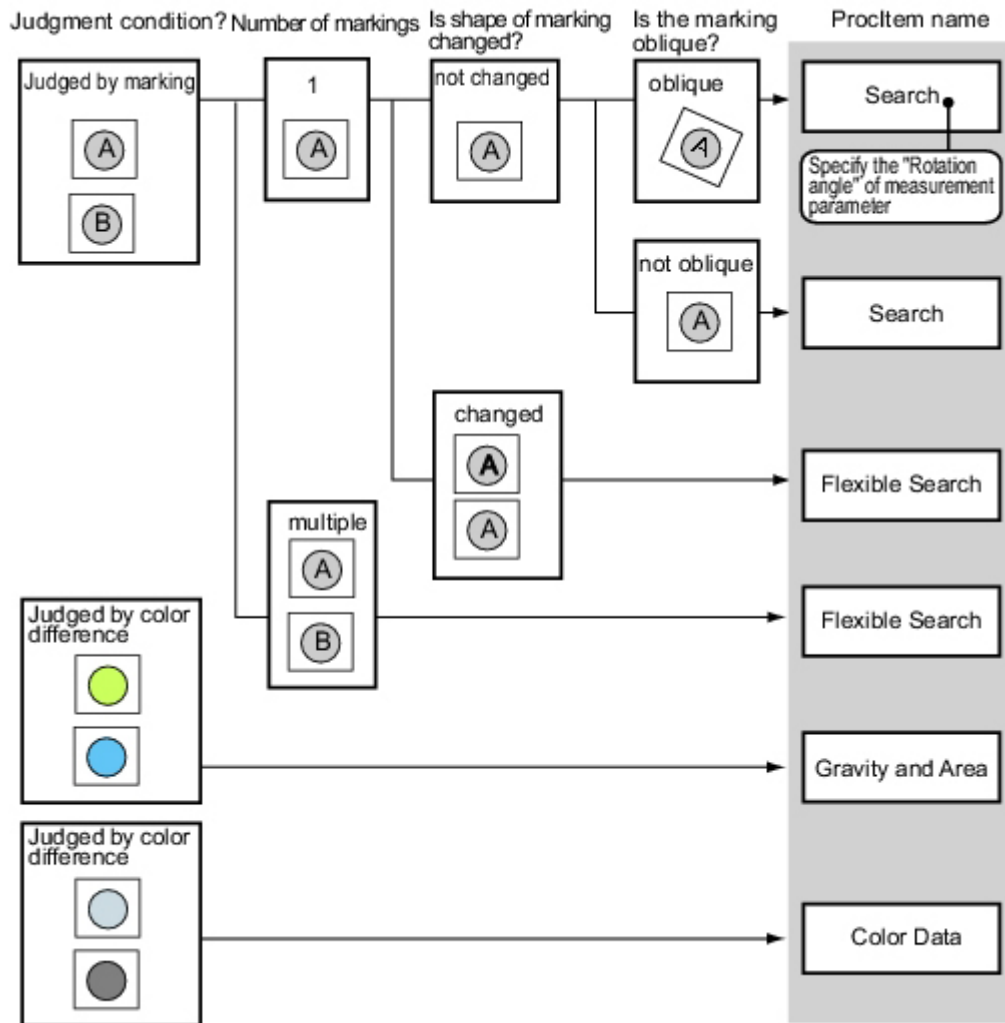

Hole Position Measurement



Selecting Measurement Processing Items According to the Measurement Method and Purpose

This section describes methods for selecting processing items appropriate to different measurement objectives such as counting quantities, checking for deformation, and checking for contamination.

- Reference: ▶ Measuring positions (p.57)
- Reference: ▶ Detecting defects and foreign materials (p.58)
- Reference: ▶ Count (p.59)
- Reference: ▶ Measuring dimensions (p.59)

- Reference: ▶ Measuring folding of papers and sheets (p.60)
- Reference: ▶ Checking the interior/exterior and direction (p.60)
- Reference: ▶ Checking for mixing of different objects (p.61)
- Reference: ▶ Checking for deformation (p.61)
- Reference: ▶ Inspecting characters (p.62)
- Reference: ▶ Reading barcodes (p.62)
- Reference: ▶ Reading 2D codes (p.62)
- Reference: ▶ Increasing camera installation efficiency (p.62)

Measuring positions

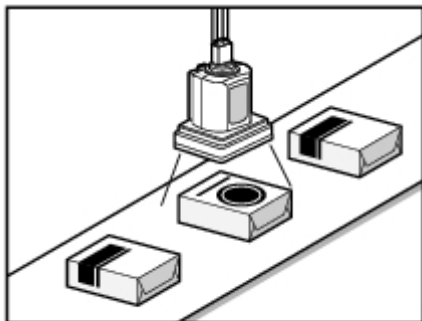
Method, objective	References
Positioning of the measurement objects with low contrast	[ECM Search], [Shape Search+ (FZ3-Hxxx series)] Effective for positioning measurement objects, such as LCD substrates, glass substrates, and sheets, which have low contrast and in which color differences at measurement locations are not obvious. Reference: ▶ "Processing Item List Manual", "ECM Search" (p.79) Reference: ▶ Processing Item List Manual, "Shape Search+" (p.100)
Label position detection	[Edge Position] Effective for detecting whether the label position is off-center, raised or lowered, and whether the label is affixed on bottles and cans. Reference: ▶ "Processing Item List Manual", "Edge Position" (p.120)
Robot arm positioning	[Search] Effective for position measurement that includes tilting of the measurement object due to handling with robot arms. Reference: ▶ "Processing Item List Manual", "Search" (p.48)
Position measurement for measurement objects with variations	[Flexible Search] Effective for position measurement of measurement objects in which there are variations in markings or shape such as with inspection of packaging, etc. Reference: ▶ "Processing Item List Manual", "Flexible Search" (p.59) <div style="text-align: center;">  <p>Position measurement</p> </div>
Measurement of the inclination of a circular measurement object	[Circle angle] Effective when measuring bottle caps, etc., after correcting the rotation angle. Reference: ▶ "Processing Item List Manual", "Circle Angle" (p.282)

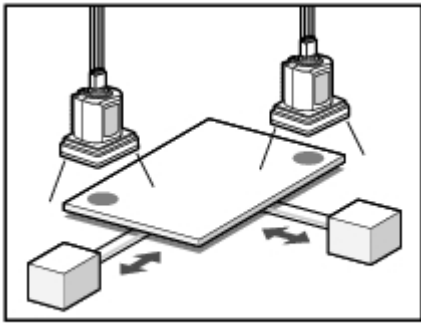
Other positioning	<p>[Search] If the shape and background of the measurement object are constant, a processing item such as one that registers an image as a model and searches for this image is effective. Reference: ▶ "Processing Item List Manual", "Search" (p.48)</p>  <p style="text-align: center;">Locating of reference mark of base plate</p>
-------------------	--

Detecting defects and foreign materials

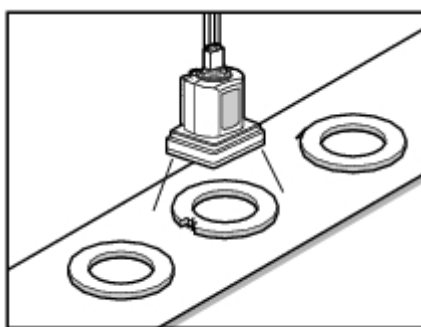
Method, objective	References
Detection of the defect, stain and spot of plain measurement objects	<p>[Defect] [Precise Defect (FZ3-Hxxx series)] Effective for inspection for contamination or spots on plain backgrounds. Reference: ▶ "Processing Item List Manual", "Defect" (p.215) Reference: ▶ "Processing Item List Manual", "Precise Defect" (p.223)</p>
Scratches, burrs	<p>[Defect] [Precise Defect (FZ3-Hxxx series)] Effective for exterior inspection of scratches and burrs on parts. Reference: ▶ "Processing Item List Manual", "Defect" (p.215)</p>  <p style="text-align: center;">Defect/Burr measurement</p> <p>Reference: ▶ "Processing Item List Manual", "Precise Defect" (p.223)</p>
Inspection for minor defects, contamination and objects with backgrounds other than plain	<p>[Fine Matching] Effective for detection of minor defects and contamination on labels, etc. Reference: ▶ "Processing Item List Manual", "Fine Matching" (p.231)</p>

Count

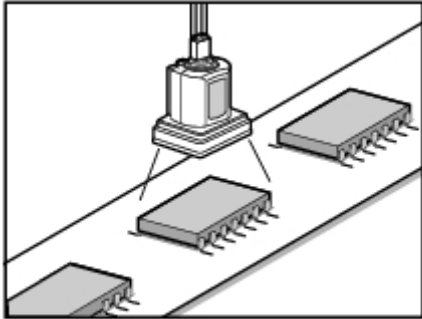
Method, objective	References
Inspection for number of pins	<p>[Edge Pitch] Effective when calculating the number of IC or connector pins. Reference: ▶ "Processing Item List Manual", "Edge Pitch" (p.130)</p>  <p style="text-align: center;">Measuring number of IC pins</p>
Inspection of the number of screws	<p>[EC Circle Search] Effective when inspecting by focusing on circular outline information. Reference: ▶ "Processing Item List Manual", "EC Circle Search" (p.90)</p>
Inspection of the number of labels	<p>[Labeling] [Labeling+ (FZ3-Hxxx series)] Effective when counting the labels and measuring their positions. Reference: ▶ "Processing Item List Manual", "Labeling" (p.178) Reference: ▶ "Processing Item List Manual", "Labeling+" (p.196)</p>

Measuring dimensions

Method, objective	References
Measurement of width of measurement objects	<p>[Edge Position] Effective when measuring the width of measurement objects. Reference: ▶ "Processing Item List Manual", "Edge Position" (p.120)</p>
Dimension inspection of finished products	<p>[Edge Position] [Calculation] To measure the dimensions of finished products, combine [Edge Position] and [Calculation]. Use [Edge Position] to measure position, and [Calculation] to calculate dimensions by calculating the distance between positions. Reference: ▶ "Processing Item List Manual", "Edge Position" (p.120) Reference: ▶ "Processing Item List Manual", "Calculation" (p.338)</p>
Dimension inspection for circular shapes and tilted parts	<p>[Edge Position] [Calculation] [Edge Position] is effective when measuring the dimensions of circular works and tilted measurement objects. Use this processing item to measure position, [Calculation] to calculate the spacing of positions and then the dimensions. Reference: ▶ "Processing Item List Manual", "Edge Position" (p.120) Reference: ▶ "Processing Item List Manual", "Calculation" (p.338)</p>

Measuring folding of papers and sheets

Method, objective	References
Check for folding on plain measurement objects	[Defect] [Precise Defect (FZ3-Hxxx series)] Effective when checking for folding on plain works. Reference: ▶ "Processing Item List Manual", "Defect" (p.215)

Checking the interior/exterior and direction

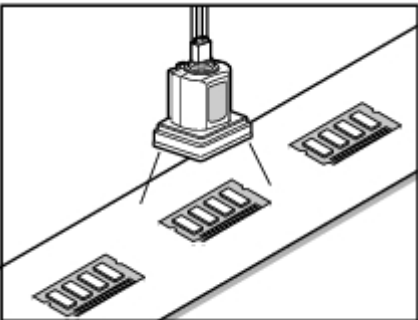
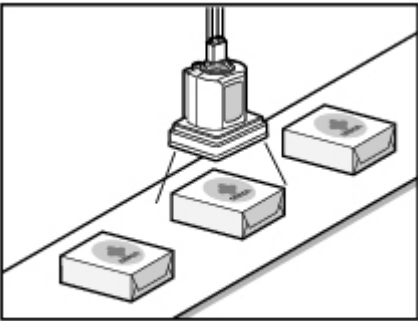
Method, objective	References
Interior/exterior and orientation inspection through presence of markings	<p>[Flexible Search] Effective when there is variation in the size and position of the markings to be checked. Reference: ▶ "Processing Item List Manual", "Flexible Search" (p.59)</p>  <p>Measuring chip components</p>
When precision is required for measurement of markings	<p>[Fine Matching] Effective when there are patterns on the background of markings, markings have a complex shape, or precision is required for measurement of markings. Reference: ▶ "Processing Item List Manual", "Fine Matching" (p.231)</p>  <p>Measuring LOG</p>

Checking for mixing of different objects

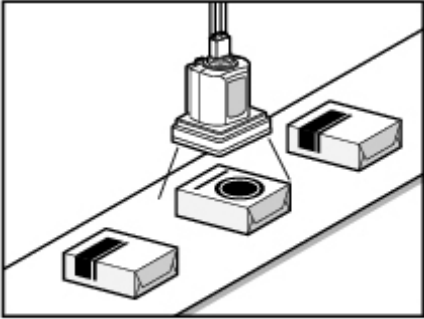
Method, objective	References
<p>Inspection for mixing of different measurement objects with variations</p>	<p>[Flexible Search] Effective for inspection of mixing of different objects in which there are variations with markings and the shape of measurement objects. Reference: ▶ "Processing Item List Manual", "Flexible Search" (p.59)</p>  <p>Disparity judge</p>
<p>Inspection for mixing of different objects for objects with plain background</p>	<p>[Search] Effective for inspection of mixing of different objects for packaging that has plain background. Reference: ▶ "Processing Item List Manual", "Search" (p.48)</p>
<p>When accuracy is required for inspection of mixing of different objects</p>	<p>[Fine Matching] Effective when precision is required for inspection of mixing of different objects such as inspection of nameplates and objects other than those with plain backgrounds. Reference: ▶ "Processing Item List Manual", "Fine Matching" (p.231)</p>
<p>When not all characters and markings are the same</p>	<p>[Sensitive Search] Effective when the difference between the model image and measurement image is small. The models are automatically finely divided and matched in detail. Reference: ▶ "Processing Item List Manual", "Sensitive Search" (p.68)</p>
<p>When performing different inspections according to the type</p>	<p>[Classification] Effective for inspections performed on lines where different types of products are manufactured. Reference: ▶ "Processing Item List Manual", "Classification" (p.110)</p>

Checking for deformation

Method, objective	References
<p>Deformation check when there are multiple acceptable shapes</p>	<p>[Flexible Search] Effective when performing inspection for deformation of measurement objects based on multiple acceptable shapes. Reference: ▶ "Processing Item List Manual", "Flexible Search" (p.59)</p>
<p>When measuring the shape more strictly</p>	<p>[Fine Matching] Effective when inspecting the shape of workpieces to a high degree of precision. Reference: ▶ "Processing Item List Manual", "Fine Matching" (p.231)</p>

Inspecting characters

Method, objective	References
Inspection of the date	[Date Verification] Effective when inspecting date character strings that show the production date, etc. The verification date can be set automatically. Reference: ▶ "Processing Item List Manual", "Date Verification" (p.250)
Inspection of arbitrary character strings	[Character Inspection] Effective when inspecting arbitrary character strings. Reference: ▶ "Processing Item List Manual", "Character Inspection" (p.242)
Registration of character strings	[Model Dictionary] To inspect character strings with [Date Verification] or [Character Inspection], register the target character strings with [Model Dictionary]. Reference: ▶ "Processing Item List Manual", "Model Dictionary" (p.259)

Reading barcodes

Method, objective	References
When reading barcodes	[Barcode+ (FZ3-Hxxx series)] Effective when reading barcodes and outputting the information to an external device. Reference: ▶ "Processing Item List Manual", "Barcodes+" (p.267)

Reading 2D codes

Method, objective	References
When reading 2D codes	[2D Code+ (FZ3-Hxxx series)] Effective when reading 2D codes for classification, etc. Reference: ▶ "Processing Items List Manual", "2D Codes+" (p.275)



Increasing camera installation efficiency



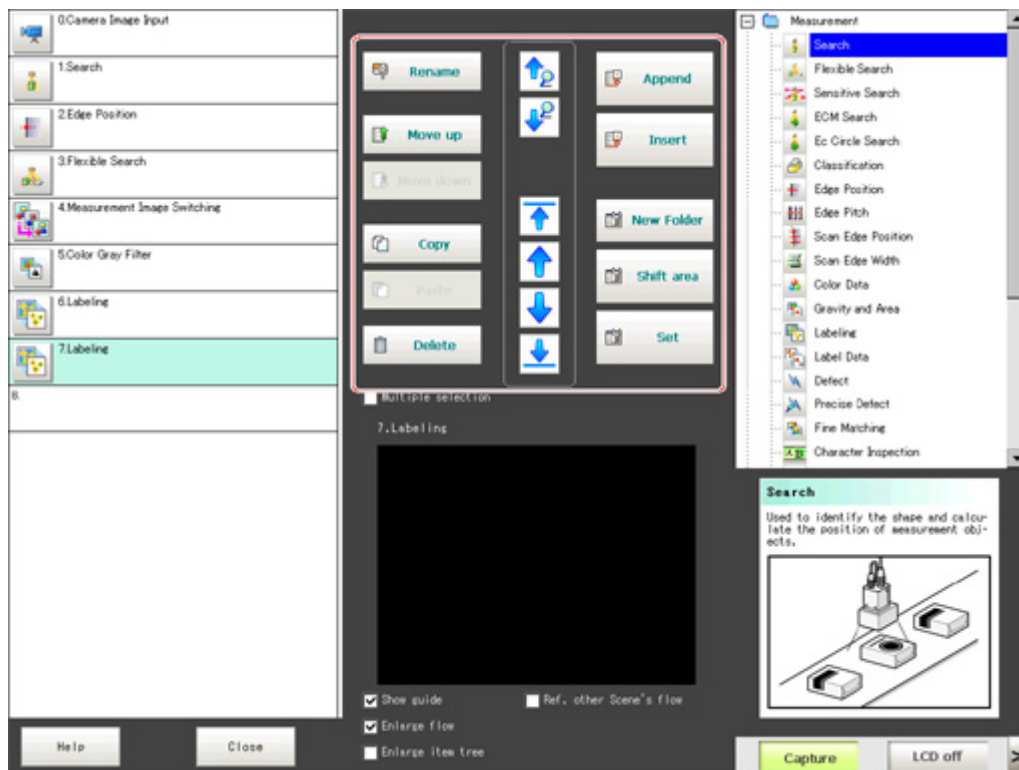

Method, objective	References
When adjusting the focus	[Focus] Effective when the measurement position changes and the camera becomes out of focus. Reference: ▶ "Processing Item List Manual", "Focus" (p.397)
When adjusting the lighting	[Iris] Effective when performing lighting adjustment according to the changing brightness at the measurement site. Reference: ▶ "Processing Item List Manual", "Iris" (p.400)



Editing Processing Units in Scenes



In the Edit Flow window, editing buttons in the window can be used to change the order of processing units within the scene or to delete processing units.





- Searching a processing unit () ()

Convenient when the processing unit you want to select is not displayed on the screen.
- Selecting a processing unit () () () ()

In addition to tapping the property setting button icons, the editing buttons can be used to automatically select the processing unit at the top or bottom, or above or below an arbitrarily selected processing unit in the unit list.
- Specifying the position for a processing unit and adding it () ()

Adds and inserts a processing unit at the bottom position of the scene or another specified position.
- Moving a processing unit () ()

Moves a processing unit within a scene and changes the processing order.
- Copying and pasting a processing unit () ()

Copies and pastes a processing unit while maintaining settings data.
- Deleting a processing unit ()

Deletes processing units within a scene.
- Changing the name of a processing unit ()

Changes processing unit names within a scene. Unit names must begin with a character other than ° (semi-voiced sound symbol) and ` (voiced sound symbol). Also, unit names cannot

consist of only a single-byte number, only a "+", or only a ".".

- Setting details of a processing unit ()

Sets the properties of any processing unit within a scene.

- Shift area ()

Changes related figure data in one batch.

- New Folder ()

Used when multiple processing units are managed as one group.

- Operating processing units as a group ()

Used when processing units are copied or deleted together. A checkbox is displayed in the processing unit if [Multiple selection] is tapped. Checked processing items can be operated as a group.



- Ref. other Scene's flow (Ref. other Scene's flow)

Units of other scenes can be referred to and added to the current scene flow.

Selecting a scene to refer to displays the flow for that scene.



Note

- If a processing unit is inserted, the numbers for the subsequent processing units increase by one. With processing items related to results output or branch control, the numbers for processing units set as references also automatically increase by one.
- If a button other than [Paste] is tapped after pasting a processing unit, continued pasting of the processing cannot be performed.
- If a processing unit is deleted, the numbers for the subsequent processing units decrease by one. With processing items related to results output or branch control, the numbers for processing units set as references also automatically decrease by one.
- To make a specific processing unit not display in a flow on the ADJUST window or RUN window, insert a "*" (single byte) at the beginning of the processing unit name.

Switching Scenes and Scene Groups

Set-up can be changed by changing the scene. With factory settings, the default display is scene 0 when the power is switched on. In addition, multiple scenes can be created (Scene 1 to 31).

Also, when combined with the scene group function, up to 1024 scenes can be set.

Instructions for switching scene groups and scenes can also be performed from external devices.

Reference: ▶ Methods for Connecting and Communicating with External Devices (p.148)

Switching Scenes

1. Tap "Scene switch" in the toolbar on the Main screen.

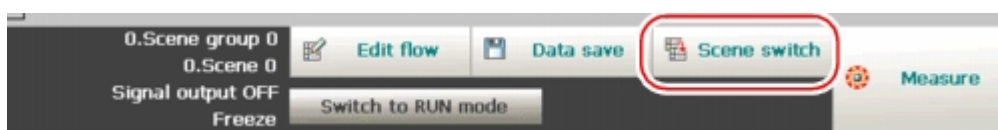

The Switch Scene window is displayed.

Note

- The same operation is available by tapping [Scene] menu - [Scene switch].

2. Tap [▼] to select the scene to switch.

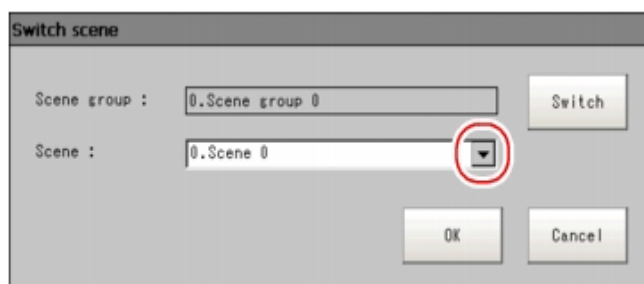

To switch a scene group, tap [Switch], then tap [▼] in the displayed window to select the scene group to switch.

3. Tap [OK].
The scene switches.

Switching Scene Groups

Switches to the scene group in which the scene to be edited is stored.

1. On the Main screen, tap [Scene] - [Scene maintenance].
The Scene Maintenance window is displayed.

2. Tap [Switch] for the scene group.

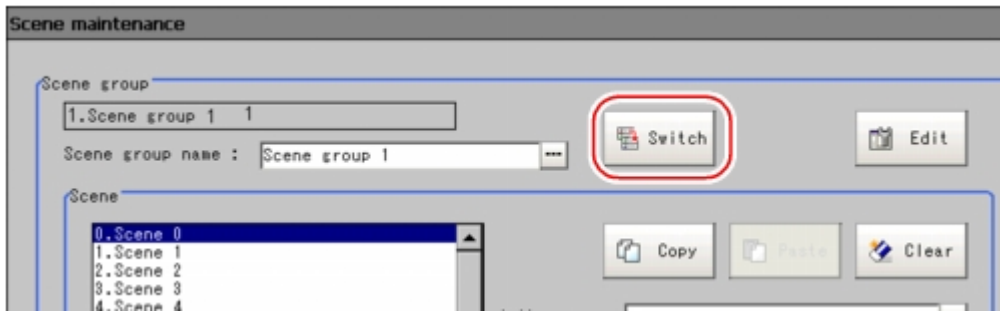

The Switch Scene Group window is displayed.

3. Switch to the scene group to edit.

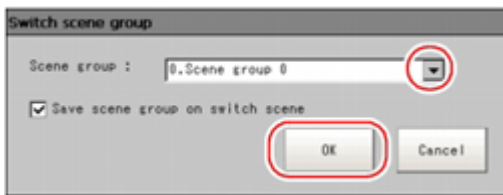

1. Tap [▼] and select the scene group to edit.
2. Select whether a scene group should be saved when switching to another scene group.

Setting item	Setting value [Factory default]	Description
Save scene group on switch scene	[Checked]	When the scene group is switched, the data of the scene group before switching is saved.
	Unchecked	The scene group data is not saved when switching to another scene group. Therefore, the switching period can be shortened.

Note

- The setting for whether to save a scene group during switching is linked to the settings of the Measurement Setting window.
Reference: ▶ Setting Conditions Related to Operation during Measurement (p.130)

3. Tap [OK].
The scene group is switched and the screen returns to the Scene Maintenance window.

Important

- When a check is inserted in "Save scene group on switch scene", data may be lost if the power is cut off during scene group switching. During scene group switching, make sure that the power is not cut off.

Editing Scenes

Copying a Scene

Copies and pastes scenes within a scene group.
This is a convenient function for reusing a created scene with only one portion being changed.

1. On the Main screen, tap [Scene] - [Scene maintenance].
The Scene Maintenance window is displayed.
2. In the scene list, tap the source scene to copy, and then tap [Copy].

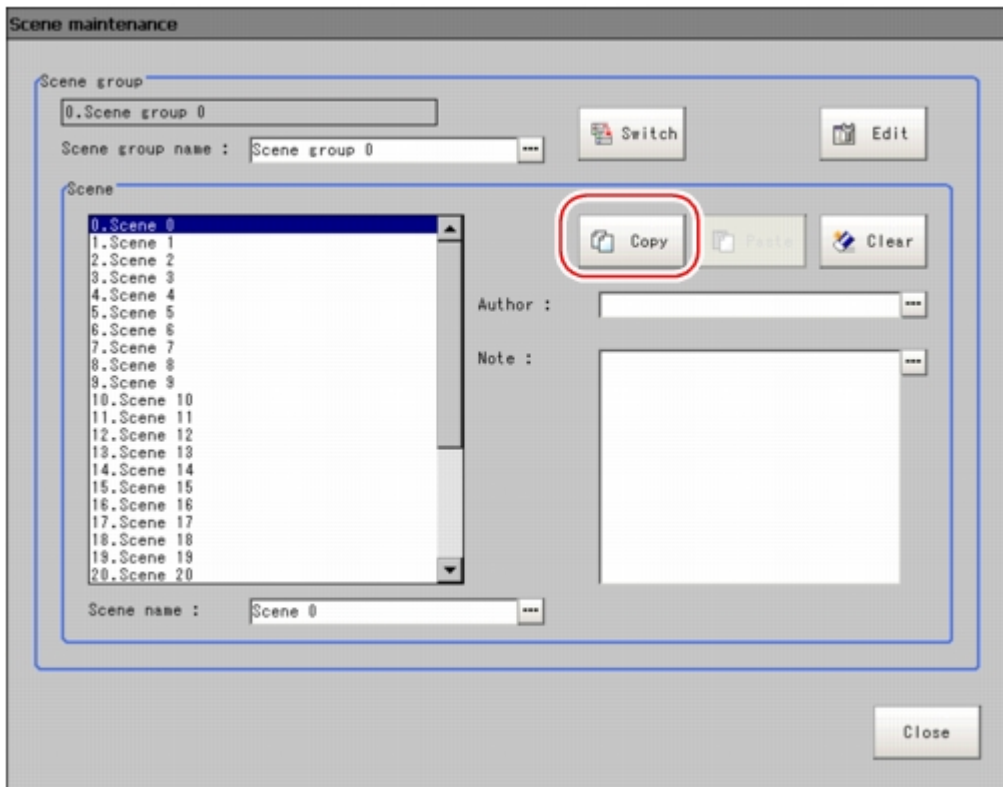

3. In the scene list, tap the scene to which the copy is to be pasted and then tap [Paste].
The confirmation window for overwriting is displayed.
4. Tap [Yes].
The copied scene data is written over the scene selected as the destination.
5. Tap [Close].

Clearing a Scene

Clear scene settings and return to factory default values. This section describes how to initialize measurement contents for each scene.

1. On the Main screen, tap [Scene] - [Scene maintenance].
The Scene Maintenance window is displayed.
2. Tap the scene to be cleared from scene list.

3. Tap [Clear].

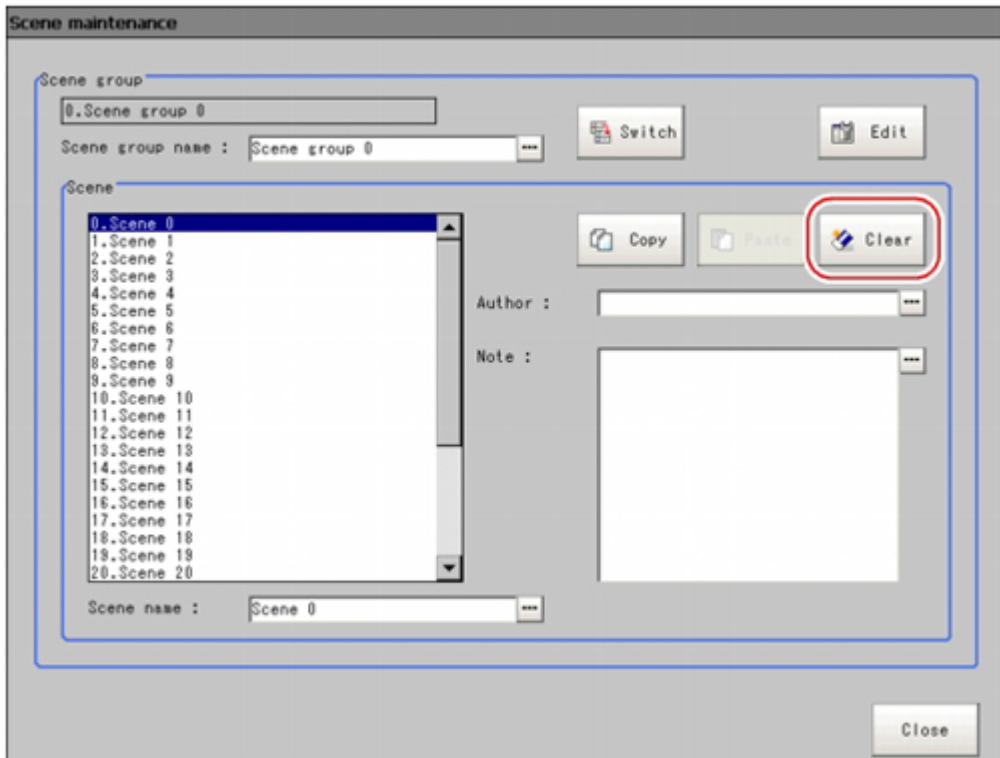

A confirmation message is displayed.

4. Tap [Yes].

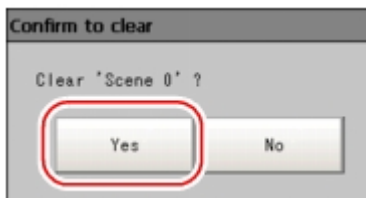

Scene data is cleared.

5. Tap [Close].

Renaming a Scene and Adding a Description

Arbitrary descriptions can be added to each scene. This is convenient for making settings more easily understandable when managing many scenes.

1. On the Main screen, tap [Scene] - [Scene maintenance].
The Scene Maintenance window is displayed.
2. Tap the scene to be renamed from scene list.

3. Set "Scene name", "Author" and "Note".

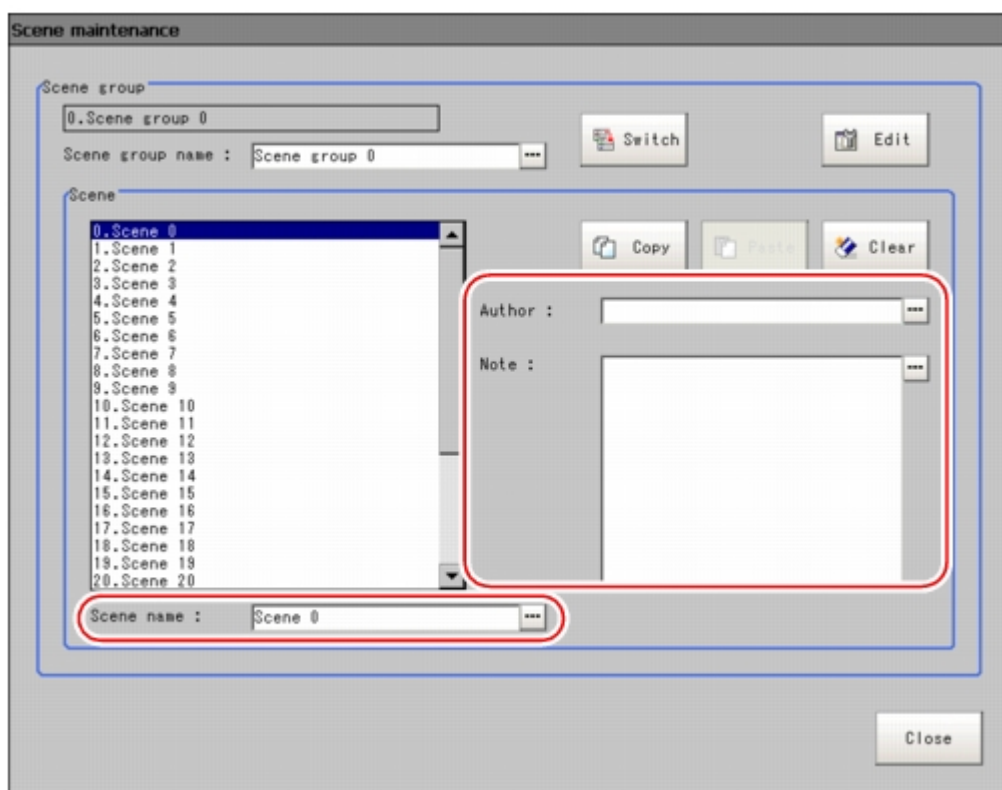

1. Tap [...] for each item.
The soft keyboard is displayed.
2. Set the name and a description.
"Scene name" and "Author" cannot be longer than 15 characters, and "Note" cannot be longer than 255 characters.
 - and " cannot be used alone as a "Scene name".

Note

- When writing "Note", enter a line-break after 32 single-byte characters or 17 double-byte characters. Without a line break, the display of character strings is truncated.

4. Tap [Close].

Editing Scene Groups

Copying or deleting can be done by scene group and scene groups can be arbitrarily renamed.

Note

- Make sure to check that a USB memory device has been inserted before performing this operation.

Copying a Scene Group

1. On the Main screen, tap [Scene] - [Scene maintenance].
The Scene Maintenance window is displayed.
2. Tap [Edit].

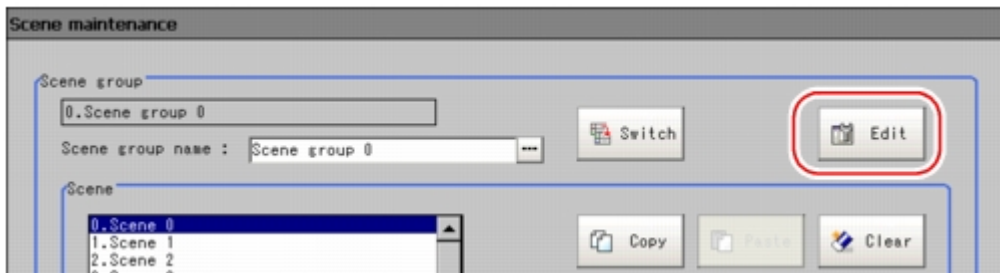

The Scene Group Maintenance window is displayed.

3. Select the scene group to copy and tap [Copy].

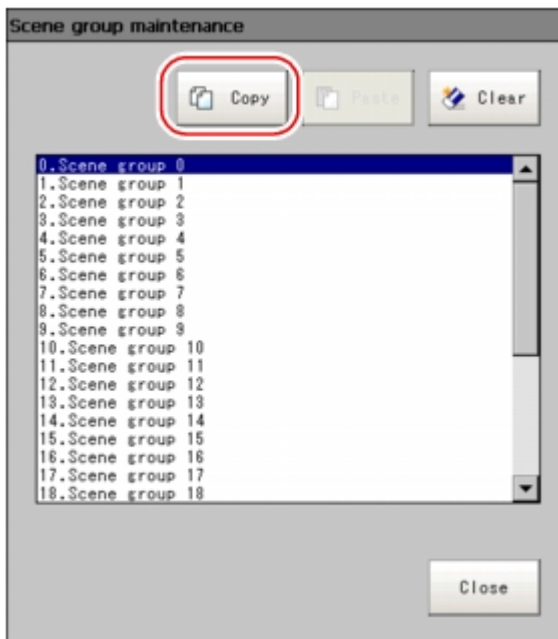

4. Select the copy destination scene group and tap [Paste].
The confirmation window for overwriting is displayed.
5. Tap [Yes].
The copied scene group data is written over the scene group selected as the destination.
6. Tap [Close].

Deleting a Scene Group

Delete scene group data. The data to be deleted is shown as follows.

- Names set for a scene group
- All scene data within a scene group

1. On the Main screen, tap [Scene] - [Scene maintenance].
The Scene Maintenance window is displayed.
2. Tap [Edit].

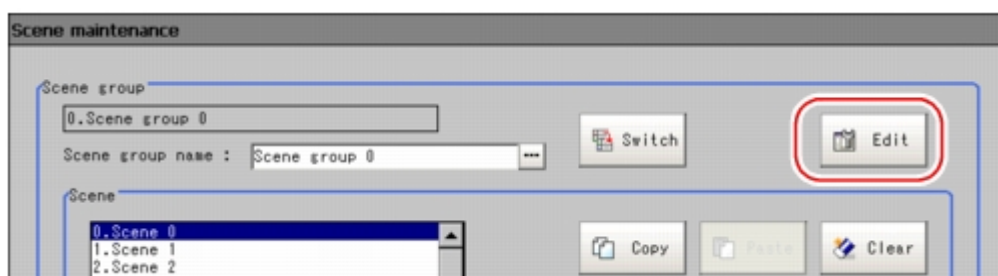

The Scene Group Maintenance window is displayed.

3. Select the scene group to delete and tap [Clear].

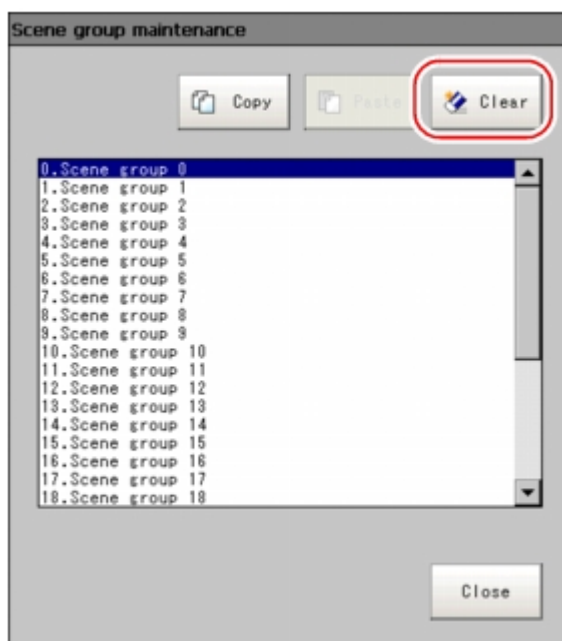

A confirmation message is displayed.

4. Tap [Yes].
Scene group data is deleted.
5. Tap [Close].

Renaming a Scene Group

Scene groups can be arbitrarily named. This is convenient for managing more than one scene group.

1. On the Main screen, tap [Scene] - [Scene maintenance].
The Scene Maintenance window is displayed.

2. Set "Scene group name".



1. Tap [...] for the "Scene group name".
The soft keyboard is displayed.
2. Enter a new name.
Use 15 characters or less to Input words.
3. Tap [Close].

Performing Test Measurement /Starting Operation

This chapter describes tests methods for checking whether correct measurement can be performed at the set conditions and describes useful functions for operation.

- ▶ Reference: ADJUST Window and RUN Window (p.74)
- ▶ Reference: Performing Test Measurement (p.77)
- ▶ Reference: Key Points for Adjustment (p.79)
- ▶ Reference: Arranging the RUN Window (p.82)
- ▶ Reference: Useful Functions for Operation (p.90)

ADJUST Window and RUN Window

After test measurement and remeasurement are performed, check the measurement results. If there are problems, adjust the processing item setting values of the processing units. If the measurement results are stable, switch to the RUN window and perform measurement. This section describes the ADJUST window and RUN window.

ADJUST Window

Judgement result and measurement time for the entire scene are displayed.

The unit with NG is displayed in red.

The measured object can be displayed on a displayed camera image.

The measurement result is displayed in text.

The current display settings are shown. Also, you can change the display settings here.

RUN Window

There are two types of RUN windows: Normal mode and fast view mode. Change the display speed according to the intended use.

Note

- Switching method for RUN window normal mode and fast view mode
Reference: ▶ Switching the RUN Window to Fast View Mode [Select RUN mode] (p.88)
- Method for setting display contents of RUN window
Reference: ▶ Setting the RUN Window Display [RUN Mode View Setting] (p.138)

Normal Mode RUN Window

The screenshot shows the Normal Mode RUN Window. At the top left, a large 'OK' indicator is displayed in cyan, with 'RUN' and '17ms' below it. The top right shows '0.Scene group 0' and '0.Scene 0'. The main area is a camera image of a battery labeled 'omron FZ-MEM256' with a green bounding box around it. On the right side, there are several panels: 'Flow' (0.Camera Image Input, 1.Edge Position, 2.Search), 'Detail result' (Judge: OK, Count: 1, Correlation: 99.4000, Position X: 320.0000, Position Y: 240.0000, Angle: 0.0000), 'Image display' (Image layout: 1 image, Active image: Image number 0, Image mode: Through, Positions: ON/OFF, Sub image: Image 0), and 'Tool box' (Switch to ADJUST mode, Enter simplified non-stop adj., Capture, LCD off).

To display measuring time and overall judgment results of total scene.

To display the NG unit in red.

To cascade measured results in camera image.

To display measured results in text format.

Display method of the image can be changed.

Switches to Simplified non-stop adjustment mode.

Switches to the ADJUST window.

When processing is taking a long time, it is necessary to check processing items and setting values. The time required for measurement is also displayed with the measurement results, so use this for reference.

Fast View Mode RUN Window

Simplifies display items and makes the display speed faster.

The screenshot shows the Fast View Mode RUN Window. It is a simplified version of the Normal Mode window. At the top left, 'OK' and 'RUN' are displayed. The top right shows '0.Scene group 0' and '0.Scene 0'. The main area is a camera image of the same battery with a green bounding box. On the right side, there is a 'Detail result' panel (Judge: OK, Count: 1, Correlation: 99.4000, Position X: 320.0000, Position Y: 240.0000, Angle: 0.0000) and a 'Tool box' panel (Switch to ADJUST mode, Capture, LCD off).

Switching to the RUN Window

1. Tap [Switch to RUN mode] in the ADJUST window.

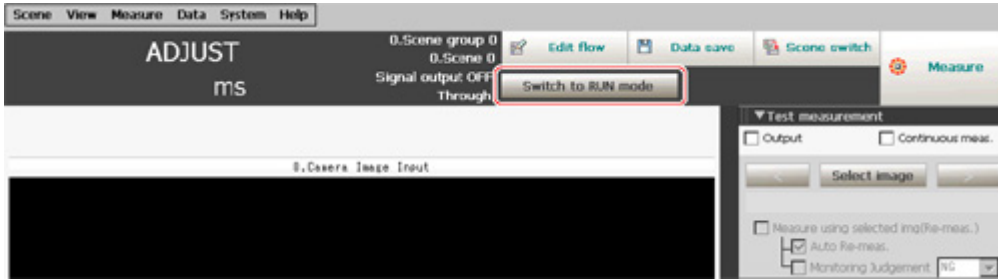

Window switches to the RUN window.

Note

- You can make settings so that the RUN window is displayed whenever power to the controller is turned on.
Reference: ▶ Setting the Start-up Status [Startup Setting] (p.133)
- Lighting gradually gets darker if it is used for a long time, so adjust judgement conditions periodically.
- Without stopping a measurement in operation, you can change judgement conditions for a processing unit set in a scene.
Reference: ▶ Changing Judgement Conditions without Stopping Measurement (p.93)

Switching to the ADJUST Window

1. Tap [Switch to ADJUST mode] in the RUN window tool box.

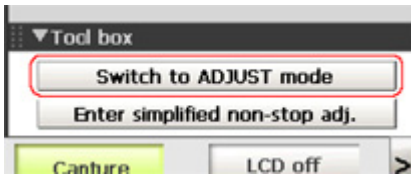

Switches to the ADJUST window.

Performing Test Measurement

Test whether the intended measurement processing can be performed with the current setting contents. Look at test results and adjust the property settings of each processing unit. Perform measurement according to the conditions set in the displayed scene.

1. Display the Main screen (ADJUST window).
2. For the test conditions on the ADJUST window, set the following items.

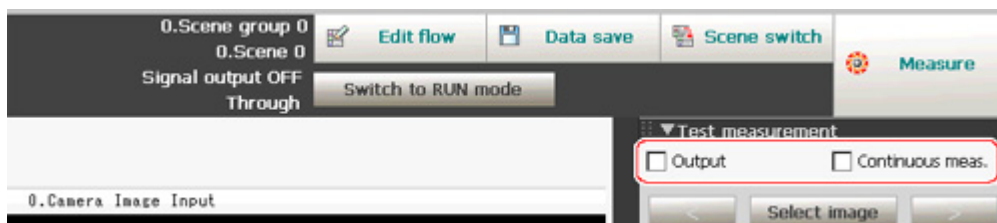

Setting item	Description
Output	Place a check here when the measurement results on the ADJUST window are also to be output. Remove the check when test measurement for the device only is to be performed without results being output.
Continuous meas.	Place a check here when continuous measurement is to be performed. Tapping the [Measure] button starts continuous measurement.

3. Tap [Measure] in the Toolbar.

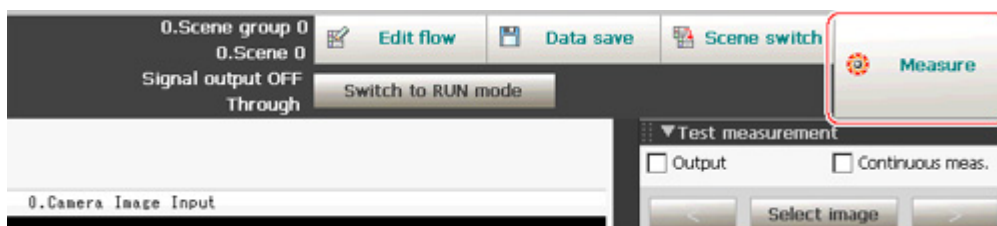

Measurement is performed.

Note

- With continuous measurement, the [Measure] button changes to the [Stop meas.] button during the measurement. To stop continuous measurement, tap [Stop meas.].

4. Check measurement results.
5. If necessary, adjust the setting values for each processing unit again. Moving to the property window can be done directly by tapping the button of any processing unit set in the flow.

Procterm setting button



Note

- Test images can be saved. This function is called the logging function. After setting conditions, these test images can be used in performing test measurement again.
Reference: ▶ Logging Measurement Values and Measurement Images (p.96)

Important

- The measurement interval and display update interval will vary for continuous measurement with test measurement settings and continuous measurement with serial commands/parallel commands.
Evaluate the measurement interval and display update interval by watching actual operation.

Key Points for Adjustment

This section describes key points for adjustment when aiming to improve measurement precision and shorten measurement time.

Stabilizing Measurement

This section describes key points for adjustment when measurement is not stable. There are two methods for improving measurement precision: Performing processing of images loaded from the camera (filtering) or adjusting settings and parameters.

Adjusting Parameters of Each Processing Item

Adjustment to improve precision and stability varies depending on the processing item. For details, see "Key Points for Adjustment" for each processing item in the Processing Item List Manual.

Processing Images (Filtering)

There are cases in which high-precision measurement is impossible such as when using images loaded from the camera that have noise, irregularities, or low contrast or when the background has patterns during defect measurement. In this case, measurement accuracy can be improved by performing processing of measurement images in advance.

Reference: ▶ "Processing Item List Manual", "Filtering" (p.302)

When measurement images have irregularities (search and location positioning are not stable)

The filtering items "Smoothing (strong and weak)" and "Median" are both effective.

- **Smoothing (strong and weak)**

This processing changes the shade of images so that irregularities are not as easily seen.

[Weak smoothing]

Before filtering



After filtering

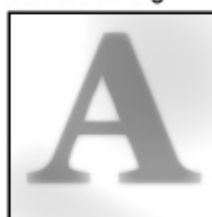

- **Median**

In comparison with smoothing, "Median" allows for irregularities to be hidden without having to shade the edges of images.

When measurement images contain noise

The filtering items "Dilate" and "Erosion" are both effective.

- **Dilate**

When there is dark noise in an image, bright areas are enlarged to eliminate dark noise.

- **Erosion**

When there is bright noise in an image, bright areas are contracted to eliminate bright noise.

[Erosion]

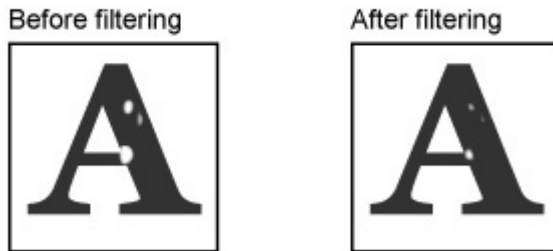

When contrast of measurement images is low (defect inspection is unstable)

The filtering items "Extract vertical edges", "Extract horizontal edges", and "Extract edges" are effective.

- **Extract vertical edges**

This extracts the vertical edges of an image.

[Extract vertical edges]

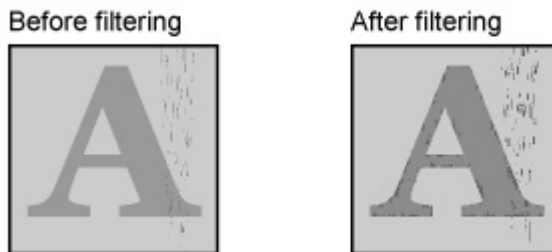

- **Extract horizontal edges**

This extracts the horizontal edges of an image.

- **Extract edges**

This extracts the all edges of an image.

When unidentifiable shapes are present

The filtering item "Extract edges" is effective.

- **Extract edges**

This is used to make the profile clearer and the shape more identifiable.

[Extract edges]

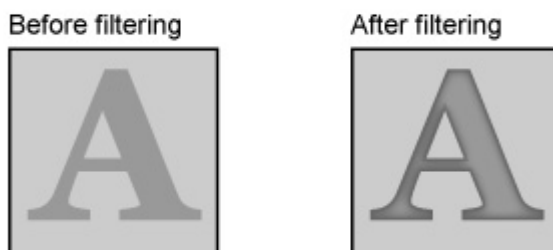

Shortening Processing Time

Find out which processing units are taking the most time and adjust the parameters of these processing items taking time.

1. Insert the processing item "Elapsed Time" after the processing unit for which time is to be measured.

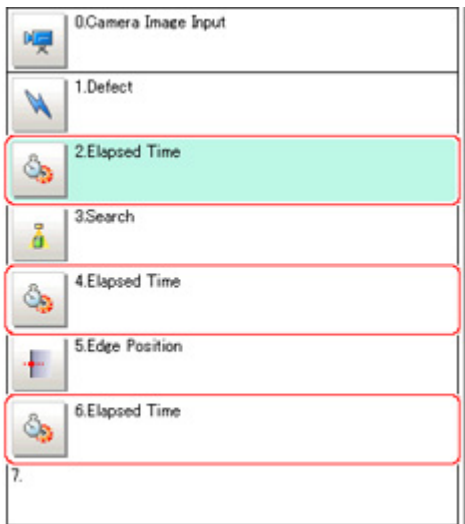

2. Execute measurement.
3. After tapping the "Detail result" area, tap the elapsed time processing unit where time is to be checked.
The elapsed time from the top of the flow to the relevant processing unit is displayed.

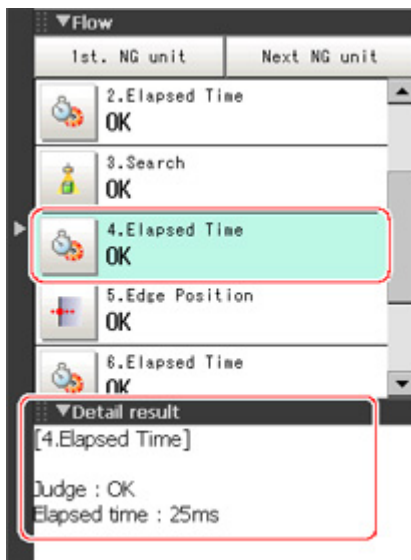

4. Adjust the parameters of the processing units that are taking time.
For details on adjustment parameters, see "Key Points for Adjustment" for each processing item in the Processing Item List Manual.

Arranging the RUN Window

Displaying Multiple Windows Together

Multiple images can be displayed side by side in the Image Display area.

1. In "Image display" of the Main screen Control area, tap [▼] of the "Image layout" menu and select the number of images to be displayed.
The camera image view in the Image Display area switches according to the selected contents.

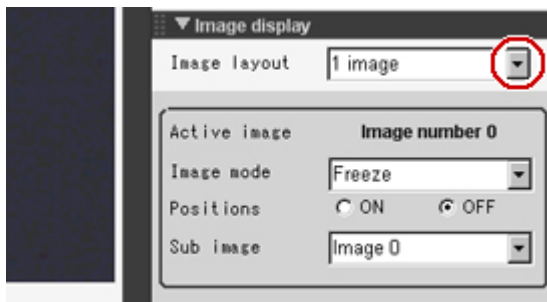

There are the following four image display patterns.

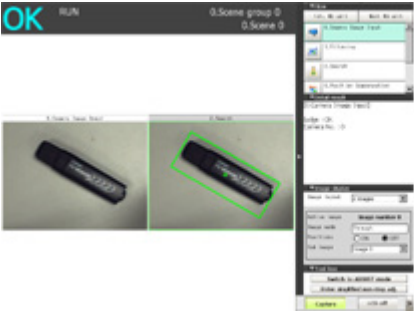
Item	Description
1 image	Displays 1 image. Since images are enlarged, this is ideal for checking details. 
2 images	2 images are displayed side by side. Suitable for when 2 cameras are connected and images are to be checked all at one time. 

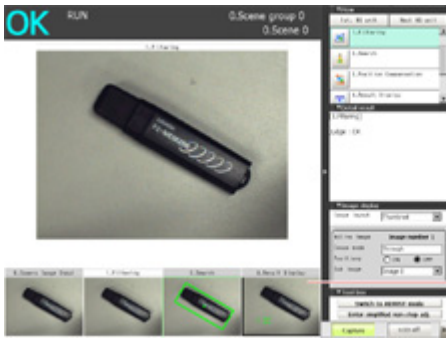
<p>4 images</p>	<p>4 images are viewed together with one each at the left, right, upper, and lower positions.</p>  <p>Suitable for when 4 cameras are connected and images are to be checked all at one time.</p>
<p>Thumbnail</p>	<p>Displays four small images at the bottom and also one larger selected image. This view is preferable when you wish to check details of a certain image when four cameras are connected. Thumbnail display is not available in the RUN window (Fast view mode). When using the thumbnail display in the ADJUST window, the display will change to 4 images if you switch to the RUN window (Fast view mode).</p>  <p>For the selected image, the color of button turns lighter.</p>

2. Select which processing unit image to display for each image.
After tapping the display assignment to change, tap the relevant processing unit in the measurement flow.

Changing Display Contents

The display contents of the Image Display area can be changed in order to make the measurement status easier to understand.

1. Tap the image to be changed.



- From the measurement flow, tap the processing unit to be displayed.

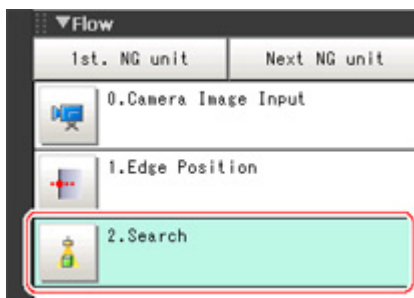

- Set each item in [Image display] of the Control area.

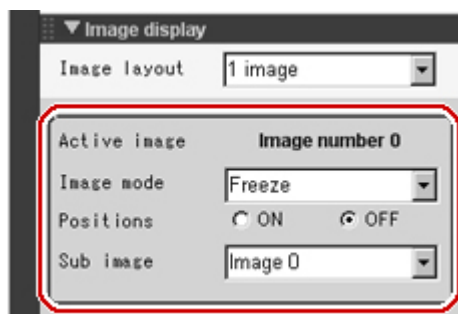

Item	Description
Image mode	This item changes the camera image mode. Reference: ▶ Image Mode List (p.84)
Positions	Measurement results are displayed as a list in the Image Display area. Display contents are classified into "Input image" units such as [Camera Image Input] and [Camera Switching], and "Compensate image" units such as [Filtering] and [Position Compensation]. For example, if "Positions" is turned on with [Position Compensation] selected, a combined positions list for units after [Position Compensation] is displayed. The units in the area before [Position Compensation] are not displayed.
Sub image	Indicates displayable image for the selected processing item. Reference: ▶ List of sub image numbers (p.86)

Note

- To check detailed results for each unit when "Positions" is on, select any unit after selecting the "Detail result" area to make detailed results active. To make detailed results inactive, select the Image Display area.

Image Mode List

Changes can be made in the ADJUST window.

Item	Description
Through	The latest image is always loaded from the camera and displayed. When "Through" is selected, saved images cannot be called up for measurement.
Freeze	The image that was scanned in the immediately preceding measurement is displayed. Images can be updated at any time during measurement.

Last NG	<p>The latest NG error image resulting from an overall judgement is displayed.</p> <p>The latest measurement results are always shown in overall judgement and measurement time. In this case, the overall judgement result and measurement time may conflict with the camera images. Also, during continuous measurement, "Last NG" cannot be displayed.</p>
---------	---

Note

- Tapping the Image Display area or flow when "Last NG" is displayed and made active clears the screen. Be sure to capture "Last NG" before performing any other operation.
- If a measurement trigger is input during multi-input status or immediately after BUSY is turned off (during display update processing, etc.), "Last NG" cannot be displayed.
- [Display Last NG Image] fulfills a similar function as a processing item in which up to 4 NG error images can be saved. If this processing item is used, "Last NG" can be acquired without operation having any effect on acquisition.

List of Sub Image Numbers

Classification	Processing item	Sub image number and display
2D measurement	ECM Search	0: Measurement image 1: Measurement image displayed with matching edges overlaid
	Edge Position	0: Measurement image 1: Profile display
	Edge Pitch	0: Measurement image 1: Profile display
	Scan Edge Position	0: Measurement image 1: Scan region
	Scan Edge Width	0: Measurement image 1: Scan region
	Gravity and Area	0: Measurement image 1: Extracted image
	Labeling	0: Measurement image 1: Extracted image
	Labeling+	0: Measurement image 1: Color extraction image
	Defect	0: Measurement image 1: Defect profile [when area measurement is present]
	Precise Defect	0: Measurement image 1: Defect profile [when area measurement is present]
	Fine Matching	0: Measurement image 1: Difference image display
	Measurement Image Switching	0: Reset image 1: Measurement image
	Position Compensation	0: After compensation 1: Before compensation
	Trapezoidal Correction+	0: Post-conversion image
	Extract Color Filter	0: Color extraction image 1: Measurement image
	Stripes Removal Filter+	0: Post-conversion image
	Halation Cut+	0: Color extraction image
	Panorama+	0: Post-combination image
	Polar Transformation	0: Post-conversion image 1: Measurement image
	Display Image File	0: Image 0 1: Image 1 2: Image 2 3: Image 3
Display Last NG Image	0: Last NG 1: Previous NG error image (Displayed when there are 2 or more saved images. Otherwise, "Last NG" is displayed.) 2: NG error image from 2 previous (Displayed when there are 3 or more saved images. Otherwise, "Last NG" is displayed.) 3: NG error image from 3 previous (Displayed when there are 4 or more saved images. Otherwise, "Last NG" is displayed.)	

Enlarging Measurement Images [Zoom Images]

Set the measurement image zoom status (magnification and display position). During display of multiple images, magnification can be set for each image.

1. On the Main screen, tap [View] - [Zoom images].
A magnification setting tab is displayed in the top right of the measurement image.



2. Set the magnification as required.

Setting item	Set value [Factory default]	Description
Measurement image magnification setting	<ul style="list-style-type: none"> • [Auto] • 25% • 50% • 100% • 200% • 400% • 800% • 1600% 	Sets magnification.

3. Drag images to specify the display position as required.
4. On the Main screen, tap [View] - [Zoom images].
The current magnification and display position are saved.

Displaying Flow and Detailed Results

Switches display of [Flow] and [Detail result] on/off of in the Control area.

Note

- The same operation is available by tapping [View] - [Flow] or [Detail result].

1. Tap [Flow] or [Detail result] in the Control area.

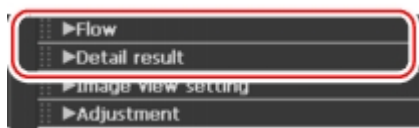

Flow or details of measurement results are displayed. Tapping once again returns the screen to the previous status.

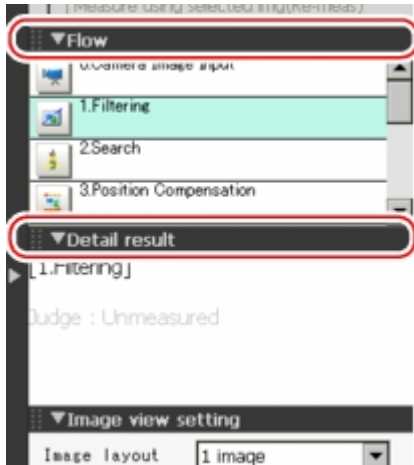

2. When displaying both the flow and detailed results, you can change the size of the Display area of the flow and detailed results by dragging [Detail result].



Switching the RUN Window to Fast View Mode [Select RUN Mode]

Switches the mode of the RUN window. Fast view mode simplifies display items and makes the display speed faster.

1. On the Main screen, tap the [System] menu - [Controller] - [Select RUN mode].
The Select RUN Mode window is displayed.
2. Tap [▼] and select a mode.

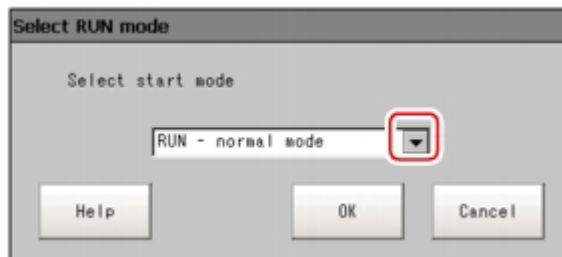

Set value [Factory default]	Description
<ul style="list-style-type: none"> • [RUN - normal mode] • RUN - fast view mode 	Selects which mode is used to display the RUN window.

3. Tap [OK].

The Select RUN Mode window closes.

Changing Display Contents on the RUN Window Measurement Information Display Area

The display contents on the RUN window measurement information display area can be changed.

Reference: ▶ [Setting the RUN Window Display \[RUN Mode View Setting\]](#) (p.137)

Changing Functions That Can Be Operated from the RUN Window Tool Box

Functions that can be operated from the RUN window tool box can be changed.

Reference: ▶ [Setting the RUN Window Shortcut \[Create Shortcut\]](#) (p.138)

Useful Functions for Operation

Remeasuring Saved Images

Images from when measurement, including test measurement, was performed can be saved. Remeasurement can be performed with saved images after conditions are adjusted in order to check whether the adjustment is appropriate.

The logging function is used for saving images.

Reference: ▶ Setting Logging Conditions [Logging Setting] (p.98)

Images that can be remeasured include images saved in the controller and images saved in USB memory.

1. In the Control area of the Main screen, tap [Test measurement].
2. Tap [Select image].

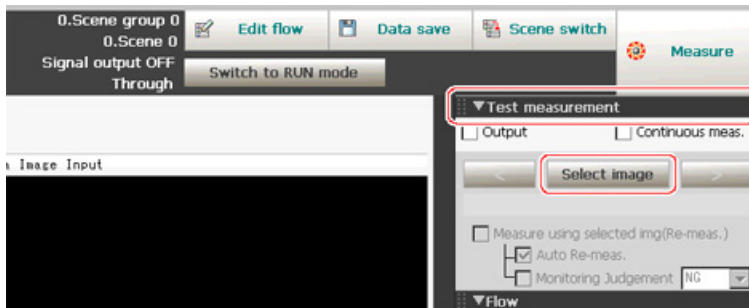

The Select Image window is displayed.

3. Tap [...] and select the file to display.

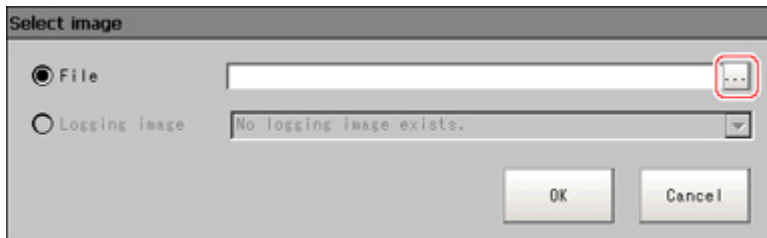

Setting item	Description
File	Specify images saved in the USB memory or in the RAMDisk.
Logging image	Specify images that are logged in the controller memory.

4. The selected image is displayed at the lower left of the FileExplorer screen. When there are multiple camera images in a file, as for a logging image when multiple cameras are connected, use the "<<" and ">>" buttons to switch images.



5. Tap [OK].
The path and file name of the image are displayed under [Select image].

6. Check "Measure using selected img (Re-meas.)".

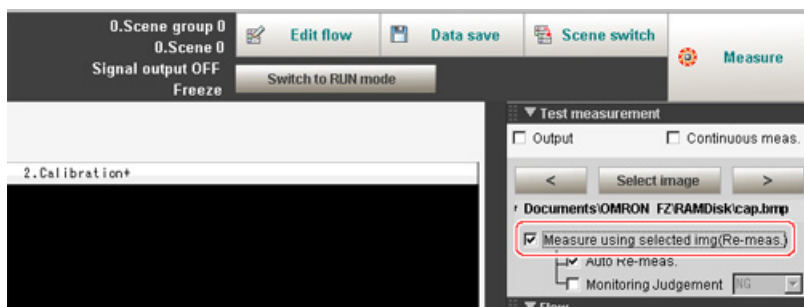

7. Tap [Measure] in the toolbar on the Main screen.

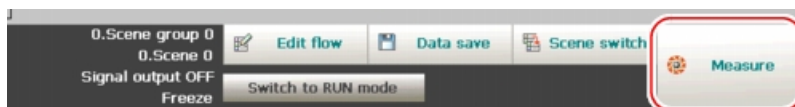

Measurement of the selected image is performed.

Note

- About Auto Re-meas.
Displayed images can be automatically remeasured by placing a check in "Auto Re-meas."

Important

- When remeasuring an image with the controller, it is necessary to have a camera connected that is appropriate to the image size. For example, if the image file for remeasurement contains 2 megapixel images and a 0.3 megapixel camera is connected to the controller or if a camera is not connected, measurement will not be performed correctly due to a memory deficiency. Perform remeasurement after connecting a camera appropriate to the image size.

Improving Adjustment Efficiency

Convenient when measuring a large amount of image samples and classification or adjustment is performed with each judgement.

Files in which NG error files and OK files are mixed can be continuously remeasured automatically, with the system stopping at images with a specified condition (OK/NG) and these files being moved.

1. In the Control area of the Main screen, tap [Test measurement].
2. Place a check next to "Monitoring Judgement" and set the judgement conditions for identification.

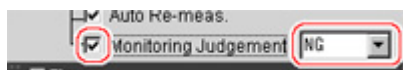

If the specified judgement condition is achieved when continuous measurement is performed, measurement stops and the following message is displayed.

If OK is selected

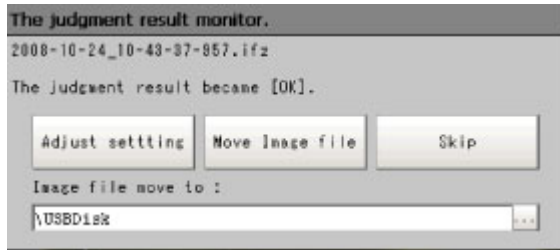

If NG is selected

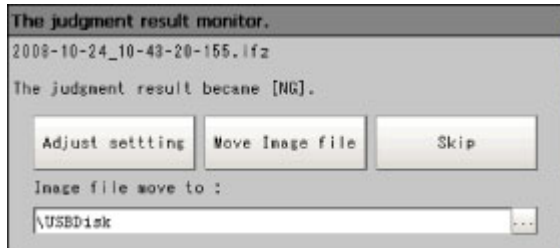

3. Select the processing for the measured image.

For "Adjust setting"

Tap the [Adjust setting] button.

For "Move Image file"

Specify the save destination and tap [OK].

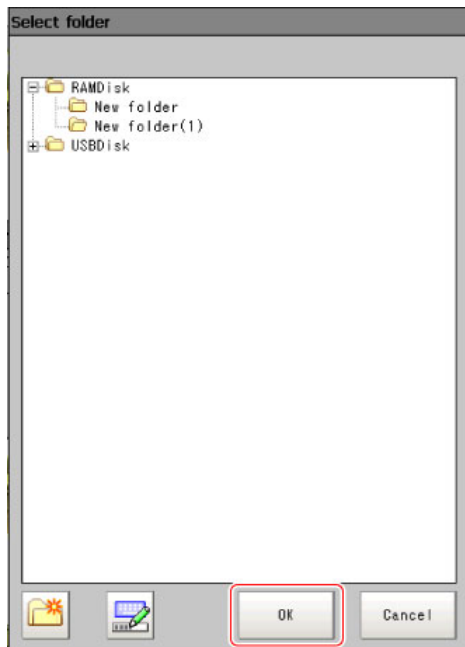

Tap the [Move Image file] button.

Tap the [Skip] button to skip processing and remeasure the next image.

Changing Judgement Conditions without Stopping Measurement

Using the simplified non-stop adjustment function makes it possible to change the judgement conditions of processing units of the currently displayed scene without stopping the measurement processing being executed.

Note

- The simplified non-stop adjustment function can only be used in RUN window normal mode. However, it cannot be used when the operation mode (FZ3-9 □□ /H9 □□ only) is set to [Single-line High-speed mode] [Non-stop adjustment mode]. Also, it cannot be used in the ADJUST window or RUN window fast view mode.
- If the Enter non-stop adj. button is not displayed, the button can be added with the system/controller/RUN window short cut setting.

1. In the "Control" area of the Main screen (RUN window), tap [Tool box].
2. Tap [Enter non-stop adj].
Transfers to simplified non-stop adjustment mode. "Enter simplified non-stop adj." is displayed at the upper part of the "Control" area flow.
Measurement will continue without stopping.



3. Tap the icon of the processing unit with the judgement condition to be adjusted.

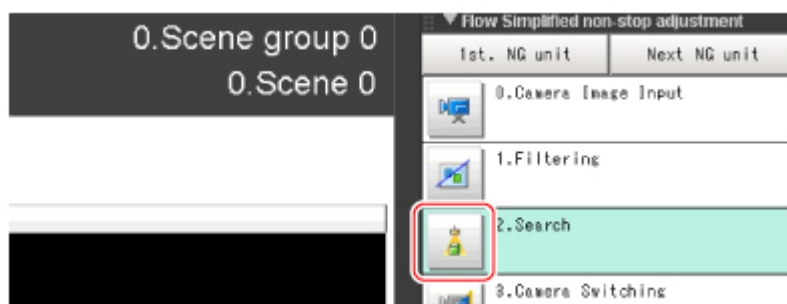

The window for the judgement conditions of the selected processing unit is displayed.

If you tap the icon of the processing unit that does not have setting item of "Judgement condition", Judgement window is not displayed.

- Change the judgement conditions of each processing unit.

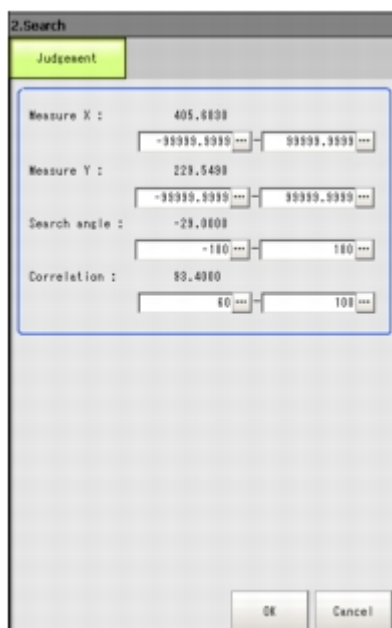

- Tap [OK].
The Judgement window closes, and the screen returns to the Main screen.

The changed contents are shown in the displayed scene.

When changing judgement conditions for multiple processing units, repeat steps Reference: ▶ 3 (p.93) to Reference: ▶ 5 (p.94) .

- In the "Control" area of the Main screen, tap [Quit simplified non-stop adj.].

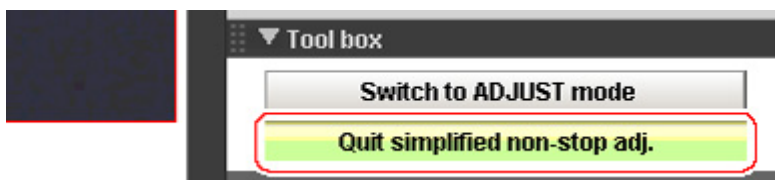

The simplified non-stop adjustment mode ends.

Note

- If [Switch to ADJUST mode] is tapped while entering simplified non-stop adjustment, the simplified non-stop adjustment mode is automatically ended and the screen switches to the ADJUST window.

Changing Regions as a Batch [Shift area]

Figure data for multiple processing items can be changed as a batch.

- Tap [Shift area] in the Edit Flow window.
The Move Measuring Area at Once window is displayed.

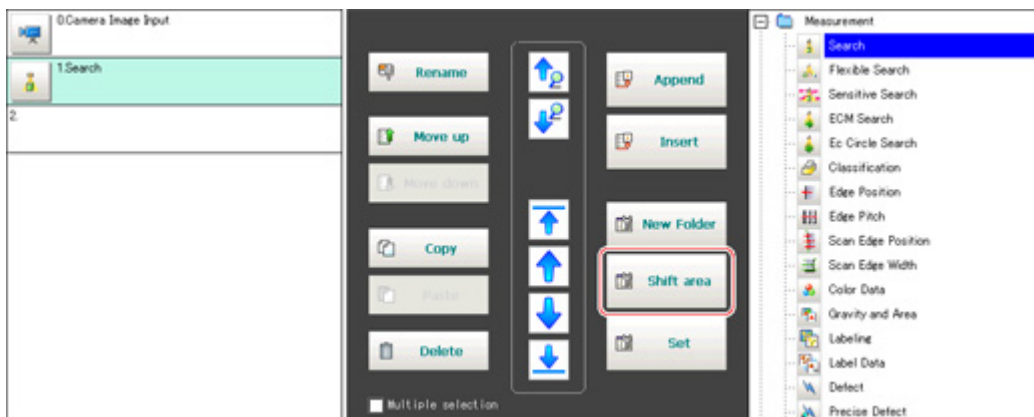

2. Select the processing item in which to change the region.
Only image setting processing items included in "Input image" and "Compensate image" are displayed.

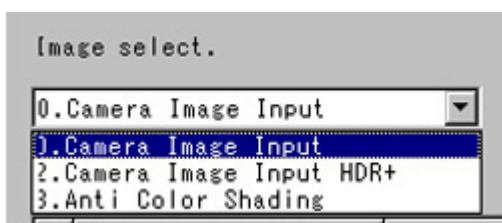

3. Select the registration region to change.

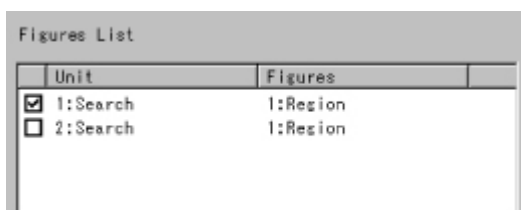

4. Tap [Move] and input the value or tap the arrows to move the image.
Images can also be directly dragged and moved.



5. Tap [OK].
The change is registered.

Monitoring Measurement Value Trends

By monitoring the trend in measurement values, the occurrence of defects can be prevented in advance and this information can also be helpful in NG error occurrence cause analysis. Use the processing item [Trend Monitor] to monitor the measurement values.

Reference: ▶ "Processing Item List Manual", "Trend Monitor" (p.374)

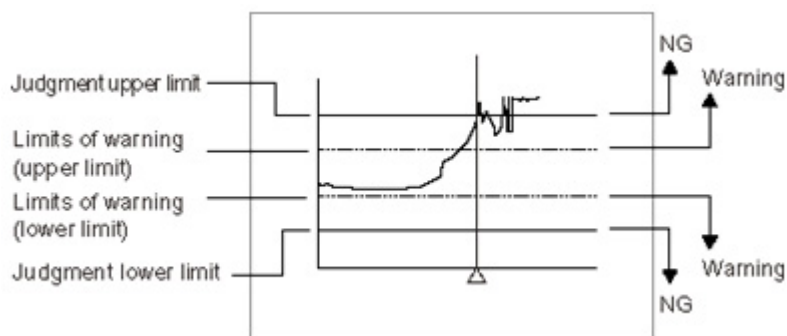

Note

- If the measurement value is within the alarm range, the "Warning" message is shown on the screen.
- If a result output-related processing item is used, this allows for output to external devices when a warning occurs.
- Through trend monitor judgement, trends can be managed and NG error images can be saved.
To save only NG error images identified by trend monitor judgement, create settings so that overall judgements from processing units other than [Trend Monitor] are not included in judgement.

Logging Measurement Values and Measurement Images

Logging is a function for saving camera input images or measurement results when executing measurement.

There are 2 different logging methods.

- When logging images that are currently displayed
Reference: ▶ Logging current image [Save last logging image] (p.97)
- When automatically logging images during measurement
Reference: ▶ Setting Logging Conditions [Logging setting] (p.98)

Images and measurement data can be saved in USB memory, which makes them useful for the

following kinds of adjustment.

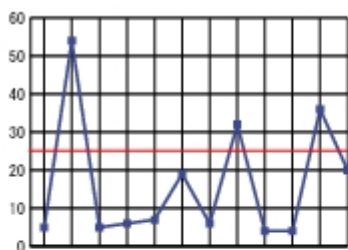

Optimization of thresholds

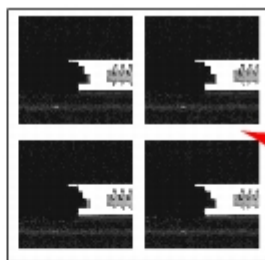

Verify measured data and NG images

Statistical analysis via Excel

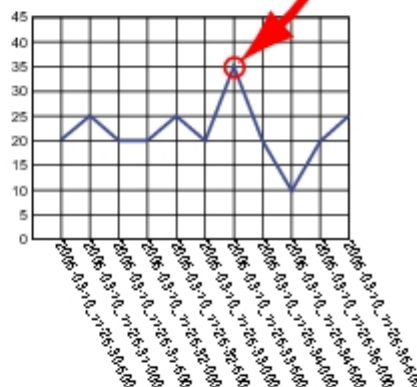
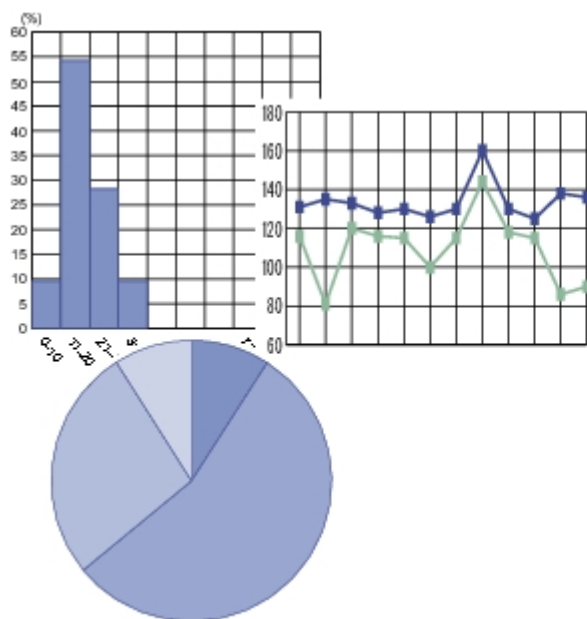

Logging Current Image [Save Last Logging Image]

This section explains the method for logging the latest input image being displayed.

1. On the Main screen, tap [Measure] menu - [Save last logging image].
The Logging Setting window is displayed.

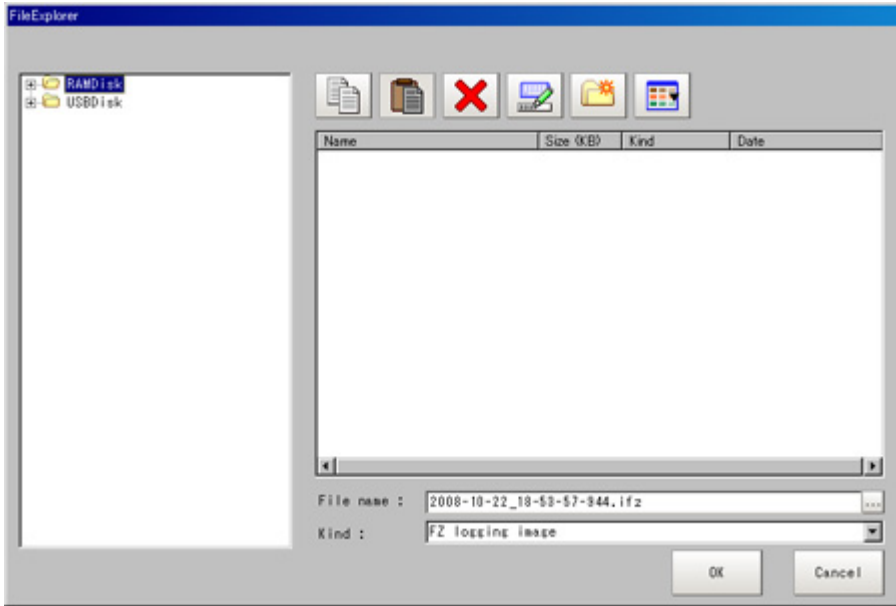

2. Set the logging images save destination.
Specify the image file save destination (RAMDisk or USB memory).
3. Edit the file name as required.



4. Tap [OK].



After the logging operation is complete, the Save Last Logging Image window closes.

Setting Logging Conditions [Logging Setting]

Set the logging timing and the save destination.

1. On the Main screen, tap the [Measure] menu - [Logging setting].
The Logging Setting window is displayed.
2. Set the logging conditions for images.

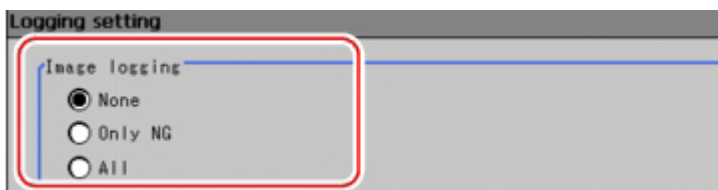

Setting item	Setting value [Factory default]	Description
Image Logging	[None]	No images are saved. When logging images with the processing item "Image Logging", select [None].
	Only NG	Only images with an overall judgement of NG are saved.
	All	All measured images are saved. Note, however, that some images may not be saved if "Measurement" is set in "Logging priority" in step 4.

3. Set the logging images save destination.

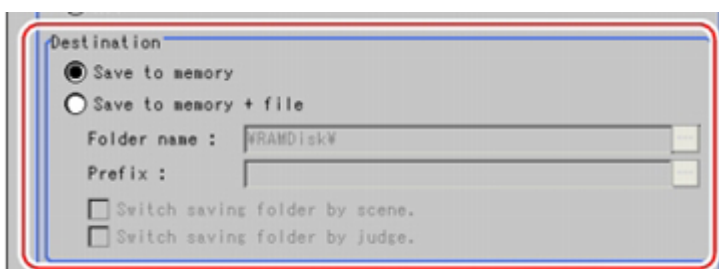

Reference

- In order to perform fast logging, image files are first saved in the controller memory. Note, however, that the controller memory for saving images is a ring memory. If the maximum number of save images is reached, images will be overwritten starting with the oldest saved image if further images are saved. Reference: ▶ About Number of Logging Images (p.346)
The controller memory is cleared if the power is turned off again.
To keep images, select "Save to memory + file" and save images to USB memory, etc.

Setting item	Setting value [Factory default]	Description
Destination	[Save to memory]	Saves to the controller memory.
	Save to memory + file	Images saved to the controller memory are saved to a USBDisk or RAMDisk as files.

When "Save to memory + file" in "Destination" is selected, set the destination and file names.

Setting item	Setting value [Factory default]	Description
Folder name	<ul style="list-style-type: none"> [RAMDisk] USBDisk 	Specify the image file save destination (RAMDisk or USB memory). Logging images are saved in the specified save destination folder.
Prefix	-	Sets the prefix for the save file name. The set character string is added at the beginning of the name of the save file.
Switch saving folder by scene	<ul style="list-style-type: none"> Checked [Unchecked] 	If checked, folders that correspond to scene numbers are automatically created and image files are divided by scene and saved.
Switch saving folder by judge	<ul style="list-style-type: none"> Checked [Unchecked] 	If checked, OK/NG folders are automatically created and image files are divided by scene and saved.

"Save to memory + file" setting example and save destination

Example of setting	Destination
<ul style="list-style-type: none"> Folder name: USBDisk Prefix: image_ "Switch saving folder by scene": Checked "Switch saving folder by judge": Checked 	Saving will be performed as follows for the settings example on the left <ul style="list-style-type: none"> OK image save destination: \USBDisk\S000-000\OK\image_(Measurement ID).IFZ NG image save destination: \USBDisk\S000-002\NG\image_(Measurement ID).IFZ

4. Set the image logging priority conditions.

This setting is only valid when "Save to memory + file" is selected in the image logging saving conditions.

When the measurement takt time is short, time lag may occur with writing from the controller memory to the RAMDisk or USBDisk and temporary absences of free capacity in the controller memory may occur. Select whether logging or measurement has priority at these times.

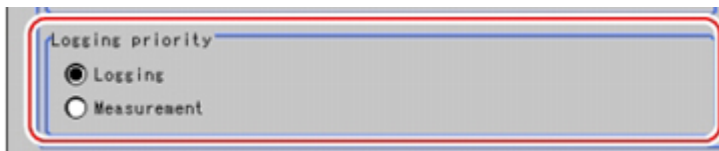

Setting item	Setting value [Factory default]	Description
Logging priority	[Logging]	When there is no free capacity in the controller memory, subsequent measurement cannot be received until free capacity becomes available. All measurement target images are logged, but the measurement takt time becomes longer.
	Measurement	Measurement will continue even if there is no free capacity in the controller memory. New logging is not performed until free capacity becomes available in the controller memory. The measurement takt time is maintained, but some measurement may not be logged.

5. Set the data logging conditions.

The data format is set with the processing item "Data Logging".

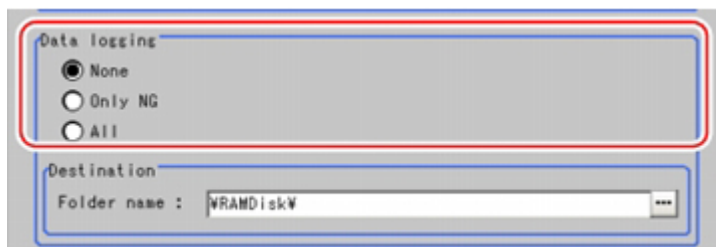

Setting item	Setting value [Factory default]	Description
Data Logging	[None]	Measurement data is not saved.
	Only NG	Measurement data is saved when an NG error occurs in a unit before "Data Logging". If an NG error occurs after the "Data Logging" processing unit, data logging is not performed.
	All	All measurement data is saved.

6. Set the logging data save destination.

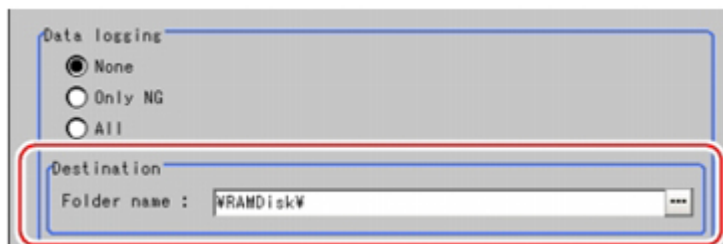

Setting item	Setting value [Factory default]	Description
Folder name	<ul style="list-style-type: none"> · [RAMDisk] · USBDisk 	The data is saved in the specified destination folder (RAMDisk or USBDisk). Set the file name with the processing unit [Data Logging].

Important

- If a USB memory or a network drive is specified as the save destination, the processing time may be longer or fluctuate. Be sure to check it thoroughly before starting an operation.
- When image logging or data logging is executed for a network drive, the communication may be disrupted and the logging process may not be executed successfully due to the controller measurement load that becomes too heavy when the multiple image input function is used. In this case, set a reasonable amount of measurement takt time.

Reference

About loading data to a PC

- Factory settings are set so that logging data is saved in the controller RAMDisk. When logging data is loaded to a PC, set USBDisk as the save destination. Logging data is first saved to the controller RAMDisk and then can be copied from the RAMDisk and saved to the USBDisk using "Copy files" in "Save to file".

7. Tap [OK].

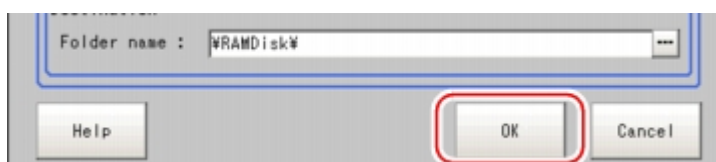

Settings are confirmed and the Logging Setting window closes.

Important

- Logging images saved in the controller memory are overwritten starting with the oldest image if the upper limit for the number of save images is exceeded.
Reference: ▶ About Number of Logging Images (p.346)
- The data saved in the controller memory or RAMDisk is deleted when the controller is restarted.

Reference

About image logging

- When the number of files in the save destination folder increases, the time needed for image saving increases.
- If "Camera Image Input" is used several times in a flow, the image from the last "Camera Image Input" is saved.
- If image transfer is disabled using the camera selection setting for the [Camera Image Input] unit, black images are saved instead of images from the disabled camera.

About number of images that can be saved

- This will vary depending on the size of the images and the resolution of the connected number of the camera.
- The number of images that can be saved on the RAMDisk or USBDisk depends on free capacity.
 - If RAMDisk is selected, this depends on the RAMDisk memory capacity.
 - If USBDisk is selected, this depends on the USBDisk capacity.
- Note that the following restrictions apply to USBDisk.
 - When saving image files directly under the root directory, the number of images that can be saved is about 126.
 - When saving in sub-folders (\\USBDisk\\SUB, etc.), a maximum of 999 images can be saved in each folder. Change to a different folder to save another 999 images up to the maximum memory capacity.

Analyzing Logging Data

Acquired data is referred to and processed, and settings are analyzed.

Checking Logging Data with a PC

This section uses the example of saving logging data in the USB memory.

- Copy logging data saved to the USB memory to the PC.
- Open folder with copied data.

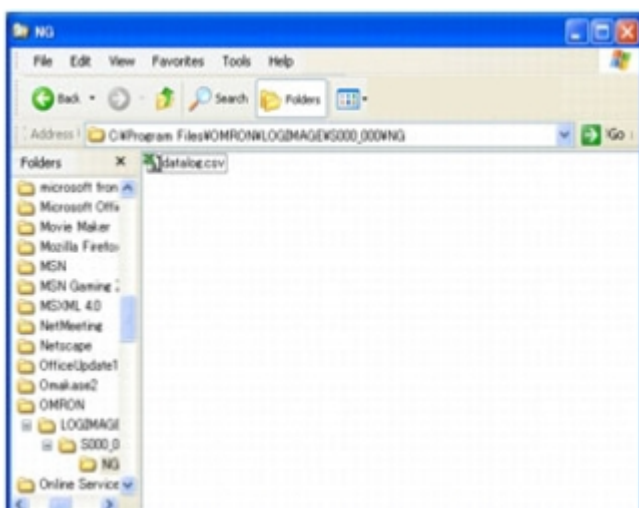

- Open using an application associated with the extension (csv).
Explanation is given here using examples displayed in Excel.

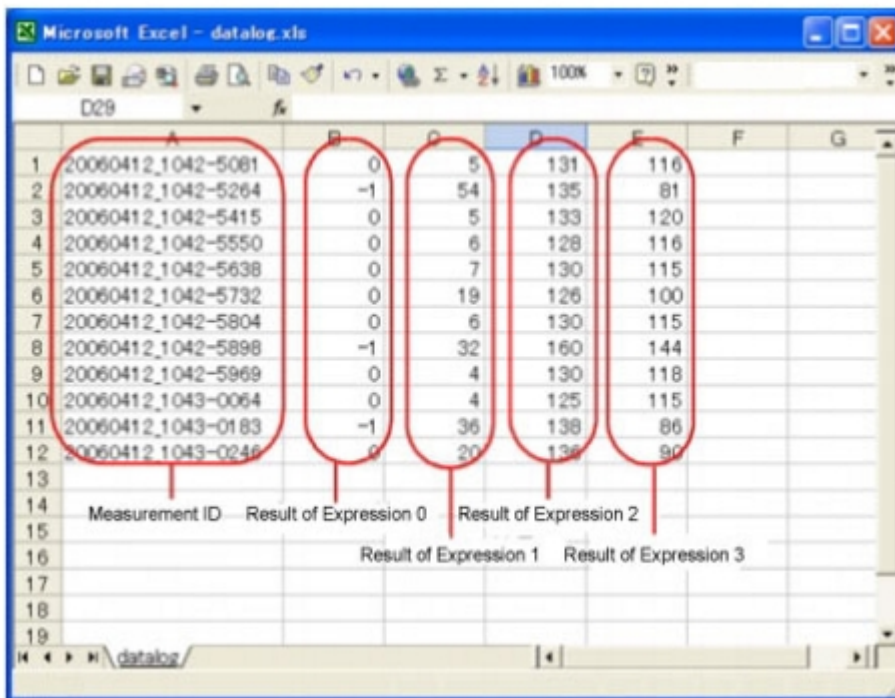

- Use Excel graphing and functions to process and analyze data. For example, the optimum threshold value can be calculated.

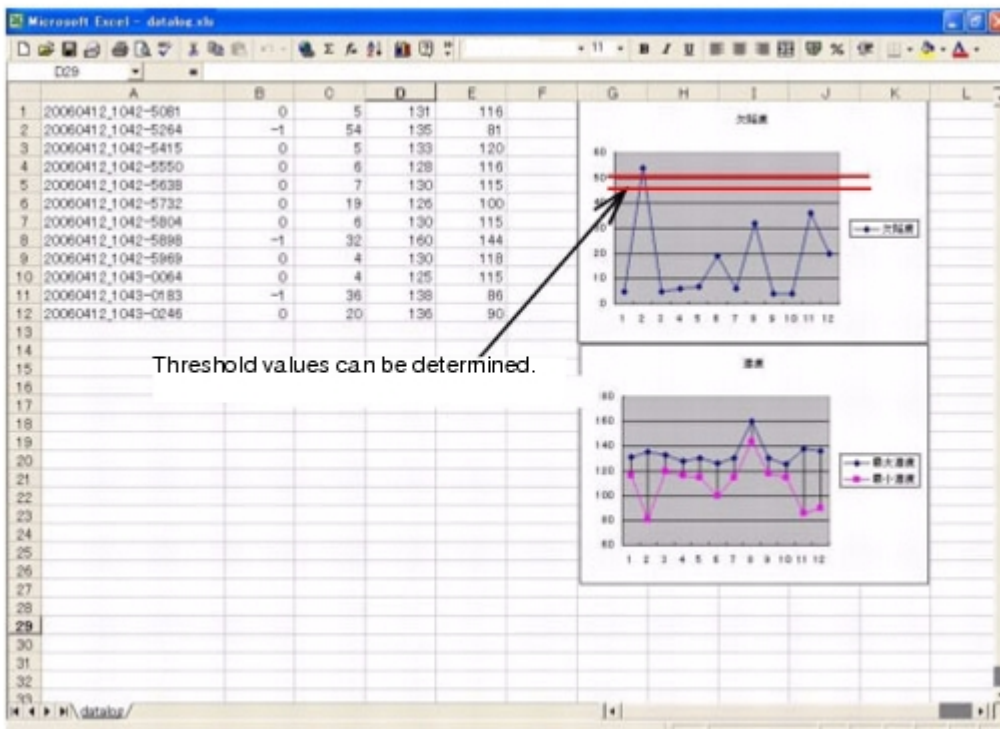

Comparing Logging Data and Logging Images

Compare image and measurement data to confirm correctness and to make analyzing trends for when NG occurs easier.

The measurement data and image data stored through the logging function is associated through

measurement IDs based on the measurement date and time.
 In this way, measurement data can be made to always correspond with image data.
 Verify data with the measurement ID.

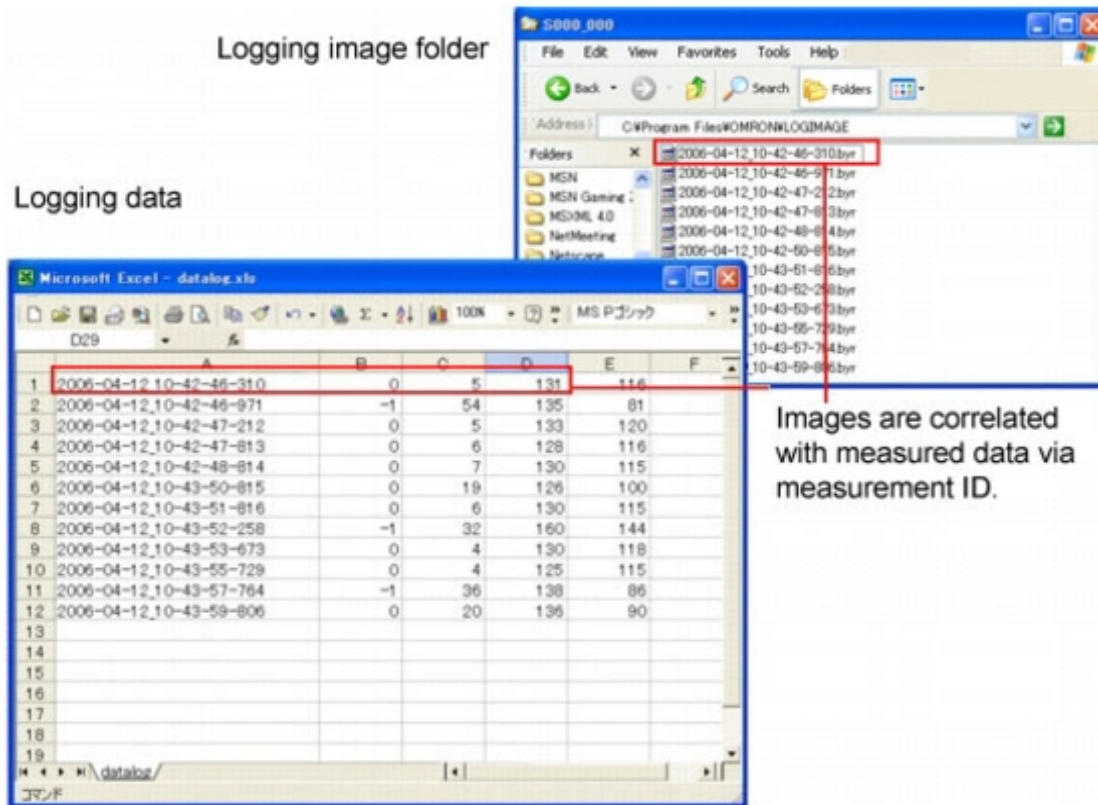

Clearing Measurement Results

Clears all of the currently displayed scenes.

This function sets the expression which calculates the measurement count, and is convenient when that count is to be reset.

1. On the Main screen, tap [Measure] - [Clear measurement].
A confirmation window is displayed.
2. Tap [OK].



The measurement results are deleted.

Clearing Saved Images

Clears all of the logging images that are currently logged in the controller.

1. On the Main screen, tap the [Measure] menu - [Clear logging image].
A confirmation window is displayed.
2. Tap [OK].

Note

- If you want to keep the logged images as files, save the logged images to the USB memory device by tapping [Data] - [Save to file] - [Logging image] before clearing them.
Reference: ▶ Saving Logging Images to RAMDisk/USB Device (p.122)

Capturing Screens

The contents displayed in the monitor screen can be captured. Saved images can be loaded into the PC and pasted to documents.

Important

- Capture takes a few seconds and measurement cannot be performed at this time.

1. Open the measurement manager bar at the bottom right of the Main screen and tap [Capture].



Note

- The same operation can also be performed by tapping the [System] menu - [Screen capture] - [Screen capture].
- When capture is performed from the measurement manager bar in multi-line random-trigger mode it always saves to the destination set for line 0.

About capture image files

This section explains the format and file names for capture images. With factory settings, capture images are saved to the RAMDisk. The save destination can be changed.

Item	Description
File format	The file format is BMP.
File name	The file name is the date and time at which capture was performed. YYYY-MM-DD_HH-MM-SS-MS.BMP Year (4 digits) -Month- Date_ Hour- Minute- Second- Millisecond Example) The file name for a capture date and time of 3/10/2007, 11:25:30.500: 2007-03-10_11-25-30-500.BMP

Note

- The following windows cannot be captured.
 - The window to select a file or a folder
 - Confirmation message window when LCD is turned off

Setting the Save Destination for Captured Images

Sets the save destination for the image captured with the screen capture function.

1. On the Main screen, tap the [System] menu - [Screen capture] - [Screen capture setting].
The Screen Capture Setting window is displayed.
2. Specify the save destination for captured images.

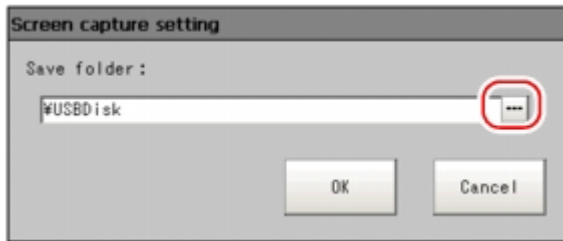

3. Tap [OK].
The settings are determined and the Screen Capture Setting window closes.

Using Tool

This section describes adjustments during startup and convenient tools for operations.

▶ Reference: Using NG Analyser (p.108)

Using NG Analyser

Start the NG analyser by selecting [Tool] - [NG analyser] from the controller menu.

This tool, which analyzes setting flows, is used mainly in 2 ways.

- Adjustment of measurement setting values during start-up
Use sample work images to analyze optimal setting values for the processing flow.
- Analysis of NG causes during operation
Use logged images to analyze NG causes.

The operation flow is as follows.

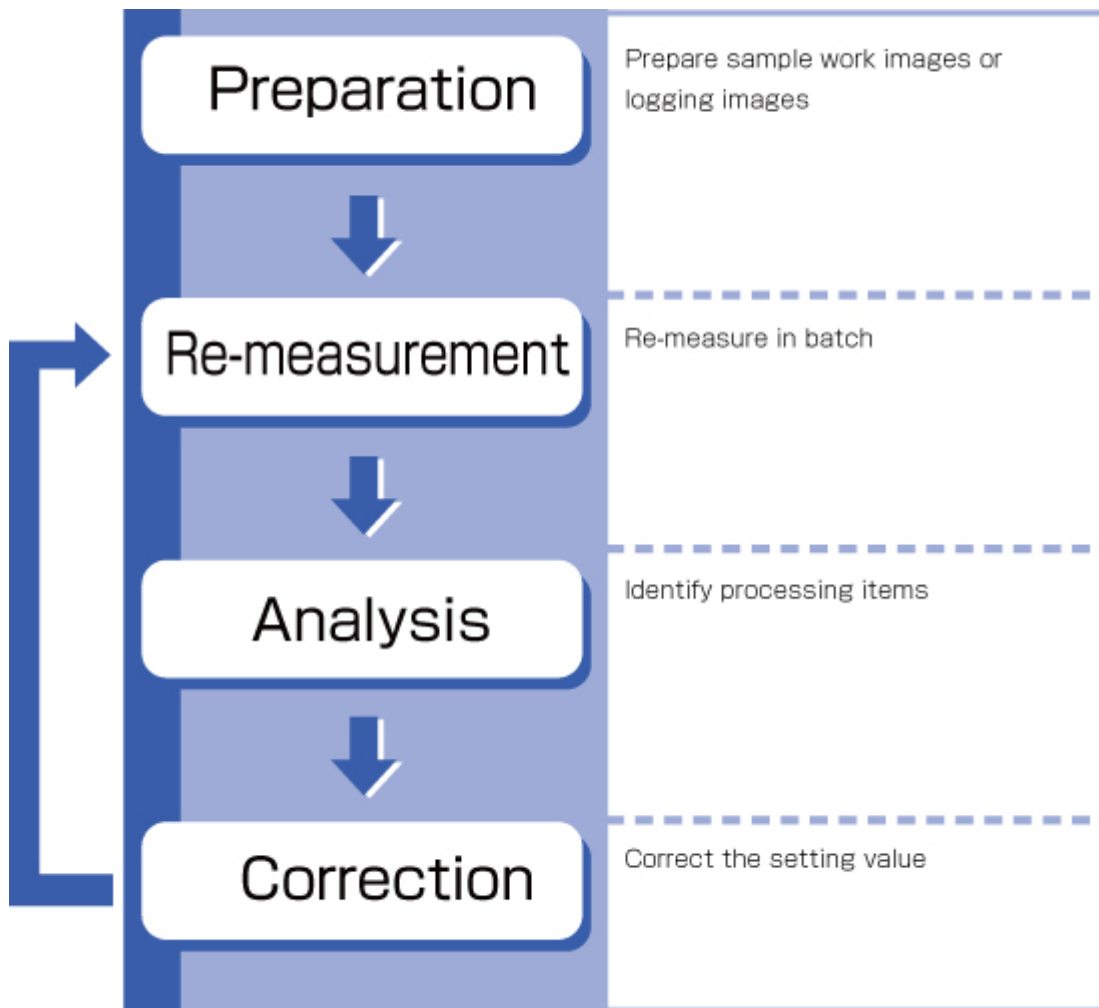

Layouts of NG Analyser Screens

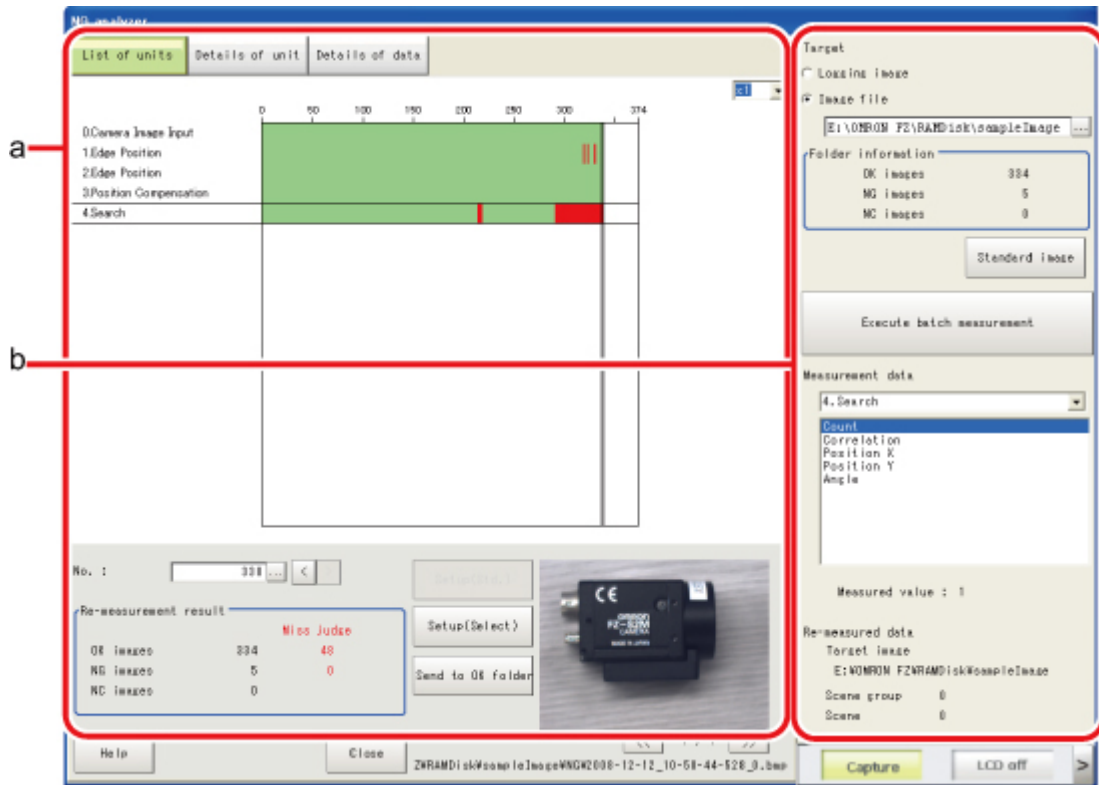

a. Analysis result display area

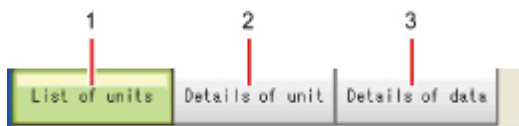

1. List of units
A list of units currently set is shown together with analysis results.
2. Details of unit
Detailed analysis results of each unit are shown.
3. Details of data
Detailed results of analysis data are shown.



Sets magnification to display.



1. Image display area
Displays selected images.
2. Image selection
Selects the image number to be displayed in the image display area.
Images can be displayed by directly tapping the analysis result window.

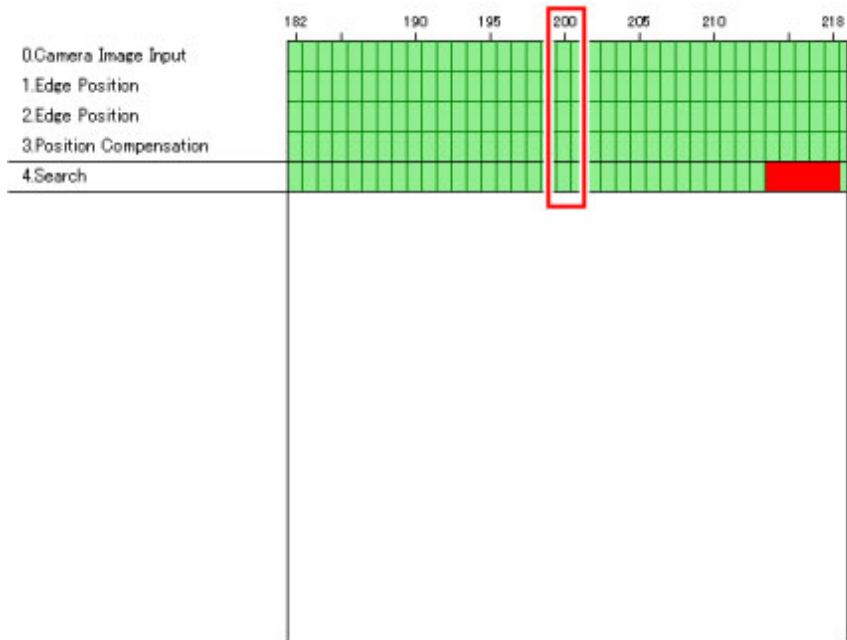

b. Control area

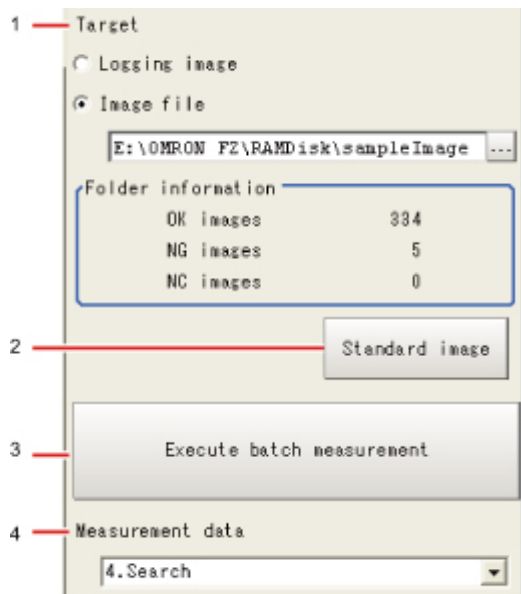

1. Target
Sets images to be measured.
2. Standard image
Sets the image to be used as a reference for analysis.
3. Execute batch measurement
All of the specified target images are measured continuously.

4. Measurement data

Display the desired unit in the list of units and select the unit based on details of unit and details of data.

Using Method of NG Analyser

Important

- Classify sample images beforehand into the OK folder containing images you want to judge OK or NG folder containing images you want to judge NG. (The applicable file types are "*.IFZ", "*.BYR" and "*.BMP".)
- Do not input external commands or STEP signals while the NG analyser is running (excluding during non-stop adjustment).

1. On the Main screen, tap [Tool] menu - [NG analyser].
The analyser screen is displayed.

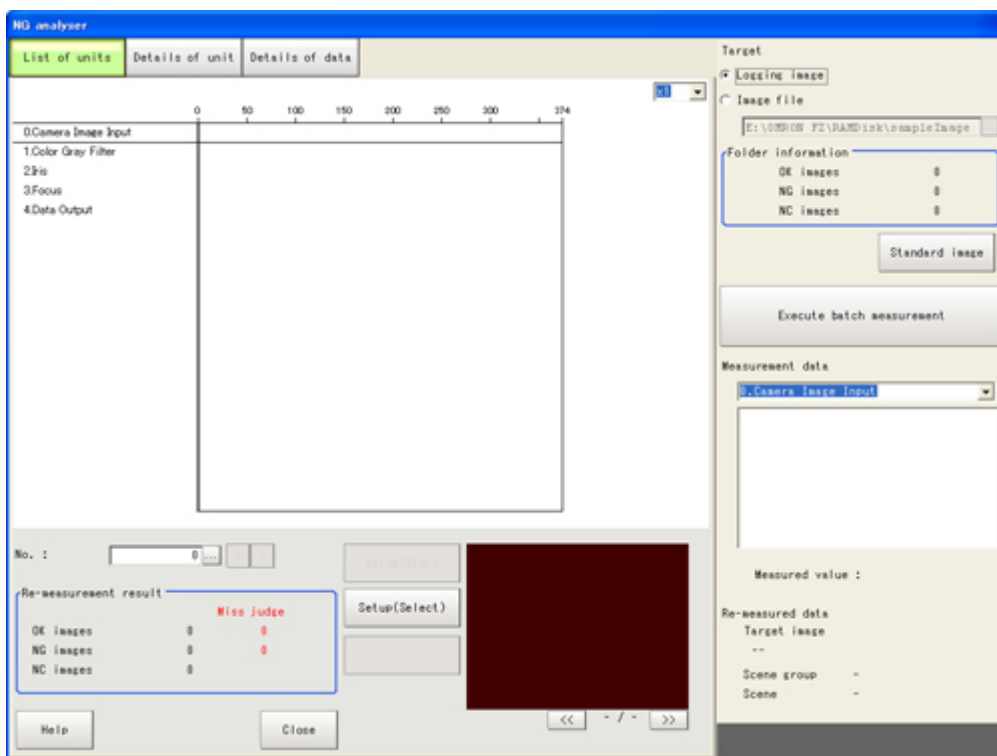

2. Specify the image file.
Specify the upper rank folder containing the OK and NG folders.
Although logging images of the controller can be set as the target, all logging images of the controller, if selected, are treated as "Not yet judged."



You can also set a reference image to perform adjustment.



- The files in the folder are displayed.

		Miss judge
OK images	334	48
NG images	5	0
NC images	0	

- Tap [Execute batch measurement].
All images in the folder are measured in batch.

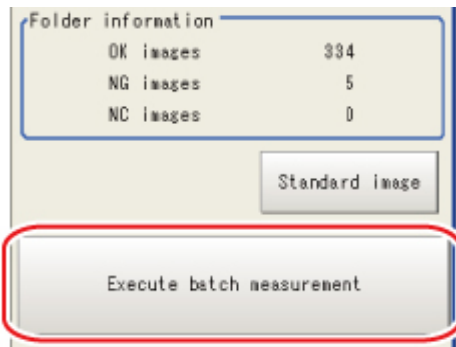

- Measurement results are displayed.
The results in the OK folder are shown first, followed by the results in the NG folder. Green indicates OK, while red indicates NG.

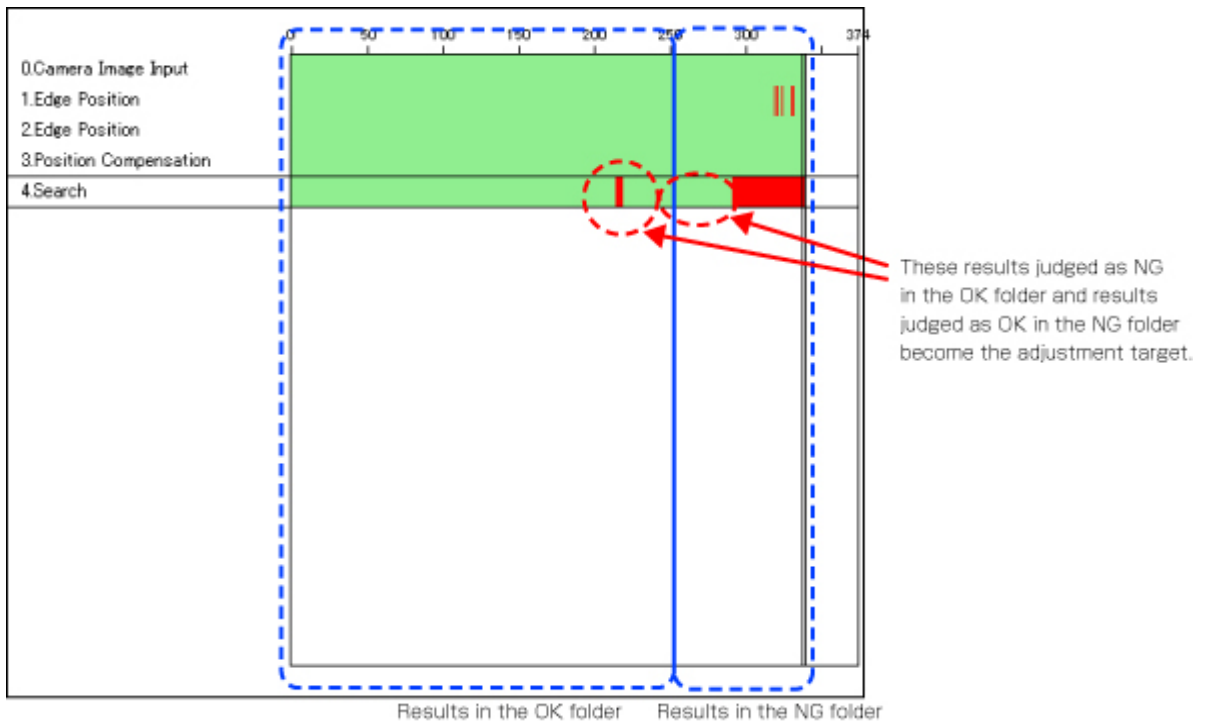

- Adjust the setting values of each unit until no images are falsely judged.
- Select the processing item to be adjusted, and tap [Details of unit].

In the above example, [Search] becomes the adjustment target.

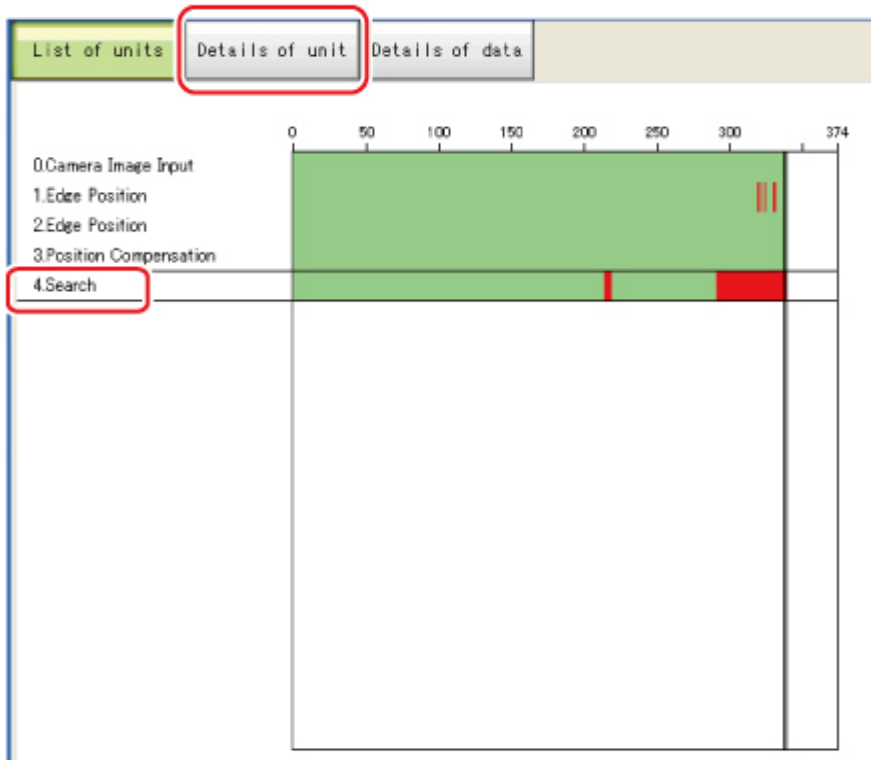

7. The cause of NG is displayed. To check the details of values further, tap [Details of data].

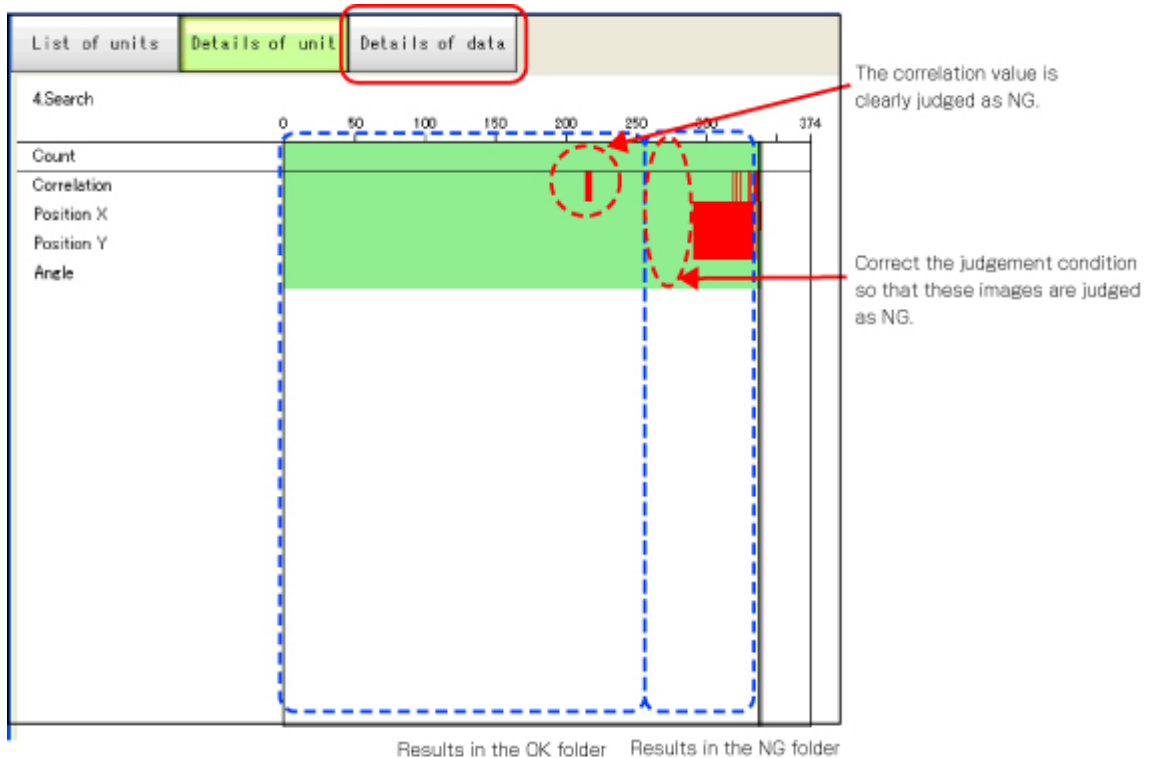

8. Adjust the processing item by referring to the displayed content.

In the following example, Correlation values are clearly lower on some screens.

Based on the revealed cause of false judgement, use the [Set up(Std.)] and [Set up(Select)] buttons to change the setting values of the processing unit.

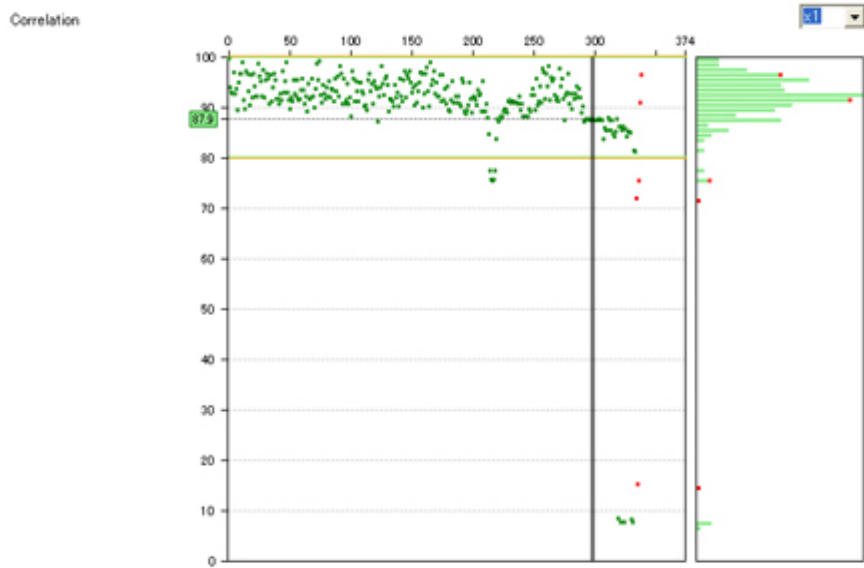

9. Repeat steps 5 to 8 to correct the setting values corresponding to all causes of false judgement.
10. Select [Execute batch measurement] to confirm that no images are falsely judged.
If there are still falsely judged images, repeat the same procedure until a re-measurement finds no falsely judged images.

Note

- OK/NG judgements can be changed by using [Send to OK folder] and [Send to NG folder] buttons. In this case, the changes will not be reflected until re-measurement is performed.



Saving/Loading Data

This chapter explains the methods for saving and loading settings and image data.

- ▶ Reference: Basic Knowledge about Data Saving (p.116)
- ▶ Reference: Saving Settings Data to Controller Memory (p.118)
- ▶ Reference: Saving Settings Data to RAMDisk/USB Device (p.120)
- ▶ Reference: Saving Logging Images to RAMDisk/USB Device (p.122)
- ▶ Reference: Copying/Moving Files (p.124)
- ▶ Reference: Loading Settings Data to Controller (p.126)

Basic Knowledge about Data Saving

This section explains methods for saving and loading settings data and image data.

About Saving Areas

The following saving areas can be used with this device.

Saving area		Description
Controller	Flash memory	Settings data is saved in this area. Data is held even after the power is turned off.
	On-board memory	This is the area where images are temporarily stored when logging images using the logging function. This memory is a ring memory, and images will be overwritten starting with the oldest image if the maximum number of save images is exceeded.
	RAM disk	Can be used as a temporary file save destination. Data is cleared if the controller power is turned off. The RAMDisk data can be sent to or received from external devices using the FTP function.
USB memory		Used to back up settings data as a precaution, to copy settings data to another controller, and to load data to a PC. To keep data, save to the USB memory before turning off power to the controller.

Important

During data transfer, do not turn off the power.

- When a message indicating that processing such as saving or loading is in progress is displayed, do not restart the controller or turn off the power. Data will be corrupted and the system will not work properly at the next startup.
- Do not remove USB memory devices during saving or loading. Operation of the controller may damage data or the USB memory.
- Do not change the extension of saved files. If changed, the file cannot be loaded as the setting data. In addition, if setting data in which the extension was changed is loaded, the system may not work properly later.
- Depending on the settings, saving may fail due to insufficient USB memory capacity. If saving fails and the error message "Please check." appears, check to see if there is unnecessary data in the USB memory and save after this data has been deleted.

About USB Drive Names

A controller is equipped with 4 USB interfaces. If multiple USB memory devices are plugged in, specify the USB memory drive that is to be the destination.

The drive names of USB memory devices are called USBDisk, USBDisk2, USBDisk3 and USBDisk4 according to the sequence in which devices are inserted into the controller.

If the controller, however, is started with more than one USB memory device inserted, drive names *1 will be assigned based on the ports in which the USB memory devices are inserted. Depending on the controller type, USB memory devices are recognized and drive name will be assigned using the following sequence.

*1: In the case of FZ3-9 □□ /H9 □□, USB drives are assigned as drives E: \, F: \, G: \ and H: \ in the order in which they are plugged.

- Integrated panel type
1: Left side of the front - 2: Right side of the front - 3: Front of the side face - 4: Back of the side face

- BOX type
 - 1: Lower left of the front
 - 2: Lower right of the front
 - 3: Upper left of the front
 - 4: Upper right of the front

Important**When the BOX type controller is used**

- If USB memory devices are separately connected to adjacent USB interfaces, the contact between USB memory devices may possibly lead to failure or damage.
-

Saving Settings Data to Controller Memory

Saves system data and scene group data on the controller's flash memory. Make sure to save settings data when settings have been changed.

Important

- If "Save to file" is performed for system + scene group 0 data, the data being saved will also be saved to the controller flash memory at the same time. Do not turn off the power during processing. The controller may not start up properly the next time it is turned on.
- During data transfer to USB memory, do not remove the USB memory device until transfer is completed. Data and/or the USB memory may corrupt.

Note

- When using scene groups 1 to 31, only system data can be saved in the controller flash memory. Note, however, that if a USB memory device is plugged in, scene group data can be saved to the USB memory. (For FZ3-9 □□ /H9 □□ , all data are saved in the controller.)

When Using Scene Group 0

1. On the Main screen, tap [Data save] in the toolbar.

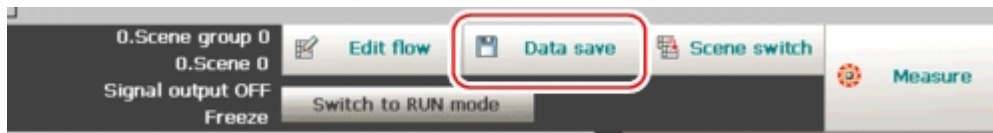

A confirmation message is displayed.

Note

- The same operation is available by tapping [Data] menu - [Data save].

2. Tap [Yes].
System data and scene group data are saved on the controller's flash memory.

When Using Scene Groups 1 to 31

1. Plug a USB memory device into the controller.
2. On the Main screen, tap [Data save] in the toolbar.

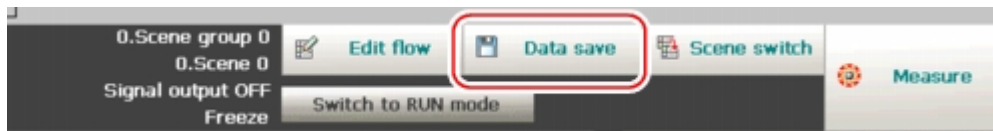

A confirmation message is displayed.

3. Tap [Yes].
System data is saved to the controller's flash memory and scene group data is saved to the USB memory, respectively.

The data from scene groups 1 to 31 is saved to the USBDisk. (For FZ3-9 □□ /H9 □□ , all data are saved in the controller.)

When multiple USB memories are connected to the controller, check in the file explorer window,

etc. that the USB memory where scene group data is to be saved is recognized as the USBDisk.
Reference: ▶ About USB Drive Names (p.116)

Note

- If a USB memory device is not plugged in, a check message is displayed.
If [OK] is tapped, only system data is saved in the controller flash memory.
-

Saving Settings Data to RAMDisk/USB Device

Saves the setting data file to the RAM Disk or USB memory. The data that can be saved is as follows.

Data	Description
System data (*.ini)	Settings data, such as the [System] menu settings contents, which is shared within the controller
Scene data (*.scn)	Data for each scene. Sequence of units set in each scene and setting values of units within scenes.
Scene group data (*.sgp)	The data of scene group with 32 scenes.
System + Scene group 0 data (*.bkd)	Data combining the system data and the data from Scene Group 0.

Important

- During saving, do not restart, turn off power or remove the USB memory. Data will be corrupted and the system will not work properly at the next start-up. It is especially necessary to pay attention when "Save to file" is being performed for system + scene group 0 data, as the data being saved will also be saved to the controller flash memory at the same time.

Note

- When "Save to file" is executed, the data to save is also saved in the controller (except Scene Group Data 1 to 31).

- When saving to USB memory, plug a USB memory device into the controller.
- On the Main screen, tap [Data] - [Save to file].
The Save to File window is displayed.
- Tap [Setting data] and select the data to save.

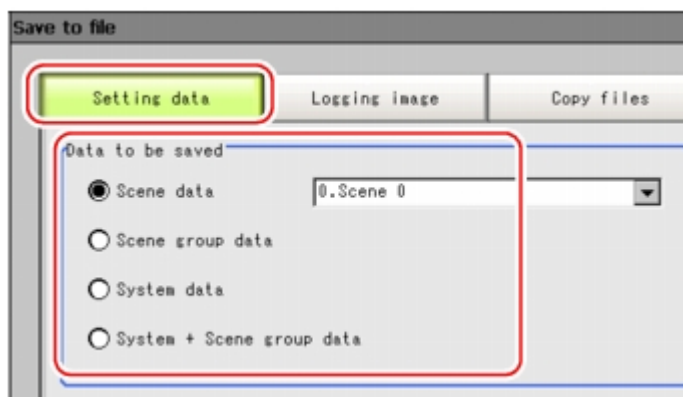

- When scene data is selected, tap [▼] to select the scene number that is to be the save target.



- Specify the save destination folder and file name.



6. Tap [OK].

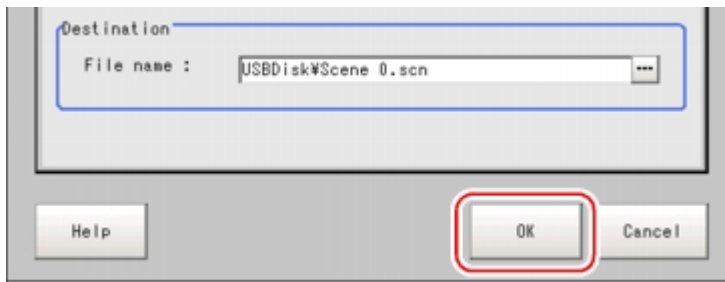

The window showing transfer status is displayed, and the data is sent to the save destination.

Saving Logging Images to RAMDisk/USB Device

Logged image data in the controller memory is saved to RAMDisk or USB memory.

Reference: ▶ About Saving Areas (p.116)

1. When saving to USB memory, plug a USB memory device into the controller.
2. On the Main screen, tap [Data] - [Save to file].
The Save to File window is displayed.
3. Tap [Logging image] and select the file to save.

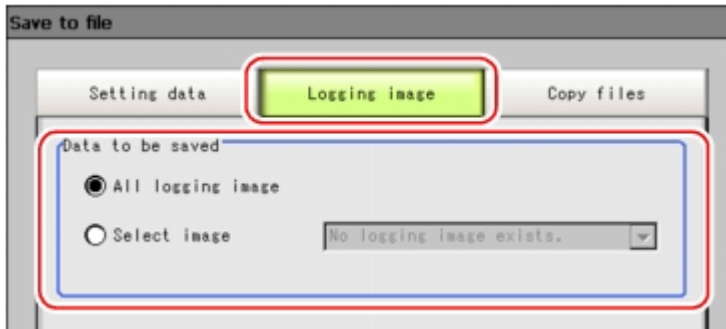

Setting item	Setting value [Factory default]	Description
Data to be saved	[All logging image]	Saves all the logging images.
	Select image	Saves the selected logging image. Tap [▼] and select the image to save.

4. Specify the save destination folder.



5. Tap [OK].



The window showing transfer status is displayed, and the data is sent to the save destination.

How to Use USB Memory (FZ3-9 □□ /H9 □□ only)

The drive information of the controller can be checked.

1. On the Main screen, tap [Other] menu - [System information].
The system information is displayed.
2. Information of each drive is displayed in the [Memory state] dialog box.
If a USB memory is inserted, the [Eject] button is displayed.

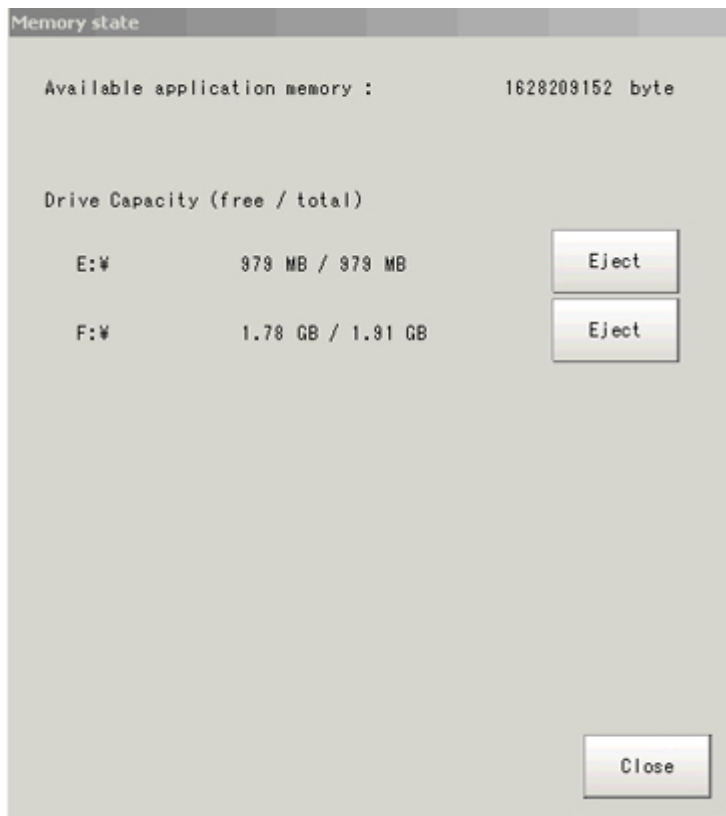

3. To remove the USB memory, tap the [Eject] button.
When the USB memory can be removed

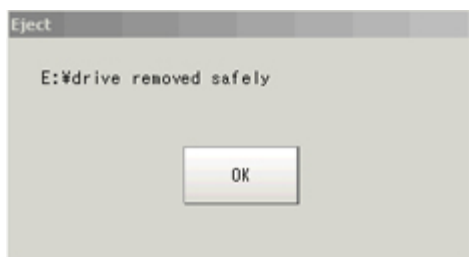

If the removal failed, wait until the USB is no longer accessed and then try removing the USB again.

Important

- Absolutely do not remove the USB memory while the USB memory is being accessed as this can result in a serious malfunction.

Copying/Moving Files

Files can be copied or moved between the controller RAM Disk and USB memory. Images and data saved on the RAM Disk are deleted if the power is turned off. If you wish to keep these images and data, copy or move them to the USB memory. The types of files that can be copied/moved are as follows:

- Settings data (scene data, scene group data, system data)
- Logging Image
- Logging data

1. Plug a USB memory device into the controller.
2. On the Main screen, tap [Data] - [Save to file].
The Save to File window is displayed.
3. Tap [Copy files] and select the file or folder to copy or move.

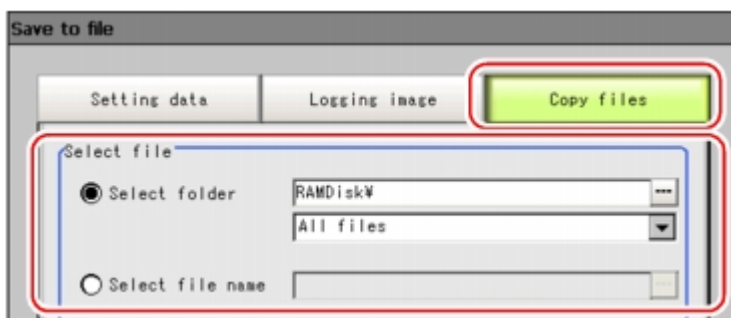

Setting item	Setting value [Factory default]	Description
Select file	[Select folder]	Copies or moves multiple files in a folder. <ul style="list-style-type: none"> • Tap [...] and specify the source folder to copy/move. • Tap [▼] and select the file format. If [All files] is selected, you can copy or move all files in the folder. When any of the file formats is selected, you can specify the type of files (extension) in the folder to copy or move.
	Select file name	Copies or moves the selected file. Tap [...] and specify a file name.

4. If you wish to delete the source file after saving a copy to USB memory, check "Delete original data after save".

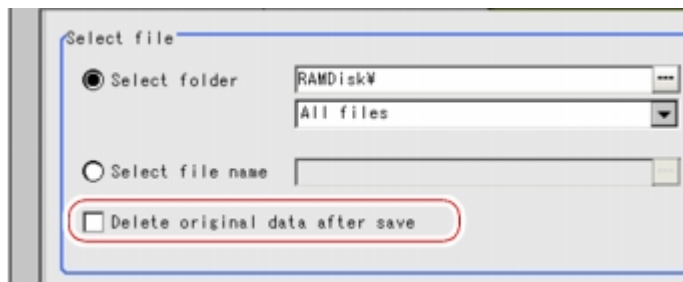

5. Tap [OK].



The window showing transfer status is displayed, and the data is sent to the save destination.

Loading Settings Data to Controller

Loads the settings data saved in an external device to the controller. The scene name and scene group name that have been loaded are displayed in the measurement information display area.

Note

- If "Load from file" is performed for system + scene group 0 data, the data being loaded will also be saved to the controller flash memory at the same time. During loading, do not restart, turn off power or remove the USB memory. Data will be corrupted and the system will not work properly at the next startup.

1. Perform either of the following.
 - Plug the USB memory device which has the load data stored in it into the controller.
 - Send setting data to the controller's RAM Disk via FTP.
2. On the Main screen, tap the [Data] menu - [Load from file].
The Load from File window is displayed.
3. Select the file to load.

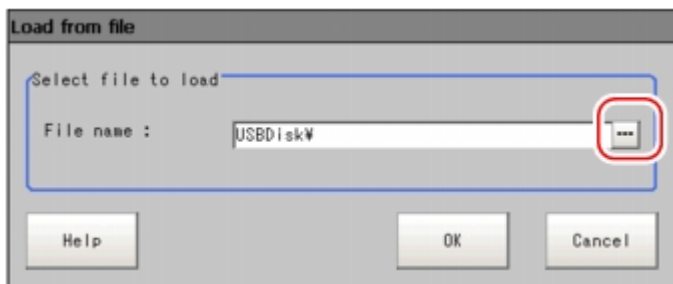

4. Tap [OK].



The window showing the transfer status is displayed, and the data is transferred.

Changing the System Environment

This chapter describes settings related to the controller system environment.

- ▶ Reference: Setting Conditions for Camera Use (p.128)
- ▶ Reference: Setting Conditions Related to Operation during Measurement (p.130)
- ▶ Reference: Setting the System Operation Environment (p.131)

Setting Conditions for Camera Use

Checking Camera Connections [Camera Connection]

Verify whether or not cameras are connected. This section includes no special settings.

1. On the Main screen, tap the [System] menu - [Camera] - [Camera connection].
The Camera Connection window is displayed.
2. Verify the connection status.

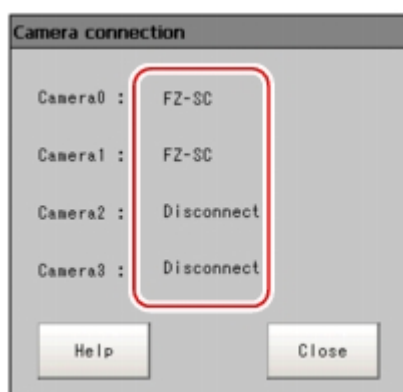

3. Tap [Close].

Setting Trigger Delay [Inter-camera Setting]

This creates settings for the delay from when the input trigger STEP signal is received to until the shutter trigger occurs. When multiple cameras are used, this prevents mutual lighting interference and can be used as a simple trigger delay when only one camera is used.

Note

- The STGOUT pulse width is set in "Electronic flash setting" of the [Camera Image Input] processing item.
Reference: ▶ "Processing Item List Manual", "Electronic Flash Setting" (p.18)

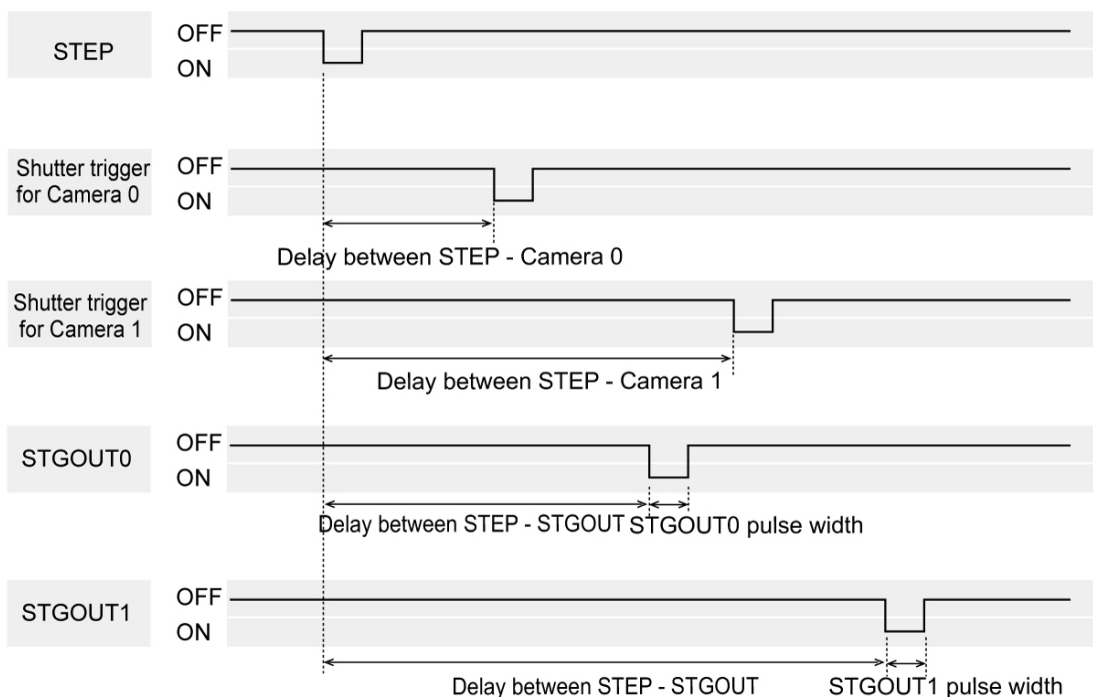

- On the Main screen, tap the [System] menu - [Camera] - [Inter-camera setting].
The Inter-camera Setting window is displayed.
- Tap [...] of each item and set values.

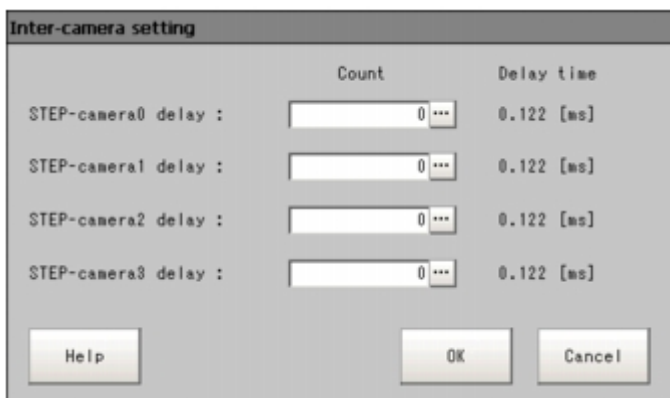

Item	Set value [Factory default]	Description
STEP - Camera 0 delay	[0] to 511 (1 count/30 μs) Max. 15 ms	Set delay between receiving the STEP signal and the beginning of camera exposure. Delay time = count x 30 μs + 122 μs
STEP - Camera 1 delay		
STEP - Camera 2 delay		
STEP - Camera 3 delay		

- Tap [OK].
The settings are confirmed and the Inter-camera Setting window closes.

Setting Conditions Related to Operation during Measurement

With operation during measurement, the following items can be changed.

- Operation when the next STEP signal is input during measurement
- Saving of scene groups during scene group switching

1. On the Main screen, tap the [Measure] menu - [Measure setting].
The Measurement Setting window is displayed.
2. Set each item as required.
When they are not displayed, create settings through the [System] menu - [Controller] - [Create shortcut].

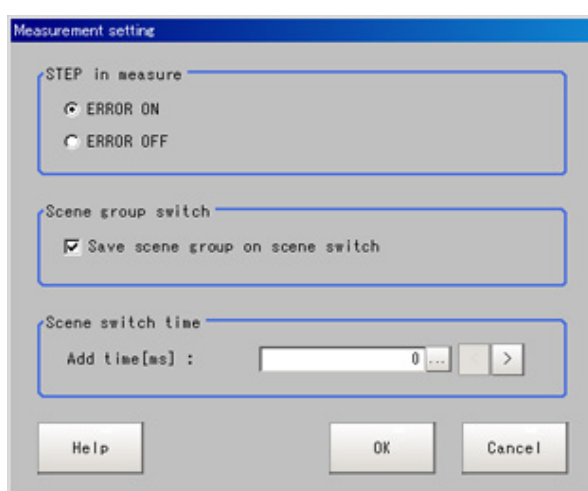

Item	Set value [Factory default]	Description
STEP in measure	<ul style="list-style-type: none"> • [ERROR ON] • ERROR OFF 	Sets whether the ERROR signal output turns on when the following STEP signals are input during measurement.
Save scene group on scene switch	<ul style="list-style-type: none"> • [Checked] • Unchecked 	Sets operation when scene group switching is performed. Sets whether the scene group is saved when it is switched. The scene group switching time can be reduced if the check is removed, but if the power is turned off without saving when settings have been changed, the changed contents will be cleared.
Scene switch time Add time [ms]	0 to 1000 [10]	The BUSY signal is turned on during scene switching. When this time is short and the change from ON to OFF cannot be detected by external devices, the BUSY signal ON time can be added. This is set in 1 ms units. The displayed value can be changed in 5 ms increments by tapping "<" and ">".

Note

- The settings of "Save scene group on scene switch" are linked with the settings of the Switch Scene Group window. Settings specified later override the previous ones.
Reference: ▶ Switching Scenes and Scene Groups (p.65)

3. Tap [OK].
The display returns to the Main screen.

Setting the System Operation Environment

Sets the controller's operation environment. The following settings are available.

- Reference: ▶ Setting the Date and Time [Date-time Setting] (p.131)
- Reference: ▶ Selecting the Language [Language Setting] (p.131)
- Reference: ▶ Setting the Fan Rotation Speed [Fan Control Setting] (p.132)
- Reference: ▶ Setting the Start-up Status [Startup Setting] (p.133)
- Reference: ▶ Setting the RUN Window Display [RUN mode View Setting] (p.138)
- Reference: ▶ Setting the RUN Window Shortcut [Create Shortcut] (p.138)
- Reference: ▶ Setting the Encoder Trigger [Encoder Trigger Setting] (p.139)
- Reference: ▶ Setting the STEP Input Detection Pulse Width [STEP Setting] (p.141)
- Reference: ▶ Setting the RUN Window Password [Password Setting] (p.142)
- Reference: ▶ Setting a Network Drive [Network Drive Setting] (p.143)

In addition, the controller model and measurement application version can be checked.

- Reference: ▶ Checking System Information [System Information] (p.145)

Setting the Date and Time [Date-time Setting]

Confirm that the date and time on the embedded calendar are correct, and make corrections if they are not.

The log data dates and times, etc. are set based on contents set here.

1. On the Main screen, tap the [System] menu - [Controller] - [Date-time setting].
The Date-time Setting window is displayed.
2. Set the date and time.

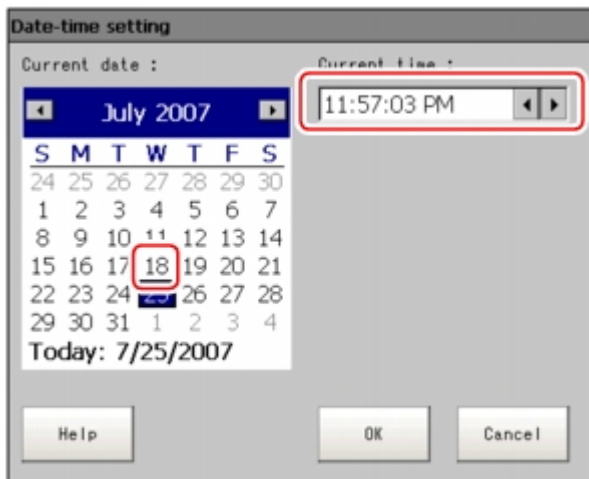

1. Tap the date that is to be set.
2. Set the time.
3. Tap [OK].
The Date-time Setting window closes.

Selecting the Language [Language Setting]

Sets the language used for the characters displayed on the screen. Messages in the application software will be displayed in Japanese or English depending on the language selected here.

Note

- When a controller with default factory settings is started up, the Language Setting window is automatically displayed.
- The controller factory default setting is Japanese language display. If the language setting is changed to English, the system automatically restarts.

1. On the Main screen, tap the [System] menu - [Controller] - [Language setting].
The Language Setting window is displayed.
2. Tap [▼] and select a language.

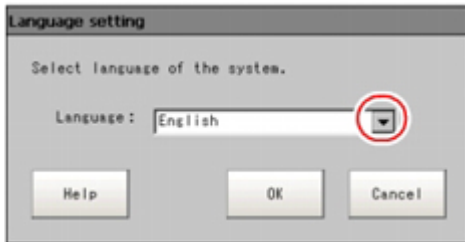

3. Tap [OK].
A confirmation message is displayed.
4. Tap [Yes].



The setting is saved in the controller and the system automatically restarts. After the system restarts, the language switches to the selected one.

Note

- The Language Setting window is displayed also when restarting after executing "System initialization".

Setting the Fan Rotation Speed [Fan Control Setting]

Sets the rotation speed of the controller fan.

(FZ3-3 □ □ /H3 □ □ , FZ3-7 □ □ /H7 □ □ , FZ3-9 □ □ /H9 □ □ only)

Note

- The factory default setting is low rotation. Use fast rotation when using the system in a high-temperature environment between +45 and +50 ° C.

1. On the Main screen, tap the [System] menu- [Controller] - [Fan control setting].
The Fan Control Setting window is displayed.
2. Select a fan setting.

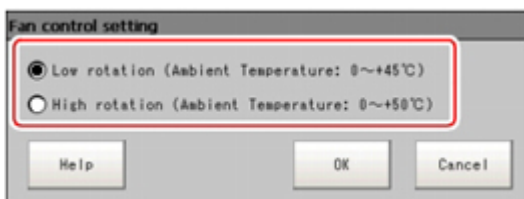

Set value [Factory default]	Description
<ul style="list-style-type: none"> • [Low rotation (Ambient temperature: 0 to +45 ° C)] • High rotation (Ambient temperature: 0 to +50 ° C) 	Select a fan rotation speed.

3. Tap [OK].

Important

- The fan control setting is disabled in the FZ3-L35 □ series.
- For the FZ3-3 □ □ /FZ3-H3 □ □ series, the fan control setting is fixed at low rotation. The setting cannot be changed to fast rotation.(Fast rotation can be selected on the screen, but the setting will not change.)

Setting the Start-up Status [Startup Setting]

The status for when power is turned on is set here.

Inspection can be set to start immediately after the power is turned on by setting the scene number of the scene in which measurement contents are set.

In addition, settings can be done so that the Camera Setting window is not displayed during start-up.

1. On the Main screen, tap the [System] menu - [Controller] - [Startup setting].
The Startup Setting window is displayed.
2. Change the settings.

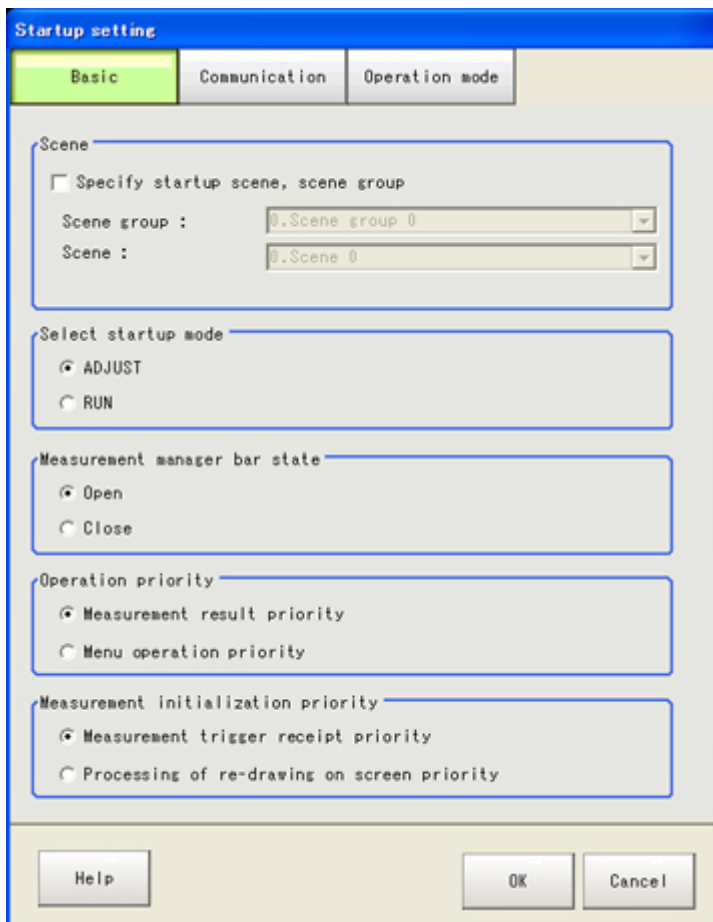

Item		Setting value [Factory default]	Description
Scene			
	Specify startup scene, scene group	Checked	The selected scene/scene group will be the scene/scene group during start-up.
		[Unchecked]	The scene/scene group set in the controller when "Data save" is executed will be the scene/scene group at start-up.
	Scene Group	Scene groups 0 to 31 [Scene group 0]	Selects the scene group displayed during start-up.
	Scene	Scenes 0 to 31 [Scene 0]	Selects the scene displayed during start-up.
Select startup mode		<ul style="list-style-type: none"> • [ADJUST] • RUN 	Selects whether the ADJUST window or RUN window is displayed during start-up.
Measurement manager bar state		<ul style="list-style-type: none"> • [Open] • Close 	Selects whether to display the measurement manager bar during start-up.
Operation priority			Specifies whether measurement results display or menu operation is to have priority.
		[Measurement result priority]	Measurement results display processing is prioritized. Menu operation will be harder to receive due to its lowered priority status.
		Menu operation priority	Menu operation is prioritized. Measurement results display may be incomplete.
Measurement initialization priority			Measurement initialization is performed immediately after scene switching or flow editing. Whether measurement trigger reception or screen re-drawing processing has priority during measurement initialization can be specified.
		[Measurement trigger receipt priority]	Measurement trigger reception is prioritized even during measurement initialization processing. Display for screen re-drawing processing may be incomplete due to its lowered priority status.
		Processing of re-drawing on screen priority	Screen re-drawing processing is prioritized. Measurement triggers will not be received until screen re-drawing processing is complete.

Communication

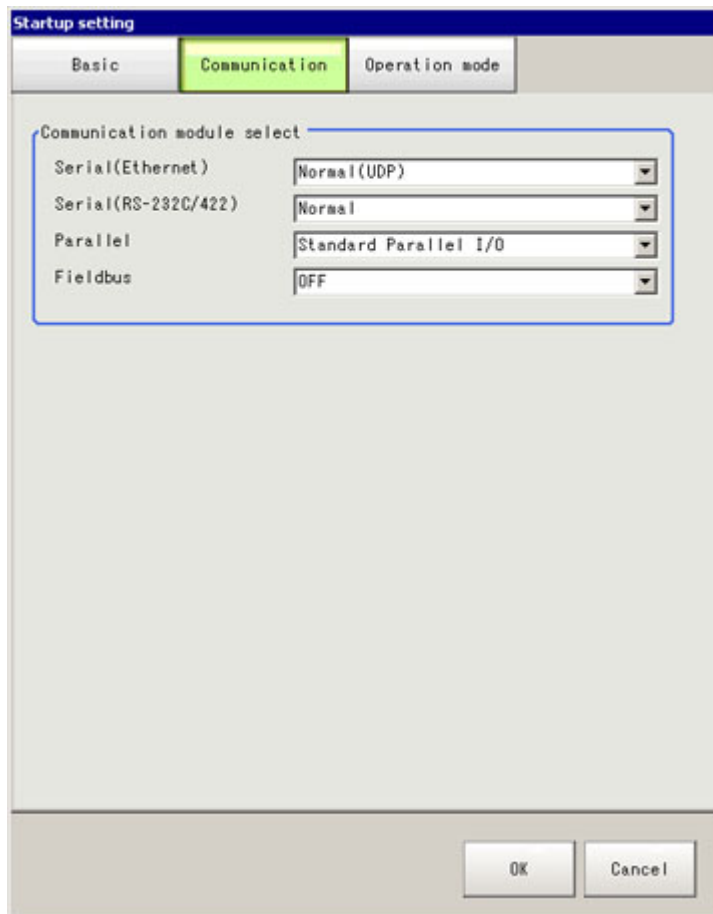

Item	Setting value [Factory default]	Description
Serial (Ethernet)	<ul style="list-style-type: none"> • [Normal (UDP)] • Normal (TCP) • Normal (UDP) (Fxxx series method) • PLC link (SYSMAC CS/CJ/ CP/One) • PLC link (Mitsubishi) 	<p>Specifies the communication module.</p> <p>Serial/Ethernet Normal/Normal (Fxxx series method): Communication is performed with external devices through Normal communication. For differences between Normal and Normal (Fxxx series method), see the following Reference.</p> <p>PLC Link: Communication is performed via a link area with the PLC.</p> <p>Parallel Standard Parallel I/O: Communication is performed via a standard parallel interface.</p> <p>Fieldbus: Communication is performed via EtherCAT communication and EtherNet/IP. EtherCAT is valid only when FZM1 controller is used.</p>
Serial (RS-232C/ RS-422)	<ul style="list-style-type: none"> • [Normal] • Normal (Fxxx series method) • PLC link (SYSMAC CS/CJ/ CP/One) • PLC link(Mitsubishi) 	
Parallel	[Standard Parallel I/O]	
Fieldbus	<ul style="list-style-type: none"> • [OFF] • EtherCAT • EtherNet/IP 	

Important

- Do not set EtherNet/IP and PLC link at the same time. They cannot be used at the same time.
Example)
Set Serial (Ethernet): PLC link and Fieldbus: EtherNet/IP at the same time.
Set Serial (RS-232C/422): PLC link and Fieldbus: EtherNet/IP at the same time.
Set PLC link and Fieldbus: EtherNet/IP at the same time to both serial (Ethernet) and serial (RS-232C/422).
- Do not set PLC link to both serial (Ethernet) and serial (RS-232C/422). They cannot be used at the same time.

Operation mode (FZ3-9 □ □ /FZ3-H9 □ □ only)



Item	Setting value [Factory default]	Description
Operation mode	<ul style="list-style-type: none">Parallel-operation high-speed modeSingle-line High-speed modeHigh-speed logging modeMulti-line random-trigger modeNon-stop adjustment mode	Sets the operation mode. Reference: ▶ Setting Operation Mode (p.30)

- Tap [OK].
Settings are confirmed and the Startup Setting window closes.

Reference

- About Normal (Fxxx series method)

With the Normal (Fxxx series method) communication method, the OK response timing in relation to MEASURE commands is different from that of the Normal communication method.

Normal (Fxxx series method) communication method	Normal communication method
MEASURE	MEASURE
Measurement result	OK
OK	Measurement result

Setting the RUN Window Display [RUN mode View Setting]

The layout of display contents and size of characters can be set.

1. On the Main screen, tap the [System] menu - [Controller] - [RUN mode view setting].
The current RUN window mode is displayed. To change the mode, specify the mode in System/ Controller/Select RUN mode .
2. Set items to be displayed.

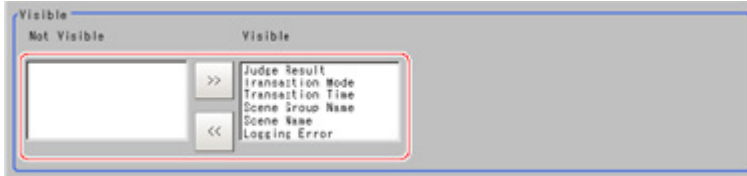

3. Set the layout as required.

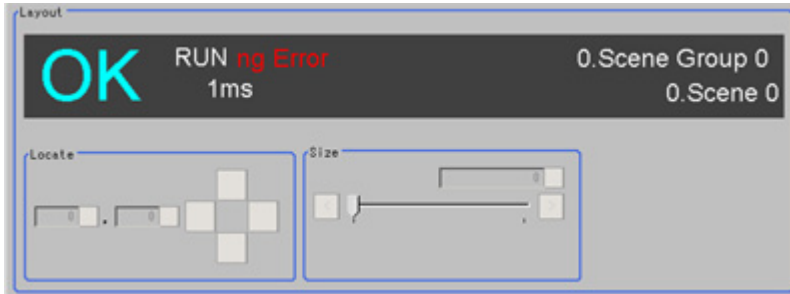

Setting the RUN Window Shortcut [Create Shortcut]

The short cut button can be added to the RUN window. The button is added to the tool box.

1. On the Main screen, tap the [System] menu - [Controller] - [Create shortcut].
2. Set the functions to be added.

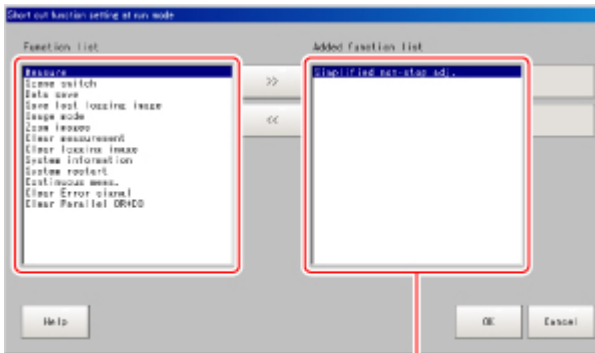

Added short cut

3. Set the sequence as required.
Short cuts are added in the sequence set here.

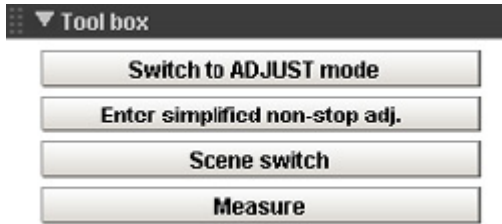

Note

- Some of these short cuts have functions, such as scene switching, which affect measurement. A password protection function can be added in order to restrict use.
Reference: ▶ Setting the RUN Window Password [Password Setting] (p.142)

Setting the Encoder Trigger [Encoder Trigger Setting]

- On the Main screen, tap the [System] menu - [Controller] - [Encoder trigger setting].
- Set the target encoder.

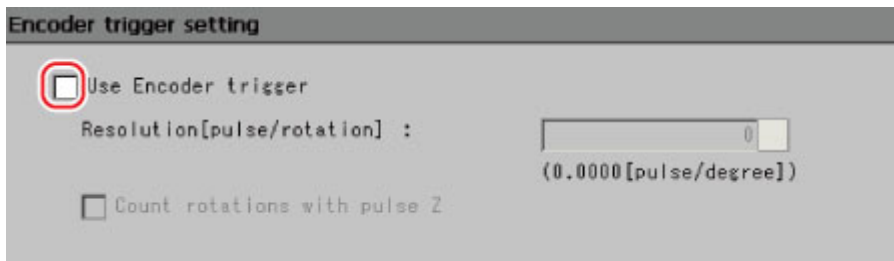

Setting item	Set value [Factory default]	Description
Use Encoder trigger	<ul style="list-style-type: none"> Checked [Unchecked] 	Sets whether the encoder trigger will be used. The maximum input frequency of the encoder trigger is 20 kHz.
Resolution	[1] to 65535	Sets how many pulses equal one rotation. Please set according to the resolution of the encoder.
Count rotations with pulse Z	<ul style="list-style-type: none"> Checked [Unchecked] 	When on, judges whether it made a full rotation with pulse Z. When off, judges whether it made a full rotation based on whether phase A pulse input reaches phase A resolution.

3. Set the trigger detailed settings as required.

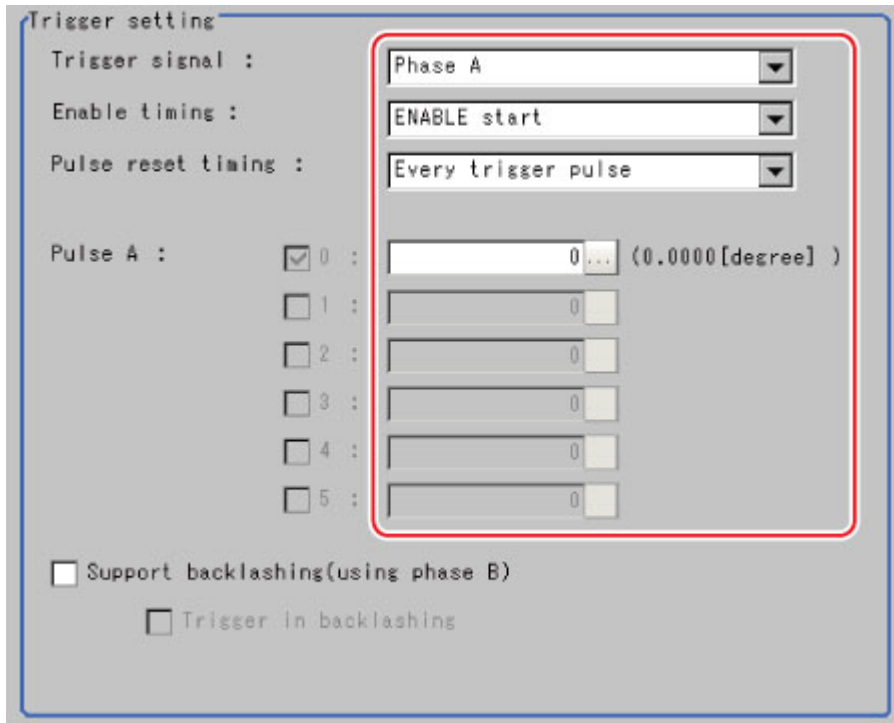

Setting item		Set value [Factory default]	Description
Trigger signal		<ul style="list-style-type: none"> • [Phase A] • Phase Z 	Sets the phase to be used as the trigger signal.
When phase A			
	Enable timing	<ul style="list-style-type: none"> • [ENABLE start] • STEP start 	Sets the timing for starting the pulse count. ENABLE start: Counts the pulses input during the measurement trigger receipt period. STEP start: Does not count pulses even during the measurement trigger receipt period until the STEP signal is input.
	Pulse reset timing	<ul style="list-style-type: none"> • [Every trigger pulse] • Every rotation (Pulse Z) 	Sets the timing for resetting. When it is every rotation, multiple settings for phase A are possible.
	Pulse A	[0] to 65536	Sets how many pulses it takes for the trigger to be produced.
	Support backlashing	<ul style="list-style-type: none"> • [Checked] • Unchecked 	Sets whether the rotation direction is detected.
	Trigger in backlashing	<ul style="list-style-type: none"> • Checked • [Unchecked] 	Sets whether a trigger is produced during reverse rotation.
When phase Z			

Enable timing	<ul style="list-style-type: none"> • [ENABLE start] • STEP start 	Sets the timing for starting the pulse count. ENABLE start: Counts the pulses input during the measurement trigger receipt period. STEP start: Does not count pulses even during the measurement trigger receipt period until the STEP signal is input.
Pulse reset timing	<ul style="list-style-type: none"> • [Every trigger pulse] 	Sets the timing for resetting.
Pulse Z	[0] to 1023	Sets how many pulses it takes for the trigger to be produced.

Important

- The encoder trigger setting is disabled in the FZ3-L35 □ series.

Setting the STEP Input Detection Pulse Width [STEP Setting]

This setting is performed as a countermeasure against STEP input chattering and to prevent operation malfunctions due to entrance of noise.

When Filter Setting Value Is 100 μs (Initial Value)

The STEP signal is detected as being on at the point it is on continuously for at least 100 μs, and measurement begins at this point. Accordingly, STEP signal detection is delayed by an amount of time equivalent to the set filter value. Also, when turning from ON to OFF, the OFF filter fixed at 500 μs is activated and the STEP signal is detected as OFF when it is off for at least 500 μs.

(1) When there is no chattering

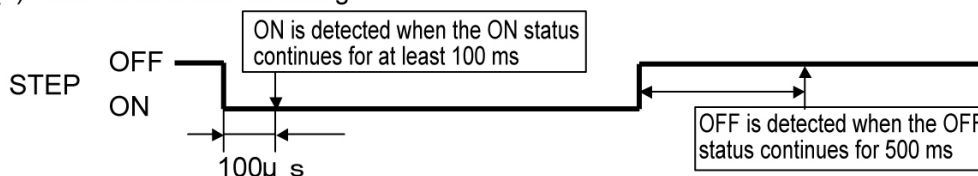

(2) When there is chattering

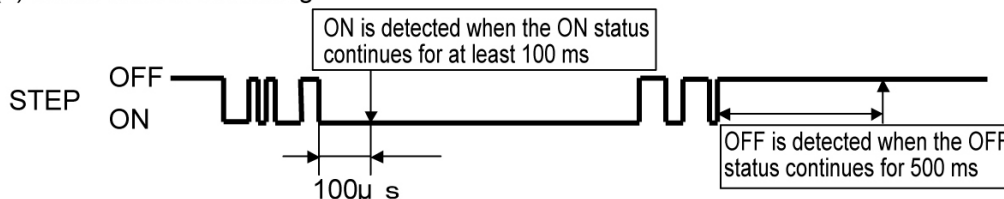

1. On the Main screen, tap the [System] menu - [Controller] - [STEP setting].
2. Set the filter width in the "STEP setting" area.

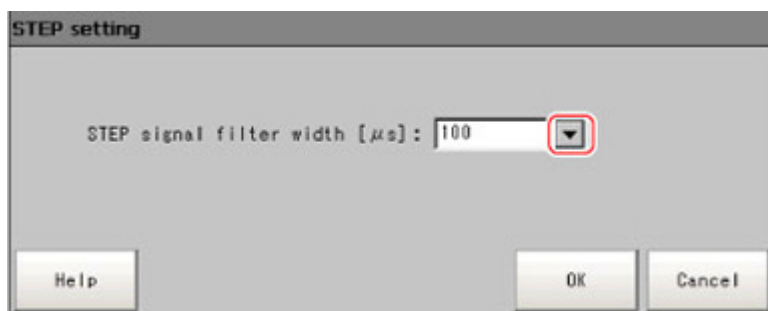

Setting item	Set value [Factory default]	Description
STEP signal filter width [μs]	<ul style="list-style-type: none"> • [100] • 200 • 300 • 400 • 500 	Sets the filter width.

Setting the RUN Window Password [Password Setting]

Operation on the RUN window can be locked with a password.

The following 3 operations can be locked.

- Switching from the RUN window to the ADJUST window
- Performing simplified non-stop adjustment on the RUN window
- Changing screen structure of the RUN window

1. On the Main screen, tap the [System] menu - [Controller] - [Password setting].
The Password Setting window is displayed.
2. Specify each of the following items.

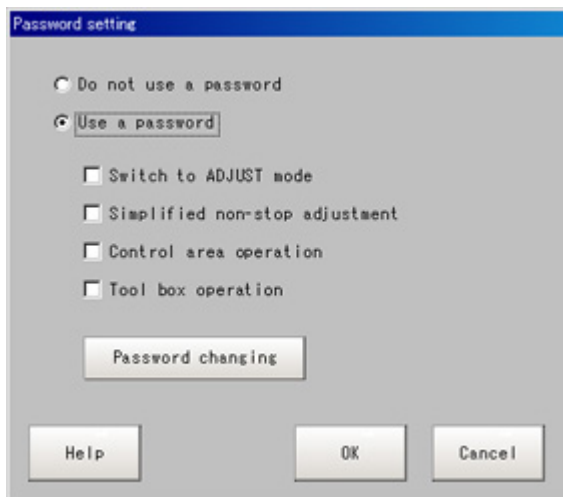

Set value [Factory default]	Description
[Do not use a password]	A password is not used for operation using the RUN window.
Use a password	<p>A password is used when the following operations are performed with the RUN window. Place a check next to the operation items for which a password is to be set.</p> <ul style="list-style-type: none"> • Switch to ADJUST mode • Simplified non-stop adjustment • Control area operation • Tool box operation
Password changing	Tapping this button displays the Password Changing window.

Note

- No passwords are set with the default settings. When setting passwords for the first time, tap [Password changing] and set a password.

Setting or changing a password

1. On the Password Setting window, tap [Password changing].
2. Tap [...].

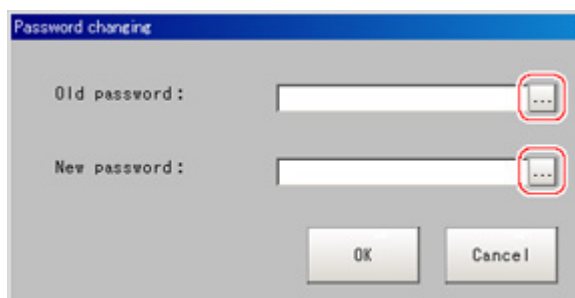

The soft keyboard is displayed.

3. Set "Old password" and "New password".
Use 16 characters or less to Input words.
4. Tap [OK].
The display returns to the Password Setting window.

3. Tap [OK].
A confirmation message is displayed.
4. Tap [OK].

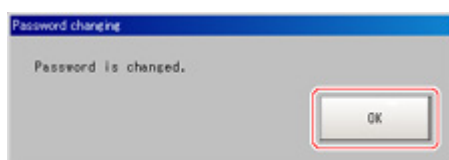

The Password Setting window closes.

Important

- Please contact us if you forget the passwords you set.

Setting a Network Drive [Network Drive Setting]

Set a network drive.

Register the shared folder on a network drive with a shared name. The network drive connected to the Select File/Folder window of the FZ software will be displayed.

1. On the Main screen, tap the [System] menu- [Controller] - [Network drive setting].

2. Select the shared name to be registered, and tap [Edit].

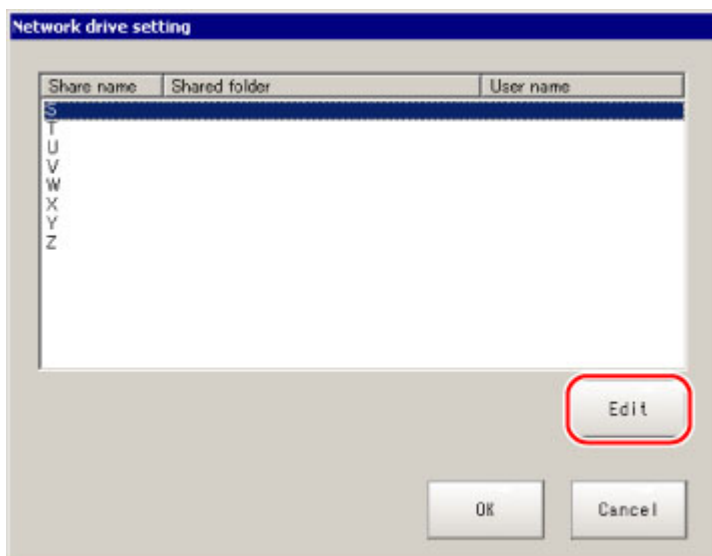

3. Enter the information to be allocated to the network drive (shared name), such as the shared folder, user name and password.

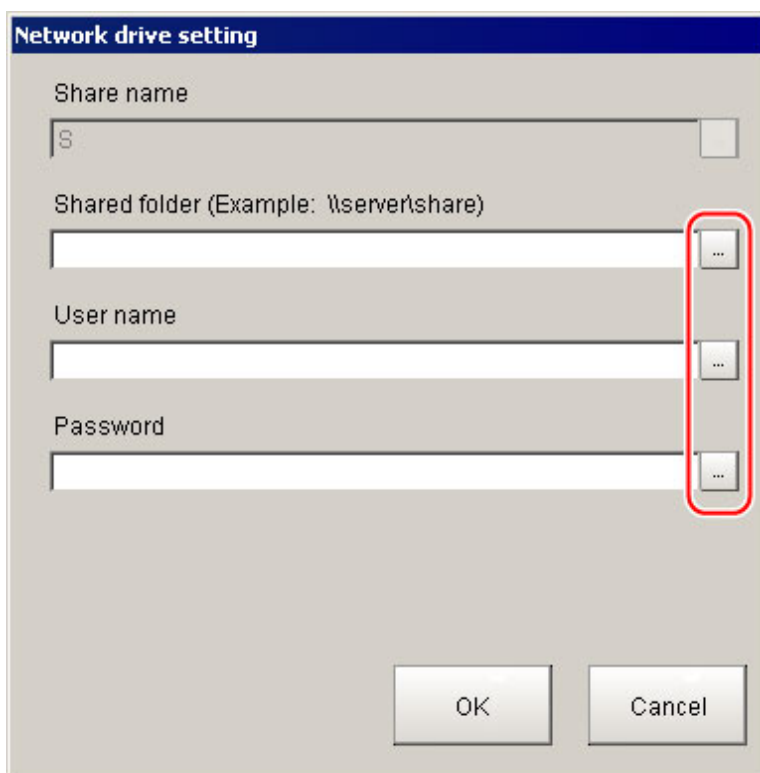

Setting item	Set value [Factory default]	Description
Share name	S,T,U,V,W,X,Y,Z	This is the name to be recognized by the controller as a network drive. Only 1 unit can be connected. For FZ3-L35 □ □ /FZ3-3 □ □ /FZ3-7 □ □ , the shared name is displayed in the \Network folder. For FZ3-9 □ □ /FZ3-H9 □ □ , the drive letters, such as E:, F:, G:, and H:, are displayed.

Shared folder	-	Specify the shared folder name. Specify the name of the folder that has been created in advance on the network drive. For example, if the host name is VISION and the shared name is COMMON, specify a name such as \\VISION\COMMON.
User name	-	Enter the user name and the password to access the network drive.
Password	-	If you are unclear about the user name or the password, contact the device network administrator.

4. Tap [OK].
5. Tap [OK] on the network drive setting screen, and close the screen.

The setting is enabled after the controller is restarted.

Important

- When image logging or data logging is executed for a network drive, the communication may be disrupted and the logging process may not be executed successfully due to the controller measurement load that becomes too heavy when the multiple image input function is used. In this case, set a reasonable amount of measurement takt time.
- If many drives are set as network drives, it may require a greater amount of time to start the controller.
- Do not pull out the LAN cable while the controller is accessing the network drives.
- Start the controller when the network drives are ready. A connection cannot be established if the network drives are not ready when the controller is started.
- If there is no access to a network drive for a certain amount of time, the connection will be automatically cut off depending on the network drive setting of the connection target. Make sure that the setting on the connection target is not set to automatic disconnection.
- Date and time of the update of the file created at network logging
If the time zone of the external device is different from the time zone setting of the controller [GMT-08:00 Pacific Time (US & Canada): Do not automatically adjust clock for Daylight Saving Time], the date and time actually written may be different from the date and time of the file update. Adjust the time zone of the external device to match that of the controller's.

Checking System Information [System Information]

The controller model and measurement application version can be checked.
You can check the USB memory status with FZ3-9□□ /H9□□ series only.
Reference: ▶ How to Use USB Memory (p.123)

1. On the Main screen, tap [Other] menu - [System information].
The System Information window is displayed.
2. Check the information.
The controller model and measurement application version can be checked.



3. Tap [Memory state].
The following information can be checked.
 - Available application memory
The application memory is the memory used by all applications.
By confirming available memory, this provides a rough standard for confirming status

while operating.

- Available data memory (FZ3-L35 □ , FZ3-3 □ □ /H3 □ □ , FZ3-7 □ □ /H7 □ □ only)

The data memory is the amount of memory that can be used for scene group data. Check the available memory that can be used for unit data and settings data for each unit.

4. Tap [Close].

The System Information window closes.





Methods for Connecting and Communicating with External Devices

This chapter describes communication with external devices such as PCs and programmable controllers, etc.

- ▶ Reference: About Connecting with External Devices (p.149)
- ▶ Reference: Communicating through Serial Communication (PLC Link) (p.152)
- ▶ Reference: Controlling/Outputting through Serial Communication (Non-procedure) (p.179)
- ▶ Reference: Control/Output through EtherNet/IP (p.214)
- ▶ Reference: Controlling/Outputting through Parallel Communication (p.221)
- ▶ Reference: Externally Outputting Data through FTP (p.241)

About Connecting with External Devices

With the FZ3, serial interfaces and parallel interfaces can be used to communicate with external devices. With serial interfaces, RS-232C/RS-422 and Ethernet can be selected as communication ports. Non-procedure and PLC link can be used with either communication port. Data transfer through EtherNet/IP (tag data link communication) or FTP is also possible with Ethernet.

Protocols usable with serial interface

The protocols that can be used with a serial interface are listed below.

Non-procedure	Controls the FZ3 through commands from a PC or specialized device. Also possible to control from the PLC.
PLC link	The FZ3 is controlled and measurement results are acquired only through data memory operations in the PLC. The FZ3 reads commands in the data memory (DM) and channel I/O (CIO) in the PLC, executes measurement, and writes execution results to the data memory. This is appropriate when the PLC is used as an external device. The PLC supported by the FZ3 PLC link protocol is the SYSMAC CS/CJ/CP/One series PLC from OMRON (models supporting FINS command) and PLC MELSEC Q series from Mitsubishi Electric Corporation.

With a parallel interface, control such as measurement control, scene group switching, scene switching, clearing errors, clearing measurement values, clearing parallel terminals is possible.

Important

- PLC link function refers to a function that communicates using 3 link areas indicated below: the command area, response area and data output area.
It is different from the serial PLC link protocol used to inter-connect PLCs serially.

Connectable Models

Ethernet

Series name	CPU	Interface	
		CPU built-in port	Ethernet unit
SYSMAC_CJ2	CJ2H	O	CJ1W-EIP21 (PLC link only),CJ1W-ETN21
	CJ1H, CJ1G	-	CJ1W-EIP21 (PLC link only),CJ1W-ETN21
SYSMAC_CJ1	CJ1M	*Built-in type only	CJ1W-EIP21 (PLC link only),CJ1W-ETN21
	CS1H,CS1D,CS1G	-	CS1W-EIP21 (PLC link only),CS1W-ETN21
SYSMAC_CP1	CP1L	-	CP1W-CIF41
	CP1H	-	CP1W-CIF41
SYSMAC_One	NSJ	*Built-in type only	NSJW-ETN21

EtherNet/IP (tag data link communication)

シリーズ名	CPU	Interface	
		CPU built-in port	EtherNet/IP unit
SYSMAC_CJ2	CJ2M,CJ2H	*Built-in type only	CJ1W-EIP21

SYSMAC_CJ1	CJ1H,CJ1G	-	CJ1W-EIP21
	CJ1M	*Built-in type only	CJ1W-EIP21
SYSMAC_CS1	CS1H,CS1D,CS1G	-	CS1W-EIP21

[Note]: When connecting to an EtherNet/IP Unit, the EDS file in which the FZ3 connection information has been defined needs to be installed on the tool (Network Configurator).

Serial

Series name	CPU	Interface	
		CPU built-in port	Serial communication unit
SYSMAC_CJ2	CJ2H	○	CJ1W-SCU21-V1, CJ1W-SCU31-V1, CJ1W-SCU41-V1
	CJ2M	*Built-in type only	
SYSMAC_CJ1	CJ1H, CJ1G, CJ1M	○	CJ1W-SCU21-V1, CJ1W-SCU31-V1, CJ1W-SCU41-V1
SYSMAC_CS1	CS1H,CS1D,CS1G	○	CS1W-SCBxx-V1, CS1W-SCU21-V1, CS1W-SCU31-V1
SYSMAC_CP1	CP1E,CP1L, CP1H	-	CP1W-CIF01
SYSMAC_One	NSJ	○	-

Mitsubishi Electric Corporation

Ethernet

Series name	Model name	CPU name	CPU	Interface	
				CPU built-in port	Ethernet/IP unit
MELSEC-QnU	Universal model	QnUDECPU	Q03UDECPU,Q04UDECPU Q06UDECPU,Q10UDECPU Q13UDECPU,Q20UDECPU Q26UDECPU	○	QJ71E71-100, QJ71E71-B2, QJ71E71-B5
		QnUDCPU	Q03UDCPU,Q04UDCPU Q06UDCPU,Q10UDCPU Q13UDCPU,Q20UDCPU Q26UDCPU	-	
		QnUCPU	Q00UJCPU,Q00UCPU Q01UCPU,Q02UCPU	-	
Basic model	QnCPU	Q00JCPU,Q00CPU Q01CPU	-		
MELSEC-Q series	High performance model	QCPU	Q02CPU,Q02HCPU Q06HCPU,Q12HCPU Q25HCPU	-	
MELSEC-QnAS series	-	-	Q2ASCPU,Q2ASCPU-S1 Q2ASHCPU,Q2ASHCPU-S1	-	

Serial

Series name	Model name	CPU name	CPU	Interface	
				CPU built-in port	Serial communication unit
MELSEC-QnU	Universal model	QnUDECPU	Q03UDECPU, Q04UDECPU Q06UDECPU, Q10UDECPU Q13UDECPU, Q20UDECPU Q26UDECPU	-	QJ71C24N, QJ71C24N-R2
		QnUDCPU	Q03UDCPU, Q04UDCPU Q06UDCPU, Q10UDCPU Q13UDCPU, Q20UDCPU Q26UDCPU	○	
		QnUCPU	Q00UJCPU, Q00UCPU Q01UCPU, Q02UCPU	○	
	Basic model	QnCPU	Q00JCPU, Q00CPU Q01CPU	○	
MELSEC-Q series	High performance model	QCPU	Q02CPU, Q02HCPU Q06HCPU, Q12HCPU Q25HCPU	-	
MELSEC-QnAS series	-	-	Q2ASCPU, Q2ASCPU-S1 Q2ASHCPU, Q2ASHCPU-S1	-	A1SJ71QC24N1, A1SJ71QC24N1-R2

Communicating through Serial Communication (PLC Link)

This section explains how to set the required communication specifications and the input format when using PLC Link to communicate with external devices.

Communication Processing Flow (PLC Link)

Communication between the PLC and FZ3 is performed using the 3 link areas indicated below: the command area, response area, and data area.

The command area is used when control commands are sent from the PLC to the FZ3.

The FZ3 can be controlled by writing commands to the command area.

In the response area, the execution results of control commands described in the command area are written.

The output data accompanying measurement is written to the data output area.

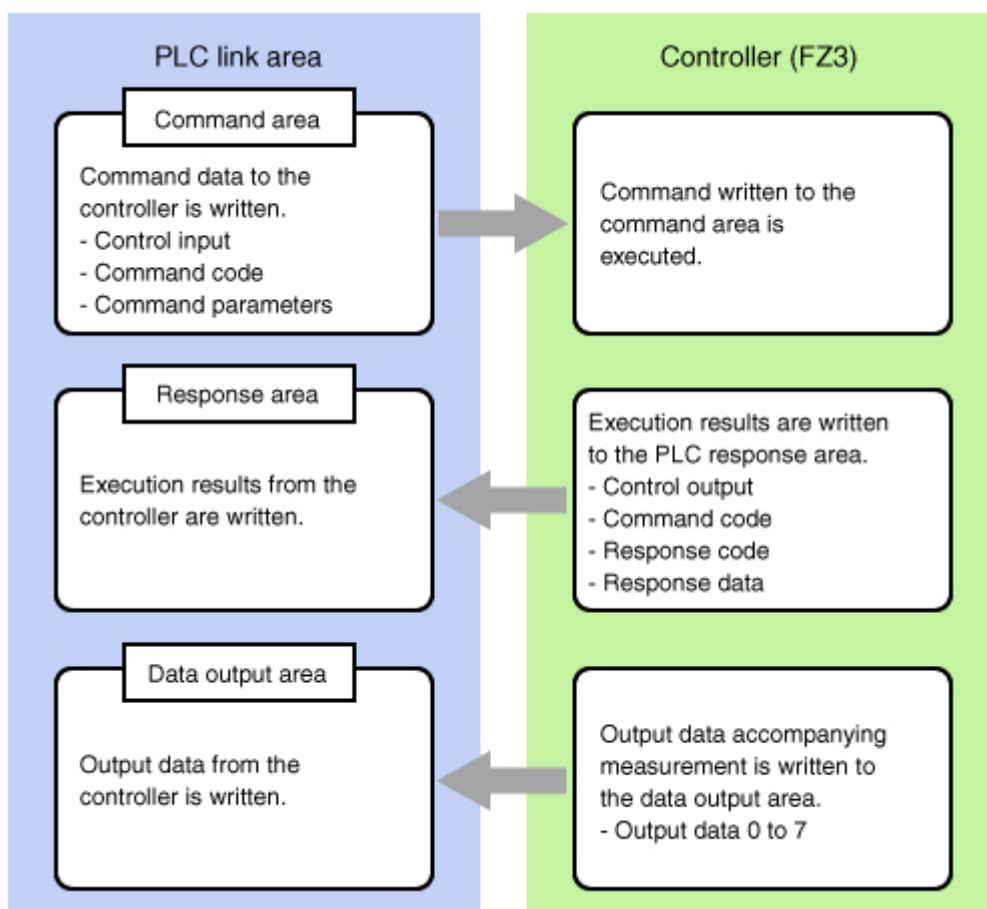

When using PLC Link, it is necessary to specify PLC Link with the communication module.

Reference: ▶ Setting the Start-up Status [Startup Setting] (p.133)

Setting Communication Specifications (Ethernet - PLC Link)

Communication specifications such as link areas or communication speed and data length are set.

Reference: ▶ Setting Communication Specifications (RS-232C/422 - PLC Link) (p.157)

Important

- Before setting the communication specifications, set the "Serial (Ethernet)" communication module to "PLC link (SYSMAC CS/CJ/CP/One)" (or to "PLC link (MELSEC Q series)" in the case of a PLC by Mitsubishi Electric Corporation), save the setting, and then restart the system. When the system is restarted, the communication settings are initialized.

Reference: ▶ Setting the Start-up Status [Startup Setting] (p.133)

- Use the same communication specification settings for the controller and the external device.
- When making system settings/Ethernet settings, do not send external input into the Ethernet.

1. On the Main screen, tap the [System] menu - [Communication] - [Serial] - [Ethernet].
The Ethernet window is displayed.
2. In the communication setting area, set the following items.

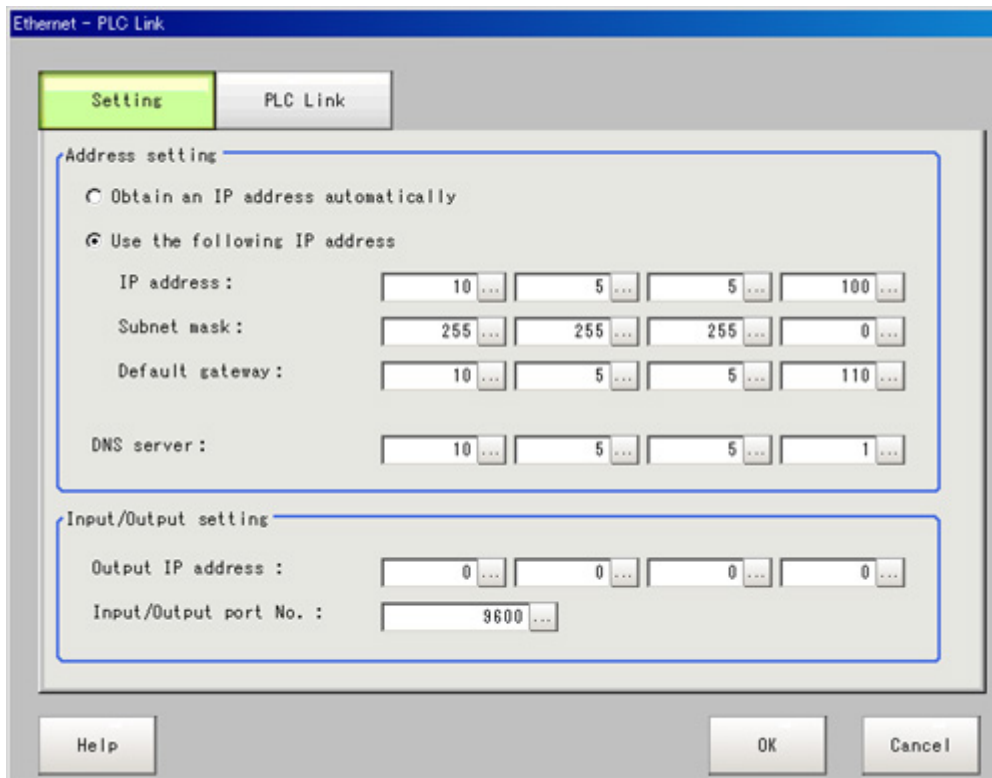

Setting item	Setting value [Factory default]	Description
Address setting	<ul style="list-style-type: none"> • Obtain an IP address automatically • [Use the following IP address] 	<p>Set the IP address of the controller.</p> <p>When "Obtain an IP address automatically" is selected, the IP address of the controller will be automatically obtained.</p> <p>When "Use the following IP address" is selected, set the IP address, subnet mask, and the default gateway address.</p>
IP address	<p>a.b.c.d</p> <p>a: 1 to 223</p> <p>b: 0 to 255</p> <p>c: 0 to 255</p> <p>d: 0 to 255</p> <p>[10.5.5.100]</p>	Input the controller IP address.

	Subnet mask	0.0.0.0 to 255.255.255.255 [255.255.255.0]	Input the subnet mask address.
	Default gateway	a.b.c.d a: 1 to 223 b: 0 to 255 c: 0 to 255 d: 0 to 255 [10.5.5.110]	Input the default gateway address.
	DNS server	a.b.c.d a: 1 to 223 b: 0 to 255 c: 0 to 255 d: 0 to 255 [10.5.5.1]	Input the DNS server address.
Input/Output setting			
	Output IP address	a.b.c.d a: 0 to 255 b: 0 to 255 c: 0 to 255 d: 0 to 255 [0.0.0.0]	Input the output destination IP address.
	Input/Output port No.	0 to 65535 [9600]	Set the port No. to use for data I/O with the controller.

Important

- If the operation mode (FZ3-9 □ □ /H9 □ □ only) is [Multi-line random-trigger mode], set a different I/O port No. for line 0 and line 1.

3. Tap [PLC link setting].
The PLC Link Setting window is displayed.

4. Set the following items.

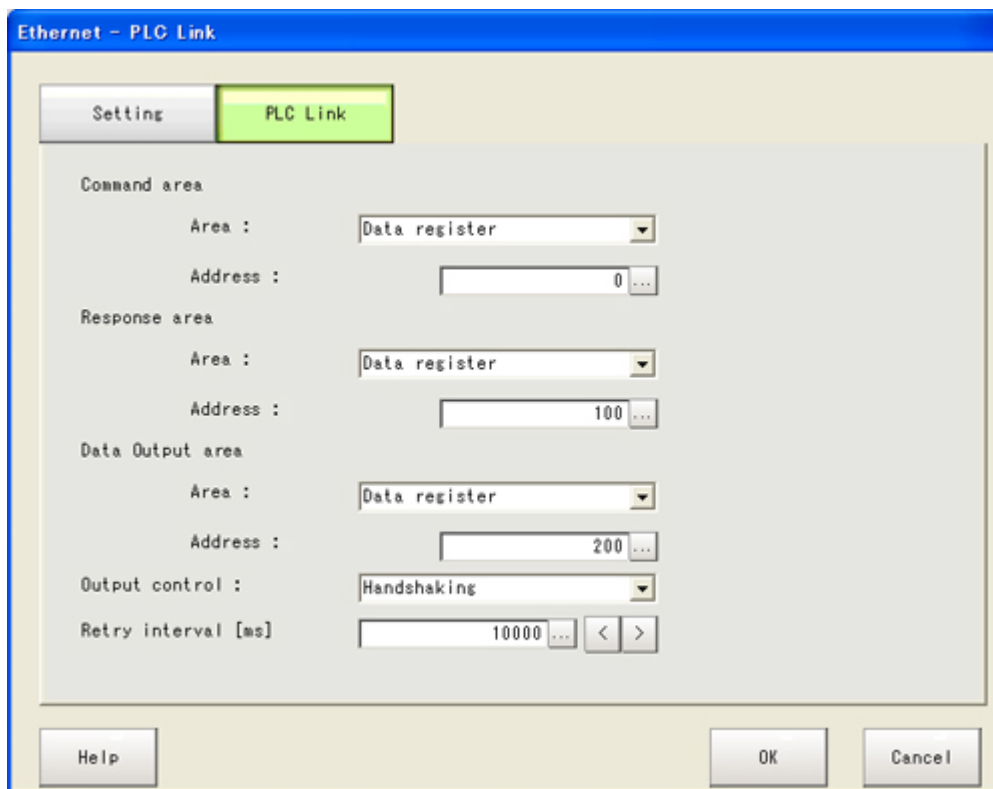

Setting item	Setting value [Factory default]	Description
Command area		
Area	<ul style="list-style-type: none"> • [CIO Area (CIO)] • Work Area(WR) • Holding Bit Area(HR) • Auxiliary Bit Area(AR) • DM Area (DM) • EM Area(EMO) 	Set the Command area.
Address	0 to 99999 [0]	Set the top channel address in the Command area.
Response area		
Area	<ul style="list-style-type: none"> • [CIO Area (CIO)] • Work Area(WR) • Holding Bit Area(HR) • Auxiliary Bit Area(AR) • DM Area (DM) • EM Area(EMO) 	Set the Response area.
Address	0 to 99999 [100]	Set the top channel address in the Response area.
Data output area		
Area	<ul style="list-style-type: none"> • [CIO Area (CIO)] • Work Area(WR) • Holding Bit Area(HR) • Auxiliary Bit Area(AR) • DM Area (DM) • EM Area(EMO) 	Set the Data output area.
Address	0 to 99999 [200]	Set the top channel address in the Data output area.

Output control	<ul style="list-style-type: none"> • None • [Handshaking] 	Set whether or not to provide an interlock with the PLC when performing data output. None: Data is output regardless of the status of signals from the PLC. GATE is always OFF. Handshaking: Data is output after confirming DSA from the PLC.
Retry interval [ms]	1000 to 999999 [10000]	Set the communication retry interval.

PLC by Mitsubishi Electric Corporation

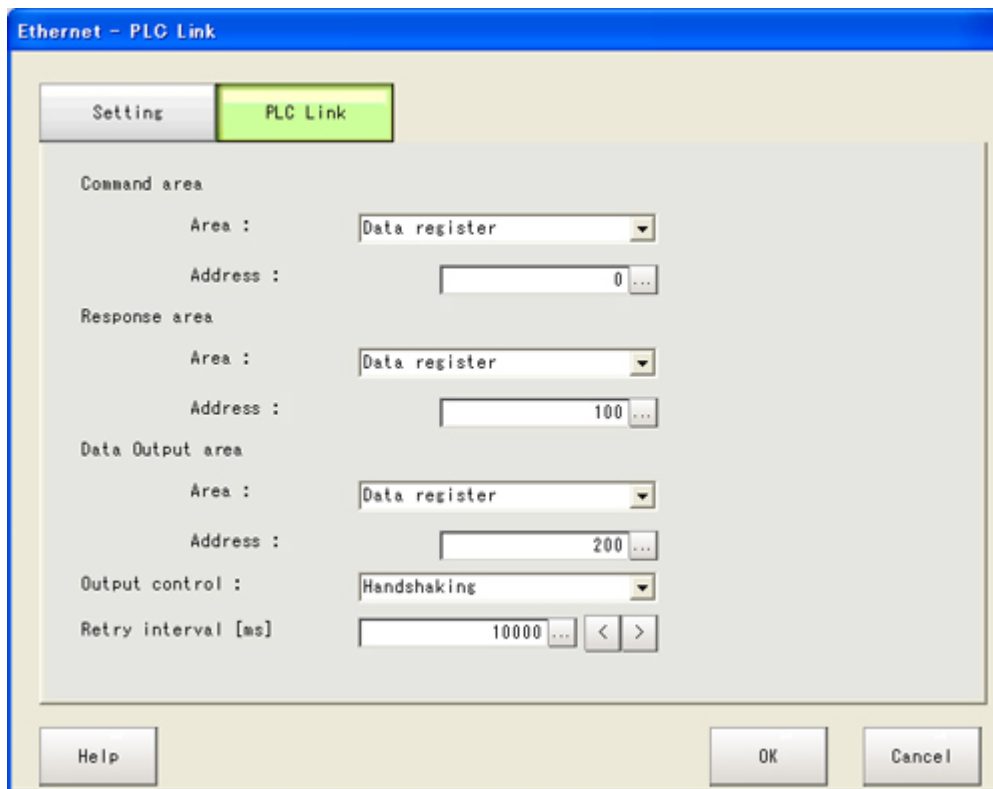

Setting item	Setting value [Factory default]	Description
Command area		
Area	<ul style="list-style-type: none"> • [Data register] • File register • Link register 	Set the Command area.
Address	0 to 99999 [0]	Set the top channel address in the Command area.
Response area		
Area	<ul style="list-style-type: none"> • [Data register] • File register • Link register 	Set the Response area.
Address	0 to 99999 [100]	Set the top channel address in the Response area.
Data output area		

	Area	<ul style="list-style-type: none"> • [Data register] • File register • Link register 	Set the Data output area.
	Address	0 to 99999 [200]	Set the top channel address in the Data output area.
	Output control	<ul style="list-style-type: none"> • None • [Handshaking] 	<p>Set whether or not to provide an interlock with the PLC when performing data output.</p> <p>None: Data is output regardless of the status of signals from the PLC. GATE is always OFF.</p> <p>Handshaking: Data is output after confirming DSA from the PLC.</p>
	Retry interval [ms]	1000 to 999999 [10000]	Set the communication retry interval.

5. Tap [OK].

The settings are confirmed and the Ethernet window closes.

Checking Communication Status

Use PLC tools, etc. to check the communication status.

Important

- The communication time is different depending on the communication environment. Make sure to verify on the actual usage environment before use. The communication speed of the controllers for the FZ3-L35 □ /3 □ □ /7 □ □ series may be faster than the speed of the controllers for FZ3-9 □ □ series depending on the conditions.

Setting Communication Specifications (RS-232C/422-PLC Link)

Communication specifications such as link areas or communication speed and data length are set.

Reference: ▶ Setting Communication Specifications (Ethernet - PLC Link) (p.152)

Important

- Before setting the communication specifications, set the "Serial (RS-232C/422)" communication module to "PLC link (SYSMAC CS/CJ/CP/One)" (or to "PLC link (MELSEC Q series)" in the case of a PLC by Mitsubishi Electric Corporation), save the setting to the controller, and then restart the system. When the system is restarted, the communication settings are initialized.
Reference: ▶ Setting the Start-up Status [Startup Setting] (p.133)
- Use the same communication specification settings for the controller and the external device.
- If the operation mode (FZ3-9 □ □ /H9 □ □ only) is [Multi-line random-trigger mode], "RS232C/422-PLC link" cannot be selected for line 1.

1. On the Main screen, tap the [System] menu - [Communication] - [Serial] - [RS-232C/RS-422].

The serial interface window is displayed.

2. In the communication setting area, set the following items.

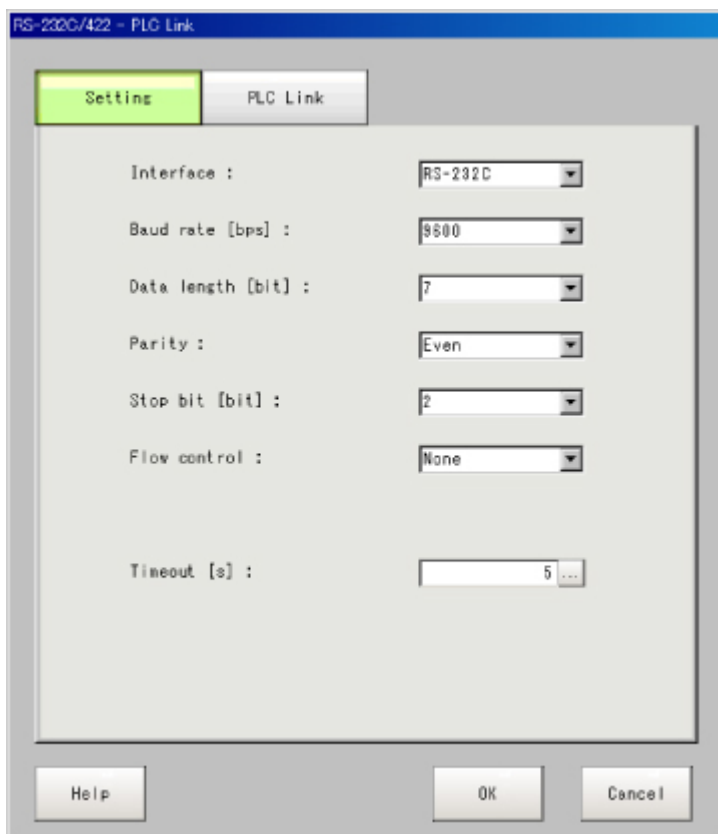

Setting item	Setting value [Factory default]	Description
Interface	<ul style="list-style-type: none"> • [RS-232C] • RS-422 [Note 3] 	Adjust to the PLC communication specifications.
Band rate [bps] [Note 1]	<ul style="list-style-type: none"> • 2400 • 4800 • [9600] • 19200 • 38400 • 57600 • 115200 	Adjust to the PLC communication specifications.
Data length [bit] [Note 2]	<ul style="list-style-type: none"> • [7] • 8 	Adjust to the PLC communication specifications.
Parity	<ul style="list-style-type: none"> • None • Odd • [Even] 	
Stop bit [bit]	<ul style="list-style-type: none"> • 1 • [2] 	
Flow control	[None]	Flow control is not performed with software. If the time in which there is no response from external devices reaches the timeout setting time, a timeout error occurs and an error message is displayed in the window. The parallel interface ERROR signal also turns on.
	Xon/Xoff	Flow control is performed with software. Data is sent according to the Xon/Xoff codes from external devices.
Timeout [s]	1 to 120 [5]	Set the time in which a timeout error will occur in seconds.

[Note 1]: If a speed of [38400 bps] or higher is selected, effective communication cannot be guaranteed depending on the cable length because speeds of over 20 kbps are not defined in RS-232C standards. In this case, set the communication speed at [19200 bps] or lower.

[Note 2]: With the RS-232C MELSEC Q series, set the data length to 8.

[Note 3]: With the MELSEC Q series, RS-422 cannot be used.

3. Tap [PLC Link setting].
The PLC Link Setting window is displayed.
4. Set the following items.

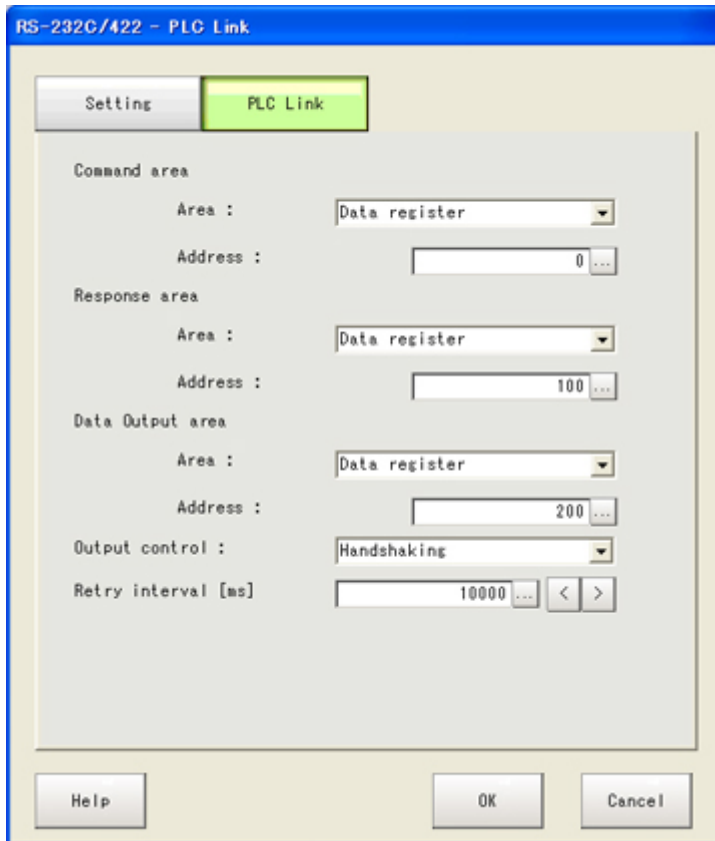

Setting item	Setting value [Factory default]	Description
Command area		
Area	<ul style="list-style-type: none"> • [CIO Area (CIO)] • Work Area(WR) • Holding Bit Area(HR) • Auxiliary Bit Area (AR) • DM Area (DM) • EM Area(EMO) 	Set the Command area.
Address	0 to 99999 [0]	Set the top channel address in the Command area.
Response area		
Area	<ul style="list-style-type: none"> • [CIO Area (CIO)] • Work Area(WR) • Holding Bit Area(HR) • Auxiliary Bit Area (AR) • DM Area (DM) • EM Area(EMO) 	Set the Response area.

	Address	0 to 99999 [100]	Set the top channel address in the Response area.
Data output area			
	Area	<ul style="list-style-type: none"> • [CIO Area (CIO)] • Work Area(WR) • Holding Bit Area(HR) • Auxiliary Bit Area (AR) • DM Area (DM) • EM Area(EMO) 	Set the Data output area.
	Address	0 to 99999 [200]	Set the top channel address in the Data output area.
	Output control	<ul style="list-style-type: none"> • None • [Handshaking] 	<p>Set whether or not to provide an interlock with the PLC when performing data output.</p> <p>None: Data is output regardless of the status of signals from the PLC. GATE is always OFF.</p> <p>Handshaking: Data is output after confirming DSA from the PLC.</p>
	Retry interval [ms]	1000 to 999999 [10000]	Set the communication retry interval.

PLC by Mitsubishi Electric Corporation

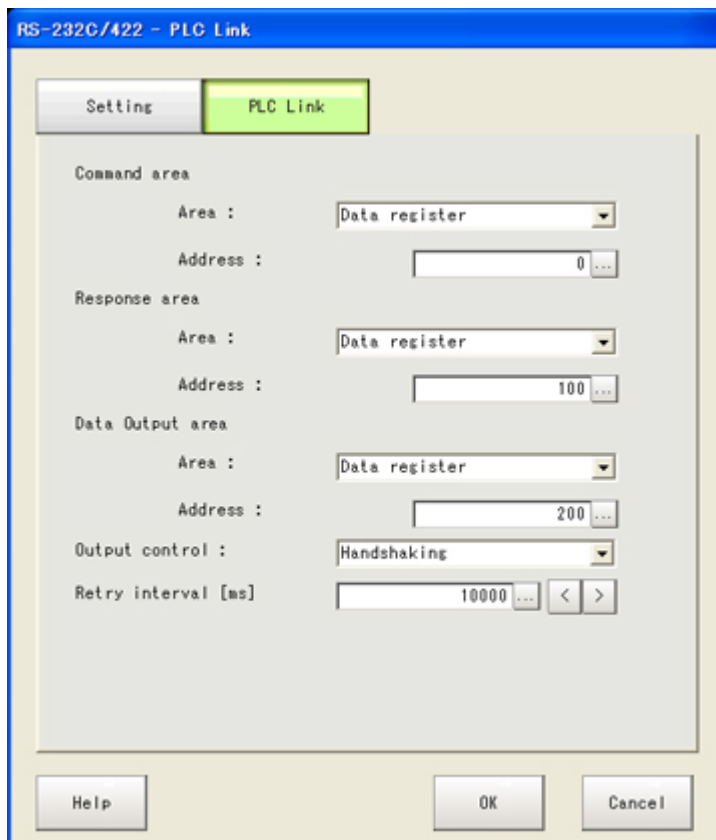

Setting item	Setting value [Factory default]	Description
Command area		
Area	<ul style="list-style-type: none"> • [Data register] • File register • Link register 	Set the Command area.
Address	0 to 99999 [0]	Set the top channel address in the Command area.
Response area		
Area	<ul style="list-style-type: none"> • [Data register] • File register • Link register 	Set the Response area.
Address	0 to 99999 [100]	Set the top channel address in the Response area.
Data output area		
Area	<ul style="list-style-type: none"> • [Data register] • File register • Link register 	Set the Data output area.
Address	0 to 99999 [200]	Set the top channel address in the Data output area.
Output control	<ul style="list-style-type: none"> • None • [Handshaking] 	Set whether or not to provide an interlock with the PLC when performing data output. None: Data is output regardless of the status of signals from the PLC. GATE is always OFF. Handshaking: Data is output after confirming DSA from the PLC.
Retry interval [ms]	1000 to 999999 [10000]	Set the communication retry interval.

5. Tap [OK].

The settings are confirmed and the serial interface window closes.

Checking Communication Status

Use PLC tools, etc. to check the communication status.

Important

- The communication time is different depending on the communication environment. Make sure to verify on the actual usage environment before use. The communication speed of the controllers for the FZ3-L35 □ /3 □ □ /7 □ □ series may be faster than the speed of the controllers for FZ3-9 □ □ series depending on the conditions.

Memory Allocation (PLC Link)

This section explains allocations for each area including the command area, response area, and output area.

Command Area

PLC to controller (FZ3)

Command area top channel	Bit																Name
	15	14	13	12	11	10	9	8	7	6	5	4	3	2	1	0	
+0																EXE	Control input (2CH)
+1																DSA	
+2	CMD-CODE																Command code (2CH)
+3																	
+4	CMD-PARAM																Command parameter (Length changeable)
+5																	
+6																	
+7																	
+8																	
+9																	
+10																	
.																	
.																	
.																	

Signal	Signal name	Function
CMD-EXE	Command execution bit	Executes commands Reference: ▶ Command Control (p.163)
DSA	Data output request bit	Requests the next data output Reference: ▶ Data Output (p.174)
CMD-CODE	Command code	Stores command codes
CMD-PARAM	Command parameter	Stores command parameters

Response Area

Controller (FZ3) to PLC

Response area top channel	Bit																Name																	
	15	14	13	12	11	10	9	8	7	6	5	4	3	2	1	0																		
+0															BUSY	FLG	Control output (2CH)																	
+1																GATE																		
+2	CMD-CODE																Command code (2CH)																	
+3																																		
+4	RES-CODE																Response code (2CH)																	
+5																																		
+6	RES-DATA																Response data (Length changeable)																	
+7																																		
+8																																		
+9																																		
+10																																		
.																																		
.																																		
.																																		

Signal	Signal name	Function
CMD-FLG	Command completion bit	Turns on when command execution is complete.
GATE	Data output completion bit	Turns on when data output is complete.

BUSY	Command execution in progress bit	Turns on when command execution is in progress.
CMD-CODE	Command code	Returns the executed command code.
RES-CODE	Response code	Stores the response from the executed command
RES-DATA	Response data	Stores the response data from the executed command

Output Area

Controller (FZ3) to PLC

Output area top channel	Bit																Name
	15	14	13	12	11	10	9	8	7	6	5	4	3	2	1	0	
+0	DATA0																Output data 0
+1																	
+2	DATA1																Output data 1
+3																	
+4	DATA2																Output data 2
+5																	
+6	DATA3																Output data 3
+7																	
+8	DATA4																Output data 4
+9																	
+10	DATA5																Output data 5
+11																	
+12	DATA6																Output data 6
+13																	
+14	DATA7																Output data 7
+15																	

Signal	Signal name	Function
DATA0-7	Output data 0 to 7	The data set in the output processing items is output. When there are multiple processing items, data is overwritten to this area while "handshaking" is performed.

Data storage to the PLC I/O memory varies depending on the PLC to be connected.

Reference: ▶ Memory Display Image on PLC I/O (p.353)

Command Control (PLC Link)

This section explains each command used in PLC link.

Measurement control command

Command area top channel		Function	References
+3	+2		
0010	1010	Measurement is performed one time	Reference: ▶ Details (p.164)
0010	1020	Starts continuous measurement	Reference: ▶ Details (p.164)
0010	1030	Completes continuous measurement	Reference: ▶ Details (p.165)
0010	2010	Clears measurement values	Reference: ▶ Details (p.165)
0010	3010	Saves in controller	Reference: ▶ Details (p.166)

0010	F010	Restarts the controller	Reference: ▶ Details (p.166)
------	------	-------------------------	------------------------------

Scene control command

Command area top channel		Function	References
+3	+2		
0020	1000	Acquires scene No.	Reference: ▶ Details (p.167)
0020	2000	Acquires scene group No.	Reference: ▶ Details (p.167)
0030	1000	Switching Scenes	Reference: ▶ Details (p.168)
0030	2000	Switch the scene group No.	Reference: ▶ Details (p.168)

Settings acquisition/change command

Command area top channel		Function	References
+3	+2		
0040	1000	Acquires unit data	Reference: ▶ Details (p.169)
0040	2000	Acquires the current date and time	Reference: ▶ Details (p.170)
0040	3000	Acquires system version information	Reference: ▶ Details (p.170)
0040	4000	Acquires setting data related to image logging.	Reference: ▶ Details (p.171)
0050	1000	Sets unit data	Reference: ▶ Details (p.172)
0050	2000	Sets the date/time	Reference: ▶ Details (p.172)
0050	4000	Changes settings related to image logging	Reference: ▶ Details (p.173)
0070	4000	Saves image data.	Reference: ▶ Details (p.174)

Executing Measurement

Executes measurement one time.

Command (PLC to Controller)

Command area top channel	Command code	Bit				Description
		15-12	11-8	7-4	3-0	
+2	1010	0001	0000	0001	0000	Set command codes.
+3	0010	0000	0000	0001	0000	

Response (Controller to PLC)

Response area top channel	Bit				Description
	15-12	11-8	7-4	3-0	
+2	0001	0000	0001	0000	Command code Store response target command codes.
+3	0000	0000	0001	0000	
+4	0000	0000	0000	0000	Response code Command execution result OK: 0 (0000 0000) NG: -1 (FFFF FFFF)
+5	0000	0000	0000	0000	

Starting Continuous Measurement

Starts continuous measurement.

Command (PLC to controller)

Command area top channel	Command code	Bit				Description
		15-12	11-8	7-4	3-0	
+2	1020	0001	0000	0010	0000	Set command codes.
+3	0010	0000	0000	0001	0000	

Response (Controller to PLC)

Response area top channel	Bit				Description
	15-12	11-8	7-4	3-0	
+2	0001	0000	0010	0000	Command code Store response target command codes.
+3	0000	0000	0001	0000	
+4	0000	0000	0000	0000	Response code Command execution result OK: 0 (0000 0000) NG: -1 (FFFF FFFF)
+5	0000	0000	0000	0000	

Stopping Continuous Measurement

Stops continuous measurement.

Command (PLC to controller)

Command area top channel	Command code	Bit				Description
		15-12	11-8	7-4	3-0	
+2	1030	0001	0000	0011	0000	Set command codes.
+3	0010	0000	0000	0001	0000	

Response (Controller to PLC)

Response area top channel	Bit				Description
	15-12	11-8	7-4	3-0	
+2	0001	0000	0011	0000	Command code Store response target command codes.
+3	0000	0000	0001	0000	
+4	0000	0000	0000	0000	Response code Command execution result OK: 0 (0000 0000) NG: -1 (FFFF FFFF)
+5	0000	0000	0000	0000	

Clearing Measurement Values

Clears all measurement values.

Command (PLC to controller)

Command area top channel	Command code	Bit				Description
		15-12	11-8	7-4	3-0	
+2	2010	0010	0000	0001	0000	Set command codes.
+3	0010	0000	0000	0001	0000	

Response (Controller to PLC)

Response area top channel	Bit				Description
	15-12	11-8	7-4	3-0	
+2	0010	0000	0001	0000	Command code Store response target command codes.
+3	0000	0000	0001	0000	
+4	0000	0000	0000	0000	Response code Command execution result OK: 0 (0000 0000) NG: -1 (FFFF FFFF)
+5	0000	0000	0000	0000	

Saving in Controller

Stores the current system data and scene group in the controller.

Command (PLC to controller)

Command area top channel	Command code	Bit				Description
		15-12	11-8	7-4	3-0	
+2	3010	0011	0000	0001	0000	Set command codes.
+3	0010	0000	0000	0001	0000	

Response (Controller to PLC)

Response area top channel	Bit				Description
	15-12	11-8	7-4	3-0	
+2	0011	0000	0001	0000	Command code Store response target command codes.
+3	0000	0000	0001	0000	
+4	0000	0000	0000	0000	Response code Command execution result OK: 0 (0000 0000) NG: -1 (FFFF FFFF)
+5	0000	0000	0000	0000	

Restart

Restarts the controller.

Important

- When a restart command is executed, BUSY does not turn off even after the command execution bit turns off. After a restart command is executed, perform a memory clear of BUSY on the PLC side.

Command (PLC to controller)

Command area top channel	Command code	Bit				Description
		15-12	11-8	7-4	3-0	
+2	F010	1111	0000	0001	0000	Set command codes.
+3	0010	0010	0000	0001	0000	

Response (Controller to PLC)

There is no response because restarting is performed.

Acquiring Scene Number

Acquires the current scene No.

Command (PLC to controller)

Command area top channel	Command code	Bit				Description
		15-12	11-8	7-4	3-0	
+2	1000	0001	0000	0000	0000	Set command codes.
+3	0020	0000	0000	0010	0000	

Response (Controller to PLC)

Response area top channel	Bit				Description
	15-12	11-8	7-4	3-0	
+2	0001	0000	0000	0000	Command code
+3	0000	0000	0010	0000	Store response target command codes.
+4	0000	0000	0000	0000	Response code
+5	0000	0000	0000	0000	Command execution result OK: 0 (0000 0000) NG: -1 (FFFF FFFF)
+6	0000	0000	0000	0000	Response data
+7	0000	0000	0000	0000	Stores the acquired scene No.

Acquiring Scene Group Number

Acquires the current scene group No.

Command (PLC to controller)

Command area top channel	Command code	Bit				Description
		15-12	11-8	7-4	3-0	
+2	2000	0010	0000	0000	0000	Set command codes.
+3	0020	0000	0000	0010	0000	

Response (Controller to PLC)

Response area top channel	Bit				Description
	15-12	11-8	7-4	3-0	
+2	0010	0000	0000	0000	Command code
+3	0000	0000	0010	0000	Store response target command codes.
+4	0000	0000	0000	0000	Response code
+5	0000	0000	0000	0000	Command execution result OK: 0 (0000 0000) NG: -1 (FFFF FFFF)
+6	0000	0000	0000	0000	Response data
+7	0000	0000	0000	0000	Acquired scene group No.

Scene Switching

Switches the scene number to be used.

Command (PLC to controller)

Command area top channel	Command code	Bit				Description
		15-12	11-8	7-4	3-0	
+2	1000	0001	0000	0000	0000	Set command codes.
+3	0030	0000	0000	0011	0000	
+4	-	0000	0000	0000	0000	Specifies the scene No.
+5	-	0000	0000	0000	0000	

Response (Controller to PLC)

Response area top channel	Bit				Description
	15-12	11-8	7-4	3-0	
+2	0001	0000	0000	0000	Command code
+3	0000	0000	0011	0000	Store response target command codes.
+4	0000	0000	0000	0000	Response code
+5	0000	0000	0000	0000	Command execution result OK: 0 (0000 0000) NG: -1 (FFFF FFFF)

Scene Group Switching

Switches the scene group number to be used.

Command (PLC to controller)

Command area top channel	Command code	Bit				Description
		15-12	11-8	7-4	3-0	
+2	2000	0010	0000	0000	0000	Set command codes.
+3	0030	0000	0000	0011	0000	

+4	-	0000	0000	0000	0000	Specifies the scene group No.
+5	-	0000	0000	0000	0000	

Response (Controller to PLC)

Response area top channel	Bit				Description
	15-12	11-8	7-4	3-0	
+2	0010	0000	0000	0000	Command code
+3	0000	0000	0011	0000	Store response target command codes.
+4	0000	0000	0000	0000	Response code
+5	0000	0000	0000	0000	Command execution result OK: 0 (0000 0000) NG: -1 (FFFF FFFF)

Acquiring Unit Data

Acquires the specified processing unit data.

Important

- In processing unit data setting/acquisition, external reference table No. 139 (verification string) of Character Inspection, external reference table No. 164 (judgement comparison character string) of barcodes+, and external reference table No. 172 (judgement comparison character string) of 2D Codes+ cannot be used.

Command (PLC to controller)

Command area top channel	Command code	Bit				Description
		15-12	11-8	7-4	3-0	
+2	1000	0001	0000	0000	0000	Set command codes.
+3	0040	0000	0000	0100	0000	
+4	-	0000	0000	0000	0000	Specifies the unit No.
+5	-	0000	0000	0000	0000	
+6	-	0000	0000	0000	0000	Specifies data number in the External Reference Tables.
+7	-	0000	0000	0000	0000	

Response (Controller to PLC)

Response area top channel	Bit				Description
	15-12	11-8	7-4	3-0	
+2	0001	0000	0000	0000	Command code
+3	0000	0000	0100	0000	Store response target command codes.
+4	0000	0000	0000	0000	Response code
+5	0000	0000	0000	0000	Command execution result OK: 0 (0000 0000) NG: -1 (FFFF FFFF)
+6	0000	0000	0000	0000	Acquired data (Value multiplied by 1000)
+7	0000	0000	0000	0000	

Acquiring Date and Time

Acquires the date and time from the internal calendar timer in the controller.

Command (PLC to controller)

Command area top channel	Command code	Bit				Description
		15-12	11-8	7-4	3-0	
+2	2000	0010	0000	0000	0000	Set command codes.
+3	0040	0000	0000	0100	0000	

Response (Controller to PLC)

Response area top channel	Bit				Description
	15-12	11-8	7-4	3-0	
+2	0010	0000	0000	0000	Command code
+3	0000	0000	0100	0000	Store response target command codes.
+4	0000	0000	0000	0000	Response code
+5	0000	0000	0000	0000	Command execution result OK: 0 (0000 0000) NG: -1 (FFFF FFFF)
+6	0000	0000	0000	0000	Year data: 1900 to 2100
+7	0000	0000	0000	0000	
+8	0000	0000	0000	0000	Month data: 1 to 12
+9	0000	0000	0000	0000	
+10	0000	0000	0000	0000	Date data: 1 to 31
+11	0000	0000	0000	0000	
+12	0000	0000	0000	0000	Hour data: 0 to 23
+13	0000	0000	0000	0000	
+14	0000	0000	0000	0000	Minute data: 0 to 59
+15	0000	0000	0000	0000	
+16	0000	0000	0000	0000	Second data: 0 to 59
+17	0000	0000	0000	0000	

Acquiring Version Information

Acquires the controller version information.

Command (PLC to Controller)

Command area top channel	Command code	Bit				Description
		15-12	11-8	7-4	3-0	
+2	3000	0011	0000	0000	0000	Set command codes.
+3	0040	0000	0000	0100	0000	

Response (Controller to PLC)

Response area top channel	Bit				Description
	15-12	11-8	7-4	3-0	
+2	0011	0000	0000	0000	Command code
+3	0000	0000	0100	0000	Store response target command codes.
+4	0000	0000	0000	0000	Response code
+5	0000	0000	0000	0000	Command execution result OK: 0 (0000 0000) NG: -1 (FFFF FFFF)
+6	0000	0000	0000	0000	Version information character string
+7	0000	0000	0000	0000	
+8	0000	0000	0000	0000	
+9	0000	0000	0000	0000	
:	0000	0000	0000	0000	
:	0000	0000	0000	0000	

Acquires settings related to image logging.

Acquires settings related to image logging.

Command (PLC to Controller)

Command area top channel	Bit				Description
	15-12	11-8	7-4	3-0	
+2	0100	0000	0000	0000	Sets command codes.
+3	0000	0000	0100	0000	
+4	0000	0000	0000	0000	Specifies [Identifier 0] and [Identifier 1]. [Identifier 0]: Specifies logging. [Identifier 1]: Specifies the name of the item to be acquired. Refer to identifier 1 of non-procedure command SYSDATA.
+5	0000	0000	0000	0000	
+6	0000	0000	0000	0000	
+7	0000	0000	0000	0000	
:	0000	0000	0000	0000	
:	0000	0000	0000	0000	

Response (Controller to PLC)

Response area top channel	Bit				Description
	15-12	11-8	7-4	3-0	
+2	0100	0000	0000	0000	Command code
+3	0000	0000	0100	0000	Stores response target command codes.
+4	0000	0000	0000	0000	Response code
+5	0000	0000	0000	0000	Command execution result OK: 0 (0000 0000) NG: -1 (FFFF FFFF)

+6	0000	0000	0000	0000	Setting values related to image logging
+7	0000	0000	0000	0000	
+8	0000	0000	0000	0000	
+9	0000	0000	0000	0000	
:	0000	0000	0000	0000	
:	0000	0000	0000	0000	

Setting Unit Data

Sets the specified processing unit data.

Important

- In processing unit data setting/acquisition, external reference table No. 139 (verification string) of Character Inspection cannot be used.

Command (PLC to controller)

Command area top channel	Command code	Bit				Description
		15-12	11-8	7-4	3-0	
+2	1000	0001	0000	0000	0000	Set command codes.
+3	0050	0000	0000	0101	0000	
+4	0000	0000	0000	0000	0000	Specifies the unit No.
+5	0000	0000	0000	0000	0000	
+6	0000	0000	0000	0000	0000	Specifies data number in the External Reference Tables.
+7	0000	0000	0000	0000	0000	
+8	0000	0000	0000	0000	0000	Input data to be set. (Value multiplied by 1000)
+9	0000	0000	0000	0000	0000	

Response (Controller to PLC)

Response area top channel	Bit				Description
	15-12	11-8	7-4	3-0	
+2	0001	0000	0000	0000	Command code
+3	0000	0000	0101	0000	Store response target command codes.
+4	0000	0000	0000	0000	Response code
+5	0000	0000	0000	0000	Command execution result OK: 0 (0000 0000) NG: -1 (FFFF FFFF)

Setting Date and Time

Sets the date and time of the internal calendar timer in the controller.

Command (PLC to controller)

Command area top channel	Command code	Bit				Description
		15-12	11-8	7-4	3-0	
+2	2000	0010	0000	0000	0000	Set command codes.
+3	0050	0000	0000	0101	0000	
+4	0000	0000	0000	0000	0000	Year data: 1900 to 2100
+5	0000	0000	0000	0000	0000	
+6	0000	0000	0000	0000	0000	
+7	0000	0000	0000	0000	0000	Month data: 1 to 12
+8	0000	0000	0000	0000	0000	Date data: 1 to 31
+9	0000	0000	0000	0000	0000	
+10	0000	0000	0000	0000	0000	Hour data: 0 to 23
+11	0000	0000	0000	0000	0000	
+12	0000	0000	0000	0000	0000	Minute data: 0 to 59
+13	0000	0000	0000	0000	0000	
+14	0000	0000	0000	0000	0000	Second data: 0 to 59
+15	0000	0000	0000	0000	0000	

Response (Controller to PLC)

Response area top channel	Bit				Description
	15-12	11-8	7-4	3-0	
+2	0010	0000	0000	0000	Command code
+3	0000	0000	0101	0000	Store response target command codes.
+4	0000	0000	0000	0000	Response code
+5	0000	0000	0000	0000	Command execution result OK: 0 (0000 0000) NG: -1 (FFFF FFFF)

Changes settings related to image logging

Changes settings related to image logging.

Command (PLC to controller)

Command area top channel	Bit				Description
	15-12	11-8	7-4	3-0	
+2	0100	0000	0000	0000	Sets command codes.
+3	0000	0000	0101	0000	
+4	0000	0000	0000	0000	Specifies [Identifier 0], [Identifier 1] and [Setting value]. [Identifier 0]: Specifies logging. [Identifier 1]: Specifies the name of the item to be set. Refer to identifier 1 of non-procedure command SYSDATA. [Setting value]: Specifies the setting value.
+5	0000	0000	0000	0000	
+6	0000	0000	0000	0000	
+7	0000	0000	0000	0000	
:	0000	0000	0000	0000	
:	0000	0000	0000	0000	
:	0000	0000	0000	0000	

Response (Controller to PLC)

Response area top channel	Bit				Description
	15-12	11-8	7-4	3-0	
+2	0100	0000	0000	0000	Command code Stores response target command codes.
+3	0000	0000	0101	0000	
+4	0000	0000	0000	0000	Response code Command execution result OK: 0 (0000 0000) NG: -1 (FFFF FFFF)
+5	0000	0000	0000	0000	

Saves image data

Saves image data.

Command (PLC to controller)

Response area top channel	Bit				Description
	15-12	11-8	7-4	3-0	
+2	0100	0000	0000	0000	Sets command codes.
+3	0000	0000	0111	0000	
+4	0000	0000	0000	0000	Specifies the image data No.
+5	0000	0000	0000	0000	
+6	0000	0000	0000	0000	For details of [Image data number] and [Save destination], refer to the non-procedure command IMGSAVE command section.
+7	0000	0000	0000	0000	
:	0000	0000	0000	0000	
:	0000	0000	0000	0000	

Response (Controller to PLC)

Response area top channel	Bit				Description
	15-12	11-8	7-4	3-0	
+2	0100	0000	0000	0000	Command code Stores response target command codes.
+3	0000	0000	0111	0000	
+4	0000	0000	0000	0000	Response code Command execution result OK: 0 (0000 0000) NG: -1 (FFFF FFFF)
+5	0000	0000	0000	0000	

Data Output (PLC Link)

Either fixed point output or floating point output can be selected for data output.

Reference: ▶ Data Output (p.418)

Timing Chart (PLC Link)

This section explains timing charts for command, response, output, and measurement commands.

Command to Response

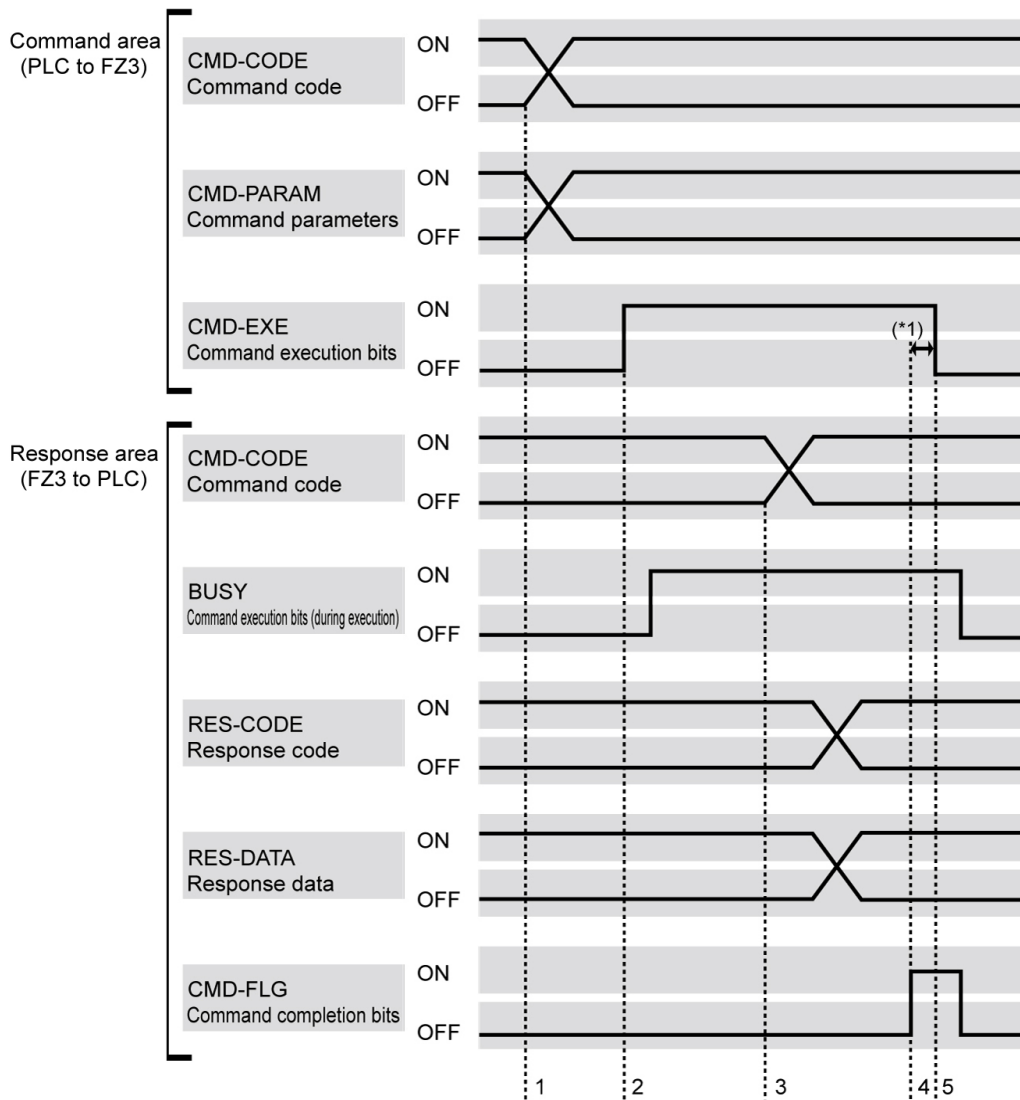

1. CMD-CODE and CMD-PARAM are set from the PLC, and then CMD-EXE is turned on. The FZ3 receives an execution instruction.
 2. When the FZ3 receives the execution instruction, BUSY is turned on and the command is executed.
 3. When the FZ3 completes execution, CMD-CODE, RES-CODE, and RES-DATA are set and then CMD-FLG is turned on.
 4. The PLC confirms that CMD-FLG has turned on and then CMD-EXE is turned off.
 5. The FZ3 confirms that CMD-EXE has turned off and then CMD-FLG and BUSY are turned off.
- *1: If CMD-EXE is not turned off within the retry interval (0 to 999999 ms), CMD-FLG and BUSY are forcibly turned off.

Data Output

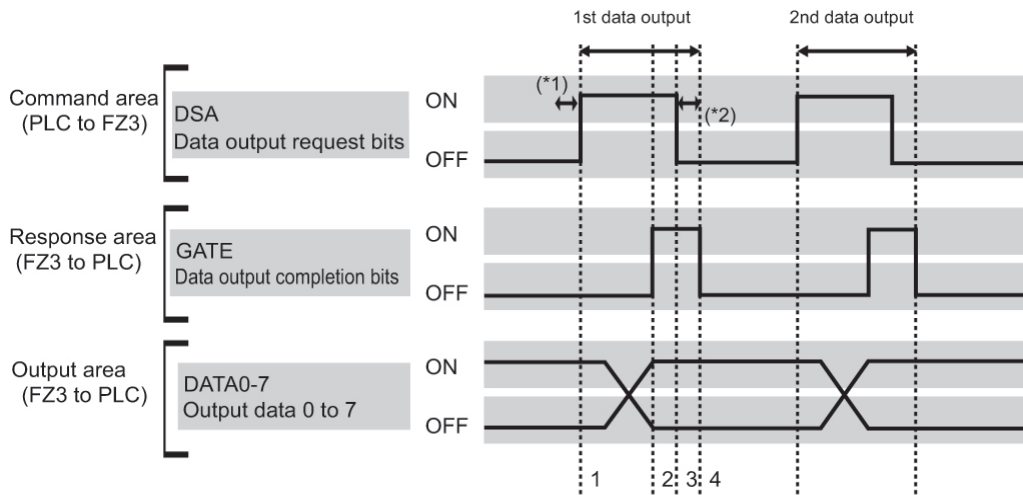

1. Turn on DSA from the PLC and issue a data output request.
 2. The FZ3 outputs data. After output is complete, GATE is turned on.
 3. The PLC confirms that GATE has turned on, loads data, and then the DSA is turned off.
 4. The FZ3 confirms that the DSA has turned off and then GATE is turned off.
- After measurement completion, the DSA is turned on from the PLC and the next data output is requested.
- *1: If DSA is not turned on within the retry interval (0 to 999999 ms) after the processing flow has been adjusted to the order of data output units, the GATE will be forcibly turned off and data output will end. Use caution as data will be deleted.
- *2: If the DSA is not turned off within the retry interval (0 to 999999 ms), GATE is forcibly turned off and output is ended.

Measurement Command Details

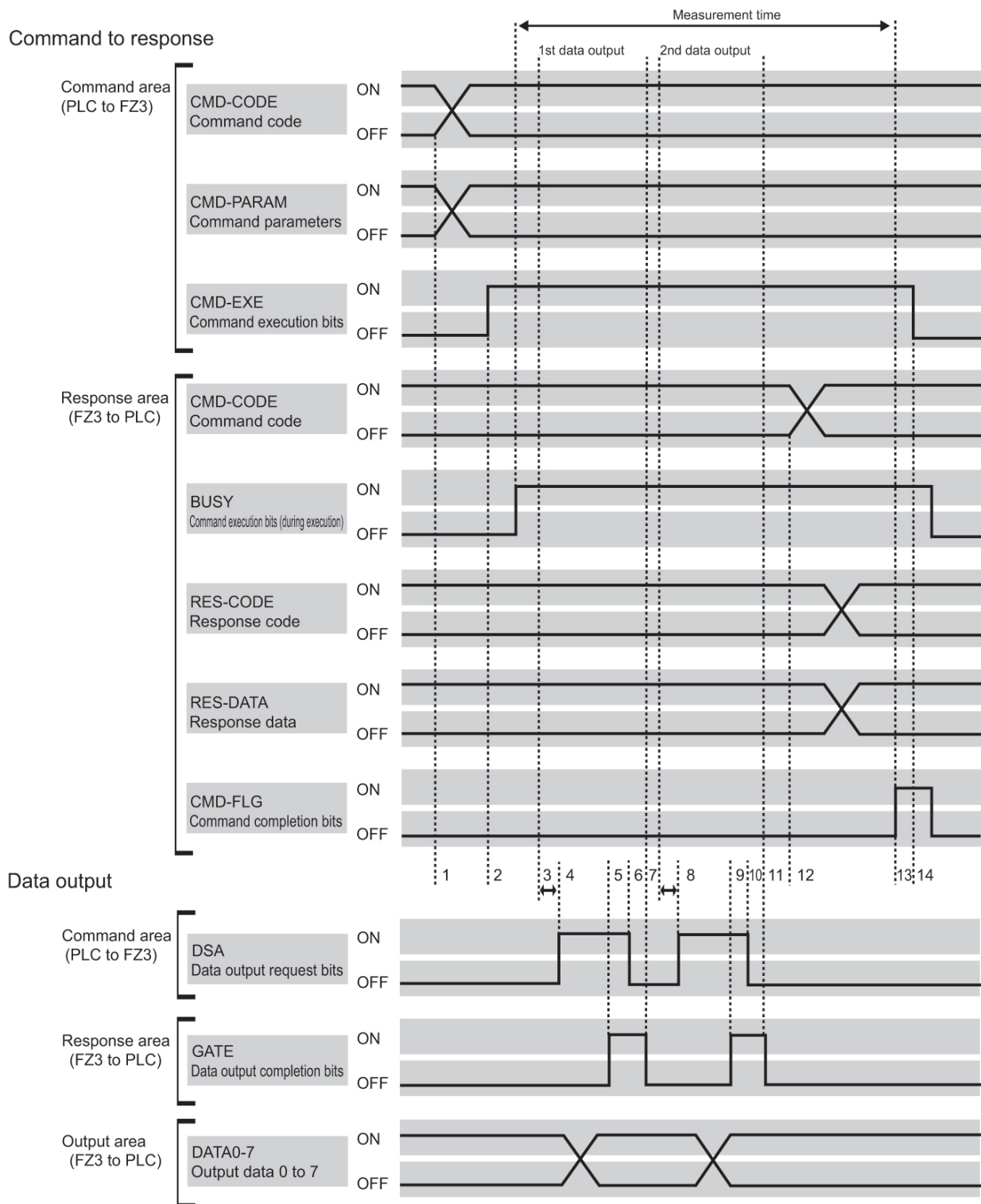

1. CMD-CODE and CMD-PARAM are set from the PLC, and then CMD-EXE is turned on. The FZ3 receives an execution instruction.
2. When the FZ3 receives the execution instruction, BUSY is turned on and the command is executed.
3. If DSA is not turned on within the retry interval (0 to 999999 ms) after the processing flow has been adjusted to the order of data output units, the GATE will be forcibly turned off and data output will end.
4. After measurement completion, the DSA is turned on from the PLC and data output is requested.
5. The FZ3 outputs data. After output is complete, GATE is turned on.
6. The PLC confirms that GATE has turned on, loads data, and then the DSA is turned off.
7. The FZ3 confirms that the DSA has turned off and then GATE is turned off. If there are 2 or more serial data output units in the processing flow, turn on DSA from the PLC and issue the next data output request.
- 8 to 11. 2nd data output (same as 4 to 7)
12. When the FZ3 completes execution, CMD-CODE, RES-CODE, and RES-DATA are set and then CMD-FLG is turned on.
13. The PLC confirms that CMD-FLG has turned on and then CMD-EXE is turned off.
14. The FZ3 confirms that CMD-EXE has turned off and then CMD-FLG and BUSY are turned off.

Ladder Program Example (PLC Link)

This section shows a PLC ladder program example.

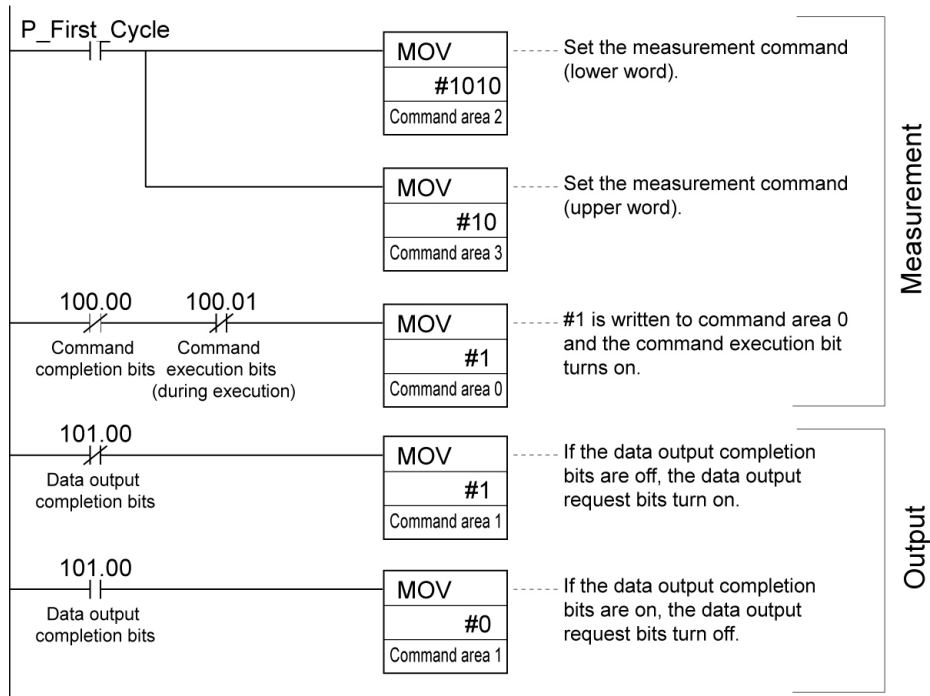

Controlling/Outputting through Serial Communication (Non-procedure)

This section describes how to set required communication specifications and describes the I/O format for communication with external devices via serial interface (RS-232C/422 connection) using a non-procedure method with commands. Communication is performed via the Ethernet using the UDP/IP, TCP/IP protocols.

Communication Processing Flow (Non-procedure)

This section explains the processing flow of serial (non-procedure) communication.

1:1 connection

Example) Input measurement command and acquire the results

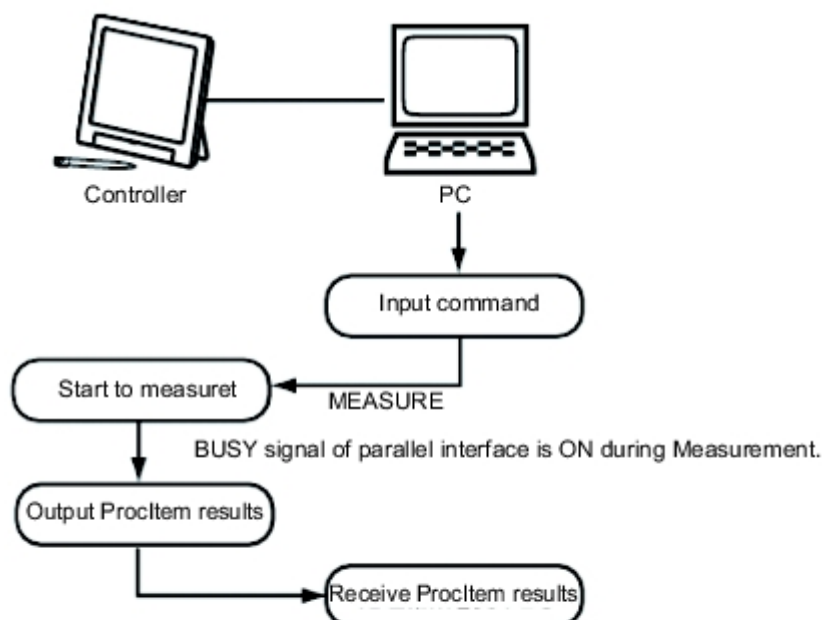

* When 'Flow Control' is set to 'Xon/Xoff'.

If a PC has no response within preset overtime, line breakage or PC malfunction maybe occur, signalling an overtime error.

Error message will displayed in the window of controller and ERR signal of parallel interface is ON.

Setting Communication Specifications (Ethernet - Non-procedure)

Communication specifications such as communication speed and IP addresses are set for Ethernet communication.

Reference: ▶ Setting Communication Specifications (RS-232C/422 - Non-procedure) (p.183)

Important

- Before setting the communication specification, set the [Serial (Ethernet)] communication module to [Non-procedure (UDP)], [Non-procedure (TCP)], or [Non-procedure (UDP) (Fxxx series method)]. Save the setting to the controller and then restart the system.
Reference: ▶ Setting the Start-up Status [Startup Setting] (p.133)
- Use the same communication specification settings for the controller and the external device.
- When making system settings/Ethernet settings, do not send external input into the Ethernet.
- If the operation mode (FZ3-9 □ □ /H9 □ □ only) is set to [Multi-line random-trigger mode], the controller address cannot be set for line 1. (The same setting for line 0 is used.)
- If the operation mode (FZ3-9 □ □ /H9 □ □ only) is set to [Multi-line random-trigger mode], set a different port number for line 0 and line 1.
- When it is non-procedure (TCP), data output cannot be performed using serial data output.

1. On the Main screen, tap the [System] menu - [Communication] - [Serial] - [Ethernet].
The Ethernet window is displayed.
2. Set the following items.

Ethernet

Address setting

Obtain an IP address automatically

Use the following IP address

IP address : 10... 5... 5... 100...

Subnet mask : 255... 255... 255... 0...

Default gateway : 10... 5... 5... 110...

DNS server : 10... 5... 5... 1...

Input/Output setting

Input mode : Normal

Input form : ASCII

Output IP address : 0... 0... 0... 0...

Input/Output port No. : 9600...

Help OK Cancel

Non-procedure (TCP)

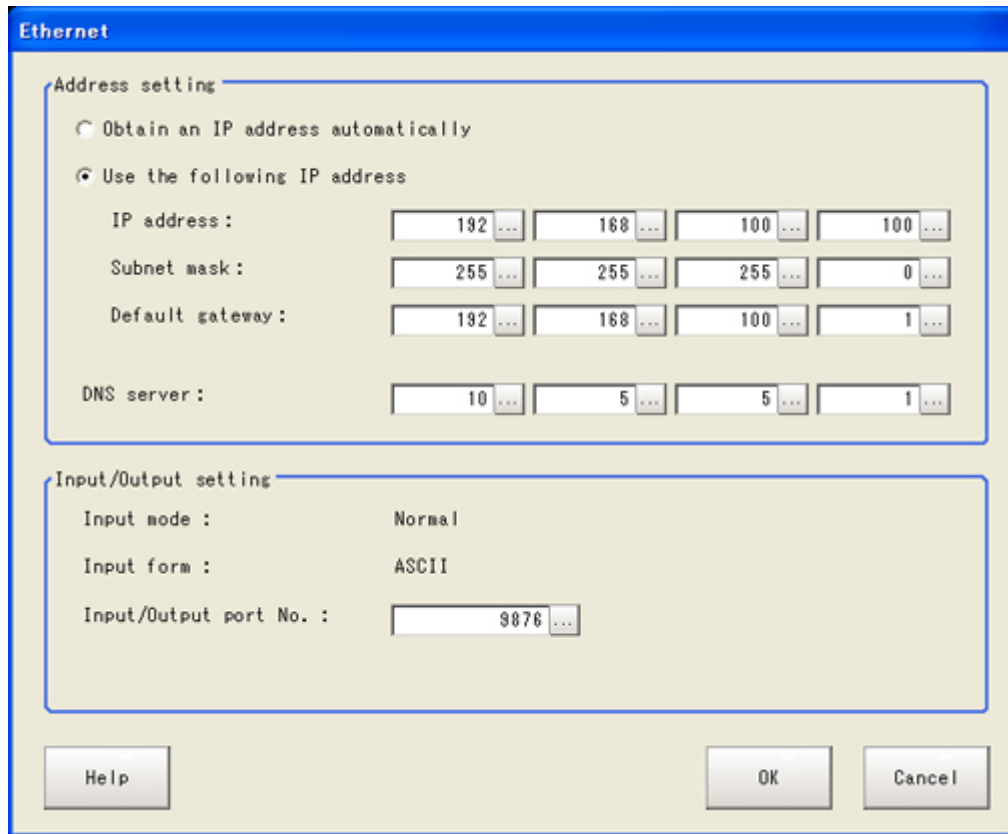

The image shows a dialog box titled "Ethernet" with two main sections: "Address setting" and "Input/Output setting".

Address setting

- Obtain an IP address automatically
- Use the following IP address

IP address : 192 ... 168 ... 100 ... 100 ...

Subnet mask : 255 ... 255 ... 255 ... 0 ...

Default gateway : 192 ... 168 ... 100 ... 1 ...

DNS server : 10 ... 5 ... 5 ... 1 ...

Input/Output setting

Input mode : Normal

Input form : ASCII

Input/Output port No. : 9076 ...

Buttons: Help, OK, Cancel

Setting item	Setting value [Factory default]	Description
Address setting		
	<ul style="list-style-type: none"> Obtain an IP address automatically [Use the following IP address] 	Set the IP address of the controller. When "Obtain an IP address automatically" is selected, the IP address of the controller will be automatically obtained. When "Use the following IP address" is selected, set the IP address, subnet mask, and the default gateway address.
IP address	a.b.c.d a: 1 to 223 b: 0 to 255 c: 0 to 255 d: 0 to 255 [10.5.5.100]	Input the controller IP address.
Subnet mask	0.0.0.0 to 255.255.255.255 [255.255.255.0]	Input the subnet mask address.
Default gateway	a.b.c.d a: 1 to 223 b: 0 to 255 c: 0 to 255 d: 0 to 255 [10.5.5.110]	Input the default gateway address.
DNS server	a.b.c.d a: 1 to 223 b: 0 to 255 c: 0 to 255 d: 0 to 255 [10.5.5.1]	Input the DNS server address.
I/O setting		
Input mode	[Normal]	This item cannot be changed.
Input form	[ASCII]	This item cannot be changed.
Output IP address ^[Note 1]	a.b.c.d a: 1 to 223 b: 0 to 255 c: 0 to 255 d: 0 to 255 [0.0.0.0]	Input the output destination IP address.
Input/Output port No.	0 to 65535 [9600] [9876] [Note 2]	Set the port No. to use for data I/O with the controller. Set the same No. as on the host side.

[Note 1]: It is not displayed if the communication module is set to "Normal (TCP)".

[Note 2]: The initial setting value becomes [9876] only when the communication module is set to [Normal (TCP)].

Reference: ▶ Setting the Start-up Status [Startup Setting] (p.133)

3. Tap [OK].

The settings are confirmed and the Ethernet window closes.

Setting Communication Specifications (RS-232C/422 - Non-procedure)

Communication specifications such as communication speed and IP addresses are set for serial interface (RS-232C/422 connection) communication.

Reference: ▶ Setting Communication Specifications (Ethernet - Non-procedure) (p.179)

Important

- Before setting the communication specifications, set the "Serial (RS-232C/422)" communication module to "Normal" or "Normal (Fxxx method)", save the setting to the controller, and then restart the system.
Reference: ▶ Setting the Start-up Status [Startup Setting] (p.133)
- Use the same communication specification settings for the controller and the external device.
- If the operation mode (FZ3-9 □ □ /H9 □ □ only) is set to [Multi-line random-trigger mode], this setting is not supported for line 1.
- RS-422 is disabled on the FZ3-L35 □ series.

Reference

- During setting of communication specifications, input signals cannot be handled. However, the input status can be checked with [confirmation].
Reference: ▶ Checking Communication Status (Non-procedure) (p.184)
- When data is output via serial communication, output is suspended while communication specifications are being set.

1. On the Main screen, tap the [System] menu - [Communication] - [Serial] - [RS-232C/422].
The Serial window is displayed.
2. Tap [Setting] to set communication specifications.

Serial

Setting Confirmation

Mode : Normal

Interface : RS-232C

Baud rate [bps] : 38400

Data length [bit] : 8

Parity : None

Stop bit [bit] : 2

Flow control : None

Delimiter : CR

Timeout [s] : 5

Help OK Cancel

Item	Setting value [Factory default]	Description
Interface	<ul style="list-style-type: none"> · [RS-232C] · RS-422 	Adjust to the PC communication specifications.
Band rate [bps] [Note 1]	<ul style="list-style-type: none"> · 2400 · 4800 · 9600 · 19200 · [38400] · 57600 · 115200 	Adjust to the PC communication specifications.
Data length [bit]	<ul style="list-style-type: none"> · 7 · [8] 	Adjust to the PC communication specifications.
Parity	<ul style="list-style-type: none"> · [OFF] · Odd · Even 	
Stop bit [bit]	<ul style="list-style-type: none"> · 1 · [2] 	
Flow control	[OFF]	Flow control is not performed with software. If the time in which there is no response from external devices reaches the timeout setting time, a timeout error occurs and an error message is displayed in the window. The parallel interface ERROR signal also turns on.
	Xon/Xoff	Flow control is performed with software. Data is sent according to the Xon/Xoff codes from external devices.
Delimiter	<ul style="list-style-type: none"> · [CR] · LF · CR+LF 	Adjust to the PC communication specifications.
Timeout [s]	1 to 120 [5]	Set the time in which a timeout error will occur in seconds.

[Note 1]: If a speed of [38400 bps] or higher is selected, effective communication cannot be guaranteed depending on the cable length because speeds of over 20 kbps are not defined in RS-232C standards. In this case, set the communication speed at [19200 bps] or lower.

3. Tap [OK].

The settings are confirmed and the Serial window closes.

Checking Communication Status (Non-procedure)

Check the communication status with connected external devices using the serial interface. You can check whether wiring and communication settings have been performed correctly.

1. On the Main screen, tap the [System] menu - [Communication] - [Serial] - [RS-232C/422].
The Serial window is displayed.
2. Tap [Confirmation] to check the I/O status.
3. Check or uncheck the "Local echo" check box.

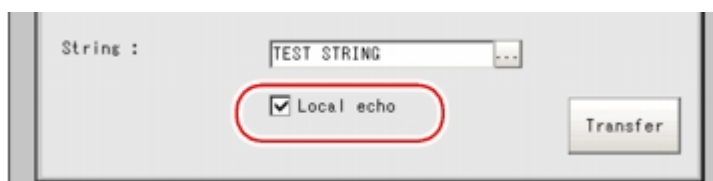

When it is checked, the transfer character string from the device is displayed in the Confirmation window.

- Any character string can be input when editing the character string to be sent through "Transfer". A character string with up to 12 characters can be entered.

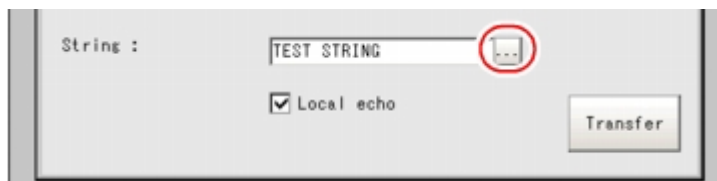

- Tap [Transfer].



Contents of "String" are displayed on the window. Check that there are no problems.

ON	Description
[Send]	Character strings sent from external devices are displayed.
[Receive]	Character strings received from external devices are displayed.

- Tap [OK].
The Serial window closes.

Command Format (Non-procedure)

This section explains the format of commands used in non-procedure method.

Important

- Japanese characters cannot be used. To load a scene, etc., set the file name beforehand using characters other than Japanese.

When Ethernet is used

For Ethernet connections, delimiters are not required at the end of commands.

As with scene number acquisition commands, when acquisition data and an OK response exist next to each other, a space (0 x 20) is inserted between the acquisition data and the OK response and this information is grouped and sent as one packet.

Reference: ▶ Command List (Non-procedure) (p.186)

Input format example (When using DISPCOND to acquire the display status)

<Command format>

DISPCOND

<Response format>

Display state **OK**

Important

- With serial data output (when Ethernet output is set), up to 128 processing units can be registered. Note, however, that not all data may be received depending on the network environment being used, PC performance, and the software for receiving data.

When serial interface (RS-232C/422 connection) is used

Communication specifications are performed according to the settings in Reference: ▶ Setting Communication Specifications (RS-232C/422 - Non-procedure) (p.183) .

Example of input format (SCENE command)

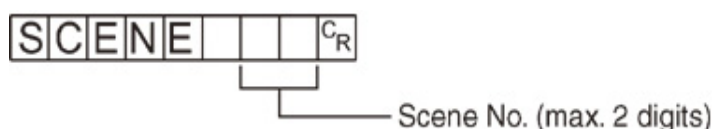

Enter a delimiter at the end of commands.

In this manual, delimiters are expressed with " C_R ".

Separate parameters with spaces. (Not required before delimiters.)

In the following cases, an error occurs. The system quits abnormally and the return values are returned when an error occurs.

- When non-existing commands are specified
- The number of parameters is incorrect
- The range of the parameters is incorrect
- The content of parameters is incorrect
- When action cannot be ended correctly with an action instruction command

Important

- Commands can be input and measurement results can be output only when the Main screen is at the front. Cannot receive commands when setting windows or the Edit Flow windows are displayed (excluding Serial - Confirmation). On the Main screen, even if the screen is switched to the Edit Flow window, etc., the data output after measurement will not be interrupted before all data is output. Can not react to commands when windows other than the Main screen are displayed.

Command List (Non-procedure)

This section explains the input format for each command used in the serial normal method.

Commands are input with ASCII code.Both lowercase and uppercase letters can be used.

FZ3-9 □ □ /FZ3-H9 □ □

The configuration is as follows: USBDisk:E, USBDisk2:F, USBDisk3:G, and USBDisk4:H.

Scene control command

Command	Abbreviation	Function	References
SCENE	S	Acquires the current scene No.	Reference: ▶ Details (p.197)
		Switches scene No. currently being used	
SCNGROUP	SG	Acquires the scene group No currently in use.	Reference: ▶ Details (p.198)
		Switch the scene group No.	

Measurement control/Measurement value acquisition commands

Command	Abbreviation	Function	References
MEASURE	M	Perform measurement once	Reference: ▶ Details (p.195)
		Start continuous measurement	Reference: ▶ Details (p.195)
		Complete continuous measurement	Reference: ▶ Details (p.196)
SCRSWITCH	OFF	Switches the ADJUST window/RUN window	Reference: ▶ Details (p.202)
UNITDATA	UD	Acquires the parameters and/or measurement values of specified processing units	Reference: ▶ Details (p.208)
		Sets the parameters of specified processing units	

Settings acquisition/change command

Command	Abbreviation	Function	References
DATE	OFF	Acquires the current date and time	Reference: ▶ Details (p.190)
		Sets the date/time	
DISPCOND	OFF	Acquires the current image display status	Reference: ▶ Details (p.192)
		Changes the image display state	
SYSDATA	OFF	Acquires settings related to image logging	Reference: ▶ Details (p.204)
		Changes settings related to image logging	
VERGET	OFF	Acquires system version information	Reference: ▶ Details (p.210)

Backup/Restore commands

Command	Abbreviation	Function	References
BKDLOAD	OFF	Loads System + Scene group 0 data	Reference: ▶ Details (p.187)
BKDSAVE	OFF	Saves System + Scene Group 0 data in a file	Reference: ▶ Details (p.188)
DATASAVE	OFF	Saves System + Scene group data in the controller's memory	Reference: ▶ Details (p.190)
IMGSAVE	OFF	Saves the image data	Reference: ▶ Details (p.194)
SCNLOAD	OFF	Loads the Scene data	Reference: ▶ Details (p.200)
SCNSAVE	OFF	Saves the Scene data	Reference: ▶ Details (p.201)
SGRLOAD	OFF	Loads the scene group data	Reference: ▶ Details (p.202)
SGRSAVE	OFF	Saves the scene group data	Reference: ▶ Details (p.203)
SYSLOAD	OFF	Loads system data	Reference: ▶ Details (p.207)
SYSSAVE	OFF	Saves system data	Reference: ▶ Details (p.207)

Utility commands

Command	Abbreviation	Function	References
CLRMEAS	OFF	Clears all of the measurement values of the current scenes	Reference: ▶ Details (p.189)
RESET	OFF	Restart the controller	Reference: ▶ Details (p.197)

BKDLOAD

Reads system + scene group 0 data.

<Command format>

BKDL OAD [] C_R



File name of system + scene group data

<Response format>

When processing is performed normally

OK C_R

When processing is not performed normally

ER C_R

<Parameters explanation>

System + scene group data	Specifies the name of the file to be read with a definite path (ex.: \USBdisk\abc.bkd). Only files that are under the following systems and have a "BKD" extension can be read.
File name	- RAMDisk - USBDisk

Important

- Do not turn off power to the controller until there is a response.

(Example)

When "LABEL1.BKD" in the "IMG01" folder of the USB memory to which the drive name "USBdisk2" is assigned is loaded to the controller

<Command>

BKDL OAD ¥ USBdisk2 ¥ IMG01 ¥ LABEL1.BKD C_R

<Response>

OK C_R

BKDSAVE

The system + scene group 0 data currently being used by the controller is saved to a file.

<Command format>

BKDSAVE [] C_R

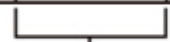

File name of system + scene group data

<Response format>

When processing is performed normally

OK^{CR}

When processing is not performed normally

ER^{CR}

<Parameters explanation>

File name of system + scene group data	Specifies the save destination and file name during saving with a definite path (ex.: \USBDisk\abc.bkd). Save destinations include directories under the following systems. Be sure to attach a "BKD" extension to the file name. - RAMDisk - USBDisk
--	--

Important

- Do not turn off power to the controller until there is a response.

(Example)

When the currently used system + scene group 0 data is saved as "LABEL1.BKD" in the "IMG01" folder in the USB memory to which the drive name "USBDisk2" is assigned

<Command>

BKDSAVE ¥ USBDisk2 ¥ IMG01 ¥ LABEL1.BKD^{CR}

<Response>

OK^{CR}

CLRMEAS

Clears all of the measurement values of the current scene.

<Command format>

CLRMEAS^{CR}

<Response format>

When processing is performed normally

OK^{CR}

When processing is not performed normally

ER^{CR}

<Window display status after clearing>

Judgement result	Unmeasured (0)
Value	0
Character string	Null character

DATASAVE

Saves system data and scene group data to the internal flash memory in the controller.

<Command format>

DATASAVE^{C_R}

<Response format>

When processing is performed normally

OK^{C_R}

When processing is not performed normally

ER^{C_R}

Note

- If DATASAVE command is executed when using scene groups 1 to 31, system data is saved on the controller's flash memory and scene group data is saved to the USB memory. If there is no USB memory plugged in, ER is returned.
- Do not turn off power to the controller until there is a response.

DATE

Acquiring date and time

Acquires the date and time from the internal calendar timer in the controller.

<Command format>

DATE^{C_R}

<Response format>

When processing is performed normally

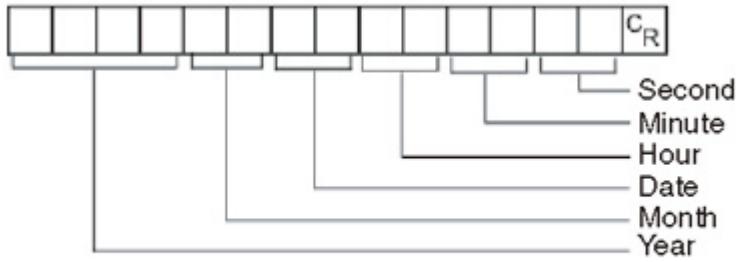

OK^{CR}

When processing is not performed normally

ER^{CR}

<Parameters explanation>

Year/Month/Date/ Hour/Minute/Second	The acquired date and time are output as a response. Year: 4 digits Month: 2 digits Date: 2 digits Hour: 2 digits Minute: 2 digits Second: 2 digits
--	---

(Example)

When the current date and time is 08/30/2007, 12:30:00

<Command>

DATE^{CR}

<Response>

2 0 0 7 0 8 3 0 1 2 3 0 0 0 ^{CR}

Setting date and time

Changes the date and time of the internal calendar timer in the controller.

<Command format>

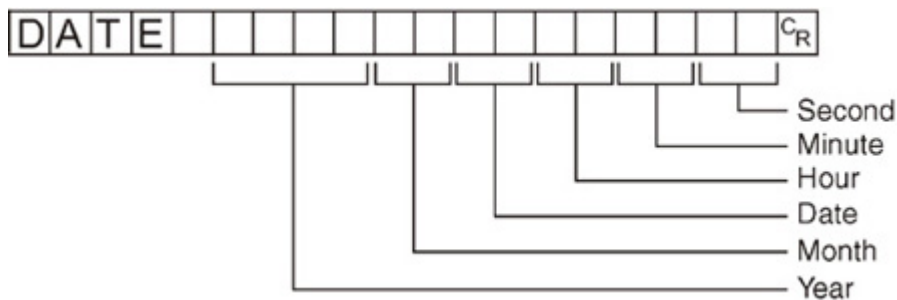

<Response format>

When processing is performed normally

OK^{CR}

When processing is not performed normally

ER^{CR}

<Parameters explanation>

Year/Month/Date/Hour/ Minute/Second	Set the date and time. Year: 4 digits Month: 2 digits Date: 2 digits Hour: 2 digits Minute: 2 digits Second: 2 digits
--	---

Note

- <Hour: 2 digits>, <Minute: 2 digits>, and <Second: 2 digits> can be omitted during setting. Settings cannot be updated when these are omitted, however, and the previous time will be kept unchanged. Allowable omission patterns include "omitting <second> only", "omitting <minute> and <second>", omitting <hour>, <minute>, and <second>". Patterns that cannot be used include "omitting <hour> only" and "omitting <minute> only".

(Example)

When changing the date and time to 8/30/2007, 12:30:00

<Command>

DATE 20070830123000^{CR}

<Response>

OK^{CR}

DISPCOND

Acquiring the current image display status

Acquires the currently displayed image mode.

<Command format>

DISPCOND^{CR}

<Response format>

When processing is performed normally

Display state C_R

OK C_R

When processing is not performed normally

ER C_R

<Parameters explanation>

View State	0: Through 1: Freeze or Freeze and Last NG together 2: Last NG
------------	--

(Example)

When the current image mode is "Through"

<Command>

DISPCOND C_R

<Response>

0 C_R

OK C_R

Changing current image display status

Changes the currently displayed image mode.

<Command format>

DISPCOND C_R

Display image mode No.

<Response format>

When processing is performed normally

OK C_R

When processing is not performed normally

ER C_R

<Parameters explanation>

Display image mode No.	0: Changes the image modes of all the windows to "Through" 1: Changes the image modes of all the windows to "Freeze" 2: Changes the image modes of all the windows to "Last NG"
------------------------	---

(Example)

When changing the current image mode to "Last NG"

<Command>

DISPCOND 2^{CR}

<Response>

OK^{CR}

IMGSAVE

Saves image data.

<Command format>

<Response format>

When processing is performed normally

OK^{CR}

When processing is not performed normally

ER^{CR}

<Parameters explanation>

Image data No.	Specifies the No. of the image data to be saved (0 to max. number of logging images (L_MAX)). The maximum number of logging images can be a number with a maximum of 3 digits. The number of images will vary depending on the controller used and the camera connected. Reference: ▶ About Number of Logging Images (p.346)
Save destination	Specifies the save destination and file name during saving with a definite path (ex.: \USBdisk\abc.IFZ). Save destinations include directories under the following systems. Be sure to attach an "IFZ" extension to the file name. - RAMDisk - USBDisk

Important

- If the specified file name already exists, this existing file will be overwritten
- Do not turn off power to the controller until there is a response.

(Example)

When the image data of image data No. 3 is saved with the file name "LABEL1.IFZ" in the "IMG01" folder in the USB memory to which the drive name "USBDisk2" is assigned

<Command>

I M G S A V E | 3 | ¥ U S B D i s k 2 ¥ I M G 0 1 ¥ L A B E L 1 . I F Z | C_R

<Response>

O K | C_R

MEASURE or M

Executing measurement

Executes measurement one time.

<Command format>

M E A S U R E | C_R or **M | C_R**

<Response format>

When processing is performed normally

Normal	Normal (Fxxx series)
O K C_R M e a s u r e m e n t r e s u l t C_R	M e a s u r e m e n t r e s u l t C_R O K C_R

When processing is not performed normally

E R | C_R

Note

- About "Normal (Fxxx series method)"
Reference: ▶ Setting the Start-up Status [Startup Setting] (p.133)

<Parameters explanation>

Measurement result	When "Data Output" is set in the flow, the measurement results are output. When "Data Output" is not set, the measurement results are not output. Reference: ▶ Output Format (Non-procedure) (p.211)
--------------------	--

Starts continuous measurement

Starts continuous measurement.

<Command format>

MEASURE / C_R

<Response format>

When processing is performed normally

OK_{C_R}

Measurement result C_R
Measurement result C_R
Measurement result C_R

Continuous measurement count

When processing is not performed normally

ER_{C_R}

<Parameters explanation>

Measurement result	The measurement results from the number of times continuous measurement is performed are output as a response. Reference: ▶ Output Format (Non-procedure) (p.211)
--------------------	--

Completes continuous measurement

Continuous measurement ends.

<Command format>

MEASURE / E_{C_R}

<Response format>

When processing is performed normally

OK_{C_R}

When processing is not performed normally

ER_{C_R}

Measurement result C_R
Measurement result C_R

Measurement is continuously executed

Note

- To output measurement results, insert a [Data Output] processing unit in the scene.
When the scene does not have a [Data Output] processing unit, only a command response is output.
Reference: ▶ Output Format (Non-procedure) (p.211)
Reference: ▶ "Processing Item List Manual", "Data Output" (p.418)

RESET

Restart the controller.

<Command format>

RESET^{C_R}

<Response format>

OFF

SCENE or S

Acquires scene No.

Acquires the current scene No.

<Command format>

SCENE^{C_R} or **S**^{C_R}

<Response format>

When processing is performed normally

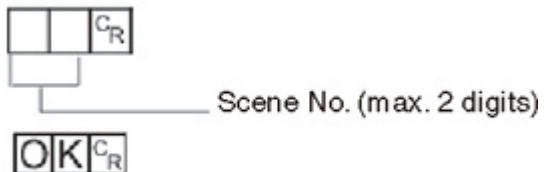

 Scene No. (max. 2 digits)

OK^{C_R}

When processing is not performed normally

ER^{C_R}

<Parameters explanation>

Scene No.	The acquired scene No. (currently used scene No.) is output as a response (0 to 31).
-----------	--

(Example)

When scene 0 is being used

<Command>

SCENE^{C_R}

<Response>

0^{CR}

OK^{CR}

Scene switch No.

Switches the scene No. to be used.

<Command format>

SCENE ^{CR}

Scene No. (max. 2 digits)

<Response format>

When processing is performed normally

OK^{CR}

When processing is not performed normally

ER^{CR}

<Parameters explanation>

Scene No.	Specifies the scene No. after switching (0 to 31).
-----------	--

(Example)

When switching to scene 2

<Command>

SCENE 2^{CR}

<Response>

OK^{CR}

SCNGROUP or SG

Acquires scene group No.

Acquires the current scene group No.

<Command format>

SCNGROUP^{C_R} or **SG**^{C_R}

<Response format>

When processing is performed normally

^{C_R}
 Scene group No. (max. 2 digits)

OK^{C_R}

When processing is not performed normally

ER^{C_R}

<Parameters explanation>

Scene group No.	The acquired scene group No. (currently used scene group No.) is output as a response (0 to 31).
-----------------	--

(Example)

When scene group 0 is being used

<Command>

SCNGROUP^{C_R}

<Response>

0^{C_R}
OK^{C_R}

Switch the scene group No.

Switches the scene group No. to be used.

<Command format>

SCNGROUP ^{C_R}
 Scene group No. (max. 2 digits)

<Response format>

When processing is performed normally

OK^{C_R}

When processing is not performed normally

ER^{CR}

<Parameters explanation>

Scene group No.	Specifies the scene group No. after switching (0 to 31).
-----------------	--

(Example)

When switching to scene group 2

<Command>

SCNNGROUP 2^{CR}

<Response>

OK^{CR}

Important

- During parallel continuous measurement and when the STEP signal is input continuously, do not perform switching of the scene group. When this is performed, set "Unchecked" in "Save scene group on switch scene" in either of the settings items below.
 - Switch Scene Group window Reference: ▶ Switching Scene Groups (p.65)
 - [Measure setting] in the [Measure] menu Reference: ▶ Setting Conditions Related to Operation during Measurement (p.130)

SCNLOAD

Reads scene data.

<Command format>

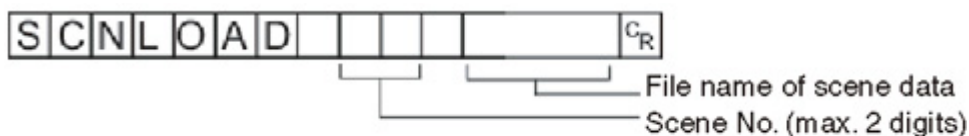

<Response format>

When processing is performed normally

OK^{CR}

When processing is not performed normally

ER^{CR}

<Parameters explanation>

Scene No.	Specifies the scene No. to be read (0 to 31)
-----------	--

File name of scene data	<p>Specifies the name of the file to be read with a definite path. Only files that are under the following systems and have an "SCN" extension can be read.</p> <ul style="list-style-type: none"> - USBDisk - RAMDisk
-------------------------	---

Important

- If the specified file name already exists, this existing file will be overwritten
- Do not turn off power to the controller until there is a response.

(Example)

When "LABEL.SCN" in the "IMG01" folder of the USB memory to which the drive name "USBDisk2" is assigned is loaded to the controller as scene 2.

<Command>

SCNLOAD 2 ¥USBDisk2¥IMG01¥LABEL1.SCN^{CR}

<Response>

OK^{CR}

SCNSAVE

Saves scene data.

<Command format>

SCNSAVE [] [] [] []^{CR}

└── Save destination
 └── Scene No. (max. 2 digits)

<Response format>

When processing is performed normally

OK^{CR}

When processing is not performed normally

ER^{CR}

<Parameters explanation>

Scene No.	Specifies the scene No. to save (0 to 31).
Save destination	<p>Specifies the save destination and file name during saving with a definite path. Save destinations include directories under the following systems. Be sure to attach an "SCN" extension to the file name.</p> <ul style="list-style-type: none"> - USBDisk - RAMDisk

Important

- If the specified file name already exists, this existing file will be overwritten
- Do not turn off power to the controller until there is a response.

(Example)

When scene data of scene No. 3 is saved with the file name "LABEL.SCN" in the "SCN01" folder in the USB memory to which the drive name "USBDisk2" is assigned

<Command>

```
SCNSAVE 3 ¥USBdisk2¥IMG01¥LABEL1.SCNCR
```

<Response>

```
OKCR
```

SCRSWITCH

Switches the ADJUST window/RUN window

The currently displayed window switches to the ADJUST window or RUN window.

- If the current window is the RUN window, it switches to the ADJUST window.
- If the current window is the ADJUST window, it switches to the RUN window.

<Command format>

```
SCRSWITCHCR
```

<Response format>

When processing is performed normally

```
OKCR
```

When processing is not performed normally

```
ERCR
```

SGRLOAD

Reads scene group data.

<Command format>

```
SGRLOAD [ ] [ ] [ ]CR
```

File name of scene group data
Scene group No. (max. 2 digits)

<Response format>

When processing is performed normally

OK^{CR}

When processing is not performed normally

ER^{CR}

<Parameters explanation>

Scene group No.	Specifies the scene group No. to be read (0 to 31)
File name of scene group data	Specifies the name of the file to be read with a definite path. Only files that are under the following systems and have an "SGP" extension can be read. - USBDisk - RAMDisk

Important

- Do not turn off power to the controller until there is a response.

(Example)

When "LABEL.SGP" in the "IMG01" folder of the USB memory to which the drive name "USBDisk2" is assigned is loaded to scene group 3

<Command>

SGRLOAD 3 ¥USBDisk2¥IMG01¥LABEL1.SGP^{CR}

<Response>

OK^{CR}

Note

- For the USB memory drive, see Reference: ▶ About USB Drive Names (p.116) .

SGRSAVE

Saves scene group data.

<Command format>

SGRSAVE [] [] [] [] []^{CR}

Save destination

Scene group No. (max. 2 digits)

<Response format>

When processing is performed normally

OK^{CR}

When processing is not performed normally

ER^{CR}

<Parameters explanation>

Scene group No.	Specifies the scene group No. to save (0 to 31).
Save destination	Specifies the save destination and file name during saving with a definite path. Save destinations include directories under the following systems. Be sure to attach an "SGP" extension to the file name. - USBDisk - RAMDisk

Important

- If the specified file name already exists, this existing file will be overwritten
- Do not turn off power to the controller until there is a response.

(Example)

When data stored in scene group 3 is saved with the file name "LABEL.SGP" in the "IMG01" folder in the USB memory to which the drive name "USBDisk2" is assigned

<Command>

SGRS AVE | 3 | ¥ USBDisk2 ¥ IMG01 ¥ LABEL.SGP ^{CR}

<Response>

OK^{CR}

SYSDATA

Acquires settings related to image logging

Acquires settings related to current image logging.

<Command format>

SYSDATA | L o g g i n g | ^{CR}
Identifier

<Response format>

When processing is performed normally

Measurement value ^{C_R}

OK ^{C_R}

When processing is not performed normally

ER ^{C_R}

<Parameters explanation>

Setting data	Identifier 1	Set value
Image Logging	imageLogging	<ul style="list-style-type: none">• 0: None• 1: Only NG• 2: All
Folder name of image logging save destination	imageLoggingDirectory	Save destination folder name (one-byte alphanumeric character)
Prefix for image logging file name	imageLoggingHeader	Prefix for image logging file name (one-byte alphanumeric characters)
Data Logging	dataLogging	<ul style="list-style-type: none">• 0: None• 1: Only NG• 2: All
Name of destination folder for saving data logging	dataLoggingDirectory	Save destination folder name (one-byte alphanumeric character)

(Example)

When the image logging setting is acquired when the setting for acquiring the current image logging save condition is 1 (save only for NG error)

<Command>

S Y S D A T A L o g g i n g i m a g e L o g g i n g ^{C_R}

<Response>

1 ^{C_R}

OK ^{C_R}

The current image logging save condition is "1: Only NG".

Changes settings related to image logging

Changes setting related to current image logging.

<Command format>

S Y S D A T A L o g g i n g [] [] ^{C_R}

Setting value
Identifier

<Response format>

When processing is performed normally

OK^{CR}

When processing is not performed normally

ER^{CR}

<Parameters explanation>

Setting data	Identifier 1	Set value
Image Logging	imageLogging	<ul style="list-style-type: none">• 0: None• 1: Only NG• 2: All
Folder name of image logging save destination	imageLoggingDirectory	Save destination folder name (one-byte alphanumeric character)
Prefix for image logging file name	imageLoggingHeader	Prefix for image logging file name (one-byte alphanumeric characters)
Data Logging	dataLogging	<ul style="list-style-type: none">• 0: None• 1: Only NG• 2: All
Name of destination folder for saving data logging	dataLoggingDirectory	Save destination folder name (one-byte alphanumeric character)

(Example 1)

When creating settings so that image logging is only performed during NG errors

<Command>

SYSDATA Logging imageLogging 1^{CR}

<Response>

OK^{CR}

(Example 2)

When the RAMDisk is set as the image logging save destination

<Command>

SYSDATA Logging imageLoggingDirectory ¥RAMDisk^{CR}

<Response>

OK^{CR}

SYSLOAD

Reads system data.

<Command format>

`SYSLOAD` `_____` `CR`
File name of system data

<Response format>

When processing is performed normally

`OK` `CR`

When processing is not performed normally

`ER` `CR`

<Parameters explanation>

File name of system data	Specifies the name of the file to be read with a definite path. Only files that are under the following systems and have an "INI" extension can be read. - USBDisk - RAMDisk
--------------------------	---

Important

- Do not turn off power to the controller until there is a response.

(Example)

When "LABEL.INI" in the "IMG01" folder of the USB memory to which the drive name "USBDisk2" is assigned is loaded

<Command>

`SYSLOAD` `¥ USBDisk2 ¥ IMG01 ¥ LABEL.INI` `CR`

<Response>

`OK` `CR`

SYSSAVE

Saves system data.

<Command format>

`SYSSAVE` `_____` `CR`
Save destination

<Response format>

When processing is performed normally

OK^{C_R}

When processing is not performed normally

ER^{C_R}

<Parameters explanation>

Save destination	Specifies the save destination and file name during saving with a definite path. Save destinations include directories under the following systems. Be sure to attach an "INI" extension to the file name. - USBDisk - RAMDisk
------------------	--

Important

- If the specified file name already exists, this existing file will be overwritten
- Do not turn off power to the controller until there is a response.

(Example)

When data stored in scene group 3 is saved with the file name "LABEL.INI" in the "IMG01" folder in the USB memory to which the drive name "USBDisk2" is assigned

<Command>

S Y S S A V E ¥ U S B D i s k 2 ¥ I M G 0 1 ¥ L A B E L . I N I C_R

<Response>

OK^{C_R}

UNITDATA or UD

Acquiring processing unit parameters and measurement values

The set parameters and measurement values for the processing units set in the scene currently being used are acquired.

<Command format>

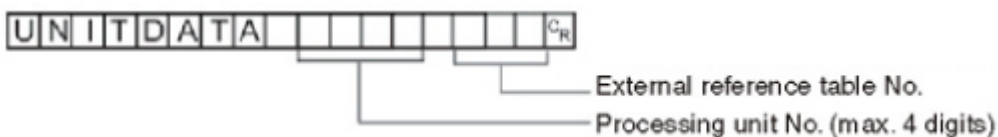

<Response format>

When processing is performed normally

Measurement value C_R

OK C_R

When processing is not performed normally

ER C_R

<Parameters explanation>

Processing unit No.	Specifies the processing unit No. (0 to 9999).
External reference table No.	Varies depending on the specified processing unit processing items. For details, see the "External Reference Table" of the processing items registered in the processing unit. Reference: ▶ External Reference Tables (p.244)
Measurement	The acquired measurement value is output as a response.

(Example)

When the judgement result of [Search] set as the 6th processing unit (processing unit number "5") is acquired (external reference table value is "0")

<Command>

UNITDATA 5 0 C_R

<Response>

0 C_R

OK C_R

Changing processing unit parameters

The set parameters for the processing units set in the scene currently being used are changed.

<Command format>

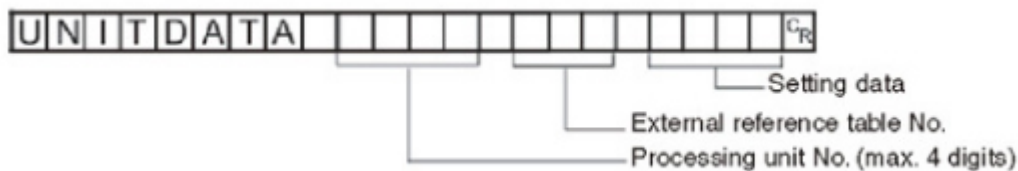

<Response format>

When processing is performed normally

OK C_R

When processing is not performed normally

ER^{CR}

<Parameters explanation>

Processing unit No.	Specifies the processing unit No. (0 to 9999).
External reference table No.	Varies depending on the specified processing unit processing items. For details, see the "External Reference Table" of the processing items registered in the processing unit. Reference: ▶ External Reference Tables (p.244)
Setting data	Set the settings data parameters.

(Example)

When "Skipping angle" (external reference table value "124") in [Search] set as the 6th processing unit (processing unit number "5") is changed to "10"

<Command>

UNITDATA 5 124 10^{CR}

<Response>

OK^{CR}

(Example)

When "Verification string" (external reference table value "139") in [Character Inspection] set as the 6th processing unit (processing unit number "5") is changed to "ABC"

<Command>

UNITDATA 5 139 ABC^{CR}

<Response>

OK^{CR}

VERGET

Acquires the controller version information.

<Command format>

VERGET^{CR}

<Response format>

When processing is performed normally

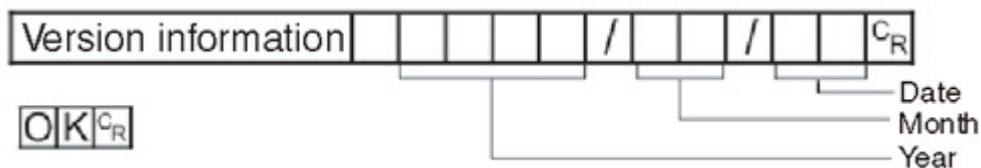

When processing is not performed normally



<Parameters explanation>

Version information	<ul style="list-style-type: none"> • Type of controller • Software version
---------------------	--

(Example)

When the controller type is "FZ3-XXX", the software version is "2.00", and the date is "Sept. 25th, 2008"

<Command>



<Response>

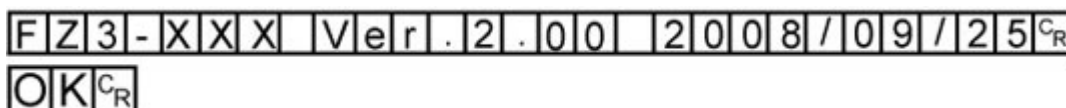

Output Format (Non-procedure)

If the processing unit [Data Output] is set in a scene, measurement results are sequentially output starting from the smallest data No. set in [Setting] of [Data Output].

Reference: ▶ "Processing Item List Manual", "Data Output" (p.418)

When Outputting ASCII Data

Set the output format as "ASCII" in [Setting] of the [Data Output] processing item. The factory settings default value is "ASCII".

Output format



Note

- The output format, number of digits and the data separator, etc. can be changed if necessary. Reference: ▶ "Processing Item List Manual", "Data Output" (p.418)

Example) Integer digits: "5 digits", decimal places: "3 digits", negative numbers: "-", field separator: "comma", record separator: "delimiter"

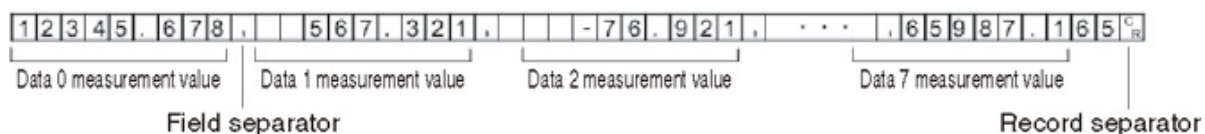

Note

- Field separators are not output in the absence of the following data.

The range of values that can be output is as follows:

-999999999.9999 <= Measurement value <= 999999999.9999

When measurement value is < -999999999.9999, "-999999999.9999" is output.

When measurement value is > 999999999.9999, "999999999.9999" is output.

When JG (Judgement) is set, the next value is output.

OK:1

NG:-1

Note

- Even if measurement is complete, data output will not stop until all of the data is output. Please note, data output will not be interrupted.

When outputting

Binary Data

Set the output format as "Binary" in [Setting] of the [Data Output] processing item.

Output format



The measurement data is multiplied by 1000 and output is continuous with 4 bytes per each data item.

Negative numbers are output in 2's complement format.

For a definition of 2's complement, see Reference: ▶ Terminology Explanations (p.325) .

Example) When Data 0 is "256.324", and data 1 is "-1.000"

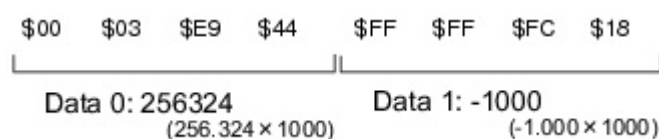

Note

- Unlike ASCII output, binary output has no separators between data such as field separators or record separators, etc.
Reference: ▶ "Processing Item List Manual", "Data Output" (p.418)

The range of values that can be output is as follows:

-2147483.648 <= Measurement value <= 2147483.647

When measurement value is < -2147483.648, "-2147483.648" is output.

When measurement value is > 2147483.647, "2147483.647" is output.

When JG (Judgement) is set, the next value is output.

OK:1000(1 × 1000)

NG:1000(-1 × 1000)

Note

- Even if measurement is complete, data output will not stop until all of the data is output. Please note, data output will not be interrupted.

Control/Output through EtherNet/IP

This section explains how to set the required communication specifications when using EtherNet/IP to communicate with external devices.

EtherNet/IP is a multi-vendor network for the industrial community using Ethernet that is managed by ODVA (Open DeviceNet Vender Association).

A cyclic communication (tag data link communication) with an EtherNet/IP device that supports the class 1 communication of the EtherNet/IP standard can be achieved without a user program. Using the tag data link communication, FZ3 sends and receives data that is the same as the parallel interface to and from an external device.

EtherNet/IP communication specification

The EtherNet/IP communication specification is described. The conformance test applies to Ver.A7. Before establishing the communication, specify the sending and receiving area settings on the external device. For details, refer to the Instruction Manual of the device being used.

Send area (Command area)

Item	Setting description
Tag set (connection)	1
Communication direction	Target → Originator (FZ3)
Tag	1
Data size	20 bytes (Command area)

Receiving area (Response area/Data Output area)

Item	Setting description
Tag set (connection)	1
Communication direction	Originator (FZ3) → Target
Tag	1
Data size	48 bytes (Response area + Data Output area)

Important

- If EtherNet/IP communication is performed with a PLC model that does not support cyclic communication, AssemblyObject setting is required. In addition, depending on the PLC model, AssemblyObject setting may be required even when cyclic communication is supported. Set the AssemblyObject class specification in the following manner: Class ID: 4; Instance ID: 100 [input], 101 [output].

Communication Processing Flow (EtherNet/IP)

Communication between the external device and FZ3 is performed using the 3 areas indicated below: the Command area, Response area, and Data area.

The Command area is used when control commands are sent from the PLC to the FZ3. The FZ3 can be controlled by writing commands to the Command area.

In the Response area, the execution results of control commands described in the Command area are written. The output data accompanying measurement is written to the Data Output area.

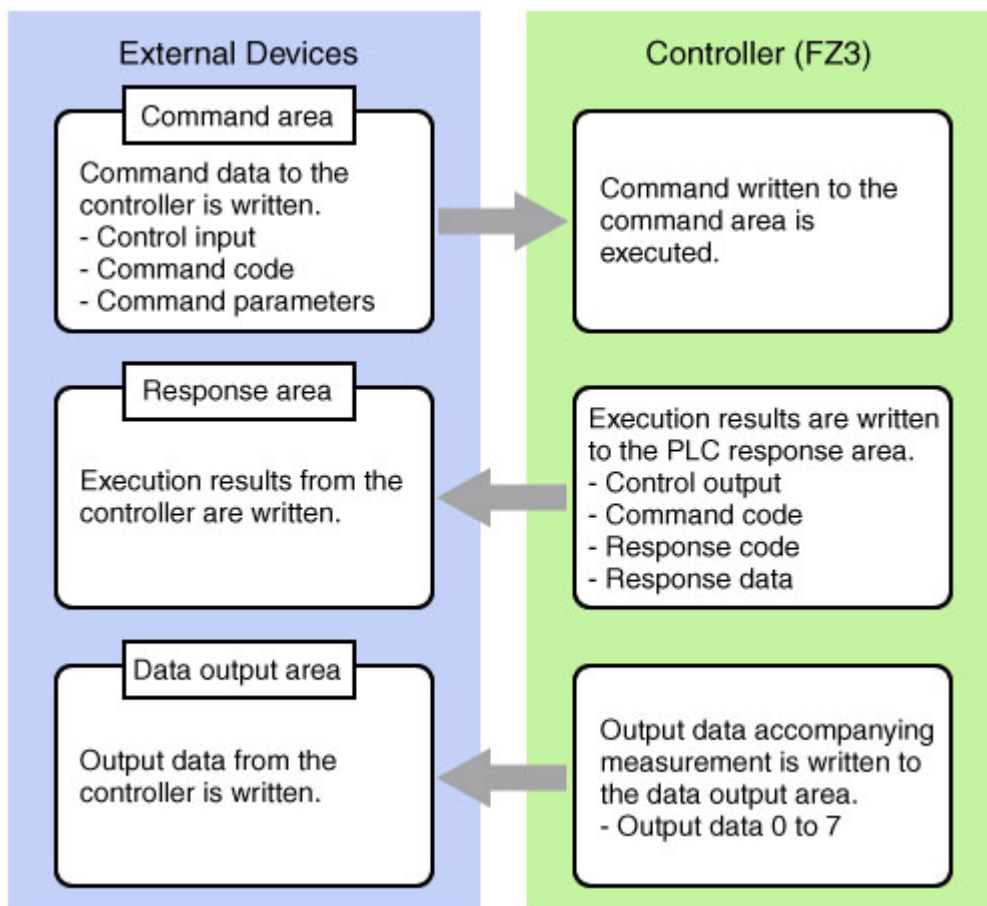
**Important**

- The signal timing is equivalent to the standard parallel I/O where command execution and data output are executed independently.

Setting Communication Specifications (EtherNet/IP)

Set the communication specifications, such as the output control.

Important

- Set the communication module to [EtherNet/IP] before setting the communication specifications. Save the setting to the controller and then restart the system.
Reference: ▶ Setting the Start-up Status [Startup Setting] (p.133)
- When connecting FZ3 to a CJ series EtherNet/IP Unit, the EDS file in which the FZ3 connection information has been defined needs to be installed on the tool (Network Configurator). Download the EDS file from OMRON's website.
- When the 2-line random trigger mode is used with the FZ3-900 series, use the EDS file that corresponds to the line to be used. Specify different addresses for the sending and receiving areas of line 0 and line 1.
- After the tag data link is set, the controller automatically restarts to reflect the setting.

1. On the Main screen, tap [System] menu → [Communication] → [EtherNet/IP].
The EtherNet/IP window is displayed.

- Set the following items.

Setting item	Setting value [Factory default]	Description
Output control	<ul style="list-style-type: none"> · [None] · Handshaking 	Set whether or not to synchronize with an external device when outputting data. None: The controller outputs measurement results without synchronizing with external devices. Reference: ▶ For data output (without handshaking) (p.220) Handshaking: The controller outputs measurement results while synchronized with external devices. Reference: ▶ For data output (with handshaking) (p.220)
Output period	2.0 to 5000.0ms [10.0ms]	Valid only when [Output control] is set to [None]. Set the cycle by which measurement results are output.
Output time	1.0 to 1000.0ms [5.0ms]	Valid only when [Output control] is set to [None]. Set the GATE signal ON time. Set the time required for external devices to acquire measurement results.

Timeout	0.5 to 120.0s [10.0s]	Valid only when [Output control] is set to [Handshaking]. A timeout error occurs when no response from external devices is received within the time that has been set. A timeout error occurs if the status of each flag does not change within the specified time in the following situations. <ul style="list-style-type: none"> • The DSA flag turns ON after the measurement is completed. • The DSA flag turns OFF after the GATE flag turns ON. • The DSA flag turns ON after the GATE flag turns OFF.
---------	--------------------------	---

3. Tap [OK].

The settings are confirmed and the EtherNet/IP window closes.

Memory Allocation (EtherNet/IP)

This section explains allocations for each area including the Command area, Response area, and Output area.

Command area

Master → Slave (FZ3)

Command area top channel	Bit															Name	
	15	14	13	12	11	10	9	8	7	6	5	4	3	2	1		0
+0																EXE	Control input (2CH)
+1																DSA	
+2	CMD-CODE															Command code (2CH)	
+3																	
+4	CMD-PARAM															Command parameter (Maximum 6CH)	
+5																	
+6																	
+7																	
+8																	
+9																	

Signal	Signal name	Function
CMD-EXE	Command execution bit	Executes commands Reference: ▶ Command Control (EtherNet/IP) (p.219)
DSA	Data output request bit	Requests the next data output Reference: ▶ Data Output (EtherNet/IP) (p.219)
CMD-CODE	Command code	Stores command codes
CMD-PARAM	Command parameter	Stores command parameters

Response area

Master ← Slave (FZ3)

Response area top channel	Bit															Name	
	15	14	13	12	11	10	9	8	7	6	5	4	3	2	1		0
+0												RUN	OR		BUSY	FLG	Control output (2CH)
+1																GATE	

+2	CMD-CODE	Command code (2CH)
+3		
+4	RES-CODE	Response code (2CH)
+5		
+6	RES-DATA	Response data (2CH)
+7		

Signal	Signal name	Function
CMD-FLG	Command completion bit	Turns ON when command execution is complete.
GATE	Data output completion bit	Turns ON when data output is complete.
BUSY	Command execution in progress bit	Turns ON when command execution is in progress.
OR	Overall judgement	Turns ON when the overall judgement result is NG. (The OR signal is output when the checkbox for [Output] is selected in the ADJUST window.)
RUN	RUN window	Turns ON when the controller is set to the RUN window.
CMD-CODE	Command code	Returns the executed command code.
RES-CODE	Response code	Stores the response from the executed command.
RES-DATA	Response data	Stores the response data from the executed command.

Data area

Master ← Slave (FZ3)

Output area top channel	Bit															Name
	15	14	13	12	11	10	9	8	7	6	5	4	3	2	1	
+0	DATA0															Output data 0
+1																
+2	DATA1															Output data 1
+3																
+4	DATA2															Output data 2
+5																
+6	DATA3															Output data 3
+7																
+8	DATA4															Output data 4
+9																
+10	DATA5															Output data 5
+11																
+12	DATA6															Output data 6
+13																
+14	DATA7															Output data 7
+15																

Signal	Signal name	Function
DATA0-7	Output data 0 to 7	The data set in the output processing items is output. When there are multiple processing items, data is overwritten to this area while handshaking is performed.

Command Control (EtherNet/IP)

This section explains each command used in EtherNet/IP.

Measurement control command

Command area top channel		Function	References
+3	+2		
0010	1010	Measurement is performed one time.	Reference: ▶ Details (p.164)
0010	1020	Starts continuous measurement	Reference: ▶ Details (p.164)
0010	1030	Completes continuous measurement	Reference: ▶ Details (p.165)
0010	2010	Clears measurement values	Reference: ▶ Details (p.165)
0010	3010	Saves in controller	Reference: ▶ Details (p.166)
0010	F010	Restarts the controller	Reference: ▶ Details (p.166)

Scene control command

Command area top channel		Function	References
+3	+2		
0020	1000	Acquires scene number	Reference: ▶ Details (p.167)
0020	2000	Acquires scene group number	Reference: ▶ Details (p.167)
0030	1000	Switching scenes	Reference: ▶ Details (p.168)
0030	2000	Switches the scene group number	Reference: ▶ Details (p.168)

Settings acquisition/change command

Command area top channel		Function	References
+3	+2		
0040	1000	Acquires unit data	Reference: ▶ Details (p.169)
0040	4000	Acquires setting data related to image logging.	Reference: ▶ Details (p.171)
0050	1000	Sets unit data	Reference: ▶ Details (p.172)
0050	4000	Changes settings related to image logging.	Reference: ▶ Details (p.173)
0070	4000	Saves image data.	Reference: ▶ Details (p.174)

Data Output (EtherNet/IP)

Either fixed point output or floating point output can be selected for data output.

Reference: ▶ Fieldbus Data Output (p.429)

Timing Chart (EtherNet/IP)

I/O timing for each command is explained here.

The signal timing through EtherNet/IP is equivalent to parallel IO, and command execution and data output are performed independently. This section explains the timing of command execution and data output through the EXE signal.

When executing a command with the EXE signal

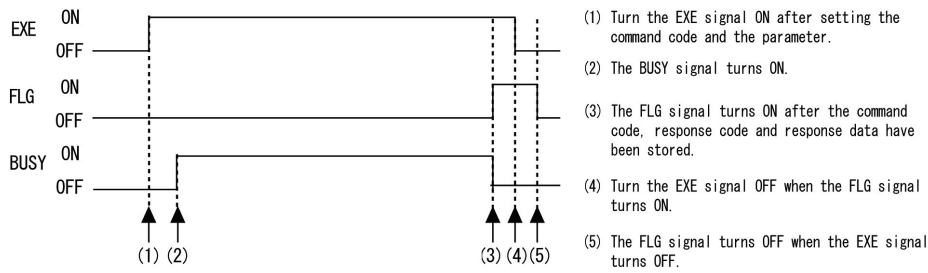

Important

- Control the EXE signal using the FLG signal.
- Screen operation is not allowed when the EXE signal is turned ON. Make sure to turn the EXE signal OFF after executing a command.

For data output (with handshaking)

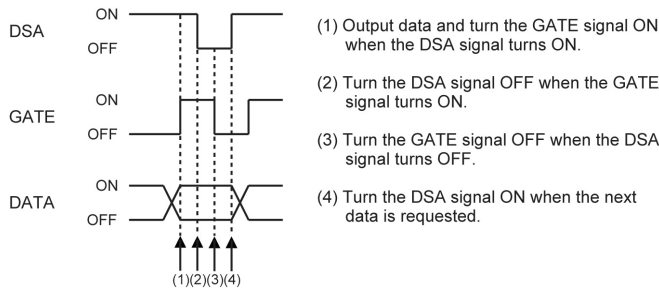

For data output (without handshaking)

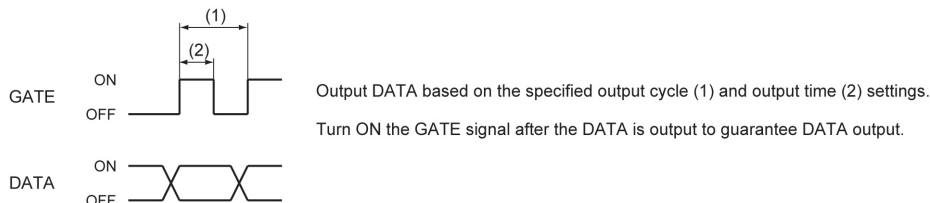

Important

- Set the data output cycle and time so that the following conditions are satisfied.
 - Set the timeout setting so that the PLC timeout time is longer than the measurement processing time.
 - Set the measurement tact interval so that the measurement tact interval is longer than the measurement processing time.
 - Set an output cycle that is longer than the output time, but shorter than the measurement interval.
 - Set the output time that is longer than the PLC cycle time and the EtherNet/IP communication cycle.
- Since a reasonable amount of measurement tact time is required to have stable communications in an operation under high load, verify the operation under the conditions that are to be actually applied.
- Since a large portion of the CPU load is allocated to measurement processing while the multiple input function is being used, a reduction in the performance (such as delayed response and packet loss), or a communication error may occur.
Do not use EtherNet/IP communication when the multiple input function is being used.
- If the measurement interval is short, a communication error may occur depending on the measurement processing time and the PLC settings. Set a PLC timeout time longer than the measurement processing time, or increase the measurement intervals.

Controlling/Outputting through Parallel Communication

This section describes how to set communication specifications and the I/O format required when communicating with external devices through a parallel interface.

Setting Communication Specifications (Parallel Interface)

Set the controller communication specifications. Use the same communication specification settings for the controller and the external device.

Note

- During setting of communication specifications, input signals cannot be handled. However, the input status can be checked with [confirmation].

Reference: ▶ Checking the Communication Status (Parallel Interface) (p.223)

1. On the Main screen, tap [System] menu - [Communication] - [Parallel].
The Parallel window is displayed.
2. Tap [Setting] to set communication specifications.

Parallel

Setting Confirmation

Output polarity : ON at NG

Output control : None

Output period [ms] : 10.0

Gate ON delay [ms] : 1.0

Output time [ms] : 5.0

Timeout [s] : 10.0

Number of delay : 1

One-shot OR signal

Output time [ms] : 5.0

Help OK Cancel

Item	Setting value [Factory default]	Description	
Output polarity	<ul style="list-style-type: none"> · [On at NG] · On at OK 	Select whether to turn on OR and DO0 to 15 when judgement result is OK or when it is NG.	
Output control	[None]	Method to output measurement results without synchronizing with external devices. Reference: ▶ When "Output Control" Is Set to "None" (p.228)	
	Handshaking	Method to output measurement results while synchronizing with external devices. Reference: ▶ When "Output Control" Is Set to "Handshaking" (p.232)	
	Synchronization output	Method to output measurement results while synchronizing with line processing timing. The STEP signal is ignored the number of times set in "Number of delay", and measurement results are output when the STEP signal next turns on. If through images are displayed, however, synchronization output cannot be used. Reference: ▶ When "Output Control" Is Set to "Synchronization Output" (p.233)	
Output period	2.0 to 5000.0 ms [10.0 ms]	Valid only when "Output control" is set to "None". Set the cycle by which measurement results are output. Set the cycle so that the interval is equal to or longer than "Gate ON delay + Output time" and shorter than measurement interval. If the cycle is longer than the measurement interval, output timing will be delayed while measurement is being repeated.	
Gate ON delay	1.0 to 1000.0 ms [1.0 ms]	Set the time from when results are output to the parallel interface to when the GATE signal turns on. Waiting time until data output is stable. Set this so that it is longer than the external device delay time.	
Output time	1.0 to 1000.0 ms [5.0 ms]	Valid only when "Output control" is set to "None" or "Synchronization output". Set the GATE signal ON time. Set the time required for external devices to acquire measurement results.	
Timeout	0.5 to 120.0 s [10.0 s]	Valid only when "Output control" is set to "Handshaking". A timeout error occurs when no response from external devices is received within the time that has been set.	
Number of delay	1 to 15 [1]	Valid only when "Output control" is set to "Synchronization output". Set the number of times that the STEP signal turning on will be ignored before measurement results of the STEP signal are output.	
One-shot OR signal	<ul style="list-style-type: none"> · ON · [OFF] 	Select whether to maintain OR signal output for an arbitrary amount of time.	
	Output time	0.1 to 1000.0 ms [5.0 ms]	Set the OR signal output time. Valid only when "One-shot OR signal" is set to ON. Set a value that is shorter than the measurement time.

3. Tap [OK].

The settings are confirmed and the Parallel window closes.

Checking Communication Status (Parallel Interface)

Check the communication status with the external devices that are connected with a parallel interface. You can check whether wiring and communication settings have been performed correctly.

1. On the Main screen, tap [System] menu - [Communication] - [Parallel].
The Parallel window is displayed.
2. Tap [Confirmation] to check the I/O status.

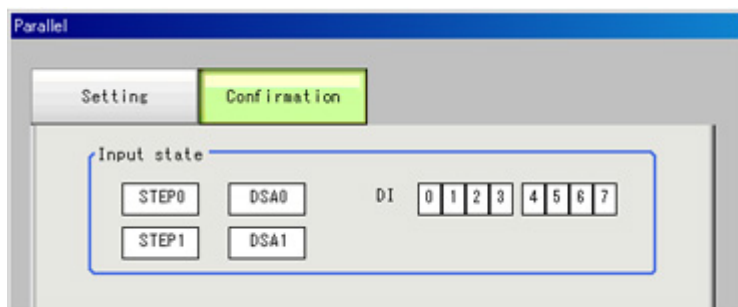

Display	Description
STEP0,STEP1	The input status of each signal from the external device to the controller is displayed. When a signal is input, the background color becomes red.
DSA0,DSA1	
DI	
RUN	The output status of each signal is displayed. When a signal is output, the background color becomes red.
GATE0,GATE1	
BUSY	The output status from each signal of the controller to external devices can be specified.
OR0,OR1	
ERR	Changes between ON and OFF and between 0 and 1 can be simulated without performing measurement.
READY0,READY1	
DO	

Operation mode = [Multi-line random-trigger mode] (FZ3-9 □□ /H9 □□ series only)

I/O	Multi-line random trigger mode		Other than Multi-line random trigger mode
	Line 0	Line 1	
STEP	STEP0	STEP1	STEP0
DSA	DSA0	DSA1	DSA0
DI	DI0 to DI7	DI0 to DI7	DI0 to DI7
RUN	No output		RUN
GATE	GATE0	GATE1	GATE0
BUSY	BUSY	RUN	BUSY
OR	OR0	OR1	OR0
ERR	ERR (common)		ERR
READY	READY0	READY1	READY0
DO	DO0 to DO7	DO8 to DO15	DO0 to DO15

Important

- That status of each of the parallel terminal signals STEP, DSA, GATE, OR, and READY can be checked on the screen with STEP0, DSA0, GATE0, OR0, and READY0.
- If the operation mode (FZ3-9 □□ /H9 □□ only) is [Multi-line random-trigger mode], line 0 uses GATE0, OR0, READY0, STEP0 and DSA0, while line 1 uses GATE1, OR1, READY1, STEP1 and DSA1.
- If the operation mode (FZ3-9 □□ /H9 □□ only) is [Multi-line random-trigger mode], the RUN signal cannot be checked.
- If the operation mode (FZ3-9 □□ /H9 □□ only) is [Multi-line random-trigger mode], the ERR signal is used in common.

3. Change the contents to be sent.

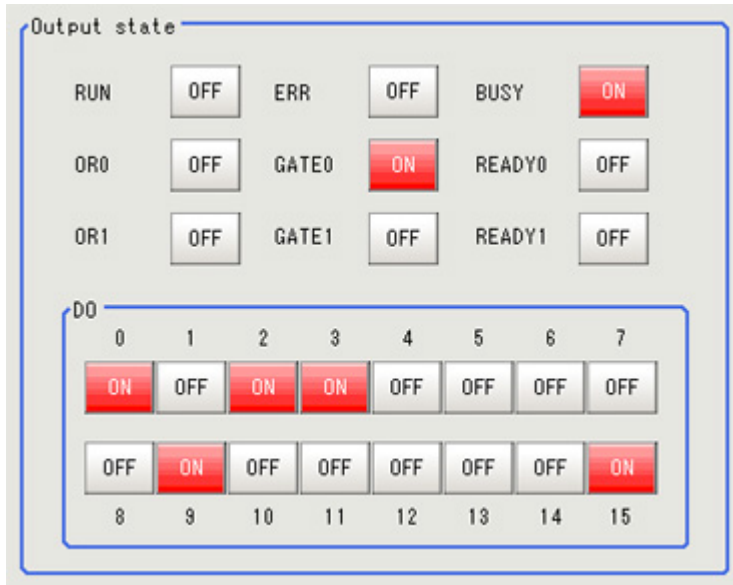

When switching between "ON"/"OFF" is performed, the changed contents are displayed on the monitors of external devices. Please verify it.

4. Tap [OK].

The Parallel window closes.

I/O Format (Parallel Interface)

Input Format

When the Main screen is displayed, the following commands can be input.

- STEP signal
Measurement is performed once when STEP signal turns on.
- DSA signal
When "Output Control" is set to "Handshaking", this is a signal to provide notification that the external device is ready to receive data.
Reference: ▶ Setting Communication Specifications (Parallel Interface) (p.221)
- DI signal
Commands can be input in the following format. Set 0 (OFF) or 1 (ON) for each DI signal.
Confirm commands and information, and turn DI7 (execute) ON with an interval of at least 1 ms.

When 1 line is used

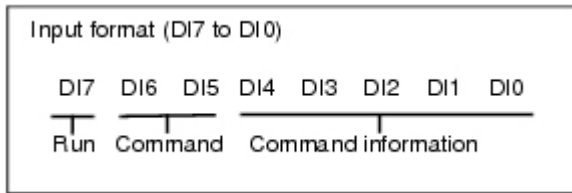

Item	Description	Input format (DI7 to DI0)			Input example
		Execute (DI7)	Command (DI6, DI5)	Command information (DI4 to 0)	
Continuous measurement	Measure continuously during input of commands.	1	00	***** The controller does not detect this signal, so a setting of either 0 or 1 makes no difference.	Input example: 10000000
Scene switch	Switch measurement scenes.	1	01	Input "Scene No." in binary format.	Switch to scene 2. Input example: 10100010
Scene group switch	Switch measurement scene groups.	1	11	Input "Scene Group No." in binary format.	Switch to scene group 2. Input example: 11100010
Clearing Measurement Values	Clear measurement values. The OR signal and DO signal are not cleared.	1	10	00000	Input example: 11000000
Clear Error	Clear error output. The ERROR indicator is also cleared.	1	10	00001	Input example: 11000001
Clear Parallel OR+DO	Clear the OR signal and DO signal.	1	10	00010	Input example: 11000010

0: OFF 1: ON

Operation mode (FZ3-9 □ □ /H9 □ □ only) = [Multi-line random-trigger mode]

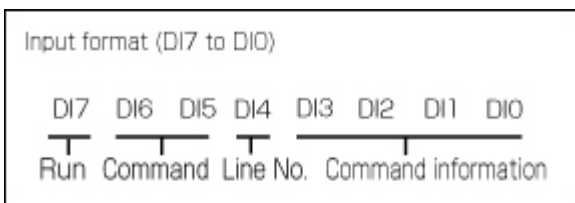

Item	Description	Input format (DI7 to DI0)				Input example
		Execute (DI7)	Command (DI6, DI5)	Line No. (DI4)	Command information (DI3 to 0)	
Continuous measurement	Measure continuously during input of commands.	1	00	0 or 1 Specify the line number to send commands to.	***** The controller does not see this signal, so a setting of either 0 or 1 makes no difference.	Continuously measure line 1 Input example: 10010000
Scene switch	Switch measurement scenes.	1	01		Input "Scene No." in binary format.	Switch line 0 to Scene 2 Input example: 10100010
Scene group switch	Switch measurement scene groups.	1	11		Input "Scene Group No." in binary format.	Switch line 1 to Scene Group 2 Input example: 11110010
Clearing Measurement Values	Clear measurement values. The OR signal and DO signal are not cleared.	1	10		0000	Clear the measurement values of line 1 Input example:11010000
Clear Error	Clear error output. The ERROR indicator is also cleared.	1	10		0001	Clear the error of line 0 Input example: 11010001
Clear Parallel OR+DO	Clear the OR signal and DO signal.	1	10		0010	Clear the OR signal and DO signal of line 1 Input example: 11010010

0: OFF 1: ON

Reference

- When the input command is not received correctly, the ERROR signal turns on.

Important

- When parallel continuous measurement is engaged and continuous STEP signal is input, switching of scene group should be avoided. When this is performed, set "Unchecked" in "Save scene group on switch scene" in either of the settings items below.
 - Switch Scene Group window Reference: ▶ Switching Scene Groups (p.65)
 - [Measure setting] in the [Measure] menu Reference: ▶ Setting Conditions Related to Operation during Measurement (p.130)

Output Format

Each time measurement is performed, the measurement result is output.

Output can be selected to turn on either when the judgement result is OK or when it is NG. The factory default setting is "ON at NG".

Reference: ▶ Setting Communication Specifications (Parallel Interface) (p.221)

Signal	Output contents
OR signal	Overall judgement results are output.
DO 0 to 15 signal ^[Note 1]	<p>Parallel judgement output The judgement results of judgement 0 to 15 set in the processing item [Parallel Judgement Output] are output to DO 0 to 15. Reference: ▶ "Processing Item List Manual", "Parallel Judgement Output" (p.426)</p>
	<p>Parallel Data Output The measurement values set in data 0 to 7 in the processing item [Parallel Data Output] are output in 16-bit format. Reference: ▶ "Processing Item List Manual", "Parallel Data Output" (p.423)</p> <ul style="list-style-type: none"> Only integers are output. Decimals are rounded up. The range of values that can be output is as follows: Binary format: -32768 to +32768 BCD format: -999 to +999 <p>When measurement values are outside of these ranges, the following apply.</p> <p>Binary format: When -32768 is > measurement value, -32767 is output. When measurement value is > +32768, +32768 is output.</p> <p>BCD format: When -999 is > measurement value, -999 is output. When measurement value is > +999, +999 is output.</p> <ul style="list-style-type: none"> For the output format, select from a 2's complement binary format or BCD format. For 2's complement, see Reference: ▶ Terminology Explanations (p.325) Output sequence Measurement results are output in sequence starting with the smallest processing unit number. <p>Example) When [Parallel Judgement Output] is processing unit 5 and [Parallel Data Output] is processing unit 8</p>

[Note 1]: If the operation mode (FZ3-9 □ □ /H9 □ □ only) is [Multi-line random-trigger mode], line 0 uses DO0 to DO7, while line 1 uses DO8 to DO15. For parallel judgement output setting, set the judgement result to be output to expressions 0 to 7 for lines 0 and 1.

Reference: ▶ "Processing Item List Manual", "Parallel Judgement Output" (p.426)

The parallel data output range is between -127 and 127 for binary data, and -9 and 9 for BCD data.

Reference

- After measurement, the data output by the OR signal or DO signal is held until the next measurement is performed. Note that the output status will be maintained even after measurement is complete. However, when [One-shot OR signal] is on in Reference: ▶ Setting Communication Specifications (Parallel Interface) (p.221), the OR signal will turn off after the set output time has elapsed.
- The output signal factory default setting is OFF, but the signal may be ON for approximately 0.5 second when power is turned on. Be careful of signal loading occurring at external devices.

Timing Chart

Here, I/O timings of various commands are described.

- Reference: ▶ When "Output Control" Is Set to "None" (p.228)
- Reference: ▶ When "Output Control" Is Set to "Handshaking" (p.232)
- Reference: ▶ When "Output Control" Is Set to "Synchronization Output" (p.233)
- Reference: ▶ Scene/Scene Group Switch (p.234)
- Reference: ▶ Clears measurement value by the parallel command (p.236)
- Reference: ▶ Clears the OR and DO signal by the parallel command (p.237)
- Reference: ▶ Clears error by the parallel command (p.238)
- Reference: ▶ About Multiple Image Input Function (p.239)

When "Output Control" Is Set to "None"

Output the measurement results if controller is not synchronous with external devices. Have the external devices detect the GATE signal of the controller, and load DO signal during ON status.

Inputting a measurement trigger in the STEP signal

Example 1) When 3 expressions are set in [Parallel Data Output]:

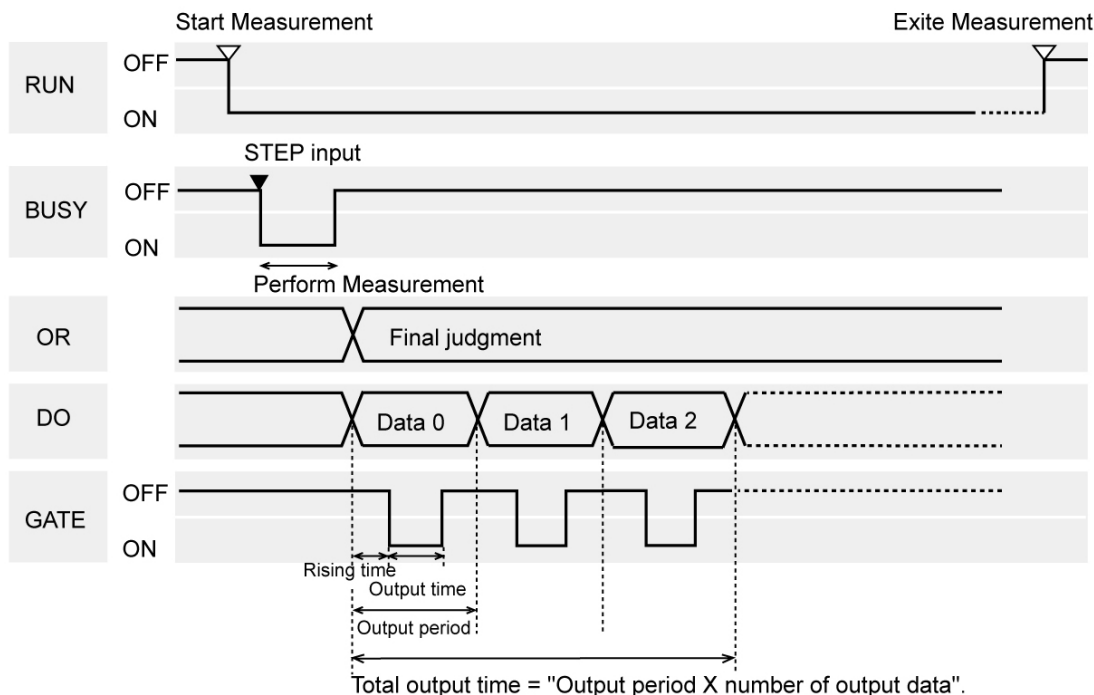

Example 2) If there is a process after a [Parallel judgement output]

■ Flow setting example 2

0. Camera Image Input
1. Search
2. Parallel Judgement Output
3. Data Logging

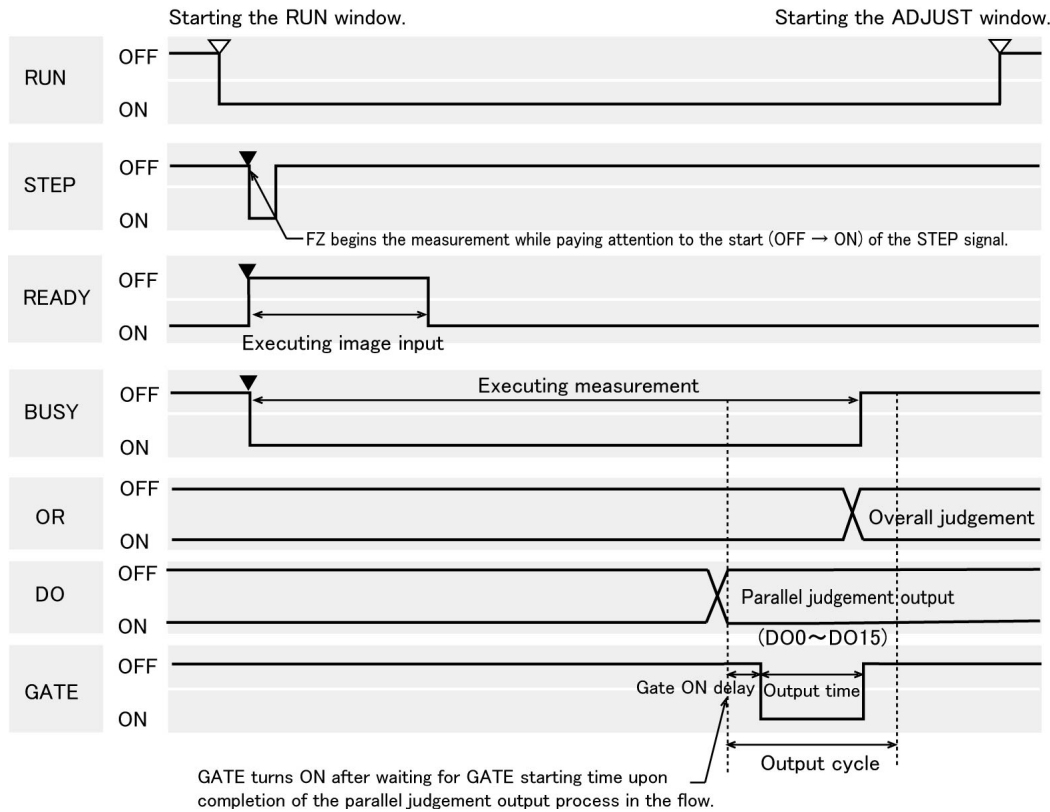

Output signal

Signal	Function
RUN	Turns on when the controller is available for measurement and the RUN window is displayed. It is OFF in the ADJUST window, so switch to the RUN window during operation.
BUSY	Indicates that controller is currently measuring or switching the scene. Do not input next command while the BUSY signal is on. Otherwise, on-going processing or commands that are input will not be performed correctly.
OR	Outputs overall judgement. This is determined when the measurement is completed (BUSY signal ON → OFF). Selection of whether ON occurs during an OK judgement result or NG judgement result can be performed in the communication specifications settings window. Reference: ▶ Setting Communication Specifications (Parallel Interface) (p.221)
DO	Outputs the results for expressions set in the processing item [Parallel Judgement Output]/[Parallel Data Output]. Selection of whether ON occurs during an OK judgement result or NG judgement result can be performed in the communication specifications settings window. Reference: ▶ Setting Communication Specifications (Parallel Interface) (p.221)

GATE	Used to control the loading time of the DO signal to external devices. ON for the time required for external devices to securely load the DO signal. Set the output cycle so that the total output time is shorter than measurement interval (input interval of STEP signal). GATE signal is output only when the [Parallel judgement output] and [Parallel data output] are set in the measurement flow, and the output process begins when the signal passes through the parallel judgement output (parallel data output) point in the flow. Depending on the setting flow, GATE output may be started when the BUSY signal is ON. Note that the OR signal and GATE signal do not necessarily operate simultaneously. Example 2)
READY	ON when STEP signal can be input. When through images are being displayed, the READY signal will turn to OFF, but the STEP signal is received. During the through display, determine whether or not STEP input is allowed based on the BUSY signal.

Input signal

Signal	Function
STEP	Input measurement triggers from external devices such as optic switches, etc. Perform measurement once synchronous with the STEP signal turning on (OFF → ON). Turn the STEP signal ON for at least 0.5 ms. A noise filter (filter initial setting value: 100 μs) is set in STEP input.

Reference

- The following can be changed with regard to the READY signal.
 - Handling of ERROR signal when STEP signal is input during measurement
Reference: ▶ Setting Conditions Related to Operation during Measurement (p.130)

Important

- When parallel continuous measurement is engaged and continuous STEP signal is input, switching of scene group should be avoided. When this is performed, set "Unchecked" in "Save scene group on switch scene" in either of the settings items below.
 - Switch Scene Group window Reference: ▶ Switching Scene Groups (p.65)
 - [Measure setting] in the [Measure] menu Reference: ▶ Setting Conditions Related to Operation during Measurement (p.130)

Continuous measurement

Important

- Measurement is given priority when continuous measurement is being performed. As a result, the measurement result display (overall judgement, image, judgement for each processing unit in the flow display, detailed results) may not be updated.
When continuous measurement ends, the measurement results of the final measurement are displayed.

Example) When 1 expressions are set in [Parallel Data Output]:

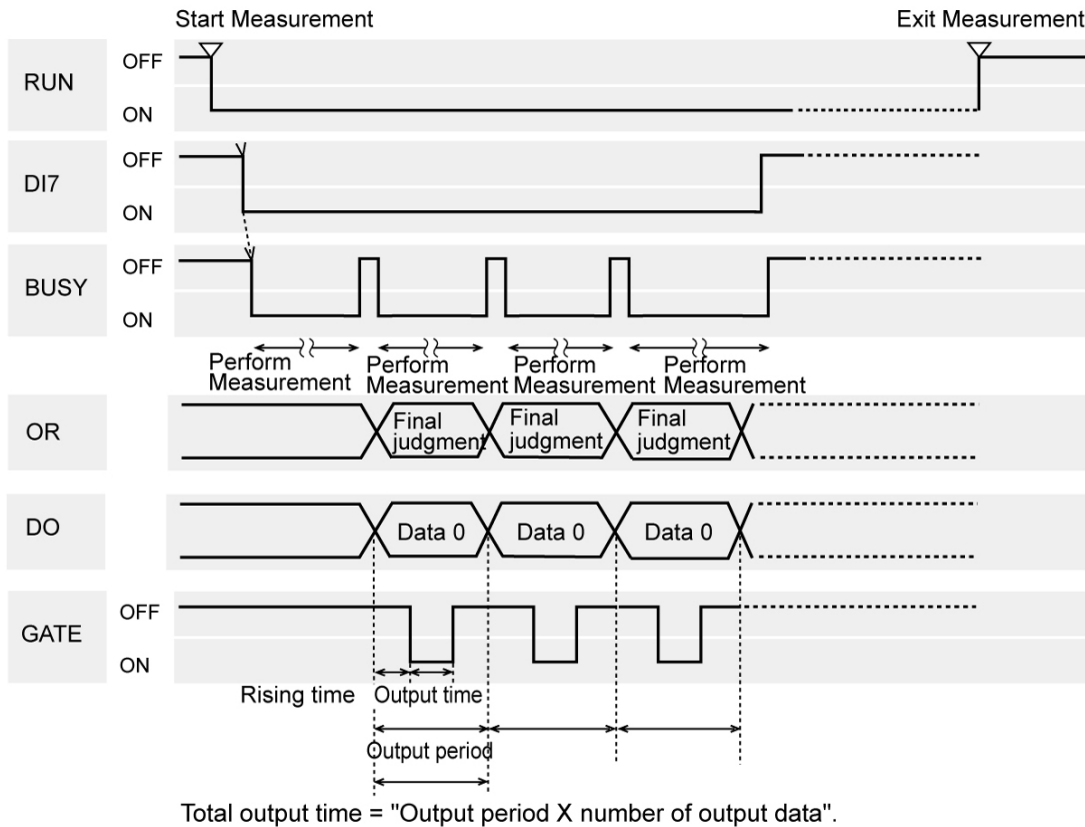

Reference

- The output signal functions the same as when "Output Control" is set to "None".
Reference: ▶ When "Output Control" Is Set to "None" (p.228)

Input signal

Signal	Function
DI0 to 6	It turns off while continuously measuring (DI7 being turned on).
DI7	This is the execution trigger. After DI0 to 6 is set, turn DI7 on after an interval over 1 ms. Always have this turned ON during a continuous measurement. Stops continuous measurement when this is turned OFF.

Reference

- The ERROR signal turns on when the input command is not correctly performed.
- Acquisition is difficult since the amount of time during which the BUSY signal is turned OFF during a continuous measurement by the parallel command is extremely short at 1 ms or less. Acquires the OR signal at the time when the GATE signal turns ON after adding the parallel judgement output at the end of the flow.

When "Output Control" Is Set to "Handshaking"

Output the measurement results if controller is synchronous with external devices. If this function is used when multiple measurement results are output in sequence, it enables efficient and effective data transfer.

Inputting a measurement trigger in the STEP signal

Example) When 3 expressions are set in [Parallel Data Output]:

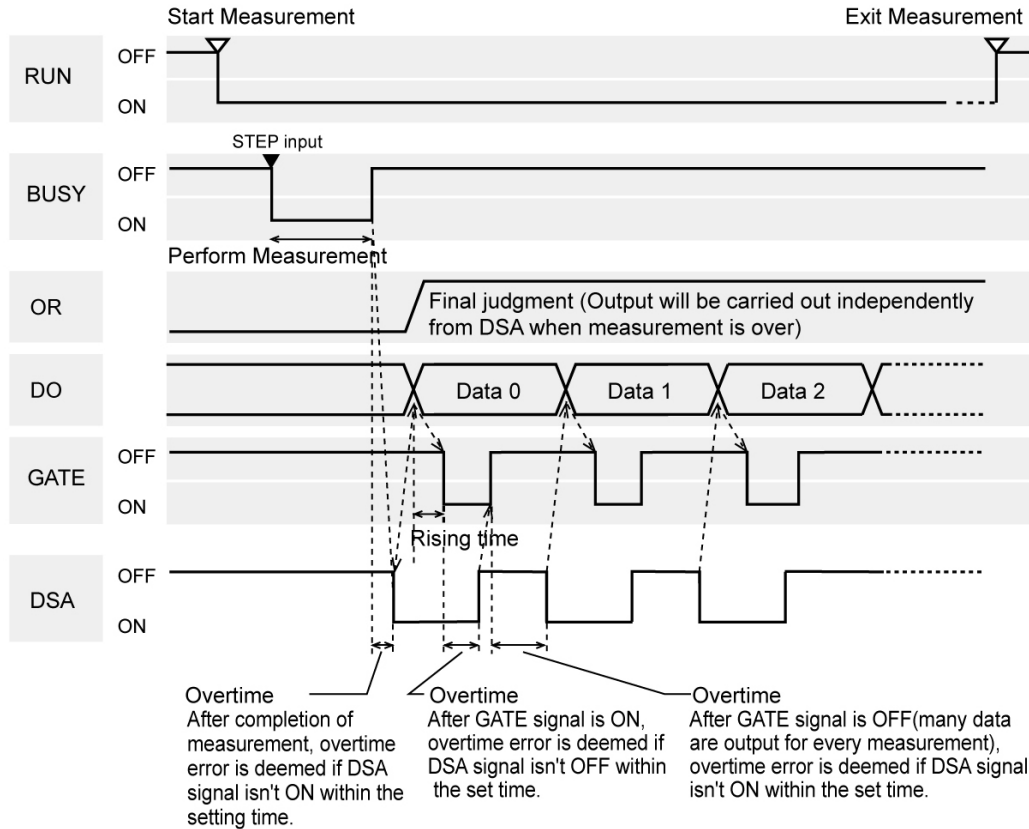

Reference

- The output signal functions the same as when "Output Control" is set to "None".
Reference: ▶ When "Output Control" Is Set to "None" (p.228)

Input signal

Signal	Function
DSA	<p>This signal is used to request the next data transfer from external devices. The controller does not output data until the DSA signal is on. Turn the DSA signal on in the following cases:</p> <ul style="list-style-type: none"> The receiving system for external devices is complete The controller has completed measurement <p>The BUSY signal is on during measurement. As a result, the timing of when measurement is complete can be understood by observing the BUSY signal.</p>

When "Output Control" Is Set to "Synchronization Output"

This method enables synchronization between processing timing on the line and timing for output of controller results. After the STEP signal has turned on the number of times set in "number of delay" in the communication specifications, measurement results will be output the next time the STEP signal turns on.

Reference

- When the communication specification "Output Control" is set to "Synchronization output", levels will be counted according to the number of times the STEP signal turns on. For this reason, perform settings so that results are output only once for each measurement. (1 unit for [Judgement Output], 1 data item for [Data Output])
Reference: ▶ Setting Communication Specifications (Parallel Interface) (p.221)
- Only designate the STEP signal for measurement command input.
When measurement using serial commands and continuous measurement are performed, the output time will not match and this can cause controller malfunctions.

Example) Stepped transmission line utilizing star wheel

The discharge timing for when a defective part is found and the measurement results output timing can be synchronized.

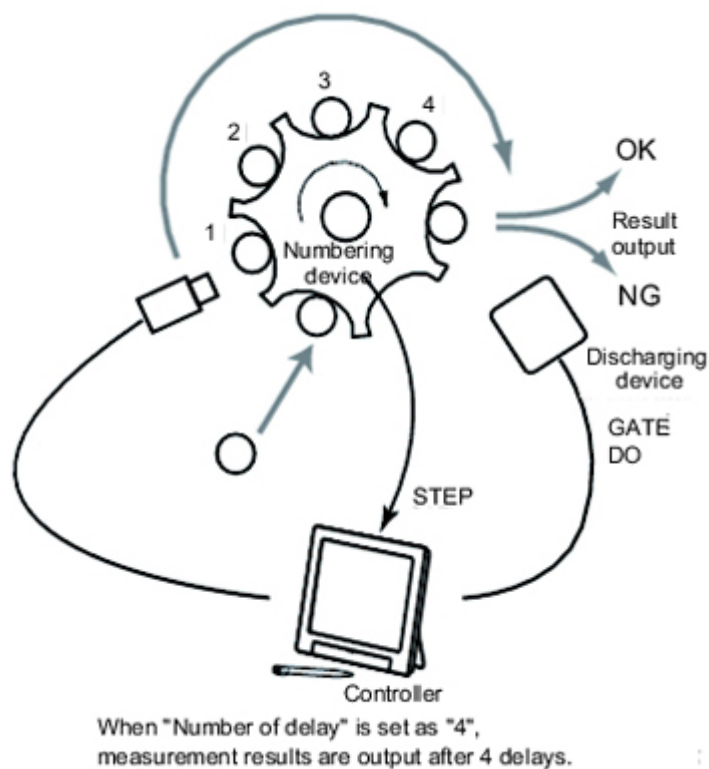

Inputting a measurement trigger in the STEP signal

Example) When "2" is set for "Number of delay"

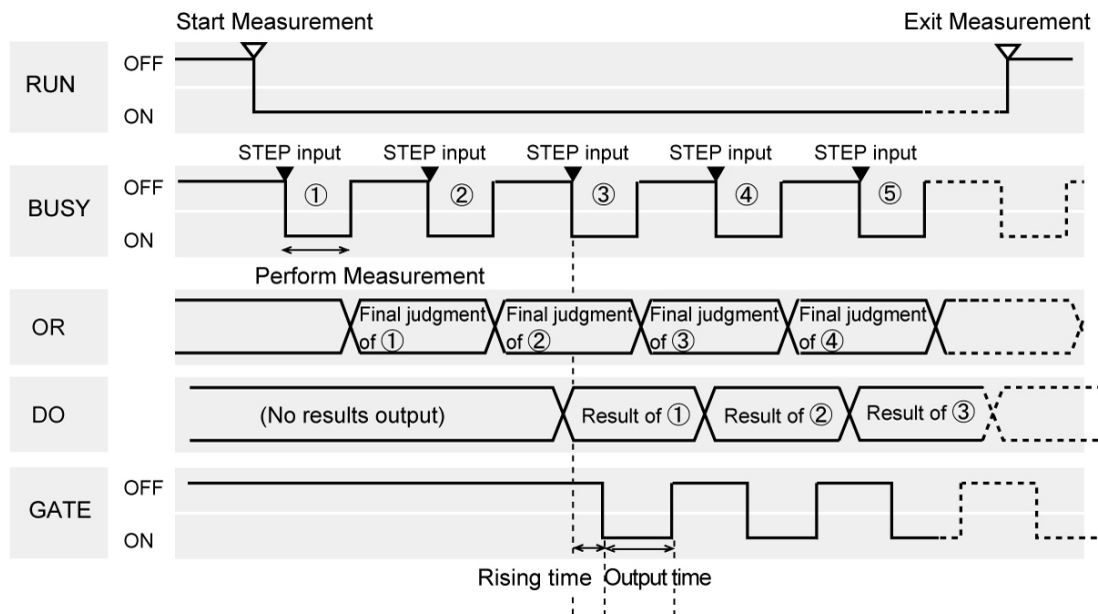

Reference

- The output signal functions the same as when "Output Control" is set to "None".
 Reference: ▶ When "Output Control" Is Set to "None" (p.228)

Scene/Scene Group Switch

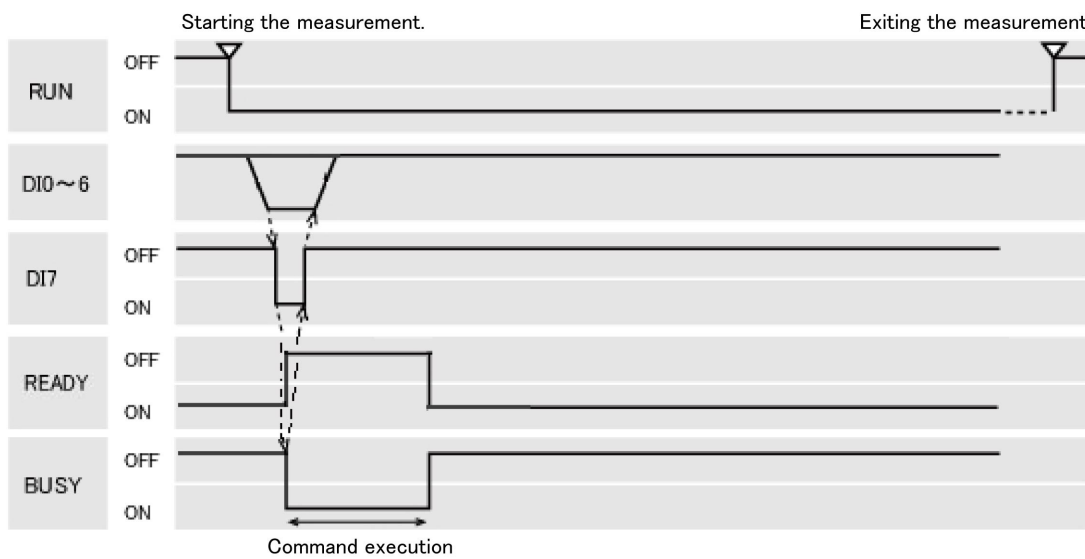

Output signal

Signal	Function
RUN	Turns on when the controller is available for measurement and the RUN window is displayed. Turns off in the ADJUST window.
READY	Turns OFF when a scene or a scene group is being switched. Turns OFF as long as the BUSY signal is turned ON.

BUSY	Indicates that the controller is currently switching the scene or scene group. Do not input next command while the BUSY signal is on. Otherwise, on-going processing or commands that are input will not be performed correctly.
------	--

Input signal Scene switching

Signal	Function
DI0 to 4	Set scene No. (0 to 31).
DI5	ON
DI6	OFF
DI7	This is the execution trigger. After DI0 to 6 is set, turn DI7 on after an interval over 1 ms. BUSY signal is on during implementation of commands. If the DI7 signal OFF timing cannot be set faster than the BUSY signal OFF timing on the control side, set the scene switching additional time to lengthen the BUSY signal OFF timing.

Reference

- The amount of time during which the BUSY signal is turned ON when a scene is switched can be changed. [Measurement setting] in the [Measure] menu Setting conditions related to operation during measurement

Input signal Scene group switching

Signal	Function
DI0 to 4	Set scene group No. (0 to 31).
DI5	ON
DI6	ON
DI7	This is the execution trigger. After DI0 to 6 is set, turn DI7 on after an interval over 1 ms. BUSY signal is on during implementation of commands. After checking that the BUSY signal has turned on, turn DI7 off, and then turn DI0 to 6 off. If the DI7 signal OFF timing cannot be set faster than the BUSY signal OFF timing on the control side, set the scene switching additional time to lengthen the BUSY signal OFF timing.

Clears measurement value by the parallel command

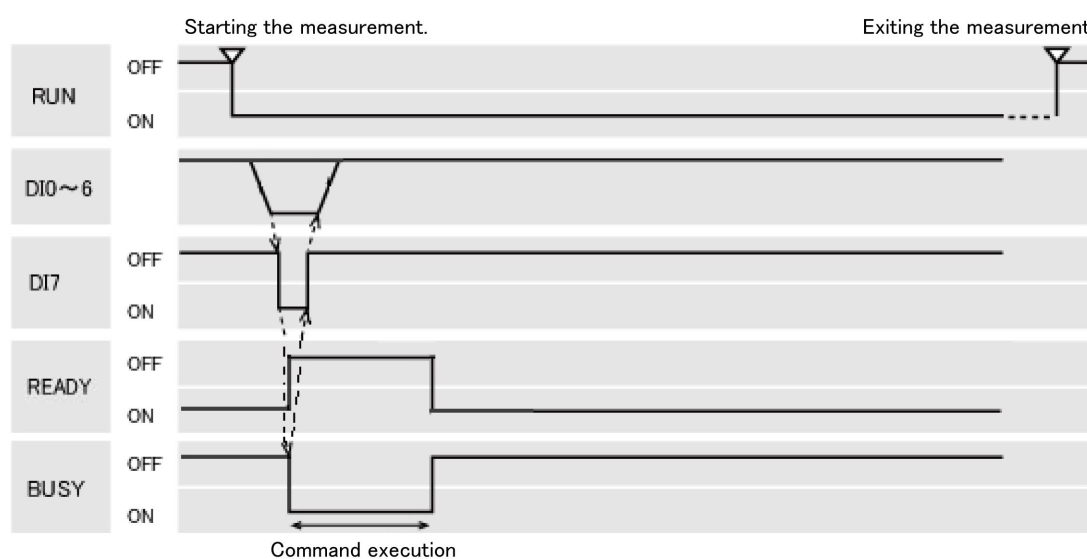

Output signal

Signal	Function
RUN	Turns ON when the controller is set to the RUN window. Turns OFF in the ADJUST window.
READY	Turns OFF when the command to clear the measurement value is being executed. Turns OFF as long as the BUSY signal is turned ON.
BUSY	Turns ON when the measurement value is being cleared. The amount of time during which the BUSY signal is turned ON is approximately 1 ms.

Input signal

Signal	Function
DI0 to 4	Turns the command OFF.
DI5	Turns the command OFF.
DI6	Turns the command ON.
DI7	This is the trigger signal to clear a measurement value. After DI0 to 6 is set, turn DI7 ON after an interval over 1 ms. BUSY signal is ON during execution of commands. After checking that the BUSY signal has turned ON, turn DI7 OFF, and then turn DI0 to 6 OFF. Note, however, that the amount of time during which the BUSY signal is turned ON is approximately 1 ms. If it cannot be recognized whether the BUSY signal is turned ON or not by an external device, control the timing so that the DI7 signal is turned ON for approximately 5 ms.。

Clears the OR and DO signal by the parallel command

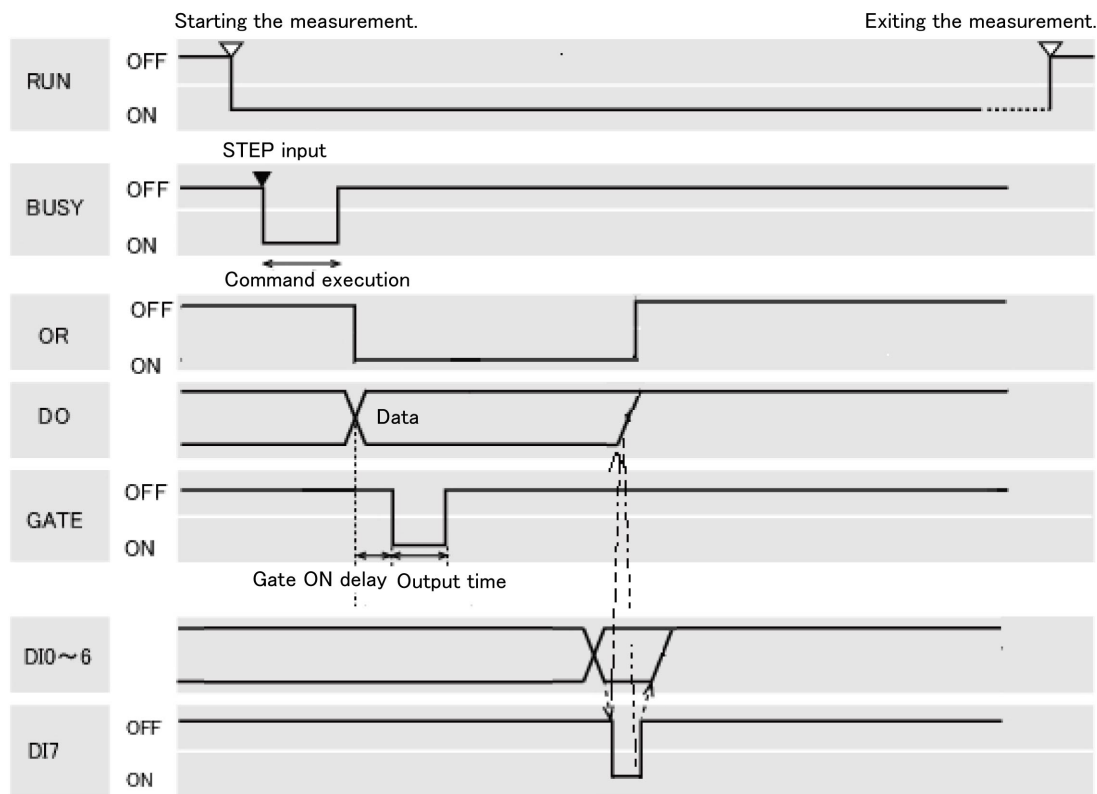

Output signal

Signal	Function
RUN	Turns ON when the controller is set to the RUN window. Turns OFF in the ADJUST window.
READY	This does not change when the OR and DO signal is being cleared. Do not, however, clear the OR and DO signal when the READY signal is turned OFF. The command will not be executed correctly.
BUSY	This does not change when the OR and DO signal is being cleared. Do not, however, clear the OR and DO signal when the BUSY signal is turned ON. The command will not be executed correctly.
OR	It will turn OFF if it was turned ON.
DO0 to 15	It will turn OFF if it was turned ON.
GATE	This does not change when the OR and DO signal is being cleared. Do not, however, clear the OR and DO signal when the GATE signal is turned ON. The command will not be executed correctly. Or, the DO and GATE will not be output correctly.

Input signal

Signal	Function
DI0	Turns the command OFF.
DI1	Turns the command ON.
DI2 to 5	Turns the command OFF.
DI6	Turns the command ON.

DI7	This is the trigger signal to clear the OR and DO signal. After DI0 to 6 is set, turn DI7 ON after an interval over 1 ms. After checking that the OR or DO signal has turned OFF, turn DI7 OFF, and then turn DI0 to 6 OFF.
-----	--

Clears error by the parallel command

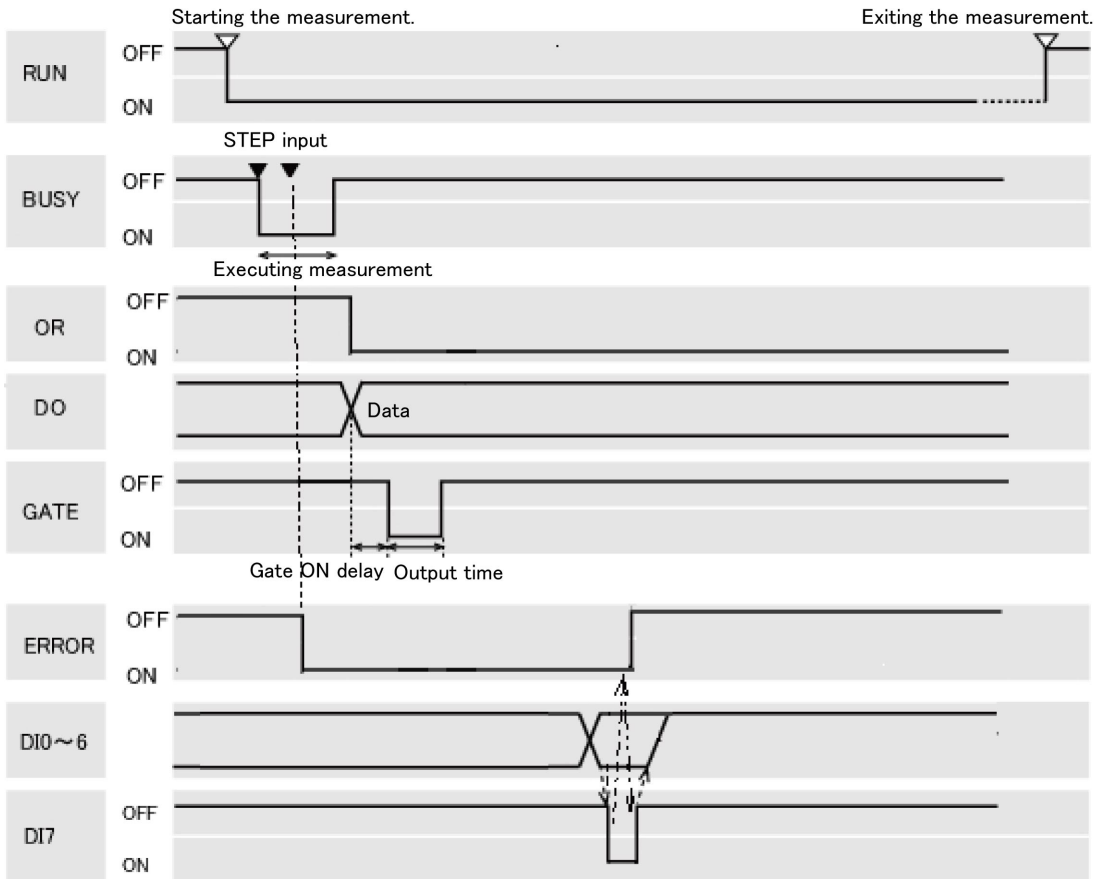

Output signal

Signal	Function
RUN	Turns ON when the controller is set to the RUN window. Turns OFF in the ADJUST window.
READY	This does not change when an error is being cleared. Do not, however, clear the error signal when the READY signal is turned OFF. The command will not be executed correctly.
BUSY	This does not change when an error is being cleared. Do not, however, clear an error when the BUSY signal is turned ON. The command will not be executed correctly.
OR	This does not change when an error is being cleared.
DO0 to 15	This does not change when an error is being cleared.
GATE	This does not change when an error is being cleared.

Input signal

Signal	Function
DI0	Turns the command ON.
DI1 to 5	Turns the command OFF.
DI6	Turns the command ON.
DI7	This is the trigger signal to clear an error. After DI0 to 6 is set, turn DI7 ON after an interval over 1 ms. After checking that the ERROR signal has turned OFF, turn DI7 OFF, and then turn DI0 to 6 OFF.

About Multiple Image Input Function

The function that enables continuous high speed image input is called the multiple image input function. The next STEP signal can be received at the point when image input is complete. It is not necessary to wait until measurement processing is complete. Whether image input is complete or not can be checked with the status of the READY signal.

In the case of FZ3-9 □ □ /H9 □ □ where two CPUs are installed, you can use the [Single-line High-speed mode] function that causes the two CPUs to alternately process measurement to shorten the shortest takt time *1 to as much as one half.

*1: The shortest takt time refers to the shortest time over which a STEP can be accepted without generating a pool of captured images.

Reference: ▶ Single-line High-speed Mode (p.34)

Important

- Set the image mode to "Freeze".
- When loading images continuously at high speed, the number of images that can be loaded is limited. Once the maximum number of images have been loaded, the READY signal will not turn on until the current measurement processing is complete. Accordingly, the next STEP cannot be input.
Reference: ▶ About Max. Number of Loading Images during Multiple Image Input (p.349)
- If STEP is input while READY is off, the ERROR terminal turns on.
- If triggers are input continuously and too quickly for the communication output to catch up, some steps may not be output or measurement delays may occur. Input triggers at appropriate timings that do not cause communication delays.
- The multiple image input function cannot be used in the following cases:
 - Multiple camera input processing units are present in the flow.
 - An Camera Image Input HDR is present in the flow.
 - 1 camera input processing unit is used in multiple processes using the branching function.
 - Measurement triggers are input other than in the parallel mode (such as when non-procedure commands or PLC-link measurement commands are sent).

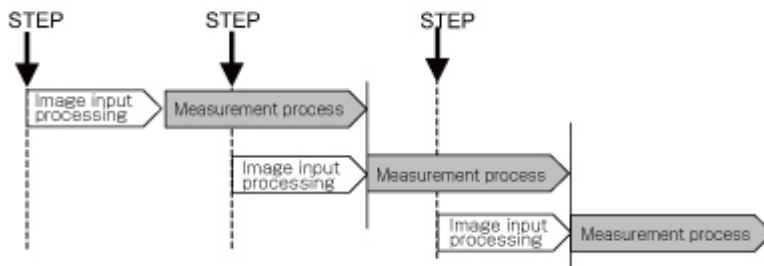
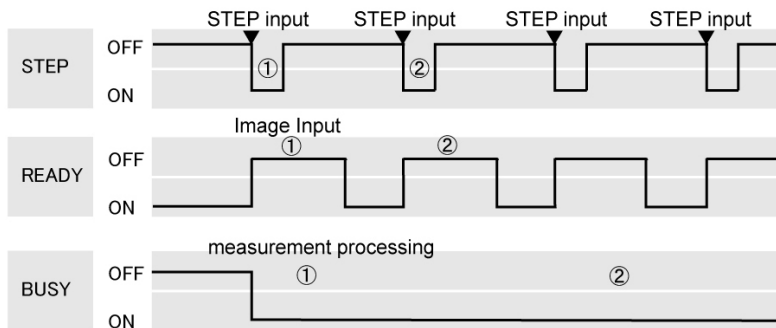

Externally Outputting Data through FTP

The image logging file and data logging file saved in the controller can be output using FTP protocol.

FZ3 only functions as a FTP server and cannot serve as a FTP client.

FTP uses the FTP passive mode. Use port 21 for FTP control (commands and responses), and use the port specified by the Ethernet I/O setting for FTP data transfer (downloading of ls command results and files).

Important

- When sending or receiving files using the FTP function, make sure to create file names using one-byte alphanumeric characters.

Setting Communication Specifications

Set the communication specifications such as IP address and DNS. In addition, perform input format settings.

Important

- Use the same communication specification settings for the controller and the external device.

1. On the Main screen, tap the [System] menu - [Communication] - [Serial] - [Ethernet].
The Ethernet window is displayed.
2. Set the following items.

The screenshot shows the 'Ethernet' configuration window. It is divided into two main sections: 'Address setting' and 'Input/Output setting'.
In the 'Address setting' section, the 'Use the following IP address' option is selected. The fields are filled with: IP address: 10.5.5.100, Subnet mask: 255.255.255.0, Default gateway: 10.5.5.110, and DNS server: 10.5.5.1.
In the 'Input/Output setting' section, the 'Input mode' is 'Normal' and 'Input form' is 'ASCII'. The 'Output IP address' is 0.0.0.0 and the 'Input/Output port No.' is 9600.
Buttons for 'Help', 'OK', and 'Cancel' are located at the bottom of the window.

Setting item	Setting value [Factory default]	Description
Address setting		
	<ul style="list-style-type: none"> • Obtain an IP address automatically • [Use the following IP address] 	<p>Set the IP address of the controller.</p> <p>When "Obtain an IP address automatically" is selected, the IP address of the controller will be automatically obtained.</p> <p>When "Use the following IP address" is selected, set the IP address, subnet mask, and the default gateway address.</p>
IP address	a.b.c.d a: 1 to 223 b: 0 to 255 c: 0 to 255 d: 0 to 255 [10.5.5.100]	Input the controller IP address.
Subnet mask	0.0.0.0 to 255.255.255.255 [255.255.255.0]	Input the subnet mask address.
Default gateway	0.0.0.1 to 255.255.255.254 [10.5.5.110]	Input the default gateway address.
DNS server	a.b.c.d a: 1 to 223 b: 0 to 255 c: 0 to 255 d: 0 to 255 [10.5.5.1]	Input the DNS server address.
I/O setting		
Input mode	[Normal]	This item cannot be changed.
Input format	[ASCII]	This item cannot be changed.
Output IP address	a.b.c.d a: 1 to 223 b: 0 to 255 c: 0 to 255 d: 0 to 255 [0.0.0.0]	Input the output destination IP address.
I/O port No.	0 to 65535 [9600]	Set the port No. to use for data I/O with the controller. When PLC link or UDP communication is used in addition to FTP, specify the I/O port number to be used in each communication. FTP uses 20 and 21 for I/O ports regardless of the I/O port number settings.

3. Tap [OK].

The settings are confirmed and the Ethernet window closes.

Communication Example

This section introduces methods for outputting logging image files using Internet browsers. When actually performing this operation, it is necessary to create software for outputting data.

Important

- In the case of FZ3-9 □□ /H9 □□ , only 2 USB memory devices can be accessed.

- Input the controller IP address in the Internet browser.
(Here, the default controller address 10.5.5.100 is used as an example of IP address.)
The folders in the controller are shown.

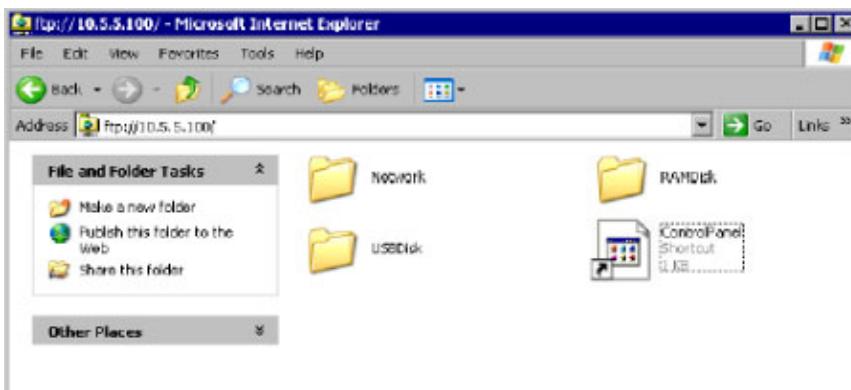

Folder name	Description
Network	This folder is used for management. Data cannot be saved within this folder.
RAMDisk	This folder is for storing logging images and data files. When the RAMDisk is set as the save destination, files are stored in this folder.
USBDisk	Displayed when a USBDisk is plugged into the controller. When the USBDisk is set as the save destination, files are stored in this folder.
Control Panel.Ink	This file is used for management. Do not delete this file.

- To view the inside of the RAMDisk, enter RAMDisk at the end of the IP address.
When the RAMDisk is set as the image logging destination, the logging files are displayed.

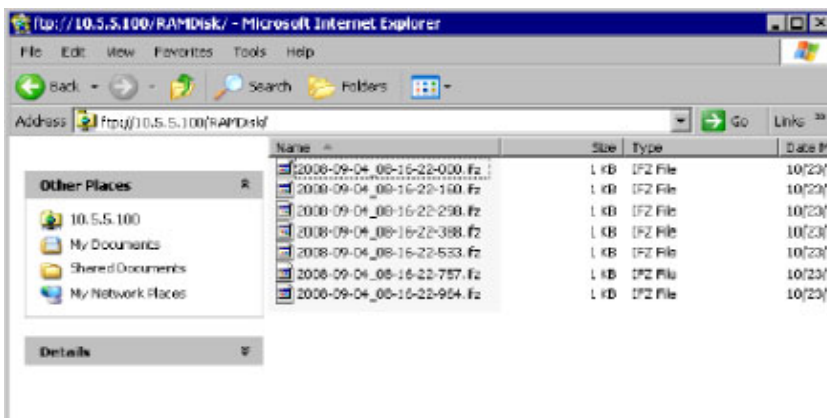

- In the same way as with normal file operations, logging images can be output from the controller.

External Reference Tables

Input image

- ▶ Reference: Measurement Image Switching (p.247)

Measurement

- ▶ Reference: Search (p.248)
- ▶ Reference: Flexible Search (p.249)
- ▶ Reference: Sensitive Search (p.250)
- ▶ Reference: ECM Search (p.252)
- ▶ Reference: EC Circle Search (p.253)
- ▶ Reference: Shape Search+ (p.255)
- ▶ Reference: Classification (p.257)
- ▶ Reference: Edge Position (p.258)
- ▶ Reference: Edge Pitch (p.259)
- ▶ Reference: Scan Edge Position (p.260)
- ▶ Reference: Scan Edge Width (p.261)
- ▶ Reference: Color Data (p.262)
- ▶ Reference: Gravity and Area (p.263)
- ▶ Reference: Labeling (p.265)
- ▶ Reference: Label Data (p.267)
- ▶ Reference: Labeling+ (p.268)
- ▶ Reference: Defect (p.272)

- ▶ Reference: Precise Defect (p.273)
- ▶ Reference: Fine Matching (p.274)
- ▶ Reference: Character Inspection (p.275)
- ▶ Reference: Date Verification (p.276)
- ▶ Reference: Model Dictionary (p.277)
- ▶ Reference: Barcode+ (p.277)
- ▶ Reference: 2D Code+ (p.279)
- ▶ Reference: Circle Angle (p.280)

Compensate image

- ▶ Reference: Position Compensation (p.282)
- ▶ Reference: Trapezoidal Correction+ (p.282)
- ▶ Reference: Filtering (p.283)
- ▶ Reference: Background Suppression (p.283)
- ▶ Reference: Color Gray Filter (p.284)
- ▶ Reference: Extract Color Filter (p.285)
- ▶ Reference: Anti Color Shading (p.286)
- ▶ Reference: Stripes Removal Filter+ (p.286)
- ▶ Reference: Halation Cut+ (p.287)
- ▶ Reference: Panorama+ (p.287)
- ▶ Reference: Polar Transformation (p.288)

Support measurement

- ▶ Reference: Calculation (p.289)
- ▶ Reference: Line Regression (p.289)
- ▶ Reference: Circle Regression (p.290)
- ▶ Reference: Calibration+ (p.290)
- ▶ Reference: Set Unit Data (p.291)

- ▶ Reference: Get Unit Data (p.291)
- ▶ Reference: Set Unit Figure (p.291)
- ▶ Reference: Get Unit Figure (p.291)
- ▶ Reference: Trend Monitor (p.292)
- ▶ Reference: Image Logging (p.293)
- ▶ Reference: Data Logging (p.293)
- ▶ Reference: Elapsed Time (p.294)
- ▶ Reference: Wait (p.294)
- ▶ Reference: Focus (p.294)
- ▶ Reference: Iris (p.294)

Branch

- ▶ Reference: Conditional Branch (p.296)
- ▶ Reference: DI Branch (p.296)

Output result

- ▶ Reference: Data Output (p.297)
- ▶ Reference: Parallel Data Output (p.297)
- ▶ Reference: Parallel Judgement Output (p.298)
- ▶ Reference: Fieldbus Data Output (p.299)

Display result

- ▶ Reference: Result Display (p.300)
- ▶ Reference: Display Image File (p.300)
- ▶ Reference: Display Last NG Image (p.300)

Input image

Measurement Image Switching

No.	Data name	Set/Get	Data range
0	Judge	Get only	0: No judgement (unmeasured) 1: Judgement result OK -1: Judgement result NG
120	Target unit	Set/Get	Unit that outputs images subject to reset 0 to 9999

Measurement

Search

No.	Data name	Set/Get	Data range
0	Judge	Get only	0: No judgement (unmeasured) 1: Judgement result OK -1: Judgement result NG
5	Correlation value	Get only	0 to 100
6	Measure X	Get only	-99999.9999 to 99999.9999
7	Measure Y	Get only	-99999.9999 to 99999.9999
8	Measure angle	Get only	-180 to 180
9	Reference X	Get only	-99999.9999 to 99999.9999
10	Reference Y	Get only	-99999.9999 to 99999.9999
11	Reference angle	Get only	-180 to 180
12	Detected coordinate X	Get only	-99999.9999 to 99999.9999
13	Detected coordinate Y	Get only	-99999.9999 to 99999.9999
14	Count	Get only	0 to 32
101	Output Coordinates	Set/Get	0: After scroll 1: Before scroll
102	Calibration	Set/Get	0: OFF 1: ON
103	Reflect to overall judgement	Set/Get	0: ON 1: OFF
120	Search mode	Set/Get	0: Correlation 1: Shape
121	With rotation	Set/Get	0: OFF 1: ON
122	Upper limit of the rotation angle	Set/Get	-180 to 180
123	Lower limit of the rotation angle	Set/Get	-180 to 180
124	Skipping angle	Set/Get	1 to 30
125	Smart mode	Set/Get	0: OFF 1: ON
126	Stab. (CR)	Set/Get	1 to 15
127	Prec.	Set/Get	1 to 3
128	Stab. (PT)	Set/Get	1 to 5
129	Reference X	Set/Get	0 to 99999.9999
130	Reference Y	Set/Get	0 to 99999.9999
132	Detection point X	Set/Get	0 to 99999.9999
133	Detection point Y	Set/Get	0 to 99999.9999
134	Sub-pixel	Set/Get	0: OFF 1: ON
135	Candidate Point Level	Set/Get	0 to 100
136	Upper limit of measure X	Set/Get	-99999.9999 to 99999.9999
137	Lower limit of measure X	Set/Get	-99999.9999 to 99999.9999
138	Upper limit of measure Y	Set/Get	-99999.9999 to 99999.9999

139	Lower limit of measure Y	Set/Get	-99999.9999 to 99999.9999
140	Upper limit of the angle	Set/Get	-180 to 180
141	Lower limit of the angle	Set/Get	-180 to 180
142	Upper limit of the corr.	Set/Get	0 to 100
143	Lower limit of the corr.	Set/Get	0 to 100
144	Save registered model	Set/Get	0: OFF 1: ON
145	Candidate Point Level	Set/Get	0 to 100
146	Sort condition	Set/Get	0: Corr. ascending 1: Corr. descending 2: X ascending 3: X descending 4: Y ascending 5: Y descending
147	Search No.	Set/Get	0 to 31
148	Upper limit of count judgement	Set/Get	0 to 32
149	Lower limit of count judgement	Set/Get	0 to 32
150	Multiple output	Set/Get	0: OFF 1: ON
1000 + NN x 4 (NN = 0 to 31)	Correlation value	Get only	0 to 100
1001 + NN x 4 (NN = 0 to 31)	Measure X	Get only	-99999.9999 to 99999.9999
1002 + NN x 4 (NN = 0 to 31)	Measure Y	Get only	-99999.9999 to 99999.9999
1003 + NN x 4 (NN = 0 to 31)	Measure angle	Get only	-180 to 180

Flexible Search

No.	Data name	Set/Get	Data range
0	Judge	Get only	0: No judgement (unmeasured) 1: Judgement result OK -1: Judgement result NG
5	Model No.	Get only	0 to 4 -1: No models found
6	Correlation value	Get only	0 to 100
7	Measure X	Get only	-99999.9999 to 99999.9999
8	Measure Y	Get only	-99999.9999 to 99999.9999
9	Measure angle	Get only	-180 to 180
10	Reference X	Get only	-99999.9999 to 99999.9999
11	Reference Y	Get only	-99999.9999 to 99999.9999
12	Reference angle	Get only	-180 to 180
13	Detection point X	Get only	-99999.9999 to 99999.9999
14	Detection point Y	Get only	-99999.9999 to 99999.9999
101	Output Coordinates	Set/Get	0: After scroll 1: Before scroll
102	Calibration	Set/Get	0: OFF, 1: ON

103	Reflect to overall judgement	Set/Get	0: ON, 1: OFF
120	Search mode	Set/Get	0: Correlation 1: Shape
121	With rotation	Set/Get	0: OFF 1: ON
122	Upper limit of the rotation angle	Set/Get	-180 to 180
123	Lower limit of the rotation angle	Set/Get	-180 to 180
124	Skipping angle	Set/Get	1 to 30
125	Smart mode	Set/Get	0: OFF 1: ON
126	Stab. (CR)	Set/Get	1 to 15
127	Prec.	Set/Get	1 to 3
128	Stab. (PT)	Set/Get	1 to 5
134	Sub-pixel	Set/Get	0: OFF 1: ON
135	Candidate Point Level	Set/Get	0 to 100
136	Upper limit of measure X	Set/Get	-99999.9999 to 99999.9999
137	Lower limit of measure X	Set/Get	-99999.9999 to 99999.9999
138	Upper limit of measure Y	Set/Get	-99999.9999 to 99999.9999
139	Lower limit of measure Y	Set/Get	-99999.9999 to 99999.9999
140	Upper limit of the angle	Set/Get	-180 to 180
141	Lower limit of the angle	Set/Get	-180 to 180
142	Upper limit of the corr.	Set/Get	0 to 100
143	Lower limit of the corr.	Set/Get	0 to 100

Sensitive Search

No.	Data name	Set/Get	Data range
0	Judge	Get only	0: No judgement (unmeasured) 1: Judgement result OK -1: Judgement result NG
1	Correlation value	Get only	0 to 100
2	Deviation	Get only	For color cameras: 0.000 to 219.9705 For monochrome cameras: 0.000 to 127.000
3	Measure X	Get only	-99999.9999 to 99999.9999
4	Measure Y	Get only	-99999.9999 to 99999.9999
5	Measure angle	Get only	-180 to 180
6	Detection point X	Get only	-99999.9999 to 99999.9999
7	Detection point Y	Get only	-99999.9999 to 99999.9999
8	Reference X	Get only	-99999.9999 to 99999.9999
9	Reference Y	Get only	-99999.9999 to 99999.9999
10	Reference angle	Get only	-180 to 180
11	NG Sub-region	Get only	0 to 100
12	Sub-region Number	Get only	0 to 99
13	Sub-region Number(X)	Get only	0 to 9

14	Sub-region Number(Y)	Get only	0 to 9
15	Sub-region Pos. X	Get only	-99999.9999 to 99999.9999
16	Sub-region Pos. Y	Get only	-99999.9999 to 99999.9999
101	Output Coordinates	Set/Get	0: After scroll 1: Before scroll
102	Calibration	Set/Get	0: OFF 1: ON
103	Reflect to overall judgement	Set/Get	0: ON 1: OFF
121	With rotation	Set/Get	0: OFF 1: ON
122	Upper limit of the rotation angle	Set/Get	-180 to 180
123	Lower limit of the rotation angle	Set/Get	-180 to 180
124	Skipping angle	Set/Get	1 to 30
125	Smart mode	Set/Get	0: OFF 1: ON
126	Stab.	Set/Get	1 to 15
127	Prec.	Set/Get	1 to 3
129	Reference X	Set/Get	0 to 9999
130	Reference Y	Set/Get	0 to 9999
132	Detection point X	Set/Get	0 to 9999
133	Detection point Y	Set/Get	0 to 9999
134	Sub-pixel	Set/Get	0: OFF 1: ON
135	Candidate Point Level	Set/Get	0 to 100
136	Upper limit of measure X	Set/Get	-99999.9999 to 99999.9999
137	Lower limit of measure X	Set/Get	-99999.9999 to 99999.9999
138	Upper limit of measure Y	Set/Get	-99999.9999 to 99999.9999
139	Lower limit of measure Y	Set/Get	-99999.9999 to 99999.9999
140	Upper limit of the angle	Set/Get	-180 to 180
141	Lower limit of the angle	Set/Get	-180 to 180
142	Upper limit of the corr.	Set/Get	0 to 100
143	Lower limit of the corr.	Set/Get	0 to 100
144	Save registered model	Set/Get	0: OFF 1: ON
145	Upper limit of deviation	Set/Get	For color cameras: 0 to 221 For monochrome cameras: 0 to 127
146	Lower limit of deviation	Set/Get	For color cameras: 0 to 221 For monochrome cameras: 0 to 127
147	Upper limit of NG Sub-region	Set/Get	0 to 100
148	Lower limit of NG Sub-region	Set/Get	0 to 100
149	Sub-region stab.	Set/Get	1 to 15
150	Sub-region prec.	Set/Get	1 to 3
151	Sub-model number X	Set/Get	1 to 10
152	Sub-model number Y	Set/Get	1 to 10
153	Plain inspection	Set/Get	0: OFF 1: ON

154	NG Sub-region (155,156 setting/ acquisition target)	Set/Get	0 to 99
155	Enabled/disabled of sub-region	Set/Get	0: Disabled 1: Enabled
156	Measurement type of sub-region	Set/Get	0: Search 1: ColorData -1: No processing item
157	Display cursor (position)	Set/Get	0: OFF 1: ON
158	Display cursor (Sub-region Pos.)	Set/Get	0: OFF 1: ON
159	Sub-region margin	Set/Get	0 to 10
165	Disabled region retention flag	Set/Get	0: Not retained 1 : Retained
1000 + N (N = 0 to 99)	Correlation value of sub-region	Get only	0 to 100
1100 + N (N = 0 to 99)	Deviation of sub-region	Get only	For color cameras: 0.000 to 219.9705 For monochrome cameras: 0.000 to 127.000

ECM Search

No.	Data name	Set/Get	Data range
0	Judge	Get only	0: No judgement (unmeasured) 1: Judgement result OK -1: Judgement result NG
5	Correlation value	Get only	0 to 100
6	Measure X	Get only	-99999.9999 to 99999.9999
7	Measure Y	Get only	-99999.9999 to 99999.9999
8	Angle θ	Get only	-180 to 180
9	Magnification X	Get only	50 to 150
10	Magnification Y	Get only	50 to 150
11	Reference X	Get only	-99999.9999 to 9999.9999
12	Reference Y	Get only	-99999.9999 to 9999.9999
13	Reference angle	Get only	-180 to 180
14	Detection point X	Get only	-99999.9999 to 9999.9999
15	Detection point Y	Get only	-99999.9999 to 9999.9999
101	Output Coordinates	Set/Get	0: After scroll 1: Before scroll
102	Calibration	Set/Get	0: OFF 1: ON
103	Reflect to overall judgement	Set/Get	0: ON 1: OFF
120	Mask size	Set/Get	0: 3 x 3 1: 5 x 5 2: 7 x 7 3: 9 x 9
121	Edge Level	Set/Get	0 to 255

122	Detection point X	Set/Get	-99999.9999 to 9999.9999
123	Detection point Y	Set/Get	-99999.9999 to 9999.9999
124	Reference X	Set/Get	0 to 99999.9999
125	Reference Y	Set/Get	0 to 99999.9999
126	Upper limit of the corr.	Set/Get	0 to 100
127	Lower limit of the corr.	Set/Get	0 to 100
128	Upper limit of measure X	Set/Get	-99999.9999 to 99999.9999
129	Lower limit of measure X	Set/Get	-99999.9999 to 99999.9999
130	Upper limit of measure Y	Set/Get	-99999.9999 to 99999.9999
131	Lower limit of measure Y	Set/Get	-99999.9999 to 99999.9999
132	Upper limit of the angle	Set/Get	-180 to 180
133	Lower limit of the angle	Set/Get	-180 to 180
134	Candidate Point Level	Set/Get	0 to 99
135	Model skipping	Set/Get	1 to 9
136	Region skipping	Set/Get	1 to 19
137	Reduction	Set/Get	10 to 100
138	With rotation	Set/Get	0: No rotation 1: With rotation
139	Lower limit of the rotation angle	Set/Get	-180 to 180
140	Upper limit of the rotation angle	Set/Get	-180 to 180
141	Skipping angle	Set/Get	1 to 30
142	Move axis	Set/Get	0: No size change 1: XY change 2: X change 3: Y change
143	Upper limit of the size change	Set/Get	50 to 150
144	Lower limit of the size change	Set/Get	50 to 150
145	Size change skipping	Set/Get	1 to 99
146	Reverse	Set/Get	0: No reverse 1: Reverse

EC Circle Search

No.	Data name	Set/Get	Data range
0	Judge	Get only	0: No judgement (unmeasured) 1: Judgement result OK -1: Judgement result NG
5	Position X	Get only	-99999.9999 to 99999.9999
6	Position Y	Get only	-99999.9999 to 99999.9999
8	Reference coordinate X	Get only	-99999.9999 to 99999.9999
9	Reference coordinate Y	Get only	-99999.9999 to 99999.9999
15	Evaluation	Get only	0 to 100
18	Radius	Get only	0 to 99999.9999
19	Count	Get only	0 to 256
101	Output Coordinates	Set/Get	0: After scroll 1: Before scroll

102	Calibration	Set/Get	0: OFF 1:ON
140	Reference X	Set/Get	0 to 9999
141	Reference Y	Set/Get	0 to 9999
142	Target	Set/Get	0: Black 1 : White 2: Black and white
143	Edge color specification	Set/Get	0: Yes 1: No
144	Circle color R	Set/Get	0 to 255
145	Circle color G	Set/Get	0 to 255
146	Circle color B	Set/Get	0 to 255
147	Background color R	Set/Get	0 to 255
148	Background color G	Set/Get	0 to 255
149	Background color B	Set/Get	0 to 255
150	Mask size	Set/Get	0: 3 x 3 1: 5 x 5 2: 7 x 7 3: 9 x 9
151	Edge extraction level	Set/Get	0 to 255
153	Upper limit of position X	Set/Get	-99999.9999 to 99999.9999
154	Lower limit of position X	Set/Get	-99999.9999 to 99999.9999
155	Upper limit of position Y	Set/Get	-99999.9999 to 99999.9999
156	Lower limit of position Y	Set/Get	-99999.9999 to 99999.9999
159	Upper limit of evaluation	Set/Get	0 to 100
160	Lower limit of evaluation	Set/Get	0 to 100
161	Upper limit of count	Set/Get	0 to 256
162	Lower limit of count	Set/Get	0 to 256
165	Upper limit of radius	Set/Get	0 to 99999.9999
166	Lower limit of radius	Set/Get	0 to 99999.9999
171	Search type	Set/Get	0: Single search 1: Multi search
172	Candidate Point Level	Set/Get	0 to 100
173	Sort condition	Set/Get	0: X ascending 1: X descending 2: Y ascending 3: Y descending 4: Eva. ascending 5: Eva. descending 6: Radius ascending 7: Radius descending
176	Grouping distance	Set/Get	1 to 10
177	Radius range	Set/Get	1 to 9999
178	Radius	Set/Get	1 to 9999
1000 + N x 4 (N = 0 to 255)	Position X	Get only	-99999.9999 to 99999.9999
1001 + N x 4 (N = 0 to 255)	Position Y	Get only	-99999.9999 to 99999.9999
1002 + N x 4 (N = 0 to 255)	Evaluation	Get only	0 to 100

1003 + N x 4 (N = 0 to 255)	Radius	Get only	0 to 99999.9999
--------------------------------	--------	----------	-----------------

Shape Search+

No.	Data name	Set/Get	Data range
0	Judge	Get only	0: No judgement (unmeasured) 1: Judgement result OK -1: Judgement result NG
5	Correlation value	Get only	0 to 100
6	Measure X	Get only	-99999.9999 to 99999.9999
7	Measure Y	Get only	-99999.9999 to 99999.9999
8	Measure angle	Get only	-180 to 180
9	Reference X	Get only	-99999.9999 to 99999.9999
10	Reference Y	Get only	-99999.9999 to 99999.9999
11	Reference angle	Get only	-180 to 180
12	Detected coordinate X	Get only	-99999.9999 to 99999.9999
13	Detected coordinate Y	Get only	-99999.9999 to 99999.9999
14	Count	Get only	0 to 100
15	Magnification X	Get only	Magnification X of search results designated by [Search No.]
16	Magnification Y	Get only	Magnification Y of search results designated by [Search No.]
17	Correlation value array	Get only	Correlation value of search results designated by [Label No. for external reference]
18	Position X arrangement	Get only	Position X of search results designated by [Label No. for external reference]
19	Position Y arrangement	Get only	Position Y of search results designated by [Label No. for external reference]
20	Measure angle arrangement	Get only	Measure angle of search results designated by [Label No. for external reference]
21	Magnification X arrangement	Get only	Magnification X of search results designated by [Search No. for external reference]
22	Magnification Y arrangement	Get only	Magnification Y of search results designated by [Search No. for external reference]
101	Output Coordinates	Set/Get	0: After scroll 1: Before scroll
102	Calibration	Set/Get	0: OFF 1: ON
103	Reflect to overall judgement	Set/Get	0: ON 1: OFF
120	Upper limit of the rotation angle	Set/Get	-180 to 180
121	Lower limit of the rotation angle	Set/Get	-180 to 180
130	Scaling	Set/Get	0: OFF 1: XY 2: X 3: Y

131	Upper limit of the scale	Set/Get	100 to 110
132	Lower limit of the scale	Set/Get	90 to 100
140	Reverse	Set/Get	0: Reverse 1: No reverse
150	Detection point X	Set/Get	-99999.9999 to 99999.9999
151	Detection point Y	Set/Get	-99999.9999 to 99999.9999
152	Reference X	Set/Get	-99999.9999 to 99999.9999
153	Reference Y	Set/Get	-99999.9999 to 99999.9999
160	Candidate Point Level	Set/Get	0 to 100
161	Label No.	Set/Get	0 to 99
162	Label No. for external reference	Set/Get	0 to 99
170	Count	Set/Get	0 to 100
171	Sub-pixel detection method	Set/Get	0: Fast 1: Normal 2: Fine
172	Succession level	Set/Get	0 to 100
173	Search level	Set/Get	0: Automatic 1: Manual
174	Upper limit of search level	Set/Get	2 to 5
176	Sort condition	Set/Get	0 to 5
180	Judgement upper limit for number of detections	Set/Get	0 to 100
181	Judgement lower limit of number of detections	Set/Get	0 to 100
182	Judgement upper limit of measure X	Set/Get	-99999.9999 to 99999.9999
183	Judgement lower limit of measure X	Set/Get	-99999.9999 to 99999.9999
184	Judgement upper limit of measure Y	Set/Get	-99999.9999 to 99999.9999
185	Judgement lower limit of measure Y	Set/Get	-99999.9999 to 99999.9999
186	Judgement upper limit for angle	Set/Get	-180 to 180
187	Judgement lower limit for angle	Set/Get	-180 to 180
188	Judgement upper limit for correlation value	Set/Get	0 to 100
189	Judgement lower limit for correlation value	Set/Get	0 to 100
1000 + N x 6 (N = 0 to 99)	Correlation 0 to 99	Get	0 to 100
1000 + N x 6 + 1 (N = 0 to 99)	Position X 0 to 99	Get	-99999.9999 to 99999.9999
1000 + N x 6 + 2 (N = 0 to 99)	Position Y 0 to 99	Get	-99999.9999 to 99999.9999
1000 + N x 6 + 3 (N = 0 to 99)	Measurement angle 0 to 99	Get	-180 to 180
1000 + N x 6 + 4 (N = 0 to 99)	Magnification MX 0 to 99	Get	90 to 110
1000 + N x 6 + 5 (N = 0 to 99)	Magnification MY 0 to 99	Get	90 to 110

Classification

No.	Data name	Set/Get	Data range
0	Judge	Get only	0: No judgement (unmeasured) 1: Judgement result OK -1: Judgement result NG
5	Index	Get only	-1: No models found 0 to 35
6	Model No.	Get only	-1: No models found 0 to 4
7	Correlation value	Get only	0 to 100
8	Measure X	Get only	-99999.9999 to 99999.9999
9	Measure Y	Get only	-99999.9999 to 99999.9999
10	Angle θ	Get only	-180 to 180
11	Reference X	Get only	-99999.9999 to 99999.9999
12	Reference Y	Get only	-99999.9999 to 99999.9999
13	Reference angle	Get only	-180 to 180
14	Detected coordinate X	Get only	-99999.9999 to 99999.9999
15	Detected coordinate Y	Get only	-99999.9999 to 99999.9999
101	Output Coordinates	Set/Get	0: After scroll 1: Before scroll
102	Calibration	Set/Get	0: OFF, 1: ON
103	Reflect to overall judgement	Set/Get	0: ON, 1: OFF
120	Search mode	Set/Get	0: Correlation 1: Shape
121	With rotation	Set/Get	0: OFF 1: ON
122	Upper limit of the rotation angle	Set/Get	-180 to 180
123	Lower limit of the rotation angle	Set/Get	-180 to 180
124	Skipping angle	Set/Get	1 to 30
125	Smart mode	Set/Get	0: OFF 1: ON
126	Stab. (CR)	Set/Get	1 to 15
127	Prec.	Set/Get	1 to 3
128	Stab. (PT)	Set/Get	1 to 5
129	Reference X	Set/Get	0 to 99999.9999
130	Reference Y	Set/Get	0 to 99999.9999
132	Detection point X	Set/Get	0 to 99999.9999
133	Detection point Y	Set/Get	0 to 99999.9999
134	Sub-pixel	Set/Get	0: OFF 1: ON
135	Candidate Point Level	Set/Get	0 to 100
136	Upper limit of measure X	Set/Get	-99999.9999 to 99999.9999
137	Lower limit of measure X	Set/Get	-99999.9999 to 99999.9999
138	Upper limit of measure Y	Set/Get	-99999.9999 to 99999.9999
139	Lower limit of measure Y	Set/Get	-99999.9999 to 99999.9999

140	Upper limit of the angle	Set/Get	-180 to 180
141	Lower limit of the angle	Set/Get	-180 to 180
142	Upper limit of the corr.	Set/Get	0 to 100
143	Lower limit of the corr.	Set/Get	0 to 100

Edge Position

No.	Data name	Set/Get	Data range
0	Judge	Get only	0: No judgement (unmeasured) 1: Judgement result OK -1: Judgement result NG
5	Edge position X	Get only	0 to 99999.9999
6	Edge position Y	Get only	0 to 99999.9999
7	Reference X	Get only	0 to 99999.9999
8	Reference Y	Get only	0 to 99999.9999
101	Output Coordinates	Set/Get	0: After scroll 1: Before scroll
102	Calibration	Set/Get	0: OFF, 1: ON
103	Reflect to overall judgement	Set/Get	0: ON, 1: OFF
120	Edge color specification	Set/Get	0: OFF 1: ON
121	Edge color R	Set/Get	0 to 255
122	Edge color G	Set/Get	0 to 255
123	Edge color B	Set/Get	0 to 255
124	Difference R	Set/Get	0 to 127
125	Difference G	Set/Get	0 to 127
126	Difference B	Set/Get	0 to 127
127	Edge detection mode	Set/Get	0: Color IN 1: Color OUT
129	Reference X	Set/Get	0 to 99999.9999
130	Reference Y	Set/Get	0 to 99999.9999
131	Edge No.	Set/Get	0 to 99
132	Edge Level	Set/Get	0 to 100
133	Noise Level	Set/Get	0 to 442
134	Noise width	Set/Get	0 to 9999
135	Edge color level	Set/Get	0 to 442
136	Upper limit of the edge position X	Set/Get	-99999.9999 to 99999.9999
137	Lower limit of the edge position X	Set/Get	-99999.9999 to 99999.9999
138	Upper limit of the edge position Y	Set/Get	-99999.9999 to 99999.9999
139	Lower limit of the edge position Y	Set/Get	-99999.9999 to 99999.9999
140	Monochrome edge detection mode	Set/Get	0: Light → Dark 1: Dark → Light
141	Edge level absolute value	Set/Get	0 to 442
142	Edge level specification method	Set/Get	0: %, 1: Absolute value
143	Clockwise/Counterclockwise	Set/Get	0: Clockwise, 1: Counterclockwise
144	Measure type	Set/Get	0: Projection, 1: Derivation

Edge Pitch

No.	Data name	Set/Get	Data range
0	Judge	Get only	0: No judgement (unmeasured) 1: Judgement result OK -1: Judgement result NG
5	Number of Edge Pins	Get only	0 to 999
6	Average pitch	Get only	0 to 99999.9999
7	Max. pitch	Get only	0 to 99999.9999
8	Min. pitch	Get only	0 to 99999.9999
9	Average width	Get only	0 to 99999.9999
10	Max. width	Get only	0 to 99999.9999
11	Min. width	Get only	0 to 99999.9999
101	Output Coordinates	Set/Get	0: After scroll 1: Before scroll
102	Calibration	Set/Get	0: OFF, 1: ON
103	Reflect to overall judgement	Set/Get	0: ON, 1: OFF
120	Edge color R	Set/Get	0 to 255
121	Edge color G	Set/Get	0 to 255
122	Edge color B	Set/Get	0 to 255
123	Edge color difference R	Set/Get	0 to 127
124	Edge color difference G	Set/Get	0 to 127
125	Edge color difference B	Set/Get	0 to 127
127	Edge Level	Set/Get	0 to 100
128	Noise Level	Set/Get	0 to 442
129	Noise width	Set/Get	0 to 9999
130	Upper limit of edge pitch	Set/Get	0 to 1000
131	Lower limit of edge pitch	Set/Get	0 to 1000
132	Upper limit of average pitch	Set/Get	0 to 99999.9999
133	Lower limit of average pitch	Set/Get	0 to 99999.9999
134	Upper limit of the pitch	Set/Get	0 to 99999.9999
135	Lower limit of the pitch	Set/Get	0 to 99999.9999
136	Upper limit of average width	Set/Get	0 to 99999.9999
137	Lower limit of Average width	Set/Get	0 to 99999.9999
138	Upper limit of the width	Set/Get	0 to 99999.9999
139	Lower limit of the width	Set/Get	0 to 99999.9999
140	Edge color level	Set/Get	0 to 442
141	Color to count	Set/Get	0: White, 1: Black
142	Mode	Set/Get	0: Normal, 1: Precise

Scan Edge Position

No.	Data name	Set/Get	Data range
0	Judge	Get only	0: No judgement (unmeasured) 1: Judgement result OK -1: Judgement result NG
1	Peak edge position X	Get only	0 to 99999.9999
2	Peak edge position Y	Get only	0 to 99999.9999
3	Bottom edge position X	Get only	0 to 99999.9999
4	Bottom edge position Y	Get only	0 to 99999.9999
5	Edge position X Ave.	Get only	-1 to 99999.9999
6	Edge position Y Ave.	Get only	-1 to 99999.9999
7	Long distance Max.	Get only	-1 to dist (X_MAX, Y_MAX)
8	Long distance Min.	Get only	-1 to dist (X_MAX, Y_MAX)
9	Short distance Max.	Get only	-1 to dist (X_MAX, Y_MAX)
10	Short distance Min.	Get only	-1 to dist (X_MAX, Y_MAX)
11	Deviation	Get only	-1 to dist (X_MAX, Y_MAX)
12	Angle	Get only	-180 to 180
13	Lost point	Get only	0 to 100
14	Linear coefficient A	Get only	-99999.9999 to 99999.9999
15	Linear coefficient B	Get only	-99999.9999 to 99999.9999
16	Linear coefficient C	Get only	-99999.9999 to 99999.9999
17	Reference X	Get only	0 to 99999.9999
18	Reference Y	Get only	0 to 99999.9999
101	Output Coordinates	Set/Get	0: After scroll 1: Before scroll
102	Calibration	Set/Get	0: OFF 1: ON
103	Reflect to overall judgement	Set/Get	0: ON 1: OFF
120	Edge color specification	Set/Get	0: OFF 1: ON
121	Edge color R	Set/Get	0 to 255
122	Edge color G	Set/Get	0 to 255
123	Edge color B	Set/Get	0 to 255
124	Difference R	Set/Get	0 to 127
125	Difference G	Set/Get	0 to 127
126	Difference B	Set/Get	0 to 127
127	Detection mode	Set/Get	0: Color IN 1: Color OUT
129	Reference X	Set/Get	0 to 99999.9999
130	Reference Y	Set/Get	0 to 99999.9999
131	Edge No.	Set/Get	0 to 99
132	Edge Level	Set/Get	0 to 100
133	Noise Level	Set/Get	0 to 442
134	Noise width	Set/Get	0 to 9999
135	Edge color level	Set/Get	0 to 442
136	Upper limit of the maximum edge position X	Set/Get	-99999.9999 to 99999.9999

137	Lower limit of the maximum edge position X	Set/Get	-99999.9999 to 99999.9999
138	Upper limit of the maximum edge position Y	Set/Get	-99999.9999 to 99999.9999
139	Lower limit of the maximum edge position Y	Set/Get	-99999.9999 to 99999.9999
140	Upper limit of the minimum edge position X	Set/Get	-99999.9999 to 99999.9999
141	Lower limit of the minimum edge position X	Set/Get	-99999.9999 to 99999.9999
142	Upper limit of the minimum edge position Y	Set/Get	-99999.9999 to 99999.9999
143	Lower limit of the minimum edge position Y	Set/Get	-99999.9999 to 99999.9999
144	Upper limit of the edge position X Ave.	Set/Get	-99999.9999 to 99999.9999
145	Lower limit of the edge position X Ave.	Set/Get	-99999.9999 to 99999.9999
146	Upper limit of the edge position Y Ave.	Set/Get	-99999.9999 to 99999.9999
147	Lower limit of the edge position Y Ave.	Set/Get	-99999.9999 to 99999.9999
148	Upper limit of the long distance Max.	Set/Get	0 to dist (X_MAX, Y_MAX)
149	Lower limit of the long distance Max.	Set/Get	0 to dist (X_MAX, Y_MAX)
150	Upper limit of the short distance Max.	Set/Get	0 to dist (X_MAX, Y_MAX)
151	Lower limit of the short distance Max.	Set/Get	0 to dist (X_MAX, Y_MAX)
152	Upper limit of the deviation	Set/Get	0 to dist (X_MAX, Y_MAX)
153	Lower limit of the deviation	Set/Get	0 to dist (X_MAX, Y_MAX)
154	Upper limit of the angle	Set/Get	-180 to 180
155	Lower limit of the angle	Set/Get	-180 to 180
156	Upper limit of the lost point	Set/Get	0 to 100
157	Lower limit of the lost point	Set/Get	0 to 100
158	Monochrome edge detection mode	Set/Get	0: Light → Dark 1: Dark → Light
159	Edge level absolute value	Set/Get	0 to 442
160	Edge level specification method	Set/Get	0: % 1: Absolute value
162	Scan lines	Set/Get	1 to 100
163	Scan width	Set/Get	1 to 200
164	Display area	Set/Get	0 to 99
165	Noise cancel	Set/Get	0: OFF 1: ON
166	Measure type	Set/Get	0: Projection, 1: Derivation
167	Area division method	Set/Get	0: Do not fix number of area divisions 1: Fix the number of area divisions

* dist (X_MAX, Y_MAX) = sqrt (X_MAX*X_MAX+Y_MAX*Y_MAX)

Scan Edge Width

No.	Data name	Set/Get	Data range
0	Judge	Get only	0: No judgement (unmeasured) 1: Judgement result OK -1: Judgement result NG
1	Edge width Max.	Get only	0 to dist (X_MAX, Y_MAX)
2	Edge width Min.	Get only	0 to dist (X_MAX, Y_MAX)
3	Edge width Ave.	Get only	0 to dist (X_MAX, Y_MAX)
4	Lostwidth	Get only	0 to 100

101	Output Coordinates	Set/Get	0: After scroll 1: Before scroll
102	Calibration	Set/Get	0: OFF, 1: ON
103	Reflect to overall judgement	Set/Get	0: ON, 1: OFF
120	Edge color specification	Set/Get	0: OFF, 1: ON
121	Edge color R	Set/Get	0 to 255
122	Edge color G	Set/Get	0 to 255
123	Edge color B	Set/Get	0 to 255
124	Difference R	Set/Get	0 to 127
125	Difference G	Set/Get	0 to 127
126	Difference B	Set/Get	0 to 127
127	Detection mode	Set/Get	0: Color IN, 1: Color OUT
129	Edge Level	Set/Get	0 to 100
130	Noise Level	Set/Get	0 to 442
131	Noise width	Set/Get	0 to 9999
132	Edge color level	Set/Get	0 to 442
133	Upper limit of the Max. width	Set/Get	0 to dist (X_MAX, Y_MAX)
134	Lower limit of the Max. width	Set/Get	0 to dist (X_MAX, Y_MAX)
135	Upper limit of the Min.width	Set/Get	0 to dist (X_MAX, Y_MAX)
136	Lower limit of the Min.width	Set/Get	0 to dist (X_MAX, Y_MAX)
137	Upper limit of the average width	Set/Get	0 to dist (X_MAX, Y_MAX)
138	Lower limit of the average width	Set/Get	0 to dist (X_MAX, Y_MAX)
139	Upper limit of the lostwidth	Set/Get	0 to 100
140	Lower limit of the lostwidth	Set/Get	0 to 100
141	Monochrome edge detection mode	Set/Get	0: Light → dark, 1: Dark → light
142	Edge level absolute value	Set/Get	0 to 442
143	Edge level specification method	Set/Get	0: %, 1: Absolute value
145	Scan lines	Set/Get	1 to 100
146	Scan width	Set/Get	1 to 200
147	Display area	Set/Get	1 to 99
148	Display area (direction)	Set/Get	0: Forward, 1: Reverse
149	Measure type	Set/Get	0: Projection, 1: Derivation
150	Area division method	Set/Get	0: Do not fix number of area divisions 1: Fix the number of area divisions

* dist (X_MAX,Y_MAX) = sqrt (X_MAX*X_MAX+Y_MAX*Y_MAX)

Color Data

No.	Data name	Set/Get	Data range
0	Judge	Get only	0: No judgement (unmeasured) 1: Judgement result OK -1: Judgement result NG
5	Average R component value	Get only	0 to 255
6	Average G component value	Get only	0 to 255

7	Average B component value	Get only	0 to 255
8	Color difference	Get only	0 to 442
9	Color deviation	Get only	0 to 219.9705
10	Density average (for monochrome cameras only)	Get only	0.000 to 255.000
11	Density deviation value (for monochrome cameras only)	Get only	0.000 to 127.000
12	Reference average value	Get only	0.000 to 255.000
13	Reference deviation value	Get only	0.000 to 127.000
103	Reflect to overall judgement	Set/Get	0: ON 1: OFF
120	Normalization	Set/Get	0: OFF 1: ON
121	Reference color R	Set/Get	0 to 255
122	Reference color G	Set/Get	0 to 255
123	Reference color B	Set/Get	0 to 255
124	Upper limit for color difference	Set/Get	0 to 442
125	Lower limit for color difference	Set/Get	0 to 442
126	Upper limit for color deviation	Set/Get	0 to 221
127	Lower limit for color deviation	Set/Get	0 to 221
128	Reference density average	Set/Get	0 to 255
129	Reference density deviation	Set/Get	0 to 127
130	Upper limit for density average (for monochrome cameras only)	Set/Get	0 to 255
131	Lower limit for density average (for monochrome cameras only)	Set/Get	0 to 255
132	Upper limit for density deviation (for monochrome cameras only)	Set/Get	0 to 127
133	Lower limit for density deviation (for monochrome cameras only)	Set/Get	0 to 127

Gravity and Area

No.	Data name	Set/Get	Data range
0	Judge	Get only	0: No judgement (unmeasured) 1: Judgement result OK -1: Judgement result NG
5	Area	Get only	0 to 999999999.9999
6	Gravity X	Get only	-99999.9999 to 99999.9999
7	Gravity Y	Get only	-99999.9999 to 99999.9999
8	Reference area	Get only	0 to 999999999
9	Reference X	Get only	-99999.9999 to 99999.9999
10	Reference Y	Get only	-99999.9999 to 99999.9999
101	Output Coordinates	Set/Get	0: After scroll 1: Before scroll
102	Calibration	Set/Get	0: OFF, 1: ON
103	Reflect to overall judgement	Set/Get	0: ON, 1: OFF

120	Register the max. color hue	Set/Get	0 to 359
121	Register the min. color hue	Set/Get	0 to 359
122	Register the max. color saturation	Set/Get	0 to 255
123	Register the min. color saturation	Set/Get	0 to 255
124	Register the max. color brightness	Set/Get	0 to 255
125	Register the min. color brightness	Set/Get	0 to 255
126	Extract image	Set/Get	0: OFF, 1: ON
127	Background color	Set/Get	0: Black, 1: White, 2: Red, 3: Green, 4: Blue
128	Fill profile	Set/Get	0: OFF, 1: Fill profile, 2: Filling up holes
129	Color inv. (reverse for monochrome)	Set/Get	0: OFF, 1: ON
132	Reference area	Set/Get	0 to 999999999.9999
133	Reference X	Set/Get	0 to 99999
134	Reference Y	Set/Get	0 to 99999
135	Upper limit of the area	Set/Get	0 to 999999999.9999
136	Lower limit of the area	Set/Get	0 to 999999999.9999
137	Upper limit of gravity X	Set/Get	-99999.9999 to 99999.9999
138	Lower limit of gravity X	Set/Get	-99999.9999 to 99999.9999
139	Upper limit of gravity Y	Set/Get	-99999.9999 to 99999.9999
140	Lower limit of gravity Y	Set/Get	-99999.9999 to 99999.9999
141	Upper limit of the binary level	Set/Get	0 to 255
142	Lower limit of the binary level	Set/Get	0 to 255
143	Binary image	Set/Get	0: ON 1: OFF
144	Image kind	Set/Get	0: Measurement image 1: All color image 2: Selection color image 3: Binary image
145	Multiple selections	Set/Get	0: Multiple selections disabled 1: Multiple selections enabled
160 + N x 10	Flag N used for registered color	Set/Get	0: Not used 1 : Used
161 + N x 10	Flag N for registered color OR/NOT	Set/Get	0: OR 1: NOT
162 + N x 10	Register the max. color hue N	Set/Get	0 to 359
163 + N x 10	Register the min. color hue N	Set/Get	0 to 359
164 + N x 10	Register the max. color saturation N	Set/Get	0 to 255
165 + N x 10	Register the min. color saturation N	Set/Get	0 to 255
166 + N x 10	Register the max. color brightness N	Set/Get	0 to 255
167 + N x 10	Register the min. color brightness N	Set/Get	0 to 255
168 + N x 10	Background color N	Set/Get	0: Black 1 : White 2: Red 3: Green 4: Blue

Labeling

No.	Data name	Set/Get	Data range
0	Judge	Get	0: No judgement (unmeasured) 1: Judgement result OK -1: Judgement result NG
5	Number of labels	Get	0 to 2500
6	Area	Get	0 to 999999999.9999
7	Gravity X	Get	-99999.9999 to 99999.9999
8	Gravity Y	Get	-99999.9999 to 99999.9999
9	Reference area	Get	0 to 999999999
10	Reference X	Get	-99999.9999 to 99999.9999
11	Reference Y	Get	-99999.9999 to 99999.9999
101	Output coordinates	Set/Get	0: After scroll 1: Before scroll
102	Calibration	Set/Get	0: OFF, 1: ON
103	Reflect to overall judgement	Set/Get	0: ON, 1: OFF
120	Max. color difference	Set/Get	0 to 359
121	Min. color difference	Set/Get	0 to 359
122	Max. saturation	Set/Get	0 to 255
123	Min. saturation	Set/Get	0 to 255
124	Max. brightness	Set/Get	0 to 255
125	Min. brightness	Set/Get	0 to 255
126	Extract image	Set/Get	0: OFF, 1: ON
127	Background color	Set/Get	0: Black 1: White 2: Red 3: Green 4: Blue
128	Reference area	Set/Get	0 to 999999999
129	Reference X	Set/Get	0 to 99999
130	Reference Y	Set/Get	0 to 99999
131	Color inv. (reverse for monochrome)	Set/Get	0: OFF 1: ON
132	Filling up holes	Set/Get	0: OFF 1: ON
133	Outside trimming	Set/Get	0: OFF 1: ON
134	Upper limit of the object area range	Set/Get	0 to 999999999.9999
135	Lower limit of the object area range	Set/Get	0 to 999999999.9999
136	Sort condition	Set/Get	0: Area ascending 1: Area descending 2: X ascending 3: X descending 4: Y ascending 5: Y descending
137	Label No.	Set/Get	0 to 2499
138	Upper limit of the number of labels	Set/Get	0 to 2500
139	Lower limit of the number of labels	Set/Get	0 to 2500

140	Upper limit of the area	Set/Get	0 to 999999999.9999
141	Lower limit of the area	Set/Get	0 to 999999999.9999
142	Upper limit of the gravity X	Set/Get	-99999.9999 to 99999.9999
143	Lower limit of the gravity X	Set/Get	-99999.9999 to 99999.9999
144	Upper limit of the gravity Y	Set/Get	-99999.9999 to 99999.9999
145	Lower limit of the gravity Y	Set/Get	-99999.9999 to 99999.9999
146	Upper limit of the binary level (for monochrome cameras only)	Set/Get	0 to 255
147	Lower limit of the binary level (for monochrome cameras only)	Set/Get	0 to 255
148	Binary image (for monochrome cameras only)	Set/Get	0: OFF, 1: ON
149	Image kind	Set/Get	0: Measurement image 1: All color image 2: Selection color image 3: Binary image
150	Multiple selections	Set/Get	0: Multiple selections disabled 1: Multiple selections enabled
160 + N x 10	Flag N used for registered color	Set/Get	0: Not used 1: Used
161 + N x 10	Flag N for registered color OR/NOT	Set/Get	0: OR 1: NOT
162 + N x 10	Register the max. color hue N	Set/Get	0 to 359
163 + N x 10	Register the min. color hue N	Set/Get	0 to 359
164 + N x 10	Register the max. color saturation N	Set/Get	0 to 255
165 + N x 10	Register the min. color saturation N	Set/Get	0 to 255
166 + N x 10	Register the max. color brightness N	Set/Get	0 to 255
167 + N x 10	Register the min. color brightness N	Set/Get	0 to 255
168 + N x 10	Background color N	Set/Get	0: Black 1: White 2: Red 3: Green 4: Blue
501 + N x 10	Extraction condition N	Set/Get	0: OFF 1: Area 2: Gravity X 3: Gravity Y 4: Elliptic major axis 5: Elliptic minor axis 6: Ratio for flat approximate ellipse 7: Width of circumscribed rectangle 8: Height of circumscribed rectangle 9: Rectangle X1 10: Rectangle Y1
503 + N x 10	Extraction condition upper limit N	Set/Get	-999999999.9999 to 999999999.9999
504 + N x 10	Extraction condition lower limit N	Set/Get	-999999999.9999 to 999999999.9999

600 + N x 10	Judgement condition N	Set/Get	0: OFF 1: Number of labels 2: Total area 3: Area 4: Gravity X 5: Gravity Y 6: Elliptic axis angle 7: Elliptic major axis 8: Elliptic minor axis 9: Ratio for flat approximate ellipse 10: Width of circumscribed rectangle 11: Height of circumscribed rectangle 12: Upper left X coordinate of circumscribed rectangle 13: Upper left Y coordinate of circumscribed rectangle
601 + N x 10	Judgement condition display flag N	Set/Get	0: OR 1: NOT
602 + N x 10	Judgement condition upper limit N	Set/Get	-999999999.9999 to 999999999.9999
603 + N x 10	Judgement condition lower limit N	Set/Get	-999999999.9999 to 999999999.9999

Label Data

No.	Data name	Set/Get	Data range
0	Judge	Get	0: No judgement (unmeasured) 1: Judgement result OK -1: Judgement result NG
5	Label No.	Get	0 to 2499
6	Area	Get	0 to 999999999.9999
7	Gravity X	Get	-99999.9999 to 99999.9999
8	Gravity Y	Get	-99999.9999 to 99999.9999
101	Output Coordinates	Set/Get	0: After scroll 1: Before scroll
102	Calibration	Set/Get	0: OFF, 1: ON
103	Reflect to overall judgement	Set/Get	0: ON, 1: OFF
120	Label unit	Set/Get	None (-1) to 9999
121	Label No.	Set/Get	0 to 2499
122	Upper limit of the area	Set/Get	0 to 999999999.9999
123	Lower limit of the area	Set/Get	0 to 999999999.9999
124	Upper limit of gravity X	Set/Get	-99999.9999 to 99999.9999
125	Lower limit of gravity X	Set/Get	-99999.9999 to 99999.9999
126	Upper limit of gravity Y	Set/Get	-99999.9999 to 99999.9999
127	Lower limit of gravity Y	Set/Get	-99999.9999 to 99999.9999

Labeling+

No.	Data name	Set/Get	Data range
0	Judgement	Get only	0: No judgement (not yet measured) 1: Judgement result OK -1: Judgement result NG
5	Number of labels	Get only	0 to 2500
6	Reference X	Get only	-99999.9999 to 99999.9999
7	Reference Y	Get only	-99999.9999 to 99999.9999
8	Reference angle	Get only	-180 to 180
9	Gravity X-coordinate	Get only	0 to 9999
10	Gravity Y-coordinate	Get only	0 to 9999
20 + N x 10 (N = 0 to 7)	Measurement of feature quantities for judgement condition	Get only	-999999999.9999 to 999999999.9999
21 + N x 10 (N = 0 to 7)	Max. of feature quantity for judgement condition	Get only	-999999999.9999 to 999999999.9999
22 + N x 10 (N = 0 to 7)	Min. of feature quantity for judgement condition	Get only	-999999999.9999 to 999999999.9999
23 + N x 10 (N = 0 to 7)	Measurement of feature quantity for extraction condition	Get only	-999999999.9999 to 999999999.9999
24 + N x 10 (N = 0 to 7)	Max. of feature quantity for extraction condition	Get only	-999999999.9999 to 999999999.9999
25 + N x 10 (N = 0 to 7)	Min. of feature quantity for extraction condition	Get only	-999999999.9999 to 999999999.9999
101	Output coordinates	Set/Get	0: After scroll 1: Before scroll
102	Calibration	Set/Get	0: OFF 1: ON
103	Reflect to overall judgement	Set/Get	0: ON 1: OFF
120	Max. color difference	Set/Get	0 to 359
121	Min. color difference	Set/Get	0 to 359
122	Max. saturation	Set/Get	0 to 255
123	Min. saturation	Set/Get	0 to 255
124	Max. brightness	Set/Get	0 to 255
125	Min. brightness	Set/Get	0 to 255
126	Extract image	Set/Get	0: OFF 1: ON
127	Background color	Set/Get	0: Black 1: White 2: Red 3: Green 4: Blue
129	Reference X	Set/Get	-99999.9999 to 99999.9999
130	Reference Y	Set/Get	-99999.9999 to 99999.9999
131	Inverse area	Set/Get	0: OFF 1: ON
132	Filling up holes	Set/Get	0: OFF 1: ON

133	Outside trimming	Set/Get	0: OFF 1: ON
137	Label No.	Set/Get	0 to 2499
146	Upper limit of the binary level	Set/Get	0 to 255
147	Lower limit of the binary level	Set/Get	128 to 255
148	Binary image	Set/Get	0: OFF 1: ON
149	Image kind	Set/Get	0: Measurement image 1: All color image 2: Selection color image 3: Binary image
150	Selection of multiple colors	Set/Get	0: OFF 1: ON
152	Label No. for external reference	Set/Get	0 to 2499
153	Vertical (horizontal) width for line sort	Set/Get	1 to 255
160 + N x 10 (N = 0 to 7)	Flag N used for registered color (N = 0 to 7)	Set/Get	0: Not used 1: Used
161 + N x 10 (N = 0 to 7)	Flag N for registered color OR/ NOT (N = 0 to 7)	Set/Get	0: OR 1: NOT
162 + N x 10 (N = 0 to 7)	Register the max. color hue N (N = 0 to 7)	Set/Get	0 to 359
163 + N x 10 (N = 0 to 7)	Register the min. color hue N (N = 0 to 7)	Set/Get	0 to 359
164 + N x 10 (N = 0 to 7)	Register the max. color saturation N (N = 0 to 7)	Set/Get	0 to 255
165 + N x 10 (N = 0 to 7)	Register the min. color saturation N (N = 0 to 7)	Set/Get	0 to 255
166 + N x 10 (N = 0 to 7)	Register the max. color brightness N (N = 0 to 7)	Set/Get	0 to 255
167 + N x 10 (N = 0 to 7)	Register the min. color brightness N (N = 0 to 7)	Set/Get	0 to 255
168 + N x 10 (N = 0 to 7)	Background color N (N = 0 to 7)	Set/Get	0: Black 1: White 2: Red 3: Green 4: Blue
500	Dynamic binary classification (for monochrome cameras only)	Set/Get	0: Light 1: Dark 2: Equal 3: Not equal
501	Dynamic binary average filter size (for monochrome cameras only)	Set/Get	3 to 255
503	Reference angle	Set/Get	-180 to 180
504	Extraction condition setting	Set/Get	0: AND 1: OR

505	Sort condition	Set/Get	0: Area 1: Gravity X 2: Gravity Y 3: Gravity XY 4: Elliptic axis angle 5: Elliptic major axis 6: Elliptic minor axis 7: Ratio of approximate ellipse 8: Width of circumscribed rectangle 9: Height of circumscribed rectangle 10: Upper left X coordinate of circumscribed rectangle 11: Upper left Y coordinate of circumscribed rectangle 12: Perimeter 13: Circularity 14: Major axis of rotating rectangle 15: Minor axis of rotating rectangle 16: Ratio of rotating rectangle 17: Center of inscribed circle X 18: Center of inscribed circle Y 19: Center of inscribed circle XY 20: Radius of inscribed circle 21: Center of circumscribed circle X 22: Center of circumscribed circle Y 23: Center of circumscribed circle XY 24: Radius of circumscribed circle 25: Number of holes
506	XY sort condition	Set/Get	0: Row sort 1: Column sort
507	Sort row (column) sequence 1	Set/Get	0: Ascending 1: Descending
510	Judgement object label	Set/Get	0: All 1: Specified label
512	Union flag for extraction area	Set/Get	0: OFF 1: ON
515	Label number display flag	Set/Get	0: OFF 1: ON
516	Feature quantity display flag	Set/Get	0: OFF 1: ON
517	Line region draw flag	Set/Get	0: OFF 1: ON
518	Sort row (column) sequence 2	Set/Get	0: Ascending 1: Descending
519	Dynamic binary classification	Set/Get	0: Light 1: Dark 2: Equal 3: Not equal
520	Extraction offset value	Set/Get	0 to 127

601 + N x 10 (N = 0 to 2)	Extraction condition	Set/Get	0: OFF 1: Area 2: Gravity X 3: Gravity Y 4: Elliptic axis angle 5: Elliptic major axis 6: Elliptic minor axis 7: Ratio for flat approximate ellipse 8: Width of circumscribed rectangle 9: Height of circumscribed rectangle 10: Upper left X coordinate of circumscribed rectangle 11: Upper left Y coordinate of circumscribed rectangle 12: Perimeter 13: Circularity 14: Major axis of rotating rectangle 15: Minor axis of rotating rectangle 16: Radius of inscribed circle 17: Radius of circumscribed circle 18: Number of holes
603 + N x 10 (N = 0 to 2)	Upper limit of extraction condition	Set/Get	-999999999.9999 to 999999999.9999
604 + N x 10 (N = 0 to 2)	Lower limit of extraction condition	Set/Get	-999999999.9999 to 999999999.9999
700 + N x 10 (N = 0 to 7)	Judgement condition	Set/Get	0: OFF 1: Number of labels 2: Area 3: Gravity X 4: Gravity Y 5: Elliptic axis angle 6: Elliptic major axis 7: Elliptic minor axis 8: Ratio for flat approximate ellipse 9: Width of circumscribed rectangle 10: Height of circumscribed rectangle 11: Upper left X coordinate of circumscribed rectangle 12: Upper left Y coordinate of circumscribed rectangle 13: Perimeter 14: Circularity 15: Major axis of rotating rectangle 16: Minor axis of rotating rectangle 17: Ratio of rotating rectangle 18: Center of inscribed circle X 19: Center of inscribed circle Y 20: Radius of inscribed circle 21: Center of circumscribed circle X 22: Center of circumscribed circle Y 23: Radius of circumscribed circle 24: Number of holes
701 + N x 10 (N = 0 to 7)	Display selection flag for feature quantity	Set/Get	0: ON 1: OFF
702 + N x 10 (N = 0 to 7)	Upper limit of judgement condition for feature quantity	Set/Get	-999999999.9999 to 999999999.9999

703 + N x 10 (N = 0 to 7)	Lower limit of judgement condition for feature quantity	Set/Get	-999999999.9999 to 999999999.9999
1000 + N (N = 0 to 99)	Judgement condition feature quantity 0 (Label No. 0 to 99)	Get only	-999999999.9999 to 999999999.9999
1100 + N (N = 0 to 99)	Judgement condition feature quantity 1 (Label No. 0 to 99)	Get only	-999999999.9999 to 999999999.9999
1200 + N (N = 0 to 99)	Judgement condition feature quantity 2 (Label No. 0 to 99)	Get only	-999999999.9999 to 999999999.9999
1300 + N (N = 0 to 99)	Judgement condition feature quantity 3 (Label No. 0 to 99)	Get only	-999999999.9999 to 999999999.9999
1400 + N (N = 0 to 99)	Judgement condition feature quantity 4 (Label No. 0 to 99)	Get only	-999999999.9999 to 999999999.9999
1500 + N (N = 0 to 99)	Judgement condition feature quantity 5 (Label No. 0 to 99)	Get only	-999999999.9999 to 999999999.9999
1600 + N (N = 0 to 99)	Judgement condition feature quantity 6 (Label No. 0 to 99)	Get only	-999999999.9999 to 999999999.9999
1700 + N (N = 0 to 99)	Judgement condition feature quantity 7 (Label No. 0 to 99)	Get only	-999999999.9999 to 999999999.9999

Defect

No.	Data name	Set/Get	Data range
0	Judge	Get only	0: No judgement (unmeasured) 1: Judgement result OK -1: Judgement result NG
5	Defect	Get only	0 to 999
6	Position X	Get only	0 to 99999.9999
7	Position Y	Get only	0 to 99999.9999
8	Defect area	Get only	0 to 999999999.9999
9	Defect gravity X	Get only	0 to 99999.9999
10	Defect gravity Y	Get only	0 to 99999.9999
103	Reflect to overall judgement	Set/Get	0: ON 1: OFF
120	Upper limit of defect size	Set/Get	0:4 1:8 2:12 3:16 4:24 5:32 6:64

121	Lower limit of defect size	Set/Get	0:4 1:8 2:12 3:16 4:24 5:32 6:64
122	Defect judgement	Set/Get	0 to 999
123	Defect color	Set/Get	0: Both, 1: White, 2: Black
124	Area measurement	Set/Get	0: OFF, 1: ON
125	Area meas. LV	Set/Get	0 to 999
126	Area judgement	Set/Get	0 to 999999999.9999

Precise Defect

No.	Data name	Set/Get	Data range
0	Judge	Get only	0: No judgement (not yet measured) 1: Judgement result OK -1: Judgement result NG
5	Defect	Get only	0 to 999999999.9999
6	Position X	Get only	0 to 999999999.9999
7	Position Y	Get only	0 to 999999999.9999
8	Area	Get only	0 to 999999999.9999
9	Gravity X	Get only	0 to 999999999.9999
10	Gravity Y	Get only	0 to 999999999.9999
103	Reflect to overall judgement	Set/Get	0: ON 1: OFF
120	Size X	Set/Get	4 to 64
121	Size Y	Set/Get	4 to 64
122	Sampling interval X	Set/Get	1 to 64
123	Sampling interval Y	Set/Get	1 to 64
124	Comparing interval X	Set/Get	1 to 32
125	Comparing interval Y	Set/Get	1 to 32
126	Detection object color (for monochrome cameras only)	Set/Get	0: Both white/black 1: White 2: Black
127	Defect detection direction X	Set/Get	0: OFF 1: ON
128	Defect detection direction Y	Set/Get	0: OFF 1: ON
129	Inclined defect detection direction	Set/Get	0: OFF 1: ON
130	Defect judgement value	Set/Get	0 to 999
131	Area measurement	Set/Get	0: OFF 1: ON
132	Area meas, LV	Set/Get	0 to 999
133	Area judgement	Set/Get	0 to 999999999.9999

134	Profile display	Set/Get	0: OFF 1: ON
135	Element display	Set/Get	0: OFF 1: ON

Fine Matching

No.	Data name	Set/Get	Data range
0	Judgement result	Get only	0: No judgement (unmeasured) 1: Judgement result OK -1: Judgement result NG
5	Number of labeling	Get only	0 to 9999
6	Area	Get only	0 to 999999999.9999
7	Position X	Get only	-99999.9999 to 99999.9999
8	Position Y	Get only	-99999.9999 to 99999.9999
101	Output Coordinates	Set/Get	0: After scroll 1: Before scroll
102	Calibration	Set/Get	0: OFF, 1: ON
103	Reflect to overall judgement	Set/Get	0: ON, 1: OFF
120	Boundary inspection	Set/Get	0: OFF, 1: ON
121	Boundary level	Set/Get	0 to 9
122	Normalization	Set/Get	0: OFF 1: ON
123	Perturbation	Set/Get	0: OFF 1: ON
124	Difference	Set/Get	0 to 255
125	Inspection	Set/Get	0: Binary 1: Labeling
126	Label No.	Set/Get	0 to 2499
127	Sort condition	Set/Get	0: Area ascending 1: Area descending 2: X ascending 3: X descending 4: Y ascending 5: Y descending
128	Upper limit of label area condition	Set/Get	0 to 999999999.9999
129	Lower limit of label area condition	Set/Get	0 to 999999999.9999
130	Upper limit of quantity judgement	Set/Get	0 to 9999
131	Lower limit of quantity judgement	Set/Get	0 to 9999
132	Upper limit of area judgement	Set/Get	0 to 999999999.9999
133	Lower limit of area judgement	Set/Get	0 to 999999999.9999
134	Upper limit of position X	Set/Get	-99999.9999 to 99999.9999
135	Lower limit of position X	Set/Get	-99999.9999 to 99999.9999
136	Upper limit of position Y	Set/Get	-99999.9999 to 99999.9999
137	Lower limit of position Y	Set/Get	-99999.9999 to 99999.9999

Character Inspection

No.	Data name	Set/Get	Data range
0	Judge	Get only	0: No judgement (unmeasured) 1: Judgement result OK -1: Judgement result NG
1	Chara. Num	Get only	0 to 32
2	NG Cause	Get only	0x0000 to 0x0007
103	Reflect to overall judgement	Set/Get	0: ON 1: OFF
120 to 123	Dictionary unit number	Set/Get	-1: OFF 0 to 9999
124	Inspection mode	Set/Get	0: OCR 1: OCR + Count 2: OCV
125	Direction	Set/Get	0: → 1: ↓ 2: ← 3: ↑
126	Character output	Set/Get	0: OFF 1: ON
127	Character output destination	Set/Get	0: RS-232C/RS-422 1: Ethernet
129	Horizontal succession	Set/Get	0 to 99
130	Vertical succession	Set/Get	0 to 99
132	Dictionary candidate point level usage flag	Set/Get	0: Not used 1: Used
133	Rough candidate	Set/Get	0 to 100
134	Detail candidate	Set/Get	0 to 100
135	Dictionary correlation usage flag	Set/Get	0: Not used 1: Used
136	Lower limit of the corr.	Set/Get	0 to 100
137	Upper limit of chara. Num	Set/Get	1 to 32
138	Lower limit of chara. Num	Set/Get	1 to 32
139	Verification string	Set/Get	Verification string
140 to 283	Model usage flag	Set/Get	0: Not used 1: Used
1000 to 1031	Unit No.	Get only	-1: None, 0 to 9999
1032 to 1063	Detected index	Get only	0 to 35
1064 to 1095	Detected model No.	Get only	0 to 4
1096 to 1127	Chara. code	Get only	0 to 0xFFFF (UTF-16 encoded)
1128 to 1159	Detected NG Cause	Get only	0 to 7
1160 to 1191	Correlation value	Get only	0 to 100
1192 to 1223	Detected coordinate X	Get only	-99999.9999 to 99999.9999
1224 to 1255	Detected coordinate Y	Get only	-99999.9999 to 99999.9999
1256 to 1287	Detected angle	Get only	-180 to 180
1288 to 1319	Reference X	Get only	-99999.9999 to 99999.9999
1320 to 1351	Reference Y	Get only	-99999.9999 to 99999.9999
1352 to 1383	Reference angle	Get only	-180 to 180

Date Verification

No.	Data name	Set/Get	Data range
0	Judge	Get only	0: No judgement (unmeasured) 1: Judgement result OK -1: Judgement result NG
1	Verification string	Get only	Character string with 32 characters or less
2	Read string	Get only	Character string with 32 characters or less
103	Reflect to overall judgement	Set/Get	0: ON 1: OFF
120	OCR unit number	Set/Get	-1: OFF 0 to 9999
125	Term year	Set/Get	0 to 99
126	Term month	Set/Get	0 to 99
127	Term day	Set/Get	0 to 999
128	Auto Update	Set/Get	0: Not update 1: First measurement after startup 2: Always update
129	Zero suppress	Set/Get	0:0 1: Space
130	Calculation order	Set/Get	0: Month → Day 1: Day → Month
131	Month end adjust	Set/Get	0: Last day of now 1: First day of next 2: Gap day of next
132	Back margin	Set/Get	0 to 99
133	Ahead margin	Set/Get	0 to 99
134	Code year 1 flag	Set/Get	0: Not used 1 : Used
135	Code year 2 flag	Set/Get	0: Not used 1 : Used
136	Code month 1 flag	Set/Get	0: Not used 1 : Used
137	Code month 2 flag	Set/Get	0: Not used 1 : Used
138	Code day 1 flag	Set/Get	0: Not used 1 : Used
139	Code day 2 flag	Set/Get	0: Not used 1 : Used
140	Code hour 1 flag	Set/Get	0: Not used 1 : Used
141	Code hour 2 flag	Set/Get	0: Not used 1 : Used
142	Code minute 1 flag	Set/Get	0: Not used 1 : Used
143	Code minute 2 flag	Set/Get	0: Not used 1 : Used
160	Operation code number	Set/Get	0 to 99

Model Dictionary

No.	Data name	Set/Get	Data range
0	Judge	Get only	0: No judgement (unmeasured) 1: Judgement result OK -1: Judgement result NG
121	With rotation	Set/Get	0: OFF 1: ON
122	Upper limit of the rotation angle	Set/Get	-45 to 45
123	Lower limit of the rotation angle	Set/Get	-45 to 45
125	Smart mode	Set/Get	0: OFF 1: ON
126	Stab.	Set/Get	1 to 15
127	Prec.	Set/Get	1 to 3

Barcode+

No.	Data name	Set/Get	Data range
0	Judge	Get only	0: No judgement (unmeasured) 1: Judgement result OK -1: Judgement result NG
6	Decoded character count	Get only	0 to (CHAR_NUM_MAX - 1)
7	Decoded character string	Get only	0 to (CHAR_NUM_MAX - 1) characters
8	Index	Get only	0 to (INDEX_NUM_MAX - 1) -1: Where there was no match with any of the index comparison strings, or the index comparison string has not been set up.
103	Reflect to overall judgement	Set/Get	0: ON 1: OFF

120	Code type	Set/Get	0: JAN/EAN - 8 1: JAN/EAN - 8 Add - On 2 2: JAN/EAN - 8 Add - On 5 3: JAN/EAN - 13 4: JAN/EAN - 13 Add - On 2 5: JAN/EAN - 13 Add - On 5 6: UPC-A 7: UPC-A Add-On 2 8: UPC-A Add-On 5 9: UPC-E 10: UPC-E Add-On 2 11: UPC-E Add-On 5 12: Code 39 13: Code 93 14: Code 128 15: IFT (Interleaved 2 of 5) 16: Codabar (NW-7) 17: GS1 Databar (RSS-14) 18: GS1 Databar (RSS Lim.) 19: GS1 Databar (RSS Exp.)
121	Flag used for special character judgement	Set/Get	0: "*" are considered to be wild cards 1: "*" are considered to be character strings
122	Flag used for special character classification	Set/Get	0: "*" are considered to be wild cards 1: "*" are considered to be character strings
123	Flag showing character string display results	Set/Get	Flag regarding whether or not character string is displayed
124	Character string display color	Set/Get	0: Black 1 : White 2: Red 3: Green 4: Blue
125	Character string display size	Set/Get	10 to 100
133	Wide bar size	Set/Get	4 to 60.0
134	Narrow bar size	Set/Get	1.5 to 10.0
136	Check digit	Set/Get	0: Check digit is not used 1: Check digit is used
137	Number of characters detected setting	Set/Get	CHAR_NUM_MIN to CHAR_NUM_MAX
162	Upper limit of number of characters detected	Set/Get	0 to CHAR_NUM_MAX
163	Lower limit of number of characters detected	Set/Get	0 to CHAR_NUM_MAX
164	Judgement comparison character string	Set/Get	Comparison string used for judgement
300 to 335	Classification comparison character string	Set/Get	Verification string used for classification
400	Character output flag	Set/Get	0: Not output 1 : Output

401	Output device	Set/Get	0: RS-232C 1: Ethernet
402	Error output	Set/Get	Error output flag
403	Error message	Set/Get	Message output while outputting an error

2D Code+

No.	Data name	Set/Get	Data range
0	Judge	Get only	0: No judgement (unmeasured) 1: Judgement result OK -1: Judgement result NG
6	Decoded character count	Get only	Number of characters included in code detected
7	Decoded character string	Get only	Character string included in code detected
8	Index	Get only	0 to (INDEX_NUM_MAX - 1) -1: Where there was no match with any of the index comparison strings, or the index comparison string has not been set up.
9	Integrated quality	Get only	0 to 4
10	Contrast	Get only	0 to 4
11	Modulation	Get only	0 to 4
12	Fixed pattern damage	Get only	0 to 4
13	Decode	Get only	0 to 4
14	Axis non-uniformity	Get only	0 to 4
15	Grid non-uniformity	Get only	0 to 4
16	Correction of error not used	Get only	0 to 4
103	Reflect to overall judgement	Set/Get	0: ON 1: OFF
120	Code type	Set/Get	0: Data Matrix ECC 200 1: QRcode
121	Flag used for special character judgement	Set/Get	0: "*" are considered to be wild cards 1: "*" are considered to be character strings
122	Flag used for special character classification	Set/Get	0: "*" are considered to be wild cards 1: "*" are considered to be character strings
123	Flag showing character string display results	Set/Get	0 : Not displayed 1 : Displayed
124	Character string display color	Set/Get	0: Black 1 : White 2: Red 3: Green 4: Blue
125	Character string display size	Set/Get	10 to 200
134	Code color setting	Set/Get	0: Black code 1 : White code
170	Upper limit of number of characters detected	Set/Get	0 to CHAR_NUM_MAX

171	Lower limit of number of characters detected	Set/Get	0 to CHAR_NUM_MAX
172	Judgement comparison character string	Set/Get	Comparison string used for judgement
173	Lower limit of overall quality	Set/Get	0 to 4
190	Grade overall quality display	Set/Get	0 : Not displayed 1 : Displayed
191	Grade: Contrast display setting (DataMatrix, QR)	Set/Get	0 : Not displayed 1 : Displayed
192	Grade: Modulation display setting (DataMatrix, QR)	Set/Get	0 : Not displayed 1 : Displayed
193	Grade: Fixed pattern damage display setting (DataMatrix, QR)	Set/Get	0 : Not displayed 1 : Displayed
194	Grade: Decode display setting (DataMatrix, QR)	Set/Get	0 : Not displayed 1 : Displayed
195	Grade: Axis non-uniformity display setting (DataMatrix, QR)	Set/Get	0 : Not displayed 1 : Displayed
196	Grade: Grid non-uniformity display setting (DataMatrix, QR)	Set/Get	0 : Not displayed 1 : Displayed
197	Grade: Correction of error not used display setting (DataMatrix, QR)	Set/Get	0 : Not displayed 1 : Displayed
300 to 335	Classification comparison character string	Set/Get	Verification string used for classification
400	Character output flag	Set/Get	0: Not output 1 : Output
401	Output device	Set/Get	0: RS-232C 1: Ethernet
402	Error output	Set/Get	Error output flag
403	Error message	Set/Get	Message output while outputting an error

Circle Angle

No.	Data name	Set/Get	Data range
0	Judge	Get only	0: No judgement (unmeasured) 1: Judgement result OK -1: Judgement result NG
5	Center position X	Get only	0 to 99999.9999
6	Center position Y	Get only	0 to 99999.9999
7	Rotation angle	Get only	-180 to 180
8	Reference X	Get only	0 to 99999.9999
9	Reference Y	Get only	0 to 99999.9999
10	Reference angle	Get only	-180 to 180
101	Output coordinates	Set/Get	0: After scroll 1: Before scroll
102	Calibration	Set/Get	0: OFF, 1: ON
120	Mode	Set/Get	0: Search 1: Edge 2: Defect
121	Skipping angle	Set/Get	0.1 to 10

122	Edge pitch	Set/Get	1 to 99
-----	------------	---------	---------

Compensate image

Position Compensation

No.	Data name	Set/Get	Data range
0	Judge	Get only	0: No judgement (unmeasured) 1: Judgement result OK -1: Judgement result NG
5	Scroll X	Get only	-99999.9999 to 99999.9999
6	Scroll Y	Get only	-99999.9999 to 99999.9999
7	Scroll θ	Get only	-999.9999 to 999.9999
8	Position X	Get only	0 to 99999.9999
9	Position Y	Get only	0 to 99999.9999
10	Measurement θ	Get only	-360 to 360
11	Reference X	Get only	-99999.9999 to 99999.9999
12	Reference Y	Get only	-99999.9999 to 99999.9999
13	Reference θ	Get only	-999.9999 to 999.9999
120	Interpolation	Set/Get	0: None 1: Bilinear
121	Method	Set/Get	0: 1 unit scroll 1: 2 unit scroll 2: Expression 3: Reset scroll
122	Scroll target	Set/Get	0: Camera image 1: Prev. unit image
123	With rotation	Set/Get	0: OFF 1: ON

Trapezoidal Correction+

No.	Data name	Set/Get	Data range
0	Judge	Get only	0: No judgement (unmeasured) 1: Judgement result OK -1: Judgement result NG
120	Interpolation mode	Set/Get	0: None 1: Linear interpolation
121	Method	Set/Get	0: See unit 4 1: Expression
122	Input image	Set/Get	0: Camera image 1: Prev image
123	Reference position setting method	Set/Get	0: Figure 1: Expression
124	Measurement position setting method	Set/Get	0: Figure 1: Expression
125	Reference coordinate display	Set/Get	0: Not displayed 1: Displayed

126	Reference coordinate display color	Set/Get	0: Black 1 : White 2: Red 3: Green 4: Blue
127	Measurement coordinate display	Set/Get	0 : Not displayed 1 : Displayed
128	Measurement coordinate display color	Set/Get	0: Black 1 : White 2: Red 3: Green 4: Blue
129	Filtered image	Set/Get	0: Disp input image 1: Filtered image

Filtering

No.	Data name	Set/Get	Data range
0	Judge	Get only	0: No judgement (unmeasured) 1: Judgement result OK -1: Judgement result NG
120	Target	Set/Get	0: Camera image 1: Prev. unit image
121	Filtering	Set/Get	0: OFF 1: Weak smoothing 2: Strong smoothing 3: Dilation 4: Erosion 5: Median 6: Extract vertical edges 7: Extract horizontal edges 8: Extract edges 9: Enhance edges
122	Filtering order	Set/Get	0: Filtering to BGS 1: BGS to Filtering
123	Filter size	Set/Get	0: 3 * 3 1: 5 * 5
124	Lower limit for BGS levels	Set/Get	0 to 255
125	Upper limit for BGS levels	Set/Get	0 to 255

Background Suppression

No.	Data name	Set/Get	Data range
0	Judge	Get only	0: No judgement (unmeasured) 1: Judgement result OK -1: Judgement result NG

121	Color setting mode	Set/Get	0: RGB common 1: RGB individual
122	Lower limit for common colors	Set/Get	0 to 255
123	Upper limit for common colors	Set/Get	0 to 255
124	MIN R	Set/Get	0 to 255
125	MAX R	Set/Get	0 to 255
126	MIN G	Set/Get	0 to 255
127	MAX G	Set/Get	0 to 255
128	MIN B	Set/Get	0 to 255
129	MAX B	Set/Get	0 to 255
130	Lower limit for shading	Set/Get	0 to 255
131	Upper limit for shading	Set/Get	0 to 255
132	Filtered image	Set/Get	0: Image prior to transfer 1: Image after transfer
200	Transfer source image number	Set/Get	0 to 9
201	Transfer destination image number	Set/Get	0 to 9

Color Gray Filter

No.	Data name	Set/Get	Data range
0	Judge	Get only	0: No judgement (unmeasured) 1: Judgement result OK -1: Judgement result NG
100	Filter kind	Set/Get	0: RGB filter 1: HSV filter
101	RGB filter kind	Set/Get	0: Red filter 1: Green filter 2: Blue filter 3: Cyan filter 4: Magenta filter 5: Yellow filter 6: Brightness filter (R+G+B) 7: Brightness filter (R+2G+B) 8: Custom filter
102	Gain (Red)	Set/Get	0.0001 to 9.9999
103	Gain (Green)	Set/Get	0.0001 to 9.9999
104	Gain (Blue)	Set/Get	0.0001 to 9.9999
105	HSV filter kind	Set/Get	0: Fast 1: Fine
106	Standard Hue	Set/Get	0 to 359
107	Hue range	Set/Get	10 to 180
108	Upper Limit for Saturation	Set/Get	0 to 255
109	Lower Limit for Saturation	Set/Get	0 to 255

Extract Color Filter

No.	Data name	Set/Get	Data range
0	Judge	Get only	0: No judgement (unmeasured) 1: Judgement result OK -1: Judgement result NG
120	Fill profile	Set/Get	0: OFF 1: Fill profile 2: Filling up holes
121	Inverse area presence	Set/Get	0: OFF 1: ON
122	Image kind	Set/Get	0: Measurement image 1: All color image 2: Selection color image 3: Binary image
123	Multiple selections	Set/Get	0: Multiple selections disabled 1: Multiple selections enabled
124	Output image	Set/Get	0: Binary image 1: All color image
130	Usage flag [0]	Set/Get	0: Not used 1 : Used
130 + 10 x N (N = 0 to 7)	Usage flag [N] (N = 0 to 7)	Set/Get	0: Not used 1 : Used Default value 1 only for [0] Default value 0 for all others
131 + 10 x N (N = 0 to 7)	OR/NOT setting [N] (N = 0 to 7)	Set/Get	0: OR 1: NOT
132 + 10 x N (N = 0 to 7)	Register the max. color hue [N] (N = 0 to 7)	Set/Get	0 to 359
133 + 10 x N (N = 0 to 7)	Register the min. color hue [N] (N = 0 to 7)	Set/Get	0 to 359
134 + 10 x N (N = 0 to 7)	Register the max. color saturation [N] (N = 0 to 7)	Set/Get	0 to 255
135 + 10 x N (N = 0 to 7)	Register the min. color saturation [N] (N = 0 to 7)	Set/Get	0 to 255
136 + 10 x N (N = 0 to 7)	Register the max. color brightness [N] (N = 0 to 7)	Set/Get	0 to 255
137 + 10 x N (N = 0 to 7)	Register the min. color brightness [N] (N = 0 to 7)	Set/Get	0 to 255
138 + 10 x N (N = 0 to 7)	Register the BG color [N] (N = 0 to 7)	Set/Get	0: Black 1 : White 2: Red 3: Green 4: Blue
5000	RGB value pixel density data	Set/Get	Characteristic application The RGB value for the coordinate specified during set up is saved in measurement data. When acquiring, the data saved in measurement data is returned.

5001	Selected color extraction range	Set/Get	Characteristic application The color extraction range number selected during set up is saved in measurement data. When acquiring, the data saved in measurement data is returned.
------	---------------------------------	---------	---

Anti Color Shading

No.	Data name	Set/Get	Data range
0	Judge	Get only	0: No judgement (unmeasured) 1: Judgement result OK -1: Judgement result NG
100	Specified color R1	Set/Get	0 to 255
101	Specified color G1	Set/Get	0 to 255
102	Specified color B1	Set/Get	0 to 255
103	Specified color R2	Set/Get	0 to 255
104	Specified color G2	Set/Get	0 to 255
105	Specified color B2	Set/Get	0 to 255
106	Direction	Set/Get	0: Color 1 →← Color 2 1: Color 1 → Color 2 2: Color 1 ← Color 2
107	Shading level	Set/Get	0 to 255
108	Filtered image	Set/Get	0: OFF 1: ON

Stripes Removal Filter+

No.	Data name	Set/Get	Data range
0	Judge	Get only	0: No judgement (unmeasured) 1: Judgement result OK -1: Judgement result NG
100	Transfer source image number	Set/Get	0 to 9
101	Image number after transfer	Set/Get	0 to 9
102	Target image	Set/Get	0: Camera image 1: Prev. unit image
103	Display image	Set/Get	0: Image prior to processing 1: Image after processing
200	Defect brightness	Set/Get	0: Light 1: Dark 2: Light and dark
201	Background pattern	Set/Get	0: Normal 1: Vertical stripes 2: Horizontal stripes 3: Lattice
202	Background pattern presence	Set/Get	0: OFF 1: ON

300	Vertical and horizontal width of square filter	Set/Get	3 to 63 Pattern kind: Lattice
301	Vertical width of vertical filter	Set/Get	3 to 63 Pattern kind: Lattice
302	Horizontal width of horizontal filter	Set/Get	3 to 63 Pattern kind: Lattice
303	Defect size	Set/Get	3 to 63 [3] Pattern kind: Normal, vertical stripes, horizontal stripes
350	Contrast	Set/Get	Contrast 1 to 63

Halation Cut+

No.	Data name	Set/Get	Data range
0	Judge	Get only	0: No judgement (unmeasured) 1: Judgement result OK -1: Judgement result NG
103	Reflect to overall judgement	Set/Get	-0: ON, 1: OFF
120	RB ratio adjustment	Set/Get	-100 to 100
121	Gain	Set/Get	0.0001 to 9.9999
122	Filtered image	Set/Get	0: Display image prior to transfer 1: Filtered image
200	Transfer source image number	Set/Get	0 to 9
201	Image number after transfer	Set/Get	0 to 9

Panorama+

No.	Data name	Set/Get	Data range
0	Judge	Get	0: No judgement (unmeasured) 1: Judgement result OK -1: Judgement result NG
100	Select camera	Set/Get	0: Camera 0 + 1 1: Camera 0 + 1 + 2 2: Camera 0 + 1 + 2 + 3
101	Arrangement	Set/Get	0: (1 x 4) placement 1: (2 x 2) placement
102	Select Image	Set/Get	0 to 3
103	Amount of parallel movement X	Set/Get	For 0.3 megapixel cameras: - 640 to 640 For 2 megapixel cameras: - 1600 to 1600
104	Amount of parallel movement Y	Set/Get	For 0.3 megapixel cameras: - 480 to 480 For 2 megapixel cameras: - 1200 to 1200
107	Flag for drawing image frame	Set/Get	0: Not drawn 1 : Drawn
108	Flag for drawing characteristic points	Set/Get	0: Not drawn 1 : Drawn

109	Flag for executing brightness correction	Set/Get	0: Not executed 1 : Executed
110	Brightness correction reference image No.	Set/Get	0 to 3
112	Number of valid images	Get	0 to 4
200	Foremost window image	Set/Get	Camera number of foremost window of cameras used

Polar Transformation

No.	Data name	Set/Get	Data range
0	Judge	Get only	0: No judgement (unmeasured) 1: Judgement result OK -1: Judgement result NG
120	Cut out angle	Set/Get	0 to 359
122	Overlap	Set/Get	0 to 360
123	Disp transferred image	Set/Get	0: Image prior to transfer 1: Image after transfer

Support measurement

Calculation

No.	Data name	Set/Get	Data range
0	Judge	Get only	0: No judgement (unmeasured) 1: Judgement result OK -1: Judgement result NG
5 to 12	Expression result of Expression 0 - Expression result of Expression 7	Set/Get	-999999999.9999 to 999999999.9999
13 to 20	Judgement result of Expression 0 - Judgement result of Expression 7	Get only	0: Unmeasured, 1: OK, -1: NG
103	Reflect to overall judgement	Set/Get	0: ON, 1: OFF
120	Upper limit 0 for judgement	Set/Get	-999999999.9999 to 999999999.9999
121	Lower limit 0 for judgement	Set/Get	-999999999.9999 to 999999999.9999
122	Upper limit 1 for judgement	Set/Get	-999999999.9999 to 999999999.9999
123	Lower limit 1 for judgement	Set/Get	-999999999.9999 to 999999999.9999
124	Upper limit 2 for judgement	Set/Get	-999999999.9999 to 999999999.9999
125	Lower limit 2 for judgement	Set/Get	-999999999.9999 to 999999999.9999
126	Upper limit 3 for judgement	Set/Get	-999999999.9999 to 999999999.9999
127	Lower limit 3 for judgement	Set/Get	-999999999.9999 to 999999999.9999
128	Upper limit 4 for judgement	Set/Get	-999999999.9999 to 999999999.9999
129	Lower limit 4 for judgement	Set/Get	-999999999.9999 to 999999999.9999
130	Upper limit 5 for judgement	Set/Get	-999999999.9999 to 999999999.9999
131	Lower limit 5 for judgement	Set/Get	-999999999.9999 to 999999999.9999
132	Upper limit 6 for judgement	Set/Get	-999999999.9999 to 999999999.9999
133	Lower limit 6 for judgement	Set/Get	-999999999.9999 to 999999999.9999
134	Upper limit 7 for judgement	Set/Get	-999999999.9999 to 999999999.9999
135	Lower limit 7 for judgement	Set/Get	-999999999.9999 to 999999999.9999

Line Regression

No.	Data name	Set/Get	Data range
0	Judge	Get only	0: No judgement (unmeasured) 1: Judgement result OK -1: Judgement result NG
5	Line Param. 0 A	Get only	-99999.9999 to 99999.9999
6	Line Param. 0 B	Get only	-99999.9999 to 99999.9999
7	Line Param. 0 C	Get only	-99999.9999 to 99999.9999
8	Line Param. 1 A	Get only	-99999.9999 to 99999.9999
9	Line Param. 1 B	Get only	-99999.9999 to 99999.9999
10	Line Param. 1 C	Get only	-99999.9999 to 99999.9999
11	Cross point X	Get only	-99999.9999 to 99999.9999
12	Cross point Y	Get only	-99999.9999 to 99999.9999

13	Angle	Get only	0.0000 to 180.0000
14	Point X	Get only	-99999.9999 to 99999.9999
15	Point Y	Get only	-99999.9999 to 99999.9999
16	Distance	Get only	0.0000 to 99999.9999
101	Output Coordinates	Set/Get	0: After scroll 1: Before scroll
102	Calibration	Set/Get	0: OFF 1: ON
120	Function type	Set/Get	0: Calculate line 1: Calculate cross point and angle of two lines 2: Calculate distance between line and point
121	Noise cancel 0	Set/Get	0: Noise cancel OFF 1: Noise cancel ON
122	Noise cancel 1	Set/Get	0: Noise cancel OFF 1: Noise cancel ON
123	Number of points 0	Set/Get	2 to 8
124	Number of points 1	Set/Get	2 to 8
125	Method 0	Set/Get	0: Nearest unit 1: Expression
126	Method 1	Set/Get	0: Nearest unit 1: Expression

Circle Regression

No.	Data name	Set/Get	Data range
0	Judge	Get only	0: No judgement (unmeasured) 1: Judgement result OK -1: Judgement result NG
5	Central X	Get only	-99999.9999 to 99999.9999
6	Central Y	Get only	-99999.9999 to 99999.9999
7	Radius	Get only	0 to 99999.9999
101	Output Coordinates	Set/Get	0: After scroll 1: Before scroll
102	Calibration	Set/Get	0: OFF 1: ON
121	Number of points	Set/Get	3 to 8
122	Method	Set/Get	0: Nearest unit 1: Expression

Calibration+

No.	Data name	Set/Get	Data range
120	Coordinate indication method	Set/Get	0: Specified point 1: Sampling
200 to 208	Specified coordinate X	Set/Get	0.0000 to 99999.9999
300 to 308	Specified coordinate Y	Set/Get	0.0000 to 99999.9999

400 to 408	Actual coordinate X	Set/Get	-99999.9999 to 99999.9999
500 to 508	Actual coordinate Y	Set/Get	-99999.9999 to 99999.9999

Set Unit Data

No.	Data name	Set/Get	Data range
0	Judge	Get only	0: No judgement (unmeasured) 1: Judgement result OK -1: Judgement result NG
5	Data	Get only	-999999999.9999 to 999999999.9999
120	Unit	Set/Get	0 to 9999
121	Data No.	Set/Get	0 to 99999

Get Unit Data

No.	Data name	Set/Get	Data range
0	Judge	Get only	0: No judgement (unmeasured) 1: Judgement result OK -1: Judgement result NG
5	Data	Get only	-999999999.9999 to 999999999.9999
120	Unit	Set/Get	0 to 9999
121	Data No.	Set/Get	0 to 99999

Set Unit Figure

No.	Data name	Set/Get	Data range
0	Judge	Get only	0: No judgement (unmeasured) 1: Judgement result OK -1: Judgement result NG
5 to 24	Data 0 to 19	Get only	-999999999.9999 to 999999999.9999
120	Target unit	Set/Get	0 to 9999
121	Register figure No.	Set/Get	0 to 999
122	Target figure No.	Set/Get	0 to 7
123	Number of setting data items	Get only	0 to 20

Get Unit Figure

No.	Data name	Set/Get	Data range
0	Judge	Get only	0: No judgement (unmeasured) 1: Judgement result OK -1: Judgement result NG
1	Number of figures	Get only	Number of figures acquired

2	Size of figures	Get only	Size of figures acquired
120	Target processing unit No.	Set/Get	0 to 9999
121	Target figure No.	Set/Get	0 to 999
1000 + 100 x N (N = 0 to 9)	Figure N type (N = 0 to 9)	Get only	Figure 0 type 0x0000 → Undefined 0x0001 → Point 0x0002 → Line 0x0004 → Wide line 0x0008 → Rectangle 0x0010 → Ellipse 0x0020 → Circle 0x0040 → Wide circle 0x0080 → Arc 0x0100 → Wide arc 0x0200 → Polygon Set to 0 if no figures are acquired.
1001 + 100 x N (N = 0 to 9)	Figure N drawing mode (N = 0 to 9)	Get only	Figure N drawing mode
1002 + 100 x N to 1022 + 100 x N (N = 0 to 9)	Figure N data 00 to Figure N data 20 (N = 0 to 9)	Get only	Figure N data 0 to 20 The amount of valid data differs with data type. Set to 0 if disabled or no figures are acquired.

Trend Monitor

No.	Data name	Set/Get	Data range
0	Judge	Get only	0: No judgement (unmeasured) 1: Judgement result OK -1: Judgement result NG
5	Measurement	Get only	-999999999.9999 to 999999999.9999
6	Warning	Get only	0: OFF 1: ON
7	Maximum	Get only	-999999999.9999 to 999999999.9999
8	Minimum	Get only	-999999999.9999 to 999999999.9999
9	Average	Get only	-999999999.9999 to 999999999.9999
10	Deviation	Get only	-999999999.9999 to 999999999.9999
11	Count	Get only	0 to 999999999
12	NG count	Get only	0 to 999999999
13	Warning count	Get only	0 to 999999999
103	Reflect to overall judgement	Set/Get	0: ON, 1: OFF
121	Upper limit of the judgement	Set/Get	-999999999.9999 to 999999999.9999
122	Lower limit of the judgement	Set/Get	-999999999.9999 to 999999999.9999
123	Warning upper limit	Set/Get	-999999999.9999 to 999999999.9999
124	Warning lower limit	Set/Get	-999999999.9999 to 999999999.9999

125	Upper limit of the display range	Set/Get	-999999999.9999 to 999999999.9999
126	Lower limit of the display range	Set/Get	-999999999.9999 to 999999999.9999
127	Amount of change to display range	Set/Get	1 to 1000000
128	Horizontal	Set/Get	0: Display 200 results 1: Display 1000 results

Image Logging

No.	Data name	Set/Get	Data range
0	Judge	Get only	0: No judgement (unmeasured) 1: Judgement result OK -1: Judgement result NG
5	Calculation result	Get only	-99999.9999 to 99999.9999
6	Judgement result	Get only	0: No judgement (unmeasured) 1: Judgement result OK -1: Judgement result NG
120	Logging condition	Set/Get	0: None 1: Only NG 2: All
122 to 123	Upper limit of conditions calculation	Set/Get	-99999.9999 to 99999.9999
	Lower limit of conditions calculation	Set/Get	-99999.9999 to 99999.9999

Data Logging

No.	Data name	Set/Get	Data range
0	Judge	Get only	0: No judgement (unmeasured) 1: Judgement result OK -1: Judgement result NG
5 to 12	Result of Expression 0 - Result of Expression 7	Get only	Calculation results of expressions
120	Measurement ID	Set/Get	0: OFF, 1: ON
121	Integer	Set/Get	1 to 10
122	Decimal	Set/Get	0: 0 to 4: 4
123	Minus	Set/Get	0: -, 1:8
124	Field separator	Set/Get	0: OFF, 1: Comma, 2: Tab, 3: Space, 4: CR+LF
125	Record separator	Set/Get	0: OFF 1: Comma, 2: Tab, 3: Space, 4: CR+LF
126	0 suppress	Set/Get	0: OFF, 1: ON

Elapsed Time

No.	Data name	Set/Get	Data range
0	Judge	Get only	0: No judgement (unmeasured) 1: Judgement result OK -1: Judgement result NG
5	Elapsed Time	Get only	0 to 999999

Wait

No.	Data name	Set/Get	Data range
120	Waiting time	Set/Get	0 to 9999 (ms)

Focus

No.	Data name	Set/Get	Data range
0	Judge	Get only	0: No judgement (unmeasured) 1: Judgement result OK -1: Judgement result NG
1	Measurement data Focus value	Get only	0 to 255
103	Setting data Reflect to overall judgement	Set/Get	0: ON 1: OFF
120	Setting data Focus value Lower limit	Set/Get	0 to 255

Iris

No.	Data name	Set/Get	Data range
0	Judge	Get only	0: No judgement (unmeasured) 1: Judgement result OK -1: Judgement result NG
1	Measurement data Valid pixel	Get only	0 to 100
2	Measurement data Average brightness	Get only	0 to 255
3	Measurement data R average	Get only	0 to 255
4	Measurement data G average	Get only	0 to 255
5	Measurement data B average	Get only	0 to 255
103	Setting data Reflect to overall judgement	Set/Get	0: ON 1: OFF
120	Setting data Valid brightness range Lower limit	Set/Get	0 to 255
121	Setting data Valid brightness range Upper limit	Set/Get	0 to 255
122	Setting data Valid pixel Lower limit	Set/Get	0 to 100
123	Setting data Average brightness Lower limit	Set/Get	0 to 255
124	Setting data Average brightness Upper limit	Set/Get	0 to 255
125	Setting data R average Lower limit	Set/Get	0 to 255

126	Setting data R average Upper limit	Set/Get	0 to 255
127	Setting data G average Lower limit	Set/Get	0 to 255
128	Setting data G average Upper limit	Set/Get	0 to 255
129	Setting data B average Lower limit	Set/Get	0 to 255
130	Setting data B average Upper limit	Set/Get	0 to 255

Branch

Conditional Branch

No.	Data name	Set/Get	Data range
0	Judge	Get	0: No judgement (unmeasured) 1: Judgement result OK -1: Judgement result NG
5	Expression A result	Get	Maximum 256 characters (result of calculation selected in expression A)
6	Expression B result	Get	Maximum 256 characters (result of calculation selected in expression B)
7	Comparison result	Get	0: NO 1: YES
8	Destination unit No.	Get	0 to 32767
120	Condition type	Set/Get	0: A = B 1: A <= B 2: A < B 3: A >= B 4: A > B
121	YES branch destination unit No.	Set/Get	-1: End processing 0 to 32767: Unit No.
122	NO Destination unit No.	Set/Get	-1: End processing 0 to 32767: Unit No.

DI Branch

No.	Data name	Set/Get	Data range
0	Judge	Get	0: No judgement (unmeasured) 1: Judgement result OK -1: Judgement result NG
5	DI input No.	Get	No. used to indicate DI input (00000 to 11111)
6	Unit No	Get	Unit number at destination corresponding to DI input
120 to 151	Destination Unit No. 0 - Destination Unit No. 31	Set/Get	-1: End processing 0 to 9999: Unit No.

Output result

Data Output

No.	Data name	Set/Get	Data range
0	Judge	Get only	0: No judgement (unmeasured) 1: Judgement result OK -1: Judgement result NG
5 to 12	Data 0 - Data 7	Get only	<ul style="list-style-type: none"> • ASCII: -99999999.9999 to 99999999.9999 • Binary: -2147483.648 to 2147483.647
136	Communication method	Set/Get	0: Ethernet 1: RS-232C/RS-422
137	Output format	Set/Get	0: ASCII, 1: Binary
138	Integer	Set/Get	1 to 10
139	Decimal	Set/Get	0: 0 to 4: 4
140	Minus	Set/Get	0: -, 1:8
141	Field separator	Set/Get	0: OFF 1: Comma, 2: Tab, 3: Space, 4: Delimiter
142	Record separator	Set/Get	0: OFF 1: Comma, 2: Tab, 3: Space, 4: Delimiter
143	0 suppress	Set/Get	0: OFF, 1: ON
144 to 147	Output IP address (1 to 4) (only when "Ethernet" is selected for the communication method)	Set/Get	Output IP address
149	Output IP address setting (only when "Ethernet" is selected for the communication method)	Set/Get	0: Reference to system, 1: Individual specification

Parallel Data Output

No.	Data name	Set/Get	Data range
0	Judge	Get only	0: No judgement (unmeasured) 1: Judgement result OK -1: Judgement result NG
5 to 12	Data 0 - Data 7	Get only	BCD: -999 to 999 Binary: -32768 to 32768
128	Data format	Set/Get	0: Binary, 1: BCD

Parallel Judgement Output

No.	Data name	Set/Get	Data range
0	Judge	Get only	0: No judgement (unmeasured) 1: Judgement result OK -1: Judgement result NG
5 to 20	Data 0 - Data 15	Get only	-999999999.9999 to 999999999.9999
21 to 36	Judge 0 - Judge 15	Get only	1: OK, -1: NG, 0: Unmeasured
103	Reflect to overall judgement	Set/Get	0: ON, 1: OFF
136	Upper limit 0 for judgement	Set/Get	-999999999.9999 to 999999999.9999
137	Lower limit 0 for judgement	Set/Get	-999999999.9999 to 999999999.9999
138	Upper limit 1 for judgement	Set/Get	-999999999.9999 to 999999999.9999
139	Lower limit 1 for judgement	Set/Get	-999999999.9999 to 999999999.9999
140	Upper limit 2 for judgement	Set/Get	-999999999.9999 to 999999999.9999
141	Lower limit 2 for judgement	Set/Get	-999999999.9999 to 999999999.9999
142	Upper limit 3 for judgement	Set/Get	-999999999.9999 to 999999999.9999
143	Lower limit 3 for judgement	Set/Get	-999999999.9999 to 999999999.9999
144	Upper limit 4 for judgement	Set/Get	-999999999.9999 to 999999999.9999
145	Lower limit 4 for judgement	Set/Get	-999999999.9999 to 999999999.9999
146	Upper limit 5 for judgement	Set/Get	-999999999.9999 to 999999999.9999
147	Lower limit 5 for judgement	Set/Get	-999999999.9999 to 999999999.9999
148	Upper limit 6 for judgement	Set/Get	-999999999.9999 to 999999999.9999
149	Lower limit 6 for judgement	Set/Get	-999999999.9999 to 999999999.9999
150	Upper limit 7 for judgement	Set/Get	-999999999.9999 to 999999999.9999
151	Lower limit 7 for judgement	Set/Get	-999999999.9999 to 999999999.9999
152	Upper limit 8 for judgement	Set/Get	-999999999.9999 to 999999999.9999
153	Lower limit 8 for judgement	Set/Get	-999999999.9999 to 999999999.9999
154	Upper limit 9 for judgement	Set/Get	-999999999.9999 to 999999999.9999
155	Lower limit 9 for judgement	Set/Get	-999999999.9999 to 999999999.9999
156	Upper limit 10 for judgement	Set/Get	-999999999.9999 to 999999999.9999
157	Lower limit 10 for judgement	Set/Get	-999999999.9999 to 999999999.9999
158	Upper limit 11 for judgement	Set/Get	-999999999.9999 to 999999999.9999
159	Lower limit 11 for judgement	Set/Get	-999999999.9999 to 999999999.9999
160	Upper limit 12 for judgement	Set/Get	-999999999.9999 to 999999999.9999
161	Lower limit 12 for judgement	Set/Get	-999999999.9999 to 999999999.9999
162	Upper limit 13 for judgement	Set/Get	-999999999.9999 to 999999999.9999
163	Lower limit 13 for judgement	Set/Get	-999999999.9999 to 999999999.9999
164	Upper limit 14 for judgement	Set/Get	-999999999.9999 to 999999999.9999
165	Lower limit 14 for judgement	Set/Get	-999999999.9999 to 999999999.9999
166	Upper limit 15 for judgement	Set/Get	-999999999.9999 to 999999999.9999
167	Lower limit 15 for judgement	Set/Get	-999999999.9999 to 999999999.9999

Fieldbus Data Output

No.	Data name	Set/Get	Data range
0	Judge	Get only	0: No judgement (unmeasured) 1: Judgement result OK -1: Judgement result NG
5 to 12	Data 0 - Data 7	Get only	-2147483.648 to 2147483.647
150	Output format	Set/Get	0: Fixed point 1: Floating point

Display result

Result Display

No.	Data name	Set/Get	Data range
0	Judge	Get only	0: No judgement (unmeasured) 1: Judgement result OK

Display Image File

No.	Data name	Set/Get	Data range
0	Judge	Get only	0: No judgement (unmeasured) 1: Judgement result OK -1: Judgement result NG
120	Number of files	Set/Get	1 to 4
121	Camera No. [0]	Set/Get	0 to 3
122	Camera No. [1]	Set/Get	0 to 3
123	Camera No. [2]	Set/Get	0 to 3
124	Camera No. [3]	Set/Get	0 to 3

Display Last NG Image

No.	Data name	Set/Get	Data range
0	Judge	Get only	0: No judgement (unmeasured) 1: Judgement result OK -1: Judgement result NG
5 to 12	Judge data N (N = 0 to 7)	Set/Get	-999999999.9999 to 999999999.9999
13 to 20	Judge judge N (N = 0 to 7)	Set/Get	0: No judgement (unmeasured) 1: Judgement result OK -1: Judgement result NG
103	Reflect to overall judgement	Set/Get	0: ON 1: OFF
120	Judgement mode	Set/Get	0: One NG 1: All NG
121	Save type	Set/Get	0: Image 1: Image + data
122	Number of logging	Set/Get	1 to 4
123	Target processing unit number	Set/Get	-1 to 9999 -1: Images in own processing unit saved
124	Image memory setting flag	Set/Get	0: OFF 1: ON
140 to 147	Condition exp N (N = 0 to 7)	Set/Get	Exp character string for inclusion processing unit 0

148 to 163	Upper limit of condition calculation M (M = 0 to 15)	Set/Get	Even number is upper limit, odd number is lower limit Exp upper and lower limits for inclusion processing unit 0
	Lower limit of condition calculation M (M = 0 to 15)	Set/Get	
164 to 171	Condition comment M (M = 0 to 15)	Set/Get	Exp comment character string for inclusion processing unit 0
180 to 195	Data exp M (M = 0 to 15)	Set/Get	Exp character string for inclusion processing unit 1/2. First half is 1, second half is 2.
196 to 227	Upper limit for data calculation M (M = 0 to 15)	Set/Get	Even number is upper limit, odd number is lower limit Exp upper and lower limits for inclusion processing unit 1/2. First half is 1, second half is 2.
	Lower limit for data calculation M (M = 0 to 15)	Set/Get	
228 to 243	Data comment M (M = 0 to 15)	Set/Get	Exp comment character string for inclusion processing unit 1/2. First half is 1, second half is 2.
500 to 515	NG data [] [M] (M = 0 to 15)	Set/Get	-999999999.9999 to 999999999.9999

Appendixes

- ▶ Reference: About Lenses (p.303)
- ▶ Reference: Error Messages and Troubleshooting (p.309)
- ▶ Reference: FAQ (p.313)
- ▶ Reference: Measurement Mechanism (p.316)
- ▶ Reference: Terminology Explanations (p.325)
- ▶ Reference: Basic Knowledge about Operations (p.329)
- ▶ Reference: Setting Figures (p.335)
- ▶ Reference: About Number of Logging Images (p.346)
- ▶ Reference: About Limits on the Number of Image Input Processing Items Used (p.347)
- ▶ Reference: About Max. Number of Loading Images during Multiple Image Input (p.349)
- ▶ Reference: Character Code Table (p.350)
- ▶ Reference: Upper Limits of Processing Item Parameters (p.351)
- ▶ Reference: About Memories Usable with FZ Series (p.352)
- ▶ Reference: Memory Display Image on PLC I/O (p.353)

About Lenses

When using a camera (single), refer to the following tables to prepare the lens and extension tube. The lens may vary depending on the size of measurement objects and the camera setting distance.

Optical Diagrams

0.3 megapixel digital camera (stand-alone) FZ-S □

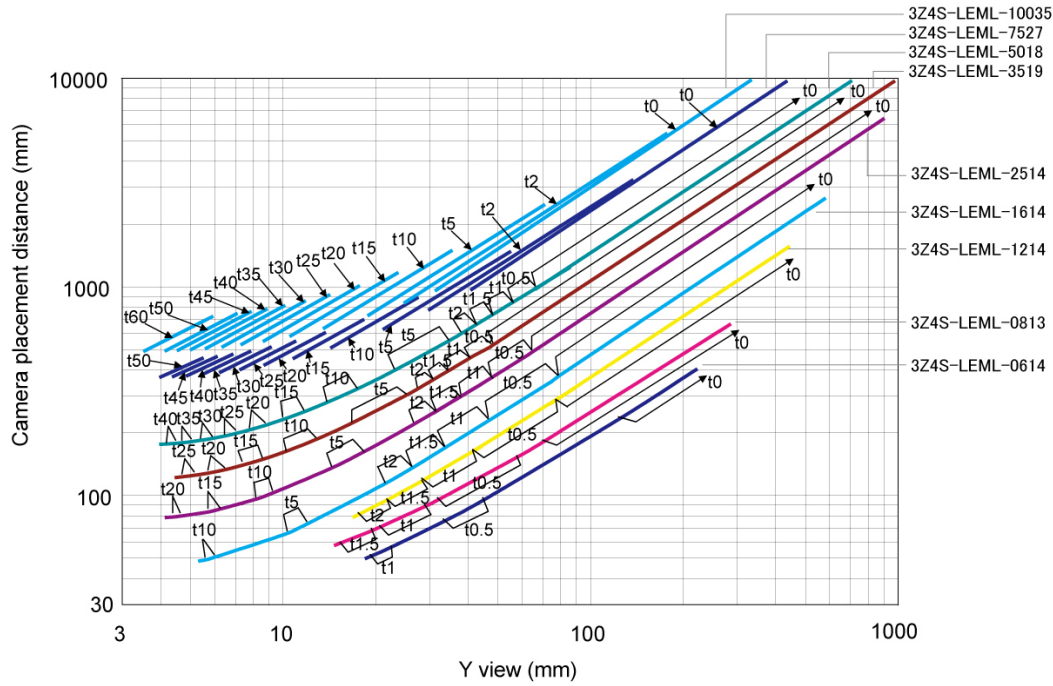

2 megapixel digital camera (stand-alone) FZ-S □ 2M

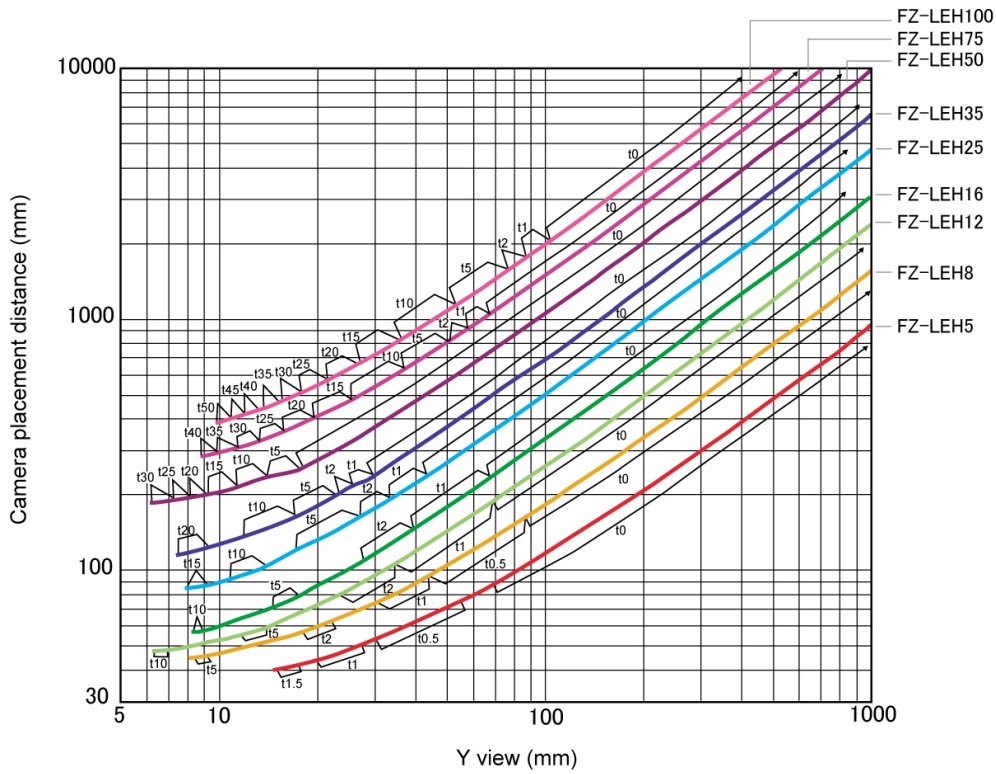

*The 5 mm extension tube (3Z4S-LE ML-EXR) cannot be connected with the FZ-LEH25.

5 megapixel digital camera (stand-alone) FZ-S □ 5M

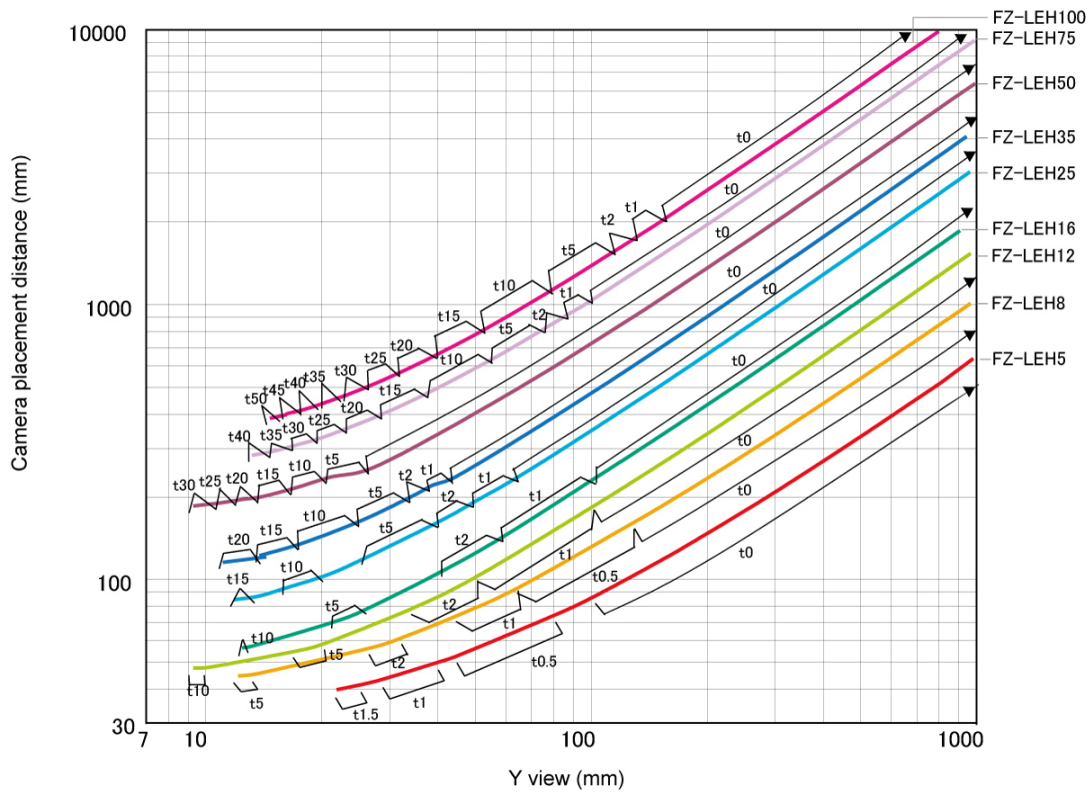
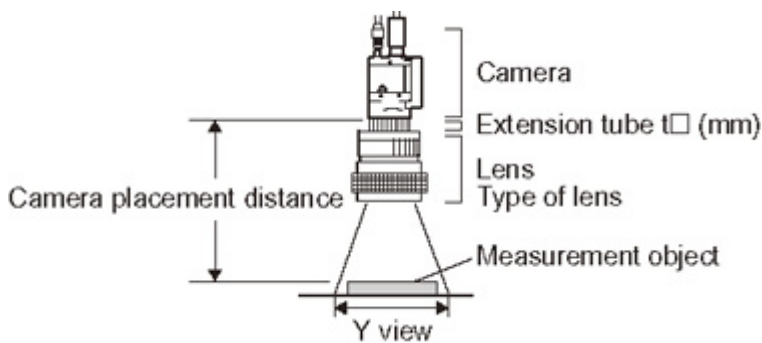

Diagram view

The horizontal axis of the diagram indicates the Y field of view (mm), and longitudinal axis indicates camera setting distance (mm). This diagram shows the relationship between the field of view of lenses and the setting distance for different types. Make sure to verify the lens type when checking the graph as the field of view value is different for each type. Points such as "t5.0" on the graph correspond to the thickness of the extension tube used. "t0" is used if an extension tube is not necessary, and "t5.0" is used if a 5 mm extension tube is used.

(Example)

If the field of view of measurement object is 40 mm, and a 3Z4S-LEML-5018 lens is used, the camera setting distance is set at 500 mm, and a 5 mm extension tube is required.



Small camera FZ-SF □ /SP □ series

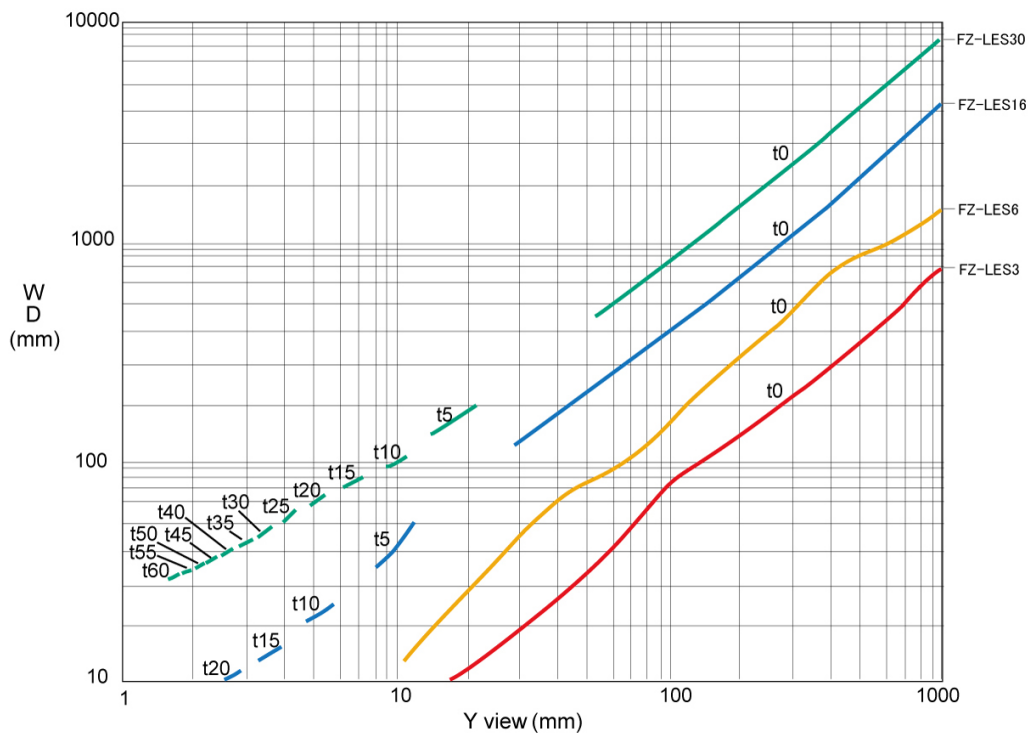
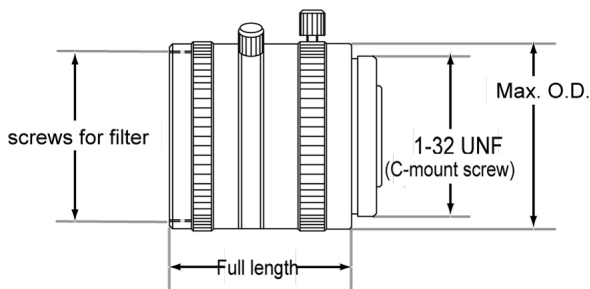

Diagram view

The horizontal axis of the diagram indicates the Y field of view (mm), and longitudinal axis indicates WD (mm). This diagram shows the relationship between the field of view of lenses and the setting distance for different types. Make sure to verify the lens type when checking the graph as the field of view value is different for each type. Points such as "t5.0" on the graph correspond to the thickness of the extension tube used. "t0" is used if an extension tube is not necessary, and "t5.0" is used if a 5 mm extension tube is used.

Lens Types and Outside Diameters



Lens 3Z4S-LE ML series

Lens type	Focal distance	Brightness	Max. O.D.	Full length	Filter size
3Z4S-LE ML0614	6 mm	F1.4	φ30 mm	30 mm	M27 P0.5
3Z4S-LE ML0813	8 mm	F1.3	φ30 mm	34.5 mm	M25.5 P0.5
3Z4S-LE ML1214	12 mm	F1.4	φ30 mm	34.5 mm	M27 P0.5
3Z4S-LE ML1614	16 mm	F1.4	φ30 mm	24.5 mm	M27 P0.5
3Z4S-LE ML2514	25 mm	F1.4	φ30 mm	24.5 mm	M27 P0.5
3Z4S-LE ML3519	35 mm	F1.9	φ30 mm	29 mm	M27 P0.5
3Z4S-LE ML5018	50 mm	F1.8	φ32 mm	37 mm	M30.5 P0.5
3Z4S-LE ML7527	75 mm	F2.7	φ32 mm	42.5 mm	M30.5 P0.5
3Z4S-LE ML10035	100 mm	F3.5	φ32 mm	43.9 mm	M30.5 P0.5

High resolution and low distortion lens Model FZ-LEHx series

Lens type	Focal distance	Brightness	Max. O.D.	Full length	Filter size
FZ-LEH5	5 mm	F2.8	φ42 mm	38.7 mm	M40.5 P0.5
FZ-LEH8	8 mm	F1.4	φ34 mm	41.6 mm	M27.0 P0.5
FZ-LEH12	12 mm	F1.4	φ34 mm	37.0 mm	M27.0 P0.5
FZ-LEH16	16 mm	F1.4	φ33 mm	36.5 mm	M27.0 P0.5
FZ-LEH25	25 mm	F1.4	φ33 mm	39.5 mm	M27.0 P0.5
FZ-LEH35	35 mm	F2	φ34 mm	36.5 mm	M27.0 P0.5
FZ-LEH50	50 mm	F2.8	φ34 mm	55.0 mm	M27.0 P0.5
FZ-LEH75	75 mm	F2.5	φ36 mm	51.0 mm	M34.0 P0.5
FZ-LEH100	100 mm	F2.8	φ50 mm	70.0 mm	M40.5 P0.5

Lens for small digital cameras FZ-LESx series

Lens type	Focal distance	Brightness	Max. O.D.	Full length L
FZ-LES3	3 mm	F2.0	φ12 mm	16.4 mm
FZ-LES6	6 mm	F2.0	φ12 mm	19.7 mm
FZ-LES16	16 mm	F3.4	φ12 mm	23.1 mm
FZ-LES30	30 mm	F3.4	φ12 mm	25.5 mm

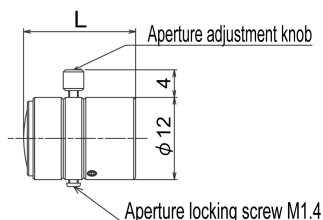

Extension Tube

An extension tube, which is installed between lens and camera, is used to adjust focal distance. Different combinations of the 7 tubes can be used to achieve any desired thickness.

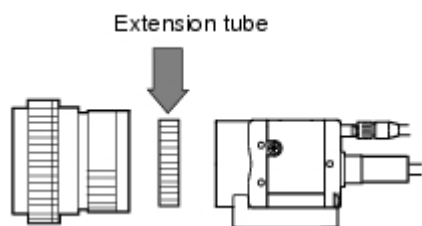

Max. O.D.	Thickness						
	Thickness:40mm	20mm	10mm	5mm	2mm	1mm	0.5mm
φ30	 7sets						

Extension tubes for small digital cameras FZ-LESR

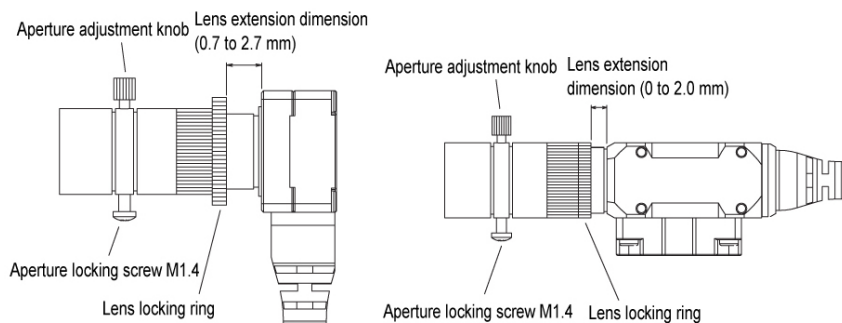

Max. O.D.	Thickness
φ12	<p style="text-align: center;">3-piece set</p>



Note



- Do not overlap the 0.5 mm, 1.0 mm and 2.0 mm extension tubes. Since these lenses are installed between the lens and the threaded section of another extension tube, overlapping of 2 or more of these tubes will cause unstable fixation.
- When a close-up exceeds 30 mm, reinforcement is necessary depending on the amount of vibration.

Error Messages and Troubleshooting

This section lists error messages that display on the screen and solutions.

 **ERR** When a message with this symbol is displayed, the ERROR signal on the parallel interface is on.

Error message	Remedy
No value set. Please set value.	A value must be set for this item. Please set up value.
Error of the expression.	Do the following errors exist in settings for an expression set up? <ul style="list-style-type: none"> • Different number of open/close parentheses • TJG/unit/value/function/operator/comma is lined next to each other. • Operator is set at beginning or end of expression • The number of function operands is insufficient or there are more than is needed
Cannot add object. Out of range of specified characters of expression.	Incompliant to the conditions of expression. Please check the content. Reference: ▶ "Processing Item List Manual", "Setting (Calculation)" (p.338)
The problem occurred in the camera connection.  ERR	Is the camera cable connected to the controller? Is camera cable disconnected? Do [Select camera] of [Camera Image Input] and [Camera Switching] have any errors? Please check the contents of [Camera setting], then switch off and restart. Reference: ▶ Setting Conditions for Camera Use (p.128)
Failed to start the window. Memory is insufficient.	Because memory available for use was insufficient, memory needed to open the window could not be secured. Check the flow by adjusting the measurement region of each processing unit and the sizes of the registered models. <ul style="list-style-type: none"> • [Shape search] If shape search+ setup window is opened while the RAMDisk memory is insufficient for image logging, etc. on the RAMDisk, a warning message is displayed. In the case that an image logging file is stored in a RAMDisk, please move the content on the RAMDisk to a USBDisk to open up memory and reopen the set up window.
Warning range shall be set within the range from judgement lower to upper limit.	Please redefine the upper and lower warning range limits such that they are within the range between the lower and upper evaluation limits. Reference: ▶ "Processing Item List Manual", "Judgement conditions (Trend Monitor)" (p.378)
The "Search" measurement result may be "NG (Insufficient memory)" with the current setting.	Insufficient memory may occur during measurement. Reset the model parameters. <ul style="list-style-type: none"> • [Search] Reference: ▶ "Processing Item List Manual", "Judgement is NG (Insufficient Memory)" (p.57) • [Flexible search] Reference: ▶ "Processing Item List Manual", "Judgement is NG (Insufficient Memory)" (p.66) • [Classification] Reference: ▶ "Processing Item List Manual", "Judgement is NG (Insufficient Memory)" (p.118)
The problem occurred in the system.  ERR	This is displayed when the significant abnormality occurs in the controller system. Please contact one of our branches or regional offices.
The problem occurred in system date. The system battery is insufficient.  ERR	Low battery (for the backup of date and time data) level. The batteries need to be replaced. Please return old batteries to one of our branches or regional offices.
Failed to switch scene	Is a USBDisk set to the controller? A USBDisk is needed to read scenes after scene group 1.

Failed to switch scene group or save scene group on switch.	The cause of the failure to switch or to save when switching may be that the USBDisk was removed from the controller. Set a USBDisk to the controller and try again.
Failed to clear scene group.	Confirm that a USBDisk is set to the controller and try again.
Failed to load scene group. Data is corrupted, or memory is insufficient. Scene group data starts with initialized status.	The following causes are suspected: <ul style="list-style-type: none"> • The power may have been cut off during the last data save. • Because the operation mode was switched, the required memory size may have increased and memory became insufficient.
The camera connected is not the same as the one used for the last save. Please check.	Check if the camera is connected correctly. This message is displayed when the system and the scene group 0 data edited using the simulation software are loaded and the unit is restarted. Save the setting to the controller and then restart.
Cannot read selected file. Confirm selected file once again.	Check the following points. <ul style="list-style-type: none"> • Have you removed the USBDisk from the controller after selecting files on the USBDisk? • Have you deleted the selected file? (Such as the case when you selected a file on the RAMDisk and the file was deleted via FTP.) In addition, the selected file may be corrupt.
The communication time-out is occurred. 	Switch off controller, verify the following contents and then restart. <ul style="list-style-type: none"> • Is cable connected correctly? • Does it comply with communication specifications of external devices? • Are external devices functioning normally? If error is not resolved after confirmation, the controller may be damaged. Please discuss this with one of our branches or regional offices. Reference: ▶ Setting Communication Specifications (RS-232C/422-PLC Link) (p.157) Reference: ▶ Setting Communication Specifications (RS-232C/422 - Non-procedure) (p.183)
Failed to transfer data. The free capacity of RAMDisk may insufficient Increase the free capacity of RAMDisk and then perform this operation again.	Clean up the content of RAMDisk to increase free space. If this error occurs even though enough free space is available, scene group data may be too large. Review the inspection flow.
Error in input range. Please input using the correct range.	Please verify range for setting and set up again.
File name contains invalid character.	Please confirm that characters such as ¥ / , : ; * ? " < > & . SPC (space) are not included in the file name.
Failed to save file. Please check.	Check the following points. <ul style="list-style-type: none"> • Is the memory of the save destination sufficient? • For cases where the save destination is the folder in the USBDisk, is the USBDisk connected to the controller? Or, the controller may not have detected the USBDisk.
Fan/voltage error. 	Switch off controller, and verify if fan is affected. If error message is still shown after restart, the controller may be damaged. Please contact one of our branches or regional offices.
Procltem error xxxx: xxxxerror	This is displayed when the application software detects an abnormality. Please contact one of our branches or regional offices as there may be a software trouble.

<p>Failed to paste. Please check the save source or the save destination.</p>	<p>No more scene can be added due to lack of memory. ※ Review the inspection flow and reduce the memory consumption or switch to another scene group. *) The display varies depending on the controller. The remaining capacity of the application is not sufficient for the FZ3-9 □ □ series. The remaining data memory capacity is not sufficient for the FZ3-L35 □ /3 □ □ /7 □ □ series.</p>														
<p>A camera outside the guarantee is connected.</p>	<p>A camera outside the guarantee is connected to the controller currently being used.</p>														
<p>Destination folder is not found. Please check.</p>	<p>Check the following points. <ul style="list-style-type: none"> • Have you deleted the destination folder? • For cases where the save destination is the folder in the USBDisk, is the USBDisk connected to the controller? Or, has the USBDisk been detected? </p>														
<p>PLC link error</p>	<p>PLC link cannot be established. Check the following points. <ul style="list-style-type: none"> • Are the FZ communication settings correct? • Are the PLC communication settings correct? • Is cable connected correctly? </p>														
<p>Cannot perform model registration.</p>	<p>Search, classification and flexible search Please register higher-contrast images as models. Fine matching For the fine matching, the 2 pixels at the edge of the image cannot be registered as the model.</p>														
<p>Available memory is insufficient. It may cause insufficient memory depending on the setting.</p>	<p>Available application memory is low. Memory may become insufficient during operation or an error may occur when the operation mode is switched. Review the inspection flow and reduce the memory consumption.</p>														
<p>The free capacity of RAMDisk is insufficient. If nothing is done, measurement cannot be performed correctly. Increase free capacity in RAMDisk.</p>	<p>Clean up the content of RAMDisk to increase free space. If this error occurs even though enough free space is available, scene group data may be too large. Review the inspection flow.</p>														
<p>Region size exceeds. Please narrow region.</p>	<p>There are restrictions as to what can be set up based on the camera and processing items being used. Please adjust the region size so that the region is not too large.</p> <table border="1" data-bbox="443 1541 1412 1765"> <thead> <tr> <th>Processing item</th> <th>Region type</th> <th>Region size (number of pixels)</th> </tr> </thead> <tbody> <tr> <td rowspan="2">Shape search+</td> <td>Measurement regions</td> <td>5003712</td> </tr> <tr> <td>Model region</td> <td>995328</td> </tr> <tr> <td>Barcodes+</td> <td>Measurement regions</td> <td>1920000</td> </tr> <tr> <td>2D codes+</td> <td>Measurement regions</td> <td>1920000</td> </tr> </tbody> </table>	Processing item	Region type	Region size (number of pixels)	Shape search+	Measurement regions	5003712	Model region	995328	Barcodes+	Measurement regions	1920000	2D codes+	Measurement regions	1920000
Processing item	Region type	Region size (number of pixels)													
Shape search+	Measurement regions	5003712													
	Model region	995328													
Barcodes+	Measurement regions	1920000													
2D codes+	Measurement regions	1920000													
<p>Logging error</p>	<p>Image logging failed due to insufficient memory at the save destination. The error message disappears after 10 s. Please delete unneeded files in the save destination or prepare a new USBDisk.</p>														

The Logon to Network Server screen is displayed.	The connection was cut off based on the idling/session time set on the network logging destination PC. At the command prompt on the PC, enter net config server /autodisconnect:-1, and disable the automatic disconnection setting.
--	---

Although an error message such as the following, is not displayed, the ERROR signal and the ERR indicator will turn ON.

Cause	Remedy
The STEP signal was input when the READY signal was turned OFF.	<ul style="list-style-type: none"> Input the STEP signal after the READY signal turns ON. Check to make sure that no chattering has occurred in the STEP signal. Noise is superimposed onto the STEP signal. Keep PLC and FZ3 away from the noise source.
A non-existing parallel command was entered.	<ul style="list-style-type: none"> Please enter a correct parallel command.
The parallel scene group switch command was executed when no USB memory was installed. (FZ3-L35 □ /FZ3-3 □ □ /FZ3-7 □ □ only)	<ul style="list-style-type: none"> Switch the scene group with the USB memory installed.



During Start-up

POWER LCD is not lit

- Is the power supply connected correctly?
- Is the supply voltage low (24 V DC +10%, -15%)?

Nothing is displayed on the monitor

- Is the monitor ON?
- Is the monitor cable connected correctly?
- Has the monitor failed?
- Is the power capacity enough (LCD monitor)?
- Have you turned off the LCD? If you have, the monitor recovery will occur if you tap on the bottom of the monitor.

Monitor images are disordered

- Are the power supply and cable generating electronic noise?
- Is the monitor cable connected correctly?

Input cannot be made

- Are the cables for input devices (mouse, etc) connected correctly?
- Is the angle too big when tapping is done with the touch pen?

Camera image does not display/Image is blurry

- Is the lens cap removed?
- Is the camera cable connected correctly?
- Is the lens aperture the maximum or the minimum?
- Is the camera's shutter speed correct?
- Is the lighting method correct?

Start-up is slow

- Was the system connected to a LAN when started?
If the system is started while connected to a LAN, startup may take a longer time.

During Operation

Measurement results do not display on the monitor

- Are windows other than the Main screen (the Edit Flow window, etc) displayed?
- Are any setting windows open?
* A setting window is defined to be a window that opens separately such as the Edit Flow window and the Scene Maintenance window.

The touch screen responds slowly

- Are you tapping the touch screen continuously and quickly? If yes, the response to operation may be delayed.

"NG (memory shortage)" is displayed in the "Detail result" area

- Does the number of specific processing items, such as camera image input, exceed the limit?
Reference: ▶ About Limits on the Number of Image Input Processing Items Used (p.347)

In the [Image view setting] of the "Control" area, "Image mode", "Positions" and "Sub image" can not be changed.

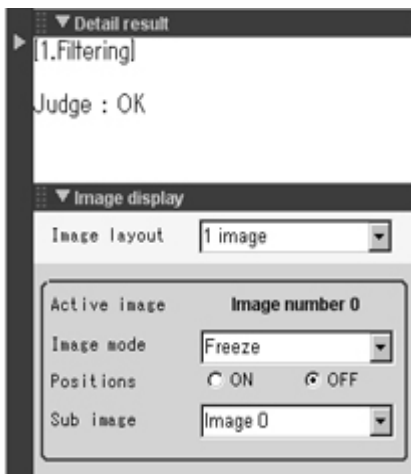

- Is the "Detail result" area active?
Reference: ▶ Displaying Flow and Detailed Results (p.87)

Data cannot be saved

- The data save may have failed because there was not enough free capacity in the flash memory in the controller. The current scene group data in the controller memory is destroyed after the restart. Immediately perform one of the recovery/avoidance procedures specified below.
 - For example, reduce the memory usage and then save data again to the controller, delete scenes, delete processing units, adjust the processing unit measurement area, or adjust the sizes of registered models.
 - Evacuate the current scene group data to a USB memory.
Tap [Data] menu - [Save to file] - [Setting data] - [Scene group data].

For Measurement

Display is not updated.

- Measurement is given priority when the STEP signal input interval is short or continuous measurement is being performed. As a result, the measurement results (overall judgment, image, individual judgment in the flow display, detailed results) may not be updated. When continuous measurement ends, the measurement results for the final measurement are displayed.

About Parallel Interface

Trigger signal (input signal) not accepted

- Are the cables connected correctly?
- Is the signal cable disconnected?
You can check the communication status in the Confirmation window.
Reference: ▶ Checking Communication Status (Parallel Interface) (p.223)
- Are windows other than the Main screen (the Edit Flow window, etc.) displayed?
- Are there any setting windows open?
* A setting window is defined as a window that opens separately such as the Edit Flow window and the Scene Maintenance window.

Signals cannot be output to external devices

- Is the trigger signal input?
- Are the cables connected correctly?
- Is the signal cable disconnected?
You can check the communication status in the Confirmation window.
Reference: ▶ Checking Communication Status (Parallel Interface) (p.223)
- Is test measurement being performed?
Data cannot be output to external devices during test measurement.

About Serial Interface (RS-232C/422 Connection)

No communication available

- Are the cables connected correctly?
- Are the communication specifications of the external devices compatible with the controller?
You can check the communication status in the Confirmation window.
Reference: ▶ Checking Communication Status (Non-procedure) (p.184)

The controller works fine initially, but there is not response after a while

- Is the buffer memory of the PC full?
Please verify if data can be received correctly based on current settings.

Data cannot be saved

- Are the communication specifications of the external devices compatible with the controller?
- Is "Flow control" in communication specifications set to "None"?
To save data, set "Flow control" to "None".
Reference: ▶ Setting Communication Specifications (RS-232C/422-PLC Link) (p.157)
Reference: ▶ Setting Communication Specifications (RS-232C/422 - Non-procedure) (p.183)

Measurement Mechanism

This section describes how to configure measurement in accordance with the images acquired from cameras.

This product is prepared with comprehensive processing capabilities for measuring items. Common processes for various processing items are described here.

Color Processing Mechanism

The images acquired from cameras are available with color information such as R(red)/G(green)/B(blue). RGB images can render 16.7 million colors on the screen, and adjustment of color intensity with a range of 0 to 255 can be performed.

For each of RGB, black is rendered with a 0 value and white is rendered with a 255 value.

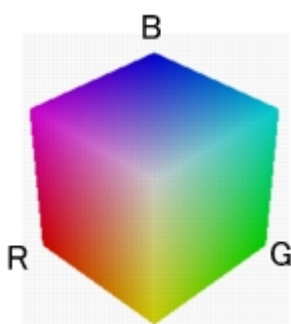

During measurement of color images, many colors can be measured by adjusting the RGB values.

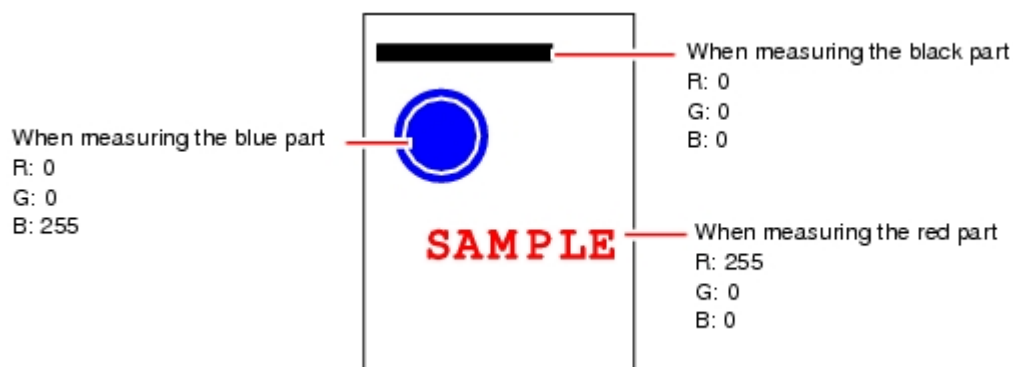

Note

- For monochrome cameras, color processing is not performed.

Search Processing Mechanism

Reference image patterns are registered as models and then search is performed using the parts of input images that most resemble the models. The degree of similarity is represented with a correlation value, and inspection for defects and different parts being mixed in can be performed.

The search process is performed over several distinct stages.

1. Register a reference model.

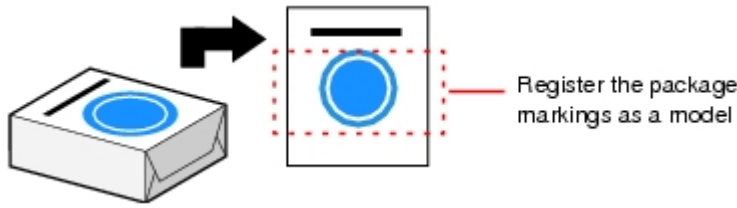

Note

Model Status and Measurement Processing

- Measurement time and accuracy may be affected by the status of model in the following ways. Please select measurement objects that are in good condition (clean) for Model Registration.
 - In the case of large or complicated models, processing time is prolonged.
 - With extremely small models or models without features, search processing is unstable.

2. Perform rough search of overall measurement region.
Search for the model over the entire measurement region.

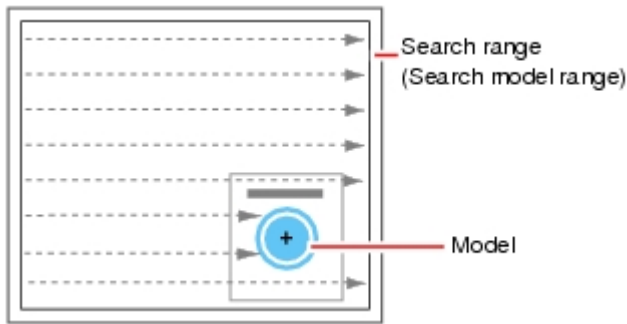

3. Perform additional searching near the model.

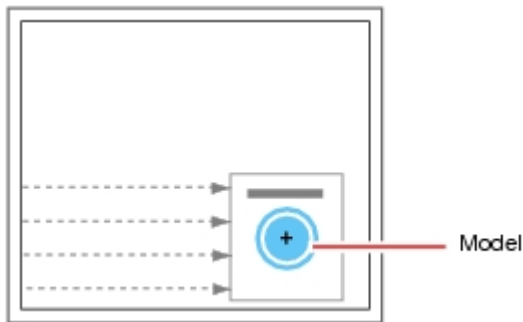

Search Detection Method

With search processing, there are two types of detection methods: Search by "Correlation (CR)" and search by "Shape (PT)".

The detection method can be selected by changing the "Rotation" settings for each processing item.

Setting item	Description
CR	Measurement for locations where there is high correlation (similar areas) between the color of the model registration image and the input image is performed. Since brightness is normalized in this operation, changes in brightness do not affect searching for correct positions.

PT	<p>Measurement for locations where there is a high degree of similarity between the shape of the model registration image and the input image is performed. Since measurement is based on shape consistency (profile of model), positions can be measured accurately even if portions of the model are missing in images.</p> <p>When the rotation angle range is wide (such as full angle), a search that is faster than a "CR" search can be performed. Note, however, that this method may be less reliable than a "CR" search if the image has low contrast or blurred edges.</p>
----	---

Note

Basic selection flow

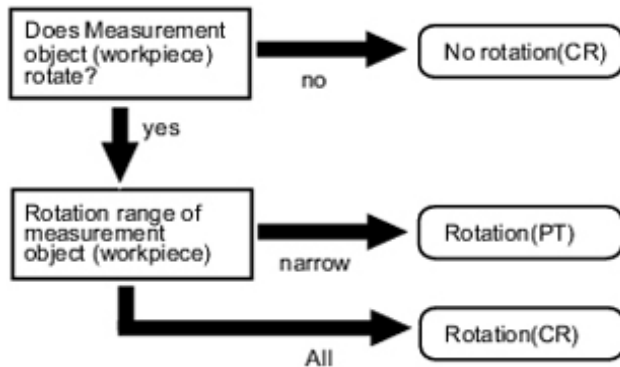

Search Speed

For processing items to perform search processing such as [Search] and [Classification], you can specify the search processing speed by through the model parameter items "Stab.", "Prec.", and/or "Skipping angle". If the value specified for "Stab." or "Prec." is small or if the value for "Skipping angle" is large, the processing speed can be increased since the amount of information for the models will be decreased during the search. In contrast, if the values specified for "Stab." or "Prec." are large or if the value for "Skipping angle" is small, the processing speed is slow because search is performed without the amount of model information being reduced. Specify appropriate values for "Stab.", "Prec.", and "Skipping angle" according to the measurement conditions.

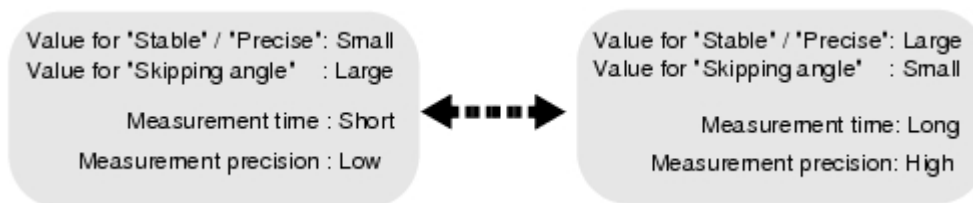

Correlation value

With processing items that use search processing, judgement is performed through correlation values. Correlation values are used to check the consistency (degree of similarity) between actual measurement images and reference model images. If portions of a measured image are missing or if shapes are

different, the correlation value is lower.

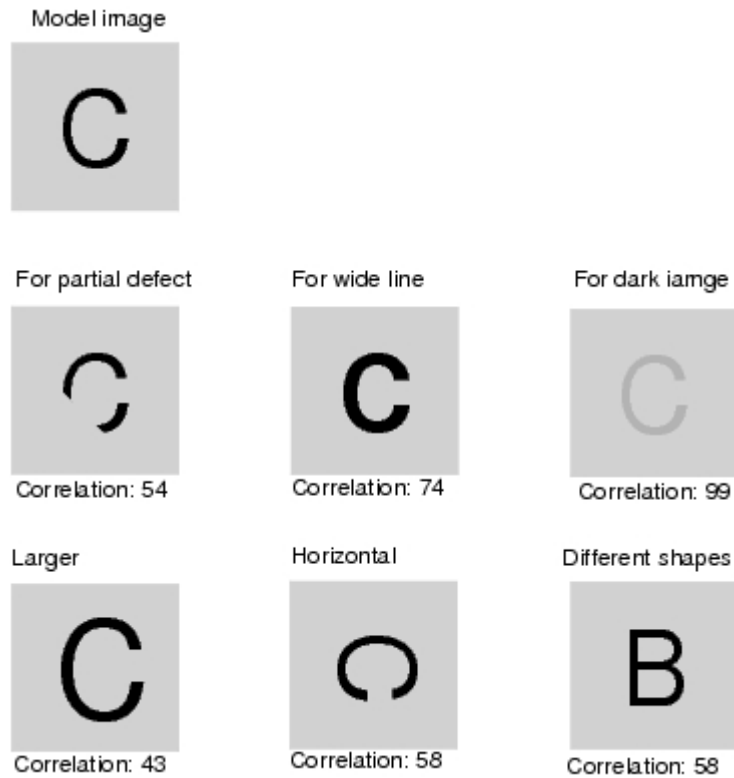

Search Angle Range, Skipping Angle

These are values, based on the model registration image, that indicate the allowable rotation interval (skipping angle) and overall maximum rotation range for the model (angle range). Search is performed for objects that most resemble these acceptable models.

Example: When angle range is 15° and skipping angle is 5°

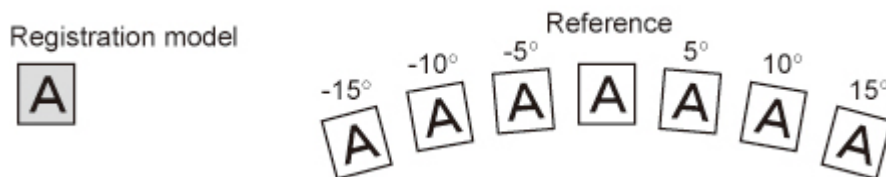

Candidate Point Level

This is the level used for finding models when searching. Images with a correlation value higher than the candidate point level are used to establish candidate points for search inspection.

Roughly search within the search region for candidate points.

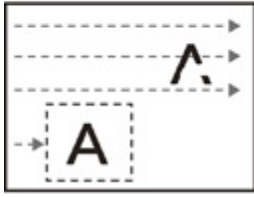

Perform detailed searches in the areas around each candidate point.

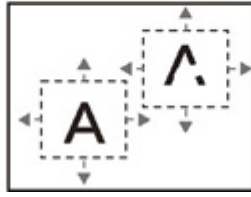

Edge Detection Measurement

This method extracts parts with color changes as edges to perform measurement. Edges are found through color changes in the measurement region.

It finds edges using color changes in the measurement region.

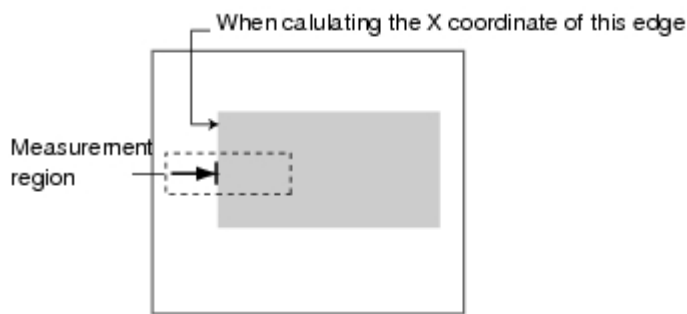

Edge Level

Indicates the edge color change level (degree of color difference). This level is adjusted if edges cannot be accurately detected.

Note

- The value 0 to 100 for the edge level indicates the edge intensity. It is not related to color differences in the original image.

For case of measurement using relative position (%) with regards to width of color difference

The edges are detected in the following manner.

1. Calculate the overall distribution of color difference in the measurement region.
2. Min. color difference value: 0%; Max. color difference value: 100%
3. Locations in which there is an edge level color difference are detected as edges.

Edge Position

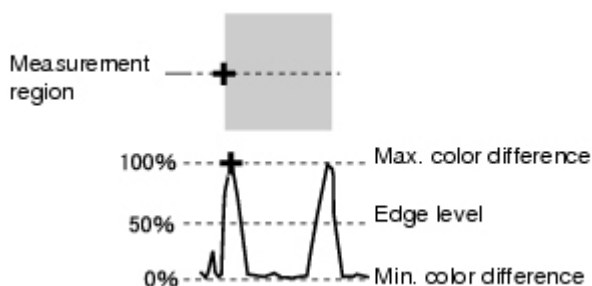

Edge Pitch

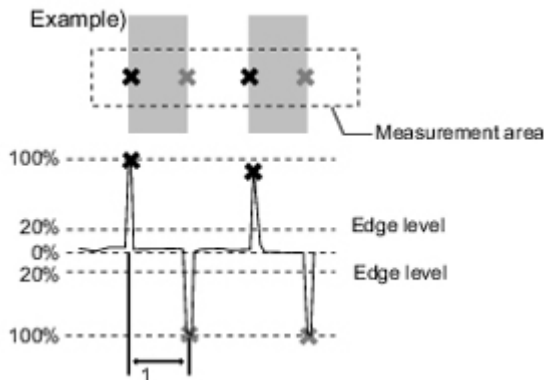

When performing measurement using color difference value

Edge level is set using color difference absolute value.

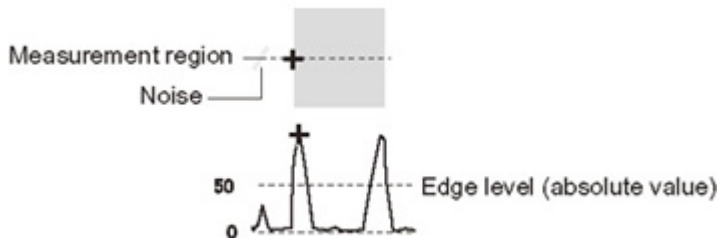

Noise Level

This level judges whether an edge is present or not.

The maximum value and minimum value for color difference in the edge detection area are determined and if the difference is less than the noise level, it is judged that there is no edge. When detection is affected by noise, increase this value.

(within area)

Maximum value - minimum value of color difference < noise level - edge does not exist - measurement result is fail

Maximum value - minimum value of color difference > = Noise level - edge exists - targeted for measurement

Example: When noise level is set to 30

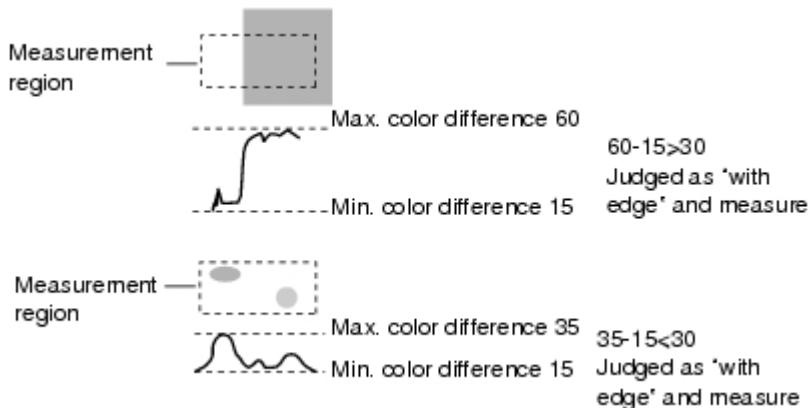

Noise Width

Set the width for judging noise.

- When no color is specified
If another edge is detected within the width range starting from the point where an edge was first detected, the newly detected point is considered noise.
- When a color is specified
If the color difference distributions again falls below the edge level within the width range starting from the point where an edge was first detected, the newly detected point is considered noise.

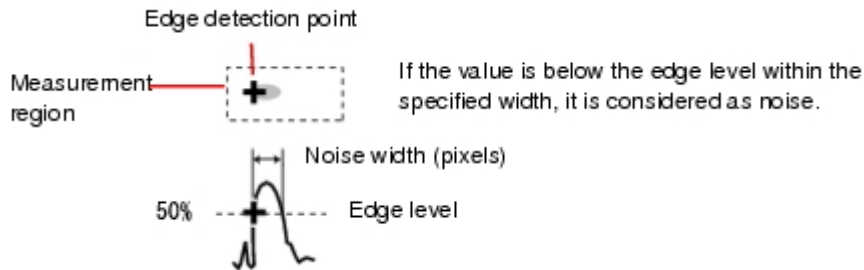

When points are mistakenly detected as edges due to noise, increase the color difference value.

Defect Detection Measurement

Color changes within the measurement region are used to find defects such as scratches, contamination, and chipping.

After measurement region is drawn, a rectangle (defect detection region) is automatically formed in this region. While moving the defect detection region around, calculate average density for each area to determine the difference between the original area and the surrounding area. This difference is called the defect level. Calculate the defect level for all defect detection areas. If the maximum value exceeds the judgement value, it is judged that there are defects in the measurement region.

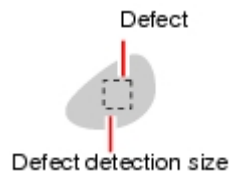

Increasing "Defect size" allows for shortening of processing time, but this will reduce measurement accuracy.

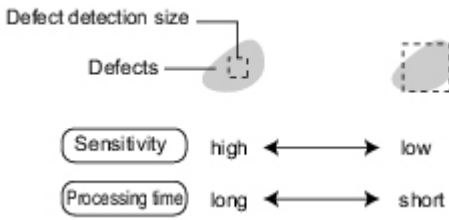
Setting item	Description
Upper Lower	<p>Specify the upper and lower limits of defect detection size based on the size of scratch or contamination to be detected.</p> <p>The larger the difference between upper and lower limits, the easier it is to detect scratches or contamination of various sizes.</p> <p>For both upper and lower limits, higher values for defect detection size limits leads to weaker detection sensitivity and shorter processing time.</p>  <p>The diagram illustrates the relationship between defect detection size limits and system performance. It shows two defect shapes: a small one on the left and a larger one on the right. Below them, two horizontal double-headed arrows indicate the range of sensitivity and processing time. The top arrow is labeled 'Sensitivity' with 'high' on the left and 'low' on the right. The bottom arrow is labeled 'Processing time' with 'long' on the left and 'short' on the right. This indicates that as the defect size increases, sensitivity decreases and processing time becomes shorter.</p>

Handling Coordinates

The processing items for measuring positions have a setting item called "Output parameter" with which you can select how to handle coordinates.

In "Output parameter", you can set "Output coordinates" or "Calibration".

Output Coordinates

Select coordinate types to be output to external devices.

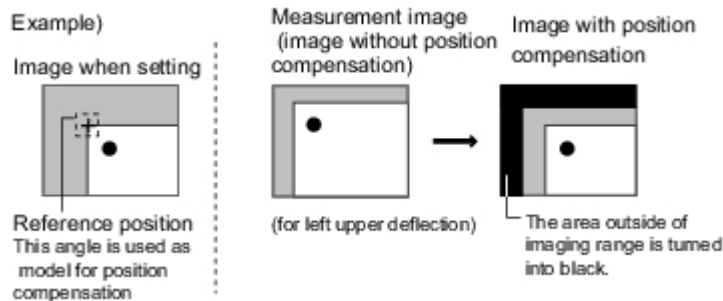

Before position compensation

Coordinate values before position compensation are output.

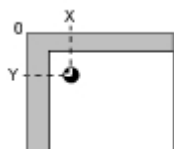

After position compensation (with factory settings)

Coordinate values after position compensation are output.

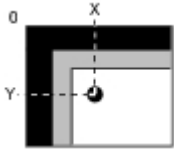

Calibration

Select whether or not to perform calibration when selecting output to external devices.

Reference: ▶ Calibration (p.326)

Calibration: ON

Calibration is performed during output and measured values after calibration are output.

Calibration: OFF

Calibration is not performed during output, and coordinate values from camera images are output.

Terminology Explanations

This section gives descriptions of terms.

Position compensation

When the location and direction of measured objects are not fixed, the positional deviation between reference position and current position is calculated and measurement is performed after correcting. Please select processing items that are appropriate to the measurement object from processing items that are related to position compensation.

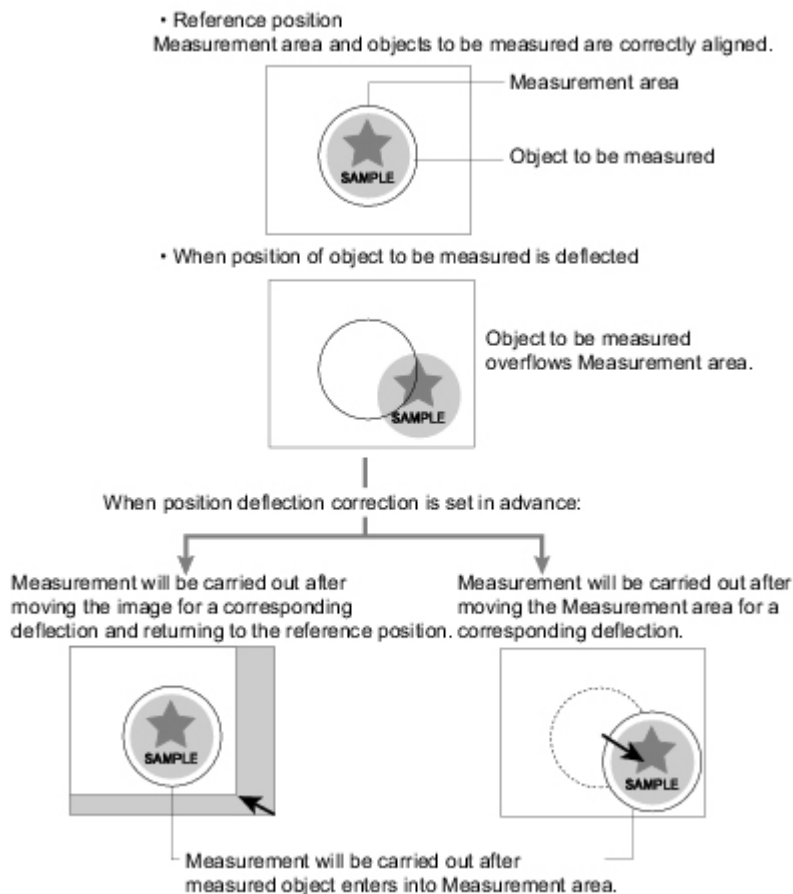

Intelligent camera (with lighting function)

Cameras with a dome-shaped light can also be controlled with the controller. This is beneficial when the effects of ambient light are to be avoided and when it is desirable to shorten the lighting setting time. For details, see Reference: ▶ "Intelligent Camera (with Lighting Function)" (p.24) .

Reference position

The point that is always the reference. If the location of the registered model is different from the reference position, the setting should be changed in [Ref. position].

Calibration

This refers to conversion of measured pixel unit dimensions to actual dimensions. Setting the relationship between actual coordinates and camera coordinates enables conversion of measurement results in pixel units to actual dimensions.

To output measured values converted by calibration to external devices, set "Calibration" in "Output parameter" of each unit to "ON".

For example, in the case of an object that measures 20 mm wide and has a 200-pixel width in the measured image, calibration is performed as follows.

$$20 \text{ (mm)} / 200 \text{ (pixel)} = 0.1 \text{ (mm/pixel)}$$

In other words, 1 pixel (pix) in the camera coordinates corresponds to 0.1 mm in actual size.

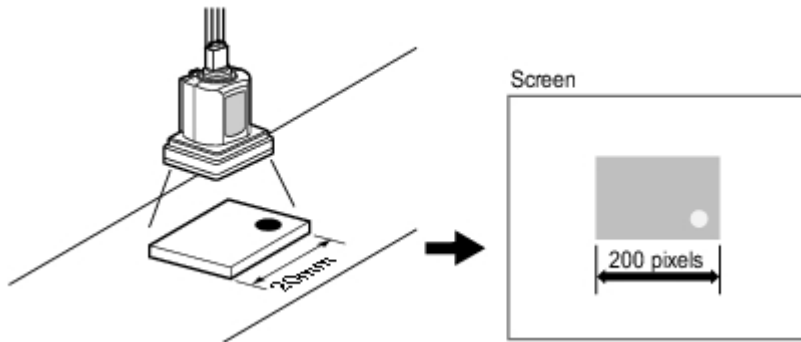

Measurement flow

A measurement processing series is called a measurement flow. You can combine processing items to create measurement flows.

Detection point

This is the point that specifies the coordinates of which part of the model are to be output by the search and ECM search processing item. The initial value is at the center of a model.

Candidate

With regards to search based processing items (search, flexible search, ECM search, classification, character inspection, model dictionary), both a rough search, which is a search over the entirety of the measurement region, and a detailed search, which is a search in areas of the rough search where correlation was high are performed. The candidate point is the point at which an area becomes a candidate for "Detail search". The candidate point level represents the rough search correlation value. If stable search of a model is not possible, set the candidate point level lower.

Sub-pixel

Points that are formed finer than pixels. In the case of search processing, if sub-pixel processing is turned on for measurement parameters, interpolation measurement is performed using sub-pixel units.

Scene

Measurement processing that is created with a combination of units. Preparing a scene for each measurement object or measurement content makes it easy to change measurements.

Reference: ▶ What Is a Scene? (p.42)

Scene group

32 units are incorporated into a scene for sorted measurement. This is convenient for managing scenes on a per category basis.

Reference: ▶ What Is a Scene Group? (p.46)

Center of gravity

The images with white pixels are cut into paper of a certain thickness, and when one point is used to support the paper, the point which enables the paper to balance is called the center of gravity. The center of gravity of a circular object is the center of the circle, the center of gravity of a rectangle is the intersection of two diagonal lines.

Processing item

Single units that constitute measurement processing. Scenes (measurement flow) are created by registering processing items in units.

Processing unit

A unit that constitutes measurement processing. Scenes (measurement flow) are created by setting processing items in processing units.

Reference: ▶ Creating a Scene (p.47)

Correlation value

0 to 100 are used to represent the degree of similarity with an acceptable object. Namely, higher values indicate higher degrees of similarity.

Flow control

If the processing speed of the receiving side is slower than that of the sending side when data is being transferred, the receiving side will send interruption commands to the sending side or send re-admittance commands and then adjust the transmission speed.

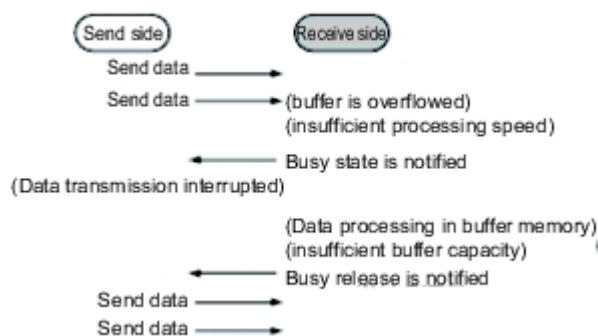

There are two flow control methods: "Hardware Flow Control" and "Software Flow Control". With this product, "Software Flow Control" is used to adjust transmission speed.

Model

The image pattern that serves as the inspection target. Characteristics portions are extracted from images of the object and registered as model registration.

Unit

Reference: ▶ Processing unit (p.327)

2's complement

Binary numbers are generally used to represent negative numbers.

Negative numbers are expressed by "Inverting all bits of a positive number and adding 1 to the result".

(Example) "-1" is expressed as 2's complement

"-1" can be calculated by "0-1".

$$\begin{array}{r} \text{(In the case of 1, minus 1)} \\ \text{00000000 (= 0)} \\ -) \text{00000001 (= 1)} \\ \hline \text{11111111 (= -1)} \end{array} \leftarrow \text{"1" is expressed with 2's Complement (for 8 bits)}$$

There are methods for simple calculation without performing this kind of computation.

For instance, "Negative number = inverting all bits of a positive number and then adding 1 to the result".

$$\begin{array}{r} \text{00000001 (= 1)} \\ \downarrow \text{Invert all bits} \\ \text{11111110} \\ \downarrow \text{Plus 1} \\ \text{11111111 (= -1)} \end{array}$$

The first digit is used to judge whether the number is positive or negative.

- When 0: Positive number (or 0)
- When 1: Negative number

The advantage of two's complement numbers is that positive and negative numbers can be used as is in calculations.

(Example) When $-1+10=9$

$$\begin{array}{r} \text{11111111 (= -1)} \\ +) \text{00001010 (= 10)} \\ \hline \text{00001001 (= 9)} \end{array}$$

Basic Knowledge about Operations

Inputting Values

This section describes how to input values required for setting the judgement conditions and communication specifications. Methods for setting up values include the following, depending on the settings.

- Specify values directly with the numeric keyboard
This is used for input of specific values.
- Set numerical values by dragging the slider
Setting values can be done by dragging the slider on the screen.

The method for displaying the numeric keyboard and setting values is explained here. For other methods, refer to individual setting descriptions.

1. Tap [...] in the item in which a value is to be set.



The numeric keyboard is displayed.

2. Tap the numeric keys to input values.



The numerical value is input.

3. Tap [OK].
This verifies the value and closes the numeric keyboard.

Inputting Text

This section describes methods for inputting file names and descriptive text.

The following software keyboard is displayed in the window for inputting text.

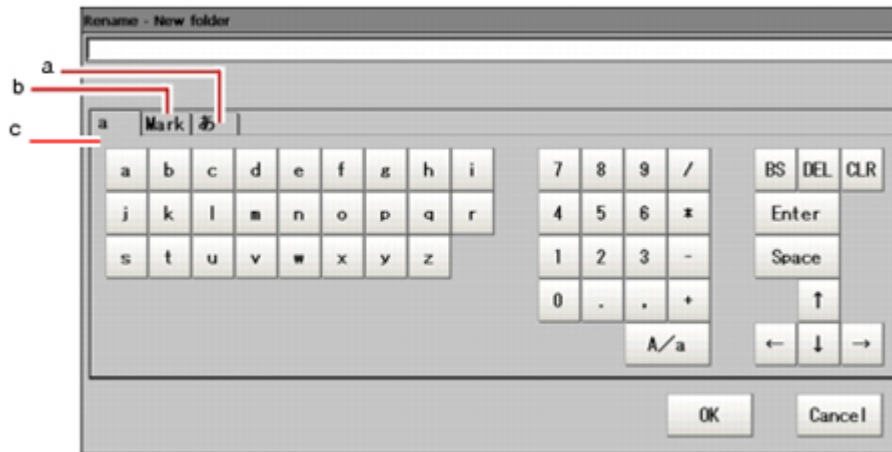

a. Japanese Input Mode

Japanese is input using kana input.

To toggle between uppercase and lowercase mode, tap [A/a].

b. Symbol (one-byte characters input mode)

c. a (Alphanumeric Input Mode)

To switch between uppercase and lowercase mode, tap "A/a". The default state is lowercase input mode.

Operation Method

1. Tap [...] in the item in which a character string is to be set.



The soft keyboard is displayed.

2. Switch the tabs as needed and tap the character that is to be input.
3. Tap [OK] after text has been entered.
The software keyboard is closed.

Selecting Files and Folders

This section describes data save/load methods and operation methods for when selecting a save destination folder for images created during remeasurement, etc.

The following window will appear in the window to select a file or a folder.

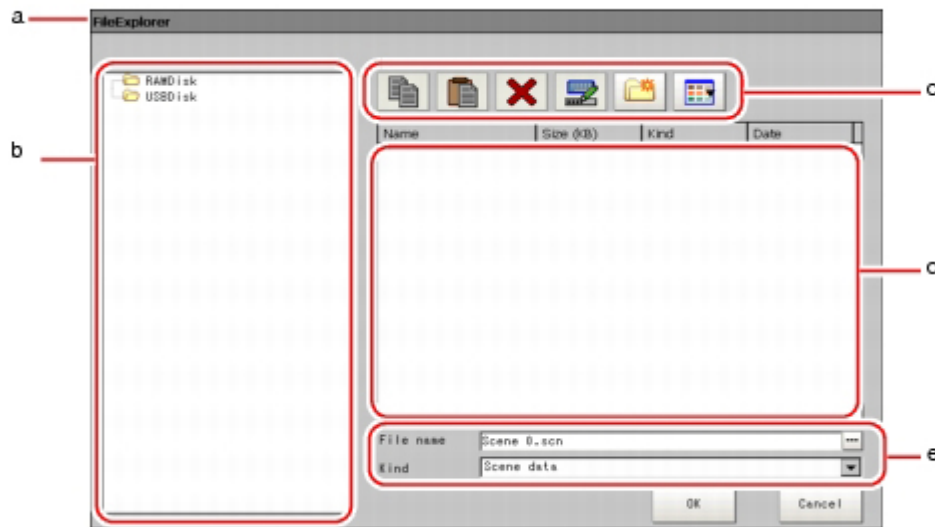

a. Window Title



When a file is specified, "FileExplorer" is displayed. If a folder is selected, "Select folder" is displayed.

b. Folder View Area

A list of folders on the RAM disk and folders in the mounted USB memory is displayed. At the root of the tree, the drive names of all accessible USB memory devices are displayed (ex. "USBDisk", "USBDisk2").

c. Toolbar

-  Copy

Reference: ▶ Enabled when a folder or file is selected in the List View area (p.332) .When tapped, the file that is selected is copied and [Paste] () becomes enabled.
-  Paste

Enabled when copying is performed. Pastes copied files or folders.
-  Delete

Reference: ▶ Enabled when a folder or file is selected in the List View area (p.332) . If tapped, the Deletion Confirmation window is displayed.
-  Rename

Reference: ▶ Enabled when a folder or file is selected in the List View area. (p.332) If tapped, the Rename window is displayed.
-  New folder

Creates a new folder.
-  Toggle list view

Reference: ▶ Switches the display format of the List View area. (p.332)

d. List View Area

A list of files and folders contained in the folder selected from the folder view area is displayed. In addition, when an extension name is selected from "Kind", only the files with the selected extension name are displayed. The content displayed is switched if [List display toggle] () is tapped.

e. File Name View Area

- File name
Reference: ▶ Names of files selected in the List View area (p.332) are displayed.
- Kind
Reference: ▶ Specifies the types of the file displayed ("Scene data", "System data", etc.) in the List View area. (p.332)



Available Operations in Select File Window

This section describes the main operations available from the Select File window.

Note

- If the target file is not displayed in the List View area when selecting a file, please check that the file type of the target file is selected in "Kind".

Copying/Pasting a File or Folder

1. Tap the folder or file that you want to copy in the List View area.
The file or folder will be selected.
2. Tap [Copy] ().
3. Select the target folder and tap [Paste] ().

Renaming a Folder or a File

1. Tap the name of the file or folder to be renamed from the List View area.
The file or folder will be selected.
2. Tap [Rename] ().
The soft keyboard is displayed.

3. Enter a new name.

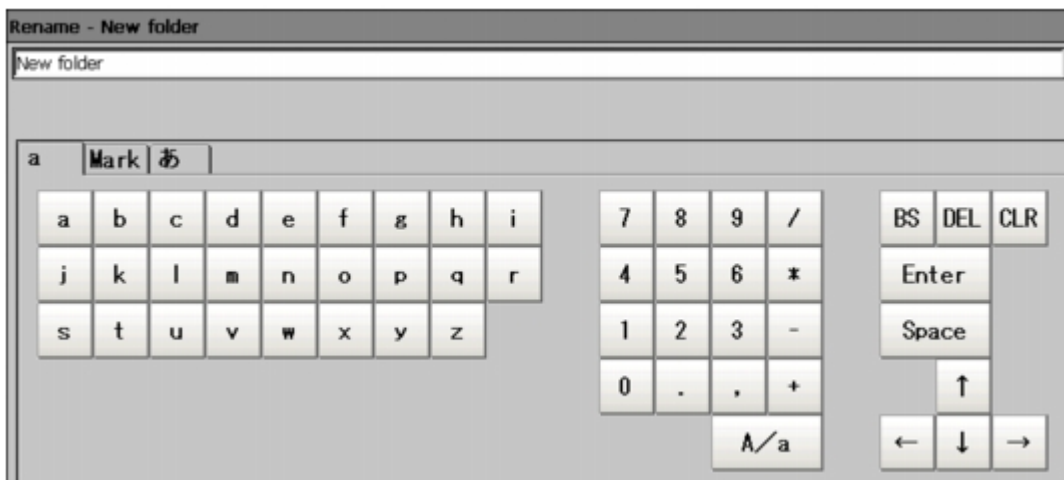

Character input method: Reference: ▶ Inputting Text (p.329)

Note

- When a file or folder with the same name exists within the folder, an error message will display telling you that you cannot change the name.

Deleting a Folder or File

1. Tap the name of file or folder to be deleted from the List View area.
The file or folder will be selected.
2. Tap [Delete] ().
A confirmation window is displayed.
3. Tap [OK].
The selected file or folder will be deleted.



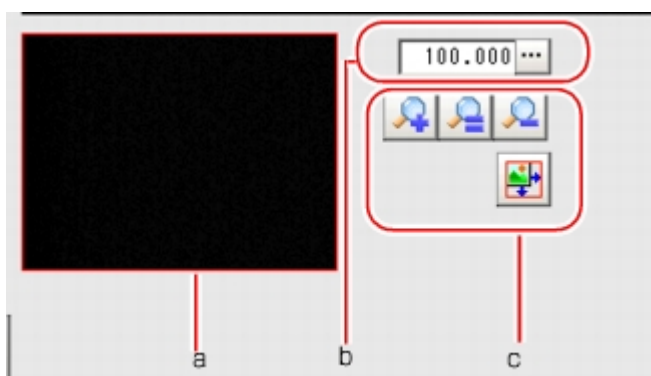

Using the Zoom Function

Specifies the magnification settings of the image displayed in the Properties window.



- a. Zoom browser
Indicates where the zoom display area is in the original image.
- b. Magnification factor
Input the magnification factor. A factor of between 25% to 1600% can be input.

C. Operation buttons

-  Zoom-in button
Enlarges the selected area to twice its size.
-  Original size button
Displays the selected area in the original size.
-  Zoom-out button
Reduces the selected area by half.
-  Full-screen button
Enlarges the zoom browser to the entire screen and returns it to its original size.

Setting Figures

This section describes the setting method for objects (figures and text) when registering models or specifying measurement regions.

The type and number of objects varies depending on different setting options.

Layout of Figure Setting Area

Window for registering figures when registering or setting areas or models as measurement objects.

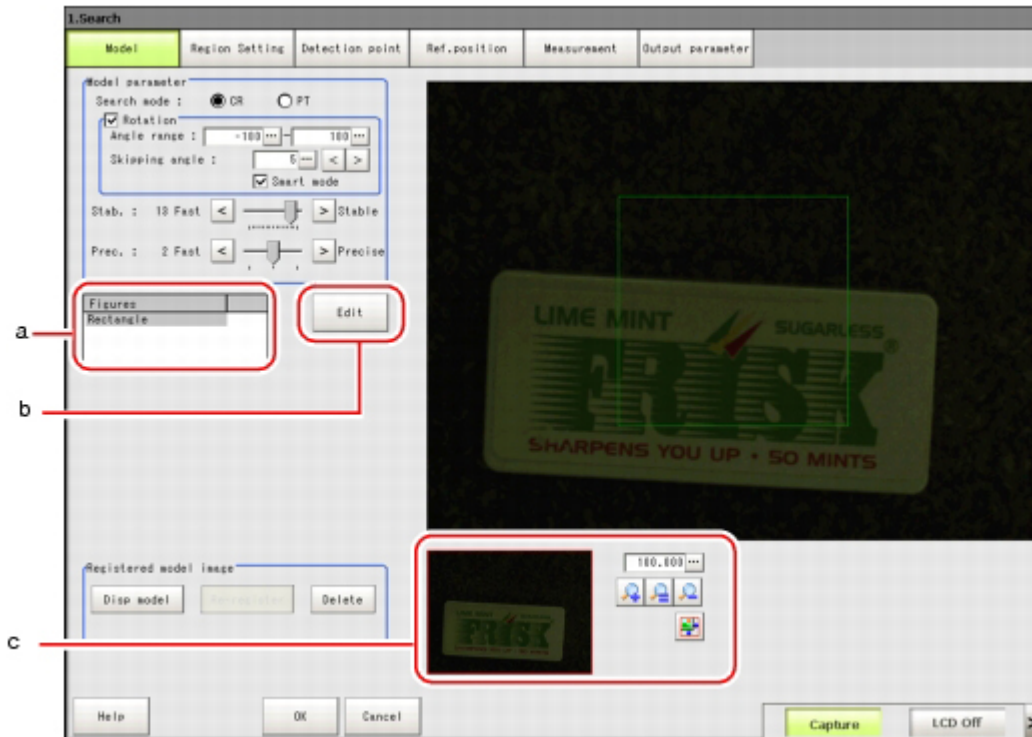

a. Figures

Displays a list of names of objects that have been set. The figure at the bottom of the list is the nearest object in the foreground. The higher the sequence position of the object, the further back in the background it is. When objects are drawn overlapping, the settings for the object set last are valid.

b. [Edit]

Used to edit a figure. The following figure editing tool is displayed.

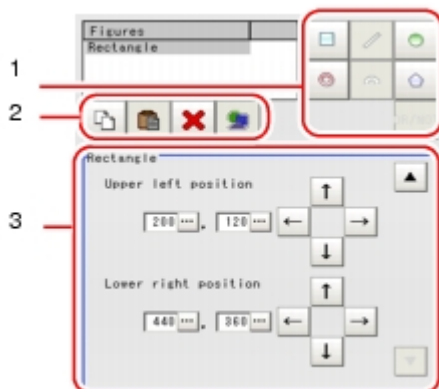

1. Drawing tool buttons
Sets objects, such as figures and text. The number and type of objects available is different depending on the applicable setting (ex. "Result display", "Model", "Region setting").
2. Object editing buttons
Buttons for editing objects
3. Details
Shows the details of the selected figure. Specify the object coordinates or radius. Tapping [▲] or [▼] will display the items currently not displayed.

C. Zoom Browser Area

Magnifies the Image Display area by the selected magnification factor.

Setting Methods

Rectangle

- **Image selection status**



Points are displayed at each of the four corners.

- **Dimension Adjustment**

Drag the points.

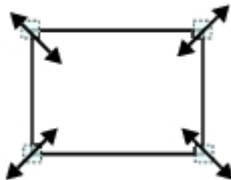

- Example) When enlarging
Drag the lower right point down in a diagonal direction.

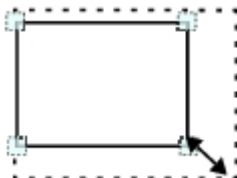

- **Using numbers for setting**

The window for settings is split into two. Setting is performed through input of numbers or through tapping on the arrows.

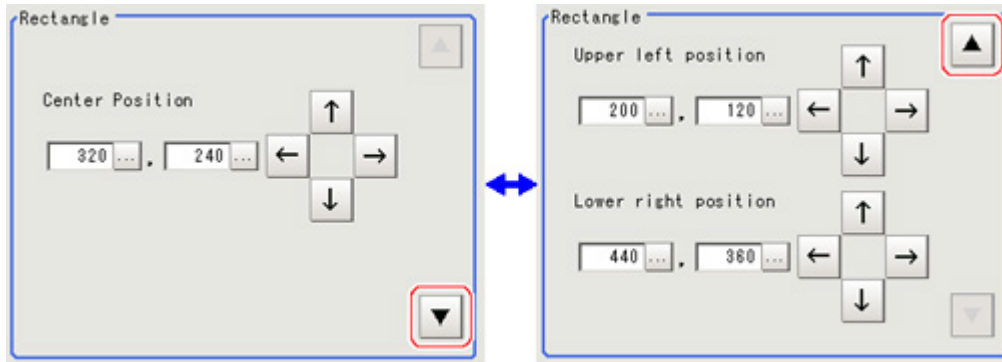

Line

- **Image selection status**



Points are displayed at the starting point, ending point, and midpoint of lines.

- **Dimension Adjustment**

Drag the points.



- Example) When changing the length of a line
Drag the points toward the intended direction.



- Example) When changing the oblique direction
Drag a point in the direction the line is to be changed.

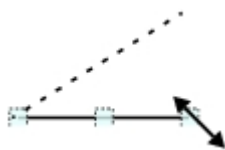

- Example) When changing the line width
Drag the center point of the line in a direction perpendicular to the line.

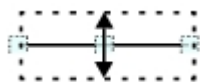

- **Using numbers for setting**

The window for settings is split into two. Setting is performed through input of numbers or through tapping on the arrows.

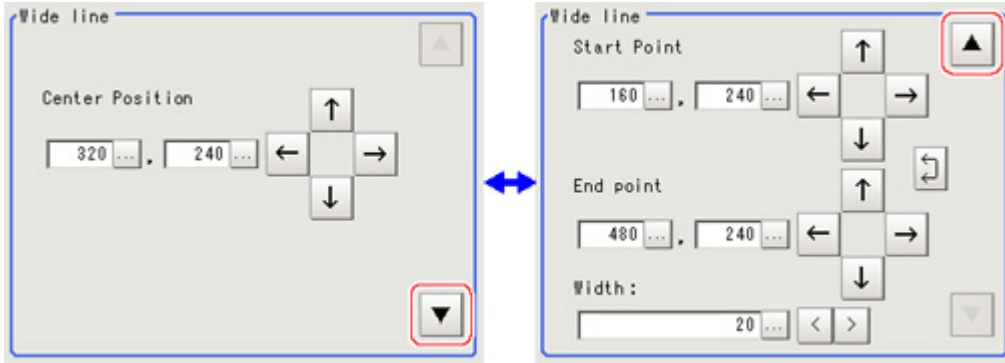

Circle/Ellipse

- **Image selection status**

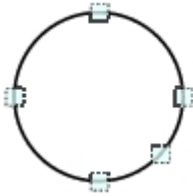

Points are displayed on the top, bottom, left, right, and lower right of the circle.

- **Dimension Adjustment**

Drag the points.

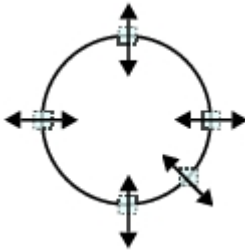

- Example) When zooming in on a circle
Drag the point on the lower right of the circle.

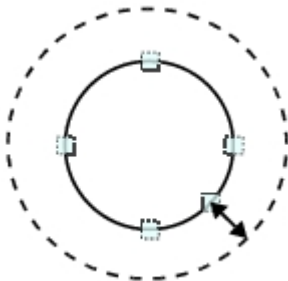

- Example) When transforming a circle into a long horizontal ellipse
Drag the point on the right of the circle to the right.

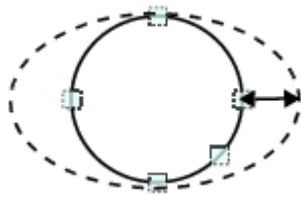

- **Using numbers for setting**

The window for settings is split into two. Setting is performed through input of numbers or through tapping on the arrows.

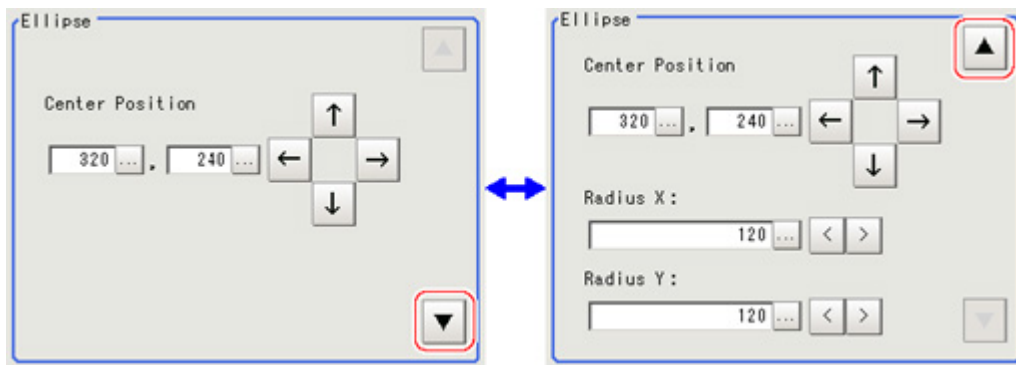

Circumference

- **Image selection status**

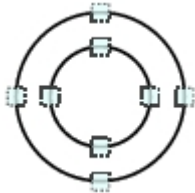

Points are displayed on the top, bottom, left, and right of both the inner and outer circles.

- **Dimension Adjustment**

Drag the points.

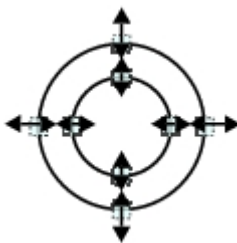

- Example) When enlarging the entire circumference
Drag a point on the outer circle.

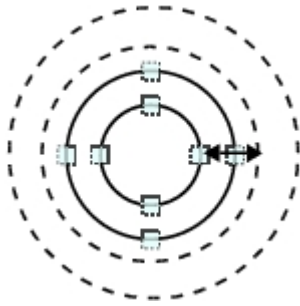

- Example) When adjusting the width of the circumference
Drag a point on the inner circle.

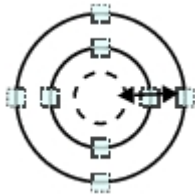

- **Using numbers for setting**

The window for settings is split into two. Setting is performed through input of numbers or through tapping on the arrows.

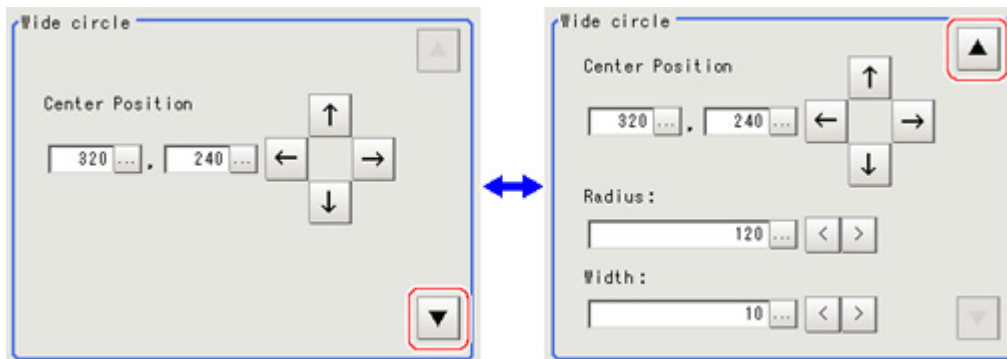

Arc

- **Image selection status**



Points are displayed on two lines at both ends of the arcs, on the inner arc, on the outer arc, and inside the closed arc shape.

- **Dimension Adjustment**

Drag the points.

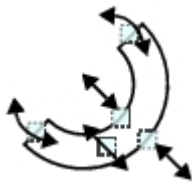

- Example) When enlarging an arc
Drag the point inside the arc outward.

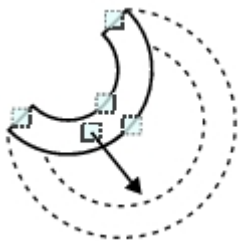

- Example) When adjusting the width of an arc
Drag a point on the inner or outer arc inward or outward.

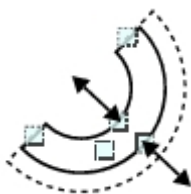

- Example) When changing the angle of arc (part that is open)
Drag one of the points at the end of the arc.

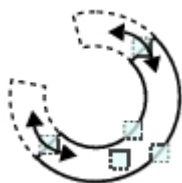

- **Using numbers for setting**

The window for settings is split into three. Setting is performed through input of numbers or through tapping on the arrows.

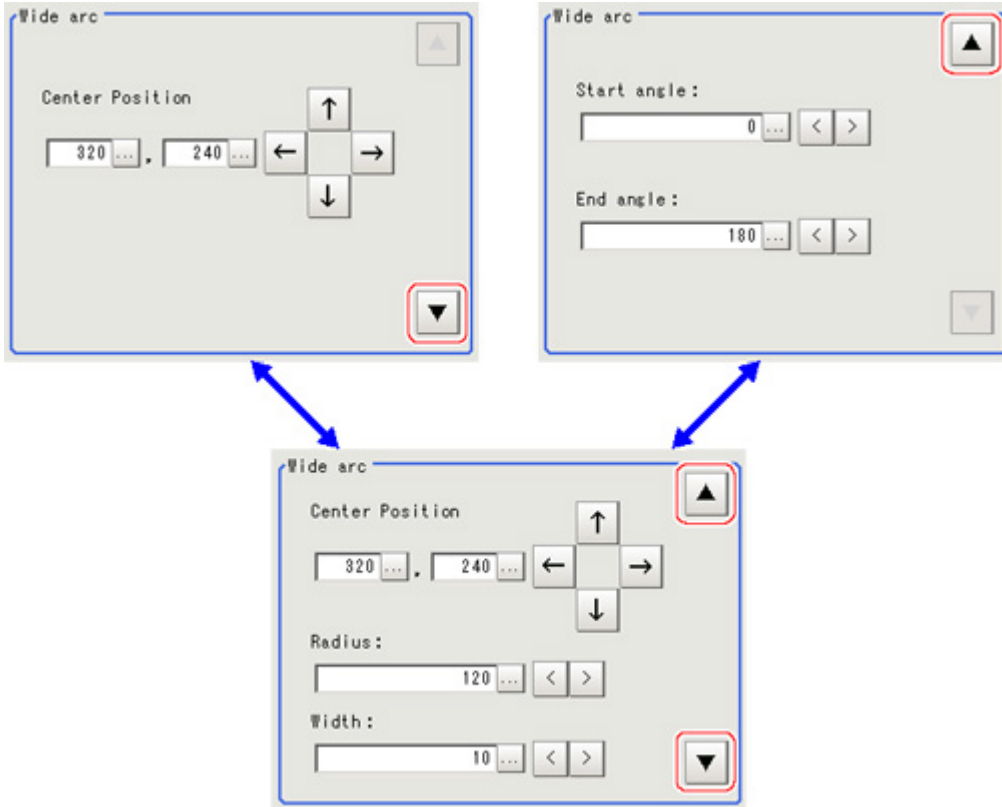

Crosshair Cursor

- **Image selection status**



Entire image is selected.

- **Using numbers for setting**

Setting is performed through input of numbers or through tapping on the arrows. The line type and line color can also be changed at this window.

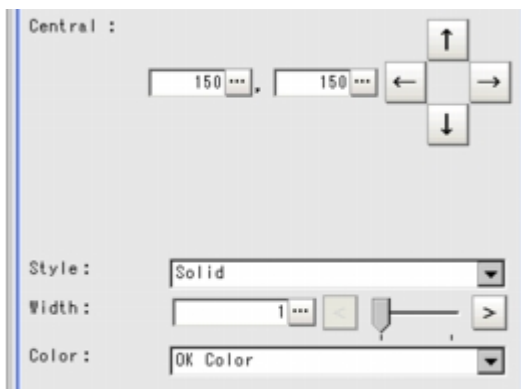

Polygons (Triangle to Decagon)

- **Drawing methods (for drawing a quadrilateral)**



1. When [Polygon] is specified, a triangle is drawn at first.
2. If you drag and drop one of the sides at the point you want to make a new vertex, a new vertex will be created.

If the number of vertexes is not within 3 to 10, the image cannot be confirmed as a polygon.

- **Image selection status**

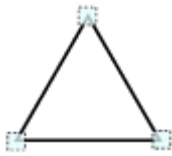

Points are displayed at the vertexes of the figure.

- **Dimension Adjustment**

Drag the points.



- Example) When changing the angle of one point
Drag point (arbitrarily).

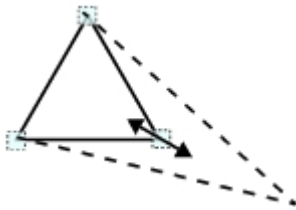

- Example) When changing the region
Drag point (arbitrarily).

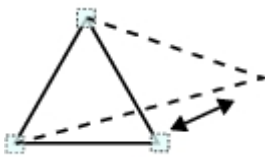

- **Using numbers for setting**

The window for settings is split into two. Setting is performed through input of numbers or through tapping on the arrows.

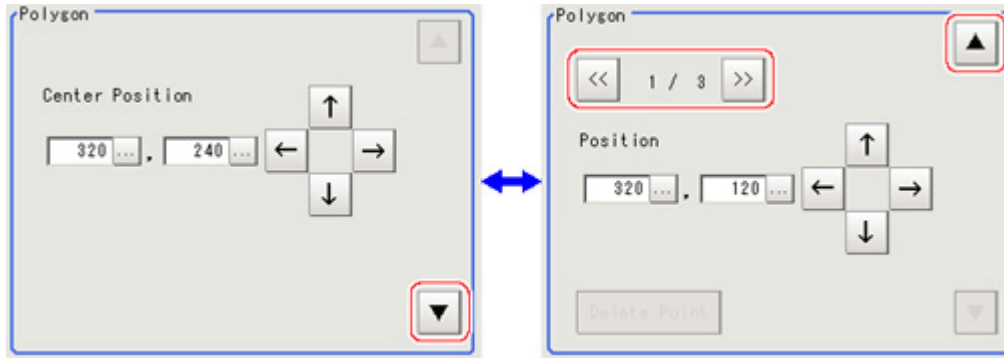

Text

- **Image selection status**



Entire image is selected.

Note

- "Text" can only be used in the [Result display] processing item.

Time

- **Image selection status**

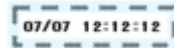

Entire image is selected.

Note

- "Time" can only be used in the [Result display] processing item.

About OR Setting/NOT Setting

The OR setting/NOT setting is used when multiple images are combined.

Areas with complex shapes can be drawn through combining figures, and unnecessary parts can be

excluded from the area. Each time [OR/NOT] () is tapped, the setting of the selected figure toggles

between OR and NOT.

Important

- Images with only the NOT setting cannot be drawn.

Item	Description
OR/ NOT()	Used when drawing a model or a region. Switching between OR and NOT occurs each time the button is tapped.

OR	The selected figure is displayed with a dotted line in the OK color. When drawing multiple figures, the entire area is registered as one region.
NOT	The selected figure is displayed with a dotted line in the NG color. The area outside of the NOT image is registered as the region.

(Example) The grey parts are measurement regions.

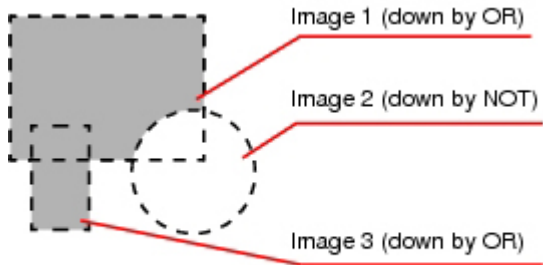

About Number of Logging Images

The maximum number of logging images (I_MAX) that can be stored in the controller's memory varies depending on the type of the controller in use and the type and number of connected cameras.

For color cameras:

Type of controller	0.3 megapixel camera				Intelligent compact camera				2 megapixel camera				5 megapixel camera			
	1 camera	2 cameras	3 cameras	4 cameras	1 camera	2 cameras	3 cameras	4 cameras	1 camera	2 cameras	3 cameras	4 cameras	1 camera	2 cameras	3 cameras	4 cameras
FZ3-L35 □	250	125	83	62	214	107	71	53	40	20	13	10	-	-	-	-
FZ3-3 □ □ FZ3-H3 □ □									40 [Note 1]	20 [Note 1]	13 [Note 1]	10 [Note 1]	-	-	-	-
FZ3-7 □ □ FZ3-H7 □ □									40	20	13	10	11	5	-	-
FZ3-9 □ □ FZ3-H9 □ □									40	20	13	10	15	7	5	3

Intelligent compact camera: 752 pixels x 480 pixels

0.3 megapixel camera: 640 pixels x 480 pixels

2 megapixel camera: 1600 pixels x 1200 pixels

5 megapixel camera: 2432 pixels x 2044 pixels

[Note 1]: 2 megapixel cameras can be used with software version 3.30 or later.

For monochrome cameras:

Type of controller	0.3 megapixel camera				2 megapixel camera				5 megapixel camera			
	1 camera	2 cameras	3 cameras	4 cameras	1 camera	2 cameras	3 cameras	4 cameras	1 camera	2 cameras	3 cameras	4 cameras
FZ3-L35 □	252	126	84	63	40	20	13	10	-	-	-	-
FZ3-3 □ □ FZ3-H3 □ □					40 [Note 1]	20 [Note 1]	13 [Note 1]	10 [Note 1]	-	-	-	-
FZ3-7 □ □ FZ3-H7 □ □					40	20	13	10	11	5	-	-
FZ3-9 □ □ FZ3-H9 □ □					40	20	13	10	15	7	5	3

0.3 megapixel camera: 640 pixels x 480 pixels

2 megapixel camera: 1600 pixels x 1200 pixels

5 megapixel camera: 2432 pixels x 2044 pixels

[Note 1]: 2 megapixel cameras can be used with software version 3.30 or later.

About Limits on the Number of Image Input Processing Items Used

The number of image input processing items that can be used within one scene is limited by the combinations of the camera.

If the limit is exceeded, a measurement NG occurs due to a memory shortage during measurement.

Please use within this processing items limitation.

Camera used	Number of image input related processing item restriction
0.3 megapixel color camera	81
0.3 megapixel monochrome camera	245
Intelligent compact camera (FZ-SQ)	68
2 megapixel color camera [Note 1]	13
2 megapixel monochrome camera [Note 1]	39
5 megapixel color camera [Note 1]	6
5 megapixel monochrome camera [Note 1]	19

[Note 1]: 2 megapixel cameras can be used with FZ3-3 □ □ /H3 □ □ (software version 3.30 or later), FZ3-L35 □ □ , FZ3-7 □ □ /H7 □ □ , and FZ3-9 □ □ /H9 □ □ series.

5 megapixel cameras can be used with FZ3-7 □ □ /H7 □ □ and FZ3-9 □ □ /H9 □ □ series.

Image input related processing items

Target processing items are as follows.

Item	Processing item
Loading images	Camera Image Input
	Camera Image Input HDR
	Camera Switching
Performing image compensation	Position Compensation
	Trapezoidal Correction+
	Filtering
	Background Suppression
	Color Gray Filter
	Extract Color Filter
	Anti Color Shading
	Stripes Removal Filter+
	Halation Cut+
	Panorama+ [Note 1]
Polar Transformation [Note 2]	
Display results	Display Image File [Note 3]
	Display Last NG image [Note 4]

[Note 1]: When using a panorama+, each image input related unit after panorama+ may consume up to a maximum of 5 items.

[Note 2]: When using a Polar Transformation, each image input related unit after Polar Transformation may consume up to a maximum of 2 items.

[Note 3]: Image file display consumes the number of image setting value items per unit.

[Note 4]: Display Last NG Image consumes the number of save setting value items per unit.

Important

- If there is one or more "Sensitive Search" in the flow, the number of image input items that can be used is only reduced by one.
 - In the case of FZ3-9 □ □ /H9 □ □ , the number of processing items is not limited and as many processing items as permitted by the memory can be registered. Note, however, that a warning message is displayed when the available memory drops to below 1 GB. In this case, adjust the inspection flow to ensure at least 1 G of available memory.
-

About Max. Number of Loading Images during Multiple Image Input

The function that enables continuous high speed image input is called the multiple image input function. The maximum number of images that can be loaded based on each specification is shown below.

Type of controller	0.3 megapixel camera	2 megapixel camera	5 megapixel camera
FZ3-L35 □	16 (Camera0, Camera1) 32 (Camera2, Camera3)	4 (Camera0, Camera1) 8 (Camera2, Camera3)	-
FZ3-3 □ □ FZ3-H3 □ □	16	4 [Note 1]	-
FZ3-7 □ □ FZ3-H7 □ □	32	8	2
FZ3-9 □ □ FZ3-H9 □ □	32	8	2

[Note 1]: 2 megapixel cameras can be used with software version 3.30 or later.

Important

- The multiple input function cannot be used when the built-in lighting of an intelligent compact camera, FZ-SQ □ □ □ □, is used.

Character Code Table

For the case of character-related process items, recognized characters are output to an external device using a character code (base 10).

Calculation method for output value (base 10)

Number of upper level bits x 16 + number of lower level bits (of recognized character) = Output value

(Examples) If the recognized character is "2", "50" is output.

If the recognized character is "C", "67" is output.

		Upper 4 bits							
		0	1	2	3	4	5	6	7
Lower 4 bits	0		D _E		0	@	P	`	p
	1	S _H	D ₁	!	1	A	Q	a	q
	2	S _X	D ₂	"	2	B	R	b	r
	3	E _X	D ₃	#	3	C	S	c	s
	4	E _T	D ₄	\$	4	D	T	d	t
	5	E _Q	N _K	%	5	E	U	e	u
	6	A _K	S _N	&	6	F	V	f	v
	7	B _L	E _B	'	7	G	W	g	w
	8	B _S	C _N	(8	H	X	h	x
	9	H _T	E _M)	9	I	Y	i	y
	A	L _F	S _B	*	:	J	Z	j	z
	B	H _M	E _C	+	;	K	[k	{
	C	C _L	→	,	<	L	¥	l	!
	D	C _R	←	-	=	M]	m	}
	E	S _O	↓	.	>	N	^	n	~
	F	S _I	↑	/	?	O	_	o	

Upper Limits of Processing Item Parameters

For processing items where the upper limit value is changed based on the image size of the camera being used, the description of the upper limit value is expressed using "_MAX". Upper limit values for each camera are as follows.

Parameters	Description	For 0.3 megapixel cameras:	For 2 megapixel cameras:	For 5 megapixel cameras:
X_MAX	The max value in the X-axis orientation	639	1599	2447
Y_MAX	The max value in the Y-axis orientation	479	1199	2043
W_MAX	Maximum width	239 (straight line W = 319)	599 (straight line W = 799)	1021 (straight line W = 1223)
R_MAX	Maximum radius	239 (circle/ellipse R1=319)	599 (circle/ellipse R1=799)	1021 (circle/ellipse R1 = 1223)
A_MAX	Maximum area	(X_MAX+1) * (Y_MAX+1) = 307200	(X_MAX+1) * (Y_MAX+1) = 1920000	(X_MAX+1) * (Y_MAX+1) = 5003712
Y_PMAX	Maximum number of lines that can be loaded	479	1199	2043

About Memories Usable with FZ Series

The following types of memory can be used with FZ.

On-board memory

This is the area where images are temporarily stored when logging images using the logging function. This uses ring memory and if the maximum number of save images has been reached, images are overwritten starting with the oldest. This is cleared when the power is turned OFF.

RAMDisk

Image logging file, data logging file, and capture images can be saved.

As this is memory inside the FZ3, files can be saved and read faster than using USB memory.

However, capacity is a fixed 40 MB (256 MB for FZ3-9 □□ /H9 □□). Files saved in RAMDisk are cleared when the power is turned OFF.

Application memory

This is a memory used for all applications.

This is a memory area that is used temporarily by applications. By confirming available memory, this provides a rough standard for confirming status while operating. The user has no access to it.

Data memory (FZ3-3 □□ /H3 □□ , FZ3-7 □□ /H7 □□ only)

This is an area for holding current settings details of scene group data.

If this capacity is exceeded, adding units and copying scenes cannot be performed in edit flow.

Available data memory can be confirmed from the system menu.

Reference: ▶ Checking System Information [System Information] (p.145)

Memory Display Image on PLC I/O

The memory display image on PLC I/O varies depending on the PLC to be used. Using data output to the Data Output area of the PLC link from the serial data output processing item as an example, this section illustrates how the memory display image varies depending on the model.

Data storage image (Data Output area DM1000)

When the PLC link Data Output area is set to DM1000, data is stored as follows in the PLC I/O memory.
 *: Up to 8 expressions can be registered in the serial output flow on the FZ3 side. If 8 expressions are registered, data is stored as follows.

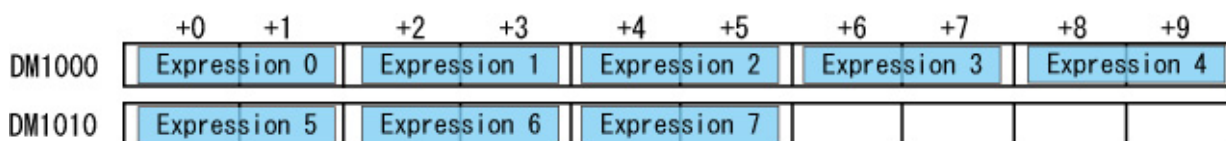

CX-Programmer PLC I/O memory display image

As an example, if 3 data items, expression 0 (DATA0) = 1.000, expression 1 (DATA1) = 200.000, and expression 2 (DATA2) = 1000.000, are output from FZ3, they are stored to the PLC Link area as measurement data as follows.

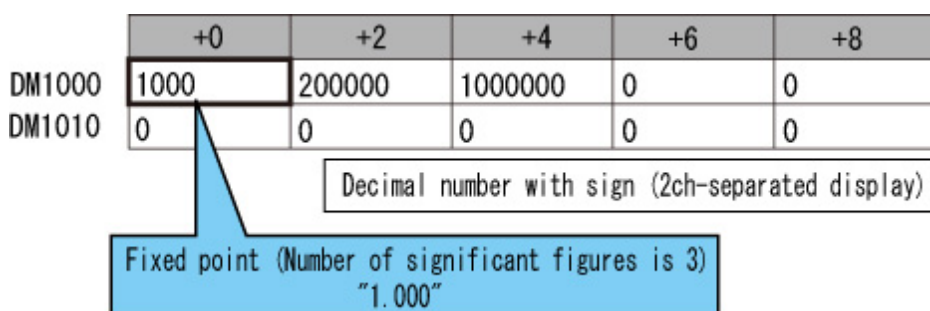

*: Data is stored to the PLC I/O memory as follows for a decimal number per channel.

	+0	+1	+2	+3
DM1000	1000	0	16960	15

GX-Developer PLC I/O memory display image

As an example, if 3 data items, expression 0 (DATA0) = 1.000, expression 1 (DATA1) = 200.000, and expression 2 (DATA2) = 1000.000, are output from FZ3, they are stored to the PLC Link area as measurement data as follows.

Device: Monitor: Bit&Word Display: 16 bit integer Numeric: Decimal
 Bit(multi points) 32 bit integer Hexadecimal
 Word(multi points) Real(single)
 Real(double)
 ASCII

Device	+F EDC	+B A98	+7 654	+3 2 1 0	
D1000	○○○○	○○●●	●●○○	●○○○	1000
D1001	○○○○	○○○○	○○○○	○○○○	
D1002	○○○○	●●○○	○●○○	○○○○	200000
D1003	○○○○	○○○○	○○○○	○○●●	
D1004	○●○○	○○●○	○●○○	○○○○	1000000
D1005	○○○○	○○○○	○○○○	●●●●	

*: Data is stored to the PLC I/O memory as follows for a decimal number per channel.

	+0	+1	+2	+3	+4	+5
DM1000	1000	0	3392	3	16960	15

Manual Revision History

The manual revision symbol is an alphabet appended at the end of the manual number found in the bottom left-hand corner of the front or back cover.



Rev. No.	Rev. Date	Revision Contents	Software Version
01	Dec. 2008	Software version upgrade from Ver.2.0 to Ver.2.1	Ver.2.1
02	Oct. 2009	Special function corresponding to FZ3-9 □ □ /H9 □ □ series	Ver.3.0
03	Feb. 2010	FZ3-3 □ □ /H3 □ □ /7 □ □ /H7 □ □ series supports the newly added functions	
04	Jan. 2011	Software version upgrade and new functions are added	Ver.3.3

Index

Value			
2D Code + (External Reference)	279		
2's complement (Terminology Explanation)	328		
<hr/>			
A			
ADJUST window	74		
Angle range	319		
Anti Color Shading (External Reference)	286		
Arc	340		
ASCII data	211		
Auto Re-meas.	91		
Available application memory	145		
Available data memory	146		
<hr/>			
B			
Background suppression (External Reference)	283		
Barcode+ (External Reference)	277		
Binary data	212		
BKDLOAD	187		
BKDSAVE	188		
<hr/>			
C			
Calculation (External Reference)	289		
Calibration (Terminology Explanation)	326		
Calibration+ (External Reference)	290		
Camera connection	128		
Candidate point (Terminology Explanation)	326		
Candidate point level	319		
Capture	105		
Captured images save destination	106		
Changing a scene name	68		
Changing scene group name	71		
Character code table	350		
Character input	333		
Character Inspection (External Reference)	275		
Circle	338		
Circle Regression (External Reference)	290		
Circle Angle (External Reference)	280		
Circumference	339		
Classification (External Reference)	257		
Clear measurement	104		
Clearing saved images	104		
CLRMEAS	189		
Color Data (External Reference)	262		
Color Gray Filter (External Reference)	284		
Color processing	316		
Command Control (PLC Link)	163		
Command format (EtherNet/IP)	219		
Command format (Non-procedure)	185		
Communication specifications (Ethernet - Non-procedure)	179		
Communication specifications (Ethernet - PLC Link)	152		
Communication specifications (RS-232C/422-PLC Link)	157		
Communication specifications (RS-232C/422-Non-procedure)	183		
Conditional Branch (External Reference)	296		
Confirmation (Non-procedure)	184		
Confirmation (Parallel)	223		
Coordinates	323		
Copying a scene	67		
Copying files	124		
Copying scene group	70		
Correlation value	318		
Correlation value (Terminology Explanation)	327		
Create shortcut	138		
Crosshair Cursor	342		
<hr/>			
D			
Data Logging (External Reference)	293		
Data Output (External Reference)	297		
Data save	28, 118		
DATASAVE	190		
DATE	190		
Date Verification (External Reference)	276		
Date-time setting	131		
Default gateway	154, 182		
Defect (External Reference)	272		
Deleting a scene	67		
Detection point (Terminology Explanation)	326		
DI Branch (External Reference)	296		
DISPCOND	192		
Display Image File (External Reference)	300		
Display Last NG Image (External Reference)	300		
DNS server	154, 182, 242		
<hr/>			
E			
EC Circle Search (External Reference)	253		
ECM Search (External Reference)	252		
Edge detection	320		
Edge Pitch (External Reference)	259		
Edge level	320		
Edge Position (External Reference)	258		
Elapsed Time (External Reference)	294		
Ellipse	338		
Encoder trigger setting	139		
Ethernet	152, 179		
EtherNet/IP	214		
Extension tube	307		
External Reference tables	244		
Extract Color Filter (External Reference)	285		

<hr/>	
F	
Fan control setting	132
Fast view mode	75
Figure setting	335
Fieldbus Data Output (External Reference)	299
Filtering (External Reference)	283
Fine Matching (External Reference)	274
Flash memory	116
Flexible Search (External Reference)	249
Flow control (Terminology Explanation)	327
Focus (External Reference)	294
FTP	241
<hr/>	
G	
Get Unit Data (External Reference)	291
Get Unit Figure (External Reference)	291
Gravity and Area (External Reference)	263
Gravity center (Terminology Explanation)	327
<hr/>	
H	
Halation Cut+ (External Reference)	287
Handshaking	232
High-speed logging mode	21
<hr/>	
I	
Image layout	82
Image Logging	99
Image Logging (External Reference)	293
Image mode	84
IMGSAVE	194
Initialization	27
Input format (Parallel)	225
Intelligent camera (Terminology Explanation)	325
Inter-camera setting	128
IP address	153, 182
Iris (External Reference)	294
<hr/>	
L	
Label Data (External Reference)	267
Labeling (External Reference)	265
Labeling+ (External Reference)	268
Language setting	131
LCD Off	28
Line	337
Line Regression (External Reference)	289
Logging	102
Logging image clearing	104
Logging image saving	122
<hr/>	
M	
MAX	351
MEASURE	195
Measure setting	130
Measurement flow (Terminology Explanation)	326
Measurement Image Switching (External Reference)	247
<hr/>	
Measuring processing time	81
Model (Terminology Explanation)	327
Model Dictionary (External Reference)	277
Mouse	25
Moving files	124
Multi-line random-trigger mode	37
Multi input	239
Multiple selection	64
<hr/>	
N	
NG analyzer	108
No. of image logging images	346
Noise level	321
Non-procedure	179
Non-stop adjustment	93
Non-stop adjustment mode	38
Normal mode	75
NOT setting	344
<hr/>	
O	
Operation mode	21, 136
Optical diagram	305
OR setting	344
Output coordinates	323
Output format (Non-procedure)	211
Output polarity	222
<hr/>	
P	
Panorama+ (External Reference)	287
Parallel Data Output (External Reference)	297
Parallel interface	223
Parallel Judgement Output (External Reference)	298
Parallel-operation High-speed mode	32
Password setting	142
PLC Link	152
Polar transformation (External Reference)	288
Polygon	343
Position Compensation (External Reference)	282
Position Compensation (Terminology Explanation)	325
Positions	84
Precise Defect (External Reference)	273
Processing item	49
Processing item (Terminology Explanation)	327
Processing unit (Terminology Explanation)	327
<hr/>	
R	
RAMDisk	116
Reading	126
Reading data	126
Rectangle	336
Reference position (Terminology Explanation)	325
Remeasuring saved images	90
RESET	197
Restart	27

Result Display (External Reference)	300
RS-232C/RS-422	135, 149
RUN window	74
RUN window display selection	138
RUN window selection	88
<hr/>	
S	
Save last logging image	97
Save to file	118
Saving during scene group switch	130
Scan Edge Position (External Reference)	260
Scan Edge Width (External Reference)	261
SCENE	197
Scene	42
Scene (Terminology Explanation)	326
Scene data saving	120
Scene group	46
Scene group (Terminology Explanation)	327
Scene group data saving	120
Scene group switch	65
Scene switch	65
Scene switch time	130
SCNGROUP	198
SCNLOAD	200
SCNSAVE	201
Screen capture	105
SCRSWITCH	202
Search (External Reference)	248
Search processing	327
Search speed	327
Select images	90
Sensitive Search (External Reference)	250
Serial interface	186
Set Unit Data (External Reference)	291
Set Unit Figure (External Reference)	291
Setup changes	42
SGRLOAD	202
SGRSAVE	203
Shape	317
Shape Search+ (External Reference)	256
Shift area	64
Simplified non-stop adjustment	93
Single-line High-speed mode	35
Skipping angle	318
Startup setting	133
STEP in measure	130
STEP setting	141
Stripes Removal Filter+ (External Reference)	286
Sub image No.	84
Subnet mask	154, 182, 242
Sub-pixel (Terminology Explanation)	326
Synchronization output	222
SYSDATA	204
SYSLOAD	207
SYSSAVE	207
System data saving	120

System environment settings	127
System information	145
System initialization	27
System restart	27
<hr/>	
T	
Test measurement	77
Text	329
Time	344
Timing chart	228
Timing chart (PLC Link)	174
Timing chart (EtherNet/IP)	219
Touch pen	25
Trackball	25
Trapezoidal Correction+ (External Reference)	282
Trend Monitor	95
Trend Monitor (External Reference)	292
Trigger delay	128
<hr/>	
U	
Unit (Terminology Explanation)	328
UNITDATA	208
Upper limit	351
<hr/>	
V	
Value input	329
VERGET	210
<hr/>	
W	
Wait (External Reference)	294
<hr/>	
Z	
Zoom function	333

OMRON Corporation
Industrial Automation Company
Sensing Devices Division H.Q.
Application Sensors Division

Shiokoji Horikawa, Shimogyo-ku,
Kyoto, 600-8530 Japan
Tel: (81) 75-344-7068/Fax: (81) 75-344-7107

Regional Headquarters

OMRON EUROPE B.V.

Sensor Business Unit
Carl-Benz-Str. 4, D-71154 Nufringen,
Germany
Tel: (49) 7032-811-0/Fax: (49) 7032-811-199

OMRON ELECTRONICS LLC

One Commerce Drive Schaumburg,
IL 60173-5302 U.S.A.
Tel: (1) 847-843-7900/Fax: (1) 847-843-7787

OMRON ASIA PACIFIC PTE. LTD.

No. 438A Alexandra Road # 05-05/08 (Lobby 2),
Alexandra Technopark, Singapore 119967
Tel: (65) 6835-3011/Fax: (65) 6835-2711

OMRON (CHINA) CO., LTD.

Room 2211, Bank of China Tower,
200 Yin Cheng Zhong Road,
PuDong New Area, Shanghai, 200120, China
Tel: (86) 21-5037-2222/Fax: (86) 21-5037-2200

Authorized Distributor:

© OMRON Corporation 2008 All Rights Reserved.
In the interest of product improvement,
specifications are subject to change without notice.