

Conductive Level Controller

61F-D21T-V1

Ideal for level control for industrial facilities and equipment.

- Outputs can be set to self-hold at ON or OFF using self-holding circuits.
- Sensitivity adjustment of operating resistance from 10 to 100 k Ω for application to a wide range of liquids.
- Delay timer to prevent relay contact chattering caused by waves.
- CE marking, cUL recognized (Except 24 VDC).
- Easy wiring with ferrules
2 \times 2.5 mm² solid or 2 \times 1.5 mm² standard ferrules.

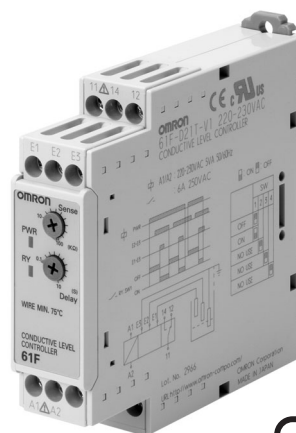

Model Number Structure

■ Model Number Legend

61F-□□
1 2 3

1. Basic Model

61F: Conductive Level Controller

2. Functions

D21T-V1: Automatic liquid supply operation/
Automatic liquid drainage operation

3. Supply Voltage

24 VDC: 24 VDC

24 VAC: 24 VAC

115 VAC: 115 VAC

220-230 VAC: 220 to 230 VAC

Ordering Information

■ List of Models

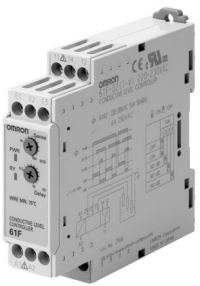
Conductive Level Controller	Supply voltage	Model
	24 VDC	61F-D21T-V1 24 VDC
	24 VAC	61F-D21T-V1 24 VAC
	115 VAC	61F-D21T-V1 115 AC
	220 to 230 VAC	61F-D21T-V1 220 to 230 VAC

Specifications

Rated voltage	24 VAC, 115 VAC, 220 to 230 VAC, 24 VDC
Operating voltage range	85% to 110% of rated voltage
Voltage between electrodes	6 VAC p-p (approx. 20 Hz)
Power consumption	AC: 5 VA max. DC: 2 W max.
Operating resistance	10 k Ω to 100 k Ω (variable)
Reset resistance	250 k Ω max.
Response time	Approx. 0.1 to 10 s (variable)
Cable length	100 m max. with completely insulated (600 V) cabtire cable with 3 conductors (0.75 mm ²)
Control output	6 A at 250 VAC for resistive load at 20°C, 1 A at 250 VAC for inductive load $\cos\phi = 0.4$ at 20°C
Indicators	Green LED: Power, Yellow LED: Control output
Ambient temperature	Operating: -20 to 60°C, Storage: -30 to 70°C (with no condensation or icing)
Ambient humidity	Operating: 25% to 85%, Storage: 25% to 85%
Elevation	2,000 m max.
Insulation resistance	100 M Ω min. (at 500 VDC) between power supply section, electrode section, and contact section
Dielectric strength	2,000 VAC 50/60 Hz for 1 min between power source section, electrode section, and contact section
Vibration resistance	Vibration of 10 to 55 Hz and acceleration of 50 m/s ² for 5 min. 10 times each in X, Y, and Z directions
Shock resistance	100 m/s ² 3 times each in 6 directions on 3 axes
Installation environment	Overvoltage Category II, Pollution Degree 2
Safety standards	EN61010-1
EMC	EN61326 Industrial applications

Connections

■ Operation Diagram

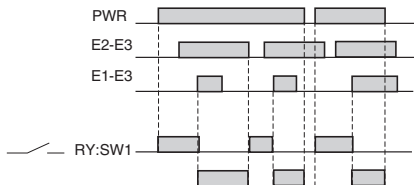

■ Wiring Diagram

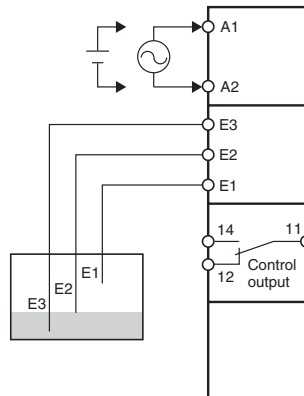

Nomenclature

■ Front

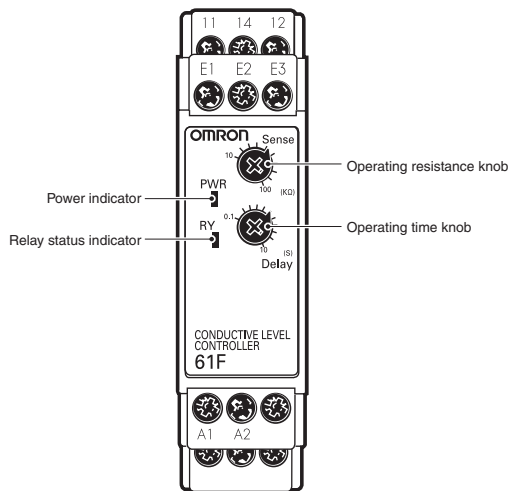

■ DIP Switch Settings

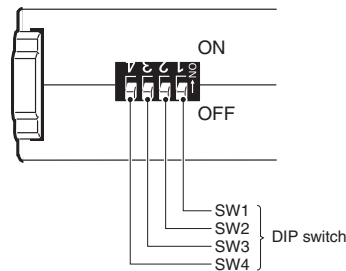

DIP Switch Functions

SWITCH	ON ● ↑	ON 4	3	2	1
	OFF ○ ↓	OFF	■	■	■
Supply/ drainage selection	Automatic liquid drainage operation	Not used.	Not used.	Not used.	●
	Automatic liquid supply operation				○

Note: All pins are set to OFF at the factory.

Indicators

Item	Meaning
Power indicator (PWR: Green)	Lit when power is being supplied.
Relay status indicator (RY: Yellow)	Lit when relay is operating.

Setting Knobs

Item	Usage
Operating resistance knob	Used to set the operating resistance to 10 to 100 kΩ.
Operating time knob	Use to set the operating time to 0.1 to 10 s.

Dimensions

61F-D21T-V1

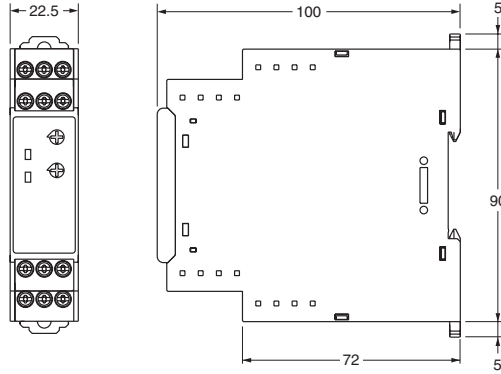

Safety Precautions

Definition of Precaution Information

 CAUTION	<p>Indicates a potentially hazardous situation which, if not avoided, may result in minor or moderate injury or in property damage.</p>
--	---

Precautionary Information

—  **Caution** —

Do not touch the terminals while power is being supplied.

Doing so may possibly result in electric shock.

■ Precautions for Safe Use

- Do not disassemble, repair, or modify the product.
- When attaching the product to the DIN rail, attach it firmly with screws.
- When attaching the product to the DIN rail, ensure that the product has been attached firmly.
- If the thickness of a mounting panel is not adequate, or a mistake has been made during installation, the product may become disconnected.
- Ensure that terminal screws have been tightened firmly.
Recommended torque : 0.49 N·m
Assured torque : 0.59 N·m
- When using the product, ensure that the wiring is correct before turning on the power.
- Use a power-supply voltage that is within the range of specifications.
- Use the control source and power supply or power lines that provide inputs with appropriate specifications.
- Do not install near heat-generating devices (coils, or devices that use coils).
- Be sure to confirm terminal numbers for correct wiring.
- Ensure that wiring is correct. Double-check materials such as connection charts and circuit diagrams.
- Properly ground the grounding terminal. Ensure that the common electrode terminal has been properly grounded. Doing so can alleviate effects from noise.
- If electrodes make contact with liquid, purchase and use a separator to prevent such contact.
- Keep appropriate distance from devices that generate high-frequency noise (e.g., high-frequency welders, electronic sewing machines).
- Do not turn a setting volume beyond the scope of movement.
- Do not connect anything to unused terminals.
- Use SELV power supply with over load protection function for DC power supply. The insulation of SELV power supply must be a double or reinforced between input and output. The output voltage shall be 30 V r.m.s. and 42.4 V at peak, or use the power supply of 60 V DC max. Recommended power supply : type S8VS-06024□ (OMRON made)

Do not keep, install, or use this product in the following environments.

- Outdoors, or places subject to direct sunlight or wearing weather.
- Places where temperature and humidity exceed the allowable range of the product specifications.
- Places where there are extreme changes in temperature and humidity, or icing or condensation may occur.
- Places subject to static electricity or inductive noise.
- Places subject to electrical fields.
- Places where vibrations or physical shocks are strong.
- Places where flammable gasses or flammable liquids exist.

- Places where corrosive gases (in particular, sulfuric or ammonia gas) exist.
- Places with large amounts of dust or iron powders.
- Places where water or oil come in contact with the product.
- Places subject to salt-water splashes.

■ Precautions for Correct Use

For Proper Use

1. Make sure to use setting values appropriate for the controlled object. Failure to do so can cause unintended operation, and may result in accident or corruption of the product.
2. When discarding, properly dispose of the product as industrial waste.
3. Only use this product within a board whose structure allows no possibility for fire to escape.
4. To avoid damage to the exterior of the product, do not use organic solvents (thinner, benzene) or agents with strong alkalinity or acidity.

About Installation

1. When wiring, use only recommended crimp terminals.
2. Do not block areas around the product for proper dissipation of heat. (If you do not secure space for heat dissipation, life cycle of the product will be compromised.)

Noise Countermeasures

1. Do not install the product near devices generating strong high frequency waves or surges.
2. When using a noise filter, check the voltage and current and install it as close to the product as possible.
3. In order to prevent inductive noise, wire the lines connected to the product separately from power lines carrying high voltages or currents. Do not wire in parallel with or on the same cable as power lines. Other measures for reducing noise include running lines along separate ducts and using shield lines.

To avoid faulty operations, malfunctions, or failure, observe the following operating instructions.

1. During insulation resistance measurements, never apply the megohmmeter across the electrode terminals.
2. Use a power supply that will reach rated voltage within 1 second.

Warranty and Application Considerations

Read and Understand this Catalog

Please read and understand this catalog before purchasing the products. Please consult your OMRON representative if you have any questions or comments.

Warranty and Limitations of Liability

WARRANTY

OMRON's exclusive warranty is that the products are free from defects in materials and workmanship for a period of one year (or other period if specified) from date of sale by OMRON.

OMRON MAKES NO WARRANTY OR REPRESENTATION, EXPRESS OR IMPLIED, REGARDING NON-INFRINGEMENT, MERCHANTABILITY, OR FITNESS FOR PARTICULAR PURPOSE OF THE PRODUCTS. ANY BUYER OR USER ACKNOWLEDGES THAT THE BUYER OR USER ALONE HAS DETERMINED THAT THE PRODUCTS WILL SUITABLY MEET THE REQUIREMENTS OF THEIR INTENDED USE. OMRON DISCLAIMS ALL OTHER WARRANTIES, EXPRESS OR IMPLIED.

LIMITATIONS OF LIABILITY

OMRON SHALL NOT BE RESPONSIBLE FOR SPECIAL, INDIRECT, OR CONSEQUENTIAL DAMAGES, LOSS OF PROFITS, OR COMMERCIAL LOSS IN ANY WAY CONNECTED WITH THE PRODUCTS, WHETHER SUCH CLAIM IS BASED ON CONTRACT, WARRANTY, NEGLIGENCE, OR STRICT LIABILITY.

In no event shall the responsibility of OMRON for any act exceed the individual price of the product on which liability is asserted.

IN NO EVENT SHALL OMRON BE RESPONSIBLE FOR WARRANTY, REPAIR, OR OTHER CLAIMS REGARDING THE PRODUCTS UNLESS OMRON'S ANALYSIS CONFIRMS THAT THE PRODUCTS WERE PROPERLY HANDLED, STORED, INSTALLED, AND MAINTAINED AND NOT SUBJECT TO CONTAMINATION, ABUSE, MISUSE, OR INAPPROPRIATE MODIFICATION OR REPAIR.

Application Considerations

SUITABILITY FOR USE

OMRON shall not be responsible for conformity with any standards, codes, or regulations that apply to the combination of products in the customer's application or use of the products.

Take all necessary steps to determine the suitability of the product for the systems, machines, and equipment with which it will be used.

Know and observe all prohibitions of use applicable to this product.

NEVER USE THE PRODUCTS FOR AN APPLICATION INVOLVING SERIOUS RISK TO LIFE OR PROPERTY WITHOUT ENSURING THAT THE SYSTEM AS A WHOLE HAS BEEN DESIGNED TO ADDRESS THE RISKS, AND THAT THE OMRON PRODUCTS ARE PROPERLY RATED AND INSTALLED FOR THE INTENDED USE WITHIN THE OVERALL EQUIPMENT OR SYSTEM.

Disclaimers

PERFORMANCE DATA

Performance data given in this catalog is provided as a guide for the user in determining suitability and does not constitute a warranty. It may represent the result of OMRON's test conditions, and the users must correlate it to actual application requirements. Actual performance is subject to the OMRON *Warranty and Limitations of Liability*.

CHANGE IN SPECIFICATIONS

Product specifications and accessories may be changed at any time based on improvements and other reasons. Consult with your OMRON representative at any time to confirm actual specifications of purchased product.

DIMENSIONS AND WEIGHTS

Dimensions and weights are nominal and are not to be used for manufacturing purposes, even when tolerances are shown.

ALL DIMENSIONS SHOWN ARE IN MILLIMETERS.

To convert millimeters into inches, multiply by 0.03937. To convert grams into ounces, multiply by 0.03527.

Cat. No. N149-E1-02 **In the interest of product improvement, specifications are subject to change without notice.**

OMRON Corporation

Industrial Automation Company

Control Devices Division H.Q.

Shiokoji Horikawa, Shimogyo-ku,
Kyoto, 600-8530 Japan

Tel: (81)75-344-7109/Fax: (81)75-344-7149