

# Floatless Level Controller 61F

## Automatic Water Supply and Drainage Control

- Ideal for level control of any conductive liquid
- Both general-purpose and panel-use models available
- Incorporates an arrester for surge and induced lightning protection
- Wide range of models: Long-distance, high- and low-sensitivity, two-wire, etc.
- LED indicator for quick operation check
- Conforms to EMC/IEC standards (61F-GP-N/-N8/-GPN-V50/-GPN-BT/-GPN-BC)
- UL/CSA approved (61F-GP-N8/-GPN-V50/-GPN-BT/-GPN-BC)

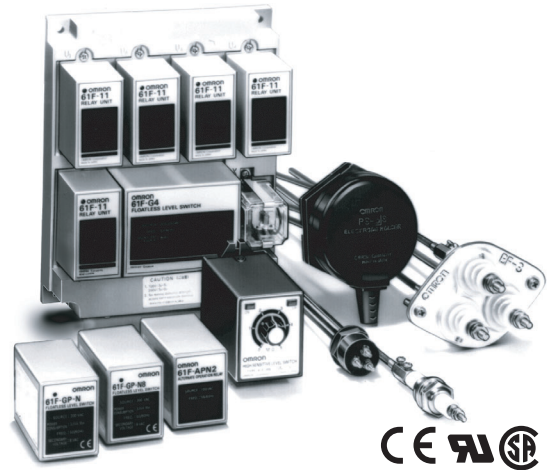

## Operating Principle

Unlike ordinary level switches that use a float for level detection, the 61F Floatless Level Controller uses electrodes to electrically detect the liquid level. The following figures illustrate this simple operating principle.

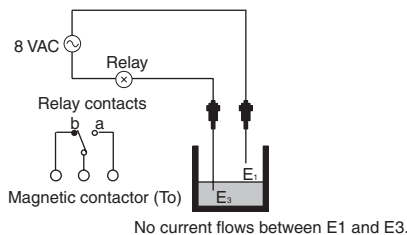

When electrode E1 is not in contact with the conductive liquid, the electrical circuit is open, and no current flows between electrodes E1 and E3.

Consequently, relay X does not operate. Relay X's NC contacts (normally closed, b in the figure) remain closed. However, when liquid is supplied to the tank, so that the liquid contacts or immerses E1, the circuit closes. Relay X operates, and electrical devices connected to the NO (normally open, a in the figure) contacts of the relay begin operation.

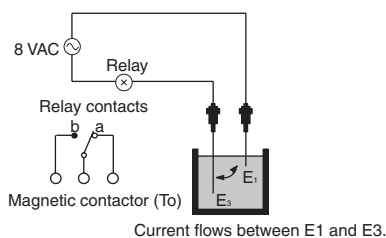

A pump is usually connected to a contactor, which in turn is connected to the Controller contact outputs. The Level Controller would automatically operate the pump, to control the liquid level in the tank.

However, in practice, with only two electrodes, ripples on the surface of the liquid cause the Controller to jump and start, shortening pump (and other equipment) life. This problem can be solved by adding another electrode to form a self-holding circuit. The additional electrode, E2, is connected in parallel with E1, as shown below.

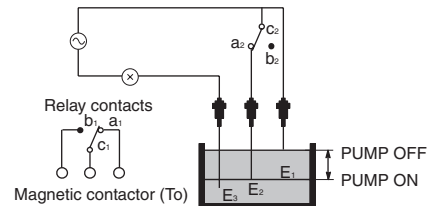

As shown in the above figure, when the holding circuit relay is energized, contact a<sub>2</sub>, its NO contact, is closed. The electrical circuit made through the liquid and the electrodes is then retained by E2 and E3, even when the liquid level falls below E1, as long as contact a<sub>2</sub> is closed.

When the liquid level falls below E2, the circuit made through the electrode circuit opens, which de-energizes relay X, thus closing the NC contact of X.

Operating as simply as it does, possible applications of the Floatless Level Controller are virtually endless. Not only liquid level control is possible, but such applications as leakage detection, object size discrimination, and many other problems may be solved by one of the reliable 61F Floatless Level Controllers.

# Model Selection

## Basic Configuration of 61F Conductive Level Controller

To use a 61F Conductive Level Controller, the 61F itself, Electrode Holders, and Electrodes are required.

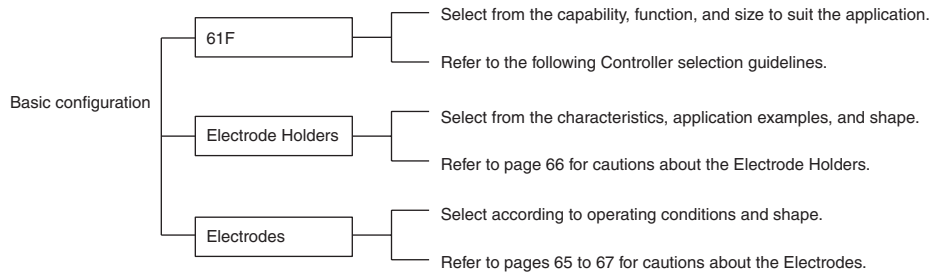

## Typical Application Example

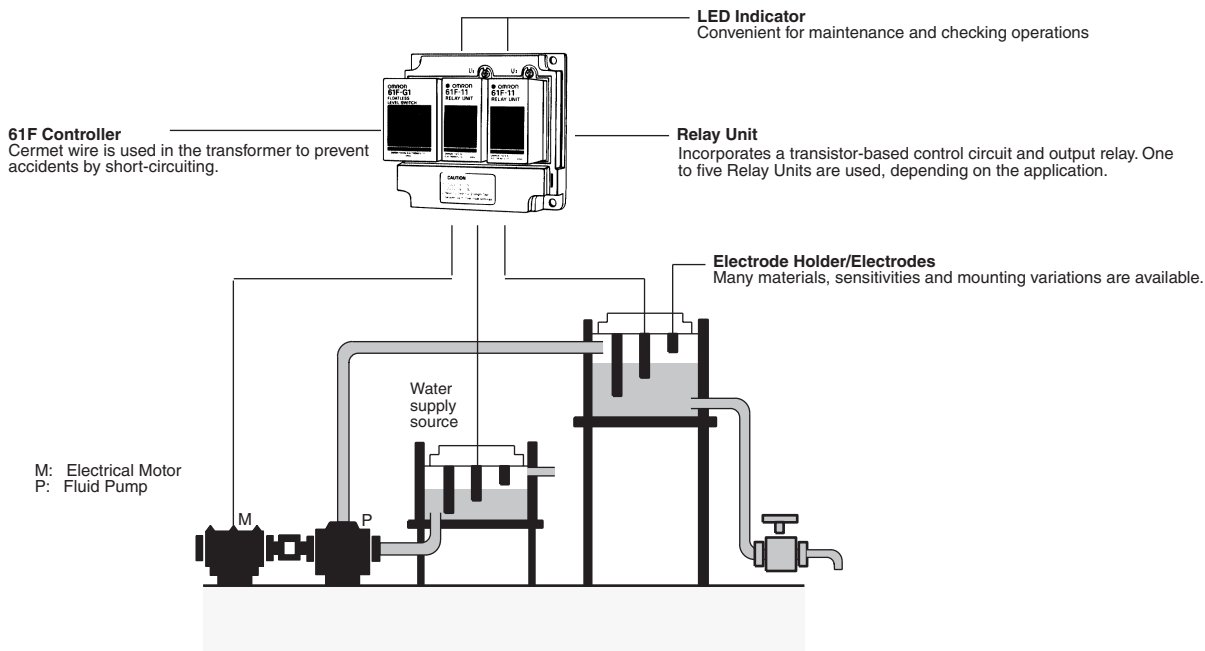

## Ordering Information

### 61F Controller Selection Guide by Installation Method

#### Standard Model

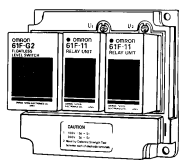

- When there is sufficient mounting space.
- When monitoring operation through LEDs.

#### Plug-in Model Compact Plug-in Model

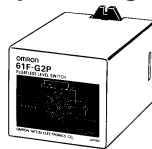



- When using socket mounting.

# 61F Controller Selection Guide by Application

Item		G		G1	
		Automatic water supply and drainage control		Automatic water supply (idling prevention)	Automatic water supply (abnormal shortage alarm)
Function	Automatic pump operation (constant water level)				
	Water level indication abnormal alarm	---			
Appearance		<b>Standard Model</b>  <b>61F-G</b> (Pages 6 to 10, 54)	<b>Compact Plug-in Model</b>  <b>61F-GPN-BT/BC</b> (Pages 18 to 19) <b>61F-GP-N</b> (Pages 20 to 22, 55) <b>61F-GP-N8</b> (Pages 23 to 26, 55)	<b>Standard Model</b>  <b>61F-G1</b> (Pages 6 to 8, 11 to 12, 54)	<b>Plug-in Model</b>  <b>61F-G1P</b> (Pages 27 to 30, 56)

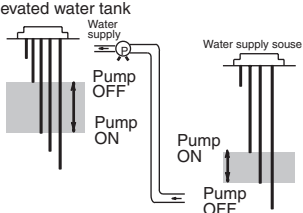
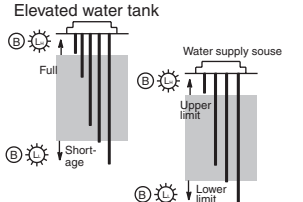
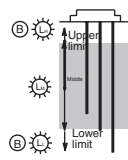
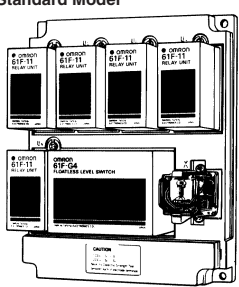
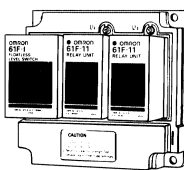
Item		G2		G3
		Automatic water supply and drainage control (abnormal water increase alarm)		Automatic water supply and drainage control (abnormal filling/shortage alarm)
Function	Automatic pump operation (constant water level)			
	Water level indication abnormal alarm			
Appearance		<b>Standard Model</b>  <b>61F-G2</b> (Pages 6 to 8, 13, 54)	<b>Plug-in Model</b>  <b>61F-G2P</b> (Pages 27 to 28, 31, 32, 56)	<b>Standard Model</b>  <b>61F-G3</b> (Pages 6 to 8, 14, 55)

Item		<b>G4</b> <b>Water source level indication, prevention of pump idling due to water shortage, automatic water supply control, and indication of water level in tank</b>	<b>I</b> <b>Liquid level indication and alarm</b>	<b>Alternative operation of two pumps</b>	
<b>Function</b>	<b>Automatic pump operation (constant water level)</b>		<p>---</p>	<p>---</p>	
	<b>Water level indication abnormal alarm</b>			<p>---</p>	
<b>Appearance</b>		<b>Standard Model</b>  <b>61F-G4</b> (Pages 6 to 8, 15, 55)	<b>Standard Model</b>  <b>61F-I</b> (Pages 6, 17, 54)	<b>Plug-in Model</b>  <b>61F-IP</b> (Pages 27 to 28, 33, 56)	<b>Compact plug-in Model</b>  <b>61F-APN2</b> (Pages 36 to 45, 56)

**Related Products**

Relay Unit for standard models (Page 8)

Surge Suppressor Unit (for protecting against induced voltage) (Pages 46, 56)

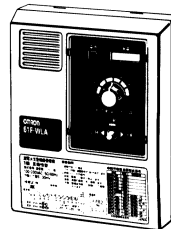
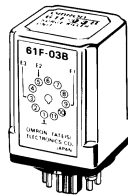

61F-WLA Water Leakage Alarm (Pages 70 to 73)

61F-GPN-V50 Water Leakage Detector (Pages 70 to 73)

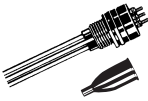

## ■ Accessories

### Electrode Holders

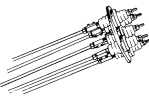
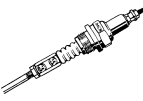
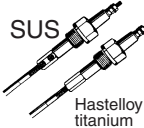
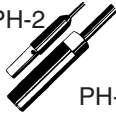
<b>Applications</b>	General applications such as water supply lines	Applications where only a small space is available	Liquid with low specific resistance	Applications where high mounting strength is required	Applications where high temperature/high pressure conditions are severe	Applications where high corrosion resistance is required	Applications where distance to the water surface is long
<b>Models</b>	PS-3S/-4S/-5S (Two-wire models are also available.)	PS-31	BF-1	BF-3/-4/-5	BS-1	BS-1T	PH-1/-2
<b>Appearance</b>						 SUS Hastelloy titanium	 PH-2 PH-1



### Electrodes

Sets of Electrodes, connecting nuts, lock nuts, and spring washers are available. When ordering individual parts, refer to page 52.



<b>Applications</b>	Purified city water, industrial water, sewage	Purified city water, industrial water, sewage, dilute alkaline solution	Sodium hydroxide, acetic acid, dilute sulfuric acid, dilute hydrochloric acid	Sea water, ammonia water, nitric acid	Acetic acid, dilute sulfuric acid, sea water
<b>Models</b>	F03-60-SUS304	F03-60-SUS316	F03-60 HAS B	F03-60 HAS C	F03-60 Titanium

### Others

Item	Model
Protective Cover (for PS or BF electrode holders) 	F03-11
Spring Clamp (for PS electrode holders) 	F03-12
Electrode Separators (for preventing long electrodes from contacting with each other) 	F03-14 1P (for 1 pole) F03-14 3P (for 3 poles) F03-14 5P (for 5 poles)

# Specifications

## ■ Standard Models

### Specifications

Items	General-purpose Controller 61F-□ (TDL) (see note 1 and 2)	High-temperature Controller 61F-□T (see note 1)	Long-distance Controllers 61F-□L 2KM (for 2 km) 61F-□L 4KM (for 4 km) (see note 1)	High-sensitivity Controllers 61F-□H (see note 1)	Low-sensitivity Controller 61F-□D (see note 1)	Two-wire Controller 61F-□R (see note 1)
<b>Controlling materials and operating conditions</b>	For control of ordinary purified water or sewage water	For control of ordinary purified water or sewage water in cases where the ambient temperature is high.	For control of ordinary purified water in cases where the distance between sewage pumps and water tanks or between receiver tanks and supply tanks is long or where remote control is required.	For control of liquids with high specific resistance such as distilled water	For control of liquids with low specific resistance such as salt water, sewage water, acid chemicals, alkali chemicals	For control of ordinary purified water or sewage water used in combination with Two-wire Electrode Holder (incorporating a resistor of 6.8 kΩ)
<b>Supply voltage</b>	100, 110, 120, 200, 220, 230 or 240 VAC; 50/60 Hz					
<b>Operating voltage range</b>	85% to 110% of rated voltage					
<b>Interelectrode voltage</b>	8 VAC			24 VAC	8 VAC	
<b>Interelectrode current</b>	Approx. 1 mA AC max.					
<b>Power consumption</b>	Approx. 3.2 VA max. (One unit)					
<b>Interelectrode operate resistance</b>	0 to approx. 4 kΩ	0 to approx. 5 kΩ	0 to approx. 1.8 kΩ (for 2 km) 0 to approx. 0.7 kΩ (for 4 km)	Approx. 15 kΩ to 70 kΩ (see note 5)	0 to approx. 1.8 kΩ	0 to approx. 1.1 kΩ
<b>Interelectrode release resistance</b>	Approx. 15 k to ∞ Ω	Approx. 15 k to ∞ Ω	4 k to ∞ Ω (for 2 km) 2.5 k to ∞ Ω (for 4 km)	Approx. 300 k to ∞ Ω	Approx. 5 k to ∞ Ω	Approx. 15 k to ∞ Ω
<b>Cable length (see note 3)</b>	1 km max.	600 m max.	2 km max. 4 km max.	50 m max.	1 km max.	800 m max.
<b>Control output</b>	2 A, 220 VAC (Inductive load: $\cos\phi = 0.4$ ) 5 A, 220 VAC (Resistive load)					
<b>Ambient temperature</b>	Operating: -10°C to 55°C (-10°C to 70°C for 61F-□T)					
<b>Ambient humidity</b>	Operating: 45% to 85% RH					
<b>Insulation resistance (see note 4)</b>	100 MΩ min. (at 500 VDC)					
<b>Dielectric strength (see note 4)</b>	2000 VAC, 50/60 Hz for 1 min.					
<b>Life expectancy</b>	Electrical: 500,000 operations min. Mechanical: 5,000,000 operations min.					

- Note:**
- The □ in the model name represents G, G1, G2, G3, G4, and I.
  - The suffix "TDL" attached to the model name represents models designed for tropical regions (storage humidity of 45 to 90% RH).
  - The length when using completely-insulated, 600-V, 3-conductor (0.75 mm<sup>2</sup>) cable cables. Usable cable lengths will become shorter as the cable diameter or number of conductors becomes larger.
  - The insulation resistance and dielectric strength indicate values between power terminals and Electrode terminals, between power terminals and contact terminals, and between Electrode terminals and contact terminals.
  - Possible to use with 15 kΩ or less, however, this may cause reset failure.

## Internal Circuit Diagrams

The schematic diagrams shown below typify the internal connections of the various 61F models. The designations Ta, Tb, and Tc (sometimes referred to collectively as "U") may occur more than once in a product, however, the "a" terminal is always an NO contact, a "b" terminal is an NC contact, and the "c" terminal is the common terminal.

**61F-G**

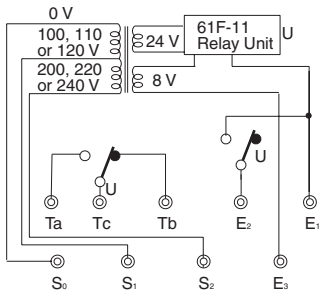

**61F-GT**

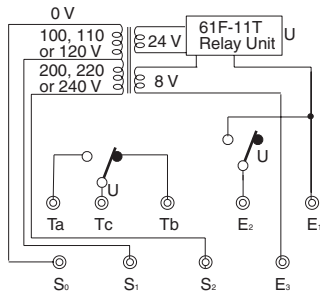

**61F-GL**

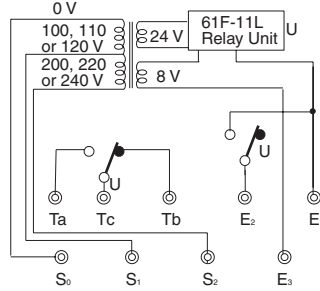

**61F-GH**  
(See note.)

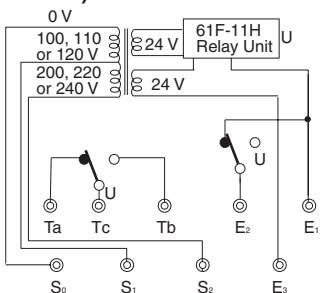

**61F-GD**

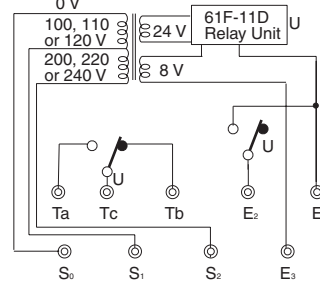

**61F-GR**

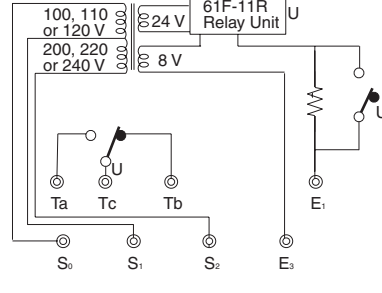

**Note:** The 61F11H relay deenergizes when there is water present across the Electrodes, whereas the 61F relay energizes when there is water present across the Electrodes.

Also, the terminal connections of those Controllers provided with LED indicators differ from those which have no indicators.

### 61F-11 Relay Units

Item	61F-11	61F-11T	61F-11L	61F-11H	61F-11D	61F-11R
Interchangeable with general-purpose model (61F-11)	---	Provided	Provided	Not provided	Provided	Not provided
Color of band on name plate	---	Red	Yellow	Blue	Black	Green

61F-11

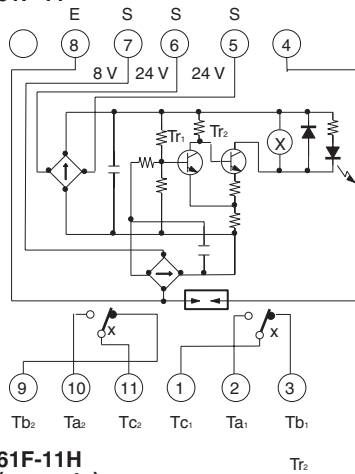

61F-11T

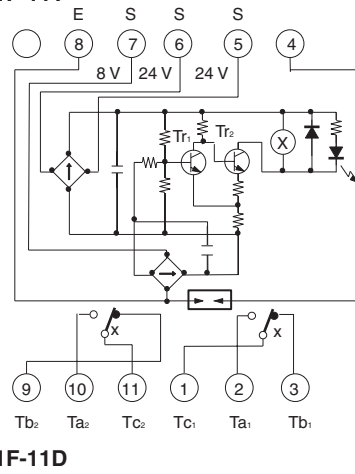

61F-11L

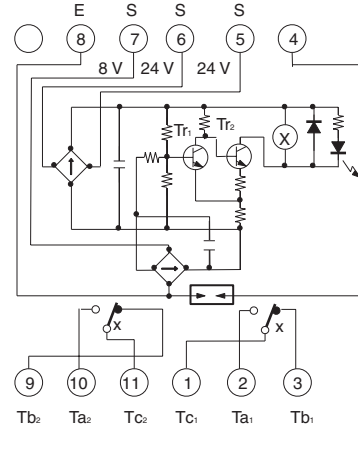

61F-11H  
(see note)

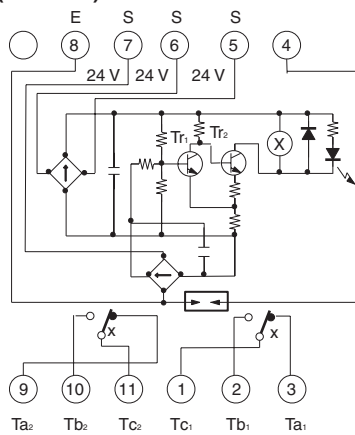

61F-11D

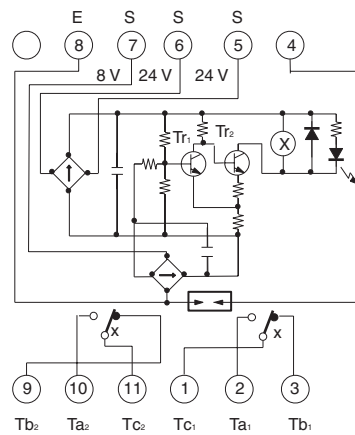

61F-11R

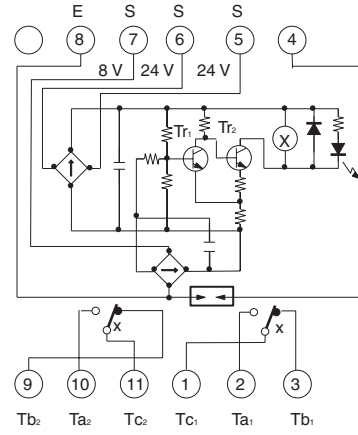



# Connections

## 61F-G

### Automatic Water Supply and Drainage Control

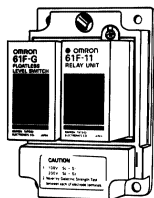

#### 1. Water Supply

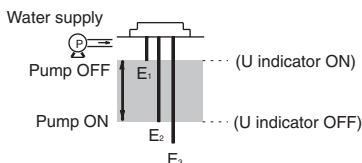

- Connect electromagnetic switch coil terminal A to Tb.
- The pump stops (indicator ON) when the water level reaches E1 and starts (indicator OFF) when the water level drops below E2.

#### 2. Drainage

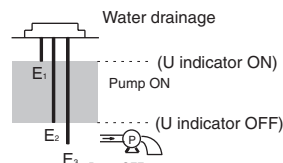

- Connect the electromagnetic switch coil terminal A to Ta.
- The pump starts (indicator ON) when the water level reaches E1 and stops (indicator OFF) when the water level drops below E2.

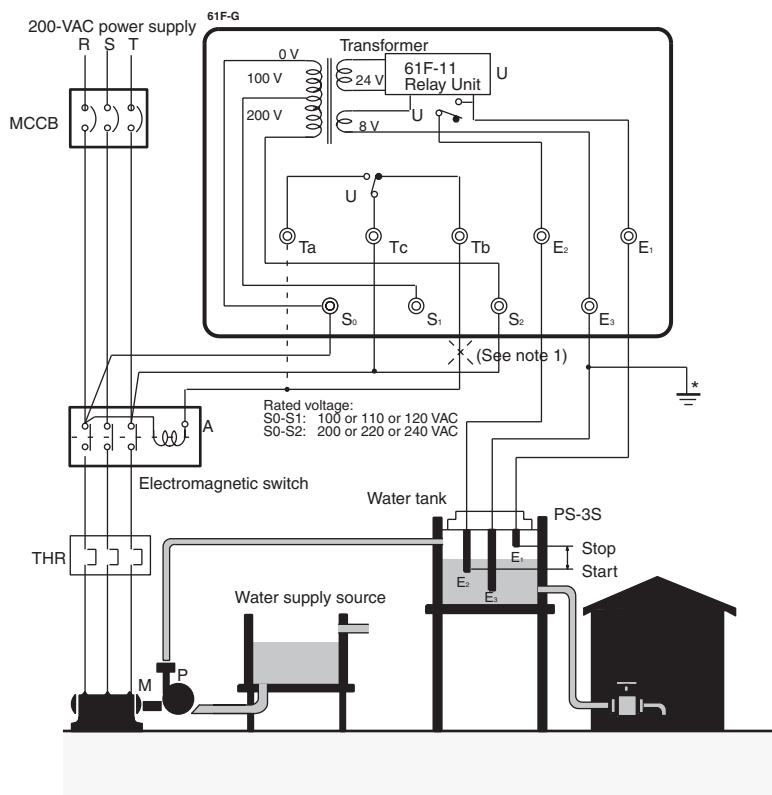

- Note:** 1. The diagram shows the connections for the water supply. When draining, change the connection from terminal Tb to terminal Ta.  
 2. Be sure to ground terminal E3.

# 61F-GR

## Two-wire Automatic Water Supply and Drainage Control

### 1. Water Supply

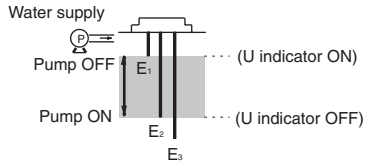

- Connect electromagnetic switch coil terminal A to Tb.
- The pump stops (indicator ON) when the water level reaches E1 and starts (indicator OFF) when the water level drops below E2.

### 2. Drainage

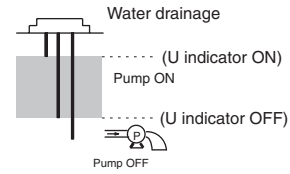

- Connect the electromagnetic switch coil terminal A to Ta.
- The pump starts (indicator ON) when the water level reaches E1 and stops (indicator OFF) when the water level drops below E2.

**Note: 1.** The two-wire models require two cables for connecting the 61F-GR and electrode holders and three electrodes.

**2.** The electrode holders must be special ones for two-wire models. (The resistance R is built into the electrode holder for the two-wire models.)

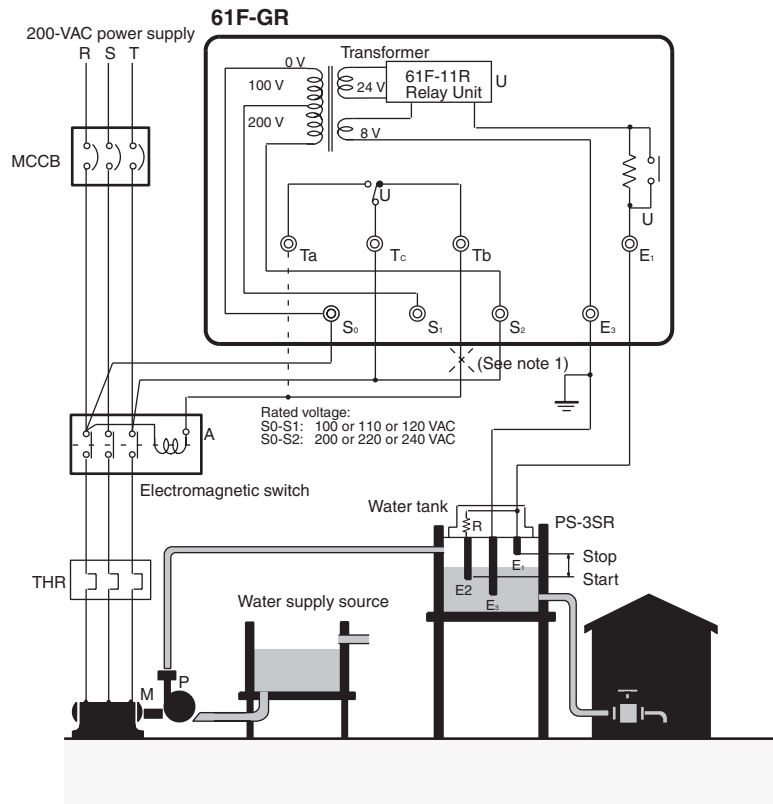

- Note: 1.** The diagram shows the connections for the water supply. When draining, change the connection from terminal Tb to terminal Ta.  
**2.** Be sure to ground terminal E3.

61F-G1

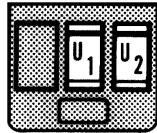
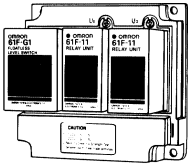

Application 1: Automatic Water Supply Control with Pump Idling Prevention

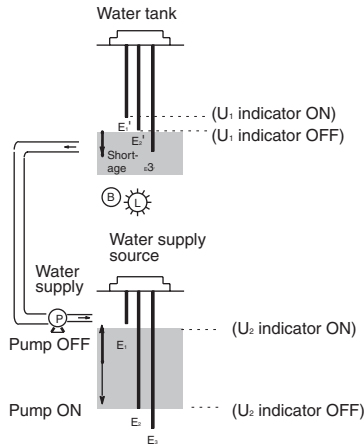

- The pump stops (U2 indicator ON) when the water level reaches E1 and the pump starts (U2 indicator OFF) when the water level in the tank drops below E2.
- When the level of the water supply source drops below E2', the pump stops (U1 indicator OFF). Pump idling is prevented and the alarm sounds.
- Insert a pushbutton switch (NO contact) between E1' and E3 as shown by the dotted line. When starting the pump or after recovering from a power failure, if the water supply source level has not yet reached E1', press the pushbutton switch to start the pump by momentarily short-circuiting E1' and E3. When the pump stops during normal operation subsequent to an alarm issued for a low water level (e.g., the water level does not reach E2'), do not press the pushbutton switch.

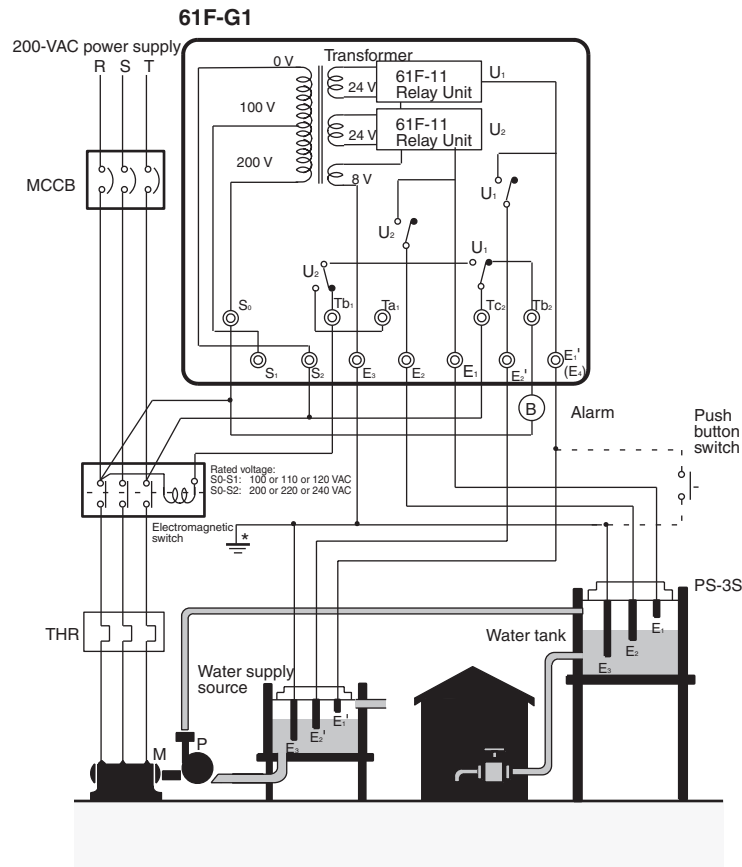

**Note:** Be sure to ground terminal E3.

# 61F-G1

## Application 2: Automatic Water Supply Control with Abnormal Water Shortage Alarm

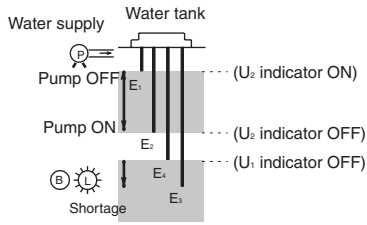

- The pump stops (U<sub>2</sub> indicator ON) when the water level reaches E<sub>1</sub> and starts (U<sub>2</sub> indicator OFF) when the water level drops below E<sub>2</sub>.
- If the water level drops below E<sub>4</sub> for any reason, the pump stops (U<sub>1</sub> indicator OFF) and the alarm sounds.
- Insert a pushbutton switch (NO contact) between E<sub>3</sub> and E<sub>4</sub>. When starting the pump or after recovering from a power failure, if the water level has not yet reached E<sub>4</sub>, press the pushbutton switch to start the pump by short-circuiting E<sub>3</sub> and E<sub>4</sub>. If the pump stops upon releasing the pushbutton switch, keep pressing the pushbutton switch.

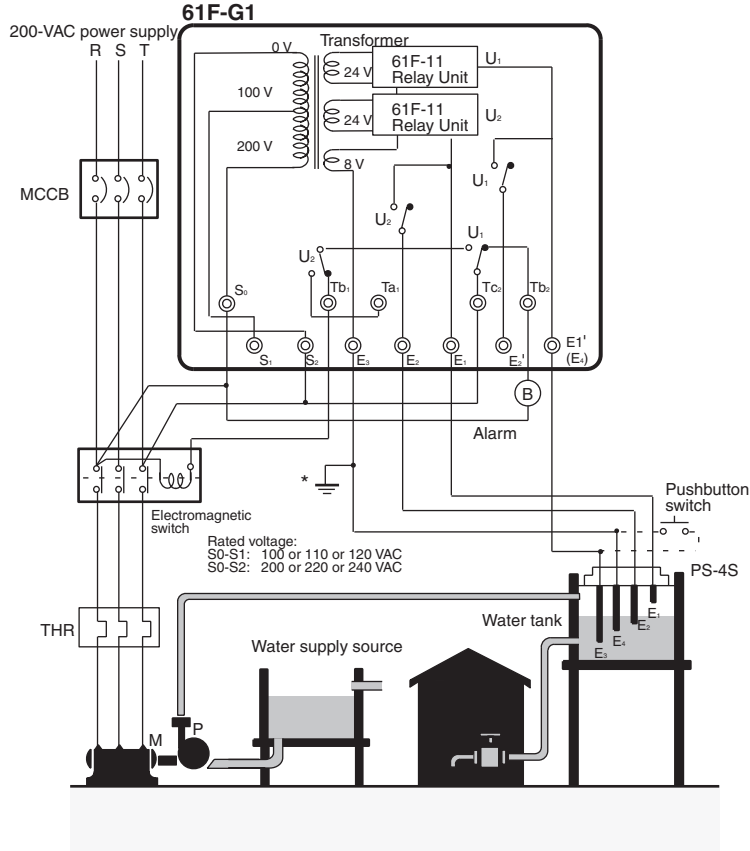

**Note:** Be sure to ground terminal E3.

# 61F-G2

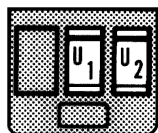
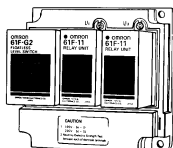

## Automatic Drainage Control and Water Supply with Abnormal Water Increase Alarm

### 1. Drainage

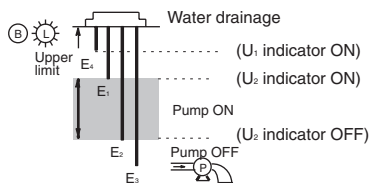

- Connect the electromagnetic switch terminal (T phase) to Ta1.
- The pump starts (U2 indicator ON) when the water level reaches E1 and stops (U2 indicator OFF) when the water level drops below E2.
- If the water level reaches E4 for any reason, the alarm sounds (U1 indicator ON).

### 2. Water Supply

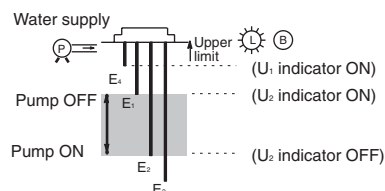

- Connect the electromagnetic switch terminal (T phase) to Tb1.
- The pump starts (U2 indicator OFF) when the water level reaches E2 and stops (U2 indicator ON) when the water level rises to E1.
- If the water level reaches E4 for any reason, the alarm sounds (U1 indicator ON).

### 61F-G2 for drainage control

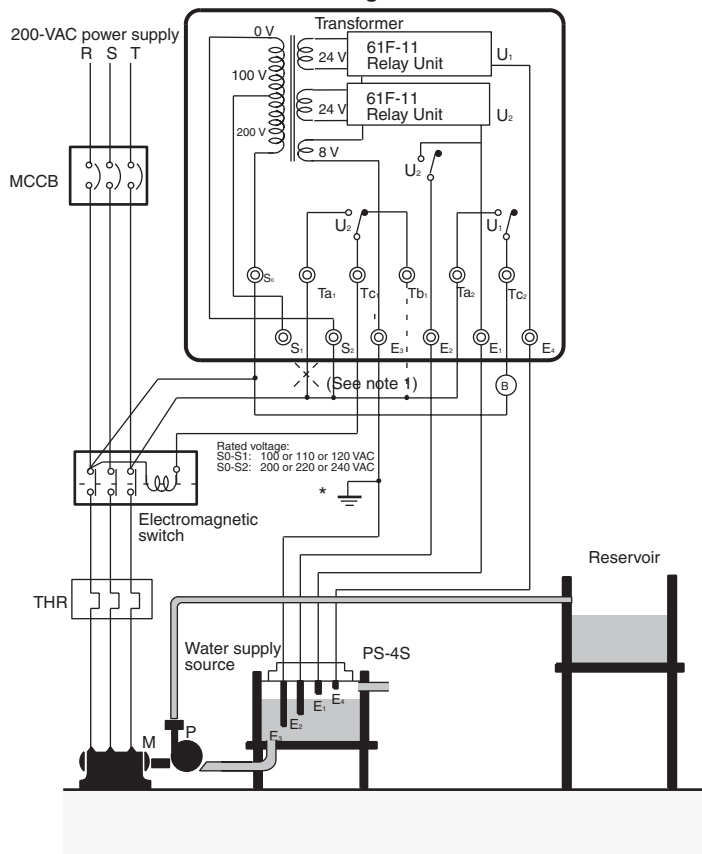

**Note: 1.** The diagram shows the connections for the water supply. When draining, change the connection from terminal Tb1 to terminal Ta1.  
**2.** Be sure to ground terminal E3.

61F-G3

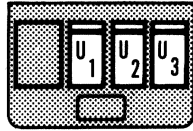
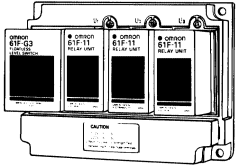

**Automatic Water Supply and Drainage Control with Abnormal Water Shortage Alarm and Water Tank Repletion**

1. Water Supply

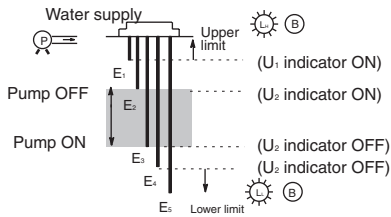

- Connect electromagnetic switch coil terminal A with Tb.
- The pump stops (U2 indicator ON) when the water level reaches E2 and starts (U2 indicator OFF) when the water level drops below E3.
- If the water level rises to E1 for any reason, the upper-limit indicator turns ON and the alarm sounds (U1 indicator ON).
- If the water level drops below E4 for any reason, the lower-limit indicator turns ON and the alarm sounds (U3 indicator OFF).

2. Drainage

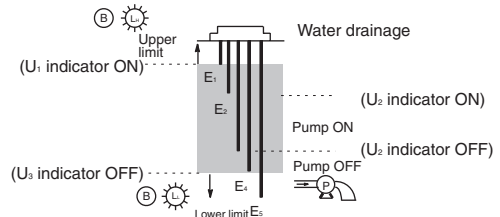

- Connect the electromagnetic switch coil terminals A with Ta.
- The pump starts (U2 indicator ON) when the water level reaches E2 and stops (U2 indicator OFF) when the water level drops below E3.
- If the water level rises to E1 for any reason, the upper-limit indicator turns ON and the alarm sounds (U1 indicator ON).
- If the water level drops below E4 for any reason, the lower-limit indicator turns ON and the alarm sounds (U3 indicator OFF).

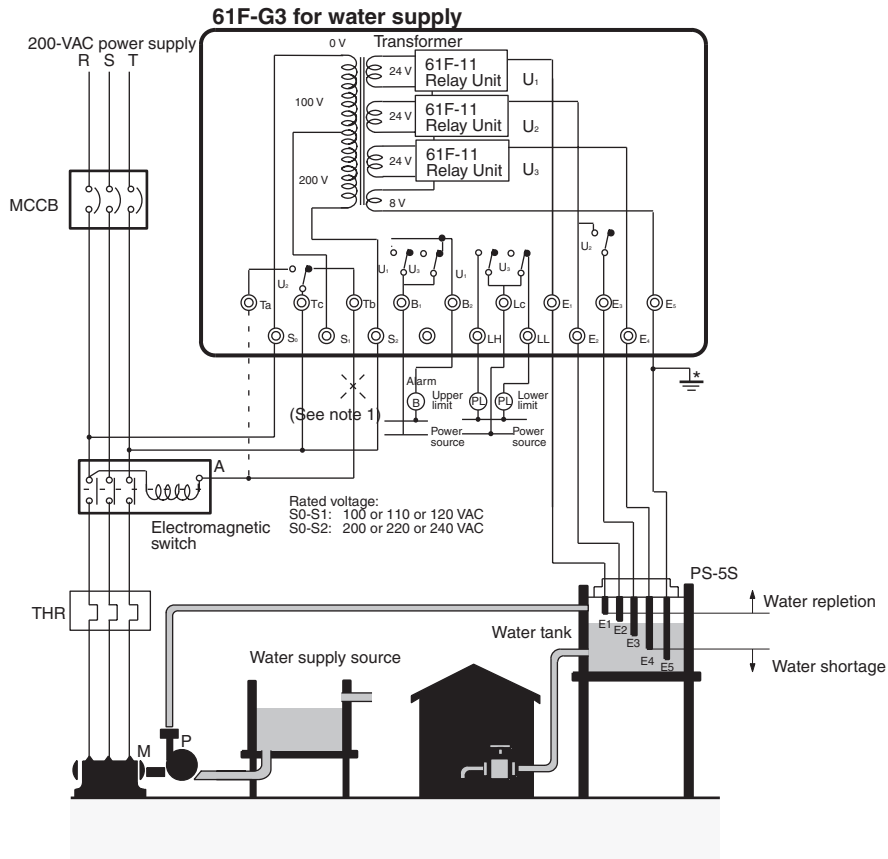

**Note:** 1. The diagram shows the connections for the water supply. When draining, change the connection from terminal Tb to terminal Ta.  
 2. Be sure to ground terminal E5.

61F-G4

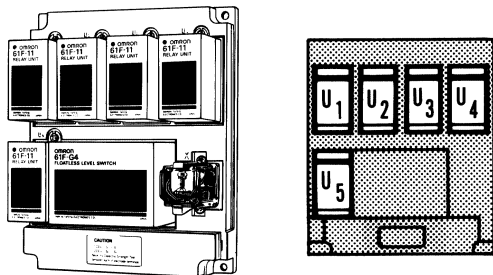

**Water Source Level Indication, Prevention of Pump Idling Due to Water Shortage, Automatic Water Supply Control, and Indication of Water Level in Tank**

- Insert four Electrodes in the water supply source and five Electrodes in the elevated water tank.
- The lower-limit indicator for the water supply source remains ON while the water source level is below E3 (U2 indicator OFF).
- When the water level rises to E2, the lower-limit indicator turns OFF (U2 indicator ON) and the pump is ready for operation.
- When the water level reaches E1, the upper-limit indicator turns ON (U3 indicator ON).
- The water-shortage indicator for the elevated tank remains ON while the water level in the elevated tank is below E7. The indicator turns OFF (U1 indicator ON) when the water level rises to E7.
- The pump stops (U5 indicator ON) when the water level reaches E5 and starts (U5 indicator OFF) when the water level drops below E6.
- If the water level reaches E4 for any reason, the tank repletion indicator for the elevated tank turns ON (U4 indicator ON).
- Insert a pushbutton switch (NO contact) between E2 and E8 as shown by the dotted line. When starting the pump and after recovering from a power failure, if the water source level has not yet reached E2 (U2 indicator OFF), press the pushbutton switch to start the pump by momentarily short-circuiting E2 and E8. When the pump stops during normal operation subsequent to an alarm issued for low water level (i.e., the water level has not reached E3), do not press the pushbutton switch.

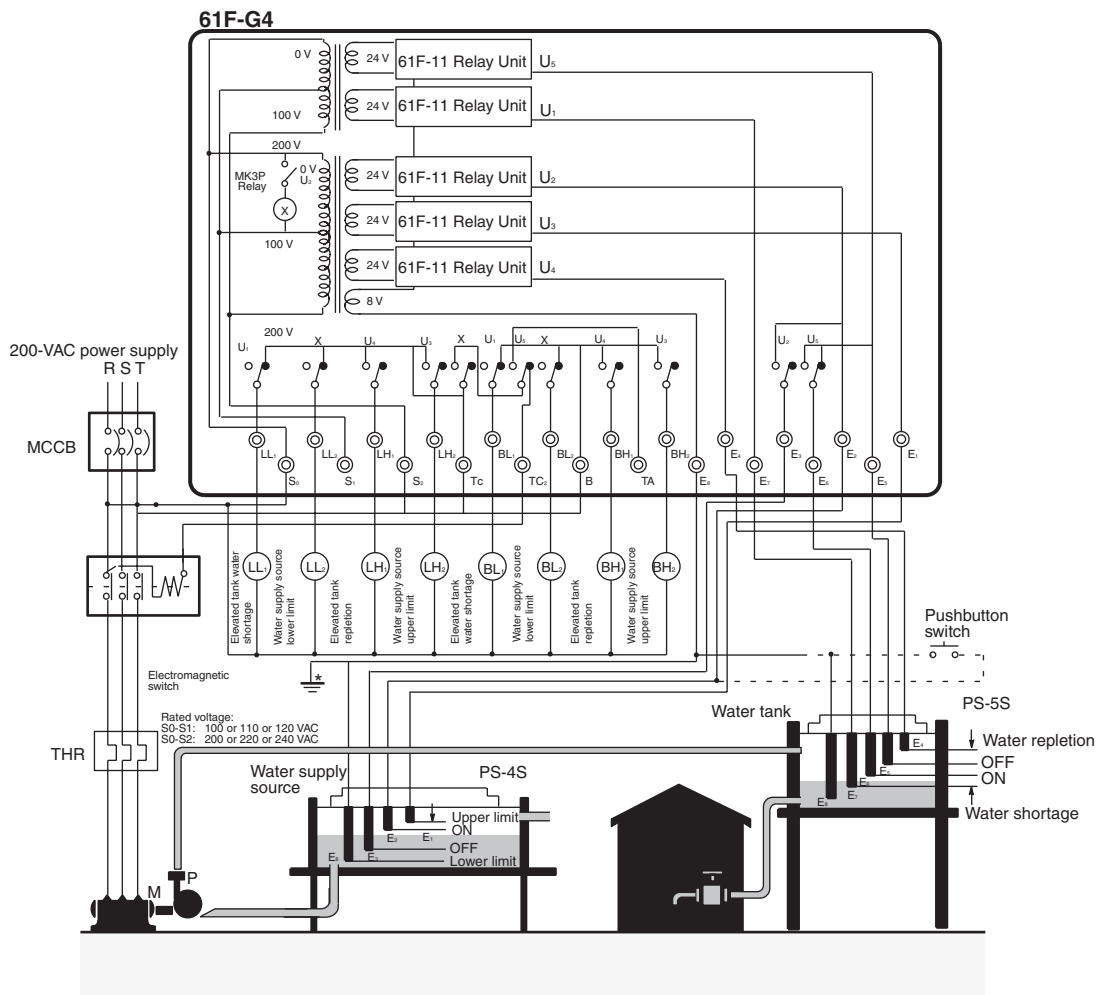

**Note: 1.** Be sure to ground terminal E8.

## ■ Connection with Three-phase Four-line Circuit

When supplying power from N-phase to the Controller in three-phase four-line circuit, refer to the following diagrams.

Line voltage (R-S, S-T, or R-T): 380 or 415 VAC

Phase voltage (N-R, N-S, or N-T): 220 or 240 VAC

### 61F-G□, 220 or 240 VAC

#### Water Supply

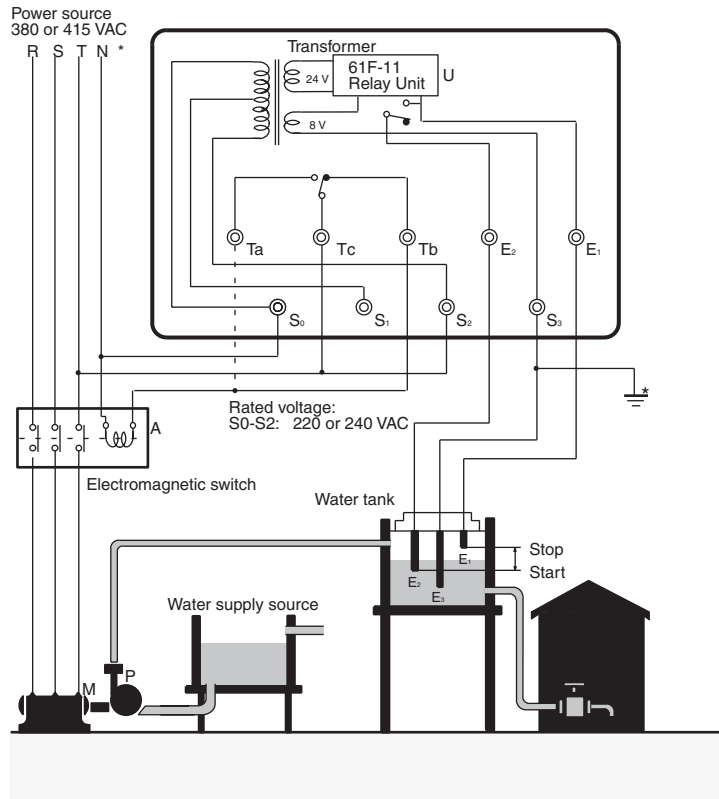

**Note:** Be sure to ground terminal E3.



# 61F-I

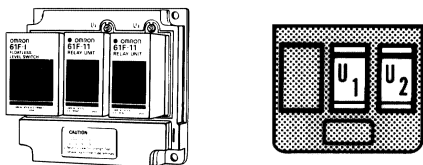

## Liquid Level Indication and Alarm

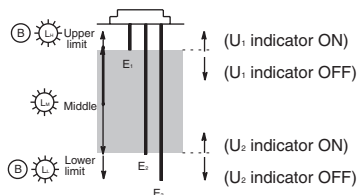

- When the water level drops below E2, the lower-limit indicator turns ON and the alarm sounds (U2 indicator OFF).
- When the water level reaches E2, the alarm turns OFF and the intermediate indicator turns ON (U2 indicator ON).
- When the water level rises to E1, the upper-limit indicator turns ON and the alarm sounds (U1 indicator ON).

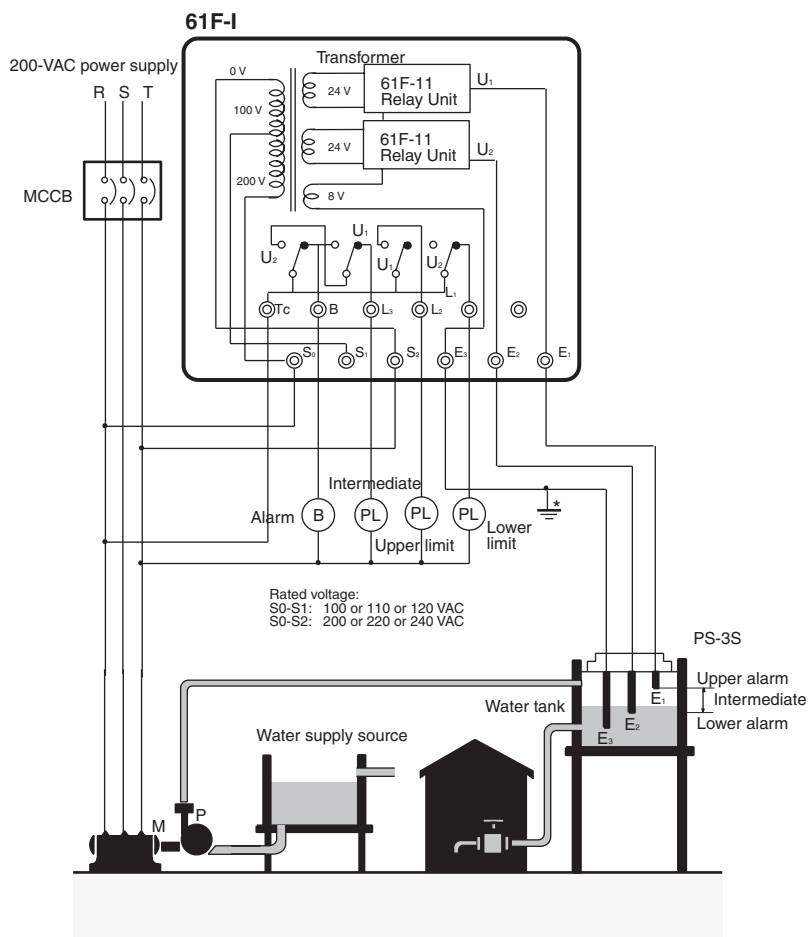

**Note:** Be sure to ground terminal E3.

# Application Examples

**Applications**



Drainage control for semiconductor wafer cleaning installations.

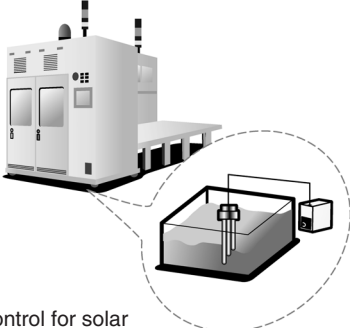

Meet safety standards by using DC power supply for all devices in a panel.



Liquid level control for waste-heat recovery boilers in co-generation systems.

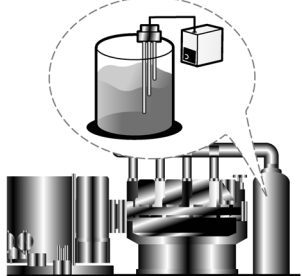

Liquid level control for solar power generation systems.

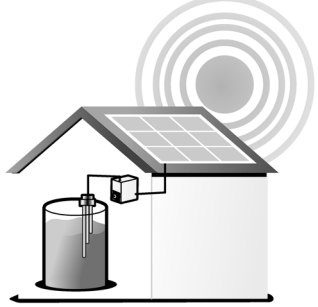

Liquid level control for remote regions without AC power supply.

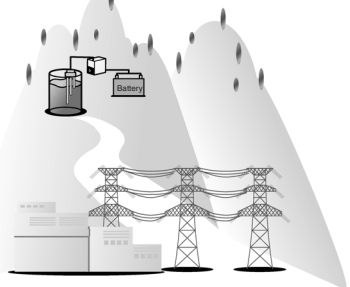

Cut costs by using the 61F in situations where ultrasonic/electrostatic capacity level controllers were used because only DC power supply was available.

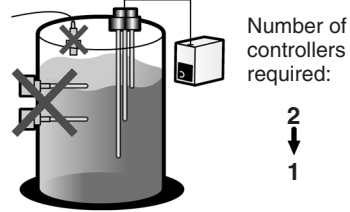

Number of controllers required:  
2  
↓  
1

## Ordering Information

Product name	Model number	
Conductive Level Controller	61F-GPN-BT	61F-GPN-BC
	Open collector (NPN)	Relay contact (SPST-NO)
Front Socket	PF113A-E	
Electrode Holder	(See note.)	

**Note:** A variety of Holders are available to suit different types of application. For details, refer to *61F Floatless Level Controller (F030-E1-8)*.

## Specifications

### ■ Ratings

	61F-GPN-BT	61F-GPN-BC
<b>Rated voltage</b>	24 VDC	
<b>Allowable voltage range</b>	85% to 110% of the rated voltage	
<b>Interelectrode voltage</b>	5 VAC max.	
<b>Operation resistance (See note 1.)</b>	Variable (0 to 100 kΩ)	
<b>Error</b>	For scale of 0: +10 kΩ; For scale of 100: ±10 kΩ	
<b>Release resistance</b>	200% max. of the operation resistance	
<b>Switching between supply and drainage</b>	Terminals 7 and 8 open: Automatic drainage operation Terminals 7 and 8 shorted: Automatic supply operation	
<b>Output specifications</b>	Open collector (NPN) 30 VDC, 100 mA max.	SPST-NO 5 A, 240 VAC (Resistive load) 2 A, 240 VAC (Inductive load: cosφ=0.4)
<b>Life expectancy</b>	---	Electrical: 100,000 operations min. Mechanical: 20,000,000 operations min.
<b>Wiring distance (See note 2.)</b>	100 m max.	

**Note:** 1. The 61F may not operate at resistance settings close to zero. Adjust the sensitivity to match actual usage conditions.  
2. The figure for wiring distance above is for when 600-V 3-core cable with a cross-sectional area of 0.75 mm<sup>2</sup> is used.

## ■ Characteristics

<b>Ambient operating temperature</b>	-10 to 55°C
<b>Ambient operating humidity</b>	25% to 85%
<b>Insulation resistance</b>	100 MΩ min. (at 500 VDC)
<b>Dielectric strength (See note.)</b>	2,000 VAC, 50/60 Hz for 1 minute
<b>Power consumption</b>	2 W max.
<b>Response time</b>	Operating: 1.5 s max. Releasing: 3.0 s max.

**Note:** The dielectric strength is measured between power terminals and electrode terminals, power terminals and output terminals, and between electrode terminals and output terminals.

## Connections

### ■ Automatic Drainage Operation

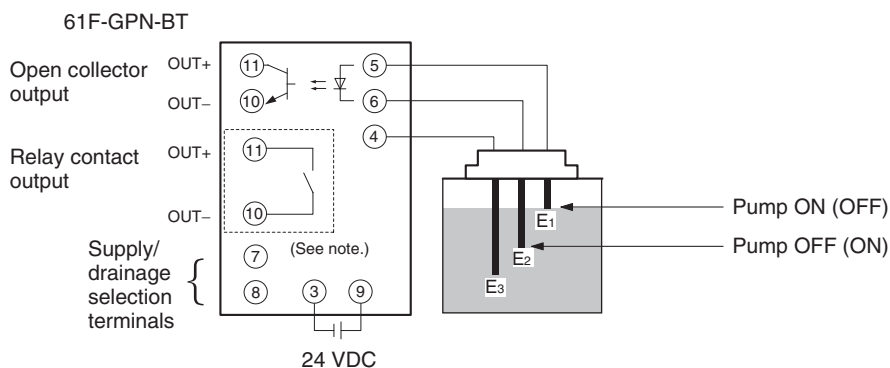

**Note:** [ ] The part within the dotted-line box is for the 61F-GPN-BC (relay-output type) only.

### ■ Automatic Water Supply Operation

Short terminals 7 and 8 for automatic water supply operation. (Operation shown in parentheses in the diagram above.)

### ■ Reading Signals for the Liquid Level Only (No Control)

Only E1 and E3 are used. Output will turn ON when the liquid level reaches E1 if terminals 7 and 8 are open, and will turn OFF if terminals 7 and 8 are closed. Also, to take signals for liquid level at several points, use terminal 4 as a common for all of the Controllers and use terminal 5 of each Controller as an electrode.

**Note:** If terminals 7 and 8 are shorted, operation of the 61F relay is "de-energizing" (i.e., energized normally and de-energized when liquid is present across the electrodes). Therefore, if the power supply connected across terminals 3 and 9 is interrupted, the output from terminals 10 and 11 will turn OFF, enabling detection of power interruptions.

## Dimensions

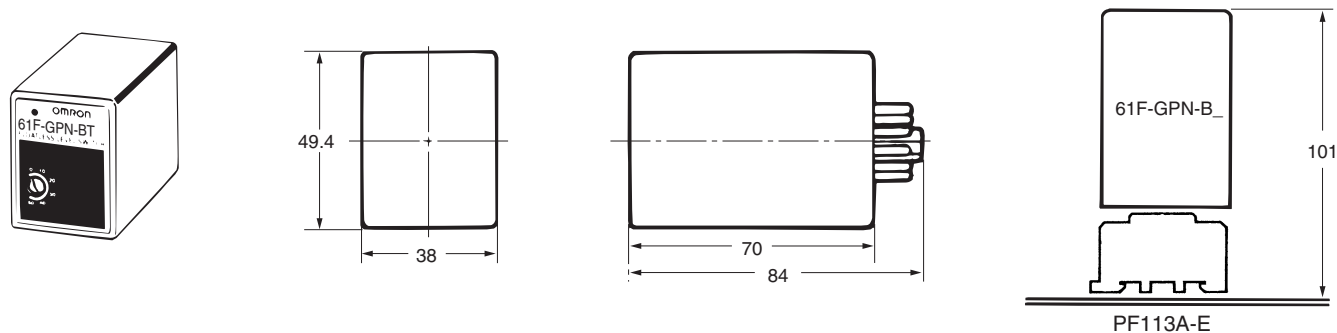

## ■ Compact Plug-in Models (11-pin Type)

### Specifications

Item	General-purpose Controller 61F-GP-N	High-temperature Controller 61F-GP-NT	Long-distance Controllers 61F-GP-NL 2KM (for 2 km) 61F-GP-NL 4KM (for 4 km)	High-sensitivity Controller 61F-GP-NH (see note 1)	Low-sensitivity Controller 61F-GP-ND	Two-wire Controller 61F-GP-NR
<b>Controlling materials and operating conditions</b>	For control of ordinary purified water or sewage water	For control of ordinary purified water or sewage where operating ambient temperature is high.	For control of ordinary purified water in cases where the distance between sewage pumps and water tanks or between receiver tanks and supply tanks is long or where remote control is required.	For control of liquids with high specific resistance such as distilled water	For control of liquids with low specific resistance such as salt water, sewage water, acid chemicals, alkali chemicals	For control of ordinary purified water or sewage water used in combination with Two-wire Electrode Holder (incorporating a resistor of 6.8 kΩ)
<b>Supply voltage</b>	24, 100, 110, 120, 200, 220, 230 or 240 VAC; 50/60 Hz					
<b>Operating voltage range</b>	85% to 110% of rated voltage					
<b>Interelectrode voltage</b>	8 VAC					
<b>Interelectrode current</b>	Approx. 1 mA AC max.			Approx. 0.12 mA AC max.	Approx. 1 mA AC max.	
<b>Power consumption</b>	Approx. 3.2 VA max.					
<b>Interelectrode operate resistance</b>	0 to approx. 4 kΩ	0 to approx. 4 kΩ	0 to approx. 1.3 kΩ (for 2 km) 0 to approx. 0.5 kΩ (for 4 km)	Approx. 10 kΩ to approx. 40 kΩ (see note 4)	0 to approx. 1.3 kΩ	0 to approx. 2 kΩ
<b>Interelectrode release resistance</b>	Approx. 15 k to ∞ Ω	Approx. 15 k to ∞ Ω	4 k to ∞ Ω (for 2 km) 0.5 k to ∞ Ω (for 4 km)	Approx. 100 k to ∞ Ω	Approx. 4 k to ∞ Ω	Approx. 15 k to ∞ Ω
<b>Response time</b>	Operate: 80 ms max. Release: 160 ms max.					
<b>Cable length (see note 2)</b>	1 km max.	600 m max.	2 km max. 4 km max.	50 m max.	1 km max.	800 m max.
<b>Control output</b>	1 A, 250 VAC (Inductive load: $\cos\phi = 0.4$ ) 3 A, 250 VAC (Resistive load)					
<b>Ambient temperature</b>	Operating: -10°C to 55°C (-10°C to 70°C for high-temperature controller)					
<b>Ambient humidity</b>	Operating: 45% to 85% RH					
<b>Insulation resistance (see note 3)</b>	100 MΩ min. (at 500 VDC)					
<b>Dielectric strength (see note 3)</b>	2000 VAC, 50/60 Hz for 1 min.					
<b>Life expectancy</b>	Electrical: 100,000 operations min. Mechanical: 5,000,000 operations min.					

- Note:**
1. The relay in the 61F-GP-NH de-energizes when there is water present across the Electrodes, whereas the relay in the 61F-GP-N8HY energizes when there is water present across the Electrodes.
  2. The length when using completely-insulated, 600-V, 3-conductor (0.75 mm<sup>2</sup>) cable cables. Usable cable lengths will become shorter as the cable diameter or number of conductors becomes larger.
  3. The insulation resistance and dielectric strength indicate values between power terminals and Electrode terminals, between power terminals and contact terminals, and between Electrode terminals and contact terminals.
  4. Possible to use with 10 kΩ or less, however, this may cause reset failure.

## Internal Circuit Diagrams

### 61F-GP-N/-NT/-NL/-ND

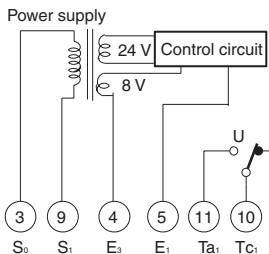

### 61F-GP-NH

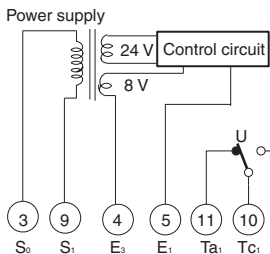

### 61F-GP-NR

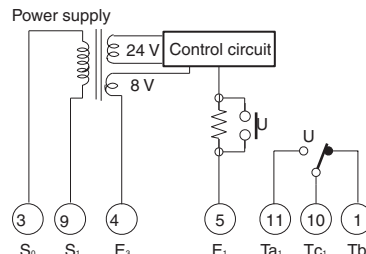

**Note:** When applying a self-holding circuit, short between terminals 5 and 6 and use terminal 7 as E<sub>2</sub>.

## Connections

### 61F-GP-N



## Automatic Water Supply and Drainage Control

### 1. Water Supply

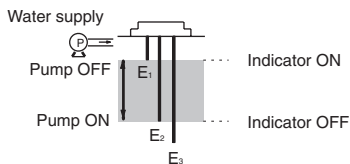

### 2. Drainage

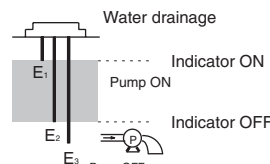

- Connect electromagnetic switch coil terminal A to terminal 1.
- The pump stops when the water level reaches E1 (indicator ON) and starts when the water level drops below E2 (indicator OFF).

- Connect the electromagnetic switch coil terminal to terminal 11.
- Pump starts when the water level reaches E1 (indicator ON) and stops when the water level drops below E2 (indicator OFF).

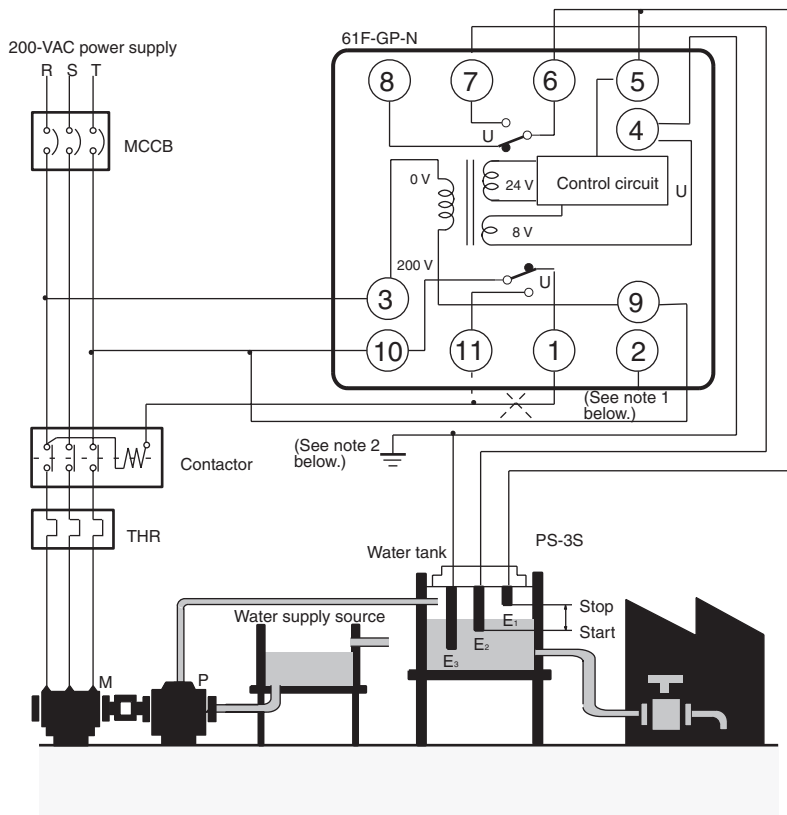

**Note:** 1. The diagram shows the connections for the water supply. When draining, change the connection from terminal 1 to terminal 11.  
2. Be sure to ground terminal 4.

## ■ Connection with Three-phase Four-line Circuit

When supplying power from N-phase to the Controller in three-phase four-line circuit, refer to the following diagrams.

Line voltage (R-S, S-T, or R-T): 380 or 415 VAC

Phase voltage (N-R, N-S, or N-T): 220 or 240 VAC

### 61F-GP-N □ 220 or 240 VAC

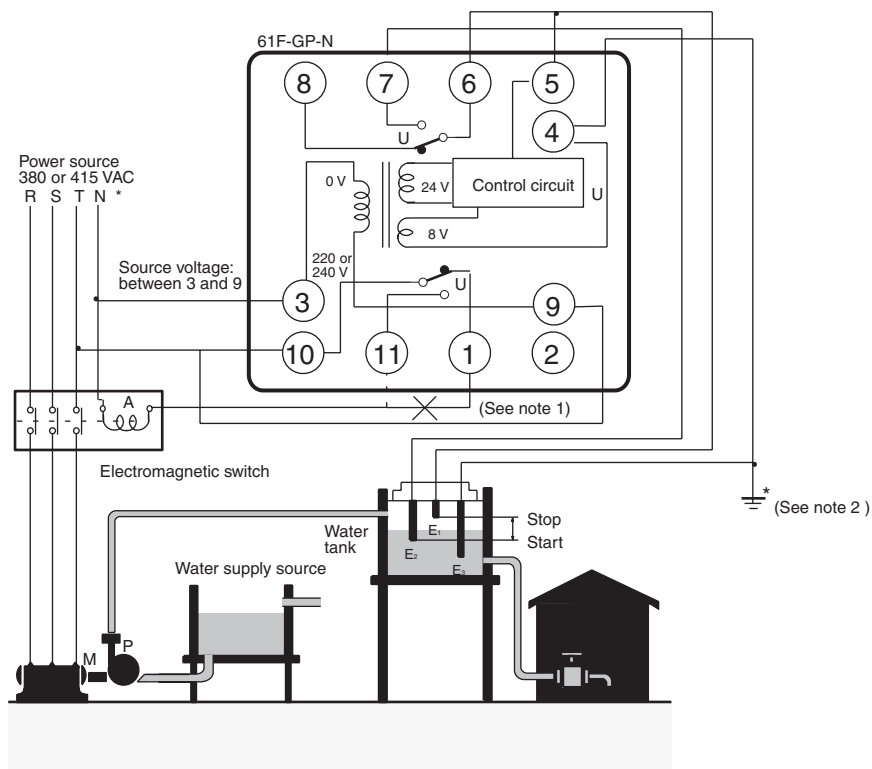

- Note: 1.** The diagram shows the connections for the water supply. When draining, change the connection from terminal 1 to terminal 11.  
**2.** Be sure to ground terminal 4.

## ■ Compact Plug-in Models (8-pin Type)

### Specifications

Item	General-purpose Controller 61F-GP-N8 61F-GP-N8Y (see note 1)	Long-distance Controllers 61F-GP-N8L 2KM (for 2 km) 61F-GP-N8L 4KM (for 4 km)	High-sensitivity Controllers 61F-GP-N8H 61F-GP-N8HY (see note 1)	Low-sensitivity Controller 61F-GP-N8D	Two-wire Controller 61F-GP-N8R	Variable Sensitivity Controller 61F-GP-N8-V50
<b>Controlling materials and operating conditions</b>	For control of ordinary purified water or sewage water	For control of ordinary purified water in cases where the distance between sewage pumps and water tanks or between receiver tanks and supply tanks is long or where remote control is required.	For control of liquids with high specific resistance such as distilled water	For control of liquids with low specific resistance such as salt water, sewage water, acid chemicals, alkali chemicals	For control of ordinary purified water or sewage water used in combination with Two-wire Electrode Holder (incorporating a resistor of 6.8 k $\Omega$ )	For control of cases where variable sensitivity control is required such as detection of froth on the surface of a liquid, control of soil moisture content, or detection of degree of water pollution
<b>Supply voltage</b>	24, 100, 110, 120, 200, 220, 230 or 240 VAC; 50/60 Hz					24, 110, 220 or 240 VAC; 50/60 Hz
<b>Operating voltage range</b>	85% to 110% of rated voltage					
<b>Interelectrode voltage</b>	8 VAC		24 VAC	8 VAC		24 VAC
<b>Interelectrode current</b>	Approx. 1 mA AC max.		Approx. 0.4 mA AC max.	Approx. 1 mA AC max.		Approx. 3 mA AC max.
<b>Power consumption</b>	Approx. 3.5 VA max.					
<b>Interelectrode operate resistance</b>	0 to approx. 4 k $\Omega$	0 to 1.3 k $\Omega$ (for 2 km) 0 to 0.5 k $\Omega$ (for 4 km)	Approx. 15 k $\Omega$ to approx. 70 k $\Omega$ (see note 4)	0 to approx. 1.3 k $\Omega$	0 to approx. 2 k $\Omega$	0 to 50 k $\Omega$ (Variable)
<b>Interelectrode release resistance</b>	Approx. 15 k to $\infty$ $\Omega$	4 k to $\infty$ $\Omega$ (for 2 km) 0.5 k to $\infty$ $\Omega$ (for 4 km)	Approx. 300 k to $\infty$ $\Omega$	Approx. 4 k to $\infty$ $\Omega$	Approx. 15 k to $\infty$ $\Omega$	Operating resistance +50 k $\Omega$ max.
<b>Response time</b>	Operate: 80 ms max. Release: 160 ms max.					
<b>Cable length (see note 2)</b>	1 km max.	2 km max. 4 km max.	50 m max.	1 km max.	800 m max.	50 m max.
<b>Control output</b>	1 A, 250 VAC (Inductive load: $\cos\phi = 0.4$ ) 3 A, 250 VAC (Resistive load)					
<b>Ambient temperature</b>	Operating: -10°C to 55°C					
<b>Ambient humidity</b>	Operating: 45% to 85% RH					
<b>Insulation resistance (see note 3)</b>	100 M $\Omega$ min. (at 500 VDC)					
<b>Dielectric strength (see note 3)</b>	2000 VAC, 50/60 Hz for 1 min.					
<b>Life expectancy</b>	Electrical: 100,000 operations min. Mechanical: 5,000,000 operations min.					

- Note:**
1. The relay in the 61F-GP-N8H/-N8Y de-energizes when there is water present across the Electrodes, whereas the relay in the 61F-GP-N8HY energizes when there is water present across the Electrodes.
  2. The length when using completely-insulated, 600-V, 3-conductor (0.75 mm<sup>2</sup>) cable cables. Usable cable lengths will become shorter as the cable diameter or number of conductors becomes larger.
  3. The insulation resistance and dielectric strength indicate values between power terminals and Electrode terminals, between power terminals and contact terminals, and between Electrode terminals and contact terminals.
  4. Possible to use with 10 k $\Omega$  or less, however, this may cause reset failure.

## Internal Circuit Diagrams

**61F-GP-N8/-N8L/-N8D/-N8HY**

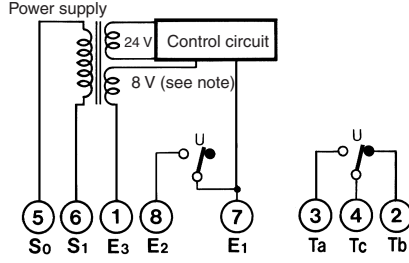

**61F-GP-N8H**

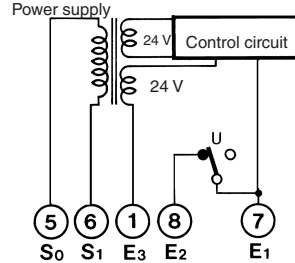

**61F-GP-N8R**

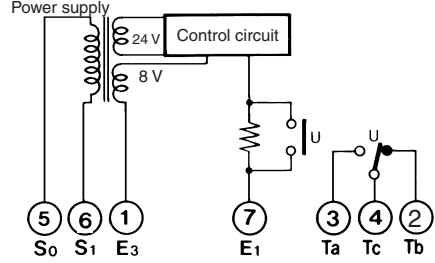

**Note:** 24 V for the 61F-GP-N8HY.

**61F-GP-N8Y**

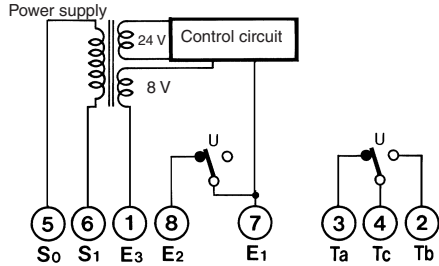

**61F-GP-N8-V50**

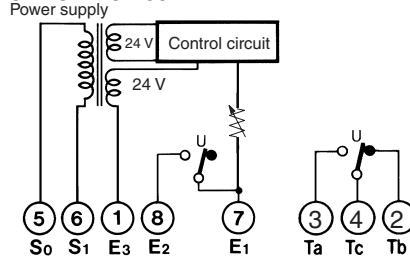



## Connections

### 61F-GP-N8



### Automatic Water Supply and Drainage Control

#### 1. Water Supply

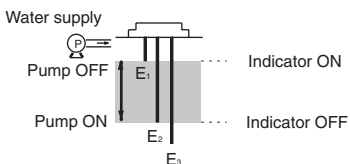

#### 2. Drainage

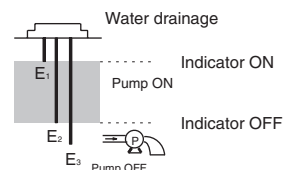

- Connect electromagnetic switch coil terminal A to terminal 2.
- The pump stops when the water level reaches E1 (indicator ON) and starts when the water level drops below E2 (indicator OFF).
- Connect the electromagnetic switch coil terminal A to terminal 3.
- The pump starts when the water level reaches E1 (indicator ON) and stops when the water level drops below E2 (indicator OFF).

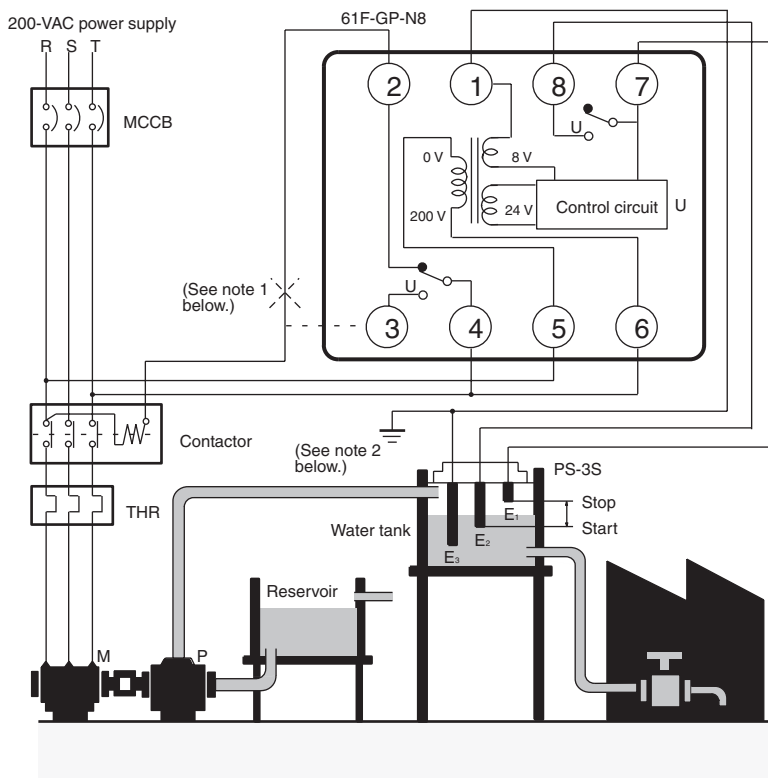

- Note:** 1. The diagram shows the connections for the water supply. When draining, change the connection from terminal 2 to terminal 3.  
 2. The ground terminal must be grounded.

## ■ Connection with Three-phase Four-line Circuit

When supplying power from N-phase to the Controller in three-phase four-line circuit, refer to the following diagrams.

Line voltage (R-S, S-T, or R-T): 380 or 415 VAC

Phase voltage (N-R, N-S, or N-T): 220 or 240 VAC

### 61F-GP-N8□, 220 or 240 VAC

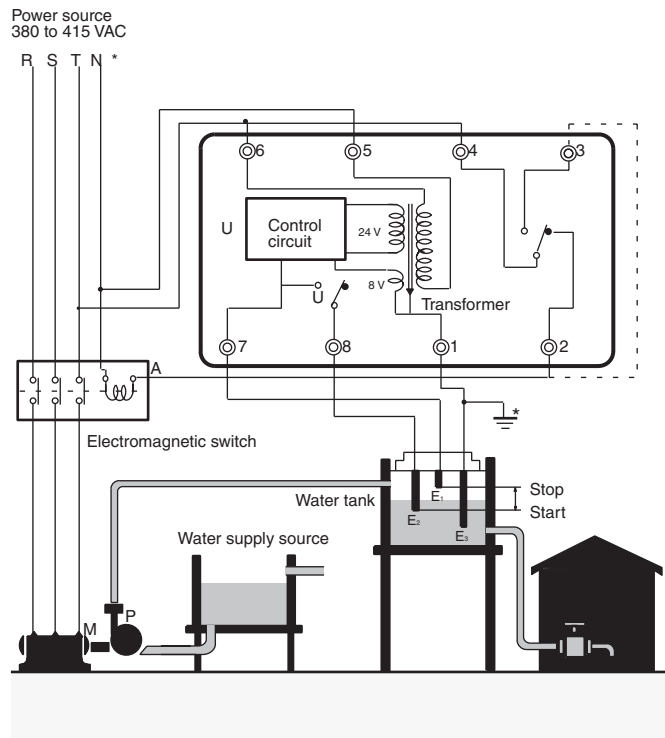

**Note:** Be sure to ground terminal 1.

## ■ Plug-in Models

### Specifications

Item	General-purpose Controller 61F-G1P 61F-G2P 61F-IP	Long-distance Controllers 61F-G1PL 61F-G2PL 61F-IPL (see note 2)	High-sensitivity Controllers 61F-G1PH 61F-G2PH 61F-IPH (see note 1)	Low-sensitivity Controller 61F-G1PD 61F-G2PD 61F-IPD
Controlling materials and operating conditions	For control of ordinary purified water or sewage water	For control of ordinary purified water in cases where the distance between sewage pumps and water tanks or between receiver tanks and supply tanks is long or where remote control is required.	For control of liquids with high specific resistance such as distilled water	For control of liquids with low specific resistance such as salt water, sewage water, acid chemicals, alkali chemicals
Supply voltage	100, 110, 120, 200, 220, 230 or 240 VAC; 50/60 Hz			
Operating voltage range	85% to 110% of rated voltage			
Interelectrode voltage	8 VAC		24 VAC	8 VAC
Interelectrode current	Approx. 1 mA AC max.		Approx. 0.4 mA AC max.	Approx. 1.2 mA AC max.
Power consumption	Approx. 6.4 VA max.			
Interelectrode operate resistance	0 to approx. 4 kΩ	0 to 1.8 kΩ (for 2 km) 0 to 0.7 kΩ (for 4 km)	Approx. 15 kΩ to approx. 70 kΩ (see note 5)	0 to approx. 1.8 kΩ
Interelectrode release resistance	Approx. 15 k to ∞ Ω	4 k to ∞ Ω (for 2 km) 2.5 k to ∞ Ω (for 4 km)	Approx. 300 k to ∞ Ω	Approx. 5 k to ∞ Ω
Response time	Operate: 80 ms max. Release: 160 ms max.			
Cable length (see note 3)	1 km max.	2 km max. 4 km max.	50 m max.	1 km max.
Control output	2 A, 200 VAC (Inductive load: $\cos\phi = 0.4$ ) 5 A, 200 VAC (Resistive load)			
Ambient temperature	Operating: -10°C to 55°C			
Ambient humidity	Operating: 45% to 85% RH			
Insulation resistance (see note 4)	100 MΩ min. (at 500 VDC)			
Dielectric strength (see note 4)	2000 VAC, 50/60 Hz for 1 min.			
Life expectancy	Electrical: 500,000 operations min. Mechanical: 5,000,000 operations min.			

- Note:**
1. The relay in the 61F-G1H/-G2H/-IPH de-energizes when there is water present across the Electrodes, whereas the relay in the 61F-GP-N8HY energizes when there is water present across the Electrodes.
  2. Models are available for 2 km and 4 km.
  3. The length when using completely-insulated, 600-V, 3-conductor (0.75 mm<sup>2</sup>) cable cables. Usable cable lengths will become shorter as the cable diameter or number of conductors becomes larger.
  4. The insulation resistance and dielectric strength indicate values between power terminals and Electrode terminals, between power terminals and contact terminals, and between Electrode terminals and contact terminals.
  5. Possible to use with 15 kΩ or less, however, this may cause reset failure.

# Internal Circuit Diagrams

**61F-G1P/-G1PL/-G1PD**

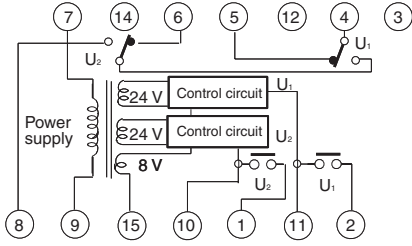

**61F-G1PH**

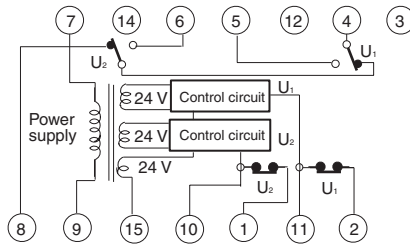

**61F-G2P/-G2PL/-G2PD**

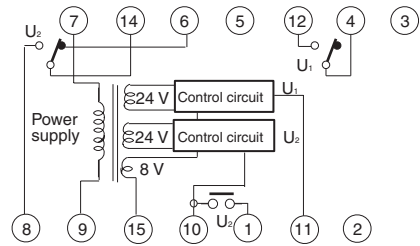

**61F-G2PH**

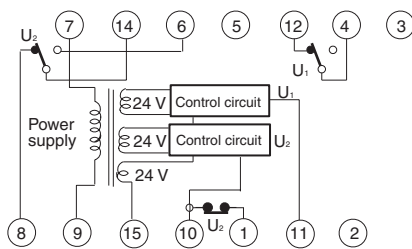

**61F-IP/-IPL/-IPD**

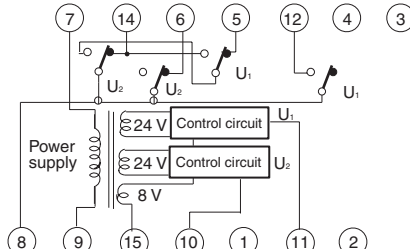

**61F-IPH**

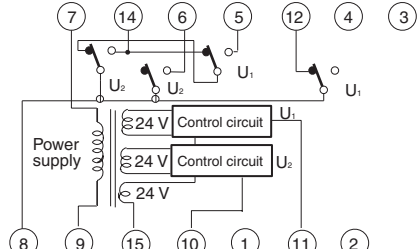

## Connections

### 61F-G1P



#### Application 1: Automatic Water Supply Control with Pump Idling Prevention

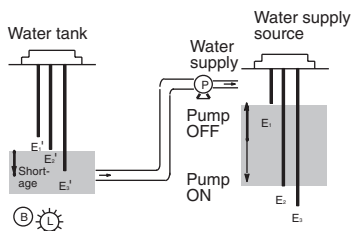

- The pump stops when the water level reaches E1 and the pump starts when the water level in the tank drops below E2.
- When the level of water supply source drops below E2', the pump stops. Pumping idling is prevented and the alarm sounds.
- Insert a pushbutton switch (NO contact) between 11 and 15 as shown by the dotted line below. When starting the pump and after recovering from a power failure, if the water supply source level has not yet reached E1', press the pushbutton switch to start the pump by momentarily short-circuiting E1' and E3. When the pump stops during normal operation subsequent to an alarm issued for a low water level, do not press the pushbutton switch.

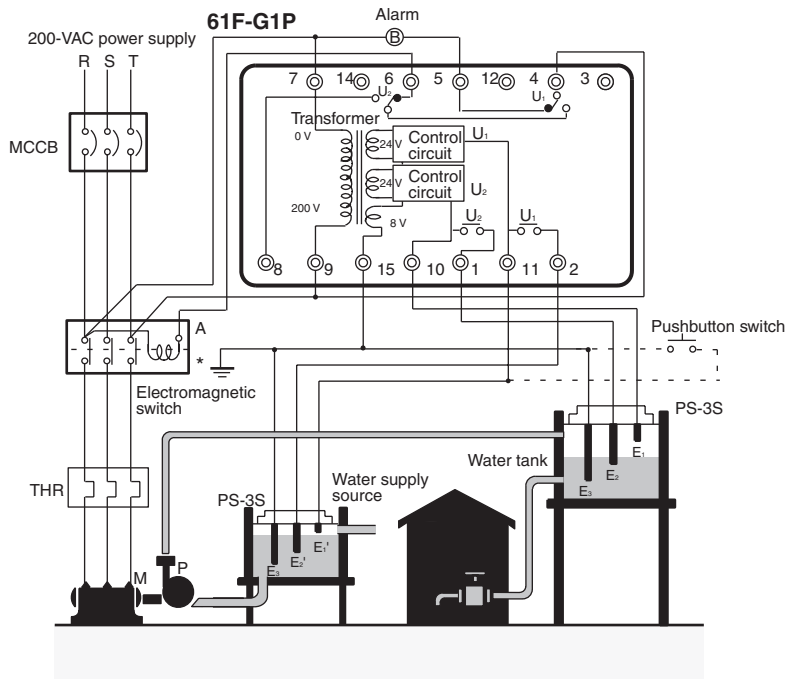

**Note:** Be sure to ground terminal 15.

**61F-G1P**

**Application 2: Automatic Water Supply Control with Abnormal Water Shortage Alarm**

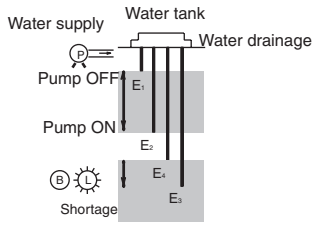

- The pump stops when the water level reaches E1 and starts when the water level drops below E2.
- If the water level drops below E4 for any reason, the pump stops and the alarm sounds.
- Insert a pushbutton switch (NO contact) between 11 and 15.
- When starting the pump and after recovering from a power failure, if the water level has not yet reached E4, press the pushbutton switch to start the pump by short-circuiting E3 and E4.
- If the pump stops upon release of the pushbutton switch, keep pressing the pushbutton switch.

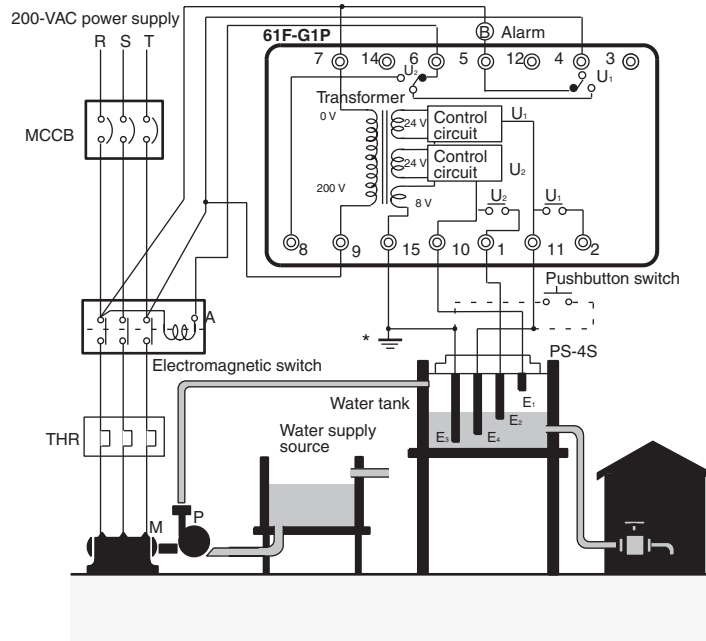

**Note:** Be sure to ground terminal 15.

# 61F-G2P

## Automatic Drainage Control with Abnormal Water Increase Alarm

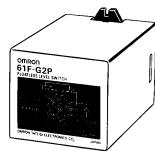

### Application 1: Drainage

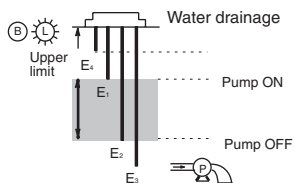

- Connect terminal 8 to power supply terminal 9.
- The pump starts when the water level reaches E1 and stops when the water level drops below E2.
- If the water level reaches E4 for any reason, the alarm sounds.

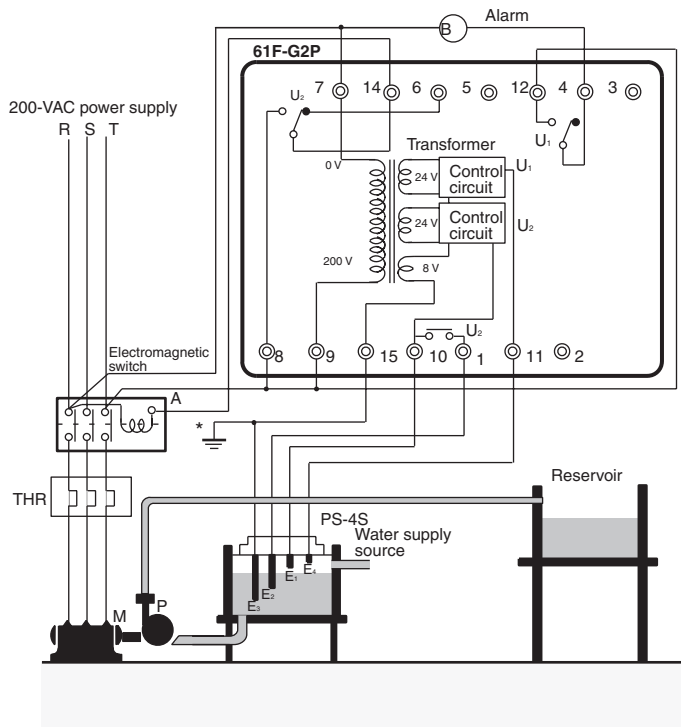

**Note:** Be sure to ground terminal 15.

# 61F-G2P

## Application 2: Water Supply

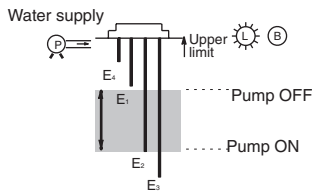

- Connect the terminal 6 to terminal 9 (power supply line).
- The pump starts when the water level reaches E<sub>2</sub>, and stops when the water level rises to E<sub>1</sub>.
- If the water level reaches E<sub>4</sub> for any reason, the alarm sounds.

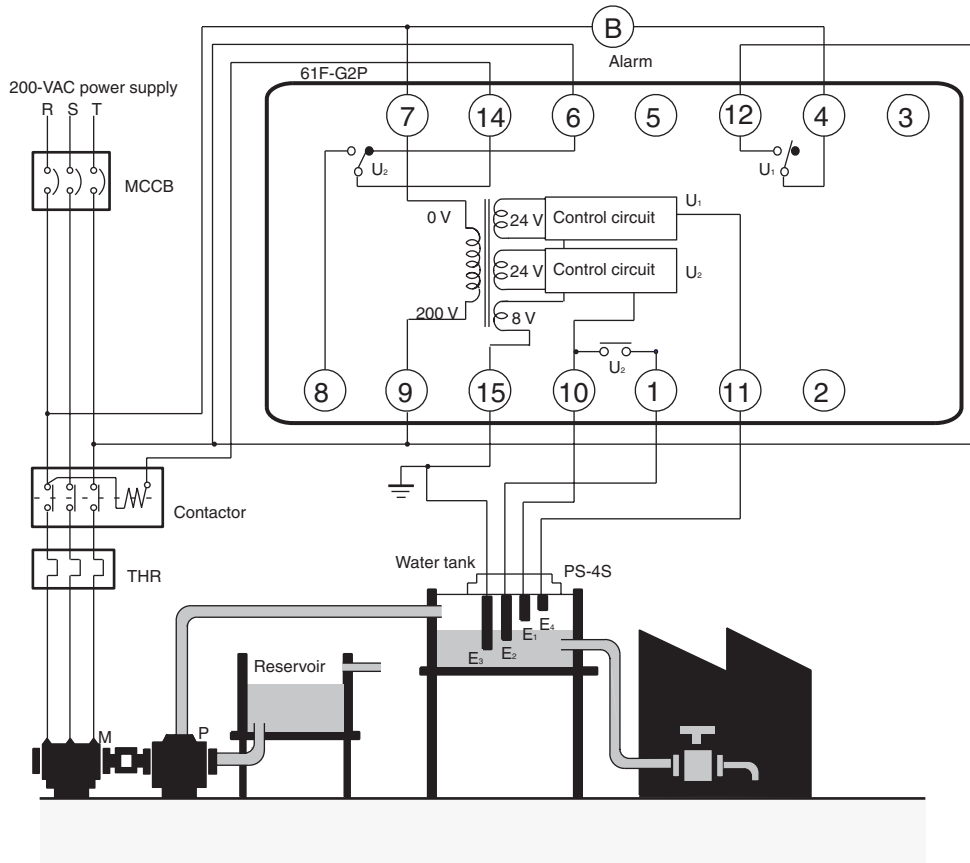

**Note:** Be sure to ground terminal 15.



**61F-IP**

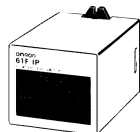

**Liquid Level Indication and Alarm**

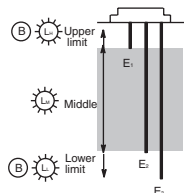

- When the water level drops below E2, the lower-limit indicator turns ON and the alarm sounds.
- When the water level reaches E2, the indicator turns OFF and the intermediate indicator turns ON.
- When the water level rises to E1, the upper-limit indicator turns ON and the alarm sounds.

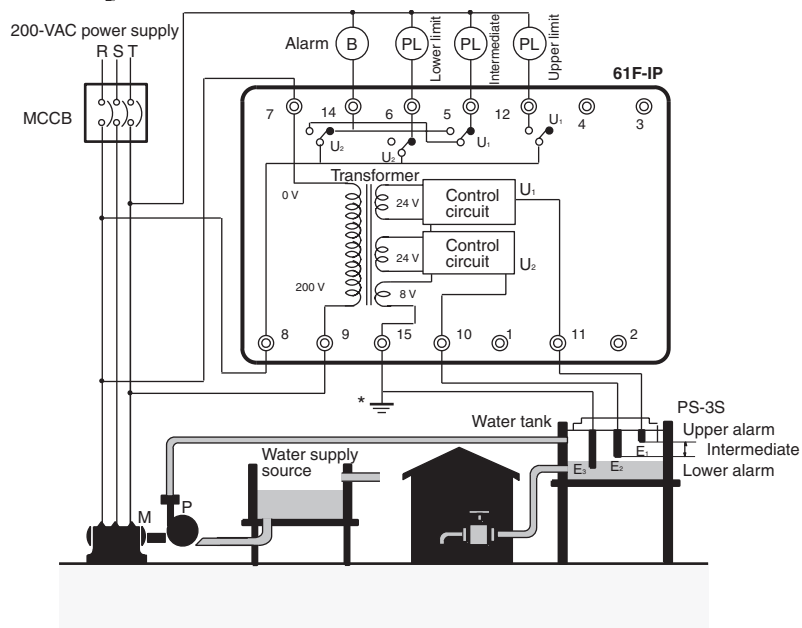

**Note:** Be sure to ground terminal 15.

## ■ Ultra High-sensitivity Models

Use these models for sensing objects such as ice, high-purity distilled water, moisture, or other objects with low electrical conductivity.

### Specifications

Item	High-sensitivity 61F-UHS	Variable high-sensitivity 61F-HSL
Supply voltage	100, 200, or 220 VAC; 50/60 Hz	24, 100, 110, 200, or 220 VAC; 50/60 Hz
Operating voltage range	85% to 110% of rated voltage	
Interelectrode voltage	24 VAC	13 VDC max.
Interelectrode current	Approx. 1 mA AC max.	Approx. 1 mA DC max.
Power consumption	3.2 VA max.	
Interelectrode operate resistance	0 to approx. 1 MΩ (see note 1)	0 to approx. 5 MΩ (variable)
Interelectrode release resistance	Approx. 5 M to ∞ Ω	Operate resistance + 2.5 MΩ max.
Cable length	5 m (see note 2)	(see note 3)
Control output	0.3 A, 220 VAC (Inductive load: $\cos\phi = 0.4$ ) 1 A, 220 VAC (Resistive load)	2 A, 220 VAC (Inductive load: $\cos\phi = 0.4$ ) 5 A, 220 VAC (Resistive load)
Ambient temperature	Operating: -10°C to 55°C	
Ambient humidity	Operating: 45% to 85% RH	
Insulation resistance	100 MΩ max. (at 500 VDC)	
Dielectric strength	2,000 VAC, 50/60 Hz for 1 min	
Life expectancy	Electrical: 50,000 operations min. Mechanical: 5,000,000 operations min.	Electrical: 500,000 operations min. Mechanical: 5,000,000 operations min.

- Note:**
- Use 61F-UHS for detecting water leakage with high specific resistance. Connect a sensor cable (page 71) between terminals 1 and 7.
  - Two Electrodes can be connected to the 61F-HSL. Use them for an alarm, not for creating a self-holding circuit.
  - The length when using completely-insulated, 600-V, 3-conductor (0.75 mm<sup>2</sup>) cabtire cables. Usable cable lengths will become shorter as the cable diameter or number of conductors becomes larger. For more details, refer to *Short Wiring in Electrode Circuit* on page 67.
  - It is recommended that the cable length be kept as short as possible since the Electrode circuit current is at DC micro-current level. Moreover, the Electrodes will corrode rapidly if the current is allowed to constantly flow between the Electrodes. Be careful with the electrode polarity and grounding when wiring.

### Internal Circuit Diagrams

61F-UHS

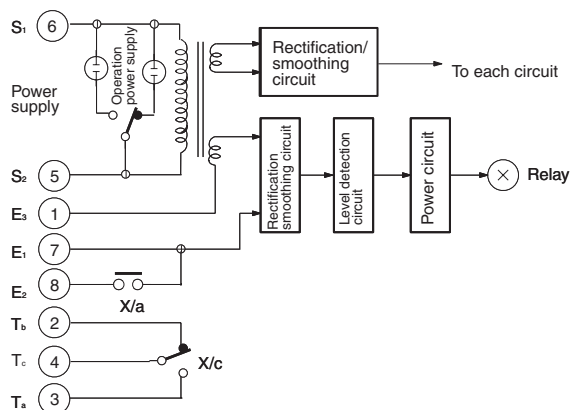

61F-HSL

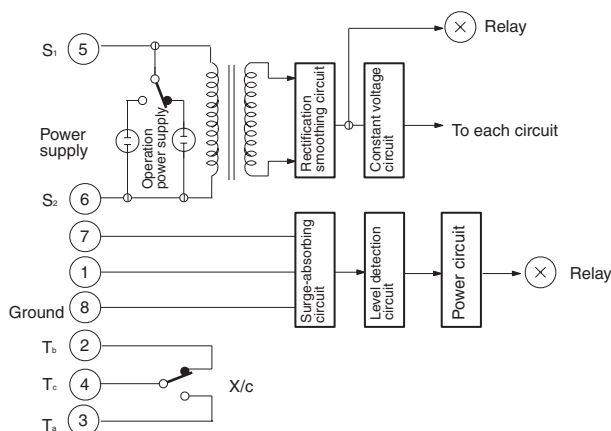

## External Circuit Diagrams (Example)

61F-UHS

61F-HSL

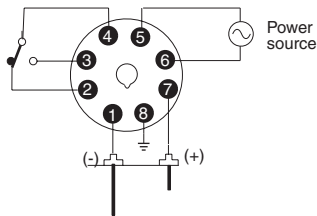
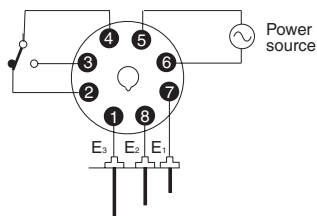

Socket: 8PFA1 (track mounted)/  
PL08 (back connecting)

Socket: 8PFA (track mounted)/  
PL08 (back connecting)

## 61F-UHS

### Automatic Operation for Water Supply and Drainage

#### 1. Water Supply

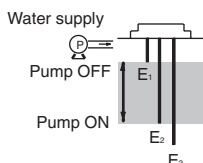

- Operation: When the water level reaches E1, the pump stops and, when the water level reaches E2 or below, the pump starts.
- Connection: Connect the contactor coil terminal to terminal 2 of the plug-in model. (Terminal 3 is not used.)

#### 2. Water Drainage

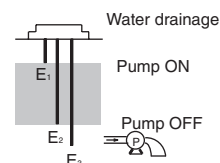

- Operation: When the water level reaches E1, the pump starts and, when the water level reaches E2 or below, the pump stops.
- Connection: Connect the contactor coil terminal to terminal 3 of the plug-in model. (Terminal 2 is not used.)

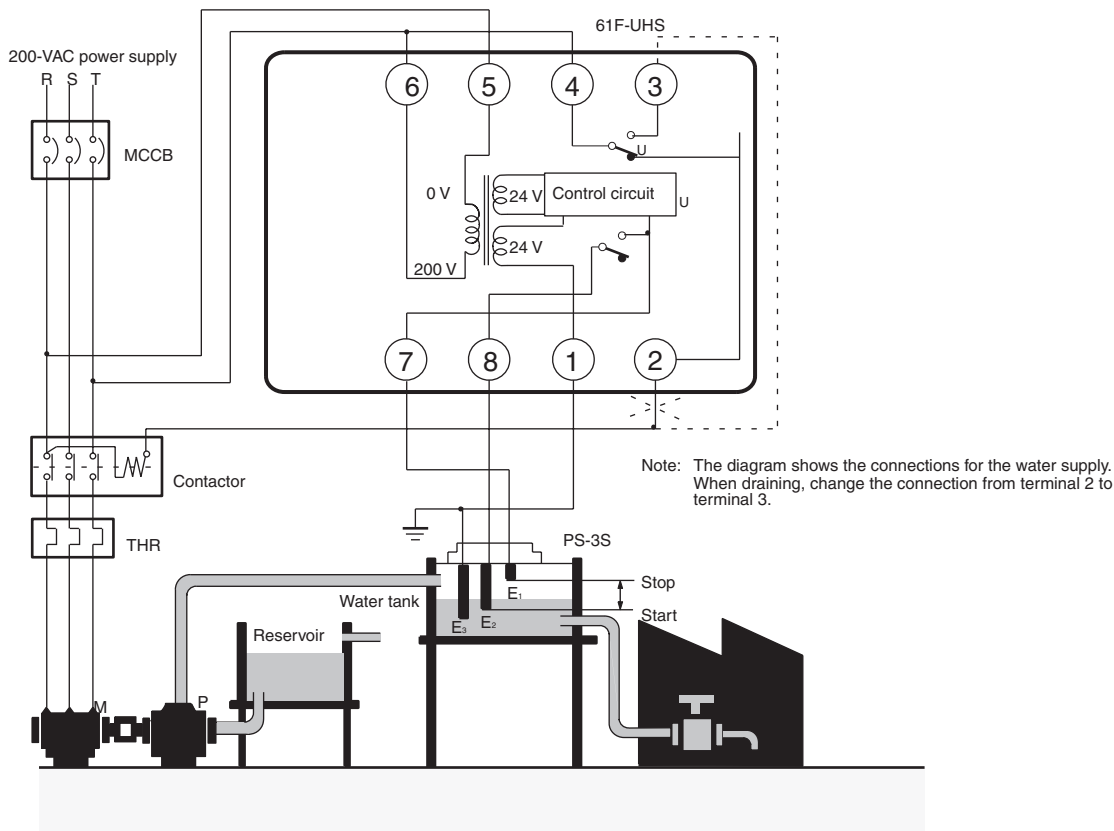

Be sure to ground terminal 1.

## ■ 61F-APN2 Solid-state Alternate Operation Relay

When operating two pumps alternately for controlling the one-point liquid level, use the Relay in combination with 61F Controller.

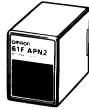

61F-APN2 Compact Plug-in Model

### Specifications

#### Ratings

Supply voltage	100, 110, 200, 220 VAC; 50/60 Hz
Operating voltage range	85% to 110% of rated voltage
Power consumption	3 VA

#### Contact Ratings (With G2RK Keep Relay)

Item	Resistive load ( $\cos\phi = 1$ )	Inductive load ( $\cos\phi = 0.4, L/R = 7\text{ ms}$ )
Max. load	3 A at 250 VAC	1.5 A at 250 VAC
Carry contact	3 A	
Max. operating current	3 A	
Max. switching capacity	750 VA	375 VA

#### Characteristics

Response time	Operate: 25 ms max. Release: 30 ms max.
Minimum pulse width	Min. ON time: 40 ms min. Min. OFF time: 200 ms min.
Insulation resistance	100 M $\Omega$ min. at 500 VDC (between each terminal and power supply)
Dielectric strength	2,000 VAC, 50/60 Hz for 1 min (between each terminal and power supply)
Vibration resistance	10 to 55 Hz, 1-mm double amplitude
Shock resistance	10 G (approx. 98 m/s <sup>2</sup> )
Life expectancy	Mechanical: 1,000,000 operations (at operating frequency of 1,800 operations/hour) Electrical: 100,000 operations min. (rated load)
Ambient temperature	Operating: -10°C to 55°C
Ambient humidity	Operating: 45% to 85% RH

When power is applied to the input terminals 2 and 7, the power will be transmitted through the alternate operation control circuit and output circuit to turn ON the contacts (NO condition) between 1 and 3 and between 6 and 8. This state will be held by a magnetic lock even when the power to the input terminals is turned OFF.

When power is again applied to the input terminals, the contact (NO condition) will turn OFF and the contacts (NC condition) between 1 and 4 and between 5 and 8 will turn ON. This state will be held even when the power to the input terminals is turned OFF.

The above operation repeats each time power is applied to the input terminals (power application pulse response system). Refer to the following internal circuit diagram.

#### Internal Circuit Diagram

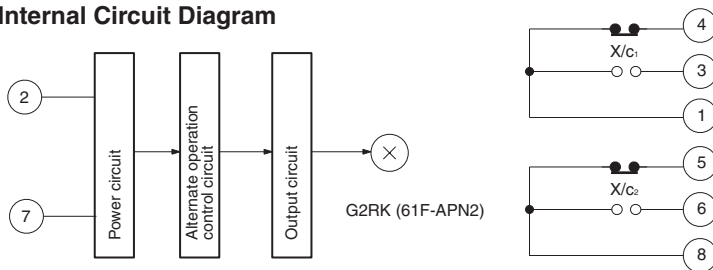

Connect the output terminal Ta of the 61FG□ to input terminal 2 of the 61F-APN2.

### Connection

Connect the contactor coil terminal A to the switching contact terminals 3 and 4 of the 61F-APN2.

Operation of the two pumps can be displayed using the switching contact terminals 5 and 6 of the 61F-APN2.

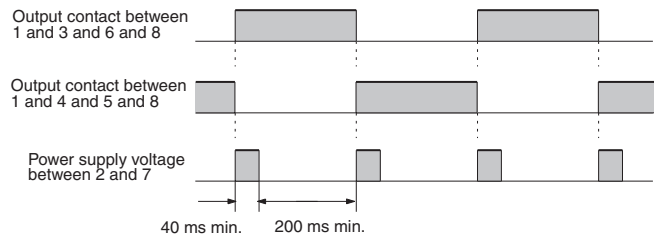

### Timing Chart of Water Supply Alternate Operation

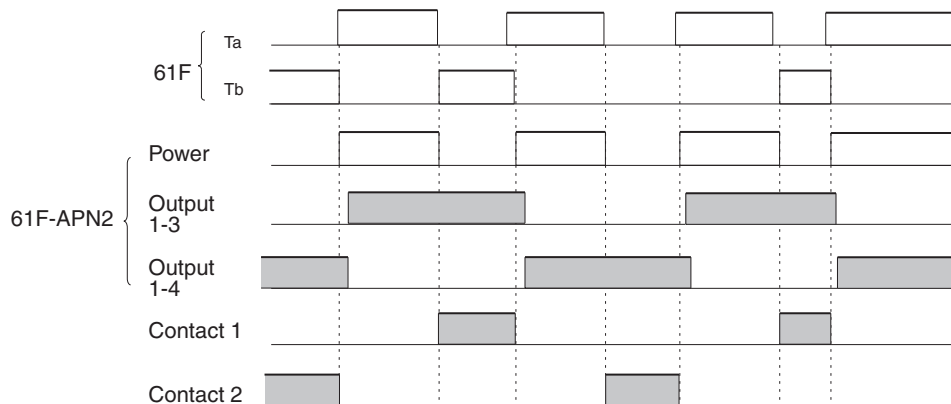

When the 61F-APN2 Alternate Operation Relay is used in combination with a 61F Controller, the output contacts of the Alternate Operation Relay will not be switched (OFF) while the contactor is being excited, and the contactor will not be excited (ON) at the moment when the output contacts are switched. That is, loads such as contactors will not be directly turned ON or OFF by the actions of the output contacts of the 61F-APN2 Alternate Operation Relay. Instead, they will be turned ON or OFF by the actions of the 61F Controller.

In case of water supply operation, the output contacts of the Alternate Operation Relay will be switched after the normally closed contacts of the 61F turn OFF upon reaching the control level, and the output contacts will be already switched when the normally closed contacts of the 61F turn OFF next time.

Therefore, only the continuous line current needs to be considered as the load capacity of the 61F-APN2 and the current can be applied up to the rated line current of 3 A.

# Connections

## At 200 VAC

### Water Supply (When Combined with 61F-G)

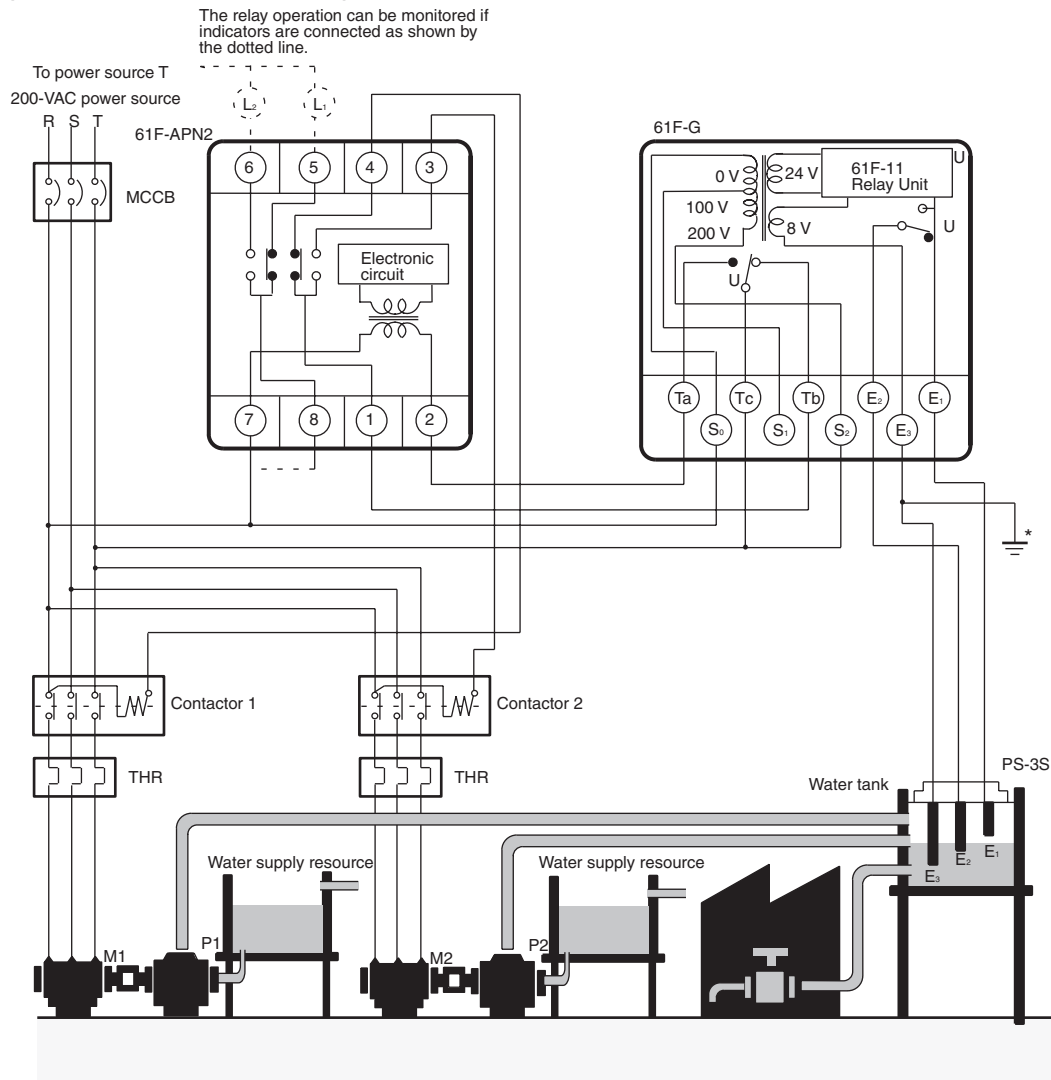

\*Be sure to ground terminal E3.

**Note:** When controlling drainage, change the connections as shown by dotted lines in the following illustration.

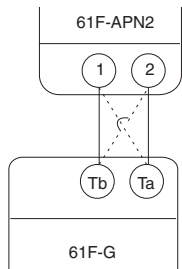

Water Supply (When Combined with 61F-G1)

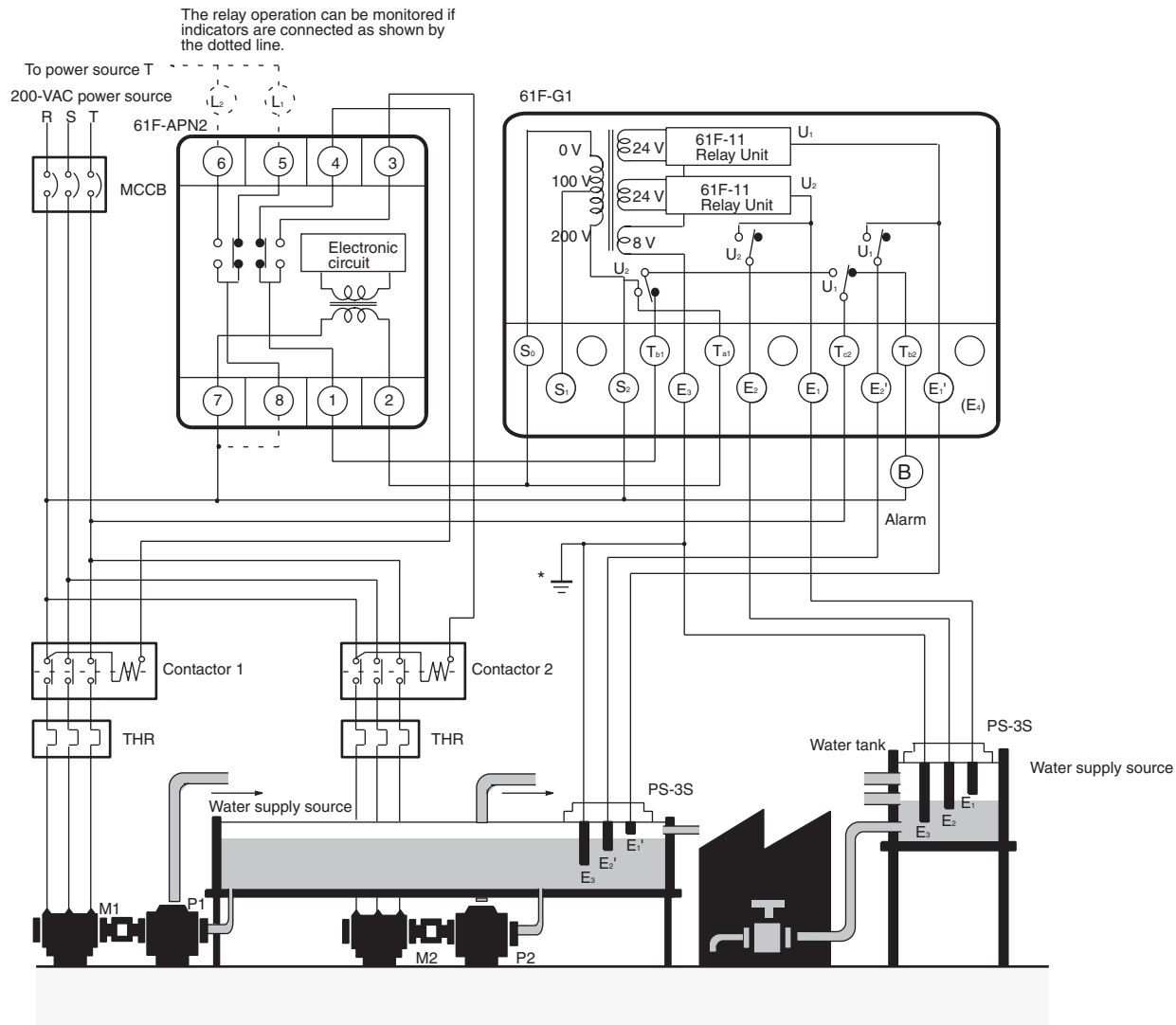

\*Be sure to ground terminal E3.

**Note:** The 61F-G1 is to be used only for supplying water and cannot be used for alternate operation for controlling drainage.

Water Drainage (When Combined with 61F-G2)

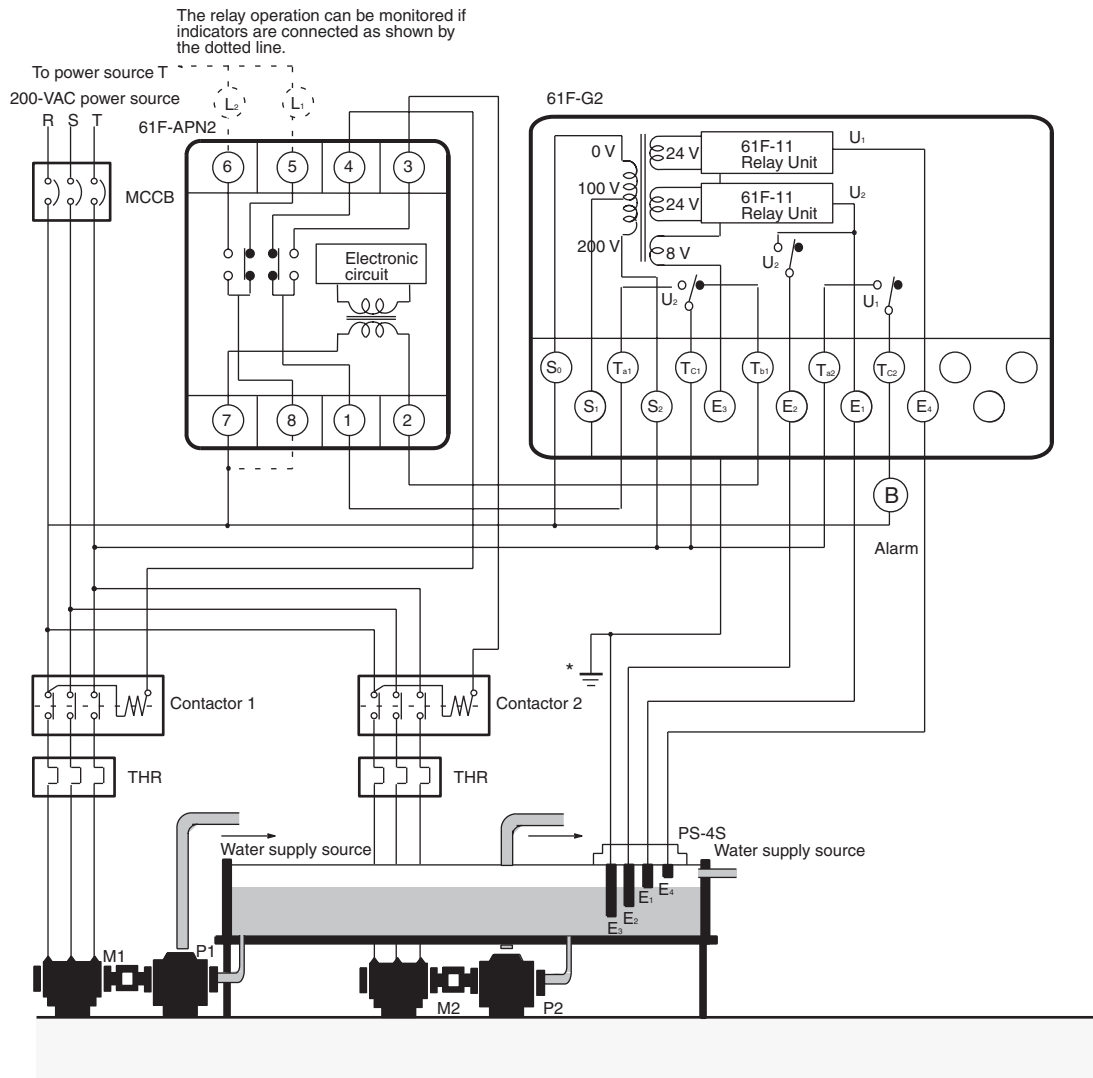

\*Be sure to ground terminal E3.

**Note:** When supplying water, change the two connections as shown by dotted lines in the following illustration.

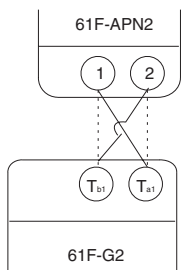



Water Supply (When Combined with 61F-G3)

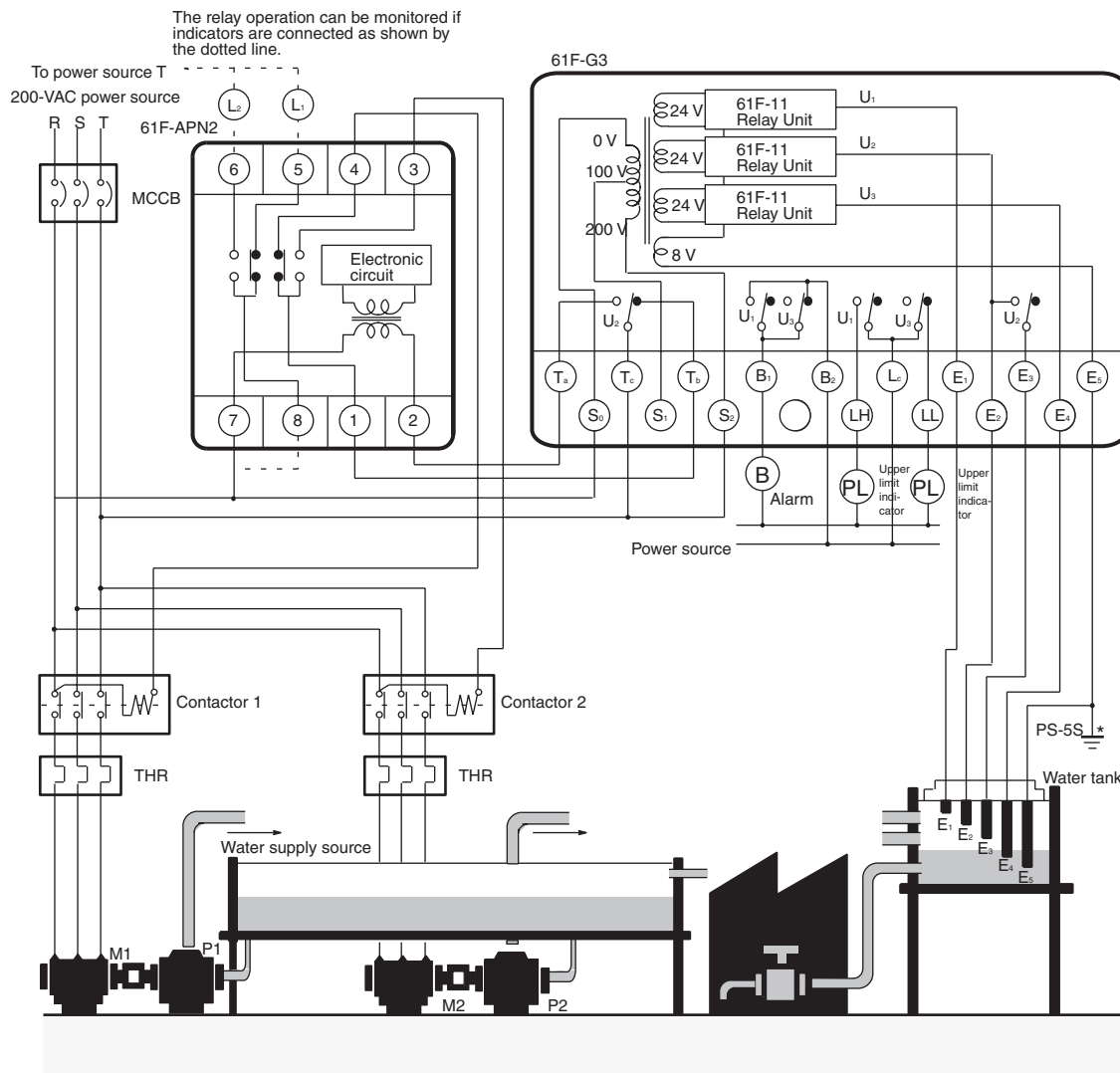

\*Be sure to ground terminal E3.

**Note:** When discharging water, change the two connections as shown by dotted lines in the following illustration.

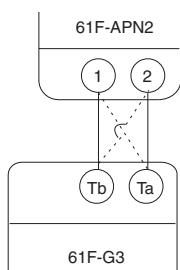

Water Supply (When Combined with 61F-G4)

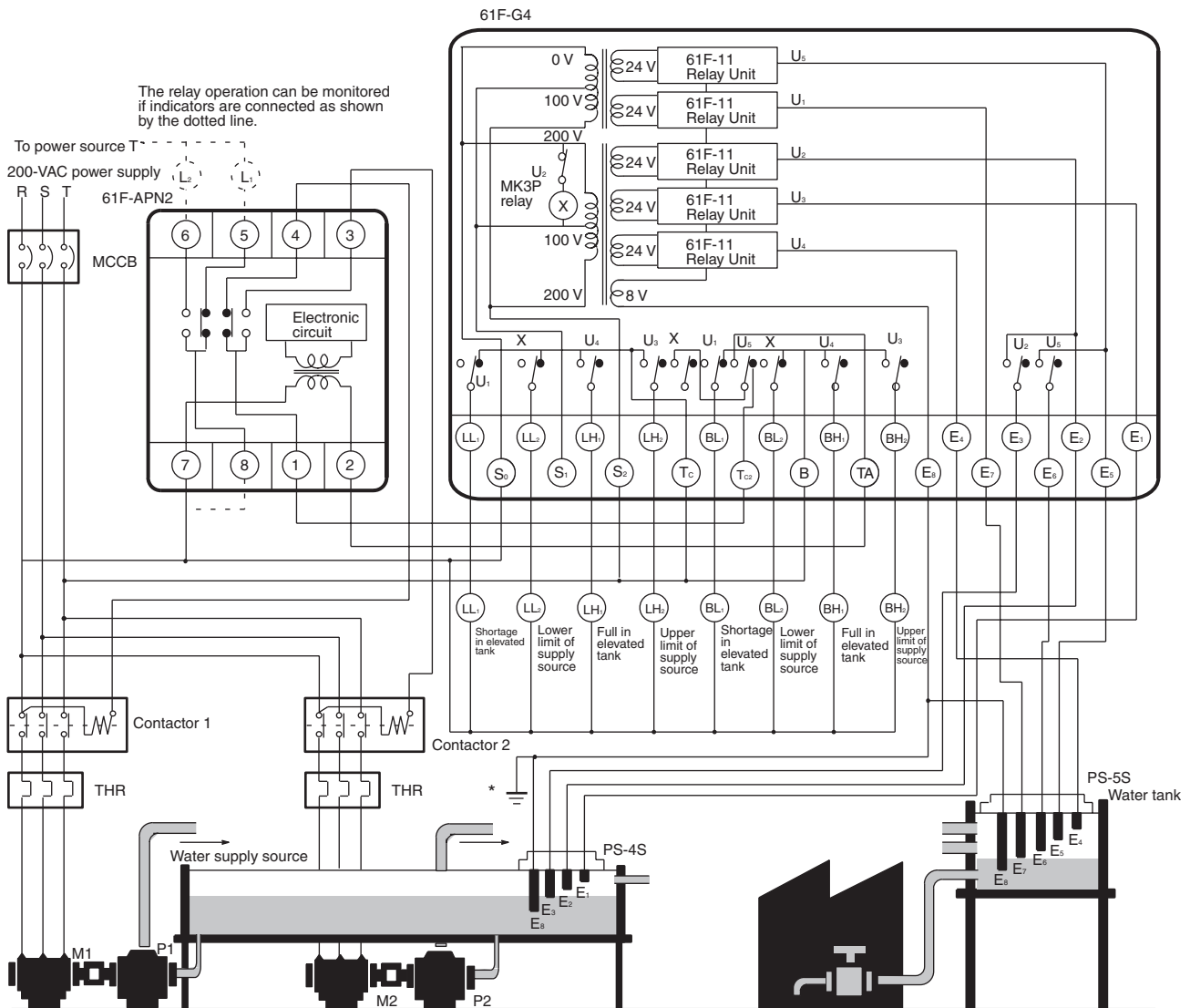

\*Be sure to ground terminal E3.

**Note:** The 61F-G4 is to be used only for supplying water and cannot be used alternately for controlling drainage.

# At 220 VAC

## Water Supply (When Combined with 61F-G1P)

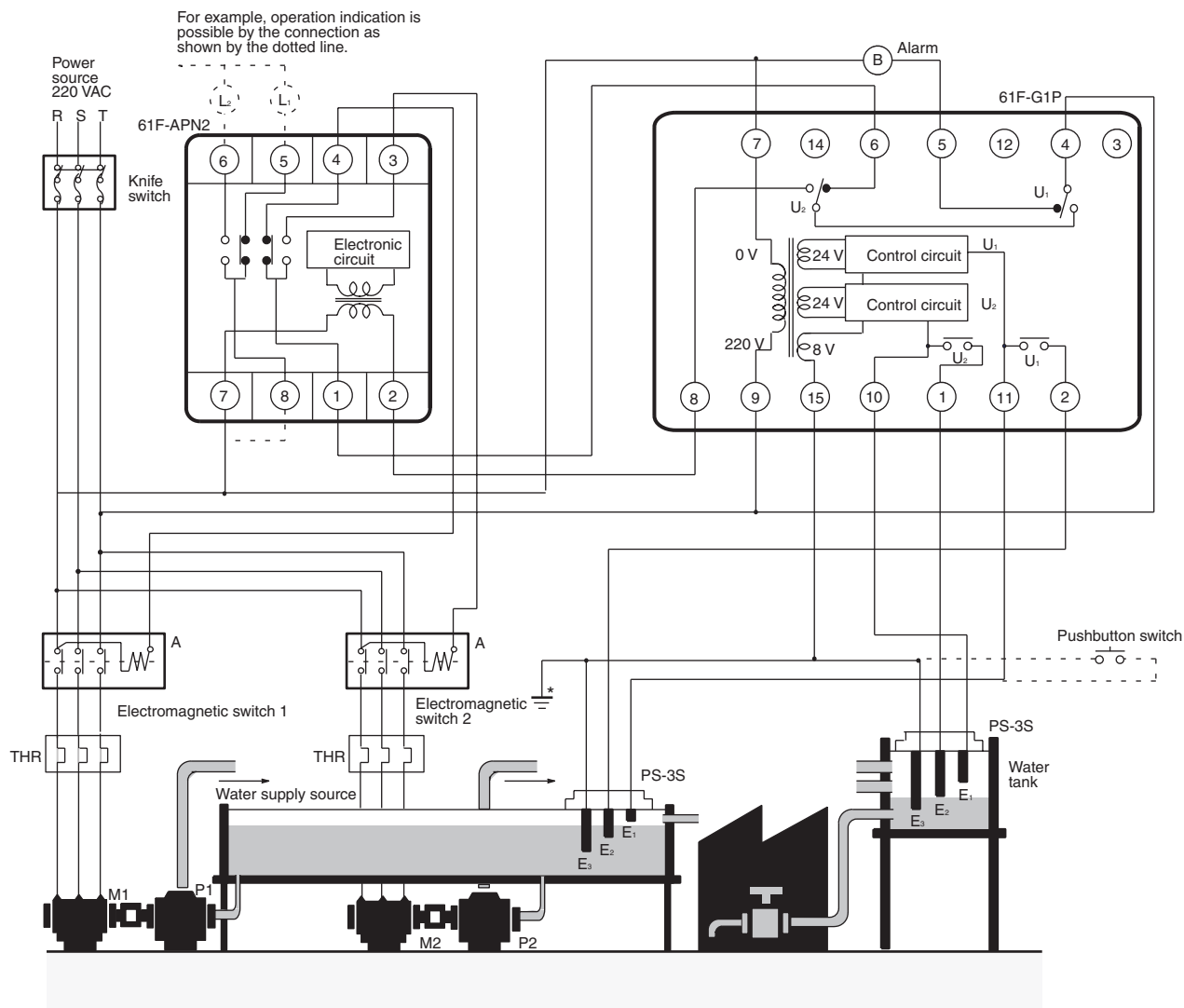

\*Be sure to ground terminal 15.

**Water Supply (When Combined with 61F-GP-N)**

For example, operation indication is possible by the connection as shown by the dotted line.

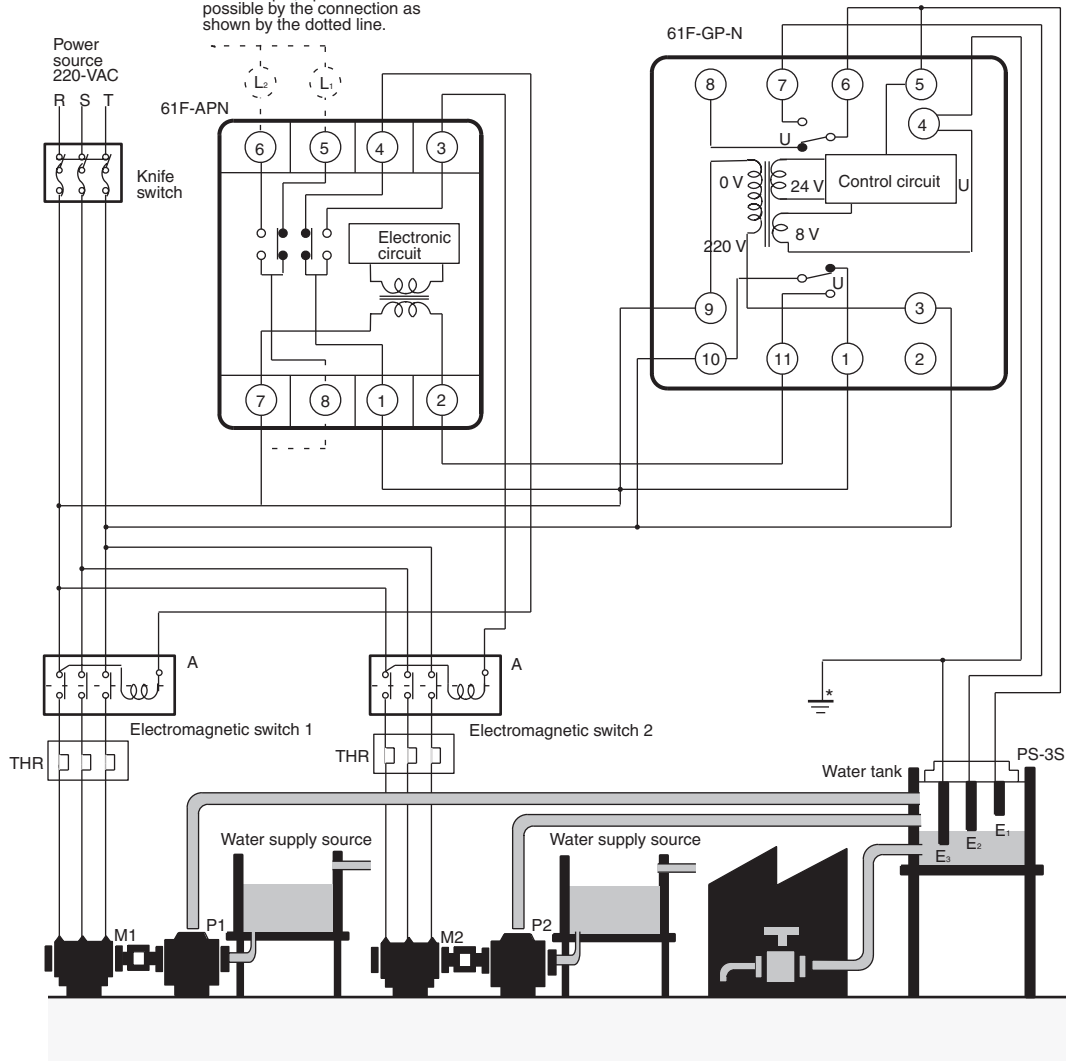

\*Be sure to ground terminal 4.

Water Drainage (When Combined with 61F-G2P)

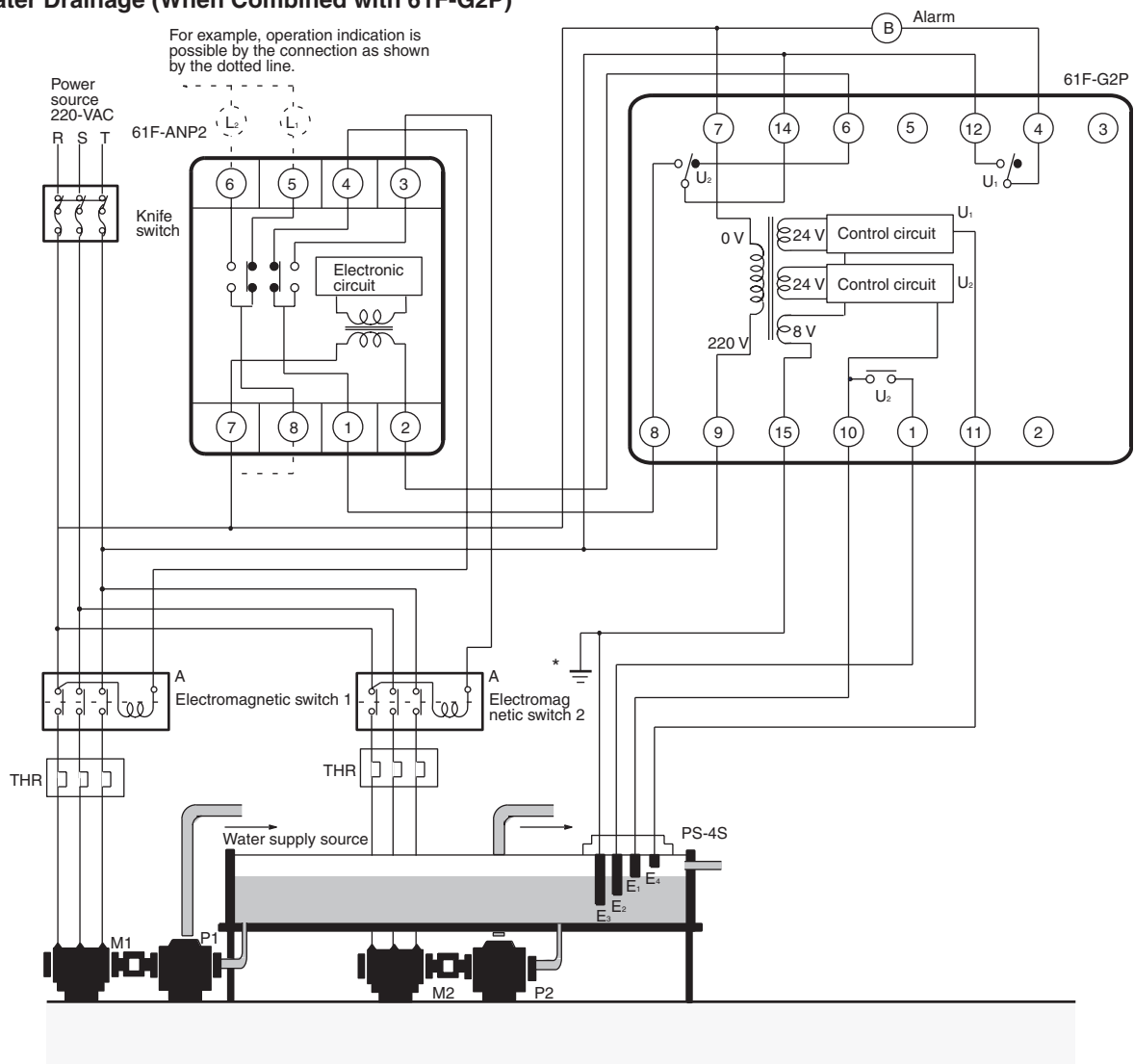

\*Be sure to ground terminal 15.

## ■ 61F-03B/04B Surge Suppressor Unit

A high-capacity protective device is available which protects 61F-series Floatless Level Controllers against faults arising from electrical surges (such as indirect strokes of lightning) when the Controllers are employed in elevated water tanks or in high-altitude locations.

### Specifications

Discharge start voltage	90 V $\pm$ 20 VDC
Impulse withstand voltage	200,000 V (1 x 40 $\mu$ s)
Impulse withstand current	6,000 A (1 x 40 $\mu$ s)

### Internal Connections

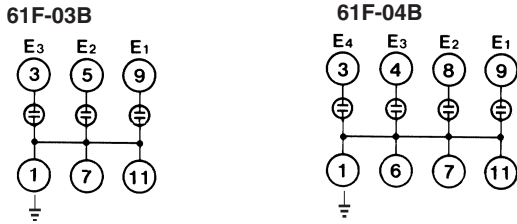

### Precautions

1. Mount the Surge Suppressor Unit as close to the Controller as possible. Adequate results may not be obtained if mounted close to the Electrode Holder.
2. When grounding the Surge Suppressor Unit in the vicinity of the Controller, connect the ground side of the Surge Suppressor Unit to Electrode E3, E5, or E8 (ground terminal).

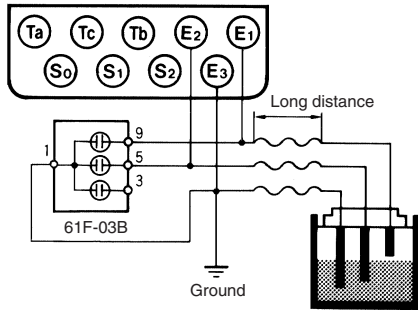

### Connection Sockets



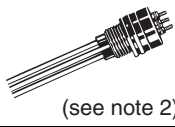
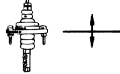
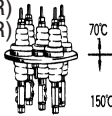

- PF113A-E Track-mounted Socket
- PL11 Back-connecting Socket

■ Accessories (Order Separately)

**Electrode Holders**

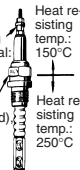
<b>Applications</b>	For city water and other General-use Electrodes. Easy-to-replace separate versions facilitate maintenance of Electrodes.	When mounting space is limited. Special 3-pole holder of small size and light weight. Ideal for soft drink vendors, etc., where only limited space is available.	For low specific liquids. Used for sewage, sea water, etc., having a low specific resistance. In sewage use, Electrode Holders must be installed 10 to 20 cm apart from one another. For acids, alkalis and sea water, Electrode Holders may be as much as 1 meter apart to operate properly.	When secure installation is required. For sewage, city water and other general use. 3-, 4-, and 5-pole models are available. In outdoor or dusty locations, or locations subject to water splashes, adherence of water, dust, dirt, or other foreign matter to the Electrode insulator may cause Controller malfunctioning due to leakage. Be sure to use the Protective Cover.
<b>Mounting style</b>	Flange	Screw	Flange	
<b>Insulator material</b>	Phenol resin		Ceramics	
<b>Max. temperature</b>	70°C max.		150°C max. (without water drips or vapor on the surface of the Electrode Holder)	150°C max.
<b>Appearance</b>	PS-3S(R) PS-4S(R) PS-5S(R) 	PS-31  (see note 2)	BF-1 	BF-3(R) BF-4(R) BF-5(R)  Heat resisting temp. 70°C Heat resisting temp. 150°C
<b>No. of Electrodes</b>	1 --- 3 PS-3S(-3SR) (see note 1) 4 PS-4S(-4SR) (see note 1) 5 PS-5S(-5SR) (see note 1)	--- PS-31 ---	BF-1 --- ---	--- BF-3(-3R) (see note 2) BF-4(-4R) (see note 2) BF-5(-5R) (see note 2)

- Note: 1.** Those with the suffix R in their model name are for 2-wire circuits.  
**2.** The Electrode material for PS-31 is SUS304. (Length: 300 mm)

<b>Applications</b>	When resistance to high pressure is required. Ideal for use in tanks where temperature or pressure inside the tank is high, e.g. 250°C, 1.96 MPa {20 kg/cm <sup>2</sup> }	When corrosion resistance is required. Since Teflon is used as the main part, the Electrode is free from rust and corrosion. Ideal for liquid level control in food processing, level control of strong alkaline liquids, etc. Withstand pressure: 981 kPa {10 kg/cm <sup>2</sup> }	When Electrode positions are distant from water surface. For deep well, especially sewage. Several Electrodes are used in combination. Cable length: 100 m max. Single-core cord of 0.75 mm <sup>2</sup> (30/0.18) provided.	When Electrode positions are distant from water surface. For deep well and underwater pump. 2 sets of special Electrodes attached to cable are to be suspended in water. Cable length: 100 m max. Two-core cord of 0.75 mm <sup>2</sup> (30/0.18) provided.
<b>Mounting style</b>	Screw		---	---
<b>Insulator material</b>	Teflon		---	---
<b>Max. temperature</b>	250°C max. (without water drips or vapor on the surface of the Electrode Holder)	150°C max.	With vinyl cord: -10°C to 60°C With hypalon cord: -30°C to 70°C (without frost formation)	
<b>Appearance</b>	 Maximum tightening torque at the terminal: 14 kg•cm (137.2 N) Material at tightening section: iron (standard), SUS304, SUS316 Heat resisting temp.: 150°C Heat resisting temp.: 250°C	SUS  Hastelloy Titanium 		
<b>No. of Electrodes</b>	1 BS-1 2 ---	BS-1T ---	PH-1 ---	--- PH-2

- Note: 1.** The BS-1 and BS-1T are pressure-proof models. The rest of models are not pressure-proof.  
**2.** The BS-1 that uses SUS304 for clamping sections and screws of PT1/2 specifications is called BS-1S1.  
**3.** The BS-1 that uses SUS304 for clamping sections is called BS-1S and one that uses SUS316 is called BS-1S2.  
**4.** When using the BS-1T in liquids with low specific resistance, provide a large clearance between Electrodes. This clearance must be varied depending on the specific resistance, for example, approximately 1 m for acid or alkali liquids.

## Electrodes, Connecting Nuts, and Lock Nuts

Applicable liquids	Material	Electrode assembly	Models for individual Electrode assembly components						
			Electrode (1 m long)		Connecting nut		Lock nut		Spring washer
		Model	Model	Indication mark	Model	Inscription	Model	Inscription	Model
Purified city water, industrial water, sewage	SUS 304 (AISI-304)	F03-60 SUS304	F03-01 SUS304	1 line	F03-02 SUS304	---	F03-03 SUS304	---	F03-04 SUS304
Purified city water, industrial water, sewage, dilute alkaline solution	SUS316 (AISI-316)	F03-60 SUS316	F03-01 SUS316	2 lines	F03-02 SUS316	6	F03-03 SUS316	316	F03-04 SUS316
Sodium hydroxide, acetic acid, dilute sulfuric acid, dilute hydrochloric acid	Hastelloy B	F03-60 HASB	F03-01 HASB	3 lines	F03-02 HASB	B	F03-03 HASB	B	---
Sea water, ammonia water, nitric acid	Hastelloy C	F03-60 HASC	F03-01 HASC	4 lines	F03-02 HASC	C	F03-03 HASC	C	---
Acetic acid, dilute sulfuric acid, sea water	Titanium	F03-60 Titanium	F03-01 Titanium	5 lines	F03-02 Titanium	T	F03-03 Titanium	T	---

**Note:** 1. An Electrode assembly consists of the following parts:

- One Electrode (1 m)
- One connecting nut
- Two lock nuts
- Two spring washers

2. The material indication mark(s) are inscribed near the screw threads, and represent the material composition of the Electrode.
3. Standard Electrodes are made of stainless steel and usable in purified water, sea water, sewage, acid (except acetic acid, sulfuric acid, etc.) and alkaline liquids. They may corrode depending upon the temperature and working conditions.
4. Corrosion-resisting Electrodes made of SUS316 (AISI-316) and acid-resisting Electrodes made of titanium or hastelloy are also available.

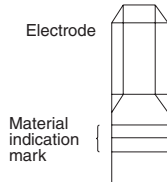

5. When long Electrodes are required, connect them with connecting nuts and lock nuts (2 pieces) every 1 m.



## Electrode Separators

No. of Electrodes	Model
1	F03-14 1P
3	F03-14 3P
5	F03-14 5P

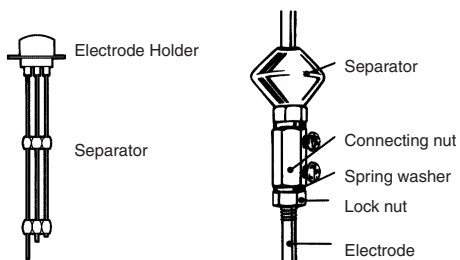

When the required length of Electrode is more than 1 m, use a Separator at each joint of two Electrodes so as to prevent the Electrodes from contacting one another.

Use a one-pole type for BF Electrodes. The five-pole type can be used for PS-5S and PS-4S Electrodes.

Material: Ceramic

## Electrode Band



Sheath: Vinyl chloride

Core: 0.3 dia. x 21, straight wire, SUS304

Length: 50 m max. (When ordering, specify the length by meters.)

The Electrodes come in three types: 3P, 4P, and 5P. Each of them require the following accessories that are separately sold.

Accessories	Weight (per 1)	Electrode		
		3P	4P	5P
Connecting nut	Approx. 20 g	3	4	5
Weight	Approx. 50 g	3 to 4	4 to 6	5 to 8
End cap	Approx. 1 g	3	4	5
Insulation Cap	Approx. 10 g	2	3	4
Adhesive	Approx. 5 g	1	1	1
Electrode Band weight (1m)	---	Approx. 110 g	Approx. 140 g	Approx. 180 g

- The Electrode Band consists of polyvinyl-chloride-covered (PVC) stainless-steel wires SUS304 (AISI-304) which are free from mutual contact. As the Electrode Band can be cut, mounted, and removed with ease, it is most suitable for deep wells.
- Applicable Electrode Holders: PS-3S, PS-4S, PS-5S, BF-3, BF-4, BF-5
- Ambient operating temperature: -10°C to 60°C (with no icing)
- The Electrode Band cannot be used in flowing water, liquids over 60°C, or liquids which corrode PVC or stainless steel.

## Application Example

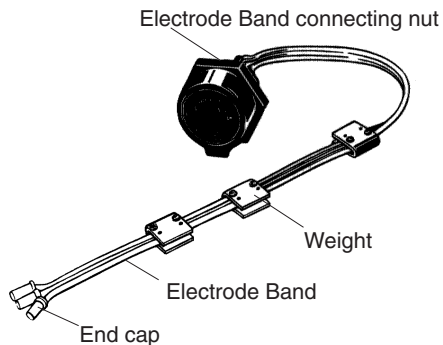

Other Accessories

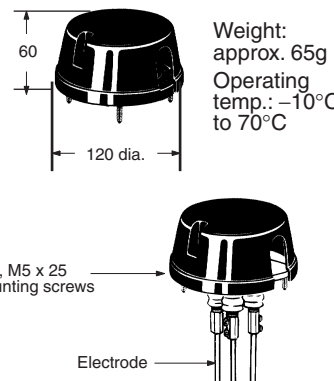
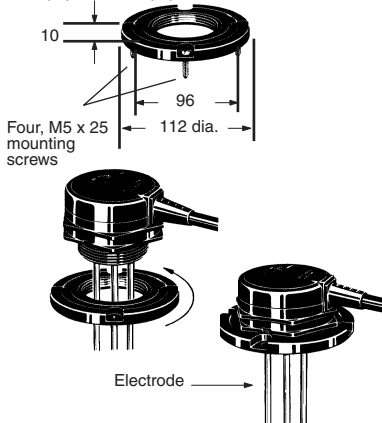
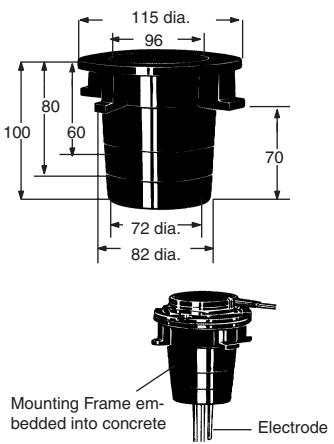
F03-11 Protective Cover	F03-12 Spring Clamp	F03-13 Mounting Frame for installing in concrete
<p>Use this Cover for PS-series Electrode Holders with Mounting Frames (upper one in the following illustration). This Cover can also be used when installing the BF-series Electrode Holders outdoors. Since this Cover is not waterproof, water or dust may enter through the wire hole (lower one below).</p> <p>Applicable Electrode Holders: BF-3, BF-4, BF-5, PS-3S(R), PS-4S(R), PS-5S(R)</p>  <p>Weight: approx. 65g Operating temp.: -10°C to 70°C</p> <p>Two, M5 x 25 mounting screws</p> <p>Electrode</p>	<p>Used to clamp an Electrode Holder with ease, as shown in the illustrations, when the Electrode Holder is applied to a tank without a coupling.</p> <p>Squeeze the mounting frame into the Holder as shown below.</p> <p>Applicable Electrode Holders: PS-3S(R), PS-4S(R), PS-5S</p>  <p>Four, M5 x 25 mounting screws</p> <p>Electrode</p>	<p>Useful frame for burying in concrete. Cut as required based on the concrete depth.</p>  <p>Mounting Frame embedded into concrete</p> <p>Electrode</p> <p>Commonly used with Mounting Frame</p>

Mounting

■ PS-3S Electrode Holders

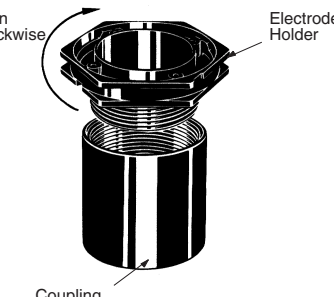
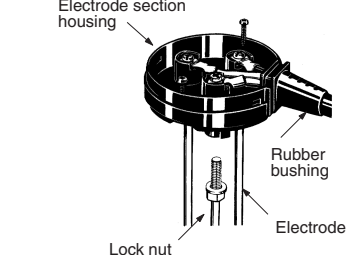
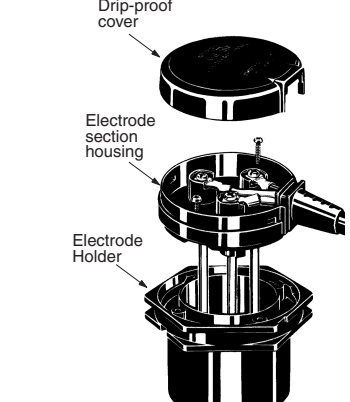
1. Mounting Electrode Holder	2. Attaching Electrode(s) to Electrode section	3. Inserting Electrode section into Electrode Holder
<ul style="list-style-type: none"> <li>Screw the Electrode Holder into the coupling secured at the installation location.</li> </ul>	<ul style="list-style-type: none"> <li>Insert each Electrode into the connecting nut, secure the Electrode with the clamp screws, and then tighten the lock nut.</li> <li>Connect the leads, inserted through the hole of the rubber bushing, into the respective terminals.</li> </ul>	<ul style="list-style-type: none"> <li>Fit the Electrode section into the Electrode Holder and secure it with the two screws.</li> <li>Check the Electrode section for proper wiring, fit the rubber bushing in position, and then cover the Electrode Holder with the drip-proof cover.</li> </ul>
 <p>Twin clockwise</p> <p>Electrode Holder</p> <p>Coupling</p>	 <p>Electrode section housing</p> <p>Rubber bushing</p> <p>Electrode</p> <p>Lock nut</p>	 <p>Drip-proof cover</p> <p>Electrode section housing</p> <p>Electrode Holder</p>

**Note:** 1. OMRON does not sell couplings.

2. Screw in the Electrode until it reaches the bottom of the nut. Insufficient insertion will cause a faulty connection.

## ■ Installing PS-□S Electrode Holder on Tank

### 1. For tanks with thin walls combined with the F03-12 Spring Clamps

- Using the F03-12 as a nut

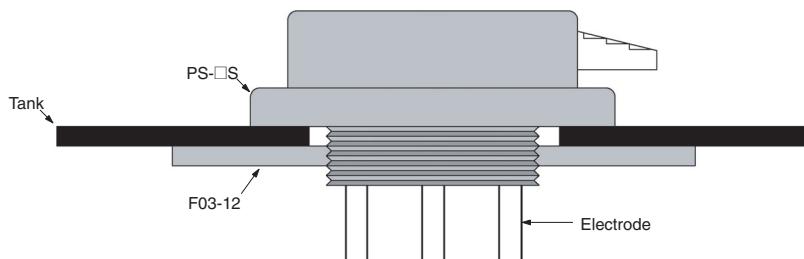

- Using the F03-12 as a flange

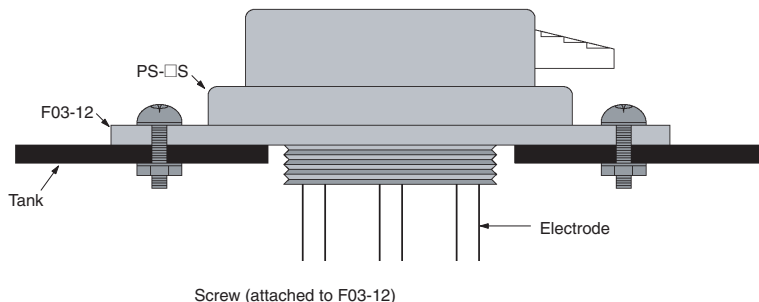

### 2. For tanks with thick metal walls

- Fabricate screw threads of the same size as for the PS-□S in the tank

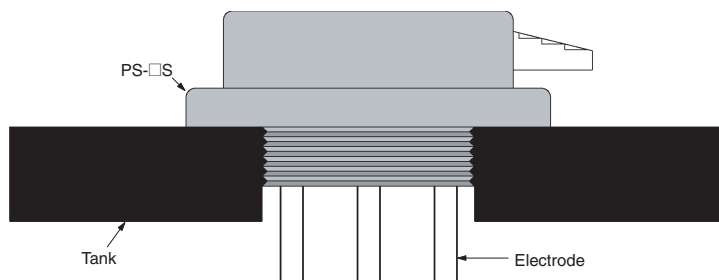

### 3. For concrete tanks

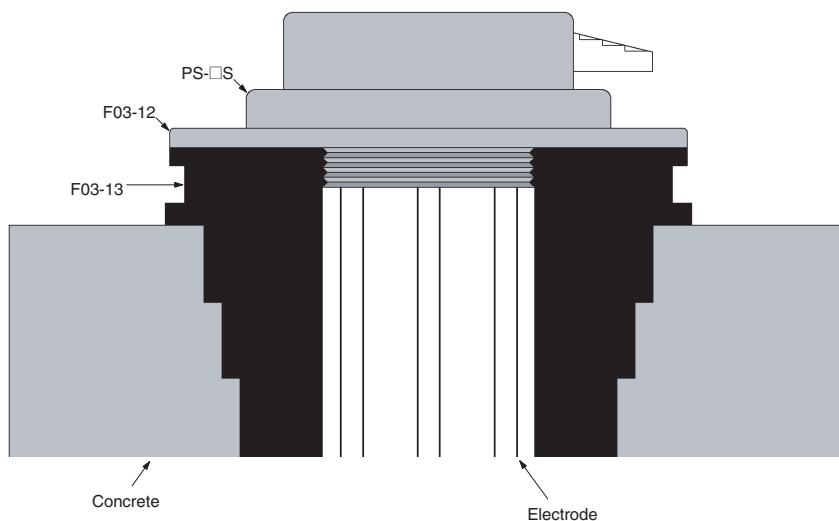

## ■ Electrode Holder and Electrodes

### How to Mount Electrodes

#### Connecting Electrodes to Electrode Holders

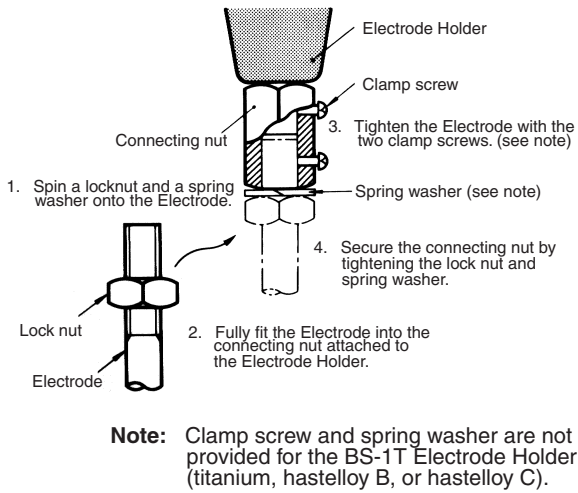

#### Connecting One Electrode to Another

When a long Electrode is required, use two or more Electrodes by joining them with a connecting nut and two lock nuts at intervals of 1 m.

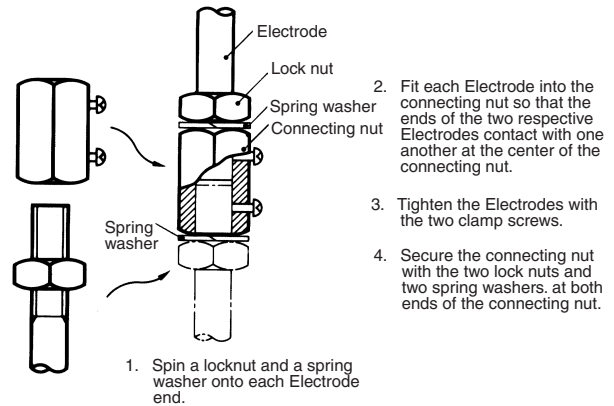

## ■ PH-1/PH-2 Electrodes

PH-1  
(See notes 1 and 2)

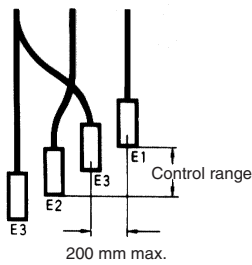

PH-2

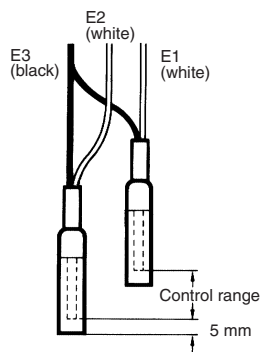

- Note:**
- When the distance between E1 and E3 exceeds 1 m for supplying purified city water, for example, locate a second E3 within 200 mm of E1.
  - Even when the distance is less than 1 m, the product may not operate due to the water quality.

## Electrode Bands

### Connecting Electrode Holder and Electrode Band

Connect the connecting nut to the Electrode section as shown in the illustration below and secure the connecting nut with the clamp screw. Insert the Electrode Band into the lower hold of the connecting nut, and tighten the two clamp screws so that the conductor in the Electrode Band will come into contact with the connecting nut. Then mount the Electrode Holder to the Electrode section and secure them with two mounting screws, which are provided with the model.

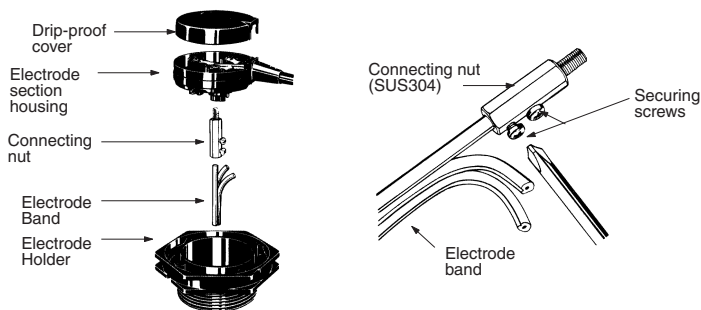

### Mounting Weight(1)

To mount an Electrode Band Weight on an Electrode Band, firmly tighten the two screws A or B. The needle screws will come into contact with the electrode wire (conductor) allowing the Electrode Band Weight to become an electrode plate. (Be sure to use screw holes A or B.). The Electrode has guides for connecting screws as shown by the arrows below so that connecting screws can be properly inserted into the conductor.

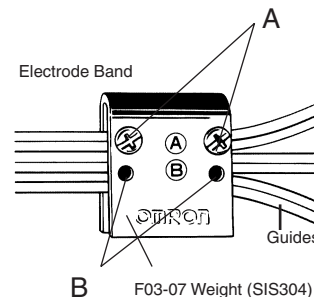

### Mounting Weight (2)

Install Electrode Band Weights in three positions. The Electrode Band Weights work as short, medium, and long Electrodes, allowing the Electrode Band to detect high, medium, and low levels of liquid.

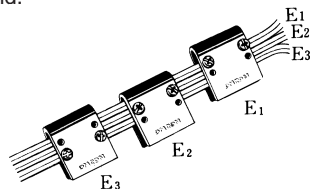

### Mounting Insulation Cap

Cover each Electrode Band Weight with an Insulation Cap so as to prevent false detection due to contact between the Electrode and tank. Deform the Insulation Cap to an ellipsoid before installing it on the Electrode Band Weight.

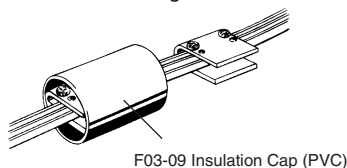

### Mounting End Cap

Cover the Electrode Band end and apply the Adhesive sold separately to prevent water from entering between the sheath and the End Cap.

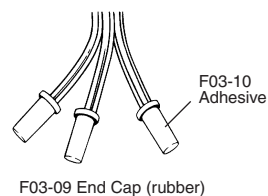

In purified city water, if the distance between the long Electrode (E3) and short Electrode (E1) is more than 50 cm, install another Electrode Band Weight as E3 in the vicinity of E1 at intervals of 15 to 20 cm, referring to Mounting Weight (2) above. An Insulation Cap is not needed for the long Electrode.

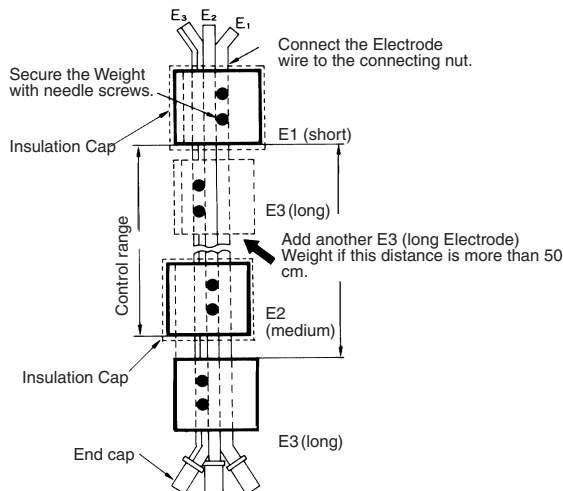

## ■ Mounting the Protective Cover on the PS-series Electrode Holder

Attach the F03-12 Mounting Frame to the bottom of the PS-series Electrode Holder as shown below. Next, place the F03-11 Protective Cover on top of the Electrode Holder and press on it until a clicking sound is heard. For mounting purposes, the cap screw attached to the Protective Cover is not required.

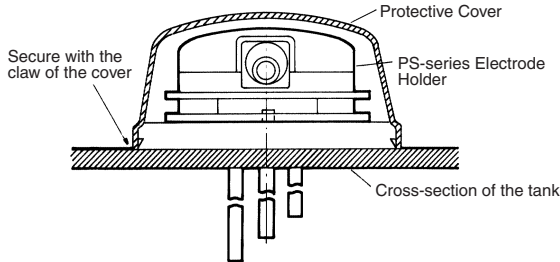

## ■ Mounting the Protective Cover on the BF-series Electrode Holder (BF-3/4/5)

Remove the two mounting screws (M5 x 25) of the BF-series Electrode Holder and attach the two cap screws (M5 x 25) supplied with the F03-11 Protective Cover.

Next, put the Protective Cover over the top of the BF-series Electrode Holder, and then tighten the supplied two screws (M3 x 20 with washers). Refer to the following illustration.

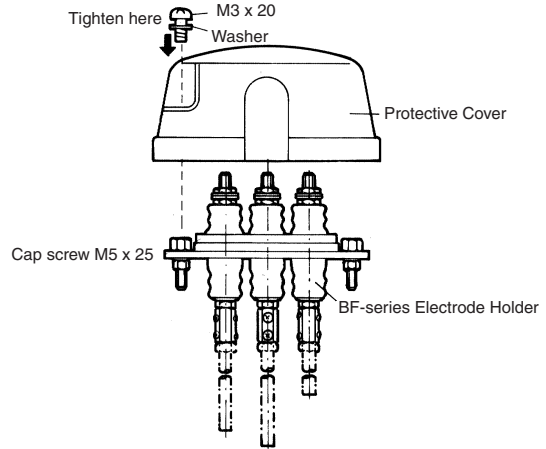

## Dimensions

**Note:** All units are in millimeters unless otherwise indicated.

### ■ Standard Models

#### 61F-G

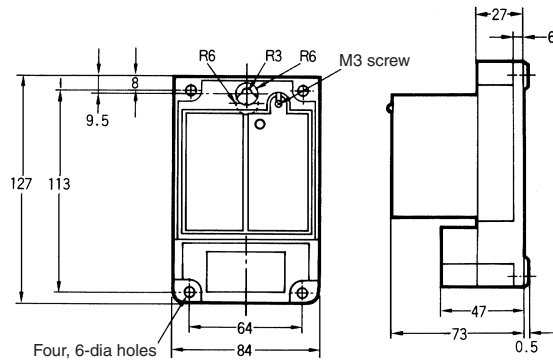
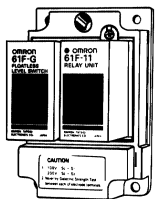

#### Mounting Holes

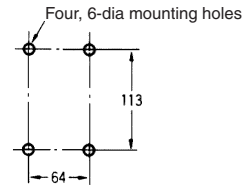

#### 61F-G1 61F-G2 61F-I

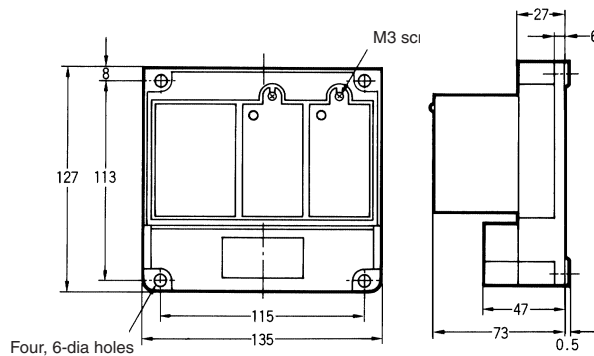
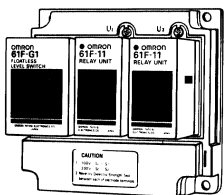

#### Mounting Holes

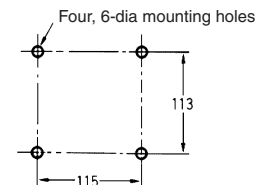

**61F-G3**

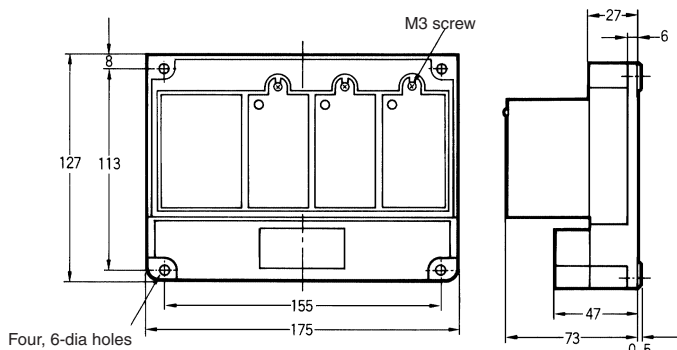
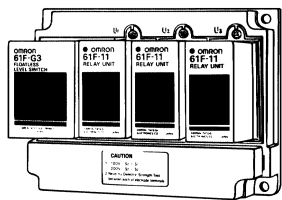

**Mounting Holes**

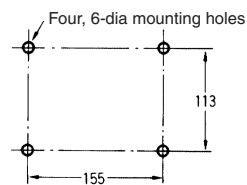

**61F-G4**

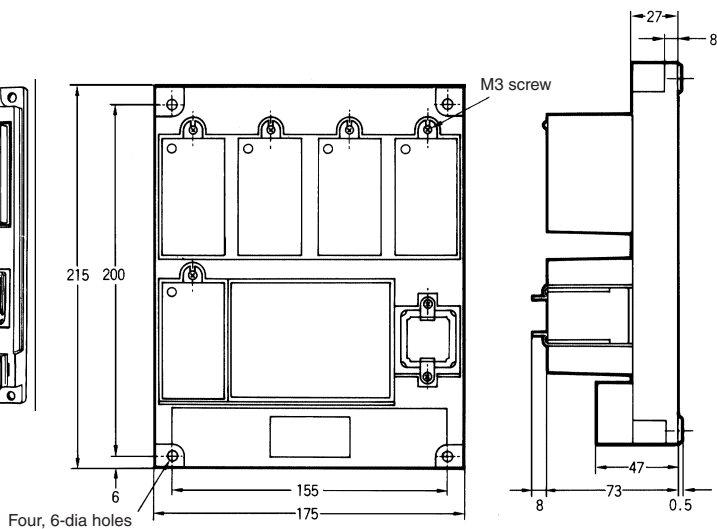
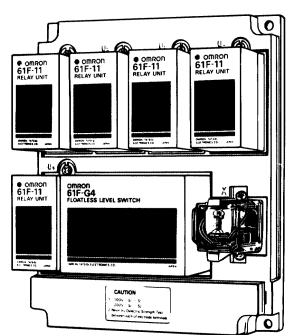

**Mounting Holes**

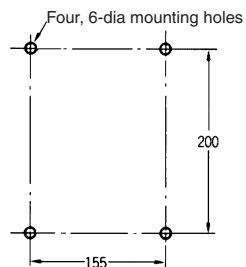

**■ Plug-in Models**

**61F-GP-N**

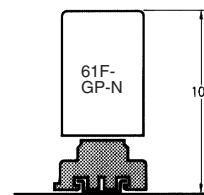
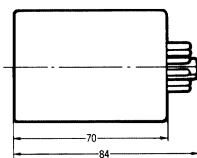
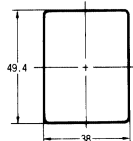

PF113A-E

**61F-GP-N8**

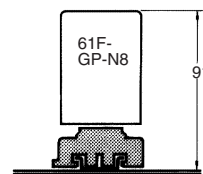
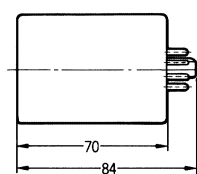
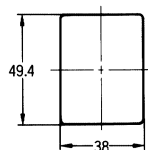

PF083A-E

61F-G1P  
61F-G2P  
61F-IP

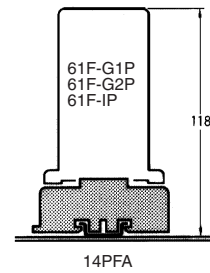
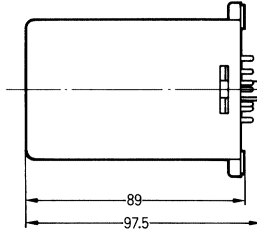
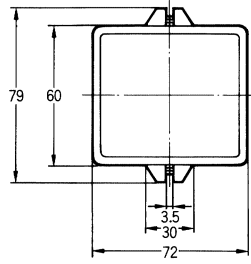

■ Ultra High-sensitivity Models

61F-UHS

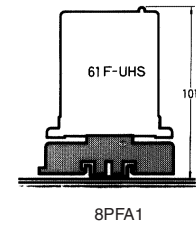
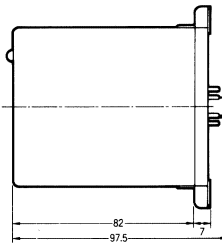
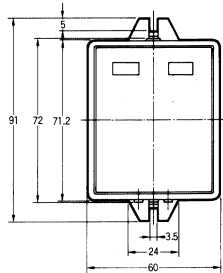
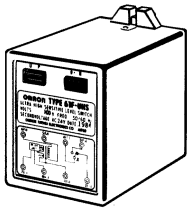

61F-HSL

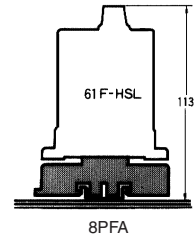
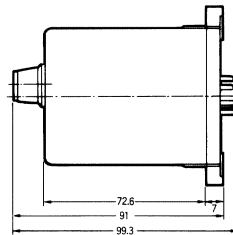
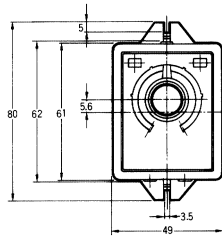

■ Solid-state Alternate Operation Relay

61F-APN2

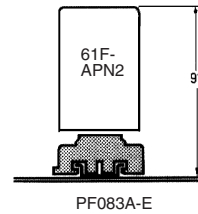
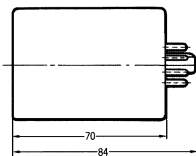
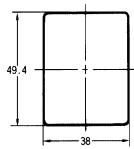
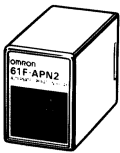

■ Surge Suppressor Unit

61F-03B  
61F-04B

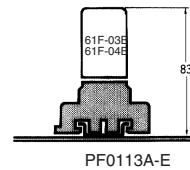
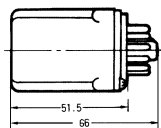
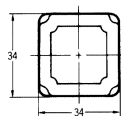
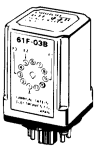



## Electrode Holders

**PS-3S/-4S/-5S**  
**PS-3SR/-4SR/-5SR**  
 (see note)

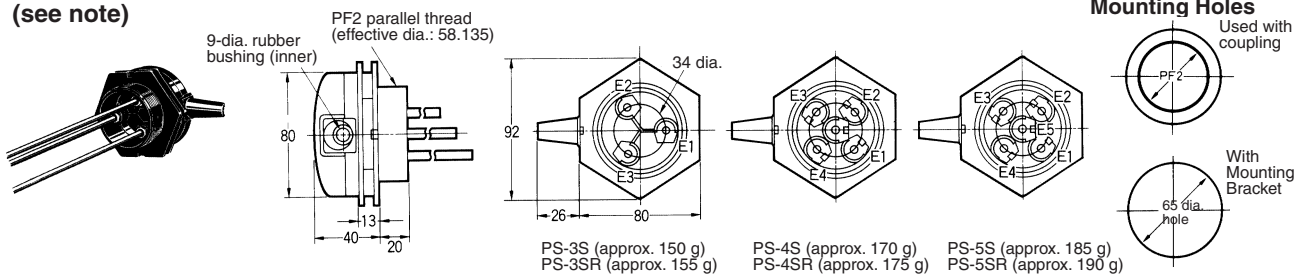

### Mounting Screw Holes

**Note:** The PS-3SR, PS-4SR, and PS-5SR have built-in resistor of 6.8 kΩ and used for the two-wire 61F models.

**PS-31**

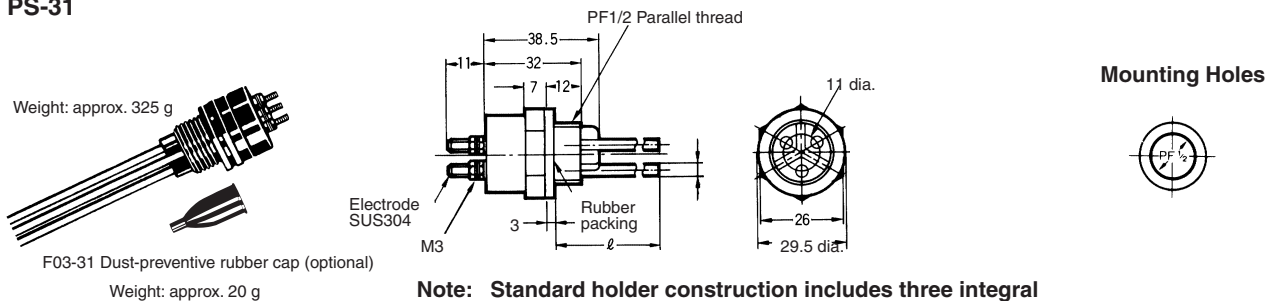

**Note:** Standard holder construction includes three integral 300-mm-long Electrodes. However, a model having 1,000-mm-long Electrodes is available on request.

**BF-1**

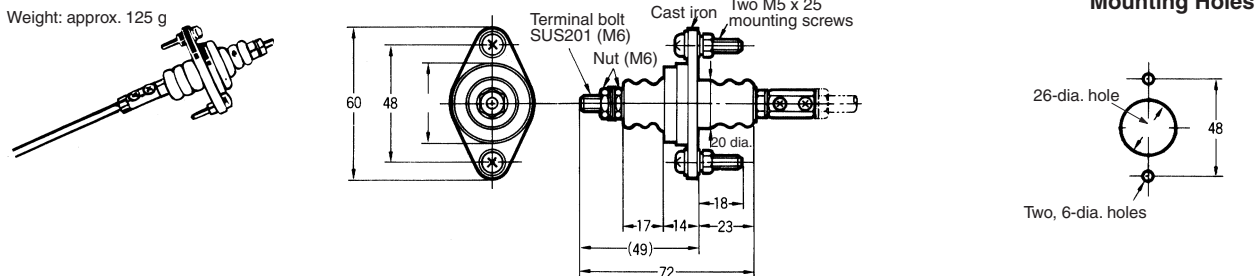

**BF-3/-3R**  
**BF-4/-4R**  
**BF-5/-5R**

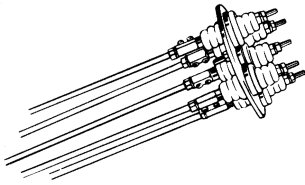

**BF-3**  
 Weight: approx. 420 g  
**BF-3R**  
 Weight: approx. 425 g

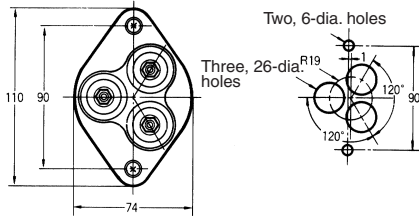

**Mounting Holes**

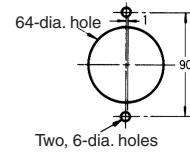

**BF-4**  
 Weight: approx. 520 g  
**BF-4R**  
 Weight: approx. 525 g

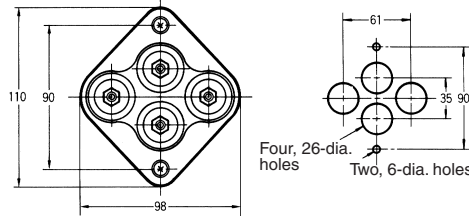

**Mounting Holes**

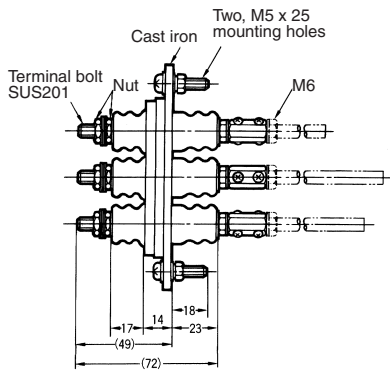
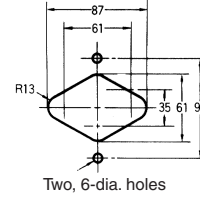

**BF-5**  
 Weight: approx. 710 g  
**BF-5R**  
 Weight: approx. 715 g

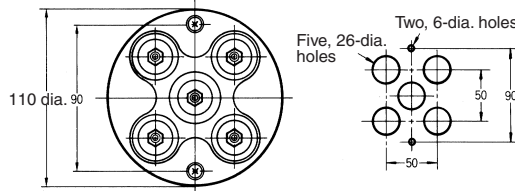

**Mounting Holes**

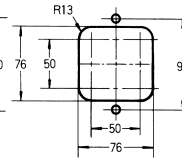

**BS-1(S)**  
 Weight: approx. 70 g

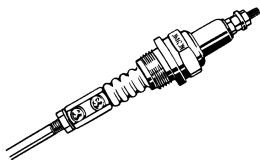

**BS-1**

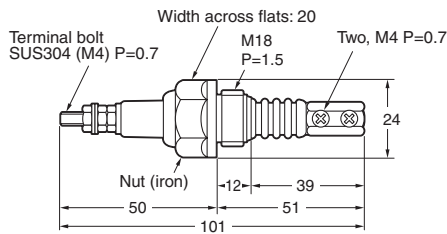

**Mounting Holes**

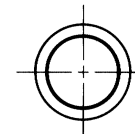

M18 P=1.5  
 (fine screw thread)

**BS-1S**  
**BS-1S1**  
**BS-1S2**

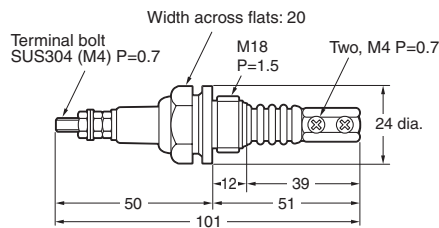

M18 P=1.5  
 (fine screw thread)

**BS-1T**

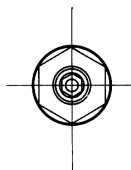
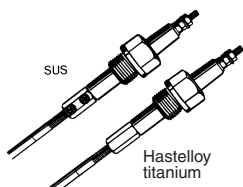

Terminal bolt  
SUS304  
SUS316  
Titanium  
Hastelloy B  
Hastelloy C

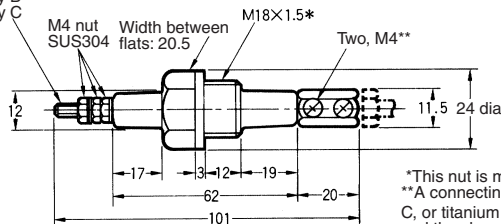

**Mounting Holes**

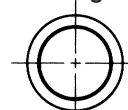

M18 P=1.5  
(fine screw thread)

\*This nut is made of Teflon  
\*\*A connecting nut made of Hastelloy B, Hastelloy C, or titanium is not supplied with two M4 screws and thus has no holes for such screws.

<b>Material</b>	SUS304	SUS316	Titanium	HAS B	HAS C
<b>Weight</b>	Approx. 55 g	Approx. 55 g	Approx. 45 g	Approx. 65 g	Approx. 60 g

**PH-1**

(Approx. 140 g with a 1-m cord)

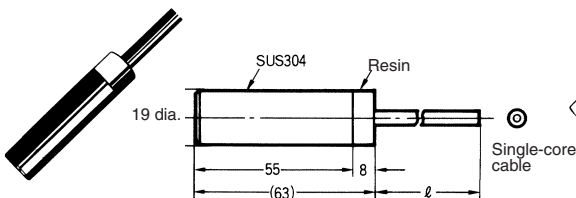

Cable OD: Vinyl 5.0 dia., Hypalon 6.5 dia.

**PH-2**

(Approx. 235 g with a 1-m cord)

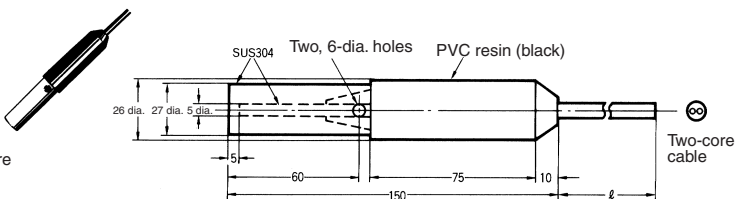

Cable OD: Vinyl, Hypalon 6.8 dia.

**Note:** Cable is supplied in lengths of 1, 5, 10, 15, 20, 30, 40, 50, 60, 70, 80, 90, or 100 meters.

**Electrode Separators**

F03-14 1P for one pole	F03-14 3P for three poles	F03-14 5P for five poles
<p>Weight: Approx. 15 g</p>	<p>Weight: Approx. 30 g</p>	<p>Weight: Approx. 30 g</p>

## ■ Electrode Bands

**F03-05 3P, 4P, 5P**

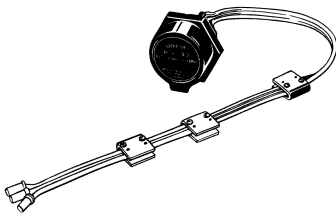

Black printing  
(1 mm wide)  
Outer sheath: PVC  
Core: SUS304, 0.3 dia. x 21 twisted

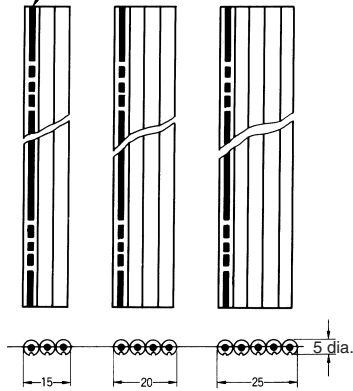

**F03-06 Electrode Band Connecting Nut (SUS304)**

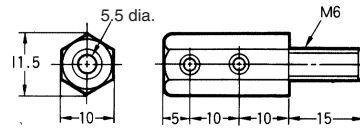

**F03-07 U-shaped Electrode Band Weight (SUS304)**

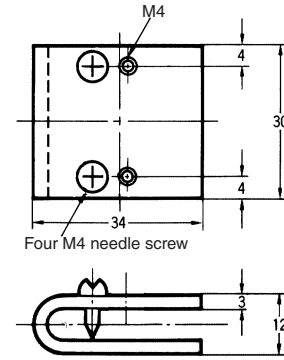

**F03-08 End Cap (Neoprene Rubber)**

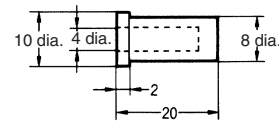

# ■ Connecting Sockets

## Available Models

Model No. of Controller Unit	Track-mounted Socket	Back-connecting Socket
61F-UHS	8PFA1	PL08
61F-HSL	8PFA	PL08
61F-APN2	PF083A-E	PL08
61F-G1P 61F-G2P 61F-IP	14PFA	PL15
61F-GP-N 61F-GPN-V50	PF113A-E	PL11
61F-GP-N8	PF083A-E	PL08
61F-03B 61F-04B	PF113A-E	PL11

## Track-mounted Sockets

### PF083A-E

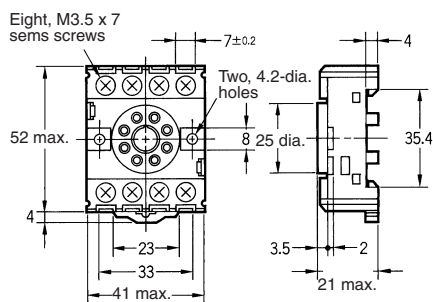
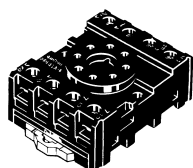

Terminal Arrangement/  
Internal Connections  
(Top View)

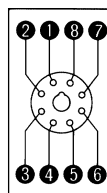

Mounting Holes

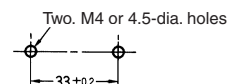

### 8PFA

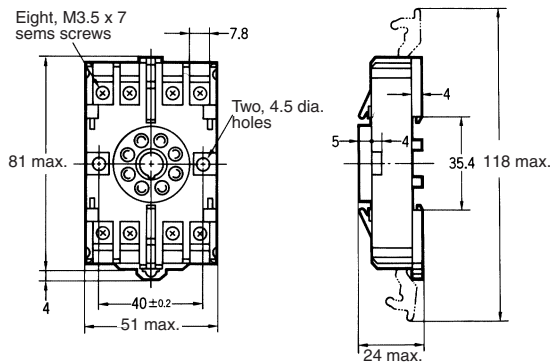
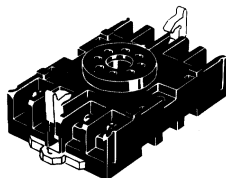

Terminal Arrangement/  
Internal Connections  
(Top View)

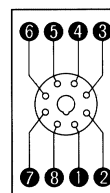

Mounting Holes

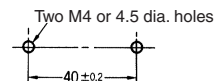

### 8PFA1

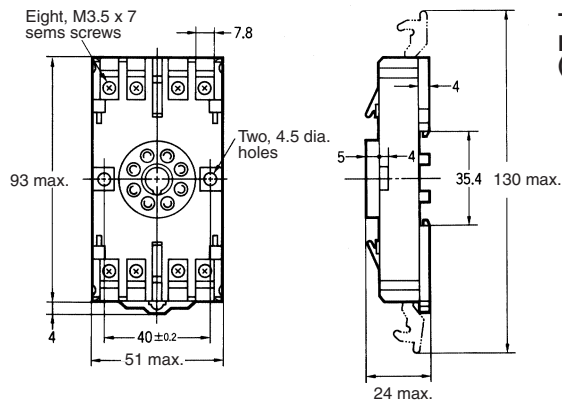
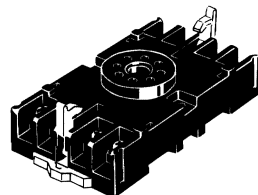

Terminal Arrangement/  
Internal Connections  
(Top View)

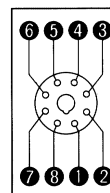

Mounting Holes

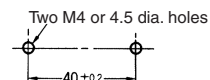

14PFA

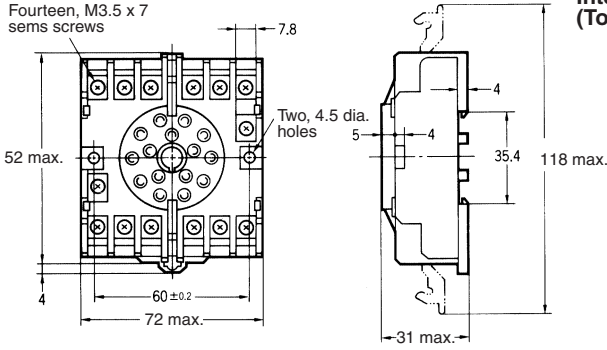
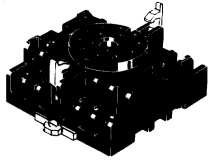

M3.5 x 11.5 sems screws for terminal screws

Terminal Arrangement/  
Internal Connections  
(Top View)

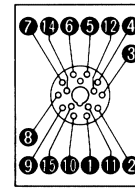

Mounting Holes

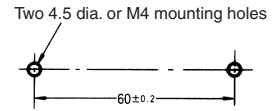

PF113A-E

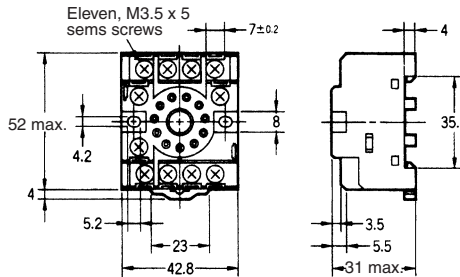
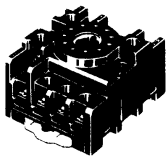

Terminal Arrangement/  
Internal Connections  
(Top View)

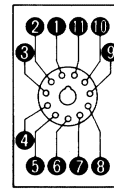

Mounting Holes

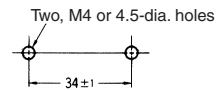

Back-connecting Sockets

PL08

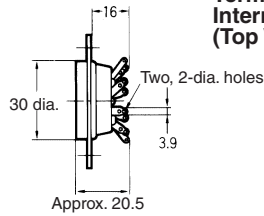
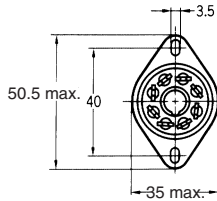
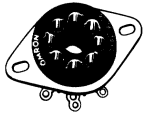

Terminal Arrangement/  
Internal Connections  
(Top View)

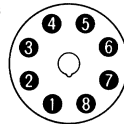

Mounting Holes

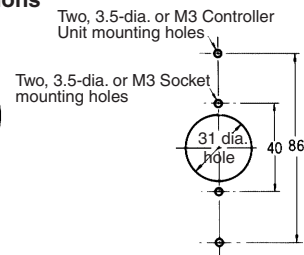

PL11

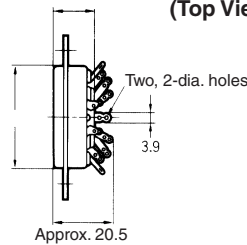
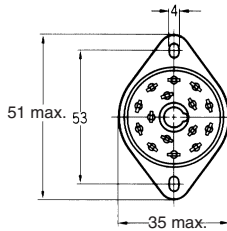

Terminal Arrangement/  
Internal Connections  
(Top View)

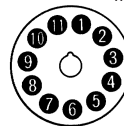

Mounting Holes

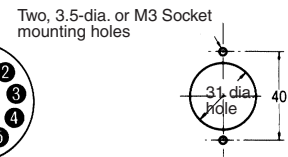

PL15

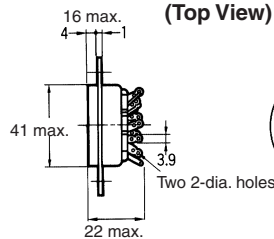
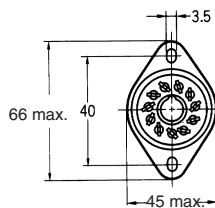

Terminal Arrangement/  
Internal Connections  
(Top View)

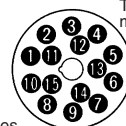

Mounting Holes

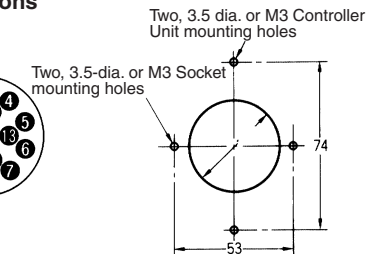

## ■ Mounting Brackets

When the 61F-G1P/-G2P/-IP/-UHS/-HSL is mounted with a Track-mounted Socket, the Controller is held secure by Mounting Brackets attached to the Socket.

### 61F-GP-N

To mount the 61F-GP-N or 61F-GPN-V50 on the PF113A-E Track-mounted Socket, use the PFC-N8 Mounting Brackets attached to the Socket as accessories.

#### PFC-N8

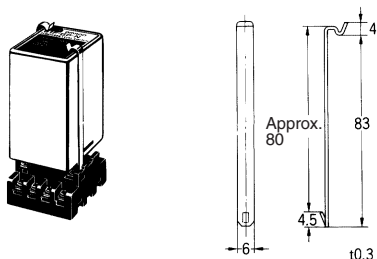

To mount the 61F-GP-N or 61F-GPN-V50 on the PL11 Back-connecting Socket, use the PHC-5 Mounting Brackets.

#### PHC-5

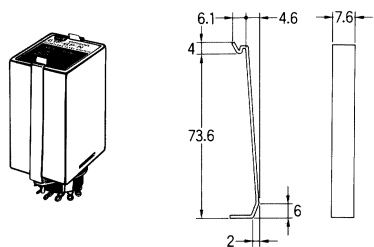

### 61F-03B/-04B

When mounting the 61F-03B/-04B on the PF113A-E Track-mounted Socket, use the PFC-A1 Mounting Bracket.

#### PFC-A1

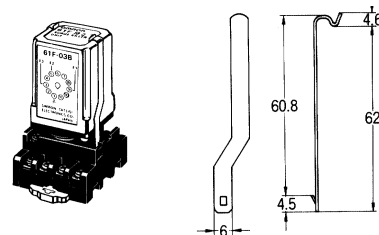

To mount the 61F-03B/-04B Unit to the PL11 Back-connecting Socket, use the PLC-1 Mounting Brackets.

#### PLC-1

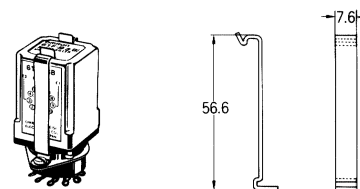

### 61F-GP-N8/61F-APN2

To mount the 61F-GP-N8/61F-APN2 on the PF083A-E, use the PFC-N8 Mounting Bracket.

#### PFC-N8

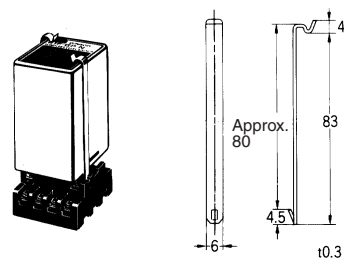

## ■ DIN Track Mounting Accessories

**DIN Track**  
PFP-100N  
PFP-50N

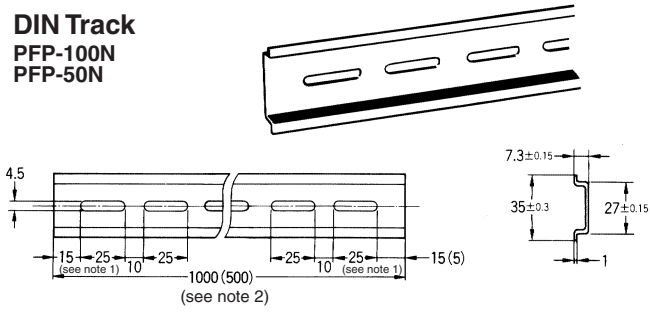

**End Plate**  
PFP-M

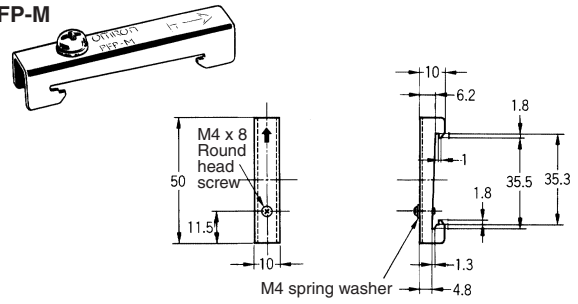

**DIN Track**  
PFP-100N2

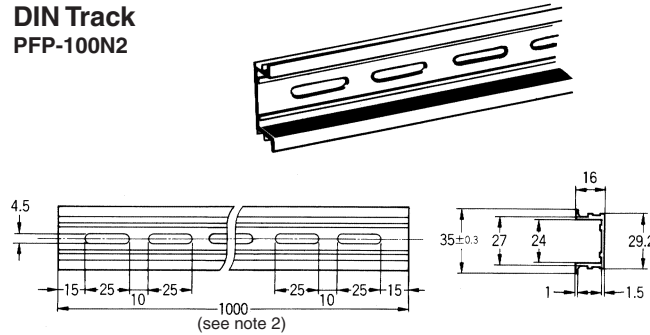

**Spacer**  
PFP-S

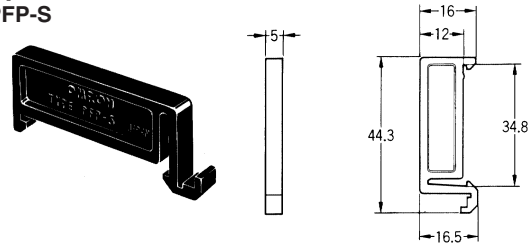

- Note:** 1. The PFP-100N is 15 mm on both ends, while the PFP50N is 15 mm on one end and 5 mm on the other end.  
2. Indicates total DIN Track length.

1 m: PFP-100N  
50 cm: PFP-50N  
1 m: PFP-100N2



## ■ Connection with SE Motor Protective Relay

### Prevents Burnouts in Motors and Pumps



Static relay for protection of motors and pumps against problems due to overload, open phase, reverse phase, etc.

Applicable to all 61F-series Controllers except for 61F-I (indicator model).

### Connection Example (When Combined with 61F-G)

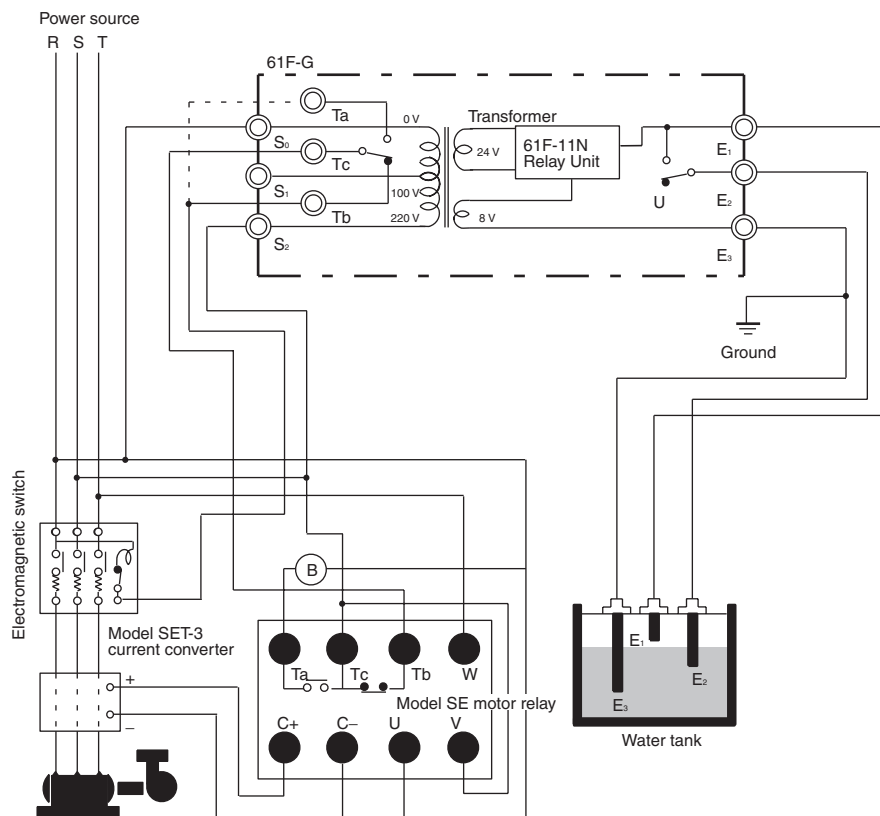

## Application Example

- Level control in tanks, reservoirs, sewage plants, underground wells, mixing plants etc.
- Level control for element protection in pipes, channels, and irrigation systems.
- Flow detection in pipes, channels, and irrigation systems.
- Ice bank control in cold drink dispensers, ice makers, water chillers, bulk milk tanks, etc.

- Dispensing of liquids by volume.
- Indication of liquid buildup due to filter blockages.
- Pollution/foul water detection for rivers, drains, etc.
- Alarm control warning of abnormal or dangerously high or low levels.

## 61F Selection Guidelines

• The limit of specific resistivity of a fluid controlled by the general-purpose model at an immersion depth not exceeding 30 mm is 30  $\Omega$ -cm, using PS-3S Electrode Holders. Use the high-sensitivity models (H type) for liquids with higher resistivity (see note 1). Refer to the resistivity values listed for water and other liquids in Table 1 and Table 3 when selecting the unit specification. The resistivity range detectable by the 61F is shown in Table 2. Refer to the information on the units and the fluid to be controlled when selecting the appropriate model.

**Note: 1.** The high-sensitivity models may suffer from resetting problems when used with certain types of water. In some cases it cannot substitute for the general-purpose models or low-sensitivity models. Be sure to select the model appropriate for the application.

**2.** The circuit configuration of the 61F-□H high-sensitivity model is designed so that the relay de-energizes when there is water present across the Electrodes. When power supply voltage is applied, the internal relay turns to the NO contact and, when the electrode between E1 and E3 becomes conductive, the relay is reset to the NC contact. This contact operation is reverse for models other than the high-sensitivity models. Although the internal relay operates (and operation indicator turns ON) simply when the power supply voltage is applied, this operation is not abnormal. (The relay in the 61F-□NH energizes when there is water present across the Electrodes.)

**⚠ Caution**

In case of the 61F-HSL ultra high-sensitivity variable model, malfunction due to electric corrosion may occur in the DC electrode circuit. Be careful not to use the product in such a way where current constantly flows between electrodes.

### Table 1 Water Resistivity Values (Japanese Reference Values)

Water type	Resistivity
City water	5 to 10 $k\Omega \cdot cm$
Well water	2 to 5 $k\Omega \cdot cm$
River water	5 to 15 $k\Omega \cdot cm$
Rain water	15 to 25 $k\Omega \cdot cm$
Sea water	0.03 $k\Omega \cdot cm$
Sewage	0.5 to 2 $k\Omega \cdot cm$
Distilled water	250 to 300 $k\Omega \cdot cm$ min.

### Table 2 Detectable Resistivity Ranges

Model	Resistivity (recommended values)
Long-distance models (4 km)	5 $k\Omega \cdot cm$ max.
Long-distance models (2 km)	10 $k\Omega \cdot cm$ max.
Low-sensitivity models	10 $k\Omega \cdot cm$ max.
2-wire models	10 $k\Omega \cdot cm$ max.
General-purpose models	10 to 30 $k\Omega \cdot cm$
High-temperature models	10 to 30 $k\Omega \cdot cm$
High-sensitivity models (compact plug-in models)	30 to 200 $k\Omega \cdot cm$
High-sensitivity models (standard models)	30 to 300 $k\Omega \cdot cm$
Ultra High-sensitivity models	100 to 10 $k\Omega \cdot cm$

**Note:** The specific resistivity ranges of fluids to be controlled are given for the PS-3S at an immersion depth not exceeding 30 mm.

### Table 1 A Conductance Values of Water

Water type	Conductance
City water	100 to 200 $\mu S/cm$
Well water	200 to 500 $\mu S/cm$
River water	67 to 200 $\mu S/cm$
Rain water	40 to 67 $\mu S/cm$
Sea water	33,300 $\mu S/cm$
Sewage	500 to 2,000 $\mu S/cm$
Distilled water	3.3 to 4 $\mu S/cm$ max.

## ■ Precautions

### ⚠ WARNING

Do not touch the terminals while power is being supplied. Doing so may possibly result in electric shock. Make sure that the terminal cover is installed before using the product.



### ⚠ CAUTION

Do not attempt to disassemble, repair, or modify the product. Doing so may occasionally result in minor or moderate injury due to electric shock.



## Precautions for Safe Use

### Use a Power Supply with Minimal Voltage Fluctuation

Avoid connection to a power supply with a voltage fluctuation greater than or equal to +10% or -15%.

### Consider the Ambient Temperature

Do not install the 61F where it may be exposed to a temperature of 55°C or more and a humidity of 85% or more. In particular, install the 61F away from heat-generating equipment incorporating coils or windings. Also avoid locations subject to high humidity or corrosive gases.

### Avoid Vibration and Shocks

Do not subject the 61F to vibration or shocks which can cause chattering problems. Do not install the 61F near contactors that generate severe shocks while the contactors are in operation.

### Do Not Test with a Megaohmmeter

During insulation resistance measurements, never apply the megaohmmeter across the Electrode terminals.

### Use Self-holding Electrodes

Use Self-holding (E2) Electrodes when contactor open/close control is carried out. If E<sub>1</sub> Electrodes are used, ripples on the liquid surface can cause incorrect contactor operation and damage to the contacts.

Be sure to turn OFF the power supply before replacing the plug-in models.

### Short Wiring in Electrode Circuit

Keep the wires connecting the 61F to Electrode Holders as short as possible. If long leads are used, the floating capacity of the leads, and abnormal surges or noise in the Electrode circuit can cause malfunctions.

The thicker the cables, the shorter the permitted wiring length. The length of the cable connecting the 61F and Electrode described in the 61F datasheet will be available if a 600-V VCT0.75-mm<sup>2</sup>, 3-core cable type is used. Test results indicate that the actual wiring length using VCT 3.5-mm<sup>2</sup>, 3-core cable laid over the ground is 50% of the indicated length for general-purpose applications and 80% of the indicated length for long-distance applications. When selecting the cable specification, remember that the wiring length is further decreased for underground cables and larger diameter cables because of the increased floating capacity with the ground.

## Keep Power Cables Separate from the Electrode Circuit

Do not pass the leads for the Electrode circuit through the same duct, or near to, high-tension cables or power cables. This can cause noise which leads to malfunctions.

## Ground Correctly

Ground the common Electrode terminal to reduce the effects of noise.

## Use a Surge Suppressor

Connect a 61F-03B(-04B) Surge Suppressor with the 61F Electrode terminals to protect the circuit from surges. This is particularly important in lightning-prone areas. To further improve protection, install a commercial surge suppressor in the power supply to eliminate surges in the power system.

## Consider the Response Times

The 61F requires a response time not exceeding 80 ms for operation or 160 ms for reset. Take these response times into account in cases where precise sequence control is required.

## Consider the Liquids to Be Controlled

The 61F cannot be used for any liquid that has almost no conductivity such as sewage containing oil.

The 61F cannot be used for any flammable liquid such as gasoline, kerosene, or heavy oil.

## Do Not Share Electrodes

Do not connect a single Electrode to more than one 61F. If the phases of the 8-VAC Electrode-circuit power supplies are opposite to each other, as shown in Fig. 1, an internal close circuit (return circuit) is created (indicated by the arrows). The 61F may malfunction regardless of the liquid level when the 61F power is turned ON. This problem can be overcome by matching the power supply phases, as shown in Fig. 2, but in this configuration the internal impedance of the 61F calculated from the Electrode will be approximately half as large as the internal impedance of a single 61F. The same phenomenon can occur if multiple (not shared) Electrodes, connected to separate 61F units, are installed close together inside a single tank. Maintain sufficient clearance between Electrodes connected to separate 61F units so that they do not interfere with each other. Common leads, however, can be connected to the ground Electrode.

Fig. 1 Internal Closed Circuit

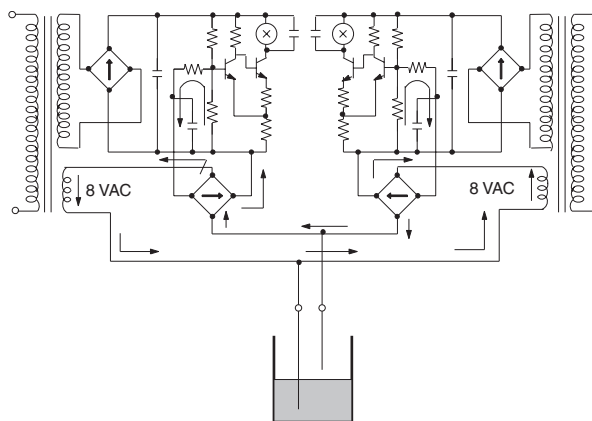
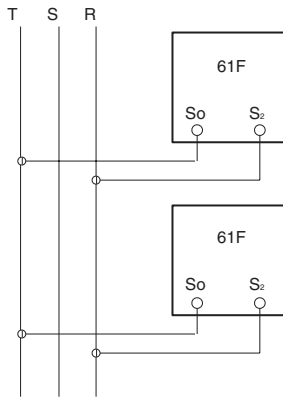

Fig. 2 Match Phases



## ■ Cautions on Electrodes

Be sure to disconnect the 61F before conducting an insulation test on the Electrode circuit for inspection purposes.

When cutting an Electrode, be sure to chamfer cut surfaces of the electrode.

## Maintain a Clearance Between Electrodes

Maintain sufficient clearance (normally 1 m) between Electrodes in sea water or contaminated water. Use the 61F-□D (or -□ND) low-sensitivity models if this clearance is difficult to maintain.

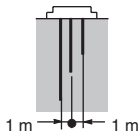

## Long Ground Electrode

The Electrodes are mounted in sets of three. Connect the shortest Electrode to E<sub>1</sub>, the medium Electrode to E<sub>2</sub> and the longest Electrode to E<sub>3</sub>. The longest Electrode, E<sub>3</sub>, must be at least 50 mm longer than the other Electrodes.

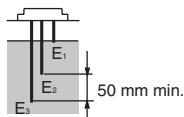

## Consider the Operating Level

Due to the liquid type and fluctuations in the power supply voltage, the operating level may fluctuate to a small degree from the level at which the liquid surface makes contact with the Electrode tip.

## Use Separators

If the Electrode length reaches 1 m min., insert Separators at the joint positions to prevent the Electrodes touching each other in the liquid.

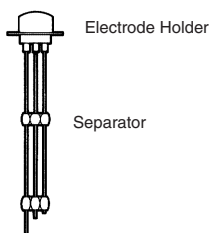

## Do Not Allow Suspended Matter to Short the Electrodes.

If suspended matter may short the electrodes, use tubing electrodes. The tubing must be removed at least 100 mm from the bottom end to ensure sufficient conductivity. Do not use a tubing electrode as a ground electrode.

## Mount Electrodes Vertically

Install the Electrodes vertically to avoid the accumulation of slime which can form an insulating layer on the Electrode surface.

## Keep Electrodes Clean

Lift the Electrodes and remove the surface film with fine sandpaper about 6 months after installation. Subsequently, repeat this cleaning once or twice per year.

Cleaning is particularly important for Electrodes used in a liquid containing large amounts of dirt or slime, which can build up into an insulating film on the Electrode surface and cause malfunctions. Clean the surface insulating film from Electrodes used in this environment once every three months. Use a pipe, as shown in the diagram below in situations where the water contains large amounts of dirt.

Use a pipe as shown to keep dirt and oil films from the Electrode in situations where the liquid is highly contaminated with dirt and oil, such as sewage holding tanks.

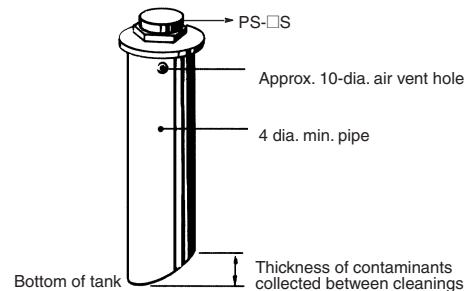

Use a pipe at least 4 inches in diameter.

Cut off the end of the pipe at an angle to clear the estimated amount of contaminants accumulating at the bottom of the tank.

Drill an approximately 10-dia. vent hole at the top of the pipe.

Using an Anti-ripple Pipe:

Use an anti-ripple pipe as shown below in cases where large ripples are produced by a rapid fluid flow rate.

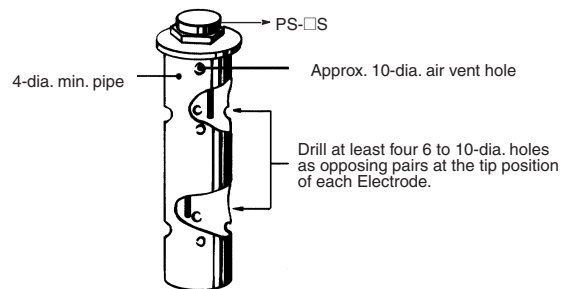

Use a pipe at least 4 inches in diameter.

To improve liquid circulation inside the pipe, drill at least four 6 to 10-dia. holes as opposing pairs at the tip position of each Electrode.

Drill an approximately 10-dia. vent hole at the top of the pipe.

Follow the information above with regard to using Electrodes.

## ■ Cautions on Electrode Holders

Do not mount horizontally or a malfunction may occur.

### BS and BF Electrode Holders

When installing the Electrodes, first tighten the connection nut with a wrench before tightening the Electrodes and lock nut. Tightening the terminals or other parts can lead to damage of the insulating parts due to tightening torque.

When mounting a BS-1 Electrode Holder to a boiler, wrap Teflon tape 2 or 3 times around the mounting position and use the gasket supplied.

Always apply the F03-11 Protective Cover if the BF-3 (-4 or -5) is used outside or in a position subject to water splashes or where dust or dirt can settle. Foreign matter on the Electrode insulation can cause electrical leakage and malfunctions.

## ■ Inspecting the Electrode Circuits

In cases where the Electrodes cannot be withdrawn to test the Electrode circuit, a tester can be used to measure the resistance between the Electrode and ground, as shown in the diagram below. The measured resistance value indicates the length, contact condition, and mounting condition of the Electrode. For example, the sequence of Electrodes ordered from low measured resistance to high is E<sub>3</sub> (long), E<sub>2</sub> (medium), and E<sub>1</sub> (short).

Follow the guidelines below to use this test method.

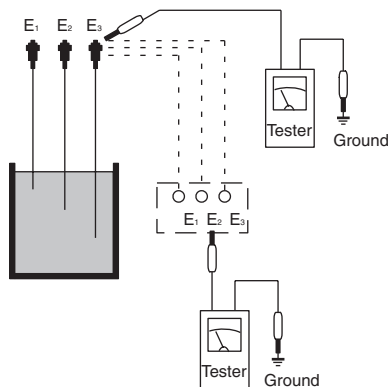

1. Detach the leads from the 61F.
2. Measure the conducting status with the tank full. (The water level must be at E<sub>1</sub> minimum.)
3. Measure the insulating status with the tank empty. (The water level must be at E<sub>3</sub> maximum.)

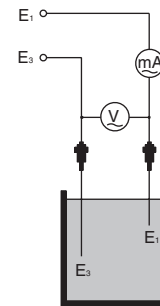

## ■ Measuring the Resistance Between Electrodes

Measure the resistance between the Electrodes if the wiring is correct but the 61F does not operate. Measure with a voltmeter using the voltage drop method, as shown below.



-  An ammeter able to read approximately 1 mA with as low an impedance as possible.
-  A voltmeter able to read a value of several volts with as high an impedance as possible.

The resistance between Electrodes (resistance of liquid between E<sub>1</sub> and E<sub>3</sub>) is given by the following equation.

$$R = V/I$$

Where,

R: resistance of liquid between Electrodes ( $\Omega$ )

V: voltmeter indicated voltage (V)

I: ammeter indicated current (mA)

Select the 61F model according to the R (resistance) value.

## ■ Inspecting the 61F-11N Relay Unit

Apply the specified power supply voltage with the Relay Units connected to the 61F. Refer to the connection diagrams (internal wiring diagrams) and short the 61F ground terminal to the operating terminal of each Relay Unit. Check the operation of the relay output contacts with a tester. With the 61F-11 models, the indicator will be lit when the Relay Unit operates.

# Water Leak Alarm/Detector 61F-WLA/GPN-V50

- Eliminate Problems Caused from Water Leakage
- 0 to 50 kΩ variable operating resistance to detect virtually any liquid.
- Two types available: Water Leak Alarm (61F-WLA) and plug-in Water Leak Detector (61F-GPN-V50).
- 24 VAC interelectrode voltage causes no electrolytic corrosion.
- Suggested applications include computer room, power plant, factory, library, warehouse, and basement use.
- Conforms to EMC/IEC Standards (61F-GPN-V50).
- Approved by UL/CSA (61F-GPN-V50)



## Ordering Information

Water Leak Alarm	61F-WLA
Water Leak Detector	61F-GPN-V50

When ordering, to complete the part number, be sure to specify the desired operating voltage.

Example: 61F-WLA [120/240 VAC]

\_\_\_\_\_ Desired supply voltage

## Specifications

### ■ Ratings/Characteristics

Item	Water Leak Alarm	Water Leak Detector
Model	61F-WLA	61F-GPN-V50
Supply voltage	100/200, 110/220, 120/240 VAC	100, 110, 120, 200, 220, 240 VAC
Interelectrode voltage	24 VAC	
Operating current	3 mA (AC) max.	
Power consumption	8.0 VA max.	3.2 VA max.
Sensitivity	Variable (0 to 50 kΩ)	
Error (against the scale)	Scale 0: 10 kΩ Scale 50: ±10 kΩ (see note 2)	Scale 0: 10 kΩ Scale 50: ±10 kΩ (see note 2)
Contact ratings	3 A 250 VAC, SPDT cosφ=1 1 A 250 VAC, SPDT cosφ=0.4	3 A 250 VAC, DPDT cosφ=1 1 A 250 VAC, DPDT cosφ=0.4
Indicator	Provided (Power and Leak indicators)	Provided (Operation indicator)
Alarm buzzer	Provided	Not provided
Test switch	Provided	Not provided
Ambient temperature	-10°C to 55°C	

- Note:** 1. For detecting leakage of water with high resistivity, use 61F-UHS or 61F-HSL ultra high-sensitivity models. (Refer to page 34.)  
2. The Detector may not operate around the setting value of "0." Adjust the sensitivity depending on the actual application.

# Operation

## Internal Circuit

61F-GPN-V50 Water Leak Detector

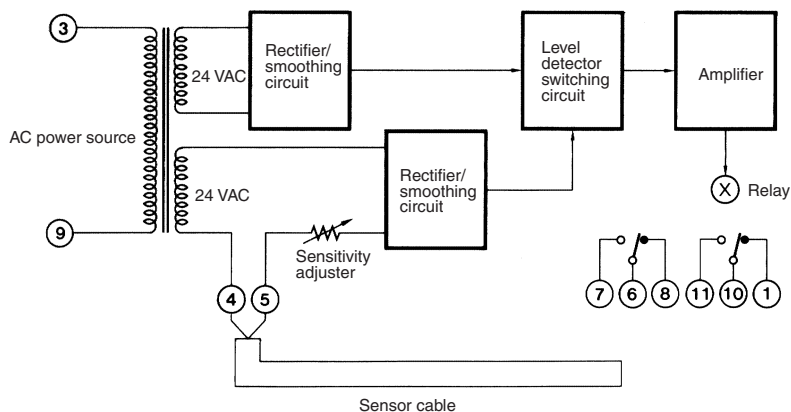

## Operating Principle

When the two conductive cores of the Sensor Cable are contacted by a liquid, a weak alternating current (as small as 3 mA max.) flows across the cores. This current is amplified to operate a relay.

In practice, leakage will be detected if water drops are present between the core wire and the Electrode (F03-15 Sensor Cable) or ring section (F03-16PE Sensor Cable). (Refer to the specifications on page 72)

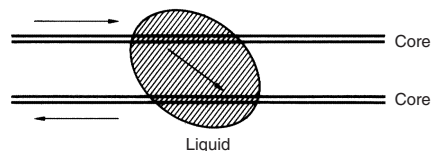

## Sensor Cable Protective Cover

Item	F03-25	F03-26PES
Appearance		
Suggested use		
Construction		
Comments	Fixes the F03-15 Sensor Cable on the floor surface. Attach the sticker on a smooth surface. To attach it on a concrete floor, use a concrete bonding agent.	Fixes the F03-16PE Sensor Cable on the floor surface. Attach the sticker on a smooth surface. To attach it on a concrete floor, use a concrete bonding agent.

# Dimensions

Note: All units are in millimeters unless otherwise indicated.

## 61F-WLA Water Leak Alarm

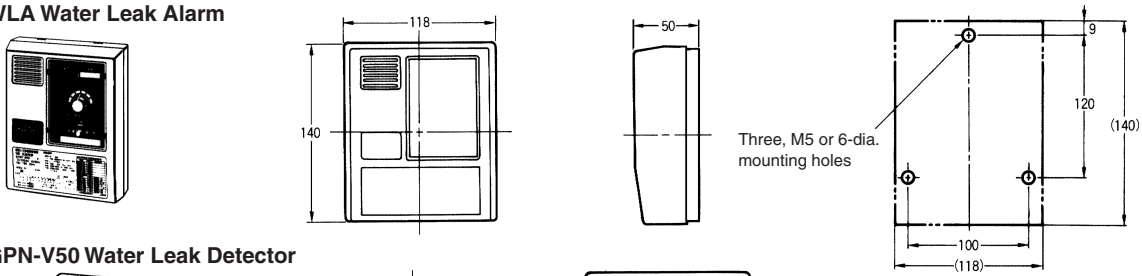

## 61F-GPN-V50 Water Leak Detector

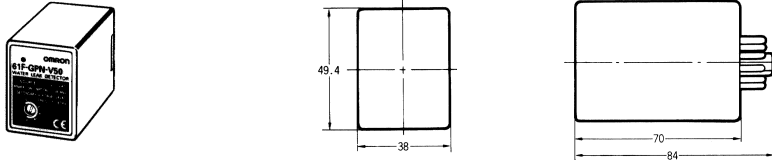

## ■ Accessories (Order Separately)

### Connecting Sockets (for 61F-GPN-V50 Water Leak Detector)

#### PF113A-E Track-mounted Socket

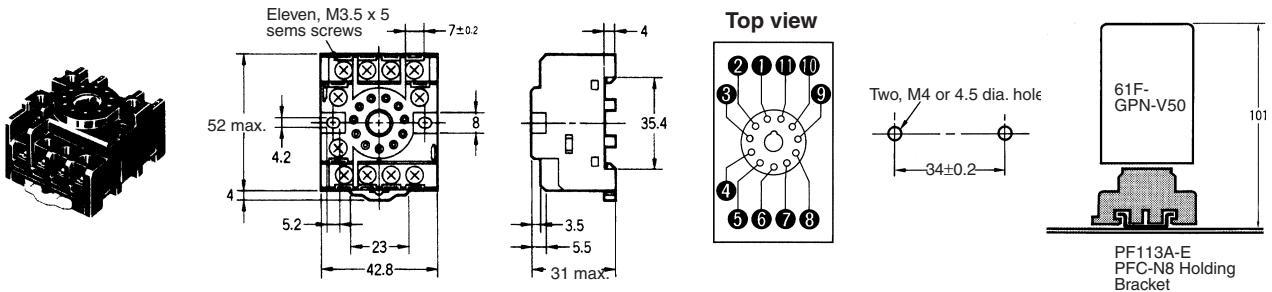

#### PL11 Back-connecting Socket

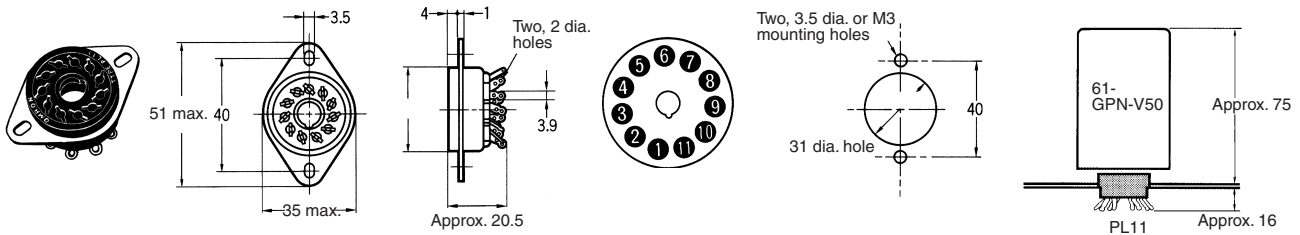

**Important:** Install the Water Leak Detector socket with the keyway facing down.

### Sensor Cable

#### F03-15

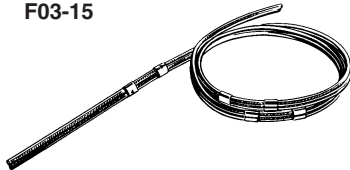

Sheath: Transparent vinyl chloride  
Core: Stainless steel SUS304

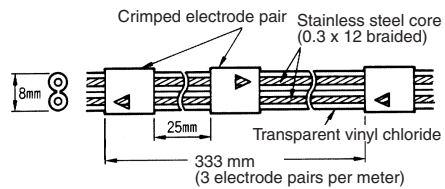

#### F03-16PE

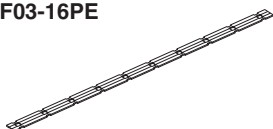

Sheath: Transparent vinyl chloride  
Core: Stainless steel SUS316

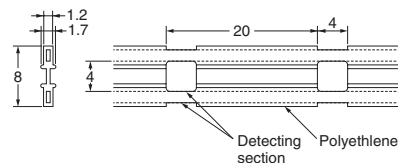



# Installation

## Connections

61F-WLA Water Leak Alarm

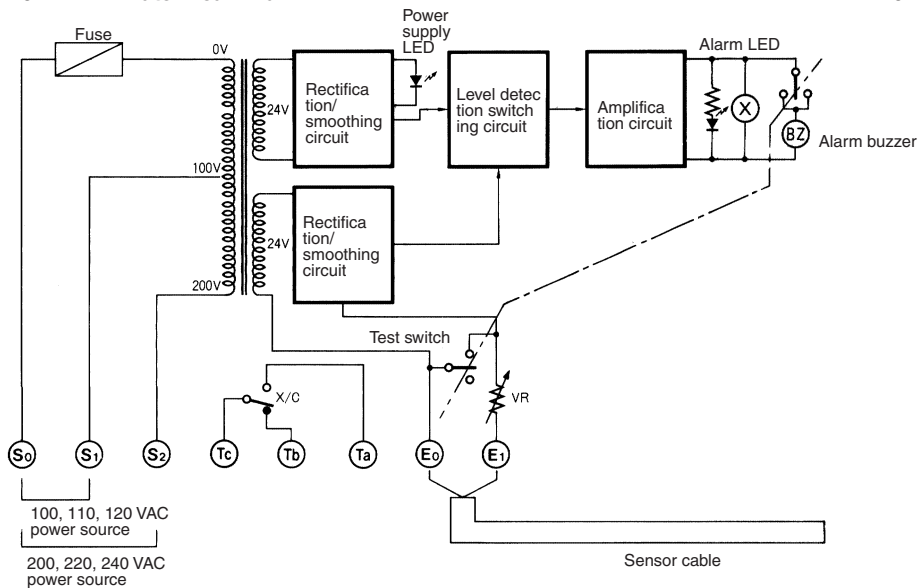

61F-GPN-V50 Water Leak Detector

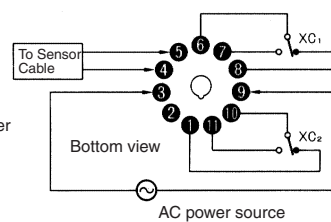

## ■ Precautions

### WARNING

Do not touch the terminals while power is being supplied. Doing so may possibly result in electric shock. Make sure that the terminal cover is installed before using the product.



### CAUTION

Do not attempt to disassemble, repair, or modify the product. Doing so may occasionally result in minor or moderate injury due to electric shock.



## Precautions for Safe Use

- (1) Use only F03-15 or F03-16 Sensor Cable. Other water conductors may cause the Water Leak Alarm/Detector to malfunction, or not operate at all because of mismatched sensitivity.
- (2) Place the Sensor Cable at a location where water leakage is most likely to occur. For example, consider the following locations:
  - Under a raised floor; on the highest floor of a building; on the ceiling
  - In the vicinity of an air conditioner, or on the floor near a humidifier
  - On the floor near a feed-water pipe, conduit; hot-water pipe.
  - On top of a power, or control panel
- (3) Secure the Sensor Cable so that they touch the floor surface or the wall near a pipe arrangement. Cover the Sensor Cable with a F03-25 or F03-26 Protective Cover if they are installed at a location crowded with people. However, place the cover such a manner that water can easily reach the Sensor Cable.
- (4) Keep the temperature at the installation site to within 55°C. Do not install the Water Leak Alarm/Detector/Sensor cable in the proximity of heat-generating equipment (such as that having a coil or wire winding). Also, do not use it in a highly humid location, or at a location that is subjected to corrosive gases. Do not place the Water Leak Alarm/Detector side-by-side with a high-capacity contactor that produces an inrush current when it operates, as such arrangement may cause chattering to occur, consequently causing a malfunction of the Water Leak Alarm/Detector.
- (5) Wiring distance of the Sensor Cable varies depending on the water quality. When using IV cables, wire the Sensor Cable to the length specified in the following table.
- (6) Mount the 61F-WLA Water Leak Alarm/Detector on a sturdy wall surface which is not subjected to vibration or shock. Do not use double-sided adhesive tape, otherwise, the Detector may detach when the adhesive tape deteriorates due to aging.
- (7) When wiring the Sensor on conductive objects like metal objects, use the F03-16.
- (8) When measuring insulation resistance, do not conduct a megger test between the electrode terminals.

IV Cable	Sensor Cable
0 m	200 m
10 to 150 m	150 m
200 to 300 m	100 m
350 to 400 m	50 m

**Note:** IV cable: 2 mm<sup>2</sup>



## Warranty and Application Considerations

### Read and Understand this Catalog

Please read and understand this catalog before purchasing the products. Please consult your OMRON representative if you have any questions or comments.

## Warranty and Limitations of Liability

### Warranty and Limitations of Liability

#### WARRANTY

OMRON's exclusive warranty is that the products are free from defects in materials and workmanship for a period of one year (or other period if specified) from date of sale by OMRON. OMRON MAKES NO WARRANTY OR REPRESENTATION, EXPRESS OR IMPLIED, REGARDING NON-INFRINGEMENT, MERCHANTABILITY, OR FITNESS FOR PARTICULAR PURPOSE OF THE PRODUCTS. ANY BUYER OR USER ACKNOWLEDGES THAT THE BUYER OR USER ALONE HAS DETERMINED THAT THE PRODUCTS WILL SUITABLY MEET THE REQUIREMENTS OF THEIR INTENDED USE. OMRON DISCLAIMS ALL OTHER WARRANTIES, EXPRESS OR IMPLIED.

#### LIMITATIONS OF LIABILITY

OMRON SHALL NOT BE RESPONSIBLE FOR SPECIAL, INDIRECT, OR CONSEQUENTIAL DAMAGES, LOSS OF PROFITS, OR COMMERCIAL LOSS IN ANY WAY CONNECTED WITH THE PRODUCTS, WHETHER SUCH CLAIM IS BASED ON CONTRACT, WARRANTY, NEGLIGENCE, OR STRICT LIABILITY.

In no event shall the responsibility of OMRON for any act exceed the individual price of the product on which liability is asserted.

IN NO EVENT SHALL OMRON BE RESPONSIBLE FOR WARRANTY, REPAIR, OR OTHER CLAIMS REGARDING THE PRODUCTS UNLESS OMRON'S ANALYSIS CONFIRMS THAT THE PRODUCTS WERE PROPERLY HANDLED, STORED, INSTALLED, AND MAINTAINED AND NOT SUBJECT TO CONTAMINATION, ABUSE, MISUSE, OR INAPPROPRIATE MODIFICATION OR REPAIR.

## Application Considerations

### Application Considerations

#### BASIC CONSIDERATIONS

At OMRON, we are constantly working to improve the quality and reliability of our products. SSRs, however, use semiconductors, which are prone to malfunction. Be sure to use SSRs within their rated values. Use the SSRs only in systems that are designed with redundancies, flame protection, countermeasures to prevent operation errors, and other countermeasures to prevent accidents involving human life or fires.

#### SUITABILITY FOR USE

OMRON shall not be responsible for conformity with any standards, codes, or regulations that apply to the combination of products in the customer's application or use of the products.

At the customer's request, OMRON will provide applicable third party certification documents identifying ratings and limitations of use that apply to the products. This information by itself is not sufficient for a complete determination of the suitability of the products in combination with the end product, machine, system, or other application or use.

The following are some examples of applications for which particular attention must be given. This is not intended to be an exhaustive list of all possible uses of the products, nor is it intended to imply that the uses listed may be suitable for the products.

- Outdoor use, uses involving potential chemical contamination or electrical interference, or conditions or uses not described in this catalog.
- Nuclear energy control systems, combustion systems, railroad systems, aviation systems, medical equipment, amusement machines, vehicles, safety equipment, and installations subject to separate industry or government regulations.
- Systems, machines, and equipment that could present a risk to life or property.

Please know and observe all prohibitions of use applicable to the products.

NEVER USE THE PRODUCTS FOR AN APPLICATION INVOLVING SERIOUS RISK TO LIFE OR PROPERTY WITHOUT ENSURING THAT THE SYSTEM AS A WHOLE HAS BEEN DESIGNED TO ADDRESS THE RISKS, AND THAT THE OMRON PRODUCTS ARE PROPERLY RATED AND INSTALLED FOR THE INTENDED USE WITHIN THE OVERALL EQUIPMENT OR SYSTEM.

## Disclaimers

### Disclaimers

#### PERFORMANCE DATA

Performance data given in this catalog is provided as a guide for the user in determining suitability and does not constitute a warranty. It may represent the result of OMRON's test conditions, and the users must correlate it to actual application requirements. Actual performance is subject to the OMRON *Warranty and Limitations of Liability*.

#### CHANGE IN SPECIFICATIONS

Product specifications and accessories may be changed at any time based on improvements and other reasons.

It is our practice to change model numbers when published ratings or features are changed, or when significant construction changes are made. However, some specifications of the products may be changed without any notice. When in doubt, special model numbers may be assigned to fix or establish key specifications for your application on your request. Please consult with your OMRON representative at any time to confirm actual specifications of purchased products.

#### DIMENSIONS AND WEIGHTS

Dimensions and weights are nominal and are not to be used for manufacturing purposes, even when tolerances are shown.

#### ERRORS AND OMISSIONS

The information in this catalog has been carefully checked and is believed to be accurate; however, no responsibility is assumed for clerical, typographical, or proofreading errors, or omissions.

## Copyright and Copy Permission

### Copyright and Copy Permission

#### COPYRIGHT AND COPY PERMISSION

This catalog shall not be copied for sales or promotions without permission.

This catalog is protected by copyright and is intended solely for use in conjunction with the products. Please notify us before copying or reproducing this catalog in any manner, for any other purpose. If copying or transmitting this catalog to another, please copy or transmit it in its entirety.

**ALL DIMENSIONS SHOWN ARE IN MILLIMETERS.**

To convert millimeters into inches, multiply by 0.03937. To convert grams into ounces, multiply by 0.03527.

Cat. No. F030-E1-09 **In the interest of product improvement, specifications are subject to change without notice.**

**OMRON Corporation**  
Industrial Automation Company

Industrial Devices and Components Division H.Q.  
Measuring Components Department  
Shiokoji Horikawa, Shimogyo-ku,  
Kyoto, 600-8530 Japan  
Tel: (81)75-344-7080/Fax: (81)75-344-7189

Printed in Japan  
0304-1.5M (0104) (B)