

NT21, NT31 and NT631 Series

Programmable Terminals

Reference Manual

OMRON

NT21, NT31 and NT631 Series Programmable Terminals

Reference Manual

Produced October 2001

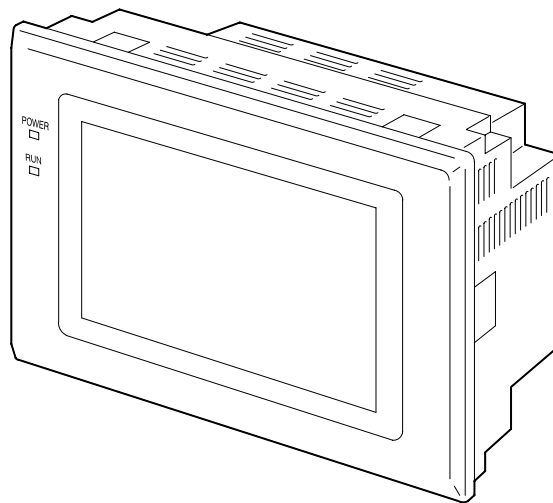



Notice:

OMRON products are manufactured for use according to proper procedures by a qualified operator and only for the purposes described in this manual.

The following conventions are used to indicate and classify precautions in this manual. Always heed the information provided with them. Failure to heed precautions can result in injury to people or damage to property.

 **DANGER** Indicates an imminently hazardous situation which, if not avoided, will result in death or serious injury.

 **WARNING** Indicates a potentially hazardous situation which, if not avoided, could result in death or serious injury.

 **Caution** Indicates a potentially hazardous situation which, if not avoided, may result in minor or moderate injury, or property damage.

OMRON Product References

All OMRON products are capitalized in this manual. The word “Unit” is also capitalized when it refers to an OMRON product, regardless of whether or not it appears in the proper name of the product.

The abbreviation “Ch,” which appears in some displays and on some OMRON products, often means “word” and is abbreviated “Wd” in documentation in this sense.

The abbreviation “PC” means Programmable Controller and is not used as an abbreviation for anything else.

Visual Aids

The following headings appear in the left column of the manual to help you locate different types of information.

Note Indicates information of particular interest for efficient and convenient operation of the product.

1, 2, 3... 1. Indicates lists of one sort or another, such as procedures, checklists, etc.

© OMRON, 2001

All rights reserved. No part of this publication may be reproduced, stored in a retrieval system, or transmitted, in any form, or by any means, mechanical, electronic, photocopying, recording, or otherwise, without the prior written permission of OMRON.

No patent liability is assumed with respect to the use of the information contained herein. Moreover, because OMRON is constantly striving to improve its high-quality products, the information contained in this manual is subject to change without notice. Every precaution has been taken in the preparation of this manual. Nevertheless, OMRON assumes no responsibility for errors or omissions. Neither is any liability assumed for damages resulting from the use of the information contained in this publication.

About this Manual:

This manual describes the basic functions and operation procedures of the NT-series NT21, NT31, NT31C, NT631, and NT631C Programmable Terminals, their operations when connected to a PC (Programmable Controller) or other host, and includes the sections described below.

Please read this manual carefully and be sure you understand the information provided before attempting to install and operate the Programmable Terminal.

Section 1 describes the functions of the PT.

Section 2 gives basic information on the method for connecting to the host and communication methods, and describes the names and functions of the parts of the PT.

Section 3 how to use the functions provided by the PT.

Section 4 gives an overview of memory link operations and contains explanations centered on communications between the PT and host when using memory link.

Section 5 presents a collection of simple practical examples that will give you hints on how to make best use of the functions of the PT.

Section 6 describes the action to take when PT errors occur.

The **Appendices** provide the specifications, compatibility with screen data of other PT models, NT30/620 emulation mode, PC memory maps, and keycode tables.



WARNING Failure to read and understand the information provided in this manual may result in personal injury or death, damage to the product, or product failure. Please read each section in its entirety and be sure you understand the information provided in the section and related sections before attempting any of the procedures or operations given.

Related Manuals:

Related manuals are listed below.

The □ symbol at the end of the catalog number is the revision number.

Connecting and Setting Up the Programmable Terminal

- NT21 PT Setup Manual (V068-E1-□)
- NT31 and NT31C PT Setup Manual (V062-E1-□)
- NT631 and NT631C PT Setup Manual (V063-E1-□)

These manuals are used separately for the different models of PT. They describe connecting the Programmable Terminals to a host and peripheral devices and settings required for communications and applications.

The functions and actual operating messages for the NT21, NT31, NT31C, NT631, and NT631C PTs are provided in the *Reference Manual* (V069-E1-□).

Programmable Terminal Functions and Operation

- NT21, NT31, and NT631 Series PT Reference Manual (V069-E1-□, this manual)

This manual is used for any of the following PTs: NT21, NT31, NT31C, NT631, and NT631C. It describes screen configurations, part functions, host control methods, and other application information.

PT connection and setup procedures are described in the *NT21 PT Setup Manual* (V068-E1-□), *NT31 and NT31C PT Setup Manual* (V062-E1-□), and the *NT631 and NT631C PT Setup Manual* (V063-E1-□).

Creating and Transferring Screen Data, and Installing the System Program

- NT-series Support Tool for Windows Ver. 4.6 Operation Manual (V061-E1-□)

The screens displayed on the NT21, NT31, NT31C, NT631, and NT631C PTs are created with the Support Tool and transferred to the PT. This manual describes how to create and transfer screen data. It also describes how to download a system program to a PT using the System Installer.

The NT-series Support Tool for Windows is normally referred to as merely the Support Tool.

Connecting to Controllers Not Made by OMRON

- PC Connection Manual (V042-E1-□)

The NT31, NT31C, NT631, and NT631C PTs can be connected to controllers in the following series: Mitsubishi's A Series and FX Series. This manual describes the connection and setup methods for these controllers.

The NT-series Support Tool for Windows Version 4.1 is required to connect the NT31, NT31C, NT631, and NT631C PTs to Mitsubishi controllers.

- NT31/NT631 Multivendor Connection Manual (V060-E1-□)

The NT31 and NT31C PTs can be connected to controllers in the following series: Allen-Bradley SLC 500 Series, GE Fanuc 90-20 and 90-30 Series, and Siemens S7-300 and S7-400 Series. This manual describes the connection and setup methods for these controllers.

TABLE OF CONTENTS

PRECAUTIONS	ix
1 Intended Audience	x
2 General Precautions	x
3 Safety Precautions	x
SECTION 1 – General	1
1-1 Role and Operation of the PT	2
1-1-1 Operation of a PT at an FA Production Site	2
1-1-2 Operations of the PT	3
1-2 Functions of the NT21, NT31/NT31C and NT631/NT631C	4
1-2-1 Features	4
1-2-2 Comparison between NT21, NT31, NT31C, NT631, and NT631C ..	6
1-2-3 Additional Functions of the V2 Versions of the NT31/NT31C and NT631/NT631C	7
1-2-4 Comparisons with Earlier Models	8
1-2-5 Principal Functions of NT21, NT31/NT31C, and NT631/NT631C ..	14
1-2-6 Displays	16
1-3 System Configuration	22
1-3-1 Peripheral Devices That Can Be Connected	22
1-3-2 Connecting to the Host	24
1-4 Communications with the Host	26
1-4-1 Direct Connection Function	26
1-4-2 Host Link	27
1-4-3 NT Link	27
1-4-4 Functions of the Allocated Bits and Words	28
1-4-5 Clock Data Area (PC to PT) (NT21 Only)	33
1-4-6 Connecting to other Companies' PCs	34
1-5 Communication by Using Memory Links	35
1-5-1 Memory Link	35
1-5-2 Comparison between Direct Connection and Memory Link	35
1-5-3 Memory Link Online Transfer Function	36
1-6 Before Operating	37
SECTION 2 – PT Functions	39
2-1 PT Screens	41
2-1-1 Screen Composition	41
2-1-2 Screen Numbers	41
2-1-3 Screen Types	41
2-1-4 Screen Attributes	45
2-1-5 Display Colors	47
2-1-6 Display Elements	49
2-2 Areas for Control/Notification	52
2-2-1 PT Status Control Area (Host e PT)	52
2-2-2 PT Status Notify Area (PT to Host)	61
2-2-3 Window Control Area (Host e PT)	65
2-2-4 Clock Data Area (Host to PT, NT21 Only)	69
2-3 Memory Tables	72
2-3-1 Numeral Memory Table	72
2-3-2 Character String Memory Table	79
2-3-3 Bit Memory Table	83
2-4 Fixed Displays	90
2-4-1 Circles, Arcs, Sectors, Polylines, Polygons, Rectangles (Fixed Displays)	90
2-4-2 Text (Fixed Display)	98
2-4-3 Tiling	101

Table of contents

2-4-4	Marks	103
2-5	Image and Library Data	106
2-5-1	Image Data Display	106
2-5-2	Library Data Display	109
2-6	Lamps	112
2-7	Touch Switches	119
2-8	Numeral Display	140
2-9	Character String Display	148
2-10	Graphs	154
2-10-1	Bar Graphs	154
2-10-2	Analog Meter	158
2-10-3	Broken Line Graphs	164
2-10-4	Trend Graphs	170
2-11	Alarm List, Alarm History	182
2-12	Inputting Numeric Values	192
2-12-1	Numeric Key Type (Numeral Input)	192
2-12-2	Thumbwheel Type (Thumbwheel)	200
2-13	Inputting Character Strings	210
2-14	Recipes	216
2-14-1	Function Outline	216
2-14-2	Operation Outline	221
2-14-3	Limits	226
2-14-4	Common Attributes	227
2-14-5	Display Functions	235
2-14-6	Input Functions	235
2-14-7	Output Functions	235
2-14-8	Relationship with Other Elements	236
2-15	Window Function	237
2-15-1	What Are Windows?	237
2-15-2	Window Type	238
2-15-3	Window Screens and Display Elements	239
2-15-4	Opening/Closing and Moving a Window	239
2-15-5	Size and Display Position of a Window	241
2-15-6	Changing the Displaying Order of Windows	241
2-15-7	Checking the Display Status of a Window	242
2-15-8	Temporary Input Fields	242
2-15-9	Focus Window	243
2-16	Special Functions	244
2-16-1	Display History Record Function	244
2-16-2	Alarm History Record Function	246
2-16-3	Resume Function	249
2-16-4	Screen Saver Function	249
2-16-5	Buzzer Function	250
2-16-6	Clock Function	251
2-16-7	Print Function (NT31/NT31C or NT631/NT631C Only)	253
2-16-8	Adjusting Contrast and Brightness During PT Operation	255
2-16-9	Programming Console Function	257
2-17	Device Monitor Function	259
2-17-1	Compatible Systems	260
2-17-2	Device Monitor Screens and Functions	261
2-17-3	Starting and Exiting Device Monitor	261
2-17-4	Operations Common to the Device Monitor Screens	263
2-17-5	Using the Registration Monitor Screen	264
2-17-6	Using the Continuous Monitor Screen	271
2-17-7	Using the Error Log Screen	275
2-17-8	Errors Occurring during Device Monitor Operation	277

Table of contents

2-18	Mathematical Function	279
2-18-1	Executable Calculations	279
2-18-2	Data Flow in Calculations	282
2-18-3	Precautions When Using the Mathematical Function	283
2-19	PT Configuration Settings	285
2-19-1	PT Configuration Settings	285
SECTION 3 – How to Use the PT		287
3-1	Screen Creation Procedure	288
3-2	Buzzer, Backlight, and Display Control	290
3-2-1	Sounding the Buzzer	290
3-2-2	Stopping the Buzzer Sound	291
3-2-3	Controlling the Backlight	293
3-2-4	Turning off the Screen	295
3-2-5	Redisplaying the Turned-off Screen	297
3-3	Screen Display and Notification	300
3-3-1	Switching the Screen	300
3-3-2	Finding the Screen Number of the Presently Displayed Screen	306
3-4	Display and Control of Windows	309
3-4-1	Opening/Closing/Moving a Window	309
3-4-2	Checking the Display Status of a Window	314
3-4-3	Disabling/Enabling the Opening of a Window	316
3-5	Changing Numeral and Character String Display	317
3-5-1	Changing Numeric Values and Character Strings	317
3-6	Display of Graphs	328
3-6-1	Changing the Trend Graph Display	328
3-7	Input of Numeric Values and Character Strings	329
3-7-1	Inputting a Numeric Value	329
3-7-2	Inputting Character Strings	343
3-8	Using the Alarm List/History Function	348
3-8-1	How to Use the Alarm List/History	348
3-9	Using the Display History Function	353
3-9-1	How to Use the Display History	353
3-10	Display and Setting of Calendar Clock	356
3-10-1	Setting the Date and Time (NT31/NT31C and NT631/NT631C)	357
3-10-2	Displaying the Date and Time	361
3-11	Printing Data and Checking the Printer Status	364
3-11-1	Printing the Screen	365
3-12	Enabling/Disabling PT Operations	368
3-12-1	Enabling and Disabling the Operation of the PT	368
SECTION 4 – Using Memory Link		371
4-1	Operation of the Memory Link	372
4-1-1	PT Memory	372
4-1-2	Memory Link Commands	372
4-2	Outline of Communications	374
4-2-1	Communication Protocol	374
4-2-2	Notes on Using Commands	375
4-3	Commands/Responses	377
4-3-1	PT Memory Read Command (Sent from Host to PT)	377
4-3-2	Numeral Memory Table Read Command (Sent from Host to PT)	378
4-3-3	Character String Memory Table Read Command (Sent from Host to PT)	379
4-3-4	Bit Memory Table Read Command (Sent from Host to PT)	380
4-3-5	Screen Data Comment Read Command (Sent from Host to PT)	382
4-3-6	System Status Read Command (Sent from Host to PT)	382
4-3-7	PT Memory Write Command (Sent from Host to PT)	383
4-3-8	Numeral Memory Table Write Command (Sent from Host to PT)	384
4-3-9	Character String Memory Table Write Command (Sent from Host to PT)	385

Table of contents

4-3-10	Bit Memory Table Write Command (Sent from Host to PT)	386
4-3-11	PT Memory Batch Write (FILL) Command (Sent from Host to PT) .	388
4-3-12	Numeral Memory Table Clear Command (Sent from Host to PT) . . .	388
4-3-13	Character String Memory Table Clear Command (Sent from Host to PT)	389
4-3-14	Bit Memory Table Clear Command (Sent from Host to PT)	390
4-3-15	Touch Switch Input Notify Command (Sent from PT to Host)	391
4-3-16	Numerical Input Notify Command (Sent from PT to Host)	392
4-3-17	Character String Input Notify Command (Sent from PT to Host) . . .	393
4-3-18	Direct Area Changing Notify Command (Sent from PT to Host) . . .	394
4-3-19	PT Memory Changing Notify Command (Sent from PT to Host) . . .	396
4-3-20	PT Operation Mode Switching Command (Sent from Host to PT) . .	397
4-3-21	Re-send Request Command (Sent from Host to PT)	398
4-3-22	Error Response (Sent from PT to Host)	398
4-4	Memory Link Online Transfer Function	400
4-4-1	Online Transfer Processes	400
4-4-2	Required Conditions	401
4-4-3	Example Applications	401
SECTION 5 – Function Applications		403
5-1	Examples of Actual Applications of Direct Access	404
5-2	Examples of Actual Applications of Memory Link	417
SECTION 6 – Troubleshooting and Maintenance		421
6-1	Troubleshooting	422
6-2	Responding to Displayed Error Messages	427
6-2-1	Errors Occurring at Start of Operation and Their Remedies	427
6-2-2	Errors Occurring during Operation and Their Remedies	429
6-2-3	Errors Occurring on Screen Data Initialization and Transmission . . .	430
6-2-4	Errors in the System Installer Mode and Their Remedies	431
6-2-5	Communication Errors and Their Remedies	432
Appendix		435
A	– Specifications	435
B	– Compatibility with Screen Data of Other PT Models	441
C	– NT20S and NT30/620 Compatible Modes	457
D	– PC Memory Maps	465
E	– Keycode Tables	467
F	– ISO 8859/1	467
G	– MS-DOS CP437	468
Revision History		473

PRECAUTIONS

This section provides general precautions for using the Programmable Terminal.

The information contained in this section is important for the safe and reliable application of the Programmable Terminal. You must read this section and understand the information contained before attempting to set up or operate a Programmable Terminal.

1	Intended Audience	x
2	General Precautions	x
3	Safety Precautions	x

1 Intended Audience

This manual is intended for the following personnel, who must also have knowledge of electrical systems (an electrical engineer or the equivalent).

- Personnel in charge of introducing FA systems into production facilities.
- Personnel in charge of designing FA systems.
- Personnel in charge of installing and connecting FA systems.
- Personnel in charge of managing FA systems and facilities.

2 General Precautions

The user must operate the product according to the performance specifications described in the operation manuals.

Before using the product under conditions that are not described in the manual or applying the product to nuclear control systems, railroad systems, aviation systems, vehicles, combustion systems, medical equipment, amusement machines, safety equipment, and other systems, machines and equipment that may have a serious influence on lives and property if used improperly, consult your OMRON representative.

Make sure that the ratings and performance characteristics of the product are sufficient for the systems, machines, and equipment, and be sure to provide the systems, machines, and equipment with double safety mechanisms.

This manual provides information for using the Programmable Terminal. Be sure to read this manual before attempting to use the software and keep this manual close at hand for reference during operation.

 **WARNING** It is extremely important that Programmable Terminals and related devices be used for the specified purpose and under the specified conditions, especially in applications that can directly or indirectly affect human life. You must consult with your OMRON representative before applying Programmable Terminals to the above-mentioned applications.

 **WARNING** Do not use input functions such as PT touch switches for applications where danger to human life or serious damage is possible, or for emergency switch applications.

3 Safety Precautions

Read these safety precautions carefully and make sure you understand them before using the Programmable Terminal so that you can use it safely and correctly.

Safety Conventions and their Meanings

This operation manual uses the following conventions and symbols to indicate cautions, warnings, and dangers in order to ensure safe use of the NT21.

The cautions, warnings, and dangers shown here contain important information related to safety. The instructions in these cautions, warnings, and dangers must be observed.

The conventions used and their meanings are presented below.

 **WARNING** Indicates information that, if not heeded, could possibly result in loss of life or serious injury.

Caution Indicates information that, if not heeded, could result in relatively serious or minor injury, damage to the product, or faulty operation.



WARNING

Do not attempt to take the Unit apart and do not touch any internal parts while the power is being supplied. Doing either of these may result in electrical shock.



SECTION 1

General

This section provides fundamental information about the functions and features of the PTs, types of connection, communication methods, etc. This information will enable you to understand the applications of the PTs.

1-1	Role and Operation of the PT	2
1-1-1	Operation of a PT at an FA Production Site	2
1-1-2	Operations of the PT	3
1-2	Functions of the NT21, NT31/NT31C and NT631/NT631C	4
1-2-1	Features	4
1-2-2	Comparison between NT21, NT31, NT31C, NT631, and NT631C ...	6
1-2-3	Additional Functions of the V2 Versions of the NT31/NT31C and NT631/NT631C	7
1-2-4	Comparisons with Earlier Models	8
1-2-5	Principal Functions of NT21, NT31/NT31C, and NT631/NT631C ...	14
1-2-6	Displays	16
1-3	System Configuration	22
1-3-1	Peripheral Devices That Can Be Connected	22
1-3-2	Connecting to the Host	24
1-4	Communications with the Host	26
1-4-1	Direct Connection Function	26
1-4-2	Host Link	27
1-4-3	NT Link	27
1-4-4	Functions of the Allocated Bits and Words	28
1-4-5	Clock Data Area (PC to PT) (NT21 Only)	33
1-4-6	Connecting to other Companies' PCs	34
1-5	Communication by Using Memory Links	35
1-5-1	Memory Link	35
1-5-2	Comparison between Direct Connection and Memory Link	35
1-5-3	Memory Link Online Transfer Function	36
1-6	Before Operating	37

1-1 Role and Operation of the PT

The NT21, NT31, NT31C, NT631, and NT631C are sophisticated operator interfaces (Programmable Terminals) that automatically display information and can also be used for operations when necessary. The following gives a general description of the role and operation of the PT for those using a Programmable Terminal (PT) for the first time.

1-1-1 Operation of a PT at an FA Production Site

Production Line Status Monitoring

The PT displays real-time information about the system and equipment operating status, etc. Its power of expression is enhanced by graphs and other visuals, making the displays easy to understand.

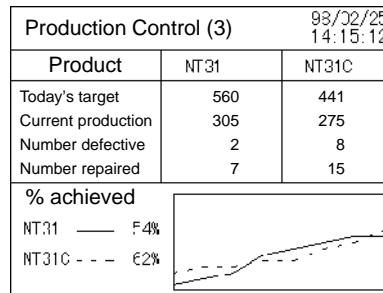

Directions to Workers on the Shop Floor

The PT warns of system or equipment failures and prompts the appropriate remedial action.

Alarm

Assembly line B
Positioning pin

is defective. Line stopped.

Check the following.

1. Defective pin L3
2. Position of dog M2
3. Mounting of photosensor P5

Panel Switch Functions

Setting touch switches on the PT allows workers to use the PT as an operating panel; the results of the operations are transmitted to the host.

Electroplating control			
Transport	Electr. head	Wash. head	Corr. prv. head
<div style="display: flex; justify-content: space-around;"> <div style="text-align: center;"> </div> <div style="border: 1px solid black; padding: 2px;">Clamp</div> </div>	<div style="border: 1px solid black; padding: 2px;">UP</div>	<div style="border: 1px solid black; padding: 2px;">UP</div>	<div style="border: 1px solid black; padding: 2px;">UP</div>
	<div style="border: 1px solid black; padding: 2px;">DOWN</div>	<div style="border: 1px solid black; padding: 2px;">DOWN</div>	<div style="border: 1px solid black; padding: 2px;">DOWN</div>
<div style="border: 1px solid black; padding: 2px;">Int. stop</div>	<div style="display: flex; justify-content: space-between;"> <div style="border: 1px solid black; padding: 2px;">Adv.</div> <div style="border: 1px solid black; padding: 2px;">Rev.</div> </div>	<div style="border: 1px solid black; padding: 2px;">Electro-lyte</div>	<div style="border: 1px solid black; padding: 2px;">Wash</div>
			<div style="border: 1px solid black; padding: 2px;">Corr. prv. fluid</div>

1-1-2 Operations of the PT

Transferring Screen Data

The screen data to be displayed on the PT can be created on a personal computer using the Support Tool. Connect the PT to the personal computer with an RS-232C cable and transfer the screen data to the PT.

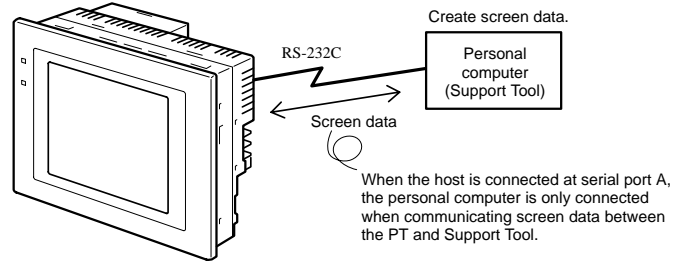

Displays Screens

The information to be displayed (screen data) can be created on a computer using the Support Tool and stored in the PT. The screen data can be displayed on the PT in response to instructions from the host or touch switch operation.

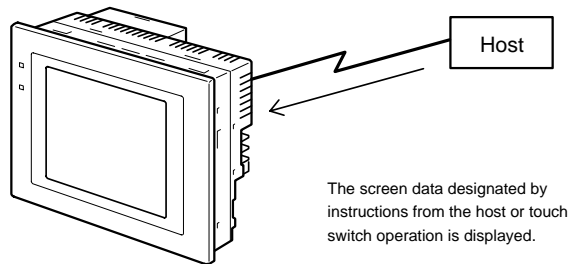

Receives Data from a Host

The PT can be connected to the host by a host link or NT Link and receive necessary data from the host.

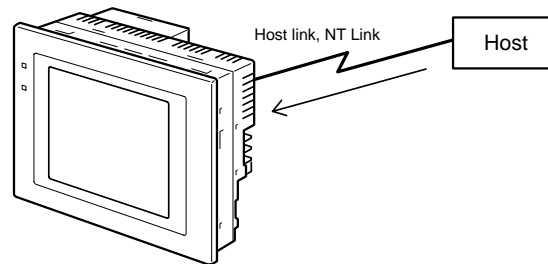

Sends Data to a Host

Data input using the touch panel (switch ON/OFF statuses, numeric values, character strings) can be transmitted to the host.

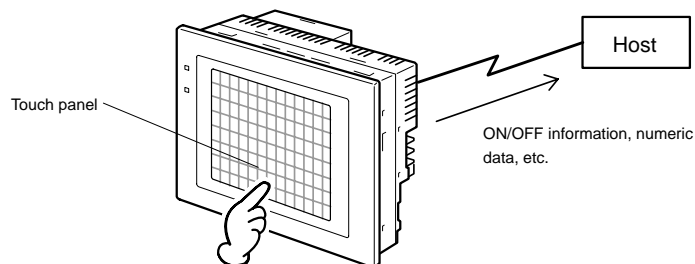

1-2 Functions of the NT21, NT31/NT31C and NT631/NT631C

The NT21, NT31/NT31C and NT631/NT631C have the following features.

1-2-1 Features

Slim Construction

- The PT is slimmer but retains the same functions. The depth is 50 mm max. when mounted in a panel with the recommended thickness (1.6 to 4.8 mm.)
- The communication cable connectors are housed in the unit so that they do not protrude from the unit.

Ideal Construction for an FA Environment

- NT21-ST121□-E: STN monochrome LCD with backlight
- NT31-ST121□-EV2: STN monochrome LCD with backlight
- NT31C-ST141□-EV2: STN color LCD with backlight
- NT631-ST211□-EV2: High-contrast EL display
- NT631C-ST141□-EV2: STN color LCD with backlight
- NT631C-ST151□-EV2: TFT color bright LCD with backlight
- The backlight unit and battery can be replaced onsite. (The backlight on the NT21 cannot be replaced.)
- Waterproofing meets NEMA4 and IP65F standards. (The panel can not be used in some IP65F environments requiring long-term exposure to oil.)

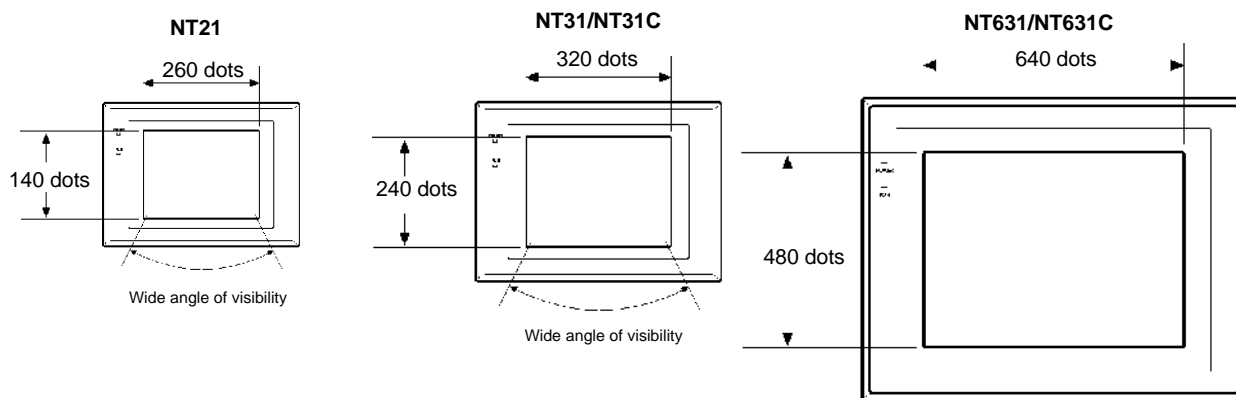

Panel Contrast and Brightness Adjustment

On the NT31, NT31C, and NT631C, the contrast and brightness are adjustable by touch switch operations. (These features are not supported on NT631 models and NT631C-ST151□-EV2.) On the NT21, the contrast is adjustable by switch operations on the back panel.

Compatibility with Other PTs

- There is upward compatibility between the following models for screen data and user programs: NT20S, NT30, NT30C, NT600S, NT21, NT31, NT31C, NT610G, NT610C, NT620S, NT620C, NT625C, NT631, NT631C. (After being read to the Support Tool, screens must be modified in accordance with the screen size. Depending on the function used, partial modification of programs may also be necessary. For details, refer to *Appendix B Compatibility with Screen Data of Other PT Models* (page 441) and the *Support Tool Operation Manual*.)
- The panel cut-out dimensions for the NT21 are the same as the dimensions for the NT20S, the panel cut-out dimensions for the NT31/NT31C are the same as the dimensions for the NT30/NT30C, and the panel cut-out dimensions for the NT631/NT631C are the same as the dimensions for the NT625C.

Two Ports Featured as Standard:

Port A for Common Use by Support Tool/Host and Port B for Exclusive Use by the Host

- Communication with the host is possible via another port while connected to the Support Tool.
- Reading bar code data from a bar code reader is possible via another port while communicating with the host.

Rapid System Program & Screen Data Changes Possible Using a Memory Unit.

- Installing a Memory Unit (NT-MF261) on the rear of the NT21, NT31/NT31C or NT631/NT631C makes it easy to write screen data into the PT onsite. This enables a rapid response to setup changes.
- The NT21, NT31/NT31C, and NT631/NT631C can store a system program into a Memory Unit. This enables the system to handle more flexible setups.

Screen Data Check Function

Screen data can be checked simply by operations in the NT21, NT31/NT31C, or NT631/NT631C system menu, without connecting up to the Support Tool.

Increased Screen Data Capacity (NT21 and NT31/NT31C)

The NT21 data capacity of 512 Kbytes is over five times that of the NT20S and the NT31/31C data capacity of 1 MB is twice that of the NT30/NT30C, enabling storage of a larger quantity of screen data.

Large Increase in Maximum Number of Registered Elements

The number of elements that can be registered on one screen has been considerably increased, making it possible to create more expressive screens. For details, refer to *Display Restrictions* (page 437).

Binary Data can be Read to/Written from the Host

It is now possible to write binary data stored in words at the host directly to the PT. This makes data conversion by a program at the host unnecessary, reducing the load on the host.

Character Display Using High Definition Fonts

Any ×4 characters are displayed with a 32-dot high-definition font.

Simple Upgrades

By using the system installer supplied with the ZJCAT1-EV4.6 Support Tool, the system program at the NT21, NT31/NT31C or NT631/NT631C can be changed easily from a personal computer.

Complies with International Standards

The PTs meet UL/CSA standards and EC Directives.

Compatible with Other Vendors' Devices (NT31/NT31C and NT631/NT631C)

Compatible with the Mitsubishi A-series (Calculator Link) and FX-series (Programming Console), Allen-Bradley SLC 500 Series, GE Fanuc 90-20 and 90-30 Series, and Siemens S7-300 and S7-400 Series, Modicon TSX Series, Sequencers. Specialized system programs can be installed that allow the NT31/NT31C or NT631/NT631C to be controlled from other companies' Sequencers. (The NT21 does not support PCs made by other companies.)

Multiple Windows

Up to 3 windows can be displayed simultaneously in the normal display. A 9-word window control area has been allocated in the host; the contents of these 9 words can be changed from the Host to open, close, and move windows.

1-2-2 Comparison between NT21, NT31, NT31C, NT631, and NT631C

NT21

The NT21 models are shown in the following table.

Item	NT21
Models	NT21-ST121-E (Beige) NT21-ST121B-E (Black)
Display	STN monochrome LCD (with white backlight)

NT31/NT31C

Two models are available: the monochrome NT31 and the 8-color NT31C. The differences between the NT31 and NT31C are shown in the following table.

Item	NT31	NT31C
Front panel color	NT31-ST121-EV2 (Beige) NT31-ST121B-EV2 (Black)	NT31C-ST141-EV2 (Beige) NT31C-ST141B-EV2 (Black)
Display	STN monochrome LCD (with white backlight)	STN color LCD (with white backlight)

NT631/NT631C

Two models are available: the NT631 has a monochrome (yellow EL) display and the NT631C has an 8-color display. The differences between the NT631 and NT631C are shown in the following table.

Item	NT631-ST211□-EV2	NT631C-ST141□-EV2	NT631C-ST151□-EV2
Front panel color	NT631-ST211-EV2 (Beige) NT631-ST211B-EV2 (Black)	NT631C-ST141-EV2 (Beige) NT631C-ST141B-EV2 (Black)	NT631C-ST151-EV2 (Beige) NT631C-ST151B-EV2 (Black)
Display	Monochrome EL display	STN color LCD (with white backlight)	Bright TFT color LCD (with white backlight)

1-2-3 Additional Functions of the V2 Versions of the NT31/NT31C and NT631/NT631C

The V2 versions of NT31/NT31C and NT631/NT631C are supplemented and enhanced by the following functions.

High-speed 1:N NT Link	The V2 versions are compatible with the high-speed 1:N NT Link as well as the earlier standard 1:N NT Link.
Additional Mathematical Functions	Operands (values referenced by equations) can be registered to allow the PT to perform calculations automatically and write the results of those calculations to numeral memory table entries or words in the host.
Device Monitor Function	The new device monitor function can be used to change the PC's operating mode or display/change values in the PC's memory areas. The PVs of several words can be listed with the device monitor.
Interlock Function	PT operations and inputs can be disabled from the PC if interlock bits have been allocated in the PC for the corresponding PT touch switches, numeric inputs, or string inputs.
Improved Lamp/Touch Switch Guide Characters	<p>The following displays can be performed with lamp or touch switch guide characters:</p> <ul style="list-style-type: none"> • Display several lines of guide characters. • Switch the display between different guide characters when OFF and ON. • Display numeral memory table contents as guide characters. • Display string memory table contents as guide characters.
NT30/NT30C, and NT620S/NT620C/NT625C Compatible	<p>The word configuration of the PT status control area and PT status notify area can be set to emulate those of the NC20S, NT30/NT30C, or NT620S/NT620C/NT625C; this mode is called NT20S or NT30/620 compatible mode.</p> <p>When the PT is operating in a compatible mode, it will be equivalent to an NT20S, NT30/NT30C, or NT620S/NT620C/NT625C in the functions listed below. The PT retains full V2 functionality in all functions other than the ones listed below. Refer to <i>Appendix C NT20S and NT30/620 Compatible Modes</i> for more details.</p> <ul style="list-style-type: none"> • Word configuration and functions of the PT status control area and PT status notify area • Image/library codes • Insertion of image/library data into character strings
Additional CS/CJ-series PC Data Areas Accessible	<p>Data areas in CS/CJ-series PCs that were previously inaccessible can be accessed. The data areas listed below can be accessed (read/written) through a 1:N NT Link with the CS/CJ-series PC. (These areas cannot be accessed through a Host Link connection.)</p> <p style="padding-left: 40px;">All banks in the EM Area, Timer Completion Flags (TU), Counter Completion Flags (CU), Work Area (WR), Task Flags (TK), and the HR Area.</p>
Recipe Function	You can set the data (numeric values) for multiple words in record units using the tabular elements on the PT screen, and write these settings in a single operation to words on the host (i.e., PC or PT memory) using a touch switch operation on the PT Unit. Also, multiple words of numeric data can be read from the host in one operation. In this way, groups of parameter settings can be edited at the PT Unit, and written to or read from the host.
Adjusting Contrast and Brightness During PT Operation	You can display the brightness and contrast adjustment screen using either the touch switch or commands from the host, even while the PT is in operation.

1-2-4 Comparisons with Earlier Models

Comparison between NT20S and NT21

Item	NT20S	NT21
NT Support Tool used	NT-ZJCAT1-EV4 or NT-ZA3AT-EV2	NT-ZJCAT1-EV4
Effective display area	112 x 56 mm (horizontal x vertical)	117 x 63 mm (horizontal x vertical)
Screen dots (resolution)	256 x 128 dots (horizontal x vertical)	260 x 140 dots (horizontal x vertical)
Number of touch switches	12 x 6 (horizontal x vertical)	13 x 7 (horizontal x vertical)
DIP switch settings	On rear of Unit	None (software settings)
Use of Memory Unit	Not possible	Possible (transferring system program data and screen data)
RS-232C interface	Connector (9-pin) also used as port for screen data transfer.	- Serial port A connector (also used for screen data transfer, 9-pin) - Serial port B connector (for host communications only, 9-pin)
Backlight life expectancy	10,000 hours min.	50,000 hours min.
Replacement Backlight	NT20S-CFL01	Replacement not possible
Battery backup	None	Possible*1 (numeral table, string table, history data, recipe data)
System program data	Installed in PT (not replaceable)	The system installer and system program data are supplied with the NT Support Tool.
1:N NT Links	Standard only	Standard or high-speed
Memory Link	Not possible*2	Possible
Number of user-registered screens	Maximum of 500	Maximum of 3,999
Screen data capacity*3 (User program memory)	96 KB	512 KB
Numeral/character string table	Maximum of 128 entries each	Maximum of 2,000 entries each
Bit memory table	None	Maximum of 1,000 bits
Mathematical table	None	256 entries max. Calculations can be executed automatically in the PT.
Image data	None	Maximum of 4,095 (224 for compatibility with NT20S)
Library data	None	Maximum of 12,288 (896 for compatibility with NT20S)
Graphic figures (rectangles, polygons, circles/ovals, sectors, filling)	None	65,535 total per screen, including other fixed objects
Image library displays	None	256 per screen max.
Analog meters	None	50 per screen max.
Trend graphs	None	1 per screen max.
Broken-line graphs	None	1 per screen max.
Alarm lists/history	None	4 per screen max.
Recipe function	None	1 per screen max.
Windows	None	3 per max.
Method for storing numeric values (numeral memory data and PT Status Control Area)	BCD (binary-coded decimal)	BCD (binary-coded decimal) or binary
PT Status Control Area size	4 words	5 words (partial change of contents) (4 words for compatibility with NT20S)
PT Status Notify Area size	3 words	2 words (partial change of contents) (3 words for compatibility with NT20S)

Item	NT20S	NT21
Window Control Area size	None	9 words
Clock Data Area size	None	4 words
Registering continuous screens	Possible	Not possible (Use screen switches as a substitute.)
System tenkey	Possible	Not possible (Use normal tenkey as a substitute.)
Lamp/Touch switch labels	Fixed display (1 line only)	<ul style="list-style-type: none"> - Multiple lines can be displayed - ON/OFF switching is possible - Numeral display is possible - Character string display is possible
Interlock function	None	Operations can be disabled from the PC by allocating interlock bits to the corresponding touch switch, numeral input, character string input, thumbwheel switches, or recipe objects.
Programming Console function	Not possible.	Possible.
Bar code reader connection	Not possible.	Possible.
High-quality font display	Not possible.	Possible.
Character codes	CP437 (DOS)	CP437 (DOS) or ISO8859/1 (Windows)
Accessible CS/CJ PC data Areas	---	<p>The data areas listed below can be accessed in addition to the data areas accessible with the NT20S.*4</p> <ul style="list-style-type: none"> - EM banks (EM_0 to EM_C) - Timer Completion Flags (TU) - Counter Completion Flags (CU) - Work Areas (WR) - Task Flags (TK) - HR Area (HR)

*1: The Battery is optional.

*2: The NT20S-ST128 supports RS-232C communications commands instead of memory links.

*3: This is the capacity of the flash memory that stores screen data.

*4: These data areas are accessible only when the PT is connected to the CS/CJ-series PC in a 1:N NT Link. (They are not accessible through host link communications.)

For differences in programming, refer to *Appendix B Compatibility with Screen Data of Other PT Models* on page 441.

Comparison between NT30/NT30C and NT31/NT31C

Item		NT30/NT30C	NT31/NT31C
Compatible Support Tool(s)		NT-ZJCAT1-EV4 or NT-ZA3AT-EV2	NT-ZJCAT1-EV4
DIP switch settings		On rear of unit	None (software settings)
Use of B7A Interface Unit		Possible	Not possible
Use of Memory Unit		Not possible	Possible
RS-232C interface		Connector (9-pin) also used as port for screen data transfer.	<ul style="list-style-type: none"> - Serial port A connector (also used for screen data transfer, 9-pin) - Serial port B connector (for host communications only, 25-pin)
RS-422A/485 interface		Terminal block	Serial port B (25-pin D-SUB connector)
Replacement backlight		NT30-CFL01/NT30C-CFL01	NT31C-CFL01 (common use)
NT31/NT31C system program data		NT-ZS3AT-EV1 (including system installer)	The system installer and system program data are supplied with the Support Tool.
High-speed 1:N NT Link		Not possible	Possible*1
Memory Link	System program	Exclusive use by Memory Link	Same as OMRON connection
	Screen data	Shared with OMRON connection	Exclusive use by Memory Link
LCD contrast adjustment		By a control on the rear of the unit	By touch panel operation
Backlight brightness adjustment		Not possible	By touch panel operation
Number of user-registered screens		2,000 max.	3,999 max.
Screen data capacity*2 (User program memory)		512 KB	1 MB
Numeral string data		1,000 max.	2,000 max.
Character string data		1,000 max.	2,000 max.
Bit data		256	1,000 max.
Mathematical table		None	256 entries max. Calculations can be executed automatically in the PT.*1
Image data		224 max.	4,095 max.*3
Library data		896 max.	12,288 max.*3
Method for storing numeric values (numeral memory data and PT status control area)		Fixed as BCD (binary coded decimal)	Selectable from BCD (binary coded decimal) or binary
PT status control area size		4 words	5 words (partial change of contents)*3
PT status notify area size		3 words	2 words (partial change of contents)*3
Window control area size		None	9 words*4
Registering continuous screen		Possible	Not possible (Use a screen switchover as a substitute.)
Lamp/Touch switch guide characters		Fixed display (1 line only)	<ul style="list-style-type: none"> - Multiple lines can be displayed*1 - ON/OFF switching is possible*1 - Numeral display is possible*1 - Character string display is possible*1
Interlock function		None	Operations can be disabled from the PC by allocating interlock bits to the corresponding touch switch, numeral input, or character string input.*1
Device monitor function		Not possible	Possible*1

Item	NT30/NT30C	NT31/NT31C
Recipe function	None	Possible*1
Accessible CS/CJ-series PC data areas	---	The data areas listed below can be accessed in addition to the data areas accessible with the NT30/NT30C.*5 - EM banks (EM_0 to EM_C) - Timer completion flags (TU) - Counter completion flags (CU) - Work Area (WR) - Task flags (TK) - HR Area

*1: These functions are available only in V2 versions of the NT31/NT31C.

*2: This is the capacity of the flash memory that stores screen data.

*3: The values are the same as the NT30/NT30C when the PT is in NT30/620 compatible mode.

*4: The window control area can be used only in version V1 or later of the NT31/NT31C.

*5: These data areas are accessible only when the PT is connected to the CS/CJ-series PC in a 1:N NT Link. (They are not accessible through host link communications.)

For differences in programming, refer to *Appendix B Compatibility with Screen Data of Other PT Models* on page 441.

Differences between the NT620S/NT620C/NT625C and NT631/NT631C

Item		NT620S/NT620C/NT625C	NT631/NT631C
Compatible Support Tool(s)		NT-ZJCAT1-EV4 or NT-ZA3AT-EV2	NT-ZJCAT1-EV4
DIP switch settings		On rear of unit	None (software settings)
Use of Memory Unit		Not possible	Possible
RS-232C interface		Connector (9-pin) also used as port for screen data transfer.	- Serial port A connector (also used for screen data transfer, 9-pin) - Serial port B connector (for host communications only, 25-pin)
RS-422A/485 interface		NT620S/NT620C: None NT625C: Terminal block (Select RS-232C or RS-422A/485 with the DIP switch.)	Terminal block (A memory switch can set the RS-232C connector as serial port B.)
Replacement backlight		NT620C-CFL01 (NT620C) NT610C-CFL02 (NT625C)	NT631C-CFL01 (for ST151) NT631C-CFL02 (for ST141)
NT631/NT631C system program data		NT620-ZS3PC/ZS3DV-EV1 (including system installer)	The system installer and system program data are supplied with the Support Tool.
High-speed 1:N NT Link		Not possible	Possible* ¹
Memory Link	System program	Exclusive use by Memory Link	Same as OMRON connection
	Screen data	Shared with OMRON connection	Exclusive use by Memory Link
LCD contrast adjustment		By a control on the rear of the unit	Adjustable with touch panel operation. (NT631-ST141□-V2 only)
Backlight brightness adjustment		Not possible	Adjustable with touch panel operation. (NT631-ST141□-V2 only)
Number of user-registered screens		2,000 max.	3,999 max.
Screen data capacity* ² (User program memory)		NT620S: 512 KB NT620C/NT625C: 1 MB	1 MB
Numeral string data		1,000 max.	2,000 max.
Character string data		1,000 max.	2,000 max.
Bit data		256	1,000 max.
Mathematical table		None	256 entries max. Calculations can be executed automatically in the PT.* ¹
Image data		224 max.	4,095 max.* ³
Library data		896 max.	12,288 max.* ³
Method for storing numeric values (numeral memory data and PT status control area)		Fixed as BCD (binary coded decimal)	Selectable from BCD (binary coded decimal) or binary
PT status control area size		4 words	5 words (partial change of contents)* ³
PT status notify area size		3 words	2 words (partial change of contents)* ³
Window control area size		None	9 words* ⁴
Registering continuous screen		Possible	Not possible (Use a screen switchover as a substitute.)
Lamp/Touch switch guide characters		Fixed display (1 line only)	- Multiple lines can be displayed* ¹ - ON/OFF switching is possible* ¹ - Numeral display is possible* ¹ - Character string display is possible* ¹
Interlock function		None	Operations can be disabled from the PC by allocating interlock bits to the corresponding touch switch, numeral input, or character string input.* ¹
Device monitor function		Not possible	Possible* ¹

Item	NT620S/NT620C/NT625C	NT631/NT631C
Recipe function	None	Possible*1
Accessible CS/CJ-series PC data areas	---	The data areas listed below can be accessed in addition to the data areas accessible with the NT30/NT30C.*5 - EM banks (EM_0 to EM_C) - Timer completion flags (TU) - Counter completion flags (CU) - Work Area (WR) - Task flags (TK) - HR Area

*1: These functions are available only in V2 versions of the NT631/NT631C.

*2: This is the capacity of the flash memory that stores screen data.

*3: The values are the same as the NT620S/620C/NT625C when the PT is in NT30/620 compatible mode.

*4: The window control area can be used only in version V1 or later of the NT631/NT631C.

*5: These data areas are accessible only when the PT is connected to the CS/CJ-series PC in a 1:N NT Link. (They are not accessible through host link communications.)

For differences in programming, refer to *Appendix B Compatibility with Screen Data of Other PT Models* on page 441.

1-2-5 Principal Functions of NT21, NT31/NT31C, and NT631/NT631C

The following are the principal functions of the NT21, NT31/NT31C, and NT631/NT631C.

Functions relating to data display

Character display

Characters of various sizes can be displayed. Characters can be flashed and displayed in reverse video. High grade fonts are available for the characters with their size enlarged.

Graphic display

Polylines, rectangles, polygons, circles, circular arcs, and sector shapes can be displayed. They can also be tiled with various patterns, flashed, or displayed in reverse video.

Memory data display

The contents of character string memory table entries and numeral memory table entries can be displayed. The contents of memory table entries can be changed from the host.

Graph display

Not only bar graphs but also broken line graphs, trend graphs, and analogue meter graphs can be displayed using numeral memory table entries.

Lamp display

Lamps can be turned on and flashed under the control of the host. It is also possible to display different graphics in the ON and OFF states.

Alarm list/history display

Warning messages are automatically displayed in a list in response to the state of a host bit. The time and the number of times of the messages appeared can also be displayed.

NT21

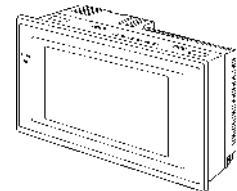

NT31/NT31C

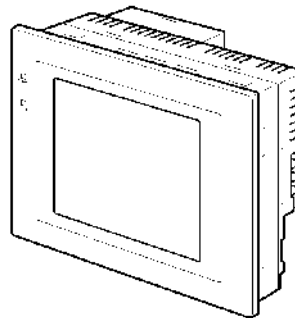

NT631/NT631C

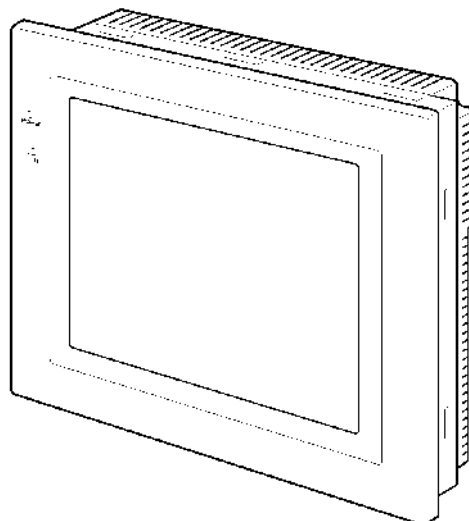

Functions relating to data output

Buzzer

A built-in buzzer can be sounded.

Screen printing (NT31/NT31C and NT631/NT631C)

A hard copy of the currently displayed screen can be printed at the printer connected to the PT.

Functions relating to data input

Input by touch switches

Data can be input by simply touching touch switches displayed on the screen. The possible functions of touch switches include sending data to the host and changing the screen display. Inputs can be enabled and disabled from the host when interlock bits have been allocated.

Pop-up window function

A window overlaying the currently displayed screen can be alternately opened and closed by pressing a touch switch. In addition to fixed character and graphic displays, control keys and character keys created as touch switches can also be set inside the window. A maximum of three windows can be displayed simultaneously. Since the window need only be opened when input is required, the screen can be used efficiently.

Numeral/character string setting function

Numeric keys and character keys can be assigned to touch switches so that numeric values and character strings can be input at the operation site.

The input data is written to numeral/character string memory table entries and also sent to the host. It is also possible to disable input by control from the host.

Recipe function

Several words of numeric data can be edited at the PT Unit, and written to or read from the host in one operation.

Input from a bar code reader

Data read with a bar code reader can be input to a character string input field.

Functions relating to communications

Communications with the host

The PT can communicate with the host by four methods: host link, 1:1 NT Link, 1:N NT Link (standard and high-speed) and Memory link. Data can be read from the host, and data input by means of touch switches and numeral/character string settings can be sent to the host. It is also possible to connect the NT31/NT31C and NT631/NT631C with PCs from other companies.

Functions relating to the system

System menu

System settings and maintenance can be performed by selecting from system menus displayed on the screen.

Creation of screen data

Screen data created using the Support Tool at a personal computer can be transferred and stored in the built-in screen data memory.

Resume function

The status and memory table contents of the NT21, NT31/NT31C, and NT631/NT631C immediately before its operation is stopped can be stored while operation is stopped, or while the power is off, and then displayed on the screen again when operation is restarted. (Optional Battery required for NT21.)

Screen saver function

This function serves to extend the service life of the backlight and prevent the formation of an afterimage on the screen.

Clock function

The time can be displayed in accordance with the internal clock data.

Programming Console function

The PT can perform the same operations as a C200H-PR027-E Programming Console when the PT is connected to a CPM1, CPM2A, CPM2C, CQM1, CQM1H, C200HX/HG/HE(-Z)E, or SRM1 PC in a 1:1 NT Link connection, or a CS1, CS1-H, CJ1, or CJ1-H PC in a 1:N NT Link connection.

Device Monitor function (NT31/NT31C and NT631/NT631C)

When the PT is connected to a PC in a 1:1 NT Link or 1:N NT Link, the PT can be used for operations such as changing the PC's operating mode, displaying or changing the PVs of words, or reading the error log.

System program install function

The system program of the NT21, NT31/NT31C, or NT631/NT631C can be changed by using the system installer supplied with the Support Tool (NT-ZJCAT1-EV4). It can also be installed by using a Memory Unit (NT-MF261).

Screen display history function/alarm history function

The screen display history function records the time at which specific screens are displayed and the number of times they are displayed. The alarm history function records the time at which specific bits at the host are turned ON and the number of times they are turned ON.

Trend graph logging function and background function

Changes in the contents of numeral memory table entries displayed in trend graphs can be recorded (logging function). Also, the record can be maintained even when the trend graph is not displayed (background function).

Mathematical function

This function allows calculations to be executed regularly during PT operation when mathematical table entries have been set in screen data. Arithmetic operations, bit operations, logic operations, and comparison operations can be performed. Operations with up to 5 terms are possible.

1-2-6 Displays

The NT21, NT31/NT31C, and NT631/NT631C can display various kinds of elements such as characters, numeric values, graphs, lamps, and touch switches, on a screen. The screen data displayed by the NT21, NT31/NT31C, and NT631/NT631C are created by using the Support Tool at a personal computer.

Example NT31/NT31C Display

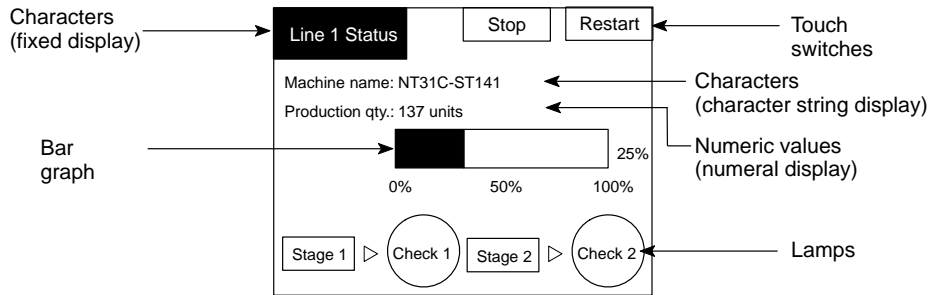

Fixed Displays

Characters and various graphics (circles, circular arcs, sectors, polylines, polygons and rectangles) whose display does not have to be changed, and mark data, image data, and library data that has already been registered, can be written directly onto the screen.

Circle

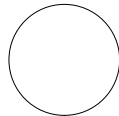

Arc

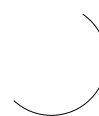

Sector

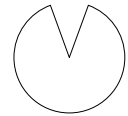

Polyline

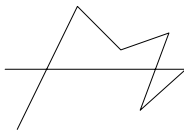

Polygon

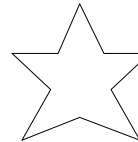

Rectangle



* A continuous straight line with up to 256 points can be drawn.

* A polygon with up to 255 vertices can be drawn.

Marks are graphics comprising 16 by 16 dots that can be used as characters. They can be used as custom characters within character strings.

Image data contain graphics comprising any required area of dots. They are registered in advance and as many as required can be displayed at any position on the screen.

Windows bit map (BMP) data can be used for images.

There is a two-color mode, in which the display color and background color of the image are specified when it is registered in a screen, and an eight-color mode in which colors are assigned to the image in advance.

Since image data is composed of dots, it requires a large data size but offers great powers of expression.

Library data contain combinations of fixed display graphics registered as a single graphic. They are registered in advance and as many as required can be displayed at any position on the screen.

Since it is generated by combining graphics, library data has a small data size.



Lamps

These are graphics whose display status changes in accordance with the states of bits at the host. Squares, circles, sectors and polygons can be used for lamps (normal (standard) lamps). In accordance with the status of the host bit, they can be lit (displayed in reverse video) or flashed (repeated alternation between normal and reverse video display states).

Lamps can also display different image/library data for the ON and OFF states of the host bit (such lamps are called image/library lamps).

There are four standard lamp guide characters: fixed display character strings, ON/OFF switching character strings, numeral displays, and character string displays. When fixed display character strings or ON/OFF switching character strings are used, several lines of guide characters can be displayed.

Normal (Standard) Lamps

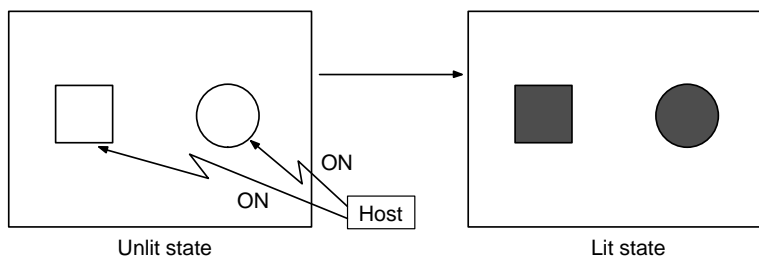

Image/Library Lamps

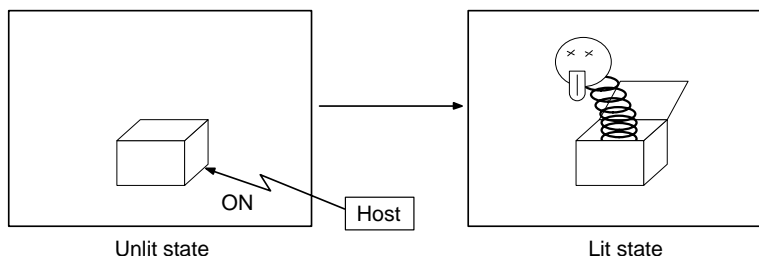

Touch Switches

These switches can be set at any location on the screen. Pressing a touch switch on the screen where a touch switch has been set can have the following effects:

- Notification to a host bit (input notification function)
- Changing the displayed screen (screen switching function)
- Input of a numeric value or character string (input key function)
- Copying of a numeric value or character string (copy key function)
- Shifting to another numeric value or character string input field (cursor moving key function)
- Obtaining a hard copy of the screen (screen print function)
- Opening / Closing a window
- Moving a window

Touch switches can be made to light or flash in accordance with the status of a host bit in the same way as lamps.

The following 8 types of display graphic can be used for touch switches: Standard, shadow, 3-dimension, no display frame, rectangle, circle, polygon, sector

When rectangle, circle, polygon, or sector is selected as the shape, the area within which pressing of the touch switch is sensed (the touch switch area) can be set independently of the position where the display graphic is set.

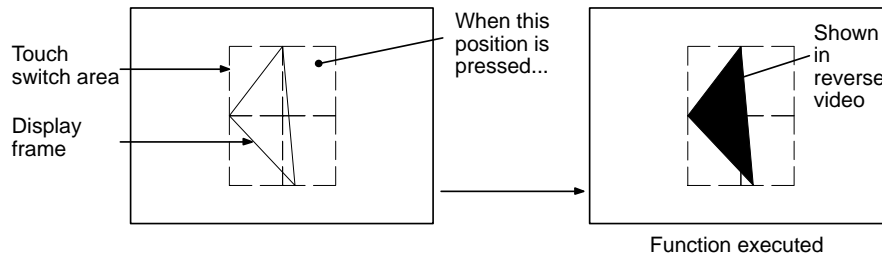

There are four standard touch-switch guide characters: fixed display character strings, ON/OFF switching character strings, numeral displays, and character string displays. When fixed display character strings or ON/OFF switching character strings are used, several lines of guide characters can be displayed.

Numeral Displays

Numeric values stored in the numeral memory table entries are displayed. The displayed numerals can be changed by changing the data stored in the numeral memory table entries.

Hexadecimal values can also be displayed.

When decimal values are displayed, the number of digits for the integral part and fractional part of displayed values can be specified in advance.

String Displays

Character strings stored in the character string memory table entries are displayed. The displayed character strings can be changed by changing the data stored in the character string memory table entries.

Numeral Inputs

Numeric values can be input at the PT by using touch switches. The input numeric values can also be stored in a numeral memory table and notified to the host.

Numeral inputs can be enabled and disabled from the host when an interlock bit has been allocated.

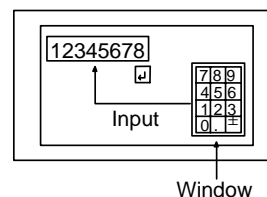

String Inputs

Character strings can be input at the PT by using touch switches, bar code readers, etc. The input character strings can also be stored in a character string memory table entry and notified to the host.

String inputs can be enabled and disabled from the host when an interlock bit has been allocated.

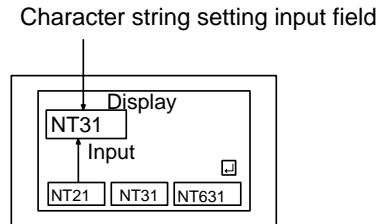

Thumbwheel Switches

Numeric values can be input by incrementing or decrementing each digit with the corresponding touch switch (+, -). The input numeric values can also be stored in a numeral memory table entry and notified to the host.

Thumbwheel switch inputs can be enabled and disabled from the host when an interlock bit has been allocated.

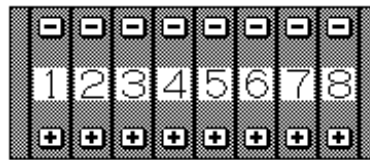

Graphs

These are graphics whose display changes in accordance with the numeric values stored in numeral memory table entries. There are the following four types.

Bar Graphs

Bar graphs display the present value in a numeral memory table entry converted to a percentage within the range -100% to +100% of a preset value.



Analog Meters

Analogue meters display, using a quarter, half, or full circle shape, the present value in a numeral memory table entry converted to a percentage within the range -100% to +100% of the preset value. Users can choose from moving pointer type and filling area type displays. Users can also add graduation to the graph.



Broken Line Graphs

Broken line graphs display, in an easy-to-read form, a sequence of numeral

memory table values converted to a percentage within the range -100% to +100% of a preset value.

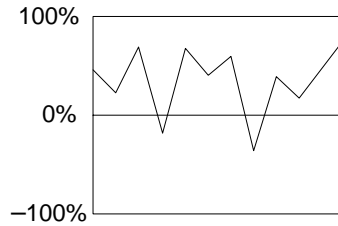

Example showing a series of 11 numeral memory table values (with a check mark set for the display sign)

Trend Graphs

Trend graphs display chronological changes in the value in a numeral memory table entry, converting the value to a percentage within the range -100% to +100% of a preset value. The trend graph shifts position with the passage of time.

Past data can also be recorded, and the numeral memory table entry can be read (sampled) even while the trend graph is not being displayed.

The user can choose to stop sampling, restart sampling, or display past data, by pressing touch switches.

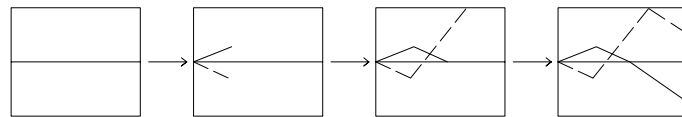

Alarm List/History

The alarm list/history function displays messages in list form, or graphics (image/library data), in accordance with changes in bit memory table statuses.

For the alarm list, a series of bit memory table entries are monitored, and messages (contained in the character string memory table) set for bit memory table entries that come ON are displayed.

For the alarm history, bit memory table entries for which the history property is set are continually monitored, and the time when they come ON and number of times they come ON are recorded and displayed together with the message (character string) set for the bit memory table entry.

The NT21, NT31/NT31C, and NT631/NT631C allow selection of the display order for the newest record first or oldest record first by memory switch setting.

The alarm list function is used to determine which bits are ON at the present time. The alarm history function is used to determine the times at which alarms occurred in the past and how many times alarms have occurred. (Optional Battery required for NT21.)

- Alarm list

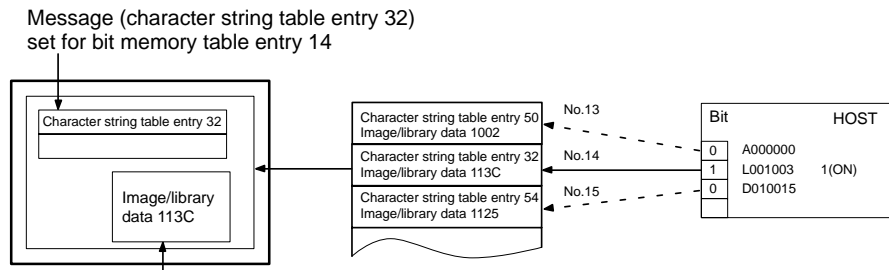

When the message displayed is pressed, the image/library data (113C) set for bit memory table entry 14 is displayed.

• Alarm history

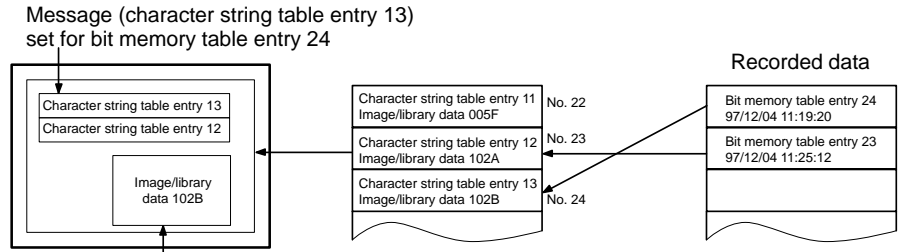

When the upper message displayed is pressed, the image/library data (102B) set for bit memory table entry 13 is displayed.

Recipe

You can set several words of numeric data at the PT in tabular format, and write it to the host. You can also read several words of numeric data from the host and display it on the PT screen.

1-3 System Configuration

This section shows the configuration of a system that uses an NT21, NT31/NT31C and NT631/NT631C. For details on product models, refer to the *Setup Manual*.

1-3-1 Peripheral Devices That Can Be Connected

NT21

The following peripheral devices can be connected to an NT21.

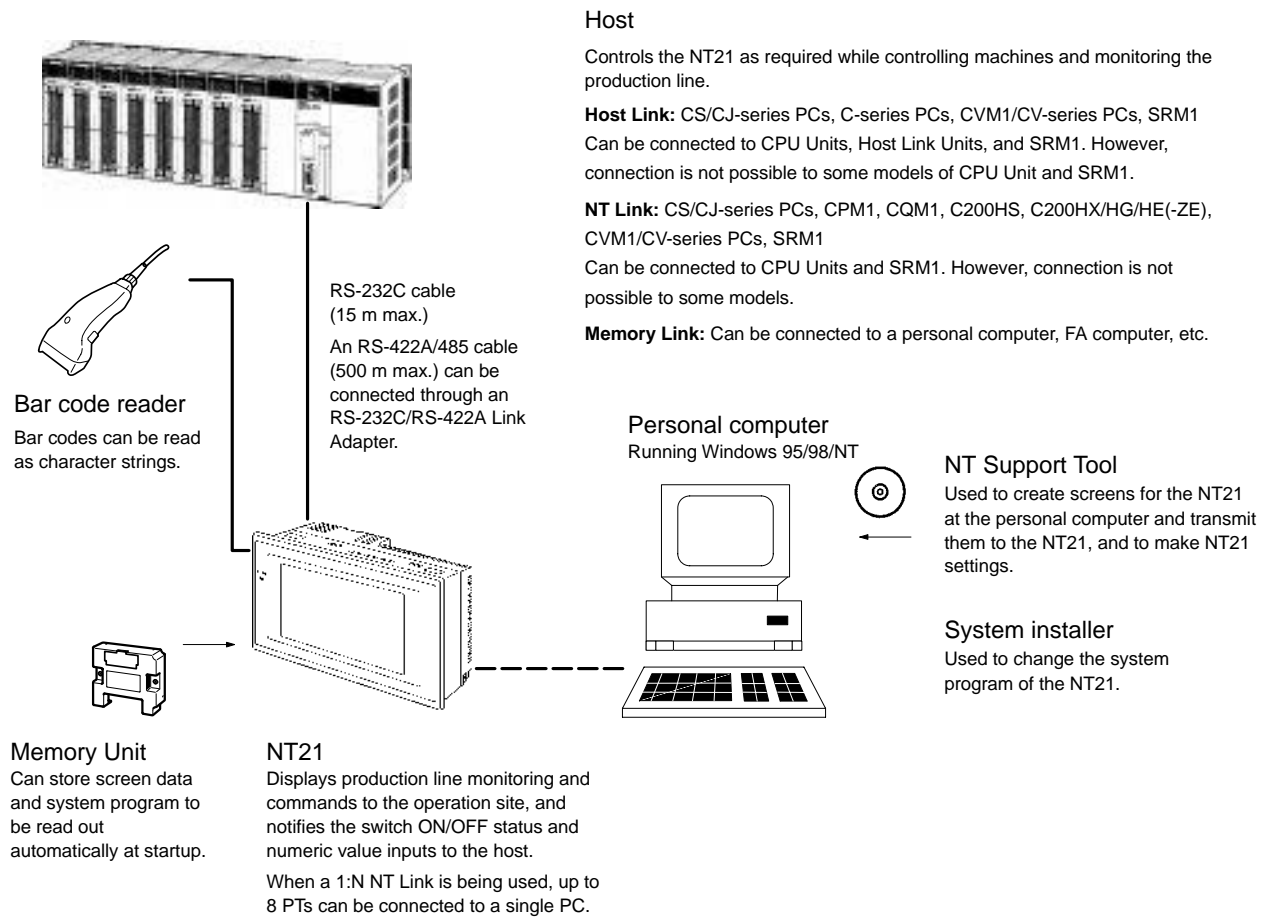

- Bar Code Reader
V520-RH21-6 (made by OMRON)
- Memory Unit
NT-MF261 (made by OMRON)
- NT Support Tool
NT-series Support Tool Version 4.6 for Windows (Made by OMRON)
 - NT-ZJCAT1-EV4 (CD-ROM version for IBM PC/AT and compatible computers)
- System Installer
System Installer (made by OMRON)
The System Installer is supplied as a standard accessory with the NT Support Tool (NT-ZJCAT1-EV4).

Reference: The following optional devices are available.

Reflection-suppressing Protective Sheets (5)	NT20S-KBA04
Chemical-resistant cover	NT20S-KBA01
Battery	C500-BAT08

NT31/NT31C and NT631/NT631C

The following peripheral devices can be connected to the NT31/NT31C and NT631/NT631C.

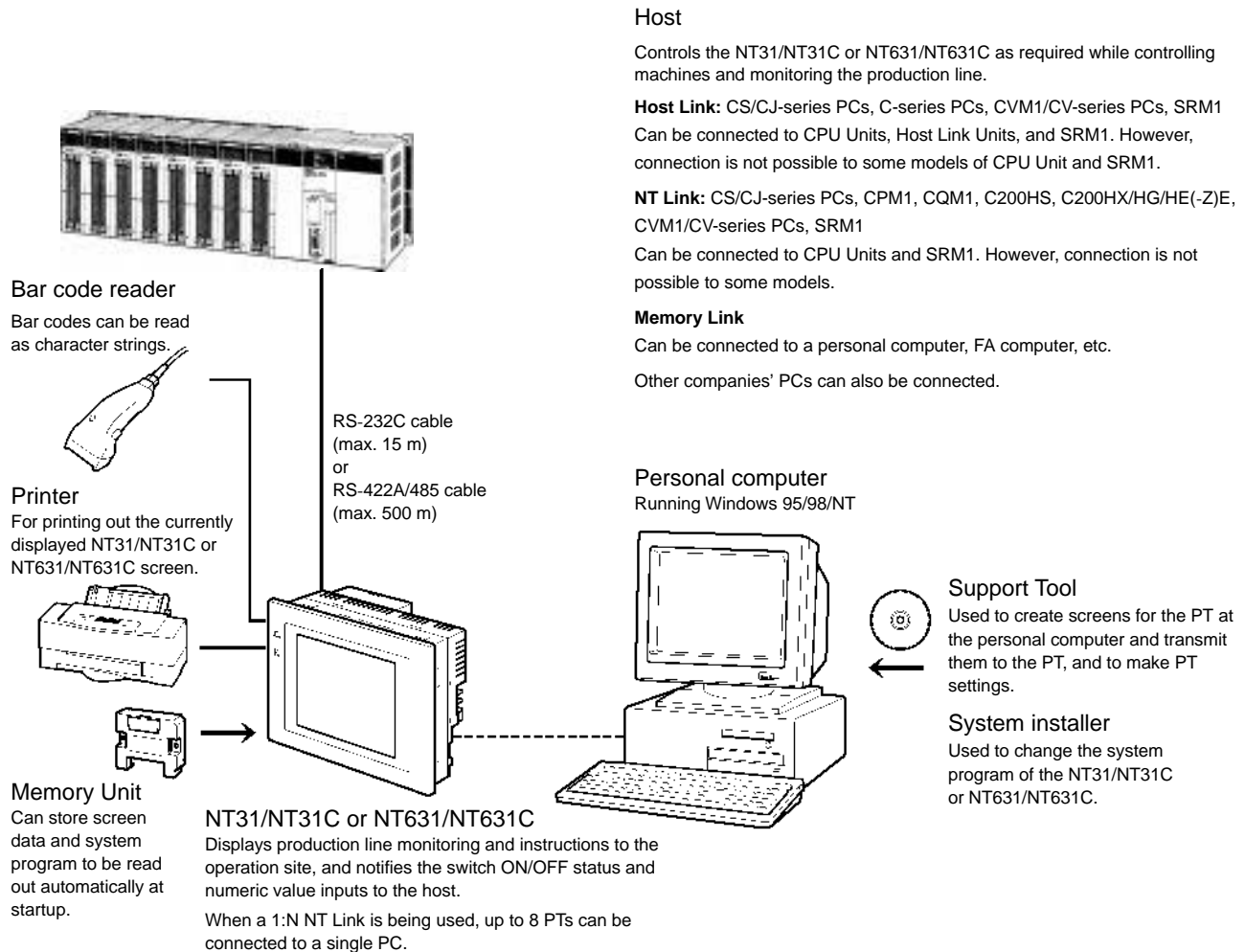

- Bar code reader
V520-RH21-6 (made by OMRON)
- Recommended printers
It is also possible to use printers that can emulate an NEC PC-PR201H (using the NEC PC-PR201PL control protocol), and printers that comply with one of the following EPSON control standards: ESC/P 24-J83C (color), or ESC/P 24-J82 (monochrome).
If using an HP printer, make sure that it conforms to the PCL5 standard.
- Memory Unit
NT-MF261 (made by OMRON)
- Support Tool
NT-series Support Tool Version 4 for Windows (made by OMRON)
 - NT-ZJCAT1-EV4 (CD-ROM version for IBM PC/AT and compatible computers)

- System installer
System installer (made by OMRON)
The system installer is supplied as a standard accessory with the Support Tool (NT-ZJCAT1-EV4).

Reference:	<ul style="list-style-type: none"> • The following optional devices are available. All of them can be used either with NT31 or NT31C. <table border="0"> <tr> <td>Replacement Backlight</td> <td>NT31C-CFL01</td> </tr> <tr> <td>Anti-reflective Film (5 sheets)</td> <td>NT30-KBA04</td> </tr> <tr> <td>Chemical-resistant Cover</td> <td>NT30-KBA01</td> </tr> <tr> <td>Replacement Battery</td> <td>C500-BAT08</td> </tr> </table> • The following optional devices are available. All of them can be used either with NT631 or NT631C except for the replacement backlights. <table border="0"> <tr> <td>Replacement Backlight</td> <td>NT631C-CFL01 (for the NT631C-ST151□) NT631C-CFL02 (for the NT631C-ST141□)</td> </tr> <tr> <td>Anti-reflective Film (5 sheets)</td> <td>NT610C-KBA04</td> </tr> <tr> <td>Chemical-resistant Cover</td> <td>NT625-KBA01</td> </tr> <tr> <td>Replacement Battery</td> <td>C500-BAT08</td> </tr> </table> 	Replacement Backlight	NT31C-CFL01	Anti-reflective Film (5 sheets)	NT30-KBA04	Chemical-resistant Cover	NT30-KBA01	Replacement Battery	C500-BAT08	Replacement Backlight	NT631C-CFL01 (for the NT631C-ST151□) NT631C-CFL02 (for the NT631C-ST141□)	Anti-reflective Film (5 sheets)	NT610C-KBA04	Chemical-resistant Cover	NT625-KBA01	Replacement Battery	C500-BAT08
Replacement Backlight	NT31C-CFL01																
Anti-reflective Film (5 sheets)	NT30-KBA04																
Chemical-resistant Cover	NT30-KBA01																
Replacement Battery	C500-BAT08																
Replacement Backlight	NT631C-CFL01 (for the NT631C-ST151□) NT631C-CFL02 (for the NT631C-ST141□)																
Anti-reflective Film (5 sheets)	NT610C-KBA04																
Chemical-resistant Cover	NT625-KBA01																
Replacement Battery	C500-BAT08																

1-3-2 Connecting to the Host

NT21

The NT21 has the following two communication ports.

- Serial port A:
D-Sub 9-pin connector (female)
RS-232C only (The NT Support Tool and bar code readers can be connected here, as can an NT-AL001 RS-232C/RS-422A Link Adapter.)
- Serial port B:
D-Sub 9-pin connector (female)
RS-232C (The NT Support Tool and bar code readers cannot be connected here, as can an NT-AL001 or NS-AL002 RS-232C/RS-422A Link Adapter.)

The host can be connected at either of these two ports.

Refer to the *Setup Manual* for information on types of communications for the PT and host.

NT31/NT31C

The NT31/NT31C has the following two communication ports.

- Serial port A:
D-SUB 9-pin connector (female)
For RS-232C use only (The Support Tool and bar code readers can be connected here.)
- Serial port B:
D-SUB 25-pin connector (female)
For RS-232C or RS-422A/485 (Selectable by memory switch)
(The Support Tool and bar code readers cannot be connected here.)

The host can be connected at either of these two ports.

The connection methods for each communication method at the PT and host sides are indicated below. Make the settings in accordance with the communication method that can be used with the PC to be connected and the conditions at the operation site.

Reference: When using an RS-232C/422A Adaptor (NT-AL001) with the host link or 1:1 NT Link communication method, RS-485 cannot be used. The connection must be made with RS-232C or RS-422A.

NT631/NT631C

The NT631/NT631C has the following two communication ports. (Serial port B has an RS-422A/485 terminal block as well as an RS-232C connector; use the memory switch to select the serial communications method.)

- Serial port A:
D-SUB 9-pin connector (female)
For RS-232C use only (The Support Tool and bar code readers can be connected here.)
- Serial port B: Use the memory switch to select RS-232C or RS-422A/485.

Communications	Connection	Notes
RS-232C	D-SUB 9-pin connector (female)	Cannot be used for Support Tool or bar code reader.
RS-422A/485	Terminal block	---

The host can be connected at either of these two ports.

The connection methods for each communication method at the PT and host sides are indicated below. Make the settings in accordance with the communication method that can be used with the PC to be connected and the conditions at the operation site.

Reference: When using an RS-232C/422A Adaptor (NT-AL001) with the host link or 1:1 NT Link communication method, RS-485 cannot be used. The connection must be made with RS-232C or RS-422A.

1-4 Communications with the Host

The NT21, NT31/NT31C, or NT631/NT631C is connected to the host by one of the following four communication methods.

The following communications can be used to connect an OMRON PC:

- Host link
- 1:1 NT Link
- 1:N NT Link (standard or high-speed)

The following communications can be used to connect another company's PC:

- Communications protocol supported by the other company's PC (NT31/NT31C or NT631/NT631C only)

The following communications can be used to connect RS-232C/RS-422 devices, such as factory computers:

- Memory links

In all of these communication methods that can be used with NT21, NT31/NT31C, or NT631/NT631C, data communication with host is by direct connection (Memory link is, however, a quasi-direct connection).

In the following, the host link and NT Link that carry out the direct connection will be discussed. Memory link will be explained in section 1-5 *Communication by Memory Link*.

1-4-1 Direct Connection Function

With the NT21, NT31/NT31C, or NT631/NT631C, the bits and words used to access data required for display, and those for storing input data, can be allocated in any part of the PC memory area.

The NT21, NT31/NT31C, or NT631/NT631C can directly write to and read from such allocated bits and words to change the display status of the elements on the PT screen, control the PT operating status, and notify statuses to the host.

This function, which directly reads and writes the statuses of words and bits without using a PC program, is called the direct connection function.

The words and bits allocated for direct connection are called the allocated words and allocated bits.

The direct connection function allows the data to be displayed at the PT to be read from the memory area in the PC and written to memory table entries in the PT. Also, the data input at the PT can be written to the memory area in the PC. The PT screen can be changed in accordance with statuses in the PC memory area, and the PT's status data can be written to the PC's memory area.

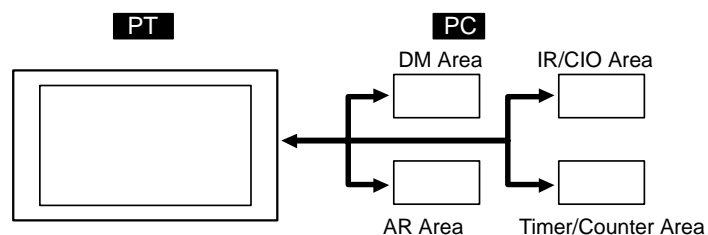

Features of the Direct Connection Function

The direct connection function has the following features.

- The bits and words used to access operating status and work instruction information and those for storing input data can be freely allocated in almost any area of the PC memory.
- Since the PT can directly access PC bit and word data without using the program at the PC, it can be connected to the PC without changing the PC program that controls the currently running production line.

- The area to control and notify the PT statuses, including display screens, display/no display status, and buzzer output, can be freely allocated in any part of the PC data area. This means that the PC status can be read and controlled just by reading this area at the PC side, without preparing a special communication program.

The direct connection function allows the PT to directly read and write almost all bits and words in the PC and to automatically change the PT screen display. This function can reduce the load on the PC so that its program development efficiency is improved.

1-4-2 Host Link

The host is connected to a PT in a 1:1 connection, and the words and bits of the host are read and displayed by host link communication. This method can be used for connection to the majority of PC models.

1-4-3 NT Link

NT Link is a method for high-speed communication with a PC using the direct connection function. The PCs that can be connected with the NT Link are as follows:

CPM1, CPM2A, CPM2C, CQM1, CQM1H, C200HS, C200HX/HG/HE(-Z)E, CS1 (V1), CS1-H, CJ1, CJ1-H, CVM1/CV-series PC (-EV1 or later version), SRM1

Besides the 1:1 NT Link method, in which one PC is connected to one PT, the NT21, NT31/NT31C, and NT631/NT631C can also use the 1:N connection NT Link method, which allows a maximum of eight PTs to be connected to one PC port.

PCs that can be connected with the 1:N connection NT Link method are as follows: CQM1H, C200HX/HG/HE(-Z)E, CS1 (V1), CS1-H, CJ1, and CJ1-H.

The NT21, NT31/NT31C, and NT631/NT631C also support OMRON's high-speed 1:N NT Link that provides faster 1:N communications. The only PCs that support the high-speed 1:N NT Link are the -EV1 and higher versions of the CS1, the CS1-H, the CJ1, and the CJ1-H.

In the following sections, the term NT Link is used to refer to the NT Link communication method in general, the term 1:1 NT Link is used to refer specifically to NT Links with a 1:1 connection, and the term 1:N NT Link is used to refer to both standard and high-speed NT Links with 1:N connections. When necessary, the standard 1:N NT Link is distinguished from the high-speed 1:N NT Link.

Features of the NT Link

The NT Link has the following features.

- High-speed communications with specific models of PCs can be executed. The NT21, NT31/NT31C, and NT631/NT631C also support OMRON's high-speed 1:N NT Link.
- Writing in units of bits to the PC memory area is possible.
 - This enables the other bits of words allocated for a touch switch to be allocated for other purposes (e.g. a lamp).
 - However, since data is written to the DM Area in word units, the other bits of words allocated for touch switches in the DM Area cannot be used for other purposes.
- The NT Link can be used even when the PC is in the RUN mode. (When the host link method is used, the PT switches to the monitor mode when the PC is in the RUN mode.)
- In the case of PTs that support the standard 1:N NT Link (NT20S, NT21, NT30, NT30C, NT1, NT31, NT31C, NT600S, NT620S, NT620C, NT625C, NT631, NT631C) up to 8 PTs can be connected to one port of the PC and used at the

same time. Up to 8 PTs (NT21, NT31, NT31C, NT631, and NT631C) can also be connected simultaneously when the high-speed 1:N NT Link is being used. All of the PTs connected to a PC port must use either the standard or high-speed 1:N NT Link; the two communications systems cannot share a single port.

- When using a C200HX/HG/HE(-Z)E PC and standard 1:N NT Links, up to three 1:N NT Link systems (i.e., 24 PTs) can be connected by installing a communication board in the option slot of the CPU. For details on the communication board, refer to the *SYSMAC Serial Communications Board Operation Manual* (W304-E1-□).
- When using a CQM1H PC and standard 1:N NT Links, multiple 1:N NT Link systems can be connected by installing Serial Communications Boards in the Inner Board slots. For details on the Serial Communications Board, refer to the *CQM1H Serial Communications Board Operation Manual* (W365-E1-□).
- When using a CS1, CS1-H, CJ1, or CJ1-H PC, multiple 1:N NT Link systems (standard or high-speed) can be connected by installing a Serial Communications Board in the Inner Board slot or installing a Serial Communications Unit on the Backplane. For details on the Communications Board/Communications Unit, refer to the *CS/CJ Series Serial Communication Board/Unit Operation Manual* (W336-E1-□).
- If the PC being used supports the Programming Console function, the NT21, NT31/NT31C or NT631/NT631C can be used as a Programming Console.
- If the PC being used supports the Device Monitor function, the NT31/NT31C or NT631/NT631C can be used to change the PC's operating mode and read/change data in the PC's memory areas. (The NT21 does not support the device monitor function.)

The NT Link is compatible with the host link. The PT screen data and PC programs used with the host link direct connection method can be used with the NT Link method as they are.

1-4-4 Functions of the Allocated Bits and Words

Words and bits in the PC can be allocated to elements displayed on the PT and PT status when using the direct connection function. By changing the contents of the bits and words, the PT can be controlled from the PC. It is also possible to send data to the PC by pressing touch switches at the PT.

Controlling the PT from the PC

The following PT functions can be controlled from the PC.

- Screens:
 - Display of designated screens, confirmation of screen numbers, etc.
- Memory table:
 - Writing to a memory table entry, copying from a memory table entry to another memory table entry, etc.
- Lamps:
 - Display instructions, confirmation of display status, etc.
- Touch switches:
 - Display instructions, confirmation of display status, enable/disable operations, etc.
- Numeric inputs, character string inputs, thumbwheel switch inputs:
 - Enable/disable inputs, etc.
- System control:
 - Buzzer ON/OFF, display/no display status, screen printing, window open/close status, and other PT status

Notification from the PT to the PC

Data in the PT is sent to a PC when, for example, a touch switch is pressed. The following 5 types of data are sent to a PC.

- PT status, screen number of currently displayed screen
- The status of touch switch inputs
- Numeric values and character string input with the numeral/character string setting function using touch switches or a bar code reader.
- Changes in memory table entries after copying between memory table entries, etc.
- Numerical results of calculations from the mathematical function

Functions of Display Elements

Lamps (page 112)

Allocated: Bit

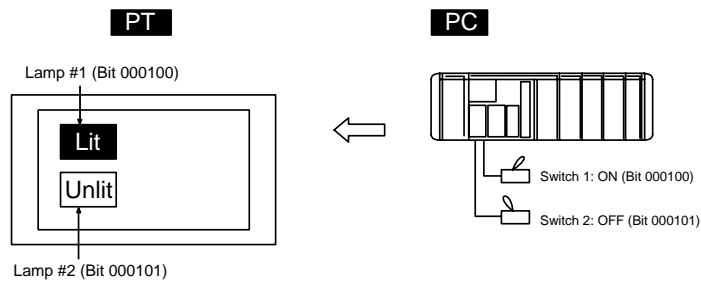

The PC's bit status is displayed by the lamp at the PT.

Normal (standard) lamps come on (flash) when the PC's bit status (lamp bit) is ON (1), and go off when it is OFF (0).

With image/library lamps, the displayed image or library data can be switched in accordance with the ON (1)/OFF (0) status of PC bits (lamp bits).

Touch Switches (page 119)

Allocated: Bit (lamp bit, notification bit, or interlock bit)

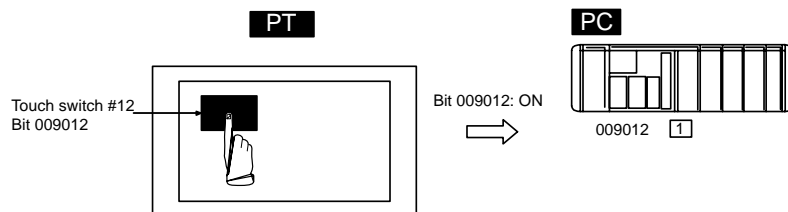

The lamp comes on (flashes) when the PC's bit (lamp bit) is ON (1) and goes OFF when it is OFF (0). When the touch switch is pressed, the PC's notification bit comes ON (1) or goes OFF (0).

The interlock function can also be used. An operation is enabled only while the corresponding interlock bit allocated in the PC is ON.

Numeral Display or Graph (Numeral Memory Table) (page 140)

Allocated: Word

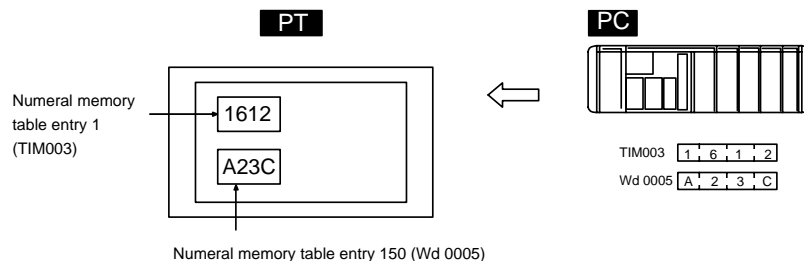

Allocate any desired words in the PC for numeral memory table entries. If the contents of the allocated words are changed while the numeral memory table data is being displayed on the screen as numeric values or lamps, the display on the screen will also change automatically. This function allows the contents of allocated words to be monitored easily.

Reading and writing are executed so that the contents of allocated words are always the same as those of the numeral memory table entries.

Character String Display (Character String Memory Table)
(page 148)

Allocated: Word

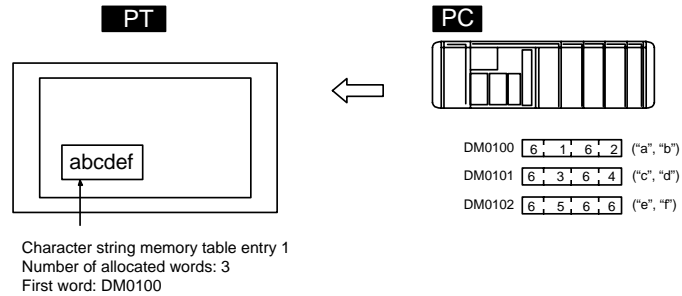

Allocate any desired words in the PC to character string memory table entries. If the contents of the allocated words are changed while the character string memory table data is being displayed on the screen as text, the corresponding display on the screen will also change automatically. This function allows any desired message to be displayed easily.

Reading and writing are executed so that the contents of allocated words are always the same as those of the character string memory table entries.

Numeric and Thumbwheel Inputs (Numeral Memory Table) (page 192, 200)

Allocated: Word

Bit (interlock bits)

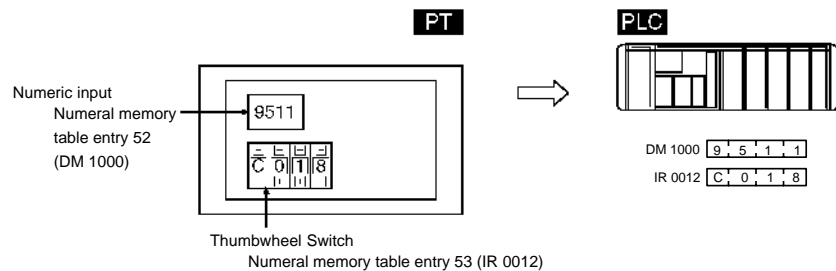

Allocate any desired words in the PC to the numeral memory table entries. When a value is input or changed with the numeric input or thumbwheel switch, the new value will be written to the numeral memory table entry and the contents of the words allocated in the PC will be changed automatically. This function allows word PVs to be changed easily from the PT.

The interlock function can also be used. The numeric and thumbwheel switch inputs are enabled only while the corresponding interlock bits allocated in the PC are ON.

Character String Input (Character String Memory Table) (page 210)

Allocated: Word

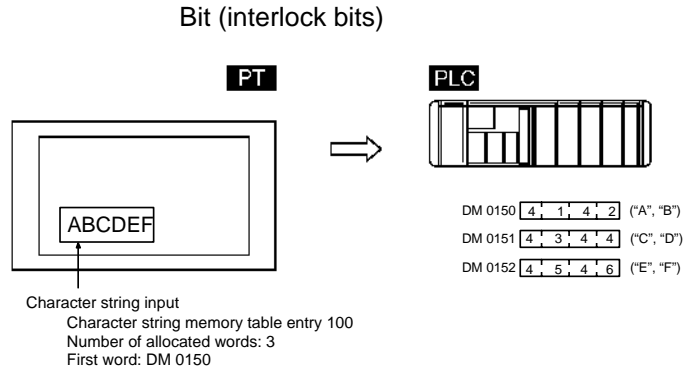

Allocate any desired words in the PC to character string table entries. When text is input with a character string input, the new character string will be written to the character string memory table entry and the contents of the words allocated in the PC will be changed automatically. This function allows text to be written from the PT to the PC easily.

The interlock function can also be used. The character string input is enabled only while the corresponding interlock bit allocated in the PC is ON.

Alarm List (Bit Memory Table) (page 182)

Allocated: Bit

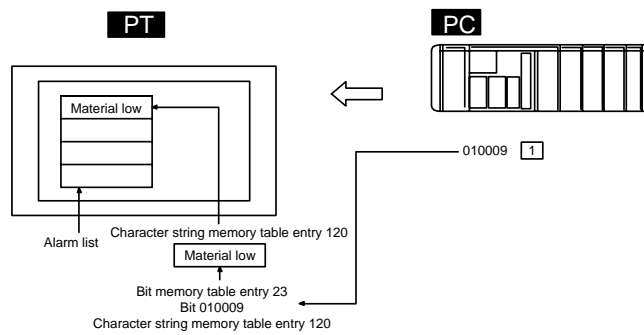

When the PC bit comes ON (1), the contents of the character string memory table entries registered for the bit memory table entries are displayed in the alarm list. When the bit returns to the OFF (0) status, the character string memory table display is automatically cleared.

Alarm History (Bit Memory Table) (page 182)

Allocated: Bit

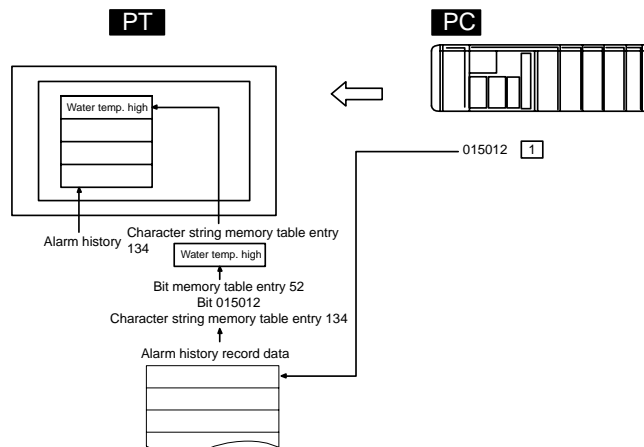

The PC bit allocated to the bit memory table entry for which the history property has been set is continually monitored: when the bit turns ON (1), the time, the number of times, and the contents of the character string memory table entry registered for the bit memory table entry are recorded in the alarm history record data.

This record data can be displayed as the alarm history.

PT Status Control Area (PC ↔ PT)

The PT status control area is used to control the PT status. When data is written to this area in the PC, the PT reads the contents and operates according to the contents.

Example of PT Status Control Area Application

When data is written to the PT status control area, the PT operates as shown below (page 52).

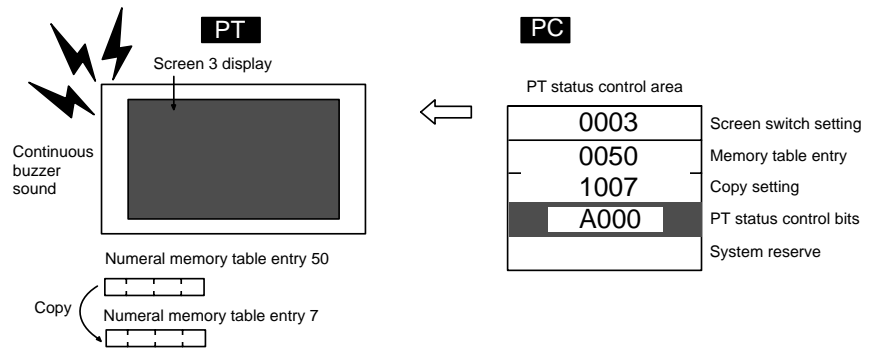

PT Status Notify Area (PT to PC)

The PT status notify area is used to notify the changes in the PT status. When the PT status changes, the change is written to this area in the PC. By reading the data from this area, the PT status can be checked.

Example of PT Status Notify Area Application

When the PT status changes, the change is applied to the PT status notify area as shown below (page 61).

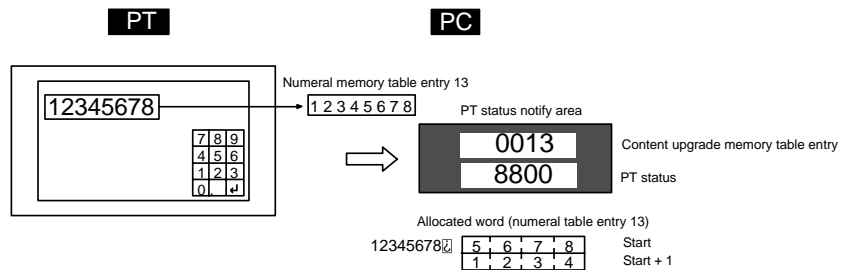

Reference: When the PT is set to NT20S or NT30/620 compatible mode, the word configuration is identical to that of the earlier NT20S, NT30, NT30C, NT620S, NT620C, and NT625C PTs.

Functions of the Window Control Area (PC to and from PT)

The window control area is used to notify and control the window status. The window control area has areas that correspond to three windows. Each area stores the screen number, and the X and Y coordinates of the lower left corner of the window that is being displayed.

When data is written to this area in the PC, the PT reads the contents and executes tasks such as switching the windows to be displayed or moving the position of the windows according to the contents (page 241).

When the window display status changes, the change is written to this area in the PC. By reading the data from this area, the window display status can be checked (refer to page 241).

If the window functions are not used, it is not necessary to allocate a window control area in the host.

Example of Window Control Area Application

When data is written to the window control area, the PT operates as shown below.

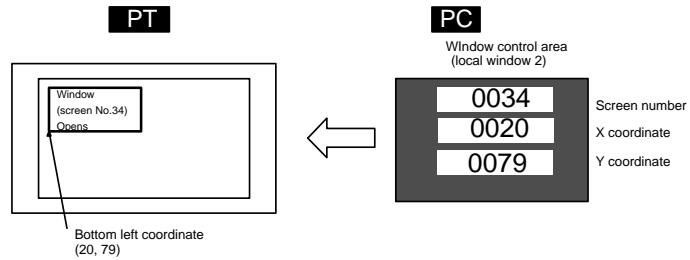

When the window display status changes, the change is notified to the window control area as shown below (Window's Opening/Closing status is notified to the PT status notify area as well).

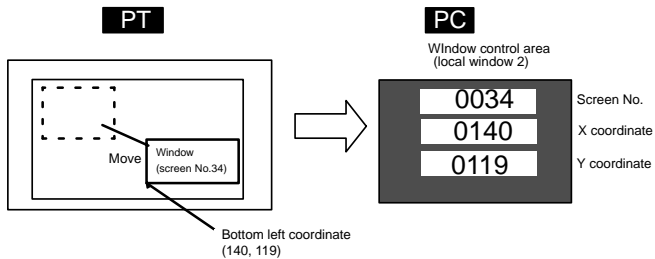

1-4-5 Clock Data Area (PC to PT) (NT21 Only)

The NT21 does not have a built-in clock and instead uses the clock data from the PC. The seconds, minutes, hour, day, month, year, and day of week data is read from the PC into a Clock Data Area.

The NT21 periodically updates the data in the Clock Data Area, storing the data in numeral table entries 247 to 253. These table entries are used to read the clock data. When displaying the time or date on the NT21 or when using the screen display history or alarm history, allocate the Clock Data Area in PC memory and periodically update the contents of the allocated words in the PC using the PC's ladder diagram. (The structure of the clock data in the NT21 is the same as the structure of the words containing the clock data in the PC. If these

words are allocated for the Clock Data Area, then periodic updating from the ladder diagram is not necessary.

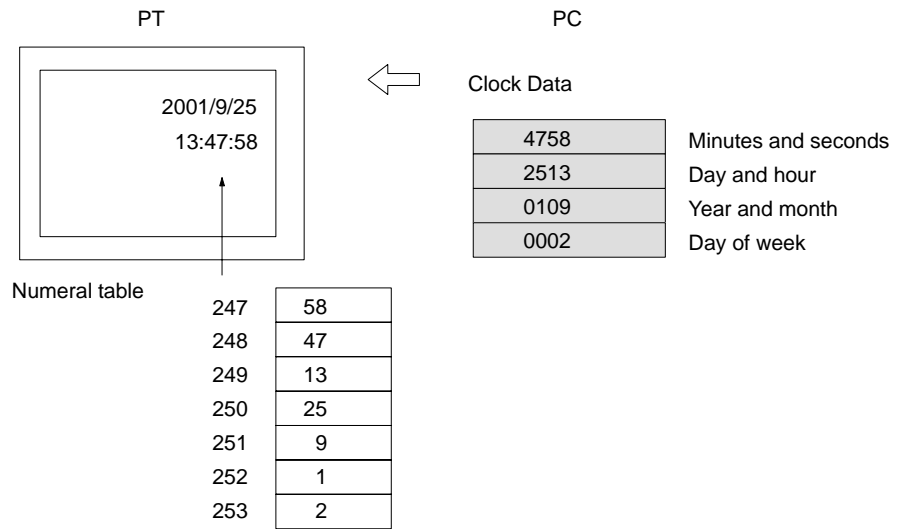

1-4-6 Connecting to other Companies' PCs

Installing a system program for multi-vendors by using a specific system installer enables the NT31/NT31C or NT631/NT631C to be connected to the PCs of other companies in direct connection. This system installer is supplied with the Support Tool (NT-ZJCAT1-EV4). (The NT21 does not support this function.)

Compatible PCs

The NT31/NT31C and NT631/NT631C can be connected to the following Mitsubishi PCs.

- Mitsubishi A series programmable controller (computer link module)
- Mitsubishi FX series programmable controller
- SLC500 Series by Allen-Bradley
- 90-20 and 90-30 Series by GE Fanuc
- S7-300 and S7-400 Series by Siemens
- TSX Series by Modicon

For details on the procedure for connecting to other model PCs, refer to the *PC Connection Manual*, or *NT31/631 Multi Vendor Connection Manual*.

1-5 Communication by Using Memory Links

In this section, a communication method other than the direct connection, called the memory link, is discussed.

1-5-1 Memory Link

The memory link is a method to send and receive data between a personal computer or a FA computer and the PT by using RS-232C/422A communication.

In memory link, there is an area called the PT Memory, as shown below, inside the PT, and this area is treated as a virtual area on the PC. This allows PT memory and the display elements of the PT to make a quasi-direct connection. By sending a command for the memory link, the host can make the PT execute processes through PT memory. Frequently used commands are kept handy for read and write tasks of the numeral memory table, character-string memory table, and bit memory table.

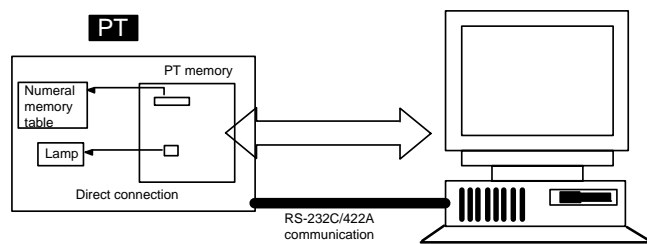

In the memory link method, the only difference is that the PT finds its communication target inside instead of outside. In the memory link method, therefore, change of the target is all that is needed to be capable of using the exact screen data that is acquired by the direct connection. (With the NT21, NT31/NT31C, and NT631/NT631C, the Support Tool must be used to convert the data to screen data for the memory link.)

When compared to the direct connection of the host link or NT Link methods, the memory link method has some restrictions regarding the use of some functions, as described below.

- The Programming Console and Device Monitor functions cannot be used.
- The following strobes of PT status notify bits do not turn ON (page 7 to 27).
 - Screen switching strobe
 - Numerals input strobe
 - Character-string input strobe
- The usable area for allocation is the PT memory only.

1-5-2 Comparison between Direct Connection and Memory Link

The major differences between the direct connection and the memory link are as follows:

- In the memory link method, the communication with the host should be carried out by using commands. Compared to the ordinal direct connection, which can be used requiring almost no programs, the memory link method requires a program that is necessary for interchange of commands. This, however, gives advantages to the memory link method by using a large variety of functions available in the direct connections from major models such as a personal computer and a FA computer equipped with RS-232C/RS-422A communication means, allowing the PT to be suited for larger usage.

- Actual PCs have many kinds of areas, where as PT memory is a single area. When creating screen data by using the memory link methods, it is always necessary to allocate PT memory to display parts.

For communication between the host and the PT by the memory link method, refer to *Section 4 Using Memory Link*, and for how to use screen and display elements, refer to *Section 3 How to Use the PT*.

1-5-3 Memory Link Online Transfer Function

When memory link communications are being used, the PT can be switched to Transmit mode from the host and screen data can be written even if the PT is operating. (The PT can be returned to RUN mode after the screen data is written.)

The memory link online transfer function can be used to replace screen data at a fixed time each day or replace screen data with maintenance screen data for maintenance.

For more details on the memory link online transfer function, refer to *4-4 Memory Link Online Transfer Function*.

1-6 Before Operating

Follow the procedure given below to start the system of the NT21, NT31/NT31C, or NT631/NT631C.

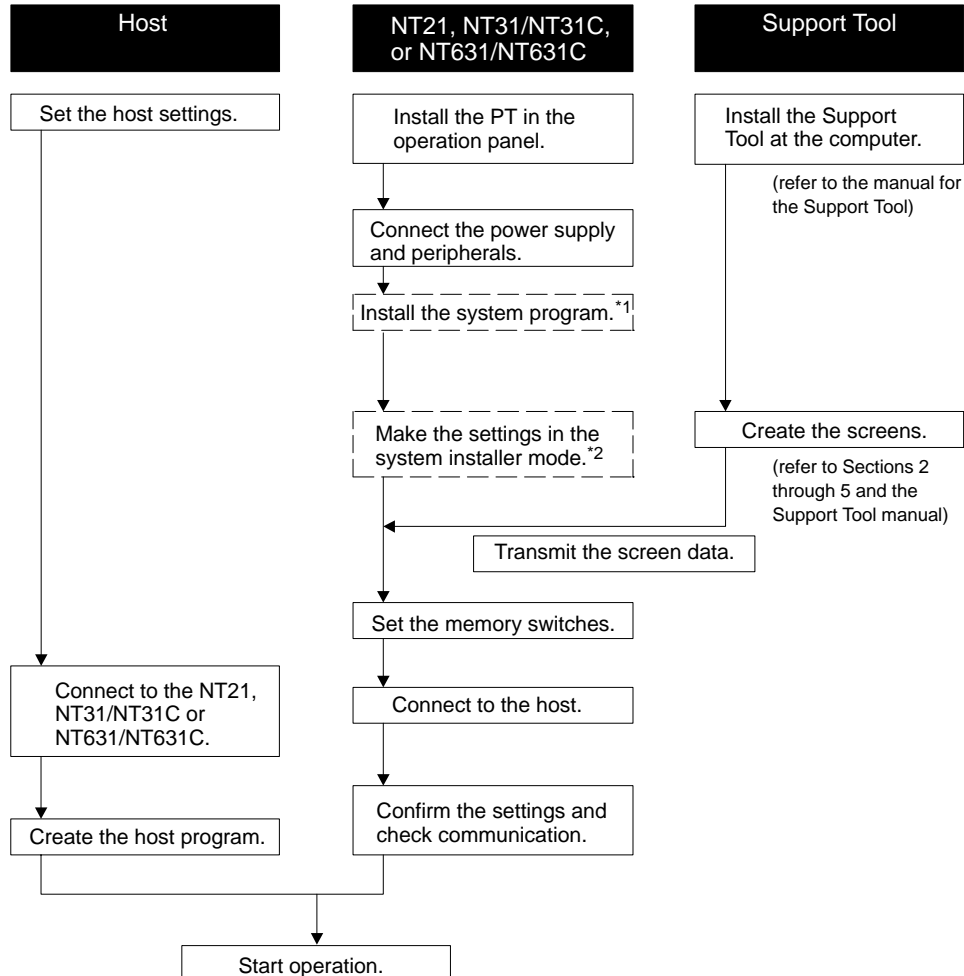

*1: System program installation is only done in special circumstances, for example when changing the system program, or to recover the original status of the installed program. This operation is not normally necessary. When using other PC models (sequencers), however, it is necessary to install specific system programs.

*2: Display of the system menu, and all change operations, can be disabled to prevent the accidental deletion or alteration of screens and settings.

- Reference:**
- For the system program, use the NT21, NT31/NT31C, or NT631/NT631C system program supplied as an accessory with the NT series Support Tool (NT-ZJCAT1-EV4).
 - For the Support Tool, use NT-series Support Tool for Windows 95/98 (Ver. 4).

Refer to the following manuals for the Units and software.

Equipment or Software	Manual Title	Manual Number
NT21	Setup Manual	V068-E1-□
NT31/NT31C	Setup Manual	V062-E1-□
NT631/NT631C	Setup Manual	V063-E1-□
System Installer	NT-series Support Tool for Windows 95/98 (Version 4)	V061-E1-□
Support Tool	NT-series Support Tool for Windows 95/98 (Version 4)	V061-E1-□
PC	SYSMAC CPM1 Operation Manual	W262-E1-□
	SYSMAC CPM1A Operation Manual	W317-E1-□
	SYSMAC CPM2A Operation Manual	W352-E1-□
	SYSMAC CPM2C Operation Manual	W356-E1-□
	SYSMAC C200H Operation Manual (for CPU01/03/11) (programming)	W130-E1-□
	SYSMAC C200H Operation Manual (for CPU21/23/31) (programming)	W217-E1-□
	SYSMAC C200HS Installation Guide	W236-E1-□
	SYSMAC C200HS Operation Manual (programming)	W235-E1-□
	SYSMAC C200HX/HG/HE(-Z) Installation Guide	W302-E1-□
	SYSMAC C200HX/HG/HE Programming Manual	W303-E1-□
	SYSMAC C200HX/HG/HE-Z Programming Manual	W322-E1-□
	SYSMAC C1000H/C2000H Operation Manual (programming)	W140-E1-□
	SYSMAC CQM1 Programming Manual	W228-E1-□
	SYSMAC CQM1H Operation Manual	W363-E1-□
	SYSMAC CQM1H Series Serial Communications Board Operation Manual	W365-E1-□
	SYSMAC CVM1/CV500/CV1000/CV2000 Operation Manual: Ladder Diagrams	W202-E1-□
	CS Series CS1G/H-CPU □□-EV1 Programmable Controllers Operation Manual	W339-E1-□
	CJ Series CJ1G-CPU□□-E Programmable Controllers Operation Manual	W393-E1-□
CS/CJ Series Programmable Controllers Programming Manual	W394-E1-□	
CS/CJ Series Serial Communications Boards/Units Operation Manual	W336-E1-□	
CompoBus Master Control Unit	SRM1 Operation Manual	W318-E1-□
Programming Devices	SYSMAC Support Software Operation Manual: C-series PCs	W248-E1-□
	SYSMAC Support Software Operation Manual: CVM1 PCs	W249-E1-□
	SYSMAC CPT Operation Manual	W332-E1-□ W333-E1-□
	CX-Programmer Operation Manual	-
Host Link Unit/ Communications Board	SYSMAC C Series Host Link Unit Operation Manual	W143-E1-□
	SYSMAC CVM1/CV Series Host Link Operation Manual	W205-E1-□
	SYSMAC C200HW-COM01 C200HW-COM02-V1 to C200HW-COM06-EV1 Communications Boards Operation Manual	W304-E1-□

SECTION 2

PT Functions

This section describes the functions of the PT.

2-1	PT Screens	41
2-1-1	Screen Composition	41
2-1-2	Screen Numbers	41
2-1-3	Screen Types	41
2-1-4	Screen Attributes	45
2-1-5	Display Colors	47
2-1-6	Display Elements	49
2-2	Areas for Control/Notification	52
2-2-1	PT Status Control Area (Host e PT)	52
2-2-2	PT Status Notify Area (PT to Host)	61
2-2-3	Window Control Area (Host e PT)	65
2-2-4	Clock Data Area (Host to PT, NT21 Only)	69
2-3	Memory Tables	72
2-3-1	Numeral Memory Table	72
2-3-2	Character String Memory Table	79
2-3-3	Bit Memory Table	83
2-4	Fixed Displays	90
2-4-1	Circles, Arcs, Sectors, Polylines, Polygons, Rectangles (Fixed Displays)	90
2-4-2	Text (Fixed Display)	98
2-4-3	Tiling	101
2-4-4	Marks	103
2-5	Image and Library Data	106
2-5-1	Image Data Display	106
2-5-2	Library Data Display	109
2-6	Lamps	112
2-7	Touch Switches	119
2-8	Numeral Display	140
2-9	Character String Display	148
2-10	Graphs	154
2-10-1	Bar Graphs	154
2-10-2	Analog Meter	158
2-10-3	Broken Line Graphs	164
2-10-4	Trend Graphs	170
2-11	Alarm List, Alarm History	182
2-12	Inputting Numeric Values	192
2-12-1	Numeric Key Type (Numeral Input)	192
2-12-2	Thumbwheel Type (Thumbwheel)	200
2-13	Inputting Character Strings	210
2-14	Recipes	216
2-14-1	Function Outline	216
2-14-2	Operation Outline	221
2-14-3	Limits	226
2-14-4	Common Attributes	227
2-14-5	Display Functions	235
2-14-6	Input Functions	235
2-14-7	Output Functions	235
2-14-8	Relationship with Other Elements	236

2-15	Window Function	237
2-15-1	What Are Windows?	237
2-15-2	Window Type	238
2-15-3	Window Screens and Display Elements	239
2-15-4	Opening/Closing and Moving a Window	239
2-15-5	Size and Display Position of a Window	241
2-15-6	Changing the Displaying Order of Windows	241
2-15-7	Checking the Display Status of a Window	242
2-15-8	Temporary Input Fields	242
2-15-9	Focus Window	243
2-16	Special Functions	244
2-16-1	Display History Record Function	244
2-16-2	Alarm History Record Function	246
2-16-3	Resume Function	249
2-16-4	Screen Saver Function	249
2-16-5	Buzzer Function	250
2-16-6	Clock Function	251
2-16-7	Print Function (NT31/NT31C or NT631/NT631C Only)	253
2-16-8	Adjusting Contrast and Brightness During PT Operation	255
2-16-9	Programming Console Function	257
2-17	Device Monitor Function	259
2-17-1	Compatible Systems	260
2-17-2	Device Monitor Screens and Functions	261
2-17-3	Starting and Exiting Device Monitor	261
2-17-4	Operations Common to the Device Monitor Screens	263
2-17-5	Using the Registration Monitor Screen	264
2-17-6	Using the Continuous Monitor Screen	271
2-17-7	Using the Error Log Screen	275
2-17-8	Errors Occurring during Device Monitor Operation	277
2-18	Mathematical Function	279
2-18-1	Executable Calculations	279
2-18-2	Data Flow in Calculations	282
2-18-3	Precautions When Using the Mathematical Function	283
2-19	PT Configuration Settings	285
2-19-1	PT Configuration Settings	285

2-1 PT Screens

This section describes the PT screens, which are the basis of PT functions.

2-1-1 Screen Composition

The size of the NT21, NT31/NT31C and NT631/NT631C screens are as follows:

NT21:	260 dots wide by 140 dots high
NT31/NT31C:	320 dots wide by 240 dots high
NT631/NT631C:	640 dots wide by 480 dots high

The location of each dot is expressed by Cartesian coordinates: an X coordinate (horizontal direction) and a Y coordinate (vertical direction). The coordinate origin (0, 0) is at the top left of the screen.

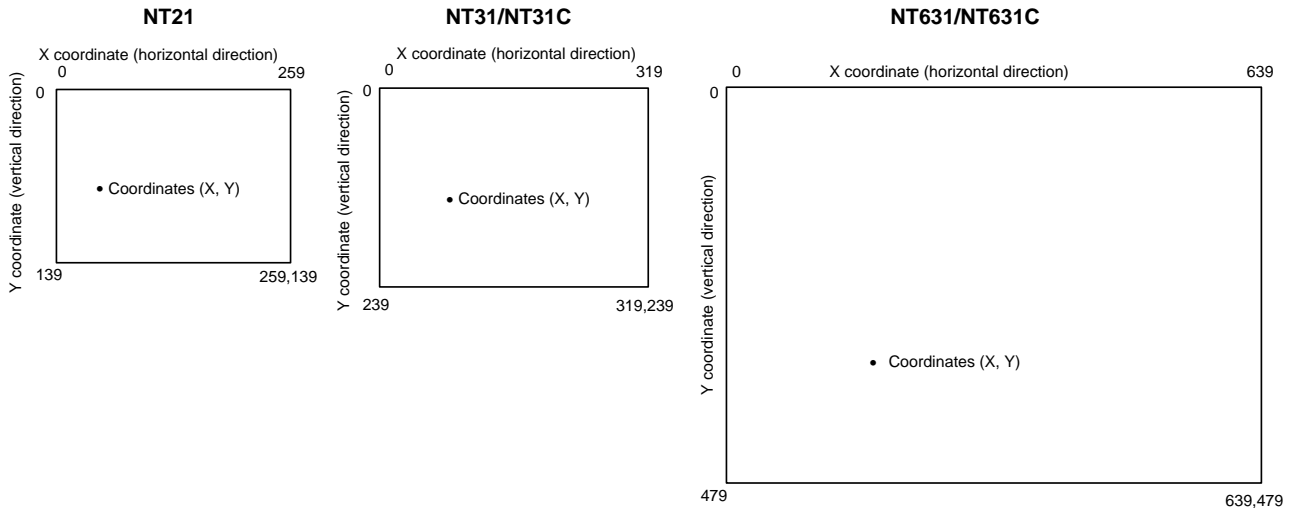

2-1-2 Screen Numbers

The screens of the PT are classified and managed by screen numbers.

Screen numbers are used to designate the first screen displayed when the PT is started up, and to designate the objective screen when switching the screen display, etc.

The PT allows up to 3999 screens to be registered, apart from those screens reserved for specific functions. For these 3999 screens, screen numbers can be designated without restriction within the range 1 to 3999. There are also no restrictions on the order of screen numbers, they can be discontinuous either.

When creating a screen at the PT with the Support Tool, designate a screen number and then register the display elements.

2-1-3 Screen Types

The screens that can be displayed by the PT are classified as follows according to their function:

- Normal (standard) screens
- Overlapping screens
- Window screens
- System screens

Normal (Standard) Screens

Normal (Standard) screens are the basic screens of the PT. There are no specific functions themselves and their purpose is to display elements that have already been registered.

Normal (Standard) screens can be registered under any screen numbers in the range 1 to 3999.

Overlapping Screens

The PT allows up to 8 screens to be displayed overlapped as one screen. A group of overlapped screens is called overlapping screens.

To allow distinction, the screen onto which the multiple component screens are overlapped is called the parent screen and the individual component screens are called the child screens.

Both parent screens and child screens can be registered under any screen numbers in the range 1 to 3999. Note that a new screen must be designated as a parent screen.

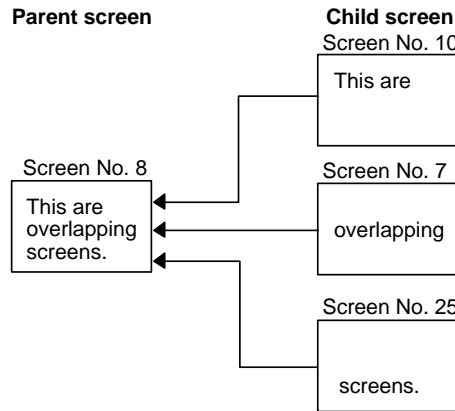

Child Screen Registration and Display Result

Child screens are created as normal (standard) screens. Therefore they can also be displayed independently by designating their screen numbers.

Parent screens are special screens used for the purpose of displaying overlapping screens. They are created by designating a new screen as a parent screen at the Support Tool. Register only the screen numbers of the child screens to be overlapped for this new screen. Direct registration of elements on a parent screen is not possible.

To display overlapping screens on the PT, designate the screen number of the parent screen. The child screens will be displayed in the order they were registered (i.e., the first one registered will be the bottom-most screen) to build up the compound image.

Note that the order in which the child screens are registered may affect the way that overlapped screens are displayed.

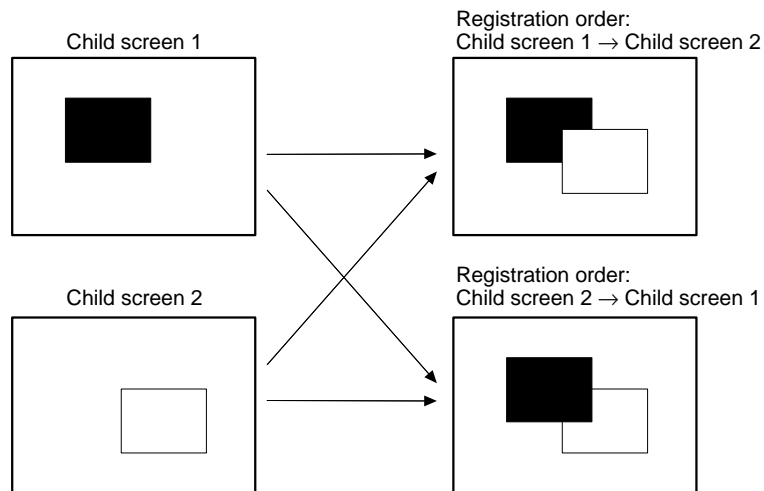

Restrictions on Overlapping Screens

Note the following points, when creating overlapping screens.

- Numerical input and character string input input fields, which allow the input of numeric values and character strings, can each only be set on one of the child

screens. (Thumbwheel switches can be used but temporary input fields cannot.) For details on numeral input, refer to *2-12 Inputting Numeric Values* (page 192), and for details on character string input, refer to *2-13 Inputting Character Strings* (page 210).

- Arrange the touch switches registered for each child screen, so that they do not overlap on the parent screen. If touch switches are overlapped, the intended operation may not be performed when a touch switch is pressed.
- On overlapping screens, the screen attributes of the child screens are invalid and the screen display is governed by the attributes of the parent screen. For details on screen attributes, refer to *2-1-4 Screen Attributes* (page 45).

Window Screens

Apart from the normal (standard) screen display method, which a screen is displayed over the entire panel area, the PT also allows screens to be displayed in one part of the screen area only. This partial screen is called a window. and a screen on which a window is displayed is called a window screen.

Window screens can be registered under any screen numbers 1 to 3999. However, screens that are registered as window screens cannot be displayed independently like normal (standard) screens.

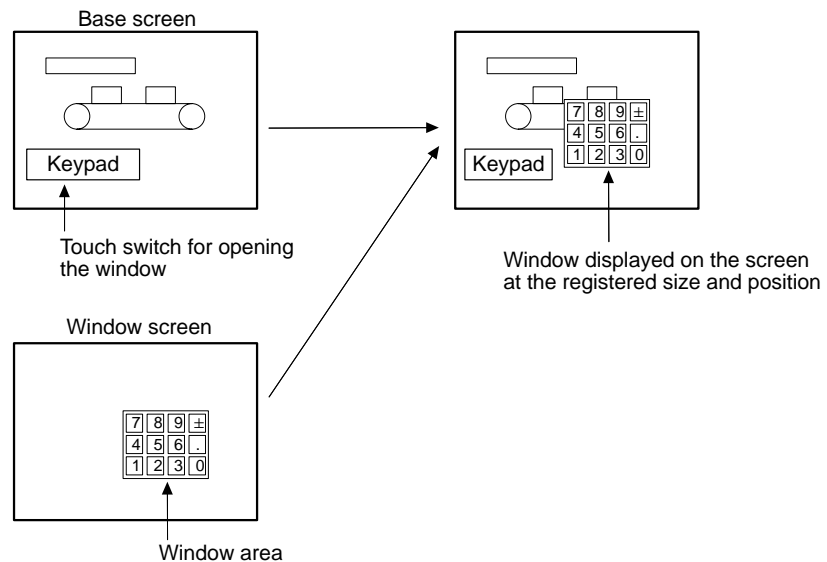

Windows can be called anytime, regardless of which screen is currently displayed. It is possible to display multiple windows (max.: 3) on the same screen, and to open, close or move windows by the control from the host.

With PT, up to three windows can be displayed at the same time.

One of these windows is called a global window. This window can be displayed all the time, regardless of which screen is currently displayed.

Other two windows are called local windows. These windows can be displayed by linking to the currently displayed screens. When the screen is switched, the local window is closed automatically.

For details, refer to *2-15 Window Function* (page 237).

System Screens

Screens with predetermined functions are called system screens.

The types of system screens are indicated in the table below.

Screen No.	Name	Function
0	No-display screen	If screen number 0 is designated as the display screen, the screen of the PT is made blank.
9000	System initializing screen	This screen is displayed during the initial processing when the PT starts operation. During operation, screen number 9000 cannot be designated for display, but it is possible to create and register a screen under screen number 9000 at the Support Tool, and this screen can then be displayed instead of the default system initialization screen. Only fixed display elements can be registered for screen number 9000.
9001	Occurrence history screen	The PT features the display history record function, which records the display status of screens. By designating screen number 9001 as the display screen, you can check the screens that have been displayed up to the present time in display order. You can set whether the records are presented in the order of newest first or oldest first by setting a PT memory switch.
9002	Frequency history screen	The PT features the display history record function, which records the display status of screens. By designating screen number 9002 as the display screen, you can check the screens that have been displayed up to the present time in order of frequency of display.
9020	Programming Console function screen	As an expansion function, the PT features the Programming Console function, which allows equivalent functions to those of a Programming Console. When the PT is connected to a host that supports the Programming Console function, it can be used in the place of a Programming Console by designating screen number 9020 as the display screen.
9021 to 9023	Device Monitor function screens (NT31/NT31C and NT631/NT631C only)	The PT has been equipped with the Device Monitor function, which can perform the same functions as a Data Access Console (DAC). When the PT is connected to a host that supports the Device Monitor function, one of the following screens can be specified to list the contents of host words, change word PVs, or display error log information. 9021: Registration monitor screen 9022: Continuous monitor screen 9023: Error log screen
9030	Brightness and Contrast Adjustment Screen (NT31/NT31C and NT631/NT631C only)	This screen can be used to adjust the contrast and the backlight brightness during PT operation.
9999	Return to previous screen designation	In addition to the display history function, the PT has a function that allows the screen numbers of up to 32 screens to be recorded in their order of display. When screen number 9999 is designated as the display screen, the screen that was displayed immediately before the currently displayed screen is redisplayed. However, note that if a system screen is displayed in the middle of operation, the record of displayed screens is cleared. (The display history function's data is not affected.)

For details on the display history function, refer to *2-16-1 Display History Record Function* (page 244).

For details on the Programming Console function, refer to *6-12 Programming Console Function* of the *Setup Manual (V062-E1-□)*.

For details on the Device Monitor function, refer to *2-17 Device Monitor Function* (page 259).

For details on screen switching refer to *3-3-1 Switching the Screen* (page 299).

2-1-4 Screen Attributes

The PT allows attributes to be set for each screen, so that the function specified by the attribute is executed when the screen is displayed. For example, when a screen for which the buzzer attribute has been set is displayed, the buzzer sounds.

Set the screen attributes as properties of each screen using the Support Tool.

The screen attributes that can be set are listed below. It is possible to set more than one attribute for the same screen at one time.

- Backlight (Light/Flash)
- Buzzer (None/Continuous/Long/Short)
- Background (NT31C and NT631C only)
- Screen comment
- History (record/don't record)
- History title
- Load Local1 (Keyboard) (screen number)
- Load Local2 (screen number)

Backlight

The backlight attribute sets whether the backlight is lit or flashed when a screen is displayed.

Setting	Function
Light	The backlight is lit. (Default)
Flash	The backlight is flashed.

Reference: The PT's backlight can also be lit or made to flash using the PT status control bit (page 293).

Buzzer

The buzzer attribute allows the buzzer to sound when a screen is displayed. There are the following four types of buzzer attribute setting.

Setting	Function
None	The buzzer does not sound when the screen is displayed. (Default) If the buzzer is sounding when the screen is displayed, it stops.
Continuous	The buzzer sounds continuously when the screen is displayed. If a buzzer type other than continuous is sounding when the screen is displayed, the sound changes to continuous.
Long	The long intermittent buzzer sounds when the screen is displayed. If a buzzer type other than long intermittent is sounding when the screen is displayed, the sound changes to long intermittent. The long intermittent buzzer sound is the repeated alternation of 1.0 second on and 1.0 second off.
Short	The short intermittent buzzer sounds when the screen is displayed. If a buzzer type other than short intermittent is sounding when the screen is displayed, the sound changes to short intermittent. The short intermittent buzzer sound is the repeated alternation of 0.5 seconds on and 0.5 seconds off.

The setting for the Buzzer Sound memory switch at the PT takes priority in determining whether or not the buzzer actually sounds. When this memory switch is set to ON, the buzzer set with a screen attribute can sound.

- Reference:**
- The buzzer can also sound by PT status control bit operation (page 290).
 - The following methods can be used to stop the buzzer when it is sounding.
 - Switching to a screen whose buzzer attribute is None
 - Stopping the buzzer by PT status control bit operation (page 292)
 - Registering the buzzer stop touch switch on the screen (page 293)

Background Color (NT31C and NT631C Only)

With the NT31C and NT631C, the background color of the entire screen can be set for each screen. The following 8 background colors can be set.

Black, blue, red, magenta, green, cyan, yellow, white

Screen Comment

A comment indicating the contents of the screen can be set as any required character string of up to 24 characters.

History

When a screen for which this attribute is set is displayed, the screen number, display time, number of times displayed, and history title of the displayed screen are recorded as display history data.

Setting	Function
Checked	When the screen is displayed, its data is recorded in the display history.
Not checked	When the screen is displayed, its data is not recorded in the display history. (Default)

- Reference:** The display history can be checked in the Maintenance mode of the PT, and can also be read during operation by displaying screen number 9001 (occurrence order) or screen number 9002 (frequency order). It is also possible to transmit the display history record data to the personal computer by operation at the Support Tool. For details, refer to the *NT-series Support Tool Version 4 for Windows Operation Manual* (V061-E1-□).

History Title

This attribute sets a character string to be recorded in the display history along with the display time and other information when a screen for which the history attribute is set is displayed.

The history title can be set as any required character string of up to 24 characters.

This setting is only valid for screens for which the history attribute is set. When a screen for which the history title attribute is set is displayed by the PT, the designated character string is recorded together with the screen number in the display history.

Load Local1, Load Local2

Specify whether or not a window (Local1, Local2) pops up at the same time the screen is displayed by screen switching. Set the window screen number to be displayed when you check these attribute.

For details of a window, refer to *2-15 Window Function* (page 237), and for details of using method of a window, refer to *3-4 Display and Control of Windows* (page 308)

- Reference:**
- A window can also be opened, closed or moved by the operation at Window control area. (Refer to page 311.)
 - To control (open close or move) a window, follow the methods below.
 - Register an Input key-Window/Keyboard touch switch or a Window Move touch switch on a screen. (Refer to pages 309, 310.)
 - Register a Cursor Move touch switch that has a window open function. (Refer to page 309.)
 - Operate Window control area from the host. (Refer to page 311.)
 - Switch to the screen that has a Load Local1 (keyboard) or Load Local2 screen attribute. (Refer to page 312.)

Restrictions Relating to Screen Attributes

The functions of the backlight and buzzer attributes can also be performed using the PT status control bits. (And the buzzer can also be operated with a touch switch.) When a screen for which one of these attributes is set is displayed, the set function is executed regardless of the status of the PT status control bits, but the status of the backlight or buzzer can be changed later by using another operation.

Depending on the screen attribute settings and the PT status control bit statuses, the PT status control bit statuses may not match the actual operation (ex. the buzzer bit in the PT status control bits may indicate that the buzzer is stopped although the buzzer is actually sounding). In such a case, carry out PT status control bit operations to make the statuses agree with the actual status of the PT.

For details on the PT status control bits, refer to *2-2-1 PT Status Control Area* (page 52).

2-1-5 Display Colors

When a screen is created with the Support Tool, the color of each element displayed on the PT screen can be set in the element's attributes.

Available Colors

The monochrome PTs (NT21, NT31, and NT631) can display elements in black or white. (The NT631 has an EL display so lit elements will actually appear orange, but the color is still referred to as white.)

The color PTs (NT31C and NT631C) can display the following eight colors.

Black, blue, red, magenta, green, cyan, yellow, white

When an element's color is the same as the background color (making it invisible), the PT changes the color of the element to its opposite color to make it visible. The opposite color combinations (XOR relationships) are as follows:

Black \Leftrightarrow White, Blue \Leftrightarrow Yellow, Red \Leftrightarrow Cyan, Magenta \Leftrightarrow Green

The following kinds of display elements are displayed in the above combinations of colors.

- Frame of input fields for numeral/character string input, and screen background color (page 192, 210).
- Display color of eight dots beyond the top of a bar graph, and screen background color (page 157).

Reference: XOR is the abbreviation of eXclusive OR. Color combinations that are opposites in terms of the three primary colors — red, green, and blue — are said to be in an XOR relationship.

Example: Blue (red 0, blue 1, green 0) \Leftrightarrow Yellow (red 1, blue 0, green 1)

Color Correspondence Between Color and Monochrome PTs

The only colors that a monochrome PT can display are white and black.

The screen data for a color PT can be displayed on a monochrome PT without alteration and in this case the color correspondences are as follows:

Color on a color PT	Color on an NT 21 or NT31	Color on an NT631
Black, blue, red, or magenta	White	Black
Green, cyan, yellow, or white	Black	White (EL lit color)

Likewise, the screen data for a monochrome PT can be displayed on a color PT without alteration and in this case the color correspondences are as follows:

Color on an NT 21 or NT31	Color on an NT631	Color on a color PT
White	Black	Black
Black	White (EL lit color)	White

Reference: When screen data is created for an NT21 or NT31, black and white are displayed as white and black respectively at the Support Tool.

Transparent Display

When elements are displayed on top of others, normally the background color of the element on top conceals the element below so that it cannot be seen.

Besides the above eight colors, the color transparent is available for the background of some display elements.

When transparent is set, nothing appears behind a display element, and the display element or screen background color underneath it is visible.

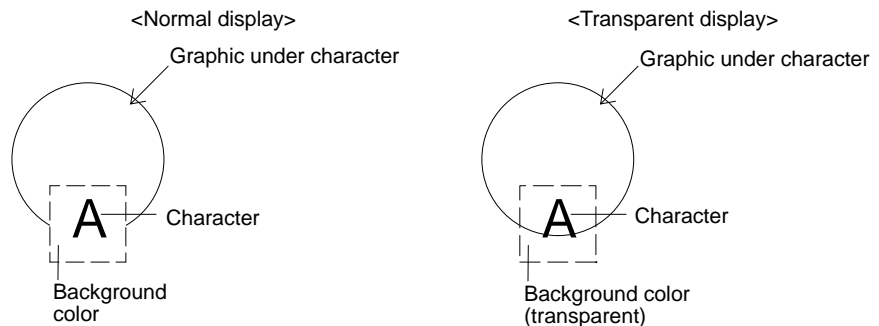

Possible Applications of the Transparent Color Designation

- Background color of normal display text
- Background of labels for lamps and touch switches (fixed as transparent)
- Display color of lamps and touch switches when they are off
- Background color of tiling patterns for graphics
- Background color of marks

Impossible Applications of the Color Transparent Designation

- Background of character strings displayed from the character string memory table
- Background of numeric values displayed from the numeral memory table
- Background of numeric values and character strings in numeral setting input fields and character string input fields
- Background of characters indicating percentages (%) on graphs
- Display color of lamps and touch switches when lit
- Background color of temporary input fields
- Display color of alarm list/history

Screen Background Color

The background color of the entire screen can be designated with the Background screen attribute. Screen attributes are properties set for each screen with the Support Tool.

Text Display Color

The color of characters (character color) and that of their rectangular frames (background color) can be specified.

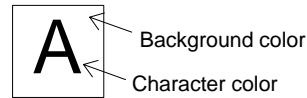

Graphics Display Color

The colors of lines and tiling patterns can be specified for graphics.

The colors that can be designated for tiling patterns are the color of the pattern itself, the background color of the pattern, and the color of the outline of the tiled area.

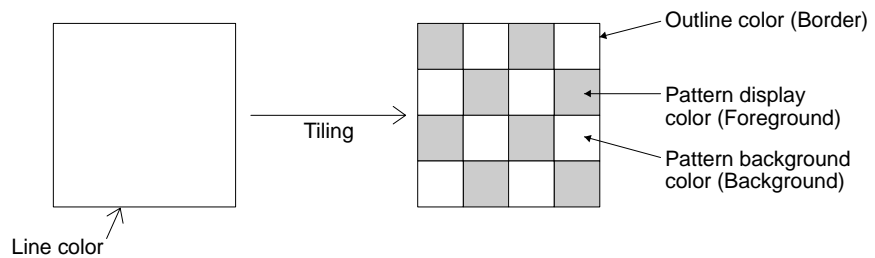

Reference: When a lamp, a touch switch, and a graphic are displayed in color, part of the frames of the display elements may be invisible because of the combination of the background, outline, and tiling colors. This is a phenomenon peculiar to a color LCD, not a failure of the system. In such a case, change the color combination.

2-1-6 Display Elements

The PT can display the following elements.

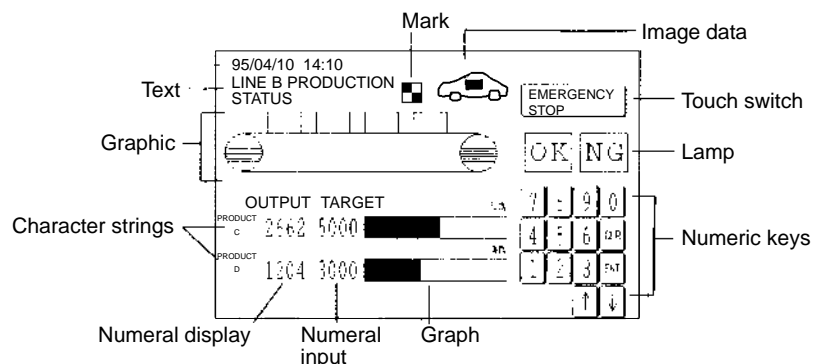

Element		Description	For Details, Refer to
Fixed display	Arcs	Possible display modes: standard/flash/inverse/inverse flash. Other display modes are not available.	Page 90
	Circles	Possible display modes: standard/flash/inverse/inverse flash. Other display modes are not available.	Page 90
	Rectangles	Possible display modes: standard/flash/inverse/inverse flash. Other display modes are not available.	Page 90
	Polygons	Possible display modes: standard/flash/inverse/inverse flash. Other display modes are not available.	Page 90
	Polylines	Possible display modes: standard/flash. Other display modes are not available.	Page 90
	Sectors	Possible display modes: standard/flash/inverse/inverse flash. Other display modes are not available.	Page 90
	Text	Character strings. Possible display modes: standard/flash/inverse flash. Other display modes are not available.	Page 97
	Tiling	The inside of an enclosed area is filled with a tiling pattern.	Page 101
	Image data	Graphics of any required size, composed of dots. The display mode cannot be changed.	Page 106
	Library data	These are groups of elements used as a single element. Fixed display graphics can be registered as library data.	Page 109
Marks	These are graphics composed of 16 by 16 dots that are treated as characters.	Page 103	
Lamps	Normal (Standard) lamps	These are graphics that light (flash) and go off depending on the status of a bit at the host. The following shapes can be selected for normal (standard) lamps: rectangles, polygons, circles, fans.	Page 112
	Image/library lamps	These are elements that display different image/library data depending on the status of a bit at the host.	Page 112
Touch switches		These are elements that can be used as switches: they allow the execution of various functions, such as notification to the host, to be executed by pressing the touch panel of the PT. They also have the same display functions as normal (standard) lamps. They can be displayed in any of the following forms: standard, shadow, 3-dimension, rectangle, circle, polygon, sector — (standard without frame can be displayed also.).	Page 119
Numeral display		The contents of a numeral memory table entry in the internal memory of the PT is displayed. The display changes in accordance with changes in the data contents.	Page 140
Character string display		The contents of a character string memory table entry in the internal memory of the PT is displayed. The display changes in accordance with changes in the data contents.	Page 148
Graphs	Bar graphs	The data contents of a numeral memory table entry in the internal memory of the PT is displayed in bar graph form.	Page 154
	Analogue meter	The data contents of a numeral memory table entry in the internal memory of the PT is displayed in the form of a quarter, semi-circle or circle-shaped graph.	Page 158
	Broken line graphs	The data contents of multiple numeral memory table entries in the internal memory of the PT are displayed in the form of a broken line graph.	Page 164
	Trend graphs	The data contents of multiple numeral memory table entries in the internal memory of the PT are displayed in the form of a trend graph.	Page 170

Element		Description	For Details, Refer to
Alarms	Alarm list	This element monitors the status of host bits designated in advance, and displays the message corresponding to the bit that comes ON. By pressing the displayed message, the corresponding image/library data can be displayed and the screen can be switched.	Page 182
	Alarm history	<ul style="list-style-type: none"> · Occurrence order This element monitors the status of host bits designated in advance, and displays the contents of the alarm history record (occurrence order), which records the time when the bits come ON, together with the messages corresponding to each bit. As with the alarm list, it is possible to display the messages or image/library data corresponding to each bit. · Frequency order This element monitors the status of host bits designated in advance, and displays the contents of the alarm history record (frequency order), which records the number of times each bit has come ON, together with the messages corresponding to each bit. As with alarm list, it is possible to display the messages or image library data corresponding to each bit. 	Page 182
Input Settings	Numeral input	This is an element for inputting numeric values to a numeral memory table entry by using touch switches as numeric keys.	Page 192
	Character string input	This is an element for inputting character strings to a character string memory table entry by using touch switches as input key – string.	Page 210
	Thumbwheel switch	This is an element for inputting numeric values to a numeral memory table entry by using + and – touch switches for each digit.	Page 200
Recipe		Tabular elements that can be used to write several words of numeric value data set at the PT, or can be used to read several words of data from the host. It also allows numerical value data to be edited from the touch panel.	Page 216

2-2 Areas for Control/Notification

The following areas are provided for PT control and PT status notification between the PT and the host.

- **PT status control area**
This area is used to designate the screen to be displayed at the PT, to copy data contents between memory table entries in the PT, and to control the status of the backlight and other statuses.
- **PT status notify area**
This area is used to notify the memory table entry number to the host when there is a change in the data contents of a memory table entry in the PT, and to notify information such as changes in the PT status.
- **Window control area**
This area is used to designate the window screen number or display position from the host, and to notify these information from PT.
- **Clock data area (NT21)**
This area is used to read clock data from the host for use by the PT. The NT21 does not have a built-in clock, so data is periodically read to this area.

- Reference:**
- Words must be allocated in the host for the PT status control area and PT status notify area. Screen data cannot be downloaded from the Support Tool unless they have been allocated.
 - The PT status control area, PT status notify area, window control area, and clock data area (NT21 only) must be set so that they do not overlap.
 - When multiple PTs are connected to one PC, the PT status control area, PT status notify area and window control area of each PT must be set so that they do not overlap, or the movement of PT will be unstable.
 - Allocate words for a window control area in the host only when the window is used and when the window is controlled from the host. Even if words are not allocated for the window control area in the host, a window can be controlled by touch switch operation.
 - Words must be allocated in the host for the clock data area only when clock data is required on the NT21 (e.g., to display the time or date or to use the screen display or alarm history). Allocation is not required if clock data is not being used on the NT21.

2-2-1 PT Status Control Area (Host ↔ PT)

When data is written to this area from the host, the PT reads the data and operates accordingly. However, note that the number of the currently displayed screen is written to the screen switch setting word from the PT too.

The PT status control area is configured as five consecutive words as shown below. The first word (word n) is set in the Control/Notify Area settings in the PT configuration settings made with the Support Tool.

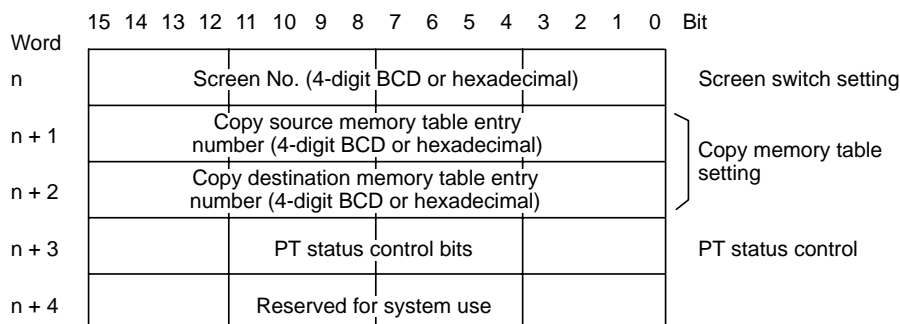

Reference: The configuration and functions of the PT status control area are different when the PT is set to NT20S or NT30/620 compatible mode. Refer to *Appendix C* for details on the NT20S and NT30/620 compatible modes.

Words Allocated for the PT Status Control Area

Words can be allocated for the PT status control area (host ↔ PT) in the following host (PC) areas.

Symbol	C-series PCs	Allocation	CV-series PCs	Allocation	CS/CJ-series PCs	Allocation
None	IR Area	OK	CIO Area	OK	CIO Area	OK
H	HR Area	OK	---	---	HR Area	Not for Host Link
A	AR Area	OK	Auxiliary Area	No	AR Area	OK
L	LR Area	OK	---	---	LR Area* ¹	Not for Host Link
T	TC Area, Timer PVs	No	Timer Area, Timer PVs	No	TC Area, Timer PVs	No
TU	---	---	---	---	TC area, Timer Completion Flags	No
C	TC Area, Counter PVs	No	Counter Area, Counter PVs	No	TC Area, Counter PVs	No
CU	---	---	---	---	TC Area, Counter Completion Flags	No
W	---	---	---	---	WR Area	Not for Host Link
TK	---	---	---	---	Task Flags	No
D	DM Area	OK	DM Area	OK	DM Area	OK
E	EM Area * ² , current bank	OK	EM Area, current bank	Not for Host Link	EM Area, current bank	Not for Host Link
E0_ to EC_	---	---	---	---	EM Area, EM banks 0 to C	Not for Host Link

*1: LR 00000 to LR 00199 are converted to CIO 01000 to CIO 01199.

*2: The EM Area is supported only by the C200HX/HG/HE(-Z)E PCs.

The Auxiliary Area of the CVM1 and CV-series PCs is allocated to system functions, and cannot be used for purposes other than system use.

The range of each memory area differs according to the PC. Refer to *Appendix D PC Memory Maps* on page 441.

Functions of the PT Status Control Area

Screen Switch Setting

Data is written to the screen switch setting word from both the PT and the host. The meaning of the data differs according to whether it is written from the PT or the host. However, if the PT is currently operating, the number of the screen displayed is always written to the screen switch setting word.

Reference: When the PT is set to NT20S or NT30/620 compatible mode, data can be written from the host only. In this case, the screen switch setting notification from the PT occurs in the first word (word m) of the PT status notify area. Refer to *Appendix C* for details on the NT20S and NT30/620 compatible modes.

When Data Is Written from the Host

To switch the screen displayed at the PT by an instruction from the host, write the screen number, as a 4-digit BCD or hexadecimal value, to the screen switch setting word. Whether the value is expressed in BCD or hexadecimal is determined

by the setting for numeral storage type in the PT configuration settings made with the Support Tool.

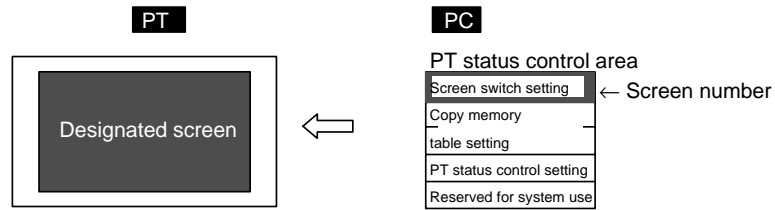

Screen Switch Setting in the PT Status Control Area

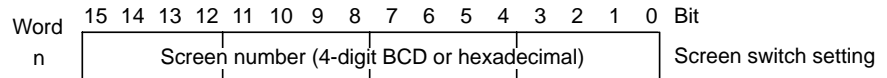

The screen numbers that can be set are as follows:

BCD	Hexadecimal	Screen
0000	0000	No-display (screen cleared)
0001 to 3999	0001 to 0F9F	Screen numbers 1 to 3,999
9001	2329	Occurrence history screen
9002	232A	Frequency history screen
9021	233D	Device Monitor function: Registration monitor screen (See note.)
9022	233E	Device Monitor function: Continuous monitor screen (See note.)
9023	233F	Device Monitor function: Error log screen (See note.)
9030	2346	Brightness and contrast adjustment screen (See note.)

Note These functions are not supported by the NT21.

- Reference:**
- The screen can also be switched by bit memory table operation (page 299), by touch switch operation (page 300), or by using the alarm list/history function (page 303).
 - To display overlapping screens, designate the screen number of the parent screen.
 - If there are no elements registered for the designated screen number, or if a keyboard screen is designated, the screen does not switch.
 - When the PT starts operating, the screen is displayed according to the contents of the screen switch setting word. If the contents of the screen switch setting word are invalid, the screen is displayed according to the Initial Screen in the PT configuration settings made at the Support Tool. If the setting for Initial Screen is also invalid, an error message is displayed.
 - The PT will continue operating when the Programming Console function or Device Monitor function is called with a command from the host, but even though the Programming Console or Device Monitor screen is displayed, it will be skipped if you attempt to go back to it with a return to previous screen touch switch.

When Data Is Written from the PT

When the screen display has been switched by operation at the PT, the new screen number is written as a 4-digit BCD or hexadecimal value into the screen switch setting word by the PT. At the same time, the ON status is also notified to the screen switch strobe flag of the PT status word of the PT status notify area by the PT (after notification, the OFF status is re-established) (page 305). Whether the data is written in BCD or hexadecimal format is determined by the setting for numeral storage type in the PT configuration settings made at the Support Tool.

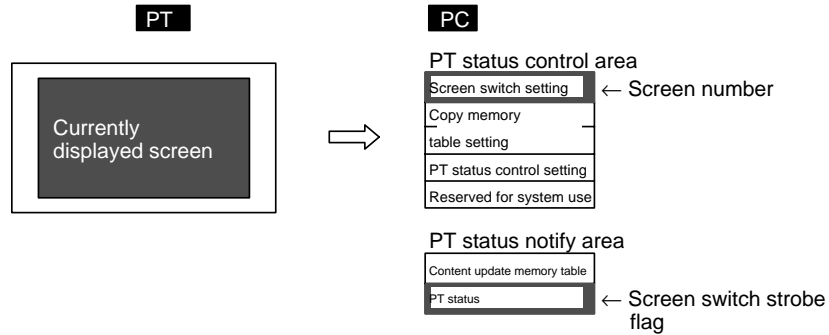

Screen Switch Setting Word of the PT Status Control Area and PT Status Word of the PT Status Notify Area

PT status control area

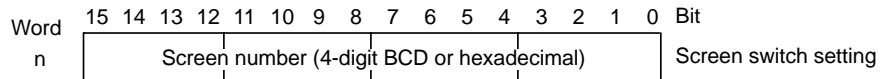

PT status notify area

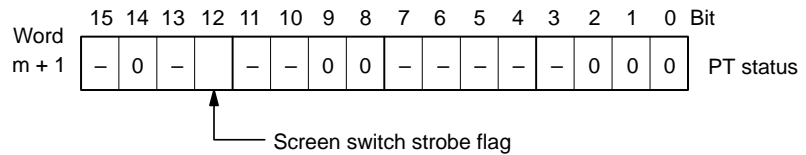

The screen numbers notified are as follows:

BCD	Hexadecimal	Screen
0000	0000	No-display (screen cleared)
0001 to 3999	0001 to 0F9F	Screen numbers 1 to 3,999
9001	2329	Occurrence history screen
9002	232A	Frequency history screen
9020	233C	Programming Console function screen
9021	233D	Device Monitor function: Registration monitor screen (See note.)
9022	233E	Device Monitor function: Continuous monitor screen (See note.)
9023	233F	Device Monitor function: Error log screen (See note.)
9030	2346	Brightness and contrast adjustment screen (See note.)

Note These functions are not supported by the NT21.

- Reference:**
- The screen number is notified only when the screen is switched by operation at the PT.
 - When overlapping screens are displayed, the screen number of the parent screen is notified.
 - When the PT is set to NT20S or NT30/620 compatible mode, the screen switch setting notification from the PT occurs in the first word (word m) of the PT status notify area. Refer to *Appendix C* for details on the NT20S and NT30/620 compatible modes.

Copy Source/Copy Destination Memory Table Entry Numbers

Designate the memory table entry numbers of the copy source and copy destination memory table entries as 4-digit BCD or hexadecimal values, when copying data between memory table entries in the PT. Whether the values are BCD or hexadecimal is determined by the setting for numeral storage type in the PT configuration settings made with the Support Tool.

The memory table entry numbers that can be designated are indicated in the table below.

BCD	Hexadecimal	Numbers
0001 to 1999	0000 to 07CF	Memory table entry numbers 0 to 1,999

Note that it is only possible to copy between the following combinations.

- A numeral memory table entry and a numeral memory table entry
- A character string memory table entry and a character string memory table entry

- Reference:**
- What is designated here is the memory table entry number only. The type of memory table (numeral/character string) is set by the memory table copy type bit in the PT status control bits.
 - Copying is not executed just by writing the memory table entry numbers. It is executed when the memory table entry copy execution bit in the PT status control bits is turned ON.
 - Since the memory table entry numbers start from 0, if there are 2000 memory table entries, the range is 0 to 1999, and if there are 1000, the range is 0 to 999.
 - When the PT is set to NT20S or NT30/620 compatible mode, copying between memory table entries is performed differently. Refer to *Appendix C* for details on the NT20S and NT30/620 compatible modes.

Pt Status Control Bits

The PT status control bits have the functions indicated below.

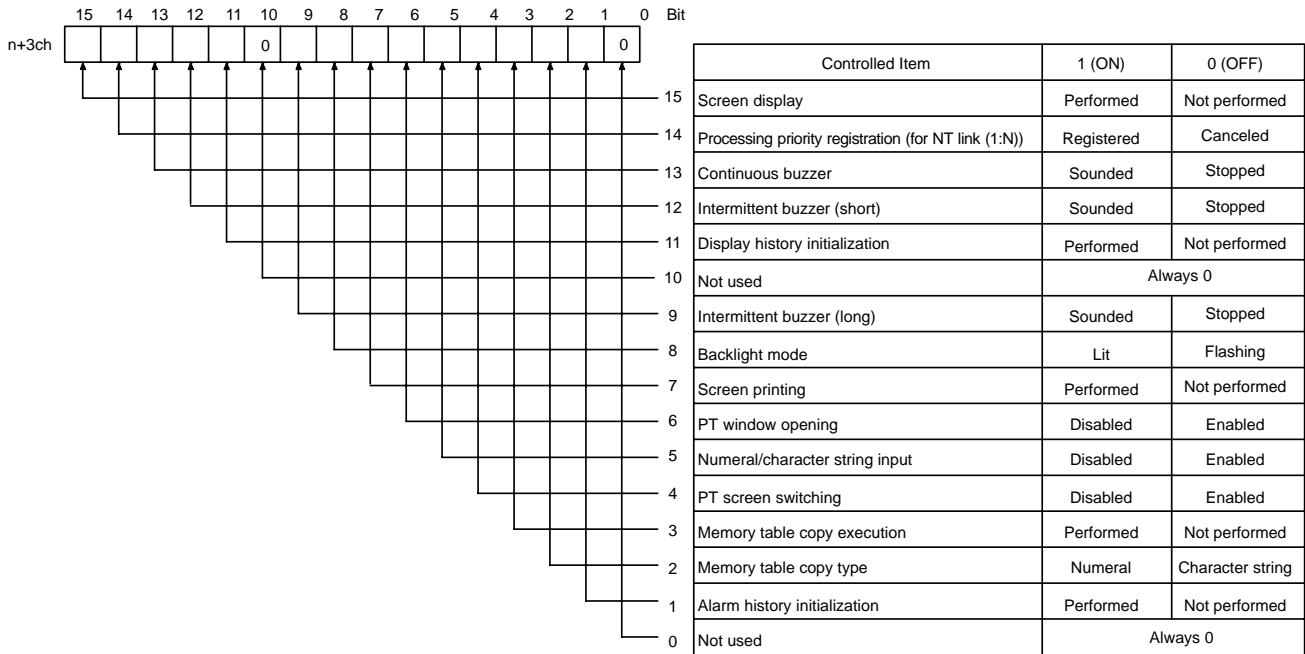

The backlight mode bit (bit 8) is not supported by the NT631.
 The screen printing bit (bit 7) is not supported by the NT21.

- Reference:**
- Since the statuses of the PT status control bits do not change even if the status of the PT changes in accordance with the settings of attributes or memory switches, the statuses of the PT status control bits may sometimes disagree with the status of the PT. For example, the buzzer may be sounding even though the continuous buzzer bit is OFF. In such a case, perform PT status control bit operations to achieve agreement with the status of the PT.
 - The PT status control bits are checked in bit units by the PT. The only functions that are actually performed are those for which the corresponding bits have changed in status.
 - The configuration of the PT status control bits is different when the PT is set to NT20S or NT30/620 compatible mode. Refer to *Appendix C* for details on the NT20S and NT30/620 compatible modes.

Screen Display (Bit 15)

The screen display bit displays and clears screens. It is used to prevent the formation of an afterimage on the display panel, etc. When bit 15 is turned OFF, the screen is cleared and the backlight also goes off. However, if the screen saver function is set with the memory switches of the PT, the screen saver is activated (the operation depends on the setting made for the screen saver function). If bit 15 is turned ON (1), or the touch panel is pressed, while the screen is cleared (or while the screen saver function is working), the screen that was displayed immediately before the screen was cleared is redisplayed. The backlight also comes back on (or flashes).

- Reference:** Even when bit 15 is OFF, the designated screen will be displayed if screen switching is designated from the host, or the status of bit 8 (backlight mode) changes, or the touch panel of the PT is pressed.

Processing Priority Registration (For NT Link 1:N) (Bit 14)

One of the PTs connected by the NT link (1:N) method can be registered for priority processing. The PT for which bit 14 is set to ON (1) is given priority over the other PTs, and has more rapid response time for screen display, touch switch operations, etc.

When bit 14 is set to OFF (0), this registration is canceled and the response speed is returned to normal. If priority registration is set for more than one PT, the one set last is given priority.

The unit number of the PT given priority registration can be checked by monitoring (reading) a word at the CS1, CS1-H, CJ1, CJ1-H, C200HX/HG/HE(-Z)E, CQM1H, and SRM1. For details on the word monitoring operation at a PC, refer to the manual for the PC you are using.

The contents of the words that reflect the status of an NT link (1:N) system are indicated below.

Word	Bit	Function
C200HX/HG/HE(-Z)E IR 265 (standard port) IR 284 (port A) ^{*1} IR 285 (port B) ^{*1} CS1, CS1-H, CJ1, CJ1-H AR 393 (RS-232C port) AR 394 (peripheral port) CIO 1909 (port 1) ^{*2} CIO 1919 (port 2) ^{*2} CIO n+9 (port 1) ^{*3} CIO n+19 (port 2) ^{*3} CQM1H IR 202 (port 1) ^{*2} IR 203 (port 2) ^{*2} SRM1 AR 09	0	Peripheral Port PT Communications Flag for unit 0: ON when connected
	1	Peripheral Port PT Communications Flag for unit 1: ON when connected
	2	Peripheral Port PT Communications Flag for unit 2: ON when connected
	3	Peripheral Port PT Communications Flag for unit 3: ON when connected
	4	Peripheral Port PT Communications Flag for unit 4: ON when connected
	5	Peripheral Port PT Communications Flag for unit 5: ON when connected
	6	Peripheral Port PT Communications Flag for unit 6: ON when connected
	7	Peripheral Port PT Communications Flag for unit 7: ON when connected
	8	Peripheral Port PT Priority Registered Flag for unit 0: ON when given priority
	9	Peripheral Port PT Priority Registered Flag for unit 1: ON when given priority
	10	Peripheral Port PT Priority Registered Flag for unit 2: ON when given priority
	11	Peripheral Port PT Priority Registered Flag for unit 3: ON when given priority
	12	Peripheral Port PT Priority Registered Flag for unit 4: ON when given priority
	13	Peripheral Port PT Priority Registered Flag for unit 5: ON when given priority
	14	Peripheral Port PT Priority Registered Flag for unit 6: ON when given priority
15	Peripheral Port PT Priority Registered Flag for unit 7: ON when given priority	

*1: Communications Board ports

*2: Ports on the Serial Communications Board

*3: Ports on the Serial Communications Unit (n=1500 + 25 the Unit's unit number)

Continuous Buzzer (Bit 13), Short Intermittent Buzzer (Bit 12), Long Intermittent Buzzer (Bit 9)

The continuous buzzer continues buzzing with no interruptions.

The short intermittent buzzer repeatedly alternates between sounding for 0.5 seconds and stopping for 0.5 seconds.

The long intermittent buzzer repeatedly alternates between sounding for 1.0 seconds and stopping for 1.0 seconds.

If more than one of these bits is ON at the same time, the buzzer sounds in accordance with the following order of priority.

1. Continuous buzzer
2. Short intermittent buzzer
3. Long intermittent buzzer

When stopping the buzzer by PT status control bit operation, set all three of the bits above to 0 (OFF).

-
- Reference:**
- The buzzer will actually sound only when the Buzzer Sound memory switch of the PT is set to ON.
 - The buzzer can also be stopped in other ways: by using a touch switch to which the buzzer stop attribute has been assigned (page 300), or by setting the screen attribute that stops the buzzer sound (page 45).
 - The buzzer can also be controlled by using the Buzzer screen attributes (page 45).
 - Even if the buzzer is controlled using PT status control bit operation, changes in the displayed screen may cause the status of the buzzer to be changed depending on the buzzer setting in the screen attributes. Reset the PT status control bits if necessary.
-

Display History Initialization (Bit 11)

This bit is used to initialize the display history recorded in the PT.

When it is switched from 0 (OFF) to 1 (ON), the display history in the PT is initialized.

After initialization, return its status to 0.

-
- Reference:** The display history can also be initialized from the MEMORY INIT. MENU screen under the System Menu of the PT.
-

Backlight Mode (Bit 8)

The backlight mode is used for controlling the backlight of the PT. This bit is invalid in the NT631.

The status of bit 8 has the following effects.

- 1 (ON): lit
- 0 (OFF): flashing

Screen Printing (Bit 7) (Not Supported by the NT21)

Hard copies of the screen can be made when a printer is connected to the PT.

When bit 7 is set from 0 (OFF) to 1 (ON), printing of the currently displayed screen starts. Note that it is not possible to stop printing while printing is in progress.

Check that bit 7 (printer operating status) of the PT status notify area is in the 0 (OFF) status before starting printing.

When printing starts and bit 7 has been set to the 1 (ON) status, return the screen printing bit to 0 (OFF).

-
- Reference:**
- It is also possible to print screens by using a touch switch assigned the Print screen function.
 - The printer type (control protocol) and printing method, are set with the memory switches of the PT.
-

PT Window Opening Bit (Bit 6)

The PT window opening bit is used to disable opening of a window by operation at the PT.

The status of bit 6 has the following effects.

Bit 6	Function
0 (OFF)	Windows can be opened by operation at the PT.
1 (ON)	Windows cannot be opened by operation at the PT (windows that are already open can be closed by operation at the PT). Also, when a keyboard screen attribute is designated for a screen, the window will not open when the screen is switched by operation at the PT.

Reference: If the interlock function has been set for a touch switch, window operations from the touch switch can also be disabled by turning OFF the corresponding interlock bit in the PC.

Numeral/Character String Input (Bit 5)

This bit is used to disable the input of numeric values and character strings into numeral setting/character string input fields by operation at the PT. It also controls input from thumbwheel switches, recipe objects, and bar code readers. The status of bit 5 has the following effects.

Bit 5	Function
0 (OFF)	Input into numeral setting input fields and character string input fields is possible.
1 (ON)	Input into numeral setting input fields and character string input fields is disabled (it is also not possible to change the contents of numeral/character string memory table entries by operation at the PT, such as copying memory table entries with touch switches). The contents of numeral/character string memory table entries can be changed without restriction from the host. It is also possible to copy memory table entries using the PT status control area.

Reference: If the interlock function has been set for a numeral input, character string input, thumbwheel switch, or recipe object, the input can also be disabled by turning OFF the corresponding interlock bit in the PC.

PT Screen Switching (Bit 4)

This bit is used to disable screen switching by operation at the PT. The status of bit 4 has the following effects.

Bit 4	Function
0 (OFF)	Screen switching by operation at the PT is possible.
1 (ON)	Screen switching by operation at the PT is not possible. The screen can be switched by the instructions from the host (screen switch setting word of the PT status control area, bit memory table operations).

Reference: If the interlock function has been set for a touch switch, screen switching by the touch switch can also be disabled by turning OFF the corresponding interlock bit in the PC.

Memory Table Copy Execute (Bit 3), Memory Table Copy Type (Bit 2)

The memory table copy execute and memory table copy type bits are used to copy data between memory table entries in the PT by PT status control area operations.

Proceed as follows to copy between memory table entries using the PT status control area:

Operation

- 1, 2, 3...**
1. Set the numbers of the copy source and copy destination memory table entries for copy source memory table entry number (word n + 1) and copy des-

mination memory table entry number (word n + 2) of the PT status control area.

2. Set the type of the memory table to be copied for memory table copy type (bit 2) of the PT status control bits (word n + 3) as follows:
 - 1 (ON): When copying between numeral memory table entries
 - 0 (OFF): When copying between character string memory table entries
3. Set 1 (ON) for memory table copy execution (bit 3) of the PT status control bits (word n + 3).
Memory table entry data is copied.
4. After copying has been executed, return memory table copy execution (bit 3) to 0.

- Reference:**
- If the display method or number of registered words is different for the copy source and copy destination memory table entries, the data may not be displayed correctly.
 - If the contents of memory table entries are changed by PT status control area operation, the change in memory table contents is not notified by the PT status notify area.
 - Memory table entries are copied differently when the PT is set to NT20S or NT30/620 compatible mode. Refer to *Appendix C* for details on the NT20S and NT30/620 compatible modes.

Alarm History Initialization (Bit 1)

This bit is used to initialize the alarm history recorded in the PT.
When it is switched from 0 (OFF) to 1 (ON), the alarm history in the PT is initialized.
After initialization, return its status to 0.

- Reference:** The alarm history can also be initialized from the MEMORY INIT. MENU screen under the System Menu of the PT.

2-2-2 PT Status Notify Area (PT to Host)

The PT status notify area is provided to notify the host of changes in the status of the PT. The host can determine the status of the PT by reading this area.
The PT status notify area is configured as two consecutive words as shown below. The first word (word m) is set in the Control/Notify Area settings in the PT configuration settings made with the Support Tool.

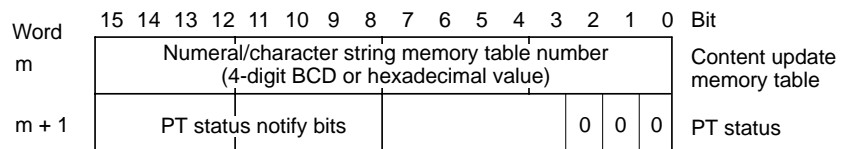

- Reference:** The configuration and functions of the PT status notify area are different when the PT is set to NT20S or NT30/620 compatible mode. (There are 3 words, with the first word indicating the screen currently being displayed.) Refer to *Appendix C* for details on the NT20S and NT30/620 compatible modes.

Words Allocated of the PT Status Notify Area

Words can be allocated for the PT status notify area (PT → host) in the following host (PC) areas.

Symbol	C-series PCs	Allocation	CV-series PCs	Allocation	CS/CJ-series PCs	Allocation
None	IR Area	OK	CIO Area	OK	CIO Area	OK
H	HR Area	OK	---	---	HR Area	Not for Host Link

Symbol	C-series PCs	Allocation	CV-series PCs	Allocation	CS/CJ-series PCs	Allocation
A	AR Area	OK	Auxiliary Area	No	AR Area	OK
L	LR Area	OK	---	---	LR Area* ¹	Not for Host Link
T	TC Area, Timer PVs	No	Timer Area, Timer PVs	No	TC Area, Timer PVs	No
TU	---	---	---	---	TC Area, Timer Completion Flags	No
C	TC Area, Counter PVs	No	Counter Area, Counter PVs	No	TC Area, Counter PVs	No
CU	---	---	---	---	TC Area, Counter Completion Flags	No
W	---	---	---	---	WR Area	Not for Host Link
TK	---	---	---	---	Task Flags	No
D	DM Area	OK	DM Area	OK	DM Area	OK
E	EM Area* ² , current bank	OK	EM Area, current bank	Not for Host Link	EM Area, current bank	Not for Host Link
E0_ to EC_	---	---	---	---	EM Area, EM banks 0 to C	Not for Host Link

*1: LR 00000 to LR 00199 are converted to CIO 01000 to CIO 01199.

*2: The EM Area is supported only by the C200HX/HG/HE (-Z)E PCs.

The Auxiliary Area of the CVM1 and CV-series PCs is allocated to system functions, and it cannot be used for purposes other than system use.

The range of each memory area differs according to the PC. Refer to *Appendix D PC Memory Maps* on page 441.

Functions of the PT Status Notify Area

Reference: When the PT is set to NT20S or NT30/620 compatible mode, there are 3 words in the PC status notify area instead of 2 words. The added first word indicates which screen is currently being displayed at the PT and the original two words are shifted down. Refer to *Appendix C* for details on the NT20S and NT30/620 compatible modes.

Updated Memory Table Entry Number

When the contents of a numeral/character string memory table entry has been changed by operation at the PT, the number of the memory table entry subject to the change is written to the content update memory table entry number word as a 4-digit BCD or hexadecimal value. Whether the value is expressed in BCD or hexadecimal is determined by the setting for numeral storage type in the PT configuration settings made with the Support Tool. The classification of memory table entry can be determined by whether the numeral setting strobe flag or

character string setting strobe flag is turned ON. (After turning ON, the flag will automatically turn OFF.) (Refer to page 63.)

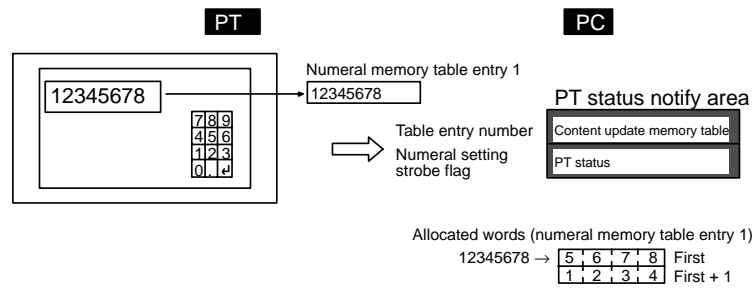

Updated Memory Table Entry and PT Status of the PT Status Notify Area

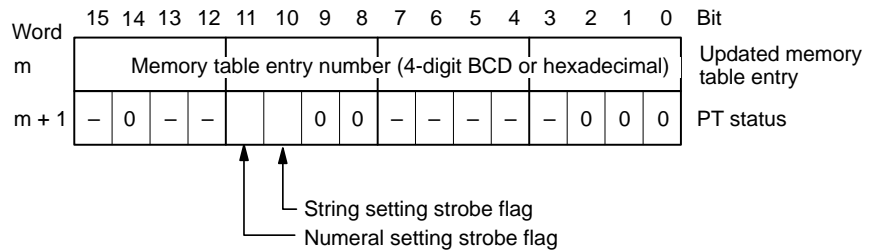

BCD	Hexadecimal	Numbers
0001 to 1999	0000 to 07CF	Memory table entry numbers 0 to 1,999 max.

Reference: The updated memory table entry number is written only when the memory table contents are changed by operation at the PT. The memory table entry number is not written when the contents of the numeral memory table entry are changed with the mathematical function.

PT Status Notify Bits

The PT status notify bits have the functions shown below.

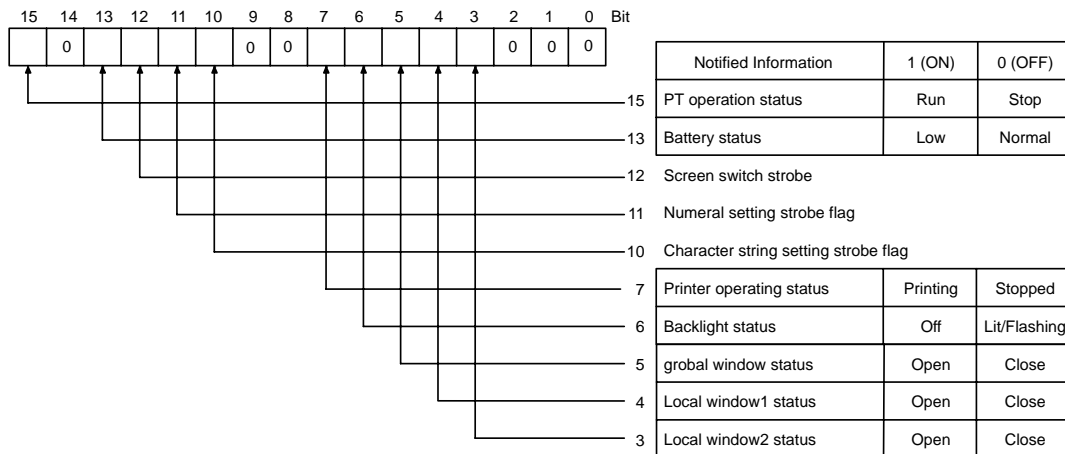

The printer operating status (bit 7) is not supported by the NT21.

PT Operation Status (Bit 15)

When the PT is in RUN mode, this bit is set to 1. In other modes, and when the System Menu screen is displayed, it is set to 0 (OFF). When this bit is set to 0 (OFF), the allocated bits and words are neither read or written.

While the PT is in RUN mode, 1 (ON) is periodically written to this bit. In order to check whether the PT is operating normally or not, write 0 (OFF) to this bit, then

read it 30 seconds later. If the setting for the bit is 1 (ON), the PT is judged to be running, and if it is 0 (OFF), the PT is judged to be stopped.

Note To ensure system safety, be sure to periodically read the PT operating status bit from the host in order to ensure that the PT is always operating normally.

Battery Status (Bit 13)

This bit is set to 1 (ON) when the voltage of the battery that backs up the internal memory of the PT (built-in battery) is low. (An optional Battery is required for the NT21.)

If the battery voltage drops, it is impossible to retain data with the resume function and to retain history records, therefore the battery must be replaced with a new one within one week after the battery bit is set to 1 (ON). For details on how to replace the battery, refer to section 7 of the *Setup Manual*.

Screen Switching Strobe (Bit 12)

This bit is set to 1 (ON) when the PT screen is changed by an instruction from the host or by operation at the PT (ex. use of screen changeover function). After notification to the host, it is automatically returned to 0 (OFF).

Numeral Setting Strobe Flag (Bit 11)

This bit is set to 1 (ON) when a numeric value is input to a numeral memory table entry using the numeral input function of the PT. After notification to the host, it is automatically returned to 0 (OFF).

At the same time, the number of the numeral memory table entry to which the input was made is notified to the content update memory table word.

Character String Setting Strobe Flag (Bit 10)

This bit is set to 1 (ON) when a character string is input to a character string memory table entry using the character string input function of the PT. After notification to the host, it is automatically returned to 0 (OFF).

At the same time, the number of the character string memory table entry to which the input was made is notified to the content update memory table word.

Printer Operating Status (Bit 7) (Not Supported by the NT21.)

This bit is set to 1 (ON) when a printer connected to the PT is printing due to touch switch operation at the PT or an instruction from the host. On completion of printing, it returns to 0 (OFF). It is also returned to 0 (OFF) even while printing is in progress if the PT displays the System Menu or an error screen. (This bit will always be OFF for the NT21.)

The PT can print the following data in the RUN mode.

- The currently displayed screen image (by touch switch operation, or operation of the screen printing bit of the PT status control bits)
- Display history record data (by pressing the Print Screen touch switch when screen number 9001 or 9002 is displayed)
- Device Monitor display screens (by pressing the print touch switch when screen number 9021, 9022, or 9023 is displayed)

Backlight Status (Bit 6)

Indicates the status of the EL screen of an NT631 or the backlight of an NT21, NT31/NT31C, or NT631C as follows:

- 1 (ON): EL screen off or backlight off
- 0 (OFF): EL screen displaying or backlight lit (flashing)

However, this bit is returned to 0 (OFF) when the PT displays the System Menu or an error screen.

Reference: Whether the backlight is lit continuously or flashes when the backlight status bit is set to 0 (OFF) is determined by the backlight mode bit (bit 8) of the PT status control bits and the Backlight screen attribute.

Global Window Open Status (Bit 5), Local Window1 Open Status (Bit 4), Local Window2 Open Status (Bit 3)

This bit is set to 1 (ON) when a corresponding window is open. It is returned to 0 (OFF) when a corresponding window is closed. (It remains 1 (ON) even if the window screen number is switched in the middle of operation.)

It is possible to know the screen number of the window that is currently open or the display position (bottom-left coordinate) by checking the window control area.

Strobes

The screen switching, numeral setting, and character string setting strobes are automatically returned to 0 (OFF) after notification to the host. The status of operations at the PT can easily be ascertained by detecting the leading edges of these strobes.

However, when connected to a CVM1/CV series CPU, if the PC is set for asynchronous operation, the leading edge may not be detected.

2-2-3 Window Control Area (Host ↔ PT)

Data is written to the window control area from both the PT and the host. The status of the window is always written.

When the data is written to this area from the host, the PT reads the data and display the window with the specified number at the designated position.

When the display status of the window (screen No., display position) is changed due to the operation at PT, current status of the window is written to the words allocated in the host. The host can determine the display status of the window by reading this area.

The window control area is configured as nine consecutive words as shown below. The first word (word k) is set in the Control/Notify Area settings in the PT configuration settings made with the Support Tool.

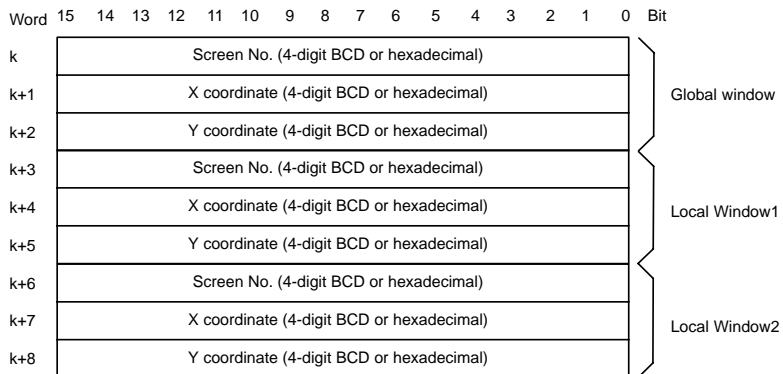

Reference: It is not necessary to allocate words in the host for window control area when the window is not controlled from the host or when the window is not used.

Words Allocated for the Window Control Area

Words can be allocated for the window control area (PT to host) in the following host (PC) data areas.

Symbol	C-series PCs	Allocation	CV-series PCs	Allocation	CS/CJ-series PCs	Allocation
None	IR Area	OK	CIO Area	OK	CIO Area	OK
H	HR Area	OK	---	---	HR Area	Not for Host Link
A	AR Area	OK	Auxiliary Area	No	Auxiliary Area	OK
L	LR Area	OK	---	---	LR Area*1	Not for Host Link

Symbol	C-series PCs	Allocation	CV-series PCs	Allocation	CS/CJ-series PCs	Allocation
T	TC Area, Timer PVs	No	Timer Area, Timer PVs	No	TC Area, Timer PVs	No
TU	---	---	---	---	TC Area, Timer Completion Flags	No
C	TC Area, Counter PVs	No	Counter Area, Counter PVs	No	TC Area, Counter PVs	No
CU	---	---	---	---	TC Area, Counter Completion Flags	No
W	---	---	---	---	WR Area	Not for Host Link
TK	---	---	---	---	Task Flags	No
D	DM Area	OK	DM Area	OK	DM Area	OK
E	EM Area ^{*2} , current bank	OK	EM Area, current bank	Not for Host Link	EM Area, current bank	Not for Host Link
E0_ to EC_	---	---	---	---	EM Area, EM banks 0 to C	Not for Host Link

*1: LR 00000 to LR 00199 are converted to CIO 01000 to CIO 01199.

*2: The EM Area is supported only by the C200HX/HG/HE (-Z)E PCs.

The Auxiliary Area of the CVM1 and CV-series PCs is allocated to system functions, and it cannot be used for purposes other than system use.

The range of each memory area differs according to the PC. Refer to *Appendix D PC Memory Maps* on page 441.

The screen numbers that can be specified are as follows:

BCD	Hexadecimal	Screen
0000	0000	No display (window closed)
0001 to 3999	0001 to 0F9F	Window screen No. 1 to 3,999

The X coordinates that can be specified are as follows:

PT	BCD	Hexadecimal	Contents
NT21 NT31/C NT631/C	0000 to 0240 0000 to 0300 0000 to 0620	0000 to 00F0 0000 to 012C 0000 to 026C	X coordinate of bottom-left corner (multiple of 20) NT21: 0 to 240 NT31/NT31C: 0 to 300 NT631/NT631C: 0 to 620

The Y coordinates that can be specified are as follows:

PT	BCD	Hexadecimal	Contents
NT21 NT31/C NT631/C	0019 to 0139 0019 to 0239 0019 to 0479	0013 to 008B 0013 to 00EF 0013 to 01DF	Y coordinate of bottom-left corner (multiple of 20 - 1) NT21: 19 to 139 NT31/NT31C: 19 to 239 NT631/NT631C: 19 to 479

- Reference:**
- Local window can be also opened, closed or moved by the operation of touch switch (page 309, 309). In addition, by setting the attribute of the screen (base screen) to be displayed, local window pops up at the same time the screen is displayed (refer to page 45).
 - Global window can be controlled only by writing to the window control area from the host.
 - Window position (coordinate) can be specified by 20 dot unit. (Y coordinate = multiple of 20-1, because of the bottom-left coordinate specification)
Window can not be controlled and the contents of the window remains unchanged when the number other than multiple of 20 is specified for X coordinate or when the number other than multiple of 20-1 is specified for Y coordinate.
However, when opening a new window, the window is displayed at the position that was specified when the window screen was created using the Support Tool.

Functions of the Window Control Area

If the PT is currently operating, the status of the window is always written to the window control area. The contents of the window control area depends on the window type (global window/local window) and the circumstances as follows:

When the Window Is Opened by Touch Switch Operation (Local Window Only)

A window screen that is set for a touch switch pops up at the position that was specified when the window was created using the Support Tool. At this time, the status of the window is written to the screen No.. X coordinate and Y coordinate of window control area (corresponding window type).

When the Window Is Closed by Touch Switch Operation (Local Window Only)

The screen No.. X coordinate and Y coordinate of window control area (corresponding window type) are all cleared to 0.

When the Window Screen No. Is Specified for Screen No. of Window Control Area

The specified window is opened as the corresponding window type. The window position follows the contents of X coordinate and Y coordinate of window control area. However, in the following cases, the window is opened at the position that was specified when the window was created using the Support Tool. (Window move operation is not performed and the X, Y coordinates return to the existing value when the incorrect X coordinate and Y coordinate are specified without changing the screen No..)

- When the contents of X coordinate is not multiple of 20, or when the contents of Y coordinate is not multiple of 20-1
- When the window will extend out of the screen with the specified value (for example, when an NT31/NT31C is being used and an X coordinate of 300 and a Y coordinate of 199 are specified for a window screen of 100 100 dots).

When 0 Is Written to the Screen No. of Window Control Area

Window of the corresponding type is closed. The contents of X coordinate and Y coordinate is retained.

When the Screen Is Switched to the Other While the Window Is Being Displayed (Other Than System Screen)

The behavior depends on the screen type as shown below. (Even when the global window and the local window were displayed before screen switching, the each screen also behaves as the table below.)

Window type	Screen No.	X coordi- nate	Y coordi- nate	Status
Global window	Retains the existing value			Remain opened
Local window	Cleared to 0			Closed (*)

* If the local window open attribute is set for the screen switched to, the local window opens.

When the Screen Is Switched to System Screen, Error Screen or System Menu, while the Window Is Being Displayed.

The behavior depends on the screen type as shown below. (Even when the global window and local window were displayed before screen switching, the each screen also behaves as the table below.)

Window type	Screen No.	X coordi- nate	Y coordi- nate	Status
Global window	Retains the existing value			Closed
Local window	Cleared to 0			Closed

If a standard screen or overlapping screens are displayed again, the same global window will be opened at the same position but the local window will not be opened.

System screens that close global window are as follows:

- System initializing screen (screen number 9000)
- Programming Console function screen (screen number 9020)
- Device Monitor function screen (screen number 9021, 9022, or 9023)

With Occurrence history screen (screen number 9001) and frequency history screen (screen number 9002) global window remains opened.

Data is written to the window control area from both the PT and the host. The meaning of the data differs according to whether it is written from the PT or the host.

When the Data Is Written from the Host

To switch, open, close or move a window on the PT by an instruction from the host, write the window screen number or coordinates to the window No.. X coordinate or Y coordinate as 4-digits BCD or hexadecimal. Whether the values are BCD or hexadecimal is determined by the setting for numeral storage type in the PT configuration settings made with the Support Tool.

By changing the screen No.. window can be switched, opened or closed.

It is possible to move the window position by changing the X coordinate and Y coordinate.

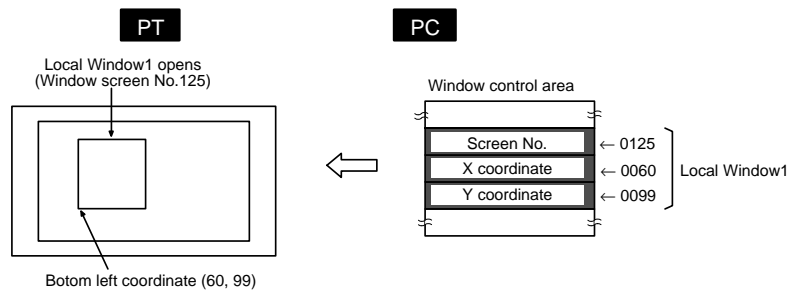

Screen No.. X Coordinate and Y Coordinate of the Window Control Area

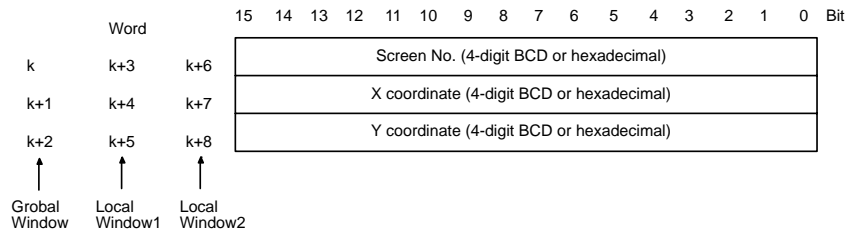

When the Data Is Written from the PT

When the display status of the window is changed by the operation at PT, new window screen No. or coordinates is written to the window No.. X coordinate or Y coordinate as 4-digits BCD or hexadecimal from the PT. When the window is opened or closed, window open/close status is written to the window open status (page 313) of PT status in PT notify area.

Whether the values are BCD or hexadecimal is determined by the setting for numeral storage type in the PT configuration settings made with the Support Tool.

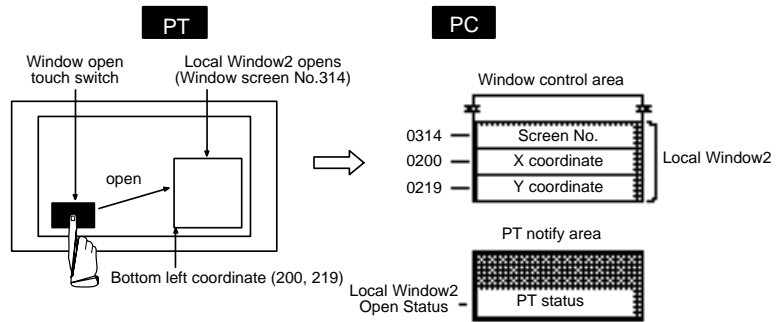

2-2-4 Clock Data Area (Host to PT, NT21 Only)

The NT21 has a clock function that displays the date and time, but the data is periodically read from the host. The PT clock data can be updated by updating the contents of this area from the host.

The clock data area consists of 4 continuous words, as shown below. The first word, j, is set under the Set Clock Address settings made with the Support Tool.

Word	15	14	13	12	11	10	9	8	7	6	5	4	3	2	1	0	Bit
j	Minutes (2-digit BCD)						Seconds (2-digit BCD)										
j + 1	Day of month (2-digit BCD)						Hour (2-digit BCD)										
j + 2	Year (2-digit BCD)						Month (2-digit BCD)										
j + 3	Always 00						Day of week (2-digit BCD)										

Reference: It is not necessary to allocate words in the host for the clock data area when the clock data is not displayed or the screen display/alarm history is not used.

Words Allocated for the Clock Data Area

Words can be allocated for the clock data area (host to PT) in the following host (PC) areas.

Symbol	C-series PCs	Allocation	CV-series PCs	Allocation	CS/CJ-series PCs	Allocation
None	IR Area	OK	CIO Area	OK	CIO Area	OK
H	HR Area	OK	---	---	HR Area	Not for Host Link
A	AR Area	OK	Auxiliary Area	No	AR Area	OK
L	LR Area	OK	---	---	LR Area*1	Not for Host Link
T	TC Area, Timer PVs	No	Timer Area, Timer PVs	No	TC Area, Timer PVs	No
TU	---	---	---	---	TC area, Timer Completion Flags	No
C	TC Area, Counter PVs	No	Counter Area, Counter PVs	No	TC Area, Counter PVs	No
CU	---	---	---	---	TC Area, Counter Completion Flags	No
W	---	---	---	---	WR Area	Not for Host Link
TK	---	---	---	---	Task Flags	No
D	DM Area	OK	DM Area	OK	DM Area	OK
E	EM Area *2, current bank	OK	EM Area, current bank	Not for Host Link	EM Area, current bank	Not for Host Link
E0_ to EC_	---	---	---	---	EM Area, EM banks 0 to C	Not for Host Link

*1: LR 00000 to LR 00199 are converted to CIO 01000 to CIO 01199.

*2: The EM Area is supported only by the C200HX/HG/HE(-Z)E PCs.

The Auxiliary Area of the CVM1 and CV-series PCs is allocated to system functions, and cannot be used for purposes other than system use.

The range of each memory area differs according to the PC. Refer to *Appendix D PC Memory Maps* on page 441.

The clock data that can be specified is listed in the following table.

Item	Data (BCD)	Remarks
Seconds	00 to 59	
Minutes	00 to 59	
Hour	00 to 23	24-hour time
Day of month	01 to 31	
Month	01 to 12	
Year	00 to 99	Rightmost two digits of year
Day of week	00 to 06	See following table.

Days of the week are expressed as follows:

Day	Sunday	Monday	Tuesday	Wednesday	Thursday	Friday	Saturday
Value	00	01	02	03	04	05	06

-
- Reference:**
- The NT21's clock function is not a counter. This function just displays the most recent clock data read from the host.
 - After the NT21 is turned ON, the default date and time (01/01/00 00:00:00) will be displayed if the data in the PT is not correct until the clock data is read properly from the host.
 - The clock function does not strictly check the date and day of the week settings. The data must therefore be set correctly so that there is no discrepancy between the date and the day of a week
 - The clock data cannot be set from the NT21's System Menu or the NT Support Tool.
 - The clock data is always BCD regardless of the setting of the Storage Type setting made in the PT configuration settings from the Support Tool.
-

Clock Data Area Functions

The PT periodically reads the contents of the Clock Data Area to update the clock data in the PT.

The structure of the clock data in the PT is the same as the structure of the words containing the clock data in the CS/CJ-series and C-series PCs. If these words are allocated for the Clock Data Area with the NT21, then the clock data will be automatically synchronized during operation if the words are allocated.

If the structure of the clock data in the host is not the same as the structure in the PT (or the words containing the clock data in the host cannot be allocated), use the ladder program to update the Clock Data Area periodically, e.g., by copying the contents of the PC's clock data to the Clock Data Area.

-
- Reference:** Numeral memory table entries 247 to 253 are reserved for the clock function (read-only) and the clock data is automatically stored in them. Refer to *3-10 Display and Setting of Calendar Clock* for the methods used to display the date or time.
-

2-3 Memory Tables

The PT has the following three types of memory area that can be written to freely from the host.

- Numeral memory table for numeric value data Page 72
- Character string memory table for text data Page 79
- Bit memory table for bit data Page 83

The contents of numeral/character string memory table entries can be displayed for individual memory table entries at the Support Tool, and set in table editing.

Reference: In addition to the memory tables listed above, there is a mathematical table in which a calculation formulas can be registered. For details, refer to *2-18 Mathematical Function* (page 279).

2-3-1 Numeral Memory Table

Function Outline

Numeral memory table is contained in internal memory of the PT for recording numeric value data.

Since words can be allocated in the host for numeral table entries, the contents of host words can be displayed as numeric values at the PT via the numeral memory table.

Numeral memory table entries are assigned numeral memory table entry numbers so that they can be managed and designated individually.

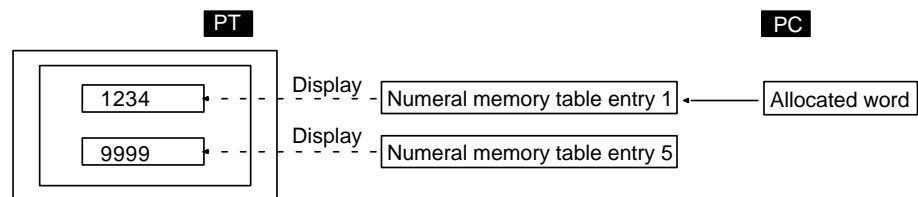

Restrictions

- The number of numeral memory table entries can be set as one of the following in the System settings in the PT configuration settings made at the Support Tool.
 - 512 (numeral memory table entry numbers 0 to 511)
 - 1000 (numeral memory table entry numbers 0 to 999)
 - 2000 (numeral memory table entry numbers 0 to 1999)

Since the numeral memory table shares memory with the screen data, setting a large number of numeral memory table entries reduces the memory area available for screen data.

- The data quantity of one numeral memory table entry can be set to either of the following by setting at the Support Tool.
 - 1 word (2 bytes)/2 words (4 bytes)
- Since numeral memory table entry numbers 1000 and higher are not backed up by the battery, they return to the initial values set with the Support Tool when the power to the PT is turned ON, when the PT is reset, and on transition from the System Menu to the RUN mode, regardless of the setting made for the resume function.
- Numeral memory table entry numbers 247 to 255 are used with the clock function of the PT. These table entries cannot be used for other applications. For details on the clock function, refer to *2-16-6 Clock Function* (page 251).

Common Attributes

Numeral memory table entries have the following properties.

Property	Possible Settings
	Meaning
Value	<ul style="list-style-type: none"> · For BCD format: –9999999 to 99999999 · For binary format: –2147483648 (80000000H) to 2147483647 (7FFFFFFH)
	<p>The initial values that can be set as the contents of memory table entries by the Support Tool The format is determined by the system memory of the PT and the Numeral Storage Type setting. For details, refer to <i>Storage type and stored data</i> (page 74).</p>
Initial	Check mark (initialize)/No check mark (do not initialize)
	<p>This setting determines whether or not the allocated words at the host are initialized when the power to the PT is turned ON, when the PT is reset, and on transition from the System Menu to the RUN mode. Initialization here means initialization of the allocated words at the host: when a check mark is set, the previously existing numeral memory table contents are written to the host words. When no check mark is set, the data at the host is read and set in the numeral memory table entries.</p>
Storage Type	System/Binary/BCD
	<p>Method for storing numeric data in numeral memory table entries. This setting is valid only when a word is allocate for the numeral table entry in the host. Numeral memory table entries that are not allocated words in the host always use binary format. If a setting is made for System. it complied with the Numeral Storage Type setting of PT configuration. For details, refer to <i>Storage type and stored data</i> (page 74).</p>
Words	0/1/2
	<p>The number of words allocated in the host for the numeral memory table entry. For details, refer to <i>Allocated words</i> (page 73).</p>
PC Address	Any word address at the host
	<p>Word at the host allocated for the numeral memory table entry. When two words are allocated for the numeral memory table entry, designate the first (lower) word. For details, refer to <i>Allocated words</i> (page 73).</p>
I/O Comment	Up to 16 characters of text
	Comment that describes the contents of a numeral memory table entry

Allocated Words

Either one or two words can be allocated at the host for each numeral memory entry. Words can be allocated in the following host (PC) areas.

Symbol	C-series PCs	Allocation	CV-series PCs	Allocation	CS/CJ-series PCs	Allocation
None	IR Area	OK	CIO Area	OK	CIO Area	OK
H	HR Area	OK	---	---	HR Area	Not for Host Link
A	AR Area	OK	Auxiliary Area	No	AR Area	OK
L	LR Area	OK	---	---	LR Area*1	Not for Host Link
T	TC Area, Timer PVs	1-word entries only	Timer Area, Timer PVs	1-word entries only	TC Area, Timer PVs	1-word entries only

Symbol	C-series PCs	Allocation	CV-series PCs	Allocation	CS/CJ-series PCs	Allocation
TU	---	---	---	---	TC Area, Timer Completion Flags	No
C	TC Area, Counter PVs	1-word en- tries only	Counter Area, Counter PVs	Not for Host Link	TC Area, Counter PVs	1-word en- tries only
CU	---	---	---	---	TC Area, Counter Completion Flags	No
W	---	---	---	---	WR Area	Not for Host Link
TK	---	---	---	---	Task Flags	No
D	DM Area	OK	DM Area	OK	DM Area	OK
E	EM Area *2, current bank	OK	EM Area, current bank	Not for Host Link	EM Area, current bank	Not for Host Link
E0_ to EC_	---	---	---	---	EM Area, EM banks 0 to C	Not for Host Link

*1: LR 00000 to LR 00199 are converted to CIO 01000 to CIO 01199.

*2: The EM Area is supported only by the C200HX/HG/HE(-Z)E PCs.

The Auxiliary Area of the CVM1 and CV-series PCs is allocated to system functions, and it cannot be used for purposes other than system use.

The range of each memory area differs according to the PC. Refer to *Appendix D PC Memory Map* on page 441.

The relationships among the allocated words, the number of allocated words, and the contents of numeral memory table entry are indicated in the figure below.

When the Number of Allocated Words Is 1 Word

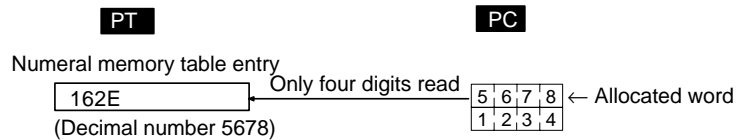

When the Number of Allocated Words Is Two Words

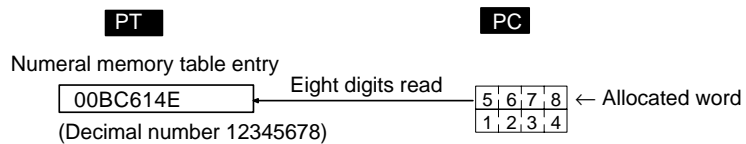

Storage Type and Stored Data

A numeral memory table entry internally stores the specified number of words of data as signed binary data. When the contents of words allocated in the host are stored in a memory table entry, the numeric value is interpreted according to the Storage Type setting and is stored after conversion to signed binary data. Also, the signed binary data in numeral memory table entries is written to the words allocated in the host according to the Storage Type setting.

Accordingly, different Storage Type settings will cause the same data to be recognized by the PT as different values and written to the host as different values.

Reference: Signed binary data expresses negative values as the complement of two (the bits are inverted and 1 is added).

- Storage Type For The BCD Format

When using BCD format, the contents of the word(s) at the host are interpreted as BCD (binary coded decimal) data. However, since it is not possible to input a negative sign in a host word, the letter F at the most significant digit is used instead to denote negative values (a negative sign can be used in the setting for Value. so negative values can be input in the normal manner for this setting).

If a value with a letter from A to E inclusive as its most significant digit, or a value with a letter from A to F inclusive at any position other than the most significant digit is stored in a host word, it is invalidated as illegal data and the existing value is retained.

If the contents of a numeral memory table entry exceeds the range that can be handled by the allocated words in the host, the value is written to the host as negative sign + less significant digits (see below).

Contents of numeral memory table entry (decimal notation)		Data at host	Conditions
12345	→	2345	1 allocated word When using BCD format
-12345	→	F345	
123456789	→	23456789	2 allocated words When using BCD format
-12345678	→	F2345678	

- Storage Type For Binary Format

When binary format is used, the initial value and contents of the host word(s) are interpreted as signed binary data and are stored without change in the numeral memory table entry.

With binary format, the most significant bit is the sign bit (when this bit is 1 it indicates a negative value). When there is one allocated word, the most significant bit is bit 15; when there are two allocated words it is bit 31.

The initial value is always expressed as a 2-word signed binary value regardless of the Storage Type setting.

However, when the initial value is input using the Support Tool, the basis for input is always the decimal system. The – symbol can be input to indicate a negative value. If \$ is input at the head of the input value, it will be input as a hexadecimal value (after confirmation of input, it is displayed in decimal).

Data Flow and Stored Data

The table below indicates how the set Value (initial value) and the contents of host words are stored in numeral memory table entries. (The examples show initial values that are set with the Support Tool and written to the host when the Resume function is not being used.)

Support Tool values		Stored value before operation	Storage Type	Number of Words	Contents of host words	Stored value after start of operation	Stored Value in decimal
Input Value (before confirmation)	Input Value (after confirmation)						
---	1	2	---	---	3	4	
123,456	123,456	0001 E240	BCD	1	3456	0000 0D80	3,456
				2	0012 3456	0001 E240	123,456
\$1E240	Binary		1	E240	FFFF E240	-7,616	
			2	0001 E240	0001 E240	123,456	
-123,456	-123,456	FFFE 1DC0	BCD	1	F456	FFFF FE38	-1,456
				2	F012 3456	FFFE 1DC0	-123,456
\$FFFE 1DC0	Binary		1	1DC0	0000 1DC0	7,616	
			2	FFFE 1DC0	FFFE 1DC0	-123,456	

Support Tool values		Stored value before operation	Storage Type	Number of Words	Contents of host words	Stored value after start of operation	Stored Value in decimal
Input Value (before confirmation)	Input Value (after confirmation)						
---	1	2	---	---	3	4	
61,441	61,441	0000 F001	BCD	1	1441	0000 05A1	1,441
				2	61441	0000 F001	61,441
\$F001			Binary	1	F001	FFFF F001	-4,095
				2	0000 F001	0000 F001	61,441
65535	65,535	0000 FFFF	BCD	1	5535	0000 159F	5,535
				2	0006 5535	0000 FFFF	65,535
\$FFFF			Binary	1	FFFF	FFFF FFFF	-1
				2	0000 FFFF	0000 FFFF	65,535
-1	-1	FFFF FFFF	BCD	1	F001	FFFF FFFF	-1
				2	F000 0001	FFFF FFFF	-1
\$FFFF FFFF			Binary	1	FFFF	FFFF FFFF	-1
				2	FFFF FFFF	FFFF FFFF	-1

Numeral Table Memory Data before Start of Operation

- 1, 2, 3...**
1. Initial value inputs at the Support Tool are written into the numeral memory table entries as 2-word signed binary data regardless of the Storage Type or Number of Words settings. (Even when the value is written in hexadecimal with the \$ prefix, it will be displayed in decimal at the Support Tool after the input is confirmed.)
 2. Before operation starts, the contents of the numeral memory table entries are retained within the PT as 2-word signed binary data regardless of the Storage Type or Number of Words settings.

Numeral Table Memory Data at the Start of Operation

3. When operation is started, the contents of numeral memory table entries are written to words in the host first. At this point, data is converted and written as described below according to the Storage Type or Number of Words settings.

Storage Type	Number of words	Conversion and storage
BCD	1	The 2-word signed binary data is converted to BCD and the least significant 4 digits are written. If the value is negative, F and the least significant 3 digits are written.
BCD	2	The 2-word signed binary data is converted to BCD and the 8 digits are written. If the value is negative, F and the least significant 7 digits are written.
Binary	1	The least significant 4 digits of the 2-word signed binary data are written as is.
Binary	2	The 2-word signed binary data is written as is.

4. After operation has started, the host words are read and the data is regularly mirrored in the numeral memory table entries. The data is converted and

written as described below according to the Storage Type or Number of Words settings.

Storage Type	Number of words	Conversion and storage
BCD	1	The contents of the host words are treated as 4-digit BCD, converted to 2-word signed binary data, and stored. (If the most significant digit is F, the remaining data is treated as negative 3-digit BCD.) Words that do not contain 4-digit BCD or F and 3 BCD digits are invalid and the numeral memory table entries will be left unchanged.
BCD	2	The contents of the host words are treated as 8-digit BCD, converted to 2-word signed binary data, and stored. (If the most significant digit is F, the remaining data is treated as negative 7-digit BCD.) Two-word fields that do not contain 8-digit BCD or F and 7 BCD digits, are invalid and the numeral memory table entries will be left unchanged.
Binary	1	The contents of the host words are treated as signed binary data (a sign bit and 15 data bits), converted to 2-word signed binary data, and stored.
Binary	2	The contents of the host words are treated as signed binary data (a sign bit and 31 data bits) and stored as is.

Resume Function and Initial Values

When the resume function is not used, the preset initial values are written in the numeral memory table entries when the power to the PT is turned ON, the PT is reset, or the PT is switched to RUN mode from the System Menu. (See Initialize below.)

Use the resume function to prevent initialization and retain the last values that were in place before operation stopped.

Resume function setting	Numeral memory table contents
Yes	The previous numeral memory table values are used.
No	The numeral memory table's initial values are used.

The System Menu's initialize operation can be used to write the initial values to the memory table entries regardless of the resume function setting. When the resume function is used, the previous values will be used even if the initial values are changed, so changes to the initial values won't be reflected in the table entries. Initialize the memory table values before starting operation to reflect changes in initial values.

With the NT21, the resume function can be used only if the optional Battery is used. Without the Battery, the resume function will not operate even if the function is set to Yes.

Initialize

The initialize setting determines whether the contents of numeral memory table entries are written to the allocated word(s) in the host when the power to the PT is turned ON, when the PT is reset, or the PT is switched to RUN mode from the System Menu.

Here, initialize means the initialization of the contents of host word(s) as they are overwritten by the contents of the numeral memory table. If a word is not allocated for the numeral memory table entry in the host, this setting has no effect.

Reference: When the PT starts operation, the contents of numeral memory table entries is as follows depending on whether or not a word is allocated for the numeral memory table entry in the host, on the Initial setting for the numeral memory table entry, and on whether or not the resume function is used:

Word allocated in host?	Initial setting	Resume function	
		Used (Battery must be present.)	Not used
Yes	Checked	Existing numeral memory table value retained (at host word(s) also)	Initial value of numeral memory table entry used (at host word(s) also)
		When the numeral memory table is initialized by System Menu operation: initial value of the numeral memory table entry (at host word(s) also)	
	Not checked	Contents of host word(s)	
No	(Ineffective)	Existing numeral memory table value	Initial value of numeral memory table entry
		When the numeral memory table is initialized by System Menu operation: initial value of the numeral memory table entry	

Display Functions

Numeral memory table entries themselves have no display function.

To display the contents of numeral memory table entries, use *2-8 Numeral Display* (page 140) or *2-10 Graphs* (page 154). Specify numeral memory table entries when displaying numeral displays as guide characters of lamps or touch switches as well.

Input Functions

When one or two words are allocated in the host for numeral memory table entries, the contents of the words is read and stored.

However, reading is only executed for those numeral memory table entries that are being used for the currently displayed screen (when copying a memory table entry, the contents of the allocated word(s) of the copy source memory table entry is read) or specified as operands in the mathematical function.

Output Functions

When one or two words are allocated in the host for a numeral memory table entry, the contents of the numeral memory table is written to the word(s).

However, writing is only executed in the following cases.

- When the contents of the numeral memory table entry has changed as a result of operations at the PT, such as memory table entry copying by touch switch operation, or use of the numeral setting function
- When the Initial setting at the Support Tool is checked when the power to the PT is turned ON, the PT is reset, or on transition from the System Menu to the RUN mode (the contents of all numeral memory table entries that are allocated words in the host and whose initial setting is checked are written)
- When using words allocated for the numeral memory table entry in the host as destinations for the calculation results of the mathematical function

Processing Functions

The contents of word(s) allocated in the host are interpreted and stored in accordance with the attributes that have been set (refer to *Common Attributes* on page 73). Data is converted according to the preset attributes even when the contents of numeral memory table entries changed with PT operations are being written to words in the host.

Relationship with Other Elements

- When numeral display is used, the contents of numeral memory table entries can be displayed in real time as numeric values (page 140).

- When a bar graph is used, the contents of a numeral memory table entry can be displayed in real time in bar graph form (page 154).
- When an analogue meter is used, the contents of a numeral memory table entry can be displayed in real time in the form of quarter, semi-circle or circle-shaped graph.
- When a broken line graph is used, the contents of multiple, consecutive numeral memory table entries can be displayed in real time in the form of a broken line graph (page 164).
- When a trend graph is used, changes over time in the contents of a numeral memory table entry can be displayed in the form of a broken line graph (page 171).
- When a lamp's guide character is made into a numeral display, the contents of a numeral memory table entry can be displayed numerically in real-time (page 112).
- When a touch switch's guide character is made into a numeral display, the contents of a numeral memory table entry can be displayed numerically in real-time (page 119).
- When a numeral setting is used, numeric values can be input into the numeral memory table entry from the screen of the PT (page 192).
- When a thumbwheel switch is used, numerical values can be input into the numeral memory table entry from the screen of the PT (page 200).
- When the touch switch copy setting function is used, the contents of a numeral memory table entry can be copied, and constants can be input to the numeral memory table entry (page 135).
- By operation of the PT status control area, data can be copied between memory table entries from the host (page 52).
- If the contents of numeral memory table entries are changed by operation at the PT, the change is notified to the PT status notify area (page 61).
- A numeral memory table entry can be specified as the location of operands used by the mathematical function or the destination of calculation results (page 279).

2-3-2 Character String Memory Table

Function Outline

Character string memory table entries are internal memories of the PT for recording character string data.

Since words can be allocated for character string memory table entries in the host, the contents of words at the host can be displayed as character strings at the PT via the character string memory table.

Character string memory table entries are assigned character string memory table entry numbers so that they can be managed and designated individually.

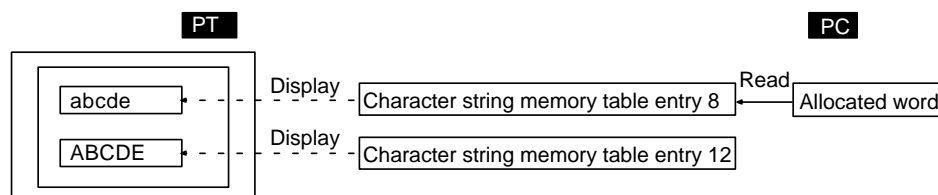

Restrictions

- The number of character string memory table entries can be set as one of the following at the Support Tool.
 - 256 (character string memory table entry numbers 0 to 255)
 - 1000 (character string memory table entry numbers 0 to 999)

- 2000 (character string memory table entry numbers 0 to 1999)

Since the character string memory table shares memory with the screen data, setting a large number of character string memory table entries reduces the memory area available for screen data.

- The data quantity of one character string memory table entry can be set as follows by setting at the Support Tool (a setting of 0 indicates no allocation):
0 to 40 characters (= 0 to 40 bytes, which is 0 to 20 words)
- Character string memory table entry numbers 500 and higher always remain at the initial value set with the Support Tool. These values cannot be changed later and can only be read. Words cannot be allocated for these table entries in the host either.
- The characters that can be stored in character string memory table entries are alphanumerics, symbols, and marks (codes FF20 to FFFFH).

- Reference:**
- If 00H (NULL code) is encountered in a character string, the subsequent data is ignored.
 - If codes outside the ranges indicated above are written to the allocated words at the host, the character strings may not be displayed correctly.
 - When the PT is set to NT20S and NT30/NT620 compatible mode, image and library codes can be included in the character strings. Refer to *Appendix C* for details on the NT20S and NT30/620 compatible modes.

Common Attributes

Character string memory table entries have the following properties.

Property	Possible Settings
	Meaning
Value	Alphanumerics and symbols, Marks
	Character string in the initial status after the contents of the character string memory table have been initialized.
Initial	Check mark (initialize)/No check mark (do not initialize)
	This setting determines whether or not the allocated words at the host are initialized when the power to the PT is turned ON, when the PT is reset, and on transition from the System Menu to the RUN mode. Initialization here means initialization of the allocated words at the host: when a check mark is set, the previous character string memory table contents is written to the host words. When no check mark is set, the data at the host is read and set in the character string memory table entries.
PC Address	Any word address at the host
	Host word(s) allocated for the character string memory table entry. Designate the first (lower) word. For details, refer to <i>Allocated words</i> (page 80).
Words	1 to 20
	The number of words allocated in the host for the character string memory table entry. For details, refer to <i>Allocated words</i> (page 80).
I/O Comment	Up to 16 characters of text
	Comment that describes the contents of a character string memory table entry

Allocated Words

One to twenty words can be allocated at the host to each character string table entry. Words can be allocated in the following host (PC) areas.

Symbol	C-series PCs	Allocation	CV-series PCs	Allocation	CS/CJ-series PCs	Allocation
None	IR Area	OK	CIO Area	OK	CIO Area	OK
H	HR Area	OK	---	---	HR Area	Not for Host Link
A	AR Area	OK	Auxiliary Area	No	AR Area	OK
L	LR Area	OK	---	---	LR Area*1	Not for Host Link
T	TC Area, Timer PVs	No	Timer Area, Timer PVs	No	TC Area, Timer PVs	No
TU	---	---	---	---	TC Area, Timer Completion Flags	No
C	TC Area, Counter PVs	No	Counter Area, Counter PVs	No	TC Area, Counter PVs	No
CU	---	---	---	---	TC Area, Counter Completion Flags	No
W	---	---	---	---	WR Area	Not for Host Link
TK	---	---	---	---	Task Flags	No
D	DM Area	OK	DM Area	OK	DM Area	OK
E	EM Area *2, current bank	OK	EM Area, current bank	Not for Host Link	EM Area, current bank	Not for Host Link
E0_ to EC_	---	---	---	---	EM Area, EM banks 0 to C	Not for Host Link

*1: LR 0000 to LR 00199 are converted to CIO 01000 to CIO 01199.

*2: The EM Area is supported only by the C200HX/HG/HE(-Z)E PCs.

The Auxiliary Area of the CVM1 and CV-series PCs is allocated to system functions, and it cannot be used for purposes other than system use.

The range of each memory area differs according to the PC. Refer to *Appendix D PC Memory Maps* on page 441.

The relationships among the allocated words, the number of allocated words, and the contents of character string memory table entries are indicated in the figure below.

Example: Number of allocated words = 4 words

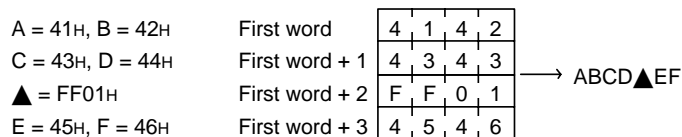

Resume Function and Initial Values

When the resume function is not used, the preset initial values are written in the character string memory table entries when the power to the PT is turned ON, the PT is reset, or the PT is switched to RUN mode from the System Menu. (See Initialize below.)

Use the resume function to prevent initialization and retain the last values that were in place before operation stopped.

Resume setting	Character string memory table contents
Yes	The previous character string memory table values are used.
No	The character string memory table entry's initial values are used.

The System Menu's initialize operation can be used to write the initial values to the memory table entries regardless of the resume function setting. When the resume function is used, the previous values will be used even if the initial values are changed, so changes to the initial values won't be reflected in the table entries. Initialize the memory table values before starting operation to reflect changes in initial values.

With the NT21, the resume function can be used only if the optional Battery is used. Without the Battery, the resume function will not operate even if the function is set to Yes.

Initialize

The initialize setting determines whether the contents of character string memory table entries are written to the allocated word(s) in the host when the power to the PT is turned ON, when the PT is reset, or the PT is switched to RUN mode from the System Menu.

Here, initialize means the initialization of the contents of host word(s) as they are overwritten by the contents of the numeral memory table entry. If no words are allocated for the character string memory table entry in the host, this setting has no effect.

Reference: When the PT starts operation, the contents of character string memory table entries are as follows depending on whether or not the character string memory table entry is allocated words in the host, on the initial setting for the character string memory table entry, and on whether or not the resume function is used:

Words allocated at host?	Initial Setting	Resume Function	
		Used (Battery must be present.)	Not Used
Yes	Checked	Existing character string memory table value retained (at host word(s) also)	Initial value of character string memory table entry used (at host word(s) also)
		When the character string memory table is initialized by System Menu operation: initial value of the character string memory table entry (at host word(s) also)	
	Not checked	Contents of host word(s)	
No	(Ineffective)	Existing character string memory table value	Initial value of character string memory table entry
		When the character string memory table is initialized by System Menu operation: initial value of the character string memory table entry	

Display Functions

Character string memory table entries themselves have no display function.

To display the contents of character string memory table entries, use *2-9 Character String Display* (page 148).

Character strings can also be displayed as messages by using the alarm list (page 182) and alarm history (page 182) functions.

Specify character string memory table entries when displaying character string displays as guide characters of lamps or touch switches as well.

Input Functions

When one or more words are allocated for a character string memory table entry in the host, the contents of the words is read and stored.

However, reading is only executed for those character string memory table entries that are being used for the currently displayed screen (when copying a character string memory table entry, the contents of the allocated word(s) of the copy source memory table entry is read).

Output Functions

When one or more words are allocated for a character string memory table entry at the host, the contents of the character string memory table entry are written to the word(s).

However, writing is only executed in the following cases.

- When the contents of the character string memory table entry have changed as a result of operations at the PT, such as memory table copying by touch switch operation, or use of the character string input function
- When the Initial setting of string table entry is checked when the power to the PT is turned ON, the PT is reset, or on transition from the System Menu to the RUN mode (the contents of all words allocated for character string memory table entries in the host and whose initial setting is checked are written.)

Processing Functions

Character string memory table entries have no data processing function.

Relationship with Other Elements

- When character string display is used, the contents of character string memory table entries can be displayed in real time as character strings (page 148).
- When alarm list or alarm history is used, the contents of the character string memory table entry can be displayed as a message (page 182).
- When a lamp's guide character is made into a character string display, the contents of a character string memory table entry can be displayed as guide characters in real-time (page 112).
- When a touch switch's guide character is made into a character string display, the contents of a numeral memory table entry can be displayed as guide characters in real-time (page 119).
- When character string input is used, character strings can be input into the character string memory table entry from the screen of the PT (page 210). It is also possible to input character strings from a bar code reader connected to the PT.
- When the touch switch copy setting function is used, the contents of a character string memory table entry can be copied (page 135).
- By operation of the PT status control area, data can be copied between memory table entries from the host (page 52).
- If the contents of character string memory table entries are changed by operation at the PT, the change is notified to the PT status notify area (page 61).

2-3-3 Bit Memory Table**Function Outline**

The bit memory table is held in memory for bit data.

Bits are allocated to bit memory table entries in the host, and the status of the bit is monitored so that a specific function can be executed in accordance with the status of the bit.

Bit memory table entries are assigned bit memory table entry numbers so that they can be managed and designated individually.

Bit memory table entries have the following functions.

Screen Changeover Function

When the host bit allocated for a bit memory table entry changes status from 0 (OFF) to 1 (ON), the screen whose screen number is set in the bit memory table entry is displayed.

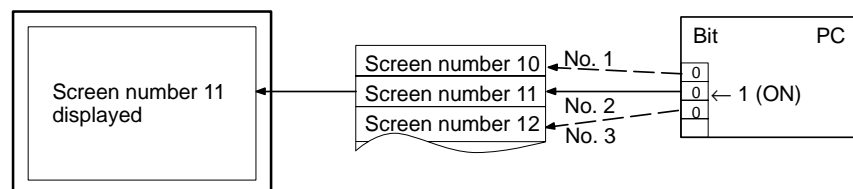

If the allocated bits of multiple bit memory table entries come ON at the same time, the bit memory table entry with the smallest number takes priority.

Alarm List/History Function

When the status of the host bit allocated for a bit memory table entry changes to 1 (ON), the contents of the character string memory table entry (message), and the image/library data set for that bit memory table entry are displayed (this is the alarm list function). In order to use the alarm list function, it must be registered for the screen in advance. If more than one bit memory table entry is set for the alarm list function, those with smaller bit memory table entry numbers are given display priority, therefore it is possible to assign an order or priority to displayed messages.

If registration in the alarm history is designated, the time when the status of the host bit allocated for the bit memory table entry changes to 1 (ON) is recorded in the alarm history (alarm history function).

For details, refer to 2-11 Alarm List, Alarm History (page 182).

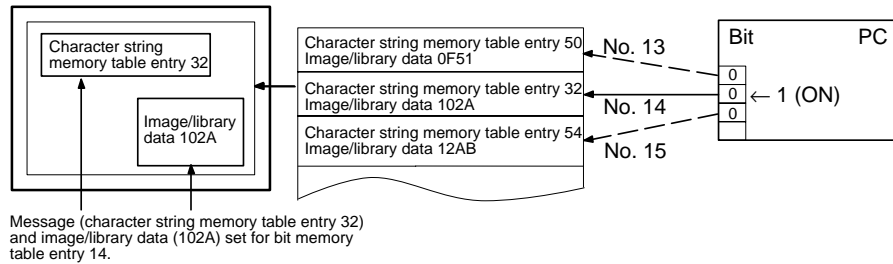

Operation when Using the Alarm List/History Function

The operation when using the alarm list/history function is as follows:

- Reference:**
- For the alarm list function, display is in ascending order of bit memory table entry numbers. For the alarm history function display is in occurrence order (from newest record/from oldest record) or frequency order.
 - With the alarm list function, when the host bit allocated for the bit memory table entry returns to 0 (OFF) during display, the message and image/library data is automatically cleared.

- 1, 2, 3...**
1. When the status of a bit memory table entry changes to 1 (ON), the contents of the set character string memory table entry are displayed as a message.

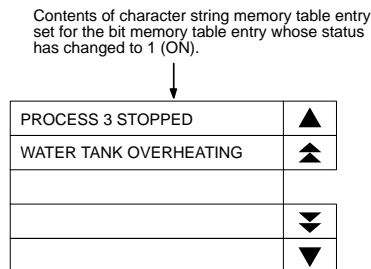

If an alarm list with multiple lines is created, alarms are displayed in ascending order of bit memory table entry numbers. If the bit memory table entries are set in ascending order of priority, the display will also be arranged in accordance with the order of priority.

- Each message area is a touch switch and pressing a message displays the set image/library data. At the same time, the pressed message is displayed in reverse video.

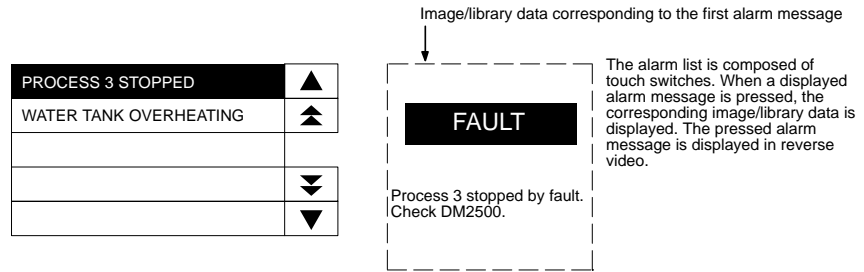

- In case multiple messages are displayed, pressing another message will cause the newly pressed one to be displayed in reverse video, and the corresponding image/library data will be displayed.

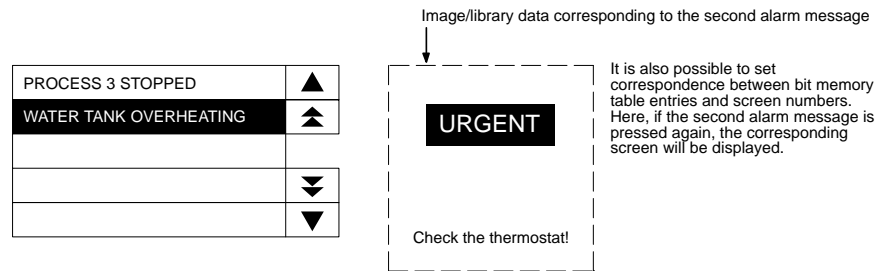

- When a message displayed in reverse video is pressed again, the display will switch to the screen with the set screen number.

Reference:

- In the case described above, both image/library display and screen changeover functions are set. The operation when a touch switch is pressed is determined as follows in accordance with these settings:

Image/library display	Screen changeover	Touch switch	
		First time	Second time
Not set	Not set	No effect	No effect
Not set	Set	Screen changeover	–
Set	Not set	Image/library data display	No effect
Set	Set	Image/library data display	Screen changeover

- Note that the text will be invisible when the message is pressed, if the color of message display (color of bit memory table entry) and the background color in reverse video of alarm list/history are the same.

Restrictions

The number of bit memory table entries can be set as one of the following at the Support Tool.

- 256 (bit memory table entry numbers 0 to 255)
- 1000 (bit memory table entry numbers 0 to 999)

Since the bit memory table shares memory with the screen data, setting a large number of bit memory table entries reduces the memory area available for screen data.

Common Attributes

Bit memory table entries have the following common properties.

Property	Possible Settings
	Meaning
Function	None/Switch screen/Alarm
	Function of the bit memory table entry When None is set, nothing will happen even if the host bit allocated for the table entry turns ON.
Description	
	Indicates the settings particular to each function.
PC Address	Any bit address at the host
	Host bit allocated for the bit memory table entry
I/O Comment	Up to 16 characters of text
	Comment that describes the meaning of a bit memory table entry

Allocated Bits

Bits can be allocated for bit memory table entries in the following host (PC) areas.

Symbol	C-series PCs	Allocation	CV-series PCs	Allocation	CS/CJ-series PCs	Allocation
None	IR Area	OK	CIO Area	OK	CIO Area	OK
H	HR Area	OK	---	---	HR Area	Not for Host Link
A	AR Area	OK	Auxiliary Area	No	AR Area	OK
L	LR Area	OK	---	---	LR Area *1	Not for Host Link
T	TC Area, Timer PVs	No	Timer Area, Timer PVs	No	TC Area, Timer PVs	No
TU	---	---	---	---	TC Area, Timer Completion Flags	Not for Host Link
C	TC Area, Counter PVs	No	Counter Area, Counter PVs	No	TC Area, Counter PVs	No
CU	---	---	---	---	TC Area, Counter Completion Flags	Not for Host Link
W	---	---	---	---	WR Area	Not for Host Link
TK	---	---	---	---	Task Flags	Not for Host Link
D	DM Area	OK	DM Area	OK	DM Area	OK
E	EM Area *2, current bank	OK	EM Area, current bank	Not for Host Link	EM Area, current bank	Not for Host Link
E0_ to EC_	---	---	---	---	EM Area, EM banks 0 to C	Not for Host Link

*1: LR 00000 to LR 00199 are converted to CIO 01000 to CIO 01199.

*2: The EM Area is supported only by the C200HX/HG/HE(-Z)E PCs.

The Auxiliary Area of the CVM1 and CV-series PCs is allocated to system functions, and it cannot be used for purposes other than system use.

The range of each memory area differs according to the PC. Refer to *Appendix D PC Memory Maps* on page 441.

If the data memory (DM) is designated, a bit number (00 to 15) must be specified after the word address.

Display Functions

Screen Changeover Function

When using the screen changeover function, the following attribute must be set in addition to the common attributes.

Property	Possible Settings	
	Meaning	
Screen Number	0001 to 3999:	Screen numbers 1 to 3999
	9001:	Occurrence history screen
	9002:	Frequency history screen
	9020:	Screen for Programming Console function (expansion function)
	9021 to 9023:	Screens for Device Monitor function (expansion function) (Not supported by NT21.)
	9030:	Brightness and contrast adjustment screen (Not supported by NT21.)
	9999:	Return to previous screen designation
	Number of screen displayed when bit memory table status changes to 1 (ON)	

When a bit memory table entry is used with the screen changeover function, when the status of the bit allocated for the bit memory table entry changes to 1 (ON), the display switches to the screen set for the bit memory table entry (this screen remains displayed even if the bit returns to 0 (OFF)).

- Reference:**
- The screen display can also be switched by PT status control area operation (page 299), touch switch operation (page 300), and by using the alarm list/history function (page 303).
 - To display overlapping screens, designate the screen number of the parent screen.
 - If there are no registered elements for the designated screen number, the screen does not switch.

Alarm List/History Function

When using the alarm list/history function, the following properties must be set in addition to the common attributes.

Property	Possible Settings	
	Meaning	
History	Check mark (record)/No check mark (do not record)	
	Determines whether or not an alarm history is recorded When a check mark is set, a record is logged in the alarm history when the status of the bit allocated for the bit memory table entry changes to 1 (ON).	
Switch Screen	Check mark (screen switched)/No check mark (screen not switched)	
	Determines whether or not the screen changeover function is used When a check mark is set, pressing the message (which is displayed when the status of the allocated bit to the bit memory table entry changes to 1 (ON)) twice switches the display to the designated screen.	

Property	Possible Settings	
	Meaning	
Screen No.	0001 to 3999: 9001: 9002: 9020: 9021 to 9023: 9030: 9999:	Screen numbers 1 to 3999 Occurrence history screen Frequency history screen Screen for Programming Console function (expansion function) Screens for Device Monitor function (expansion function) (Not supported by NT21.) Brightness and contrast adjustment screen (Not supported by NT21.) Return to previous screen designation
	Number of screen displayed when the message (which is displayed when the status of the bit allocated for the bit memory table entry changes to 1 (ON)) is pressed twice.	
String Table Entry	0 to 1999 (within the character string memory table range) Number of the character string memory table entry whose contents are displayed as a message in the alarm list/history when the status of the bit allocated for the bit memory table entry changes to 1 (ON).	
Image/Library Code	000H: No display (No check mark) 0001 to 0FFFH: Image data 1000 to 3FFFH: Library data Code (expressed as 4 hexadecimal digits) of the image/library data corresponding to the message displayed when the status of the bit allocated for the bit memory table entry changes to 1 (ON).	
Fore-ground Color	Black/Blue/Red/Magenta/Green/Cyan/Yellow/White Color of message text (only white or black for the NT21, NT31, and NT631)	

If the alarm list and alarm history functions are registered for a screen, messages and image/library data are displayed in accordance with the status of the bit memory table entry (refer to *Common Attributes* on page 86).

Reference: The alarm history can also be checked by pressing the Alarm History touch switch on the MAINTENANCE MODE MENU screen of the PT. For details, refer to section 6 of the *Setup Manual*.

Input Functions

When a bit is allocated in the host for the bit memory table entry, the status of the bit is read and processing is executed in accordance with the bit status.

However, reading is only executed in the following case.

When a function (screen changeover, alarm history) is set for the bit memory table entry.

Output Functions

Bit memory table entries have no output function. The contents of bit memory table entries are not written to bits at the host.

Processing Functions

Bit memory table entries have no data processing function.

Relationship with Other Elements

- When the alarm list function is used, messages and image/library data can be displayed in real time in accordance with the status of bits at the host (page 182).
- When the alarm history function is used, the time when the status of the host bit changes to 1 (ON), and the number of times it comes ON, can be displayed (page 182).

Reference: When the alarm history record area has become full, processing is carried out in accordance with the settings made for History Setting under Tools – PT Configuration – System at the Support Tool.

- Alarm (Use Ring Buffer)
If a check mark is set here, when an alarm occurs after the record area become full, the oldest record data is deleted in order to allow the new alarm history data to be stored (alarm pushup storage).
If no check mark is set, no more new alarm history data is stored after the record area becomes full.
 - Screen (Use Ring Buffer)
If a check mark is set here, when a screen for which the history property is set after the record area has become full, the oldest record data is deleted and new display history data is stored (alarm pushup storage).
If no check mark is set here, when the record area becomes full, no more new display history data is stored.
-

2-4 Fixed Displays

Fixed displays are graphics and text that are always displayed on the screen and do not change. This section gives details of fixed displays.

There are the following types of fixed display.

- Text Page 97
- Circle Page 90
- Arc Page 90
- Sector Page 90
- Polyline Page 90
- Polygon Page 90
- Rectangle Page 90
- Tiling Page 101
- Mark Page 103

Reference: The Support Tool also includes image data and library data as fixed display elements, but since these are functionally different, they are dealt with separately in this manual. For details on image and library data, refer to *2-5 Image and Library Data* (page 106).

2-4-1 Circles, Arcs, Sectors, Polylines, Polygons, Rectangles (Fixed Displays)

Function Outline

These are graphics that are always displayed. Standard, inverse, flash, and inverse flash displays are possible depending on the graphics.

Since fixed display graphics are always displayed in the order in which they were created at the Support Tool (graphics created early are overlaid by those created later), the order must be considered when creating them. However, the order of display within a fixed display graphic can be changed using the Support Tool.

Circle

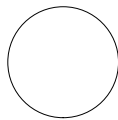

Arc

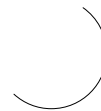

Sector

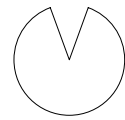

Polyline

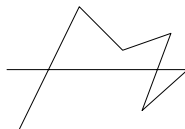

Polygon

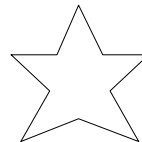

Rectangle



* A continuous straight line with up to 254 intermediate points can be drawn.

* A polygon with up to 255 vertices can be drawn.

Restrictions

- Up to 65,535 of the following graphics can be registered on one screen. (Same for window screen.) For overlapping screens comprising 8 child screens, the maximum is 524,280 (65,535 × 8 screens).

Fixed display text, circles, arcs, sectors, polylines, polygons, rectangles, tiling, marks

There is no restriction on the number of graphics that can be registered for one screen data file: any number can be registered as long as the data file capacity is not exceeded.

- One polyline can comprise up to 256 linked points including the start and end points.
- One polygon can be given up to 255 vertices.
- Elements that project out of the screen area cannot be specified (except for those parts of elements that are not actually drawn, such as the center point of an arc).

**Common Attributes
Display Functions**

The common attributes are described separately for each element.

Arcs

The relationship between the properties of an arc and the displayed graphic are indicated below.

Properties



General	
Position	
Center point	Coordinates of the center of the circle that includes the arc
Start point	Coordinates of the start point of an arc
End point	Coordinates of the end point of an arc
Size	
Radius	Radius of the circle that includes the arc (dot units)
Attribute	Display mode for the arc (Display attribute and drawing result, page 91). Standard/Inverse/Flash/Inverse Flash
Color	
Foreground	Display color of the arc (Colors other than black and white are available with the NT31C and NT631C only.) Black/Blue/Red/Magenta/Green/Cyan/Yellow/White

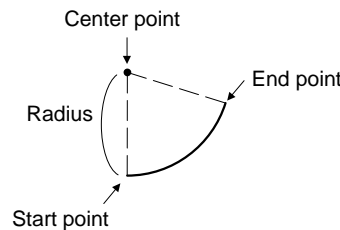

The line style is fixed as solid line and thickness is fixed as one dot.

At the Support Tool, the center point, start point and end point are specified, as shown in the figure below. When the start point is set, the radius is automatically set accordingly.

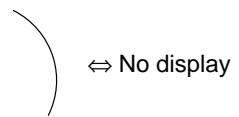

Display Attribute and Drawing Result

Attribute	Drawing Result
Standard	Only the line of the arc is drawn in the foreground color. 
Inverse	The area enclosed by the arc and a straight line drawn between its start and end points is displayed in the foreground color. 

Attribute	Drawing Result
Flash	Repeated alternation between standard display and no display. 
Inverse Flash	Repeated alternation between inverse and standard display. 

Circle

The relationship between the properties of a circle and the displayed graphic are indicated below.

Properties

General	
Position	
Center point	Coordinates of the center of the circle
Size	
Radius	Radius of the circle (dot units)
Attribute	Display mode for the circle (Display attribute and drawing result, page 92). Standard/Inverse/Flash/Inverse Flash
Color	
Foreground	Display color of the circle (Colors other than black and white are available with the NT31C and NT631C only.) Black/Blue/Red/Magenta/Green/Cyan/Yellow/White

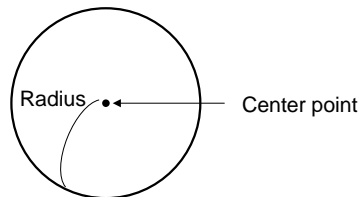

The line style is fixed as solid line and thickness is fixed as one dot.

At the Support Tool, the center point and radius are specified as shown below.

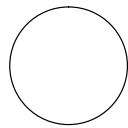
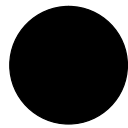

Display Attribute and Drawing Result

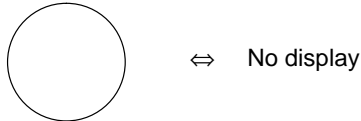
Attribute	Drawing Result
Standard	Only the line of the circle periphery is drawn in the foreground color. 
Inverse	The entire circle is displayed in the foreground color. 

Attribute	Drawing Result
Flash	Repeated alternation between standard display and no display. 
Inverse Flash	Repeated alternation between inverse and standard display. 

Rectangle

The relationship between the properties of a rectangle and the displayed graphic are indicated below.

Properties



General	
Position	Coordinates of the top left vertex of the rectangle
Size	Width and height of the rectangle (dot units)
Attribute	Display mode for the rectangle (Display attribute and drawing result, page 93). Standard/Inverse/Flash/Inverse Flash
Color	
Foreground	Display color of the rectangle (Colors other than black and white are available with the NT31C and NT631C only.) Black/Blue/Red/Magenta/Green/Cyan/Yellow/White

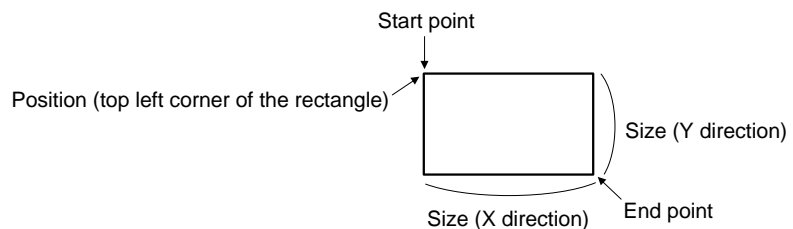

The line style is fixed as solid line and thickness is fixed as one dot.

At the Support Tool, specify the start point and end point as shown in the figure below (it is not necessary to draw the rectangle from top left to bottom right). By setting the start point and end point, the position and size are automatically set.

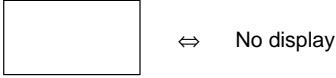

Display Attribute and Drawing Result

Attribute	Drawing Result
Standard	Only the boundary line of the rectangle is drawn in the foreground color. 
Inverse	The entire rectangle is displayed in the foreground color. 

Attribute	Drawing Result
Flash	Repeated alternation between standard display and no display. 
Inverse Flash	Repeated alternation between inverse and standard display. 

Polygon

The relationship between the properties of a polygon and the displayed graphic are indicated below.

Properties



General	
Position	
Attribute Point	Coordinates of the point that will be the start position for tiling in inverse display or inverse flashing display.
Attribute	Display mode for the polygon (Display attribute and drawing result, page 94). Standard/Inverse/Flash/Inverse Flash
Color	
Foreground	Display color of the polygon (colors other than black and white featured with NT31C, NT631C only) Black/Blue/Red/Magenta/Green/Cyan/Yellow/White

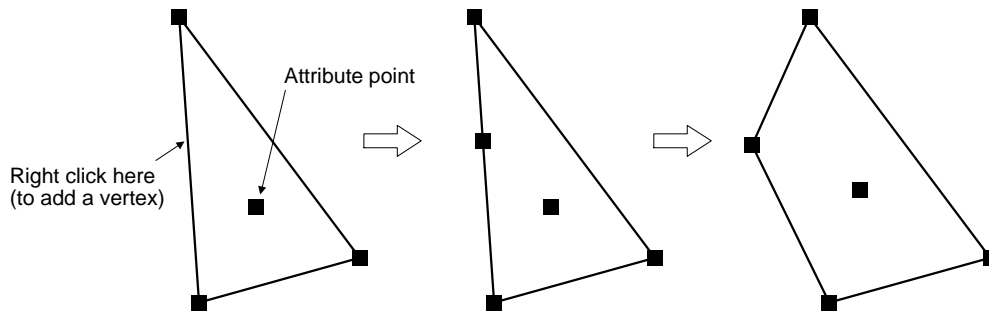

The line style is fixed as solid line and thickness is fixed as one dot.

At the Support Tool, using a triangle as the base, create the polygon by changing the number and position of the vertices. The attribute point is automatically set inside the polygon (its position can be changed).

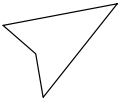

Display Attribute and Drawing Result

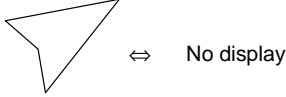
Attribute	Drawing Result
Standard	Only the boundary line of the polygon is drawn in the foreground color. 
Inverse	The inside of the polygon is displayed in the foreground color (see below). 

Attribute	Drawing Result
Flash	Repeated alternation between standard display and no display. 
Inverse Flash	Repeated alternation between inverse and standard display (see below). 

If inverse or inverse flash display is set for a polygon with multiple closed areas, like the one shown below, only the area that contains the attribute point is tiled.

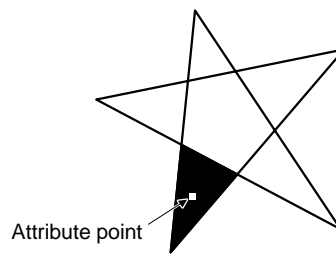

Polyline

The relationship between the properties of a polyline and the displayed graphic are indicated below.

Properties

General	
Line Style	Line type used for the polyline Solid line _____ Broken line - - - - - 1-dot chain line - · - · - · - 2-dot chain line - · - - - · -
Attribute	Display mode for the polyline (Display attribute and drawing result, page 96). Standard/flash
Color	
Foreground	Display color of the polygon (Colors other than black and white are available with the NT31C and NT631C only.) Black/Blue/Red/Magenta/Green/Cyan/Yellow/White

The line thickness is fixed as one dot.

At the Support Tool, using a straight line as the base, create the polyline by changing the number and position of the vertices.

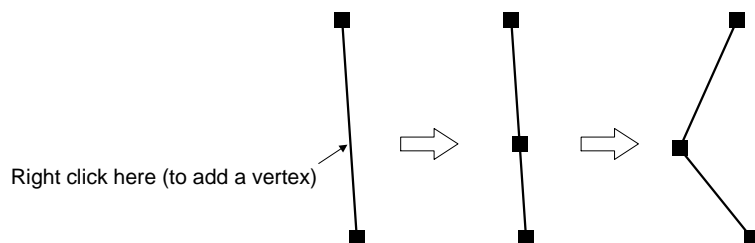

Display Attribute and Drawing Result

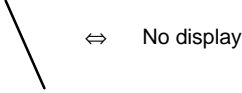
Attribute	Drawing Result
Standard	The polyline is displayed in the foreground color all the time. 
Flash	Repeated alternation between standard display and no display. 

Sector

The relationship between the properties of a sector and the displayed graphic are indicated below.

Properties

General	
Position	
Center point	Coordinates of the circle that includes the sector.
Start point	Coordinates of the start point of the sector
End point	Coordinates of the end point of the sector
Size	
Radius	Radius of the circle including the sector (dot units)
Attribute	Display mode for the sector (Display attribute and drawing result, page 96). Standard/Inverse/Flash/Inverse Flash
Color	
Foreground	Display color of the sector (Colors other than black and white are available with the NT31C and NT631C only.) Black/Blue/Red/Magenta/Green/Cyan/Yellow/White

The line style is fixed as solid line and thickness is fixed as one dot.

At the Support Tool, specify the center point, start point, and end point, as shown in the figure below. The radius is automatically set in accordance with the start point setting.

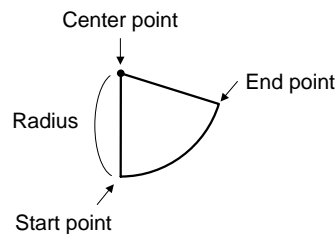

Display Attribute and Drawing Result

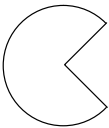
Attribute	Drawing Result
Standard	Only the boundary line of the sector is drawn in the foreground color. 

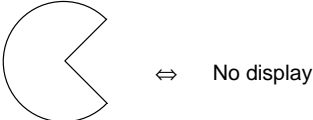
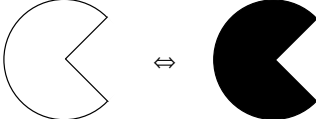
Attribute	Drawing Result
Inverse	<p>The entire sector is displayed in the foreground color.</p> 
Flash	<p>Repeated alternation between standard display and no display.</p> 
Inverse Flash	<p>Repeated alternation between inverse and standard display.</p> 

Input Functions

There are no input functions for circles, arcs, sectors, polylines, polygons, or rectangles.

Output Functions

There are no output functions for circles, arcs, sectors, polylines, polygons, or rectangles.

Processing Functions

There are no data processing functions for circles, arcs, sectors, polylines, polygons, or rectangles.

Relationship with Other Elements

- When tiling is used, an area enclosed by a continuous solid line can be tiled with the specified pattern (page 101). However, if the line is broken at any point, or if it flashes or is deleted, the tiling pattern will cover the area outside the line as well. Tiling will also spread outside the intended boundary line, in accordance with the display order, if it is displayed before the boundary line.
- It is possible to make a single library data display by combining multiple fixed display elements. If the display attribute for any of the elements in such a display is Flash or Inverse Flash, the display flashes in accordance with this setting.
- The timing of the flashing is the same for all elements.
- Both text (page 97) and mark (page 103) fixed displays will overlap each other in accordance with the order in which they were created. However, the way in which they overlap can be changed with the Support Tool.

2-4-2 Text (Fixed Display)**Function Outline**

These are character strings that are continually displayed as a fixed display. Standard, flash, and inverse flash displays are possible (inverse display can be specified by exchanging the foreground color and background color of the character string).

Since the order of display will always follow the order in which the elements are created with the Support Tool (character strings created later will overlay others created earlier), the order of creation must be considered when character strings are going to overlap.

Alphanumerics and symbols can be displayed.

NT31C

Reference: When the PT is in NT20S or NT30/620 compatible mode, images can be included within character strings of fixed displays. Refer to *Appendix C* for details on the NT20S and NT30/620 compatible modes (page 457).

Restrictions

- Up to 65,535 of the following graphics can be registered on one screen. For overlapping screens comprising 8 child screens, the maximum is 524,280 (65,535 × 8 screens).

Fixed display text, circles, arcs, sectors, polylines, polygons, rectangles, tiling, marks

There is no restriction on the number of graphics that can be registered for one screen data file: any number can be registered as long as the data file capacity is not exceeded.

- The following numbers of character can be displayed in one text display element, depending on the scale.

Magnification	NT21	NT31/NT31C	NT631/NT631C
1 1 (Equal)	Up to 32 characters	Up to 40 characters	Up to 80 characters
1 2 (High)	Up to 32 characters	Up to 40 characters	Up to 80 characters
2 1 (Wide)	Up to 16 characters	Up to 20 characters	Up to 40 characters
2 2	Up to 16 characters	Up to 20 characters	Up to 40 characters
3 3	Up to 10 characters	Up to 13 characters	Up to 26 characters
4 4	Up to 8 characters	Up to 10 characters	Up to 20 characters
8 8	Up to 4 characters	Up to 5 characters	Up to 10 characters

- If the text size exceeds the screen size, the Support Tool changes its display position automatically so that the text is displayed within the screen. In case the text can not be displayed within the screen even if the Support Tool has changed its position, the error message will be displayed. In this case, change the number of characters or scale size.

Display Functions

The relationship between the properties of a text display element and the displayed graphic are indicated below.

Properties

General	
Description	Displayed text Alphanumerics and symbols, Marks
Position	Coordinates of the top left corner of the rectangle that encloses the text.
Font Type	Font for alphanumerics Standard/Half Height
Scale	Scale at which the text is displayed (Enlarged display, page 99). 1 1 (Equal), 1 2 (High), 2 1 (Wide), 2 2, 3 3, 4 4, 8 8
Smoothing	Whether or not smoothing is used for text with a scale of 2 2 or larger (Smoothing, page 100). Check mark (smoothing executed)/ No check mark (smoothing not executed)
Attribute	Display mode for the text (Display attribute and drawing result, page 100). Standard/Flash/Inverse Flash
Color	
Foreground	Display color of the text (Colors other than black and white are available with the NT31C and NT631C only.) Black/Blue/Red/Magenta/Green/Cyan/Yellow/White/Transparent
Background	Background color of the text (Colors other than black and white are available with the NT31C and NT631C only.) Black/Blue/Red/Magenta/Green/Cyan/Yellow/White/Transparent

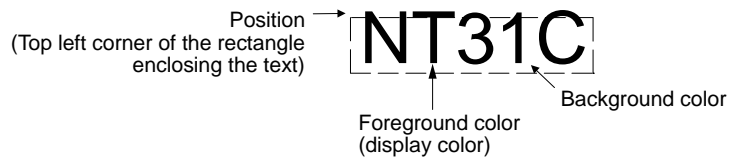

Enlarged Display

Character strings (text and marks) can be displayed at the following scales.

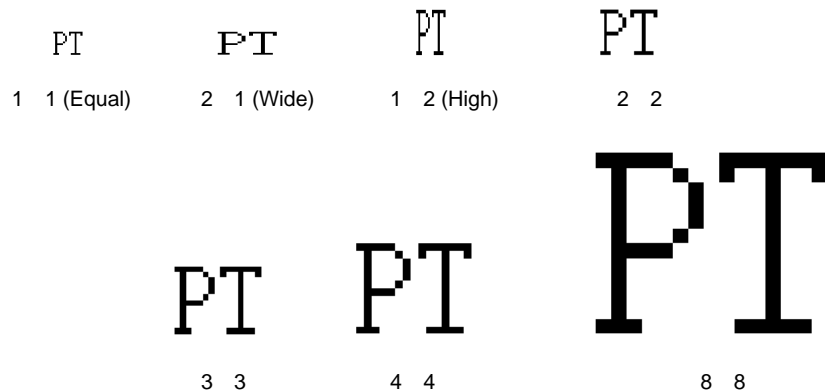

With ISO8859-1 font type, the characters of 2x2 or larger scale are automatically displayed in 32 dot high-definition font. However, the marks inserted into a string are always displayed in 16x16 dot font.

Reference: The 32 dot high-definition font is not displayed for the following models (16×16 dot font is used.)

- NT31-ST121□-E
- NT31C-ST141□-E
- NT631-ST211□-E
- NT631C-ST141□-E
- NT631C-ST151□-E

Smoothing

Characters enlarged to a scale of 2 or larger can be displayed with the outline automatically smoothed. This function is called smoothing.



Note that smoothing cannot be used for marks.

With smoothing Characters

Without smoothing Characters

Reference: Smoothing is not performed for high-definition font.

Display Attribute and Drawing Result

Attribute	Drawing Result
Standard	The text element is displayed with the specified foreground color and background color. 
Flash	Repeated alternation of the standard display and no display. 
Inverse Flash	Repeated exchange of the foreground color and background color. 

Input Functions

Text displays have no input function.

Output Functions

Text displays have no output function.

Processing Functions

Text displays have no data processing function.

Relationship with Other Elements

- It is possible to make a single library data display by combining multiple fixed display elements. If the display attributes for any of the elements in such a display is Flash or Inverse Flash, the display flashes in accordance with these settings.
- The timing of the flashing is the same for all elements.
- Circles, arcs, sectors, polylines, polygons, rectangles (page 90) and marks (page 103) overlap each other in accordance with the order in which they were created. However, the way in which they overlap can be changed with the Support Tool.

2-4-3 Tiling

Function Outline

The area enclosed by a line of the specified color is tiled with the specified tiling pattern.

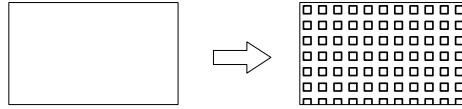

Restrictions

- Up to 65535 of the following graphics can be registered on one screen. For overlapping screens comprising 8 child screens, the maximum is 524,280 (65,535 × 8 screens).

Fixed display text, circles, arcs, sectors, polylines, polygons, rectangles, tiling, marks













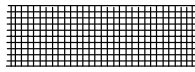
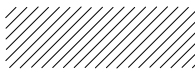
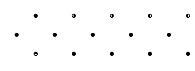

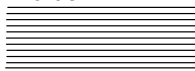





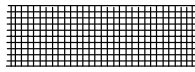
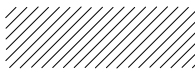
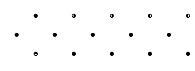

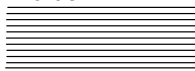
There is no restriction on the number of graphics that can be registered for one screen data file: any number can be registered as long as the data file capacity is not exceeded.

- The area to be tiled must be enclosed by a solid line of the same color. If the line is broken at any point, or if it flashes or is deleted, the tiling pattern will cover the area outside the line as well. Tiling will also spread outside the intended boundary line, in accordance with the display order, if it is displayed before the border line.
- Depending on the combination of the foreground color of a graphic (when tiled), the background color, and the border color, part of the frame of the graphic may be invisible. This is a phenomenon peculiar to a color LCD, not a failure of the PT. If this causes a problem, change the color combination.

Display Functions

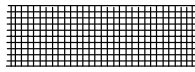
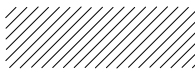
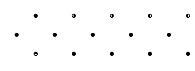
The relationship between the tiling properties and tiling method is indicated below.

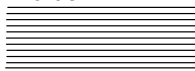
Properties

General											
Position	Coordinates where tiling starts										
Pattern	Tiling pattern (Pattern and color, page 102)										
	<table border="0"> <tr> <td>Uniform </td> <td>Slant right </td> </tr> <tr> <td>Box </td> <td>Crosshatch </td> </tr> <tr> <td>Slant left </td> <td>Grid </td> </tr> <tr> <td>Stripe </td> <td>Border </td> </tr> <tr> <td>Diamond </td> <td>Halftone </td> </tr> </table>	Uniform 	Slant right 	Box 	Crosshatch 	Slant left 	Grid 	Stripe 	Border 	Diamond 	Halftone 
Uniform 	Slant right 										
Box 	Crosshatch 										
Slant left 	Grid 										
Stripe 	Border 										
Diamond 	Halftone 										
Color											
Foreground	Display color of the tiling pattern (Colors other than black and white are available with the NT31C and NT631C only.) Black/Blue/Red/Magenta/Green/Cyan/Yellow/White										
Background	Background color of the tiling pattern (Colors other than black and white are available with the NT31C and NT631C only.) Black/Blue/Red/Magenta/Green/Cyan/Yellow/White/Transparent										
Border	Color of the line enclosing the tiled area (Colors other than black and white are available with the NT31C and NT631C only.) Black/Blue/Red/Magenta/Green/Cyan/Yellow/White										

Pattern and Color

The relationship between pattern and color is illustrated below, taking the Grid pattern as an example.

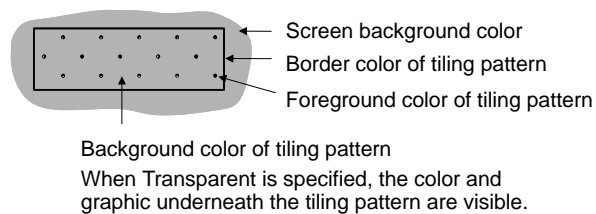

Input Functions

Tiling has no input function.

Output Functions

Tiling has no output function.

Processing Functions

Tiling has no data processing function.

Relationship with Other Elements

- Tiling can also be included in library data displays with other graphics.
- Circles, arcs, sectors, polylines, polygons, rectangles (page 90) and marks (page 103) overlap each other in accordance with the order in which they were

created. However, the way in which they overlap can be changed with the Support Tool.

- Color Palette Symbol is supplied with NT-series Support Tool for windows (version 5). For color palette symbol, combinations of foreground and background colors are registered by each tiling pattern.

By copying the symbol, you can register the required tiling object on a screen easily while checking the display status of symbols. For details, refer to the *NT-series Support Tool Version 4.6 for Windows Operation Manual (V061-E1-□)*.

2-4-4 Marks

Function Outline

Marks are pictograms comprising 16 by 16 dots. They are assigned to character codes.

Marks are created with the mark editor of the Support Tool, independently of screens, and as many as required can be displayed at any position on any screen. They can also be included in fixed display character strings and in character string memory table entries, and displayed in accordance with the properties for characters.



Procedure for creating and using marks

The procedure for creating marks and registering them on a screen is described briefly here. For details, refer to the *NT-series Support Tool Version 4 for Windows Operation Manual (V061-E1-2)*.

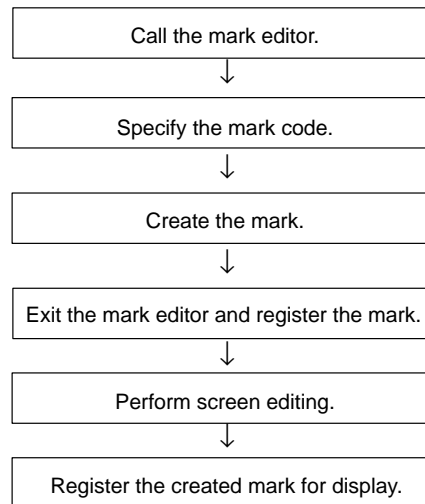

Restrictions

- A maximum of 224 marks can be created for one screen data file: each of the marks is assigned any required character code within the range FF20 to FFFFH so that it can be managed and specified. However, note that marks in the range FFEF to FFFFH are used by the system and if they are changed, touch switches may not be displayed correctly for trend graphs, etc. If marks are written to these codes, on conversion of data from a different model of PT, etc., copy the mark data to other codes, then reset the mark data. The marks at these codes will return to the initial status.
- Up to 65535 of the following graphics can be registered on one screen. (Same for window screen.) For overlapping screens comprising 8 child screens, the maximum is 524,280 (65,535 × 8 screens).

Fixed display text, circles, arcs, sectors, polylines, polygons, rectangles, tiling, marks

There is no restriction on the number of graphics that can be registered for one screen data file: any number can be registered as long as the data file capacity is not exceeded.

- When a mark is included in a character string that is displayed enlarged with the smoothing function used, the mark is not subject to smoothing.
- Marks are displayed in 16 16 dot font with enlargement, even when the character string, to which marks are inserted, is 2 2 or larger scale and are displayed in 32 dot font.

Display Functions

The properties of mark displays and their relationship with displayed character strings are indicated below.

Here, mark display, whereby a single mark is displayed as a fixed display, is explained. For details on the display of marks when they are included in character strings, refer to 2-4-2 Text (Fixed Display) (page 97) and 2-9 Character String Display (page 148).

Properties

General	
Position	Coordinates of the top left corner of the mark
Code	Character code of the mark FF20 to FFFFH
Attribute	Display mode for the mark (Display attribute and drawing result, page 105). Standard/Flash/Inverse Flash
Size	Scale at which the mark is displayed (Enlarged display, page 104). 1 1 (Equal), 1 2 (High), 2 1 (Wide), 2 2, 3 3, 4 4, 8 8
Color	
Foreground	Display color of the mark (Colors other than black and white are available with the NT31C and NT631C only.) Black/Blue/Red/Magenta/Green/Cyan/Yellow/White/Transparent
Background	Background color of the mark (Colors other than black and white are available with the NT31C and NT631C only.) Black/Blue/Red/Magenta/Green/Cyan/Yellow/White/Transparent

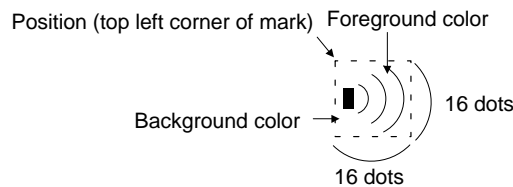

Enlarged Display

Marks can be displayed at the following scales.

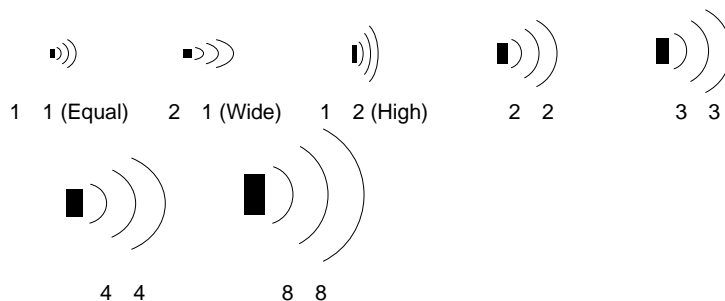

Even if a scale of 2 or larger is set for a mark, it will not be smoothed by the smoothing function.

Display Attribute And Drawing Result

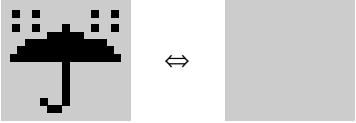
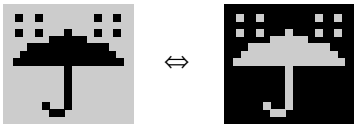
Attribute	Drawing Result
Standard	<p>The mark is displayed with the specified foreground color and background color.</p> 
Flash	<p>Repeated alternation of the standard display and background color only.</p> 
Inverse Flash	<p>Repeated exchange of the foreground color and background color.</p> 

Input Functions

Marks have no input function.

Output Functions

Marks have no output function.

Processing Functions

Marks have no data processing function.

Relationship with Other Elements

- It is possible to make a single library data display by combining multiple fixed display elements. If the display attribute for any of the elements in such a display is Flash or Inverse Flash, the display flashes in accordance with this setting. The timing of the flashing is the same for all elements.
- Marks overlap with other fixed display elements in accordance with the order in which they were registered. However, the way in which they overlap can be changed with the Support Tool.

2-5 Image and Library Data

2-5-1 Image Data Display

Function Outline

Image data are images composed of dots. They can be set to any size within the following range.

	NT21	NT31/NT31C	NT631/NT631C	Remarks
Width	8 to 256 dots	8 to 320 dots	8 to 640 dots	8-dot units
Height	8 to 136 dots	8 to 240 dots	8 to 480 dots	8-dot units

Image data are created with the image editor of the Support Tool, independently of screens, and as many as required can be displayed at any position on any screen. It is also possible to import files in the BMP format of Windows95 and register them as image data.

There are two ways to display image data. Image data can be displayed by directly specifying the code number (fixed code) or indirectly specifying the code number through a numeral memory table entry (indirect specification).

When the code is specified indirectly, the displayed image can be changed just by overwriting the code number in the numeral table entry, in the same way that indirectly specified numeral/character string displays can be changed. If indirect specification is used, displayed images can be changed with a simple program that just changes the contents of a numeral memory table entry and a series of images can be displayed to generate a moving image.

Registering frequently used and complex images as image data allows them to be displayed easily whenever required.



When image data is created in the 2 Colors mode, the foreground and background colors can be specified. (The NT21, NT31 and NT631 always run in 2 Colors mode.)

When image data is created in the 8 Colors mode, colors (selected from the available eight) can be assigned to each dot.

When creating image data, it is possible to specify compression of the data. However, note that it takes a little longer to display compressed image data than data that has not been compressed.

Reference: When the PT is in NT20S or NT30/620 compatible mode, the image codes and maximum number of images are the same as the NT30C, NT620S, NT620C, and NT625 PTs. Refer to *Appendix C* for details on the NT20S and NT30/620 compatible modes (page 457).

Procedure for Creating and Using Image Data

The procedure for creating image data and registering them on a screen is described simply here. For details, refer to the *NT-series Support Tool Version 4 for Windows Operation Manual (V061-E1-□)*.

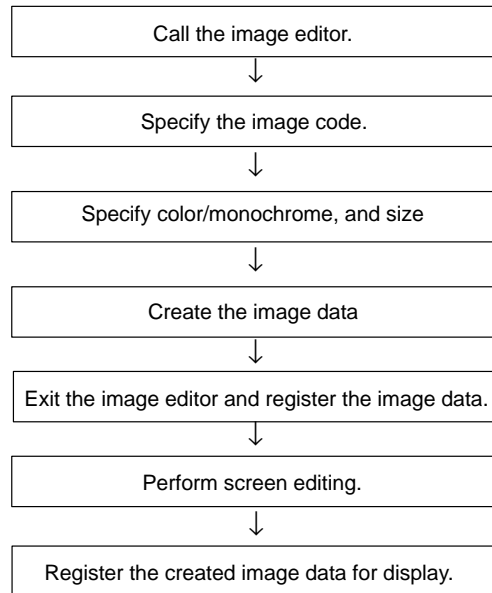
**Indirect Specification**

With indirect specification, specify a numeral memory table entry containing the desired hexadecimal code. The PT treats the contents of the specified numeral memory table entry as an image code and displays the corresponding image.

This function is very convenient when you want to change displayed images. Since image codes are hexadecimal, the Storage Type of the numeral memory table entries that contain image codes must be set to binary and the values (image code numbers) stored in the table entries must be hexadecimal.

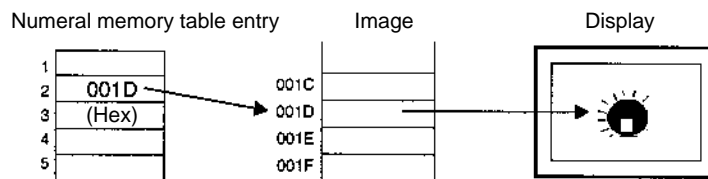
**Restrictions**

- A maximum of 4,095 image data can be created for one screen data file: each of the image data is assigned any required code within the range 0001 to 0FFFH (image/library code range) so that it can be managed and specified.
- Altogether, up to 256 image and library data elements (directly and indirectly specified) can be displayed on one screen. For overlapping screens comprising 8 child screens, the maximum is 1,024.
- The size of image data can be specified as follows:

	NT21	NT31/NT31C	NT631/NT631C	Remarks
Width	8 to 256 dots	8 to 320 dots	8 to 640 dots	8-dot units
Height	8 to 136 dots	8 to 240 dots	8 to 480 dots	8-dot units

- The codes used for image data are dedicated for image/library data use. Image data cannot be included in character strings in the same way that marks can, unless the PT is in NT20S or NT30/620 compatible mode.
- Image data that projects out of the screen area cannot be specified.

Display Functions

The properties of image data and their relationship with the method of display are indicated below.

Properties

General	
Position	Coordinates of the top left corner of the image data
Size	Size of the image data
Fixed code (The image code itself is specified directly.)	
Code	Image/library code of the image data 0001 to 0FFF _H
Mode	Color mode of the image data (specified with the image editor) (The NT21, NT31 and NT631 always run in 2 Colors mode.) 2 Colors/8 Colors
Comment	Comment assigned to the image data (specified with the image editor)
Indirect specification (The image code is specified indirectly via a numeral memory table entry.)	
table entry number	Number of the numeral memory table entry that contains the image code of the image you want to display. (Image codes are hexadecimal, so set the numeral memory table entry's Storage Type to binary. Also, be sure to write the image code number in hexadecimal.)
Color (for NT31C and NT631C only valid when 2 Colors is set for Mode.)	
Foreground	Display color of the image data Black/Blue/Red/Magenta/Green/Cyan/Yellow/White
Background	Background color of the image data Black/Blue/Red/Magenta/Green/Cyan/Yellow/White/ Transparent

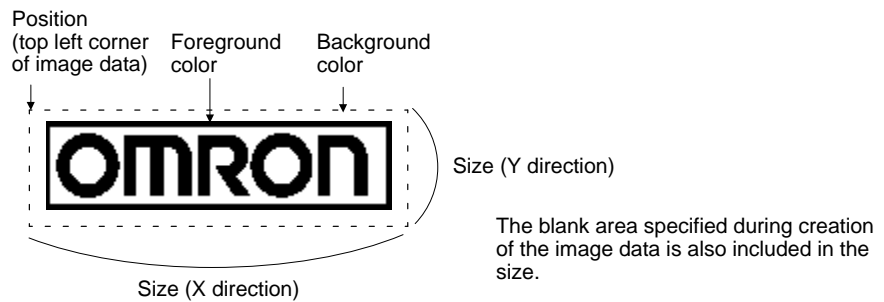

If there is a blank area surrounding the image data, this is also included in the image. Bear this in mind when specifying a background color in the 2 Colors mode.

Reference: When color data is pasted to 2 Colors mode image data, all the colors except black become white.

When an Unregistered Code Is Specified

When a code for which no image data is registered is specified, the symbol indicating an unregistered code () is displayed on the Support Tool, but on the PT nothing is displayed.

Input Functions

Image data have no input function.

Output Functions

Image data have no output function.

Processing Functions

Image data have no data processing function.

Relationship with Other Elements

- Difference between image data and library data

Image data can take any form for it is composed of dots, but library data can only be created by assembling fixed display text and graphics.

Since only drawing information for characters and graphics is registered for library data, library data takes up less memory area than image data, which requires all the dots to be displayed on the screen to be registered as data.

Another difference is that flash and inverse display are not possible for image data, but library data can be displayed in these modes in accordance with the display attributes of the registered elements. The timing of the flashing is the same for all elements.

- It is possible to specify different image/library data for the graphic displayed when a lamp (image/library lamp) is ON and OFF (page 112).
- It is possible to specify different image/library data for each message displayed for the alarm list/alarm history function (page 182).
- Image data elements overlap with other fixed display elements in accordance with the order in which they were registered. However, the way in which they overlap can be changed with the Support Tool.

2-5-2 Library Data Display

Function Outline

Library data are combinations of multiple fixed display text and graphic elements registered as single elements. Library data can be registered in any required size.

Library data are created with the library editor of the Support Tool, independently of screens, and as many as required can be displayed at any position on any screen.

Registering frequently used and complex images as library data allows them to be displayed easily whenever required.

There are two ways to display library data. Library data can be displayed by directly specifying the code number (fixed code) or indirectly specifying the code number through a numeral memory table entry (indirect specification).

When the code is specified indirectly, the displayed library can be changed just by overwriting the code number in the numeral table entry, in the same way that indirectly specified numeral/character string displays can be changed. If indirect specification is used, displayed libraries can be changed with a simple program that just changes the contents of a numeral memory table entry and a series of libraries can be displayed to generate a dynamic screen.

Since the individual elements within a library data are displayed in the order they were created with the Support Tool (graphics created early are overlaid by those created later), the order must be considered when creating them.

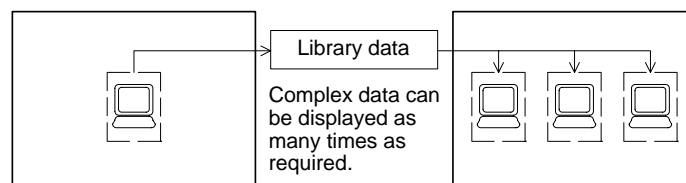

Reference: When the PT is in NT20S or NT30/620 compatible mode, the library codes and maximum number of libraries are the same as the NT30C, NT620S, NT620C, and NT625 PTs. Refer to *Appendix C* for details on the NT20S and NT30/620 compatible modes (page 457).

Procedure for Creating and Using Library Data

The procedure for creating library data and registering them on a screen is described briefly here. For details, refer to the *NT-series Support Tool Version 4 for Windows Operation Manual (V061-E1-□)*.

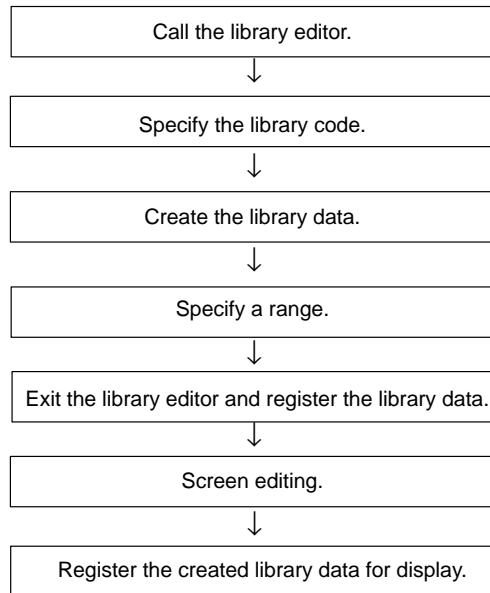
**Indirect Specification**

With indirect specification, specify a numeral memory table entry containing the desired hexadecimal code. The PT treats the contents of the specified numeral memory table entry as a library code and displays the corresponding library image. This function is very convenient when you want to change displayed libraries.

Since library codes are hexadecimal, the Storage Type of the numeral memory table entries that contain library codes must be set to binary and the values (library code numbers) stored in the table entries must be hexadecimal.

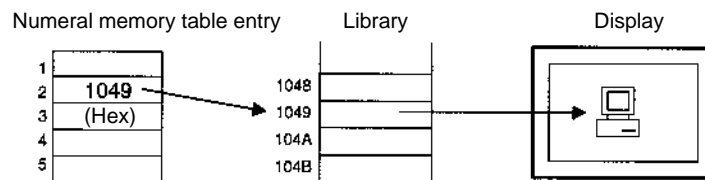
**Restrictions**

- A maximum of 12,288 library data can be created for one screen data file: each of the library data is assigned any required code within the range 1000 to 3FFFH (image/library code range) so that it can be managed and specified.
- A total of up to 256 image and library data elements (directly and indirectly specified) can be registered on one screen. (Same for window screen.) For overlapping screens comprising 8 child screens, the maximum is also 256.
- The maximum number of elements that can be registered for one library data is 65,535.
- The elements that can be registered in library data are the following fixed display elements: other elements cannot be registered.
 - Text, circles, arcs, sectors, polylines, polygons, rectangles, tiling, marks.
- The codes used for library data are dedicated for image/library data use. Library data cannot be included in character strings in the same way that marks can, unless the PT is in NT20S or NT30/620 compatible mode.

Display Functions

- Library data that projects out of the screen area cannot be specified.

The properties of library data and their relationship with the method of display are indicated below.

Properties

General	
Position	Coordinates of the top left corner of the library data
Size	Size of the library data
Fixed code (The library code itself is specified directly.)	
Code	Image/library code of the library data 1000 to 3FFF _H
Comment	Comment set for the library data (specified with the library editor)
Indirect specification (The library code is specified indirectly via a numeral memory table entry.)	
table entry number	Number of the numeral memory table entry that contains the library code of the library that you want to display. (Library codes are hexadecimal, so set the numeral memory table entry's Storage Type to binary. Also, be sure to write the library code number in hexadecimal.)

Position (top left corner of library data)

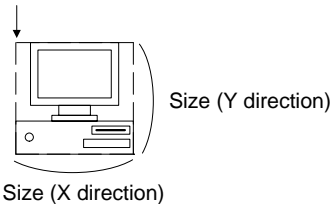
**When an Unregistered Code Is Specified**

When a code for which no library data is registered is specified, the symbol indicating an unregistered code () is displayed on the Support Tool, but on the PT nothing is displayed.

Input Functions

Library data have no input function.

Output Functions

Library data have no output function.

Processing Functions

Library data have no data processing function.

Relationship with Other Elements

- Difference between image data and library data

Image data can take any form for it is composed of dots, but library data can only be created by assembling fixed display text and graphics.

Since only drawing information for characters and graphics is registered for library data, library data requires little memory area in comparison with image data, which requires all the dots to be displayed on the screen to be registered as data.

Another difference is that flash and inverse display are not possible for image data, but library data can be displayed in these modes in accordance with the display attributes of the registered elements. The timing of the flashing is the same for all elements.

- It is possible to specify different image/library data for the graphic displayed when a lamp (image/library lamp) is ON and OFF (page 112).
- It is possible to specify different image/library data for each message displayed for the alarm list/alarm history function (page 182).
- Library data elements overlap with other fixed display elements in accordance with the order in which they were displayed. However, the way in which they overlap can be changed with the Support Tool.

2-6 Lamps

Function Outline

Lamps are graphics that change in accordance with the status of a set bit. Lamps are classified into the two major categories indicated below.

Normal (Standard) Lamps

Normal (standard) lamps change the display status (OFF/ON/flashing) of fixed display graphics.

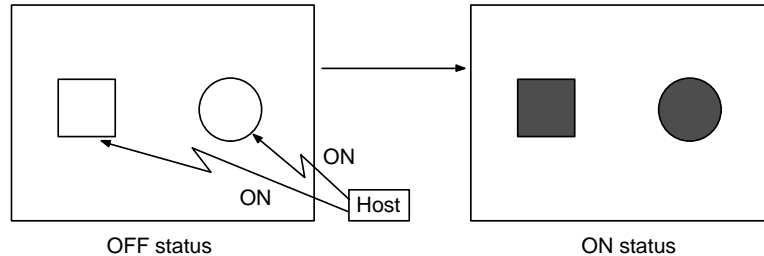

Image/Library Lamps

Image/library lamps display different graphics (image/library data) in the ON and OFF statuses.

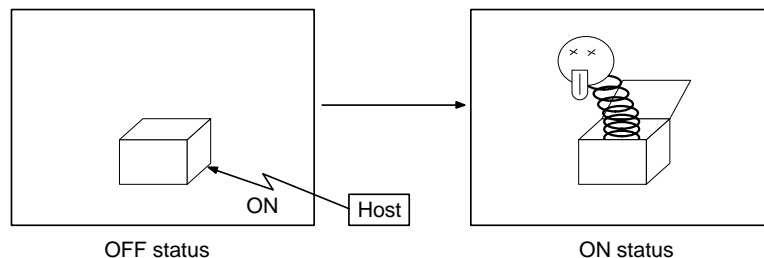

Lamps are arranged and set on the screen when creating screen data with the Support Tool.

Restrictions

- A maximum of 256 lamps can be registered for one screen. For overlapping screens comprising 8 child screens, the maximum is 1,024.

There is no restriction on the number of lamps that can be registered for one screen data file: any number can be registered as long as the data file capacity is not exceeded. However, if a large number of elements are registered, check that the restrictions on element display are complied with by referring to Display Restrictions (page 437).

- When polygons are used as the display graphics for normal (standard) lamps, one polygon can be given up to 255 vertices.
- Image/library lamps are subject to the maximum simultaneous display restriction imposed on image and library data. This means that a maximum total of 256 image/library lamps and image and library data can be displayed on one screen. For overlapping screens comprising 8 child screens, the maximum is 1,024.
- When library data is displayed with an image/library lamp, if the library data projects outside the screen area, nothing is displayed. Usually, the Support Tool ensures that the data does not project out of the screen area.
- If no data is registered for the specified image/library lamp code, nothing will be displayed.
- Among lamps, the display order is determined by the order in which the lamps were created. However, this order among lamps can be changed with the Support Tool.

Common Attributes

The common attributes vary widely according to the type of lamp, therefore they are described separately for each case.

Display Functions

Normal (Standard) Lamps

The relationship between the properties of a normal (standard) lamp and the displayed graphic are indicated below.

Properties

General	
Position	Coordinates of the top left corner of the lamp display area
Size	Width and height of the lamp display area (in dot units)
Frame	Presence/absence of a frame for the lamp display graphic Check mark (frame used)/No check mark (no frame)
Shape	Shape of the lamp (display graphic) Rectangle, Polygon, Circle, Sector
Color	
Frame	Color of the frame (valid only when a check mark is set for Frame above). Colors other than black and white are available with the NT31C and NT631C only. Black/Blue/Red/Magenta/Green/Cyan/Yellow/White
ON /Flashing	Color of the lamp in the ON or flashing states (Colors other than black and white are available with the NT31C and NT631C only.) Black/Blue/Red/Magenta/Green/Cyan/Yellow/White
OFF	Color of the lamp in the OFF state (Colors other than black and white are available with the NT31C and NT631C only.) Black/Blue/Red/Magenta/Green/Cyan/Yellow/White/ Transparent
Light Function	
Address	
PC Bit Address	Allocated bit of the lamp (Allocated bit, page 114)
I/O Comments	Comment that indicates the meaning of the allocated bit Character string of up to 16 alphanumerics and symbols
Lamp Attribute	
ON Type	Display mode when the lamp is ON Light/Flash
Guide Characters	
Display	Presence/absence of character string (guide characters) attached to the lamp Check mark (display)/No check mark (don't display)
Type	Type of character string attached to the lamp Fixed character string, ON/OFF switching, numeral display, or character string display
Guide character settings (Refer to <i>Guide Character Type</i> on page 115.)	

Shape of Lamps

Rectangle

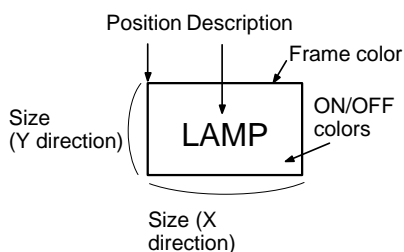

Polygon

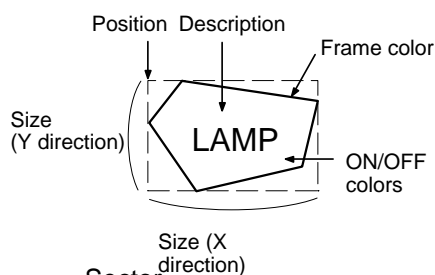

Circle

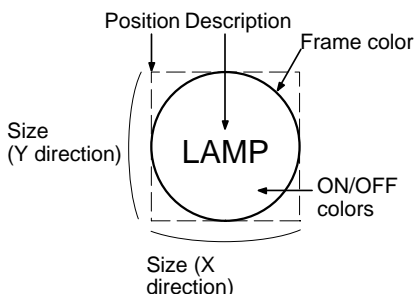

Sector

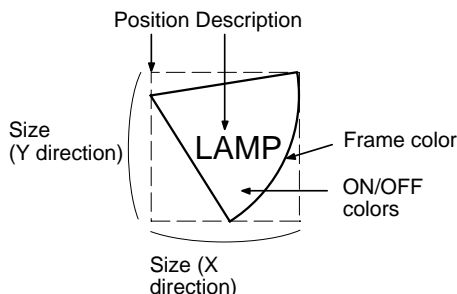

Allocated Bits

Bits can be allocated for lamp bits in the following host (PC) areas.

Symbol	C-series PCs	Allocation	CV-series PCs	Allocation	CS/CJ-series PCs	Allocation
None	IR Area	OK	CIO Area	OK	CIO Area	OK
H	HR Area	OK	---	---	HR Area	Not for Host Link
A	AR Area	OK	Auxiliary Area	No	AR Area	OK
L	LR Area	OK	---	---	LR Area ^{*1}	Not for Host Link
T	TC Area, Timer PVs	No	Timer Area, Timer PVs	No	TC Area, Timer PVs	No
TU	---	---	---	---	TC Area, Timer Completion Flags	Not for Host Link
C	TC Area, Counter PVs	No	Counter Area, Counter PVs	No	TC Area, Counter PVs	No
CU	---	---	---	---	TC Area, Counter Completion Flags	Not for Host Link
W	---	---	---	---	WR Area	Not for Host Link
TK	---	---	---	---	Task Flags	Not for Host Link
D	DM Area	OK	DM Area	OK	DM Area	OK
E	EM Area ^{*2} , current bank	OK	EM Area, current bank	Not for Host Link	EM Area, current bank	Not for Host Link
E0_ to EC_	---	---	---	---	EM Area, EM banks 0 to C	Not for Host Link

*1: LR 00000 to LR 00199 are converted to CIO 01000 to CIO 01199.

*2: The EM Area is supported only by the C200HX/HG/HE(-Z)E PCs.

The Auxiliary Area of the CVM1 and CV-series PCs is allocated to system functions, and it cannot be used for purposes other than system use.

The range of each memory area differs according to the PC. Refer to *Appendix D PC Memory Maps* on page 441.

When a DM Area or EM Area address is specified, add a bit number (00 to 15) to the end of the word address.

Display of Lamps

Lamps are displayed as follows according to the status of the allocated bit:

0 (OFF): OFF

1 (ON): ON, or flashing

Whether a lamp lights continuously or flashes when the lamp bit is set to 1 (ON) is determined by the ON Type attribute.

Note that the display when the lamp is ON or flashing also changes according to the presence or absence of a frame.

When there is a frame: The frame is always displayed.

When there is no frame: The lamp may be invisible when it is OFF depending on the OFF color.

When there is a frame display

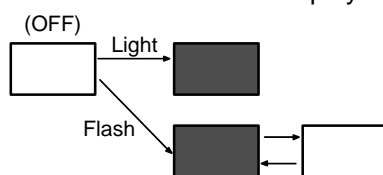

Only the area inside the frame flashes.

When there is no frame display

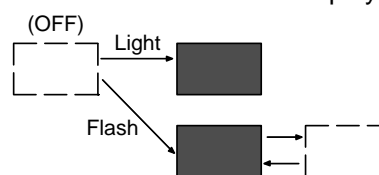

Lamp alternates between displayed and not-displayed states.

Guide Character Type

The following 4 types of guide characters can be displayed on the PT.

Type	Description
Fixed character string	The same character string is always displayed regardless of the status of the lamp.
ON/OFF switching	Different character strings are displayed when the lamp is ON (or flashing) and OFF. It is also possible to display more than one line of guide characters.
Numeral display	The contents of a numeral memory table entry are displayed in real time as the lamp's guide characters.
Character string display	The contents of a character string memory table entry are displayed in real time as the lamp's guide characters.

The guide character settings for each guide character type are as follows:

- Fixed Character String Settings

The settings are the same as the settings for the fixed display's character strings except that multiple lines and their alignment (left, center, or right) can be specified.

For details on displaying multiple lines and specifying alignment, refer to *Displaying Multiple Lines of Guide Characters* on page 116. For details on other properties, refer to *2-4-2 Text (Fixed Display)*.

Reference: Different colors can be set for a lamp's guide characters when ON and OFF, but the background color is always transparent.

- ON/OFF Switching Character Settings

Different character strings can be specified for display when the lamp is ON (lamp bit ON) and OFF (lamp bit OFF). It is also possible to specify different

display locations for the ON and OFF character strings. All other settings are the same as the settings for the fixed display's character strings.

For details on displaying multiple lines and specifying alignment, refer to *Displaying Multiple Lines of Guide Characters* below. For details on other properties, refer to 2-4-2 Text (Fixed Display).

Reference: Different colors can be set for a lamp's guide characters when ON and OFF, but the background color is always transparent.

- Numeral Display

The properties settings are the same as those for numeral displays. Refer to 2-8 *Numeral Display* for details.

- Character String Display

The properties settings are the same as those for numeral displays. Refer to 2-8 *Numeral Display* for details.

Displaying Multiple Lines of Guide Characters

Multiple lines of guide characters can be specified when fixed character strings or ON/OFF switching character strings are being used. The number of characters that can be input depends upon the model of PT being used, as shown in the following table.

Model	Max. number of guide characters*	Max. number of characters/line*	Max. number of lines
NT21	128	32	8
NT31/NT31C	128	40	15
NT631/NT631C	256	80	30

* The new line code (<\n>) is counted as one character in the number of characters.

The space between guide character lines (number of dots from the bottom of a line to the top of the next line) is set with the line spacing property. A negative line spacing can be specified, so that a later line will partially overlap the preceding line, but there must be at least 8 dots of space between the tops of the two lines.

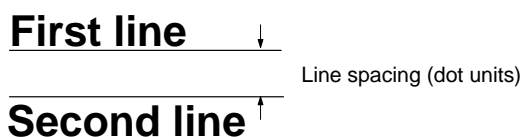

It is also possible to set the alignment (left, center, or right) of the lines.

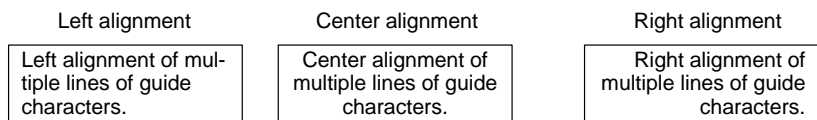

Image/Library Lamps

The relationship between the properties of an image/library lamp and the displayed graphic are indicated below.

Properties

General	
OFF state	
X, Y	Coordinates of the top left corner of the image/library data display in the OFF state
Width, Height	Width/height of image/library data displayed in the OFF state
Code	Image/library code displayed in the OFF state
Color (valid only for image data whose color mode is 2 Colors)	
Foreground	Foreground color of the image/library lamp in the OFF state (Colors other than black and white are available with the NT31C and NT631C only.) Black/Blue/Red/Magenta/Green/Cyan/Yellow/White
Background	Background color of the image/library lamp in the OFF state (Colors other than black and white are available with the NT31C and NT631C only.) Black/Blue/Red/Magenta/Green/Cyan/Yellow/White/Transparent
ON State	
X, Y	Coordinates of the top left corner of the image/library data display when the lamp is ON
Width, Height	Width/height of image/library data displayed in the ON state
Code	Code of the image/library data displayed in the ON status
Color (valid only for image data whose color mode is 2 Colors)	
Foreground	Foreground color of the image/library lamp in the OFF state (Colors other than black and white are available with the NT31C and NT631C only.) Black/Blue/Red/Magenta/Green/Cyan/Yellow/White
Background	Background color of the image/library lamp in the OFF state (Colors other than black and white are available with the NT31C and NT631C only.) Black/Blue/Red/Magenta/Green/Cyan/Yellow/White/Transparent
Light Function	
Address	
PC Bit Address	Allocated bit of the lamp (Allocated bit, page 118)
I/O Comments	Comment that indicates the contents of the allocated bit Up to 16 alphanumeric characters

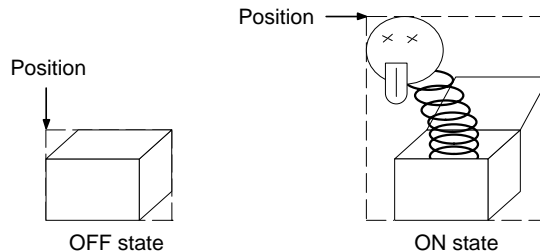

Allocated Bits

Bits can be allocated for lamp bits in the following host (PC) areas.

Symbol	C-series PCs	Allocation	CV-series PCs	Allocation	CS/CJ-series PCs	Allocation
None	IR Area	OK	CIO Area	OK	CIO Area	OK
H	HR Area	OK	---	---	HR Area	Not for Host Link
A	AR Area	OK	Auxiliary Area	No	AR Area	OK
L	LR Area	OK	---	---	LR Area* ¹	Not for Host Link
T	TC Area, Timer PVs	No	Timer Area, Timer PVs	No	TC Area, Timer PVs	No
TU	---	---	---	---	TC Area, Timer Completion Flags	Not for Host Link
C	TC Area, Counter PVs	No	Counter Area, Counter PVs	No	TC Area, Counter PVs	No
CU	---	---	---	---	TC Area, Counter Completion Flags	Not for Host Link
W	---	---	---	---	WR Area	Not for Host Link
TK	---	---	---	---	Task Flags	Not for Host Link
D	DM Area	OK	DM Area	OK	DM Area	OK
E	EM Area * ² , current bank	OK	EM Area, current bank	Not for Host Link	EM Area, current bank	Not for Host Link
E0_ to EC_	---	---	---	---	EM Area, EM banks 0 to C	Not for Host Link

*1: LR 00000 to LR 00199 are converted to CIO 01000 to CIO 01199.

*2: The EM Area is supported only by the C200HX/HG/HE(-Z)E PCs.

The Auxiliary Area of the CVM1 and CV-series PCs is allocated to system functions, and it cannot be used for purposes other than system use.

The range of each memory area differs according to the PC. Refer to *Appendix D PC Memory Maps* on page 441.

When a DM Area or EM Area address is specified, add a bit number (00 to 15) to the end of the word address.

Input Functions

Lamps read the contents of a bit at the host and execute processing in accordance with the bit status.

However, the bit is only read in the following case:

When a lamp is used on the currently displayed screen

Output Functions

Lamps have no output function.

Processing Functions

Lamps have no data processing function.

Relationship with Other Elements

- Touch switches (page 119) have the same display functions as normal (standard) lamps.
- Lamps overlap with other elements in accordance with the order in which they were registered on the screen with the Support Tool. However, the way in which they overlap can be changed with the Support Tool.

2-7 Touch Switches

Function Outline

The PT allows input from the touch panel on the screen. By pressing (touching) the touch switches on the screen, the PT screen can be switched, and bit information can be sent to the host.

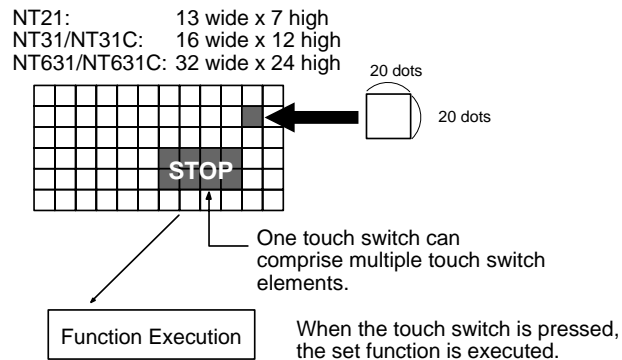

Size of Touch Switch Elements

Model	Width	Height
NT21-ST121□-E	9.0 mm	9.0 mm
NT31-ST121□-EV2 NT31C-ST141□-EV2	7.2 mm	7.2 mm
NT631C-ST141□-EV2	7.2 mm	7.2 mm
NT631-ST211□-EV2 NT631C-ST151□-EV2	6.6 mm	6.6 mm

As with lamps, graphics that change in accordance with the status of a set bit are set for touch switches, and, besides, an area where the touching of the touch switch can be detected (the touch switch area) is also set for them.

Touch switches are arranged and set on screens when creating screen data with the Support Tool.

When a touch switch is pressed, the function set for it in advance is executed.

The way a touch switch is displayed and the processing when it is pressed can each be set independently.

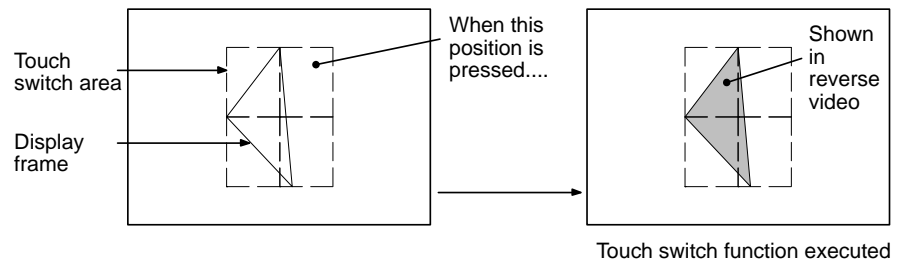

Note Do not press touch switches with a force of greater than 30 N. Applying higher force may cause the glass to break, cause injuries, and prevent operation.

Do not press touch switches carelessly while the backlight is off or while nothing is displayed on the screen. Otherwise the system may operate unpredictably. Only press touch switches after confirming system safety.

Note If touch switches are pressed in rapid succession, their inputs may not be successfully received.

Confirm that the input of a touch switch has been successfully received before moving on to the next operation.

Reference: Caution on pressing three touch switches

When multiple touch switches are arranged as shown in the example below and the three are pressed at the same time, a malfunction will occur due to a peculiarity of the touch switch mechanism.

Be careful how you arrange touch switches.

Example: When touch switches are created at positions A and B and at one of the points of intersection C or D

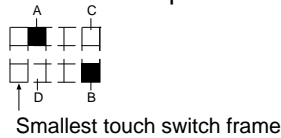

- If switches A, B, and C come ON at the same time, touch switch D will also come ON due to the touch switch mechanism.
- If switches A, B, and D come ON at the same time, touch switch C will also come ON due to the touch switch mechanism.

Functions That Can Be Set for Touch Switches

Any of the following functions can be set for touch switches. For details, refer to *Processing Functions* (page 128).

Host Notification Function

When a touch switch is pressed, the status of a bit for notification purposes at the host (the notify bit) changes.

It may change in any of the four following ways.

Momentary

The notify bit is set to 1 (ON) only while the touch switch is pressed, and returns to 0 (OFF) when the touch switch is released.

Alternate

Each time the touch switch is pressed, the notify bit is switched to 1 (ON) if currently set to 0 (OFF), and to 0 (OFF) if currently set to 1 (ON).

Set

When the touch switch is pressed the notify bit is set to 1 (ON).

Reset

When the touch switch is pressed the notify bit is set to 0 (OFF).

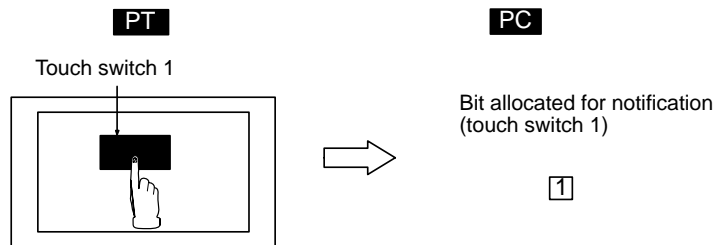

Screen Switching Function

When a touch switch is pressed, the display switches to the set screen.

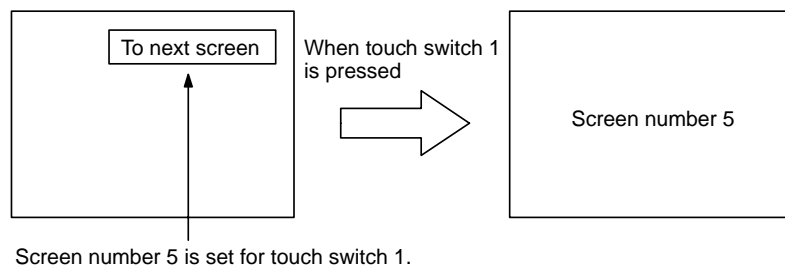

Input Key – Control Function

When used in combination with the numeral/character string setting function, this function allows numeric values to be input into input fields. It is also possible to execute special functions such as checking and clearing input numeric values and character strings, and moving the cursor and moving between input fields with the arrow keys.

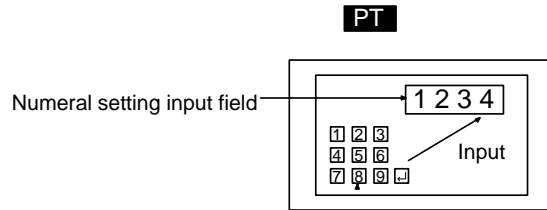

Character String Input Key Function

When this function is used in combination with the character string setting function, a label can be input into an input field by pressing a touch switch.

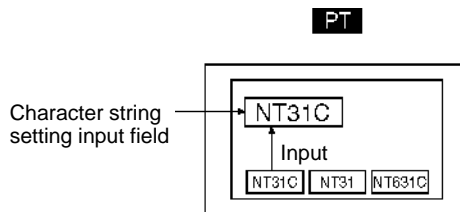

Window Key Function

This function makes it possible to open and close windows by pressing touch switches.

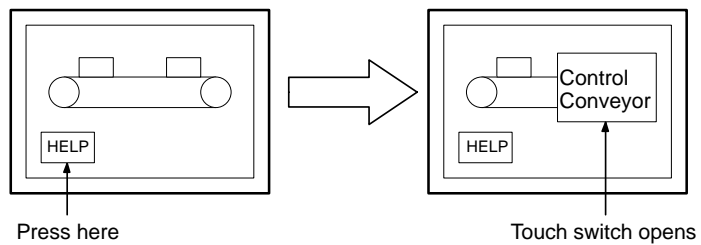

Copy Key Function

This functions allows data or constants in memory table entries to be copied to other memory table entries or into numeral setting/character string input fields, by pressing a touch switch.

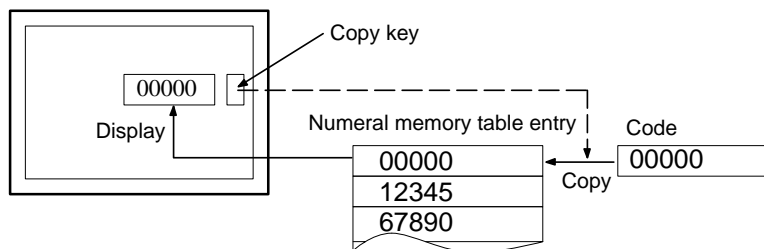

Cursor Moving Key Function

When there are a number of numeral setting or character string input fields on the screen, this function makes it possible to move the cursor to any required input field.

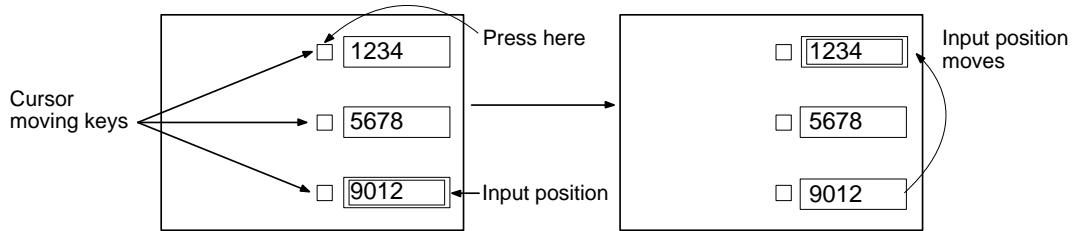

Window Move

By pressing a touch switch on a window, the window can be moved by touch panel operation at PT.

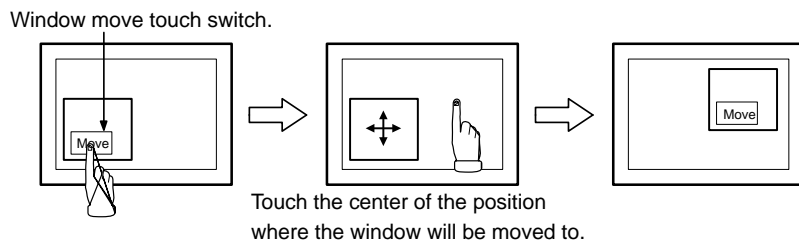

Screen Print Key Function (NT31/NT31C and NT631/NT631C Only)

This function allows a hard copy of the currently displayed screen to be printed out at a printer connected to the PT by pressing a touch switch.

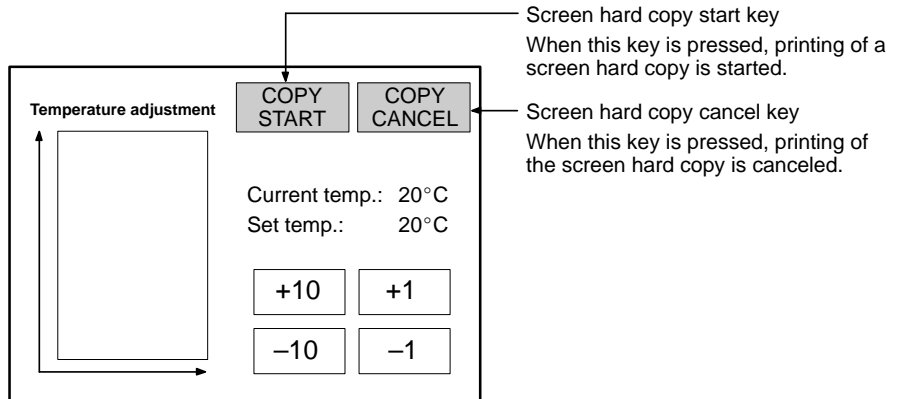

Restrictions

- A maximum of 256 touch switches can be registered for one screen. (Same for window screen.) For overlapping screens comprising 8 child screens, the maximum is 256 per screen.

There is no restriction on the number of touch switches that can be registered for one screen data file: any number can be registered as long as the data file capacity is not exceeded. However, if a large number of elements are registered, check that the restrictions on element display are complied with by referring to Display Restrictions (page 437).

- When polygons are used as the display graphics for touch switches, one polygon can be given up to 255 vertices.
- Up to 256 touch switches can be stacked together. If an overlapping area is pressed, all of the touch switch functions will be executed. Except for functions communicating to the host, only one function can be executed at a time, so just

stack one touch switch when stacking touch switches with functions other than communicating to the host. Touch switches that communicate to the host can all communicate notifications to the host at the same time.

Common Attributes

The settings common to touch switches are indicated below. Depending on the function, further settings may be necessary.

Properties

General	
Position	Coordinates of the top left corner of the touch switch display area
Size	Width and height of the touch switch display area (dot units)
Frame	Presence/absence of a frame for the touch switch display graphic. Check mark (frame used)/No check mark (no frame)
Shape	Shape of the touch switch (display graphic) · Fixed-shape display frame No frame/Standard/Shadow/3-Dimension · Free-shape display frame Rectangle, Polygon, Circle, Sector
Show ON State	Whether or not the lamp is displayed in reverse video when a touch switch is pressed.
Color	
Frame	Color of the frame (valid only when a check mark is set for Frame above). (Colors other than black and white are available with the NT31C and NT631C only.) Black/Blue/Red/Magenta/Green/Cyan/Yellow/White
ON	Display color when the touch switch is ON (Colors other than black and white are available with the NT31C and NT631C only.) Black/Blue/Red/Magenta/Green/Cyan/Yellow/White
OFF	Display color when the touch switch is OFF (Colors other than black and white are available with the NT31C and NT631C only.) Black/Blue/Red/Magenta/Green/Cyan/Yellow/White/Transparent
Settings	
Function	Processing functions executed when touch switches are pressed · Notify Bit · Switch Screen · Input Key – Control · Input Key – String · Input Key – Keyboard · Copy Setting · Cursor Move · Window Move · Print Screen (NT31/NT31C and NT631/NT631C Only)

Light Function	
Address	
PC Bit Address	Allocated bit for displaying the touch switch (See Allocated bit on page 125.)
I/O Comments	Comment that indicates the contents of the allocated bit Character string of up to 16 alphanumerics and symbols
Lamp Attribute	
On Type	Inverted display of the display graphic when the touch switch is ON (ineffective when Shadow and 3-Dimension is set for Shape) Light/Flash
Guide Characters	
Display	Presence/absence of character string (guide characters) attached to the touch switch Check mark (display)/No check mark (don't display)
Type	Type of character string attached to the touch switch Fixed character string, ON/OFF switching, numeral display, or character string display
Guide character settings (Refer to <i>Guide Character Type</i> on page 115.	
Interlock Function	
Interlock	Presence/absence of interlock control of touch switch operation Check mark (interlock)/No check mark (don't interlock)
PC address settings	
PC bit address	Allocated interlock bit used to enable/disable operation of the touch switch (See Allocated bit on page 125.)
I/O comments	Comment that explains the allocated bit. Up to 16 characters.

Lamp Shape

With Fixed-shape Display Frame

When a fixed-shape display is used, the lamp is displayed in the exact shape of the area that responds as a touch switch (the touch switch area).

When No frame is selected, only the label is displayed unless a light (flash) instruction is received from the host or the touch switch is pressed (if no label is set, nothing will be displayed unless the touch switch is pressed).

No frame

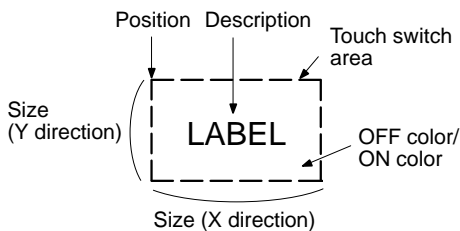

Standard

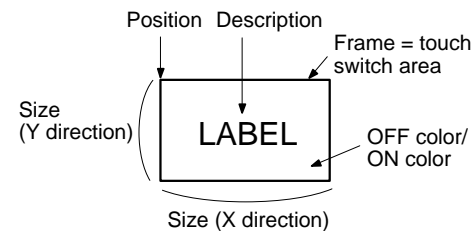

Shadow

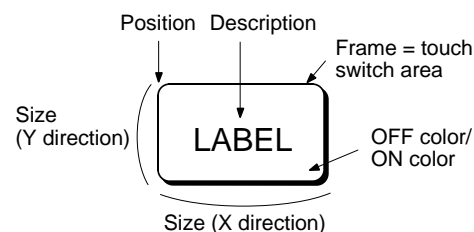

3-Dimension

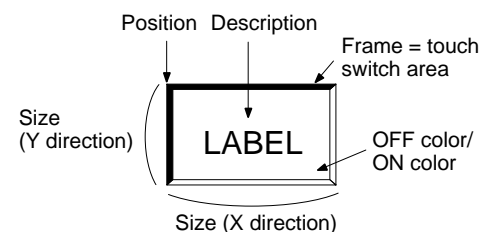

With Free-shape Display Frame

When a free-shape display frame is used, the display graphic can be set anywhere, independently of the area that responds as a touch switch (touch switch area).

Rectangle

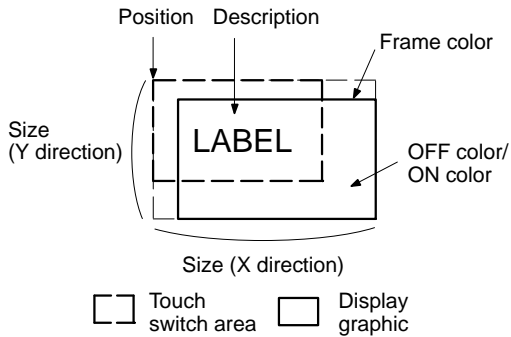

Polygon

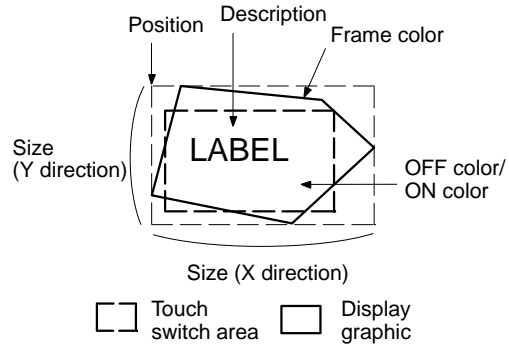

Circle

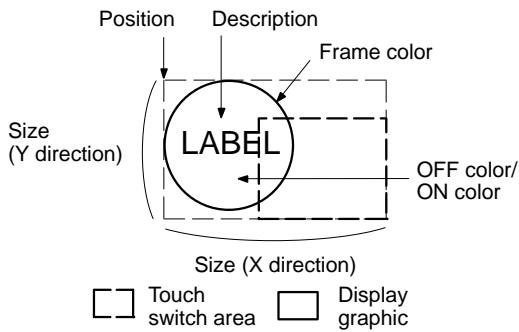

Sector

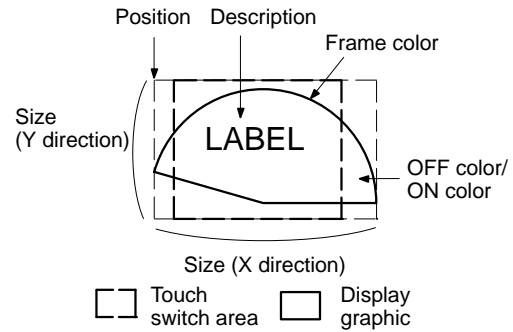

Allocated Bits

Bits can be allocated for lamp bits and interlock bits in the following host (PC) areas.

Symbol	C-series PCs	Allocation	CV-series PCs	Allocation	CS/CJ-series PCs	Allocation
None	IR Area	OK	CIO Area	OK	CIO Area	OK
H	HR Area	OK	---	---	HR Area	Not for Host Link
A	AR Area	OK	Auxiliary Area	No	AR Area	OK
L	LR Area	OK	---	---	LR Area*1	Not for Host Link
T	TC Area, Timer PVs	No	Timer Area, Timer PVs	No	TC Area, Timer PVs	No
TU	---	---	---	---	TC Area, Timer Completion Flags	Not for Host Link
C	TC Area, Counter PVs	No	Counter Area, Counter PVs	No	TC Area, Counter PVs	No
CU	---	---	---	---	TC Area, Counter Completion Flags	Not for Host Link
W	---	---	---	---	WR Area	Not for Host Link
TK	---	---	---	---	Task Flags	Not for Host Link

Symbol	C-series PCs	Allocation	CV-series PCs	Allocation	CS/CJ-series PCs	Allocation
D	DM Area	OK	DM Area	OK	DM Area	OK
E	EM Area *2, current bank	OK	EM Area, current bank	Not for Host Link	EM Area, current bank	Not for Host Link
E0_ to EC_	---	---	---	---	EM Area, EM banks 0 to C	Not for Host Link

*1: LR 00000 to LR 00199 are converted to CIO 01000 to CIO 01199.

*2: The EM Area is supported only by the C200HX/HG/HE(-Z)E PCs.

The Auxiliary Area of the CVM1 and CV-series PCs is allocated to system functions, and it cannot be used for purposes other than system use.

The range of each memory area differs according to the PC. Refer to *Appendix D PC Memory Maps* on page 441.

When a DM Area or EM Area address is specified, add a bit number (00 to 15) to the end of the word address.

Reference: For touch switches for which the host notification function is set, a bit must be allocated for host notification in addition to the lamp bit and interlock bit.

Display Functions

As with lamps, it is possible to set a graphic area for a touch switch that is displayed in different ways according to the status of a bit at the host. The bit at the host that is allocated to control the touch switch display is called a lamp bit.

The status of the lamp bit has the following effects.

0 (OFF): Lamp is OFF

1 (ON): Lamp is ON or flashing

Whether the lamp is ON or flashing when the lamp bit is set to 1 (ON) is determined by the setting made for the On Type property of the touch switch.

When a lamp bit is not allocated, touch switch performs only Show ON State function.

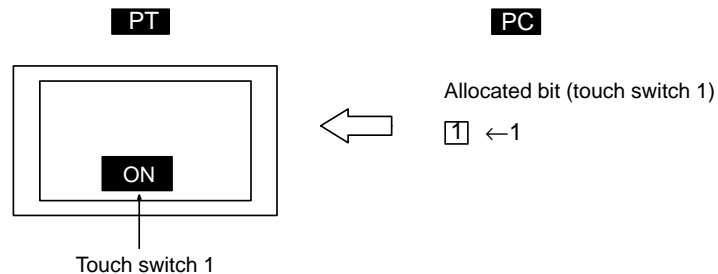

Like lamps, touch switches have four types of guide characters available: fixed character string, ON/OFF switching, numeral display, or character string display.

Input Functions

Switch Functions

The touch switch elements of the PT are arranged in a grid measuring 16 wide by 12 high on the screen. It is possible to create a single large rectangular touch switch using multiple touch switch elements.

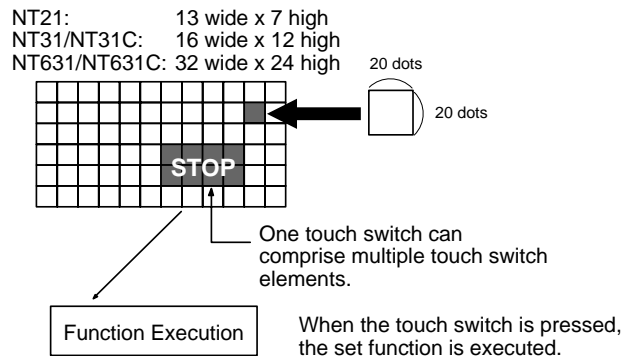

Size of Touch Switch Elements

Model	Width	Height
NT21-ST121□-E	9.0 mm	9.0 mm
NT31-ST121□-EV2 NT31C-ST141□-EV2	7.2 mm	7.2 mm
NT631C-ST141□-EV2	7.2 mm	7.2 mm
NT631-ST211□-EV2 NT631C-ST151□-EV2	6.6 mm	6.6 mm

If any one of the touch switch elements within the set touch switch area is pressed, this is interpreted as the touch switch as a whole being pressed, and the set function is executed.

When Show ON State is set, for a moment, the display graphic is displayed in reverse video when the touch switch is pressed.

Reference: If a touch switch with the screen switching function or pop-up keyboard function is pressed while another touch switch is still being pressed, the key function will not be executed. Release the other key first.

Interlock Function

The operation of a touch switch can be controlled (enabled/disabled) from the PC by setting the interlock function for the touch switch and allocating an interlock bit in a PC data area. The status of the allocated interlock bit is read and its status determines whether the touch switch is enabled or disabled.

The following table shows how touch switches operate when the interlock function is used or not used.

Interlock function	Operation
Used	The touch switch operation is enabled only while the interlock bit is ON. If the touch switch is pressed while the interlock bit is OFF, the buzzer will sound and the touch switch operation won't be performed.
Not used	The touch switch operation can be performed at any time.

The PT continuously reads the status of the corresponding interlock bit while a touch switch that uses the interlock function is being displayed on the screen. If the interlock bit's status changes, the touch switch's operation is disabled or enabled according to the interlock bit's status.

Output Functions

Touch switches can make the following outputs depending on the processing function set for them.

Host Notification Function

A bit at the host is overwritten in accordance with the set notification method.

Screen Print Key Function (NT31/NT31C and NT631/NT631C Only)

A hard copy of the currently displayed screen can be printed out at a printer connected to the PT.

For details, see Processing Functions below.

It is possible to sound the key press sound when a touch switch is pressed.

Whether or not the key press sound is sounded can be set at key press sound with memory switch. (Refer to the *Setup Manual* for details.)

Processing Functions

When a touch switch is pressed, the function set for it is executed.

There are nine functions that can be set for touch switches, as follows:

- Host notification function
- Screen switching function
- Control key function
- Character string input key function
- Window key function
- Copy key function
- Cursor moving key function
- Window move function
- Screen print key function (NT31/NT31C and NT631/NT631C Only)

Host Notification Function

This function notifies the host that a touch switch has been pressed.

When this function is used, a bit for notification (the notify bit) must be set for the touch switch. The input statuses of the touch switches displayed at the PT are always reflected by the notify bits. If the notify bit is not set, the touch switch will not function (it will function as a lamp only).

The properties for input notification are as follows:

Settings	
Address	
PC Bit Address	Allocated bit for touch switch notification (Allocation of the notify bit, page 130).
I/O Comments	Comment that indicates the contents of the allocated bit Character string of up to 16 alphanumerics and symbols
Action Type	Notification operation when the touch switch is pressed Momentary, Alternative, Set, Reset

Types of Notification Operation

The following four methods for notification to the host can be selected.

Momentary

While a touch switch is pressed the notify bit is ON; it goes OFF when the switch is released.



Alternate

Each time the touch switch is pressed, it goes OFF if it is ON, or ON if it is OFF. The status of the notify bit does not change when the touch switch is released.



Set

When the touch switch is pressed, the notify bit comes ON, and it remains ON after the switch is released.

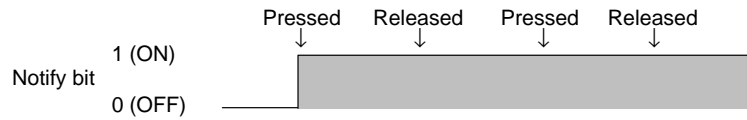

Reset

When the touch switch is pressed, the notify bit goes OFF, and it remains OFF after the switch is released.



Reference: If there the same bit is allocated for more than one momentary touch switch on one screen, and more than one switch is pressed and released at the same time, the OFF status will be notified each time one of the switches is released.

Notes on Notification Operations

The manner in which touch switch notification is executed differs according to the notification operation and communication method as follows:

Type of notification operation	<ul style="list-style-type: none"> • Host link • NT link for C or CVM1/CV-series PCs in the DM or EM Area 	<ul style="list-style-type: none"> • NT link for C or CVM1/CV-series PCs in an area other than the DM or EM Area • NT link for CS/CJ-series PCs in any area
Momentary Set	(1) Notification in word units (all other bits in the word are OFF)	(3) Notification in bit units
Reset	(2) Notification in word units (note that the word contents are read on display and notification is based on these contents)	(4) Notification in bit units
Alternate		

When using touch switch input notification, note the following points.

- In the case of (1) in the table, the other bits in the same word are turned OFF by notification.

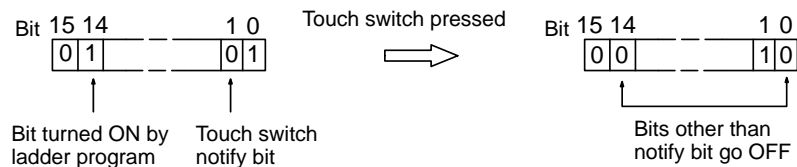

- As shown in the example above, the only bits that are turned OFF are the ones that were turned ON by processes other than PT operations, such as the ladder program or a Programming Device.

In the NT21, NT31/NT31C, and NT631/NT631C, changes to bits by PT processes are always reflected correctly so the same word can be allocated for the momentary, alternate, set, and reset touch switches. (In the earlier NT20S, NT30/NT30C, and NT620S/NT620C/NT625C PTs, the same word could not be allocated for the momentary touch switch because the other switches' operations would turn OFF the momentary touch switch's ON notification.)

- In the case of (2) in the table, since notification is executed on the basis of the contents of the word before the display, the other bits in the word are not over-

written. However, if the contents of the word are changed at the host during display, they will be rewritten based on the contents before display.

- If the screen is switched while a momentary touch switch is pressed, the touch switch itself will disappear and the OFF status will be notified to the host. Therefore, in the case of (1) in the table, all the bits in the word will be set to the OFF status.
- When using the host link, since writing in bit units is not possible, the statuses of bits other than the notify bit in the word allocated for a momentary/set/reset touch switch are not retained when the screen is switched.
- If the status of a bit allocated for an alternate touch switch is changed other than by touch switch operation — for example by Programming Console operation — the correct operation of the alternate touch switch cannot be guaranteed from that point onward (the ON and OFF states may be transposed).
- In the case of (3) and (4) in the table above, notification has no effect on the other bits in the word.

Reference: In the case of (1) in the table above, even a bit whose status is retained by the KEEP instruction for ladder program self latch operation will be turned OFF. In order to avoid this, allocate bits other than in the DM Area when using the NT link also.

Allocation of the Notify Bit

The notification bit can be allocated in the following host (PC) areas.

Symbol	C-series PCs	Allocation	CV-series PCs	Allocation	CS/CJ-series PCs	Allocation
None	IR Area	OK	CIO Area	OK	CIO Area	OK
H	HR Area	OK	---	---	HR Area	Not for Host Link
A	AR Area	OK	Auxiliary Area	No	AR Area	OK
L	LR Area	OK	---	---	LR Area ^{*1}	Not for Host Link
T	TC Area, Timer PVs	No	Timer Area, Timer PVs	No	TC Area, Timer PVs	No
TU	---	---	---	---	TC Area, Timer Completion Flags	Not for Host Link
C	TC Area, Counter PVs	No	Counter Area, Counter PVs	No	TC Area, Counter PVs	No
CU	---	---	---	---	TC Area, Counter Completion Flags	Not for Host Link
W	---	---	---	---	WR Area	Not for Host Link
TK	---	---	---	---	Task Flags	Not for Host Link
D	DM Area	OK	DM Area	OK	DM Area	OK
E	EM Area ^{*2} , current bank	OK	EM Area, current bank	Not for Host Link	EM Area ^{*3} (Current Bank)	Not for Host Link
E0_ to EC_	---	---	---	---	EM Area, EM banks 0 to C	Not for Host Link

*1: LR 00000 to LR 00199 are converted to CIO 01000 to CIO 01199.

*2: The EM Area is supported only by C200HX/HG/HE(-Z)E PCs.

*3: The EM Area current bank cannot be used in CS/CJ-series PCs when a 1:N NT Link (standard or high-speed) is being used through a Serial Communications

Board or Serial Communications Unit. An error will occur during PT operation if a bit is specified in a CS1-series PC's EM current bank.

The Auxiliary Area of the CVM1 and CV-series PCs is allocated to system functions, and it cannot be used for purposes other than system use.

The range of each memory area differs according to the PC. Refer to *Appendix D PC Memory Maps* on page 441.

When a DM Area or EM Area address is specified, add a bit number (00 to 15) to the end of the word address.

Screen Switching Function

This function allows the screen to be switched by touch switch operation at the PT, without instructions from the host.

When this function is used, the screen to be displayed is set for the touch switch. When the touch switch is pressed, the display switches to the set screen (at this time, the new screen number is notified via the PT status notify area).

- Reference:**
- When a screen with a number other than those indicated below is allocated to a touch switch, the screen does not switch and the currently displayed screen remains displayed.
 - The screen can also be switched by PT status control area operation (page 299), by bit memory table operation (page 302), and by the alarm/history function (page 303).
 - To display overlapping screens, specify the screen number of the parent screen.

The attributes for screen switching are as follows:

Settings	
Screen No.	Screen number of newly displayed screen (See note.) 1 to 3999, 9001, 9002, 9020, 9021 to 9023, 9030, 9999

Note The following screen numbers are not supported by the NT21:
9021 to 9023 and 9030.

Specified Screen Number and Display Operation

The display operation at the PT depends on the specified screen number, as follows:

- Screen Nos. 1 to 3999
The display switches to the screen with the specified screen number. The screen number of the newly displayed screen is notified to the host.
- Screen No. 9001
The display history (occurrence order) screen is displayed. Screen number 9001 is notified to the host.
- Screen No. 9002
The display history (frequency order) screen is displayed. Screen number 9001 is notified to the host.
- Screen No. 9020
The Programming Console screen is displayed. Screen number 9020 is notified to the host.

This makes it possible to use the Programming Console function even in the RUN mode.

(However, the Programming Console function can be used only when the PT is connected to a PC that can use the Programming Console function.) The RUN mode is cancelled while the programming function is being used. Also, monitoring of PT control area, data logging function for trend graphs, alarm history monitoring, and mathematical functions are not

executed. To return from the Programming Console function, exit this function, by PT operation. (It is not possible to exit this function from the host.)

- Screen No. 9021, 9022, or 9023

The Device Monitor function's screens are displayed. The displayed screen's screen number (9021 to 9023) is notified to the host. (These screen numbers are not supported by the NT21.)

The Device Monitor function can be used even in RUN mode, although this is the case only when the PT is connected to a PC that can use the Device Monitor function.

The PT can continue operating even when executing the Device Monitor function. The PT continues monitoring the status of the PT status control area, logging trend graph data, and monitoring the status of the alarm history.

When resetting from the Device Monitor function, either terminate the Device Monitor function with operations at the PT or switch to another screen by executing a PT status control area operation from the host.

- Screen No. 9030

The brightness and contrast adjustment screen is displayed. The screen number (9030) is notified to the host. (This screen number is not supported by the NT21.)

- Screen No. 9999

The screen displayed immediately before is displayed again. The screen number of the screen displayed is notified to the host.

Here, the touch switch functions as the screen switchover return key.

Screens other than No. 9999

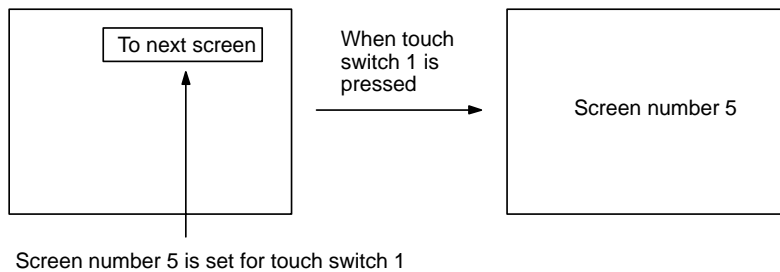

Screen No. 9999

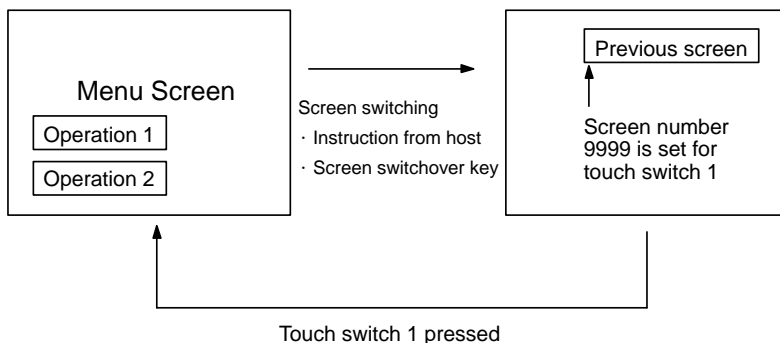

Character String Input Key Function

Used to input character strings when using the character string input function. The following table shows the attributes to be set for the character string input function.

Settings	
Character string	Up to 40 characters can be specified.

Guide characters can be copied when the guide character type is set to fixed character string or ON/OFF switching character strings. The OFF character string will be copied if the ON/OFF switching type is specified. Also, only the first line will be copied if there are multiple lines of guide characters. If the length of the source string exceeds 40 characters, only the first 40 characters will be copied.

- Reference:**
- Input into character string input fields is also possible using the control key touch switches (0 to 9, A to F), and from a bar code reader connected to the PT.
 - A control key touch switch (ENT or ) is also necessary to confirm input character strings when character string setting is used.



Control Code Input Function

Control keys are used as numeric keys (0 to 9, A to F) for the numeral input function, and as special keys with fixed functions. By assigning a control key to a touch switch, it can be used to execute a specific function.

The attributes for control keys are as follows:

Settings	
Control key	Set control key

The following functions can be set for touch switch control keys.

Key	Function
0 to 9, A to F	Used to input numerals (1 digit)
CLR	Clears numeric values and character strings in input fields
±	Assigns the opposite sign to input numeric values
.	Used to input a decimal point
HOME	Used to move to the input field at the top left of the screen
↑, ↓, ←, →	Used to move to the required input field
	Confirms input without shifting to another input field
	Stops the buzzer
↑, ↓	Shift between input fields
MENU	Used to display the System Menu
CA	Cancel text input
BS	Deletes the numeral or character immediately preceding the input cursor
DEL	Deletes the numeral or character at the input cursor location
◀, ▶	Used to shift the input cursor
ENT	Confirms input (after confirmation, the cursor shifts to the next input field)

Pop-up Window/Keyboard Function

This function is used to control the opening and closing of windows when using the window function (2-15 *Window Function*, page 237).

- Reference:**
- When the window opening bit of the PT status control area is set to 1 (disabled), it is not possible to open windows by operations at the PT such as touch switch operations.
 - By associating windows with the cursor moving key touch switches with the Support Tool, windows can be opened by pressing the cursor moving keys.
 - It is not possible to control a global window by touch switch operation.

The attributes for the window key are as follows:

Settings	
Screen No.	
Local 1 (Keyboard)	Check this attribute when the local window 1 is to be controlled. • Specify the screen number of the window to be controlled. 1 to 3999
Local 2	Check this attribute when the local window 2 is to be controlled. • Specify the screen number of the window to be controlled. 1 to 3999
Window Position	
X	X coordinate of bottom-left corner (multiple of 20) NT21: 0 to 240 NT31/NT31C: 0 to 300 NT631/NT631C: 0 to 620
Y	Y coordinate of bottom-left corner (multiple of 20 - 1) NT21: 19 to 139 NT31/NT31C: 19 to 239 NT631/NT631C: 19 to 479
Action Type	Controlling method of the window Open/Close/Toggle
Replace Local Window	Specify the behavior of the window when the other window of the same type (Local 1/Local 2) is already opened. Check mark (replace)/No check mark (no replace)

The window behaves as follows according to the settings for Action Type and Replace Local Windows:

Behavior According to the Action Type

- Open:** Opens the specified window by the specified type (local 1 or local 2). Whether or not the window is actually opened depends on the display status and the setting for Replace Local Window. The window is displayed at the position that is specified with the Window Position setting. If the other window of the same type is already opened, the behavior is determined according to the setting for Replace Local Window. If the specified window does not exist, no operation is performed.
- Close:** Closes the specified window of the specified type (local 1 or local 2). When the close window key is pressed, the specified window that is presently displayed by the specified type is closed. If the specified window is not displayed by the specified type, no operation is executed.
- Toggle:** Opens or closes the specified window of the specified type (local 1 or local 2). If the specified window is not displayed by the specified type, the specified window is opened in the same way as the Open window key. Whether or not the window is actually opened depends on the display status and the setting for Replace Local Window. The window is displayed at the position that is specified with the Window Position setting.

If the other window of the same type is already opened, the behavior is determined according to the setting for Replace Local Window.
 If the specified window does not exist, no operation is performed.
 If the specified window is already displayed by the specified type, the window is closed in the same way as Close window key.

Behavior According to the Replace Local Window

Check mark: If the other window of the same type is already displayed, the displayed window is closed first, and then the specified window is opened.

No check mark: If the other window of the same type is already displayed, no operation is performed.

Copy Key Function

This function is used to copy the data or constants in a memory table entry to another memory table entry or an input field. It is useful for setting numeral/character string displays to their initial state, and for inputting the same contents (e.g. initial values) into multiple numeral/character string setting input fields.

Copying is possible between the following combinations.

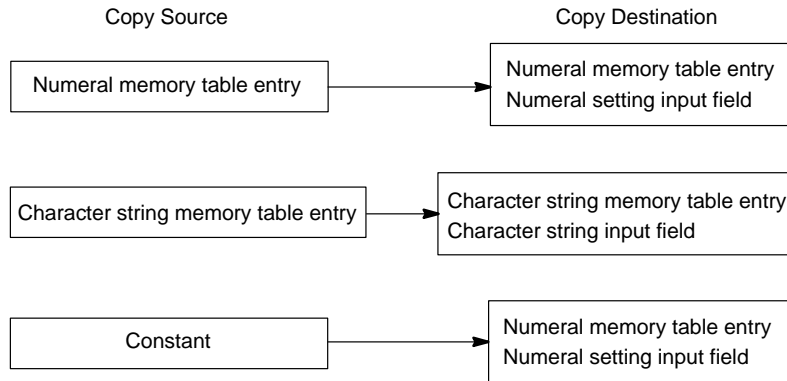

- Reference:**
- It is also possible to copy between memory table entries by operation with the PT status control area.
 - If the contents of a numeral/character string memory table entry have been changed by operation at the PT such as use of the copy key the change is notified to the PT status notify area at the host.

The attributes for the copy key are as follows:

Settings		
Copy From		
Type	Type of copy source Numeral table entry String table entry Code	
Memory Table Entry Number/Fixed Value	Copy source memory table entry number, or value if a constant · For a numeral/character string memory table entry 0 to 1999 · For a constant -2147483648 to 2147483647	
Copy To		
Type	Type of copy destination Numeral table entry String table entry Cursor Position (numeral/character string input field)	
Memory Table Entry Number	Memory table entry number of the copy destination (setting ineffective if Cursor Position is set for Copy To) 0 to 1999	

Cursor Moving Key Function

This function moves the cursor to a pre-designated numeral/character string input field in preparation for input.

It is also possible to open a designated window simultaneously with the cursor motion, and to automatically display a window in accordance with the input field.

Reference:

- Cursor moving keys can also be created automatically when a numeral/character string input field is registered on a screen.
- Input fields can also be designated using the input key – control.

The attributes for the cursor moving keys are as follows:

Settings	
Use Window/Keyboard Screen	
	Open window/keyboard? Check mark (open)/No check mark (do not open)
Screen No.	
Local 1 (Keyboard)	Screen number of the window/keyboard to be opened (setting effective only if a check mark is set for Local 1 (Keyboard) of Use Window/Keyboard Screen) 1 to 3999
Local 2	Screen number of the window to be opened (setting effective only if a check mark is set for Local 2 of Use Window/Keyboard Screen) 1 to 3999
Window Position	
X	X coordinate of bottom-left corner (multiple of 20) NT21: 0 to 240 NT31/NT31C: 0 to 300 NT631/NT631C: 0 to 620
Y	Y coordinate of bottom-left corner (multiple of 20 - 1) NT21: 19 to 139 NT31/NT31C: 19 to 239 NT631/NT631C: 19 to 479
Replace Local Window	Designate the behavior when other window of the specified type (local window 1/local window 2) is already opened Check mark (replace)/No check mark (do not replace)
Auto Arrange	
	Move together with the input field associated in editing at the Support Tool? Check mark (yes)/No check mark (no)

- Settings and action type of window to be used when using Use Window/Keyboard Screen is same as the input key-window/keyboard function that has Open action type.

Refer to *Window Key Function* (page 133).

Window Moving Key Function

This function moves a window by pressing a window moving key, which is pre-registered on a window, while the PT is running.

Window moving key can be registered on a window screen.

- Reference:**
- Window can be moved also by the operation of window control area. (Refer to page 311.)
 - Window moving key can be used only on a local window. It does not function if the window screen is displayed as a global window.

Window moving key has no special attributes.

Moving a Window By the Operation of a Window Moving Key

To move a window by the operation of a window moving key, follow the procedure below.

- 1, 2, 3...**
1. Pre-register a window moving key on the window to be moved.
 2. Press the window moving key on a window to be moved while the PT is running.

The window is changed to the frame display only as follows, with the \oplus mark at the center of it:

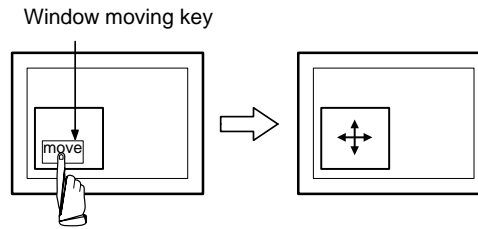

3. Press the touch panel of the PT at the moving destination.
Window is moved so that the center position of the window comes to the pressed position.
This time, Display Position of the corresponding window area is changed.

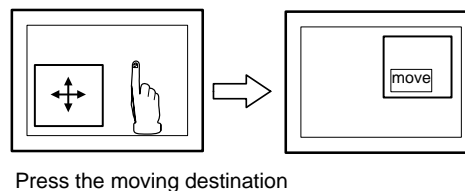

When the window is in a moving status (while \oplus mark is displayed at the center of the window), the following points differ from the normal running status.

- The elements that use the touch panel as an input do not function regardless of the screens (base/window) they are registered on. Only the specification of the window moving destination is possible.
- Switching to the system menu is not possible.
- Screen switching or window controlling due to the change in bit memory table entry, PT status control area or window control area is not possible.
- Screen saver function does not work.
- There is no time-limit for a window moving status. It will not return to the normal running status until the moving destination is specified.

-
- Reference:**
- Window moves by a minimum touch switch size (20 20).
 - Be sure to complete all the window moving operation when in the window moving status, since its behavior differs from the one when in the normal running status.
-

Screen Print Key Function (NT31/NT31C and NT631/NT631C Only)

This function allows starting and stopping of the printing of a hard copy of the currently displayed screen (screen image) at a printer connected to the PT. (This function is not supported by the NT21.)

-
- Reference:**
- The PT continues operating during printing.
 - The printer type and printing method (color/monochrome (8 grayscale levels)) is determined by memory switch setting at the PT.
 - A hard copy of the screen can also be printed by operation with the PT status control bits. In this case also, printing can be stopped part way through by pressing a touch switch.
-

The attributes for screen printing are as follows:

Settings	
Print Screen	
Printing of Display Screen	Set whether the touch switch is to start printing or stop printing. Start/Abort

Relationship with Other Elements

- By using input key – string and input key – control in combination with Numeral Input (page 192) and String Input (page 210), numeric values and character strings can be input.
 Registering these keys in windows makes it possible to switch among windows as required for versatile input.
- Special touch switches with specific functions (input key – control) are automatically created for the following elements.
 Trend graphs (page 170), alarm list (page 182), alarm history (page 182), thumbwheel switches (page 200), recipes (page 216)
- Touch switches overlap with other elements according to the order in which the elements were registered on the screen with the Support Tool.

2-8 Numeral Display

Function Outline

The contents of numeral memory table entries are displayed as numeric values. The values can be displayed either in decimal or hexadecimal notation.

There are two methods for referencing a numeral memory table entry whose contents are to be displayed, as follows:

- Direct reference (reference of the number of the relevant numeral memory table entry)

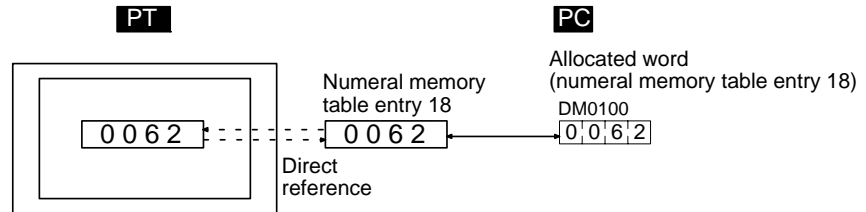

- Indirect reference (reference of the numeral memory table entry that stores the number of the relevant numeral memory table entry)

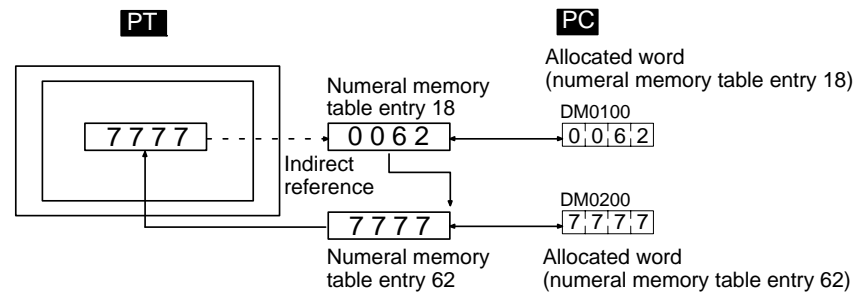

Restrictions

- A maximum of 256 numeral displays can be registered for one screen. (Same for window screen.) For overlapping screens comprising 8 child screens, the maximum is 1,024.

There is no restriction on the number of numeral displays that can be registered for one screen data file: any number can be registered as long as the data file capacity is not exceeded. However, if a large number of elements are registered, check that the restrictions on element display are complied with by referring to Display Restrictions (page 437).

- The maximum number of numeral display that can be displayed using indirect reference is 100 per screen combined with the number of character string display that is displayed using indirect reference. (Same restriction applies to overlapping screens or when displaying window screens.)
- The range of numeric values that can be displayed depends on the Storage Type (BCD or Binary), Display Type (Decimal or Hexadecimal), and Display Sign settings made for the numeral memory table entry. For details, refer to 2-3 *Numeral Memory Table* (page 72).

Common Attributes

The relationship between the properties of a numeral display and the displayed numeric value is indicated below.

Properties

General	
Position	Coordinates of the top left corner of the field in which the numeric value is displayed.
Font Type	Font for the characters Standard/Half Height/Double Width
Scale	Scale at which the numeric value is displayed (Enlarged display, page 142). 1 1 (Equal), 1 2 (High), 2 1 (Wide), 2 2, 3 3, 4 4, 8 8
Smoothing	Whether or not smoothing is used for numerals with a scale of 2 2 or larger (Smoothing, page 143). Check mark (smoothing executed)/ No check mark (smoothing not executed)
Attribute	Display mode for the numerals (Display attributes and drawing result, page 142). Standard/Flash/Inverse Flash
Color	
Foreground	Display color of the numerals (Colors other than black and white are available with the NT31C and NT631C only.) Black/Blue/Red/Magenta/Green/Cyan/Yellow/White
Background	Background color of the numerals (Colors other than black and white are available with the NT31C and NT631C only.) Black/Blue/Red/Magenta/Green/Cyan/Yellow/White
Settings	
Reference	
Indirect Reference	Method for referencing the numeral memory table entry (Direct reference and indirect reference, page 143) Check mark (Indirect Reference)/ No check mark (Direct Reference)
Table Entry	Numeral memory table entry number referenced for display (Direct reference and indirect reference, page 143) 4-digit BCD value · When Direct Reference is specified: Table entry number of the numeral memory table entry in which the numeric value to be displayed is stored · When Indirect Reference is specified: Table entry number of the numeral memory table entry in which the number of the numeral memory table entry whose contents are to be displayed is stored.
Display Type	Display format for the numeric value (Stored data and displayed numeric value, page 144) Decimal/Hexadecimal
Format (Number of digits displayed, page 143)	
Integer	Number of digits in the integer part of the numeric value
Decimal	Number of digits in the decimal fraction of the numeric value

Settings	
Zero Suppression	Whether or not zero suppression is used (Zero suppression, page 144) Check mark (zero suppression used)/ No check mark (zero suppression not used)
Display Sign	Whether or not negative numbers are indicated (setting ineffective if Hexadecimal has been set for Display Format) Check mark (negative numbers indicated)/ No check mark (negative numbers not indicated)

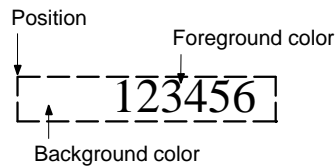

Enlarged Display

Numeric values can be displayed at the following scales.

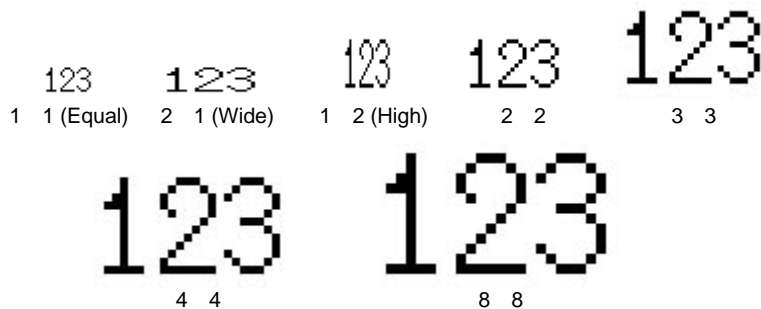

With ISO 8859-1 font type, the numerals of 2 2 or larger scale are automatically displayed in 32 dot high-definition font.

Reference: The 32 dot high-definition font is not displayed for the following models (16 16 dot font is used.)

- NT31-ST121□-E
- NT31C-ST141□-E
- NT631-ST211□-E
- NT631C-ST141□-E
- NT631C-ST151□-E

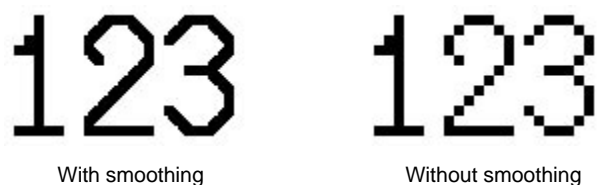

Smoothing

Characters enlarged to a scale of 2 2 or greater can be displayed with the outline automatically smoothed. This function is called smoothing.



Smoothing is not performed for high-definition font.

Display Attributes And Drawing Result

Attribute	Drawing Result
Standard	The numeral display is displayed with the specified foreground color and background color. 
Flash	Repeated alternation of the standard display and no display. 
Inverse Flash	Repeated exchange of the foreground color and background color. 

Direct Reference and Indirect Reference

Direct reference is a method whereby the memory table entry whose contents are to be displayed is specified directly.

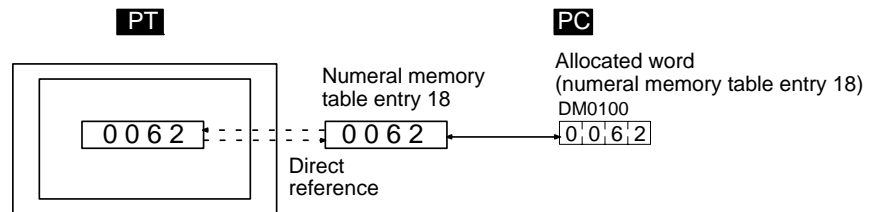

In indirect reference, the numeral memory table entry whose contents are to be displayed is not specified directly. The contents of the specified numeral memory table entry (a numeric value) are regarded as the number of a numeral memory table entry, and the contents of this numeral memory table entry are displayed. Note that more processing time is required for indirect reference than for direct reference.

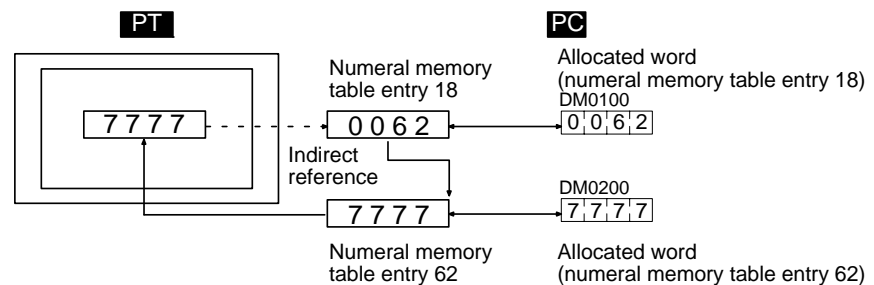

Number of Digits Displayed

All contents of numeral memory table entries are stored as integers. To display a numeric value that has a decimal fraction, set the decimal setting to 1 or higher to specify the number of places after the decimal point, then a decimal point is automatically inserted.

Note that if the number of digits of the numeric value is greater than the total of the settings for Integer and Decimal, an error occurs and * is displayed for all the digits.

An example is given below (here, the check mark is assumed to be set for Zero Suppression).

Example: Displaying 123456

- Setting for Integer = 8; setting for Decimal = 0:
Resulting display: 00123456

- Setting for Integer = 4; setting for Decimal = 4:
Resulting display: 0012.3456
- Setting for Integer = 2, setting for Decimal = 4:
Resulting display: 12.3456
- Setting for Integer = 1, setting for Decimal = 4:
Resulting display: *.****

Zero Suppression

The numeric value is displayed right-justified within the sum of the number of digits specified for Integer and the number of digits specified for Decimal. Normally, when the number of digits of the numeric value is small, the excess digits at the left side are filled with zeros. When the check mark is set for Zero Suppression, no zeros are set in the excess digits and they remain blank.

00012345	12345
Without zero suppression (when the number of digits displayed is 8)	With zero suppression

Stored Data and Displayed Numeric Value

The conversion method for display and the range of numeric values that can be displayed depend on the following settings.

Display Type (Decimal/Hexadecimal)

Display Sign (whether or not negative values are displayed)

Conversion Depending on Display Type

The data stored in a numeral memory table entry is converted as follows depending on the setting for Display Type:

- Decimal:
The numeric value (signed binary data) stored in the numeral memory table entry is converted to decimal notation.
- Hexadecimal:
The numeric value (signed binary data) stored in the numeral memory table entry is displayed without alteration.

Reference: Numeral memory table entries store numeric values as signed binary data.

Effect of Sign on Conversion

For unsigned decimal values, if the result of conversion of the data in a numeral memory table entry is negative, it is displayed after conversion to an absolute value.

For signed decimal values, if the result of conversion is a negative value it is displayed with a minus sign –.

Permissible Display Range

The permissible display range depends on the settings made for Display Type and Display Sign, as follows:

Display Type	Sign	Permissible Display Range
Decimal	Unsigned	0 to 2147483648*
	Signed	–2147483648 to 2147483647
Hexadecimal	–	0 to FFFFFFFFH

When displaying the contents of host words allocated for numeral memory table entries, not only the numeral display properties but also the Storage Type and Words settings made for the numeral memory table entry have an effect on the permissible display range. The permissible display range is determined as follows depending on these properties:

Storage Type	Words	Display Type	Sign	Permissible Display Range
BCD	1	Decimal	Unsigned	0 to 9999
			Signed	-999 to 9999
		Hexadecimal	-	0 to 270FH
	2	Decimal	Unsigned	0 to 99999999
			Signed	-99999999 to 99999999
		Hexadecimal	-	0 to 5F5E0FFH
Binary	1	Decimal	Unsigned	0 to 32768*
			Signed	-32768 to 32767
		Hexadecimal	-	0 to FFFFH
	2	Decimal	Unsigned	0 to 2147483648*
			Signed	-2147483648 to 2147483647
		Hexadecimal	-	0 to FFFFFFFFH

* Note that this range is different from that for numeral input (page 197). 32768 is displayed when the contents of the numeral memory table entry is 8000H (-32768), and 2147483648 is displayed when the contents of the memory table entry is 80000000H (-2147483648). This is because when the value is unsigned, only the sign is omitted and the numeric value is displayed as an absolute value. It is not possible to input 32768 or 2147483648 as positive values.

Relationship between Contents of Host Words and Displayed Numeric Value

When displaying the contents words allocated for a numeral memory table entry in the host, the contents of the word is first converted to the format for storage in the numeral memory table entry (signed hexadecimal), and then converted again in accordance with the settings for Display Type and Display Sign settings in order to display them. Therefore the result also differs according to the settings made for Words and Storage Type.

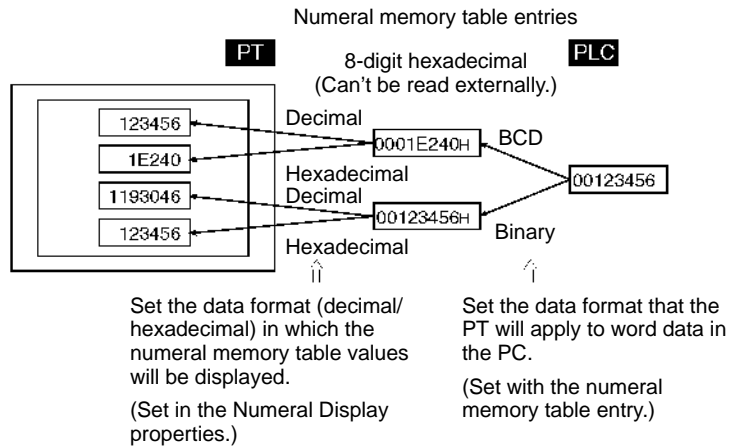

An example is given below.

Contents of word at host	Storage Type	Words	Numeric value stored in numeral memory table	Display Type	Sign	Displayed numeric value	
1234	BCD	1	000004D2H	Decimal	Unsigned	1234	
F123			FFFFFF85H			123	
F0001234		2	FFFFFB2EH			1234	
1234		1	000004D2H		Signed	1234	
F123			FFFFFF85H			-123	
F0001234		2	FFFFFB2EH			-1234	
1234		Binary	1	000004D2H	Hexadecimal	-	4D2
F123				FFFFFF85H			FF85
F0001234			2	FFFFFB2EH			FFFFFB2E
1234	Binary		1	00001234H	Decimal	Unsigned	4600
F123				FFFFF123H			3805
F0001234			2	F0001234H			268430796
1234		1	00001234H	Signed	4660		
F123			FFFFF123H		-3805		
F0001234		2	F0001234H		-268430796		
1234	Binary	1	00001234H	Hexadecimal	-	1234	
F123			FFFFF123H			F123	
F0001234		2	F0001234H			F0001234	

Reference: Data is stored in the numeral memory table entry as signed data with a data length of 4 bytes.

If the setting for Storage Type is BCD, the contents of the host word(s) (BCD data) are converted to signed binary (hexadecimal) data and then stored in the numeral memory table entry. If the most significant digit in the word contents is F, it is regarded as a negative value. If the BCD data is not correct, it is not read out and the existing value is retained.

If the setting for Storage Type is Binary, the contents of the host word(s) are stored in the numeral memory table entry without alteration. However, if a negative value is written when the number of allocated host words is 1, the number of bits is increased to accommodate 2-word signed data before storage (refer to the example of F123 above).

When the numeric value for display is designated as unsigned, it is displayed as an absolute value.

Display Functions

In numeral display, the numeric values are displayed in accordance with the General settings.

For details on the method of display depending on the General settings, refer to *Common Attributes* (page 141).

Input Functions

Numeral displays have no input function.

Output Functions

Numeral displays have no output function.

Processing Functions

With numeral displays, the contents of numeral memory table entries are converted to displayed numeric values in accordance with the General settings.

For details on the method of conversion depending on the General settings, refer to *Common Attributes* (page 141).

Relationship with Other Elements

- The conversion method and display method used with numeral displays are the same as those used when displaying numeric values with numeral input (page 192).
- When numeral display is specified for a lamp or touch switch's guide character type, the characters are converted and displayed just like numeral displays. Refer to *Guide Character Type* on page 115 for more details on guide character types.
- For details on how numeric values are stored in the numeral memory table entry, refer to *2-3 Numeral Memory Table* (page 72).
- Numeral displays overlap with other elements in accordance with the order in which they were registered for the screen with the Support Tool. However, the way in which they overlap can be changed with the Support Tool.

2-9 Character String Display

Function Outline

The contents of character string memory table entries are displayed as character strings.

Alphanumerics and symbols can be displayed. It is also possible to display marks (character codes FF20 to FFFFH) in character strings.

There are two methods for referencing a character string memory table entry whose contents are to be displayed, as follows:

- Direct reference (reference of the number of the relevant character string memory table entry)

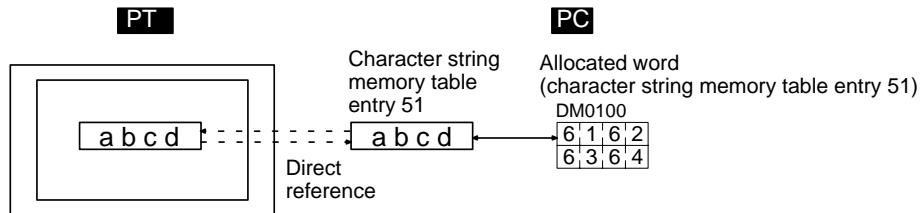

- Indirect reference (reference of the numeral memory table entry that stores the number of the relevant character string memory table entry)

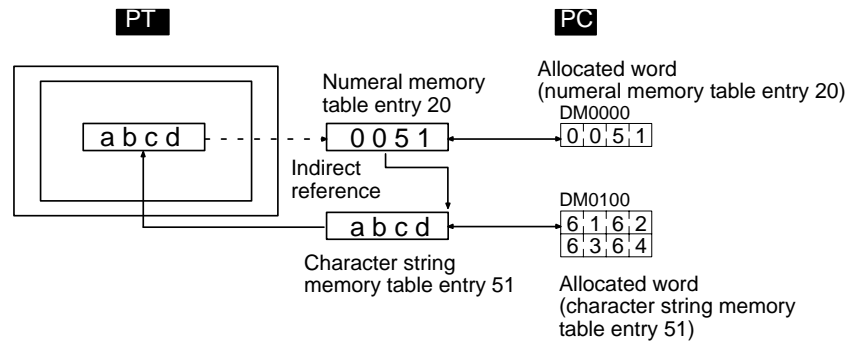

Reference: When the PT is in NT20S or NT30/620 compatible mode, image and library codes can be included in character string memory table entries. An image or library display might extend beyond the edge of the PT's screen when it is displayed by changing the contents of a character string memory table entry within a character string display. Refer to *Appendix C* for details on the NT20S and NT30/620 compatible modes (page 457).

Restrictions

- A maximum of 256 character string displays can be registered for one screen. (Same for window screen.) For an overlapping screen comprising 8 child screens, the maximum is 1,024.

There is no restriction on the number of character string displays that can be registered for one screen data file: any number can be registered as long as the data file capacity is not exceeded. However, if a large number of elements are registered, check that the restrictions on element display are complied with by referring to Display Restrictions (page 437).

- The maximum number of character string display that can be displayed using indirect reference is 100 per screen combined with the number of numeral display that is displayed using indirect reference. (Same restriction applies to overlapping screens or when displaying window screens.)
- The following numbers of characters can be displayed in one character string display, depending on the scale.

Magnification	NT21	NT31/NT31C	NT631/NT631C
1 1 (Equal)	Up to 32 characters	Up to 40 characters	Up to 40 characters
1 2 (High)	Up to 32 characters	Up to 40 characters	Up to 40 characters
2 1 (Wide)	Up to 16 characters	Up to 20 characters	Up to 40 characters
2 2	Up to 16 characters	Up to 20 characters	Up to 40 characters
3 3	Up to 10 characters	Up to 13 characters	Up to 26 characters
4 4	Up to 8 characters	Up to 10 characters	Up to 20 characters
8 8	Up to 4 characters	Up to 5 characters	Up to 10 characters

If the character string display size exceeds the screen size with the specified value, its display position is automatically changed so that the character string is displayed within the screen.

In case the character string display can not be displayed within the screen even if the Support Tool has changed its position, the error message will be displayed.

- The characters that can be displayed are alphanumeric, symbols and Marks. Marks are displayed at the standard height even if Half Height is set as the Font Type. Therefore, if normal alphanumeric and symbols are displayed after displaying a mark, part of the mark will remain displayed, as shown in the figure below.
- If Half Height is set for Font Type, and a character string is written after displaying Marks, a part of the Marks will remain displayed, as shown below.

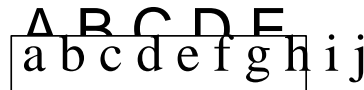

In this case, create blank characters as marks, write these marks, and then write the alphanumeric and symbol character string over them.

Common Attributes

The relationship between the properties of a character string display and the displayed character string is indicated below.

Properties

General	
Position	Coordinates of the top left corner of the field in which the character string is displayed.
Font Type	Font for the characters Standard/Half Height
Scale	Scale at which the character string is displayed (Enlarged display, page 151). 1 1 (Equal), 1 2 (High), 2 1 (Wide), 2 2, 3 3, 4 4, 8 8
Smoothing	Whether or not smoothing is used for characters with a scale of 2 2 or larger (Smoothing, page 151). Check mark (smoothing executed)/ No check mark (smoothing not executed)
Attribute	Display mode for the character string (Display attributes and drawing result, page 152). Standard/Flash/Inverse Flash
Color	
Foreground	Display color of the text (Colors other than black and white are available with the NT31C and NT631C only.) Black/Blue/Red/Magenta/Green/Cyan/Yellow/White
Background	Background color of the text (Colors other than black and white are available with the NT31C and NT631C only.) Black/Blue/Red/Magenta/Green/Cyan/Yellow/White
Settings	
Reference	
Indirect Reference	Method for referencing the character string memory table entry whose contents are to be displayed (Direct reference and indirect reference, page 152) Check mark (Indirect Reference)/ No check mark (Direct Reference)
Table Entry	Numeral memory table entry number referenced for display (Direct reference and indirect reference, page 152) · When Direct Reference is specified: Table entry number of the numeral memory table entry in which the character string to be displayed is stored. · When Indirect Reference is specified: Table entry number of the numeral memory table entry in which the number of the character string memory table entry whose contents are to be displayed is stored.
Length	Number of displayed characters NT21: 1 to 32 NT31/NT31C: 1 to 40 NT631/NT631C: 1 to 40

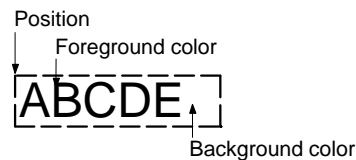

Enlarged Display

Character strings can be displayed at the following scales.

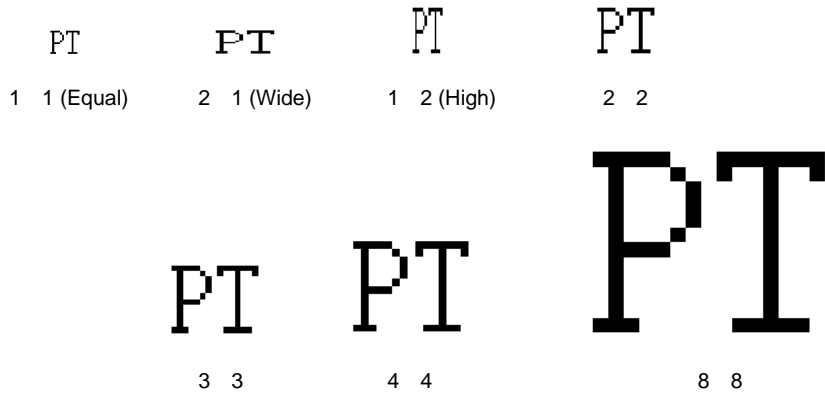

With ISO 8859-1 font type, the character strings of 2 2 or larger scale are automatically displayed in 32 dot high-definition font. However, the marks inserted into a string are always displayed in 16 16 dot font.

Reference: The 32 dot high-definition font is not displayed for the following models. (16 16 dot font is used.)

- NT31-ST121□-E
- NT31C-ST141□-E
- NT631-ST211□-E
- NT631C-ST141□-E
- NT631C-ST151□-E

Smoothing

Characters enlarged to a scale of 2 2 or greater can be displayed with the outline automatically smoothed. This function is called smoothing.

Note that smoothing cannot be used for marks.

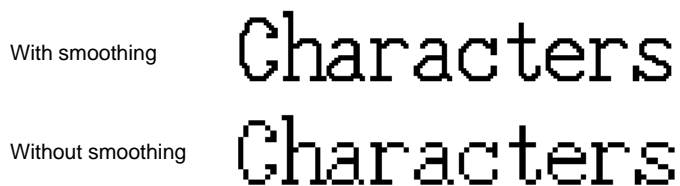



Smoothing is not performed for high-definition font.

Discrepancy Between Length and Number of Characters

If the actual number of characters of the data in the character string memory table entry is greater than the number specified for Length, the surplus part is ignored.

If the actual number of characters of the data in the character string memory table entry is less than the number specified for Length, the size of the field in which the character string is displayed is still determined by the settings for Length and Scale. In such cases the character is displayed left-justified, with spaces filling the superfluous part. Therefore if the contents of the numeral memory table entry change to fewer characters, the characters of the previous data do not remain displayed at the right side.

Display Attributes and Drawing Result

Attribute	Drawing Result
Standard	The character string display element is displayed with the specified foreground color and background color. 
Flash	Repeated alternation of the standard display and no display. 
Inverse Flash	Repeated exchange of the foreground color and background color. 

Direct Reference and Indirect Reference

Direct reference is a method whereby the memory table entry whose contents are to be displayed is specified directly.

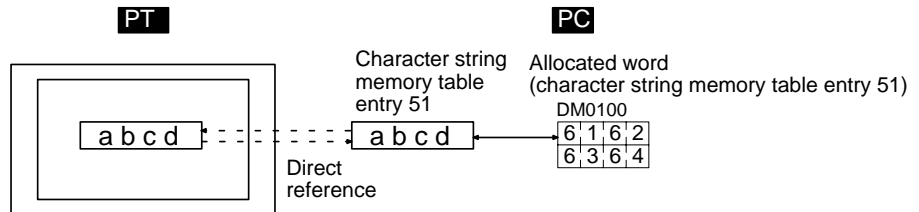

In indirect reference, the memory table entry whose contents are to be displayed is not specified directly: the contents of the specified numeral memory table entry (numeric value) are regarded as the number of a character string memory table entry, and the contents of this character string memory table entry are displayed. Note that more processing time is required for indirect reference than for direct reference.

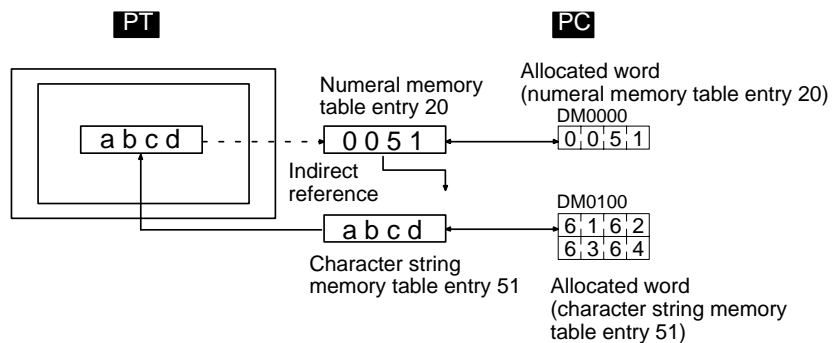

Display Functions

In character string display, the character string is displayed in accordance with the General settings.

For details on the method of display depending on the General settings, refer to *Common Attributes* (page 150).

Input Functions

Character string displays have no input function.

Output Functions

Character string displays have no output function.

Processing Functions

Character string displays have no processing function.

Relationship with Other Elements

- The conversion method and display method used with character string input (page 210) are the same as those used when for character string display.
- When character string display is specified for a lamp or touch switch's guide character type, the characters are just like character string displays. Refer to *Guide Character Type* on page 115 for more details on guide character types.
- For details on how character strings are stored in character string memory table entries, refer to *2-3-2 Character String Memory Table* (page 79).
- Character string displays overlap with other elements in accordance with the order in which they were registered for the screen with the Support Tool. However, the way in which they overlap can be changed with the Support Tool.

2-10 Graphs

The following three types of graphs can be used with the PT. The contents of memory table entries are read out, and the graph display is updated, automatically. If one or more words is allocated for the numeral memory table entry in the host, changes in the word or words are continually reflected in the graph.

- Bar graphs Page 154
- Analog meter Page 158
- Broken line graphs Page 164
- Trend graphs Page 170

2-10-1 Bar Graphs

Function Outline

The contents of a numeral memory table entry is displayed in the form of a bar graph.

The numeric value can also be indicated as a percentage of the designated numeric value.



Restrictions

- A maximum of 50 bar graphs can be registered for one screen. (Same for window screen.) For an overlapping screen comprising 8 child screens, the maximum is 400.

There is no restriction on the number of bar graphs that can be registered for one screen data file: any number can be registered as long as the data file capacity is not exceeded. However, if a large number of elements are registered, check that the restrictions on element display are complied with by referring to Display Restrictions (page 437).

Common Attributes

The relationship between the properties of a bar graph and the display results is indicated below.

Properties

General	
Position	Coordinates of the top left corner of the bar graph area.
Size	Width and height of the area in which the bar graph is displayed (dot units) NT21: Width: 2 to 260, Height: 2 to 140 NT31/NT31C: Width: 2 to 230, Height: 2 to 240 NT631/NT631C: Width: 2 to 640, Height: 2 to 480
Frame	Whether or not a frame is displayed for the graph area Check mark (frame displayed)/ No check mark (frame not displayed)
Display Sign	Whether or not a negative area is displayed. Check mark (displayed)/No check mark (not displayed)
Direction	Direction in which the bar graph extends (Incremental Direction of Bar Graphs, page 157) Up/Down/Left/Right
Color	
Frame	Display color of the frame (Colors other than black and white are available with the NT31C and NT631C only.) Black/Blue/Red/Magenta/Green/Cyan/Yellow/White
+ Range	Display color of the positive range (Colors other than black and white are available with the NT31C and NT631C only.) Black/Blue/Red/Magenta/Green/Cyan/Yellow/White
- Range	Display color of the negative range (Colors other than black and white are available with the NT31C and NT631C only.) (effective only when a check mark is set for Display Sign) Black/Blue/Red/Magenta/Green/Cyan/Yellow/White
Settings	
Value	
Table Entry	Number of numeral memory table entry whose contents are to be displayed.
Display %	Presence/absence of a percentage indication of the contents of the numeral memory table entry (Method for calculating the percentage value, page 157) Check mark (percentage displayed)/ No check mark (no percentage display) For details on the Display % properties, refer to the <i>Text (Fixed Display)</i> on page 97.
100%*1 (Specify 100% value using either of Table Entry or Value.)	
Table Entry	Numeral memory table entry number checked to find the 100% value for percentage calculations · Designate the number of the numeral memory table entry that stores the 100% value. Range: 0 to 1999
Value	Checked to find the 100% value for percentage calculations · Designate the 100% value (default: 100) Range: -2147483648 to 2147483647

Reference: The graph's % values are always displayed with the standard display attributes. These display attributes cannot be changed.

Settings	
0%*1 (Specify 0% value using either of Table Entry or Value.)	
Table Entry	Numeral memory table entry number checked to find the 0% value for percentage calculations · Designate the number of the numeral memory table entry that stores the 0% value. Range: 0 to 1999
Value	Checked to find the 0% value for percentage calculations · Designate the 0% value (default: 0) Range: -2147483648 to 2147483647
-100%*1 (Specify -100% value using either of Table Entry or Value.)	
Table Entry	Numeral memory table entry number checked to find the -100% value for percentage calculations · Designate the number of the numeral memory table entry that stores the -100% value. Range: 0 to 1999
Value	Checked to find the -100% value for percentage calculations · Designate the -100% value (default: -100) Range: -2147483648 to 2147483647

*1: The -100% value, 0% value, and 100% value must comply with the following relationship:

$$-100\% \text{ value} < 0\% \text{ value} < 100\% \text{ value}$$

When a table entry is specified for the % value, the relationship above will not be satisfied if the contents of the specified numeral memory table entry are incorrect. In this case, the graph won't be refreshed even if the values displayed on the graph are changed.

Resulting Display

When No Check Mark Is Set for Display Sign

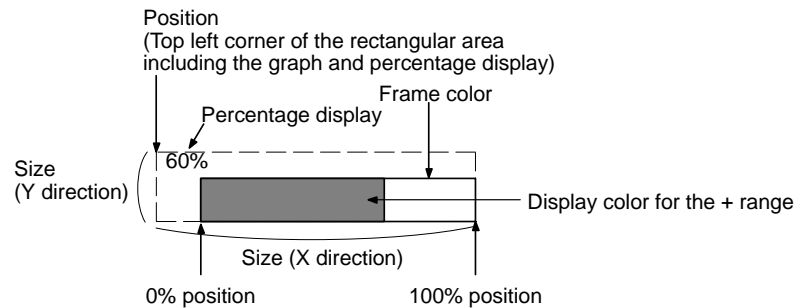

When a Check Mark Is Set for Display Sign

In this case, the center of the graph is always the 0% position, regardless of the settings made for 100%, 0%, and -100%.

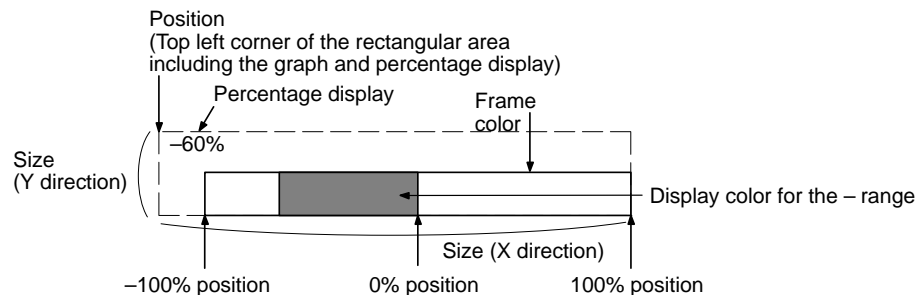

Incremental Direction of Bar Graphs

The incremental directions of the bar graph depending on the setting made for Direction are shown below (applies only when no check mark is set for Display Sign).

Up:
The bar graph increments upward.



Down:
The bar graph increments downward.

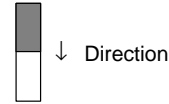

Left:
The bar graph increments to the left.

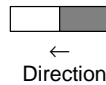

Right:
The bar graph increments to the right.

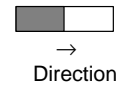

Method for Calculating the Percentage Value

The percentage value is calculated as follows, depending on whether it is larger or smaller than the 0% value.

- When displayed numeric value $\geq 0\%$, and when no check mark is set for Display Sign:

$$\text{Percentage value} = \frac{\text{Displayed numeric value} - [0\%]}{[100\%] - [0\%]} \quad 100$$

- When displayed numeric value $< 0\%$:

$$\text{Percentage value} = \frac{\text{Displayed numeric value} - [0\%]}{[0\%] - [-100\%]} \quad 100$$

Method for Displaying the Percentage Value

The percentage value will be displayed as a signed value regardless of the bar graph's Display Sign setting. The percentage value is always displayed as 5-digit value: the sign character, 3-digit numerical value, and % character. (The sign character is a blank space for positive values.)

Differences in the Bar Graph Display Method According to the Percentage Value

The bar graph display method varies according to the percentage value range.

- 1, 2, 3...
1. When the percentage value is in the minus range
The display varies as follows according to the Display Sign setting.
 - No check mark: The bar graph is displayed as 0% (Display % is shown in negative value.)
 - Check mark: Displayed in the minus range
 2. When the absolute value of the percentage value is in the range of 100% to 999%
The percentage value is displayed as it is. The bar graph is displayed as follows according to the Display Sign setting.
 - No check mark:
Display depends on the setting for Frame:

When a Frame Is Set

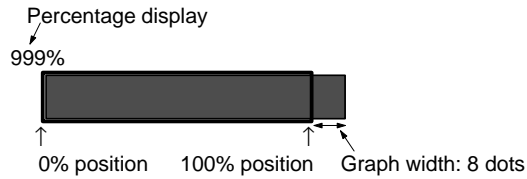

When No Frame Is Set

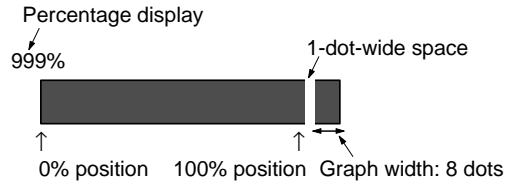

- Check mark:
The display follows the same pattern as when no check mark is set in the negative range of the graph.
- 3. When the absolute value of the percentage value is greater than 1000%
The graph is displayed in the same way as described in (2) above.
The percentage value is displayed as follows according to the setting for Display Sign:
 - No check mark: ***%
 - Check mark: ****%

Display Functions

Bar graphs indicate numeric values in accordance with the General settings. For details on the method of display depending on the General settings, refer to *Common Attributes* (page 155).

Input Functions

Bar graphs have no input function.

Output Functions

Bar graphs have no output function.

Processing Functions

Bar graphs calculate the percentage value in accordance with the settings made for Settings.

For details on the calculation method depending on the Settings settings, refer to *Common Attributes* (page 155).

Relationship with Other Elements

- For details on how numeric values are stored in numeral memory table entries, refer to *2-3 Numeral Memory Table* (page 72).
- Bar graphs overlap with other elements in accordance with the order in which they were registered for the screen with the Support Tool. However, the way in which they overlap can be changed with the Support Tool.

2-10-2 Analog Meter

Function Outline

The contents of a numeral memory table entry or host words are displayed in the form of a circle-shaped analog meter. The numeric value can also be indicated as a percentage of the designated numeric value. Also, scale display is possible.



Restrictions

- The analog meter is available only in NT31/NT31C and NT631/NT631C PTs with the -EV□ suffix on the system program's version number. The analog meter can be used with all versions of the NT21.

- A maximum of 50 analog meters can be registered for one screen. (same for window screen) For an overlapping screen comprising 8 child screens, the maximum is 400.
There is no restriction on the number of analog meters that can be registered for one screen data file: any number can be registered as long as the data file capacity is not exceeded. However, if a large number of elements are registered, check that the restrictions on element display are complied with by referring to Display Restrictions (Page 437)

Common Attributes

The relationship between the properties of an analog meter and the display results is indicated below.

Property

General																	
Position	Coordinates of the top left corner of the analog meter area. Coordinate of the center position of the meter part of an analog meter.																
Size	Radius <table border="1"> <thead> <tr> <th>Style</th> <th>NT21</th> <th>NT31/NT31C</th> <th>NT631/NT631C</th> </tr> </thead> <tbody> <tr> <td>Full circle</td> <td>10 to 70</td> <td>10 to 120</td> <td>10 to 240</td> </tr> <tr> <td>1/2 circle</td> <td>10 to 130</td> <td>10 to 160</td> <td>10 to 320</td> </tr> <tr> <td>1/4 circle</td> <td>10 to 139</td> <td>10 to 226</td> <td>10 to 452</td> </tr> </tbody> </table> The upper limit of the radius may be lower depending upon the Scale Display settings.	Style	NT21	NT31/NT31C	NT631/NT631C	Full circle	10 to 70	10 to 120	10 to 240	1/2 circle	10 to 130	10 to 160	10 to 320	1/4 circle	10 to 139	10 to 226	10 to 452
Style	NT21	NT31/NT31C	NT631/NT631C														
Full circle	10 to 70	10 to 120	10 to 240														
1/2 circle	10 to 130	10 to 160	10 to 320														
1/4 circle	10 to 139	10 to 226	10 to 452														
Frame	Whether or not a frame is displayed for the graph area. Check mark (frame displayed)/ No check mark (frame not displayed) Display color of the frame (Colors other than black and white are available with the NT31C and NT631C only.) Black/Blue/Red/Magenta/Green/Cyan/Yellow/White																
Display Sign	Whether or not a negative area is displayed. Check mark (displayed)/ No check mark (not displayed)																
Direction	Direction in which the value extends (Incremental direction of analog meters, page 162) Clock-wise/Anti-Clockwise																
Shape	Quarter/Semi-Circle/Circle																
Direction	Direction in which the analog meter extends from 0% position ↑ / ↓ / ← / →																
Type	Display method of the area between present value and 0% value. Needle/Fill																
Width Rate	Meter width 10% to 100% (regarding the radius as 100%)																
Scale Display																	
Scale	Whether or not a scale is displayed Check mark (scale displayed)/ No check mark (scale not displayed)																
Distance	Position of the scale 0% to 150% (regarding the radius as 100%) 100%=On circumference of the meter part																
Scale Length	Scale length 10% to 110% (regarding the radius as 100%) 100%=Same length as the radius of the meter part																
No. of Division	Number of the divisions in which the scale should be divided 1 to 20																
Scale Color	Scale color (Colors other than black and white are available with the NT31C and NT631C only.) Black/Blue/Red/Magenta/Green/Cyan/Yellow/White																

General	
Meter Color	
Foreground	Foreground color for the present value (needle or fill) of the meter part (Colors other than black and white are available with the NT31C and NT631C only.) Black/Blue/Red/Magenta/Green/Cyan/Yellow/White
Background	Background color of the analog meter (Colors other than black and white are available with the NT31C and NT631C only.) Black/Blue/Red/Magenta/Green/Cyan/Yellow/White
+Range	Display color for the positive range (Colors other than black and white are available with the NT31C and NT631C only.) Black/Blue/Red/Magenta/Green/Cyan/Yellow/White
-Range	Display color for the negative range (Colors other than black and white are available with the NT31C and NT631C only.) (effective only when a check mark is set for Display Sign) Black/Blue/Red/Magenta/Green/Cyan/Yellow/White

Settings	
Value	
Table Entry	Number of numeral memory table entry whose contents are to be displayed.
Display %	Presence/absence of a percentage indication of the contents of the numeral memory table entry (Method for calculating the percentage value, page 162) Check mark (percentage displayed)/ No check mark (no percentage displayed) For details on the Display % properties, refer to the <i>Numeral Display's General Properties</i> on page 141.
100% *1 (Specify 100% value using either of Table Entry or Value.)	
Table Entry	Numeral memory table entry number check to find the 100% value for percentage calculation Designate the number of the numeral memory table entry that stores the 100% value. Range: 0 to 1999
Value	Check to find the 100% value for percentage calculation Designate the 100% value (default: 100) Range: -2147483648 to 2147483647
0% *1 (Specify 0% value using either of Table Entry or Value.)	
Table Entry	Numeral memory table entry number check to find the 0% value for percentage calculation Designate the number of the numeral memory table entry that stores the 0% value. Range: 0 to 1999
Value	Check to find the 0% value for percentage calculation Designate the 0% value (default: 0) Range: -2147483648 to 2147483647
-100% *1 (Specify -100% value using either of Table Entry or Value.)	
Table Entry	Numeral memory table entry number check to find the -100% value for percentage calculation Designate the number of the numeral memory table entry that stores the -100% value. Range: 0 to 1999
Value	Check to find the -100% value for percentage calculation Designate the -100% value (default: -100) Range: -2147483648 to 2147483647

*1: The -100% value, 0% value, and 100% value must comply with the following relationship:

$$-100\% \text{ value} < 0\% \text{ value} < 100\% \text{ value}$$

When a table entry is specified for the % value, the relationship above will not be

satisfied if the contents of the specified numeral memory table entry are incorrect. In this case, the graph won't be refreshed even if the values displayed on the graph are changed.

Even if the specified value was in an allowable range, it is discarded when an analog meter sticks out of the screen with the specified value.

- Reference:**
- If the $-100\% \text{ value} < 0\% \text{ value} < 100\% \text{ value}$ relationship is not satisfied, the analog meter itself will not be displayed even if you switch to the screen containing the meter.
 - The graph's % values are always displayed with the standard display attributes. These display attributes cannot be changed.

Resulting Display

Example

Resulting display of quarter shape analog meter

When No Check Mark Is Set for Display Sign

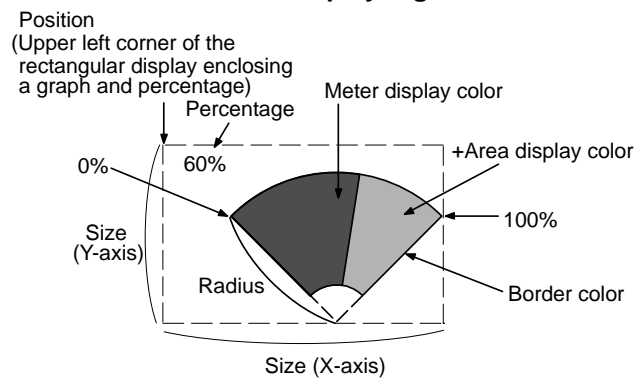

When a Check Mark Is Set for Display Sign

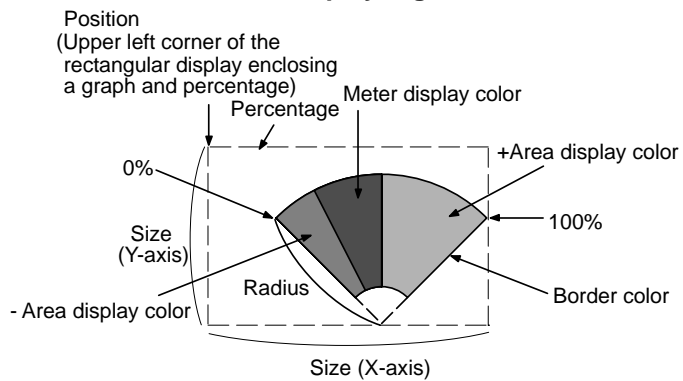

Incremental Direction of Analog Meters

The incremental directions of the analog meter depending on the setting made for Meter Shape, Display Direction and Meter Direction are shown below.

					0% position
Circle					0% position is determined by meter direction. It is not influenced by display direction.
Semi-Circle					With a display sign: 0% position comes at the center of the meter. (Dotted line position in the figure) No display sign (positive value only): Clockwise = 0% position comes at the left side of the meter. Anti-clockwise = 0% position comes at the right side of the meter. (Bold line position in the figure)
Quarter					With a display sign: 0% position comes at the center of the meter (Dotted line position in the figure) No display sign (positive value only): Clockwise = 0% position comes at the left side of the meter Anti-clockwise = 0% position comes at the right side of the meter (Bold line position in the figure)

Method for Calculating the Percentage Value

The percentage is calculated as follows, depending on whether it is larger or smaller than the 0% value.

When displayed numeric value ≥ 0%, and when no check mark is set for Display Sign:

$$\text{Percentage value} = \frac{\text{Displayed numeric value} - [0\%]}{[100\%] - [0\%]} \times 100$$

When displayed numeric value < 0%:

$$\text{Percentage value} = \frac{\text{Displayed numeric value} - [0\%]}{[0\%] - [-100\%]} \times 100$$

Method for Displaying the Percentage Value

The percentage value will be displayed as a signed value regardless of the analog meter's Display Sign setting. The percentage value is always displayed as 5-digit value: the sign character, 3-digit numerical value, and % character. (The sign character is a blank space for positive values.)

Display Sign

Circle

When Display Sign is ON, center position of the meter (It depends on Display Sign) will be 0%, and the each end side corresponds to 100% and -100%.

- When the value is more than 100%, it will be displayed same as 100%.
- When the value is less than -100%, it will be displayed same as -100%.

When Display Sign is OFF, 0% position and 100% position will be the same.

- When the value is less than 0%, it will be displayed same as 0%.
- When the value is more than 100%, it will be displayed same as 100%.

Overflow display is not performed for both cases.

Semi-Circle, Quarter

When Display Sign is ON, center position of the meter will be 0% and the each end side corresponds to 100% and -100%.

When Display Sign is OFF, from end to end of the meter correspond to 0% to 100%.

For both cases, Needle or Fill is displayed outside of the meter to indicate that the value is outside the range (overflow display) when the value is more than 100% or less than -100%. In this case, frame position will not be tiled with Fill type. Therefore, when Frame is OFF, there will be a 1 dot interval when showing the overflow display.

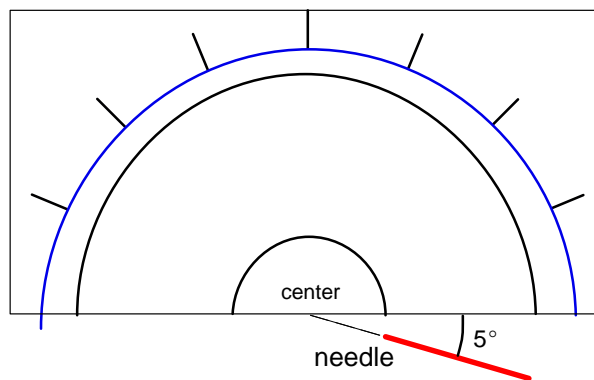

Display Method of the Area Between the Present Value and the 0% Value

Present value of an analog meter is displayed using needle or fill as a display type. If you specify needle, the present value is showed as a needle, if you specify fill, the area between 0% and the present value will be tiled in selected foreground color.

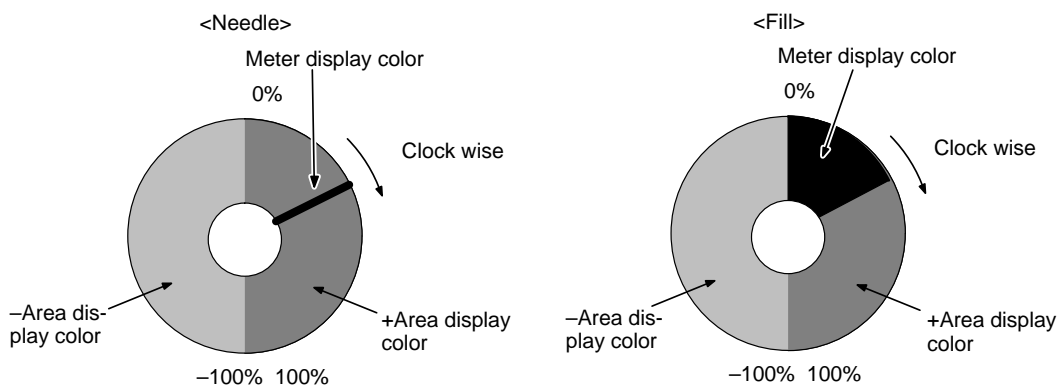

Donut-shaped Analog Meter (Width Rate)

Specify the meter width of an analog meter in % format (0% to 100%) regarding the radius as 100%. If you specify a value that is less than 100%, a donut-shaped

analog meter will be drawn.

Default value for width rate is set to 100%. With default status, therefore, donut-shaped analog meter will not be drawn since there will be no inner circle.

Scale Distance and Scale Length

Specify the scale position and scale length in % format regarding the radius as 100%.

Scale distance (0% to 150%):

Specify the distance from the center of an analog meter in % format regarding the radius as 100%.

0% None (Scale appears from center point of an analog meter)

50% Scale appears inside the analog meter.

100% Scale appears on circumference of an analog meter.

110% Scale appears 10% outside the circumference of an analog meter.

Scale length (10 to 110%):

Specify the length from the scale position in % format regarding the radius as 100%.

No. of Divisions: Specify the number of divisions in which the scale should be divided for the range from 0 to 100%.

Since it specifies the number of divisions in which the scale should be divided, No. of Division +1 scale lines are drawn.

Also, when Display Sign is ON, the same number of scale lines are drawn both for -100% to 0% and 0% to 100% range. Therefore, for -100% to 100% range, designated No. of division x2 is applied.

Example) No. of Division =

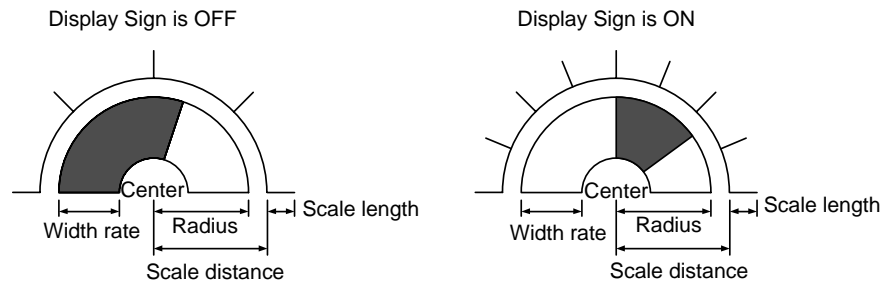

Display Functions

Analog meters indicate numeric values in accordance with the General settings. For details on the method of display depending on the General settings, refer to *Common Attributes* (page 159).

Input Functions

Analog meters have no input functions.

Output Functions

Analog meters have no output functions.

2-10-3 Broken Line Graphs

Function Outline

Broken line graphs represent the contents of multiple consecutive numeral memory table entries as one broken line. They enable the values of consecutive numeral memory table entries to be taken in at a glance.

It is possible to display more than one broken line graph in the same frame so that they can be compared.

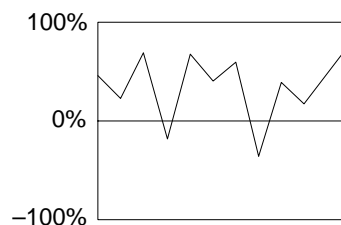

In this example, the values in 11 numeral memory table entries are displayed with the sign indicated.

With broken line graphs, a 100% value, 0% value and -100% value can be set for each broken line in order to calculate and display the numeral memory table values in percentage terms. However, there are no percentage displays for individual numeral memory table entries.

Restrictions

- One broken line graph frame can be registered for one screen. (Same for window screen.) For an overlapping screen comprising 8 child screens, up to 8 broken line graph frames can be displayed on one screen. Total maximum of 256 broken lines can be registered for one screen regardless of the number of frames. (Same for window screen.)

There is no restriction on the number of broken line graph frames that can be registered for one screen data file: any number can be registered as long as the data file capacity is not exceeded. However, if a large number of elements are registered, check that the restrictions on element display are complied with by referring to Display Restrictions (page 437).

- The contents of up to 320 consecutive numeral memory table entries (up to 260 for the NT21) can be displayed in one broken line.

Common Attributes

The relationship between the properties of a broken line graph and the display results is indicated below.

Properties

General (properties of the frame)	
Position	Coordinates of the top left corner of the graph area.
Size	Width and height of the area in which the broken line graph is displayed (dot units) NT21: Width 2 to 260; Height 2 to 140 NT31/NT31C: Width 2 to 320; Height 2 to 240 NT631/NT631C: Width 2 to 640; Height 2 to 480
Frame	Whether or not a frame is displayed for the graph area Check mark (frame displayed)/ No check mark (frame not displayed)
Display Sign	Whether or not a negative area is displayed. Check mark (displayed)/No check mark (not displayed)
Direction	Direction in which numeral memory table contents are displayed in the broken line graph (smaller number → larger numbers) (Direction of broken line graphs, page 167) Up/Down/Left/Right
Color	
Frame	Display color of the frame (Colors other than black and white are available with the NT31C and NT631C only.) Black/Blue/Red/Magenta/Green/Cyan/Yellow/White
+ Range	Display color of the positive range (Colors other than black and white are available with the NT31C and NT631C only.) Black/Blue/Red/Magenta/Green/Cyan/Yellow/White
- Range	Display color of the negative range (Colors other than black and white are available with the NT31C and NT631C only.) (effective only when a check mark is set for Display Sign) Black/Blue/Red/Magenta/Green/Cyan/Yellow/White

Settings (properties of each broken line)	
Start Table Entry*1	First numeral memory table entry number of the numeral memory table entries used to display the broken line. Range: 0 to 1998
No. of points*1	Number of vertices in the broken line display (one memory table entry is used for each vertex) NT21: 2 to 260 NT31/NT31C: 2 to 320 NT631/NT631C: 2 to 512
Interval Type	Interval between numeral memory table entries in the broken line. Even/Uneven (cannot resize) (0 to size in the broken line graph Direction - 1)
Line	
Color	Display color of the broken line (Colors other than black and white are available with the NT31C and NT631C only.) Black/Blue/Red/Magenta/Green/Cyan/Yellow/White
Style	Line type used for the broken line graph Solid line: _____ Broken line: - - - - - 1-dot chain line: 2-dot chain line:
100%*2 (Specify 100% value using either of Table Entry or Value.)	
Table Entry	Numeral memory table entry number checked to find the 100% value for percentage calculations · Designate the number of the numeral memory table entry that stores the 100% value. Range: 0 to 1999
Value	Checked to find the 100% value for percentage calculations · Designate the 100% value (default: 100) Range: -2147483648 to 2147483647
0%*2 (Specify 0% value using either of Table Entry or Value.)	
Table Entry	Numeral memory table entry number checked to find the 0% value for percentage calculations · Designate the number of the numeral memory table entry that stores the 0% value. Range: 0 to 1999
Value	Checked to find the 0% value for percentage calculations · Designate the 0% value (default: 0) Range: -2147483648 to 2147483647
-100%*2 (Specify -100% value using either of Table Entry or Value.)	
Table Entry	Numeral memory table entry number checked to find the -100% value for percentage calculations · Designate the number of the numeral memory table entry that stores the -100% value. Range: 0 to 1999
Value	Checked to find the -100% value for percentage calculations · Designate the -100% value (default: -100) Range: -2147483648 to 2147483647

*1: When making the setting, ensure that the total of the Start Table Entry and No. of Points does not exceed the maximum table entry.

*2: The -100% value, 0% value, and 100% value must comply with the following relationship:

$$-100\% \text{ value} < 0\% \text{ value} < 100\% \text{ value}$$

When a table entry is specified for the % value, the relationship above will not be satisfied if the contents of the specified numeral memory table entry are incorrect. In this case, the graph won't be refreshed even if the values displayed on the graph are changed.

The line thickness for broken line graphs is fixed as 1 dot.

Reference: If a small value is set for Interval Type, even if broken line, 1-dot chain line, or 2-dot chain line is specified the line will appear to be a solid line.

Resulting Display

When No Check Mark Is Set for display Sign

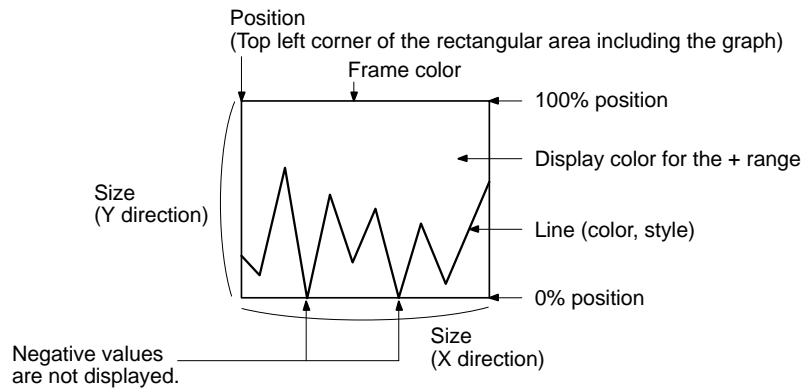

When a Check Mark Is Set for Display Sign

In this case, the center of the graph is always the 0% position, regardless of the settings made for 100%, 0%, and -100%.

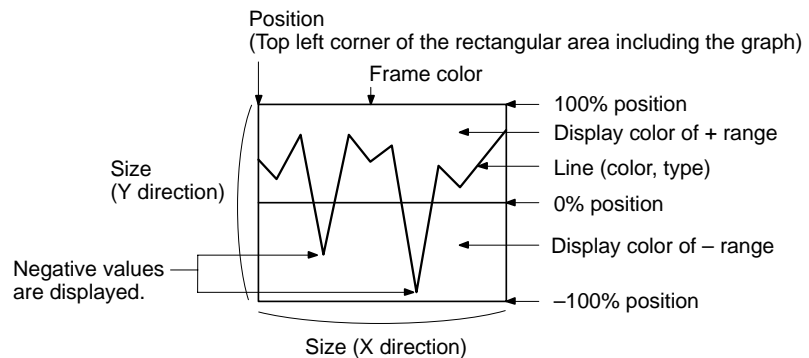

Direction of Broken Line Graphs

The directions of broken line graphs depending on the setting made for Direction are shown below. The direction of a broken line graph means the direction in which the values in numeral memory table entries are plotted, starting from the numeral memory table entry with the smallest table entry number and proceeding through progressively larger table entry numbers.

The 100% value is at the top of the frame when the Direction is a lateral one and the right of the frame when the Direction is a longitudinal one.

Up
Graph that is drawn from bottom to top

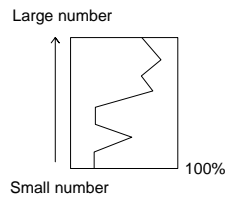

Down
Graph that is drawn from top to bottom

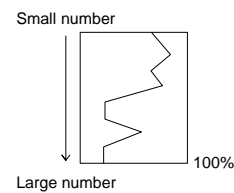

Left
Graph that is drawn from right to left

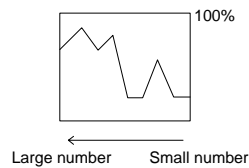

Right
Graph that is drawn from left to right

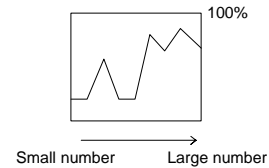

Number of Vertices

The maximum number of vertices (numeral memory table entries) that can be displayed in one broken line is 260 in the NT21 PTs, 320 in NT31/NT31C PTs, or 512 in NT631/NT631C PTs, but since a minimum interval of 1 dot is actually required between memory table entries, the following restriction applies depending on the width (number of dots) of the graph frame.

$$\text{Width of graph frame (number of dots)} \geq \text{No. of Points}$$

Interval Between Numeral Memory Table Entries

The display interval between memory table entries can be set individually for each memory table entry. Adjust the intervals as required.

When Even is set for the Interval Type, the intervals are arranged evenly so as to make use of the entire width of graph area.

Example: Broken line graph where the interval changes

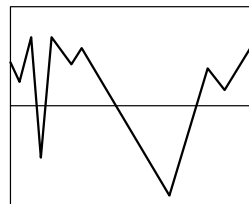

Method for Calculating the Percentage Value

The percentage value is calculated as follows, depending on whether it is larger or smaller than the 0% value.

However, note that although each vertex of the broken line graph is displayed based on this value, individual percentage values are not displayed.

- When displayed numeric value $\geq 0\%$, and when no check mark is set for Display Sign:

$$\text{Percentage value} = \frac{\text{Displayed numeric value} - [0\%]}{[100\%] - [0\%]} \quad 100$$

- When displayed numeric value $< 0\%$:

$$\text{Percentage value} = \frac{\text{Displayed numeric value} - [0\%]}{[0\%] - [-100\%]} \quad 100$$

Differences in the Broken Line Graph Display Method According to the Percentage Value

The broken line graph display method varies according to the percentage value range.

- 1, 2, 3...**
1. When the percentage value is in the minus range

The display varies as follows according to the Display Sign setting.

 - No check mark: Displayed as 0%.
 - Check mark: The graph is displayed in the minus range.
 2. When the absolute value of the percentage value exceeds 100%

If the percentage value exceeds 100%, or breaks through $-100%$ and protrudes out of the graph area, only the parts of the lines within the graph area are displayed.

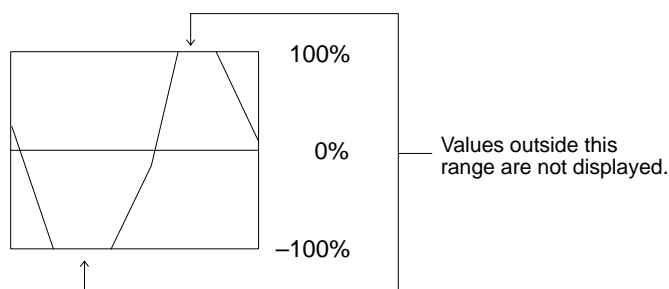

Display Functions

For broken line graphs, the graph area is displayed in accordance with the General settings, and the broken line is displayed in accordance with the Settings (line attribute) settings.

For details on the method of display depending on the General and Settings settings, refer to *Common Attributes* (page 165).

- When multiple broken lines are registered, they overwrite each other in the order they were registered. When broken lines overlay each other they are displayed according to the XOR principle (page 47), and consequently the line style and color may differ from those specified. The same principle applies when a broken line overlays the graph frame.

Input Functions

Broken line graphs have no input function.

Output Functions

Broken line graphs have no output function.

Processing Functions

Broken line graphs calculate the percentage value in accordance with the settings made for Settings (properties of each broken line).

For details on the calculation method depending on the Settings (properties of each broken line) settings, refer to *Common Attributes* (page 165).

Relationship with Other Elements

- For details on how numeric values are stored in numeral memory table entries, refer to *2-3-1 Numeral Memory Table* (page 72).
- Broken line graphs overlap with other elements in accordance with the order in which they were registered for the screen with the Support Tool. However, the way in which they overlap can be changed with the Support Tool.

2-10-4 Trend Graphs

Function Outline

Trend graphs represent the changes over time in the contents of a numeral memory table entry as one line.

It is possible to display more than one such line in the same frame so that they can be compared.

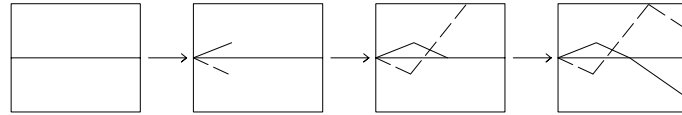

There are two types of trend graph: the standard type, where the graph is drawn as though a pen were moving across paper, and the pen recording type, where the graph is drawn as though the paper were moving under a pen.

With trend graphs, a 100% value, 0% value and -100% value can be set for each line in order to calculate and display the numeral memory table values in percentage terms. The current percentage can be displayed.

Past values can be recorded, and then displayed by back tracking (the logging function), and the contents of numeral memory table entries can be collected even while other screens are displayed (the background function).

Restrictions

- One trend graph frame can be registered for one screen. (Same for window screen.) For an overlapping screen comprising 8 child screens, up to 8 trend graph frames can be registered on each screen. Total maximum of 50 broken lines can be registered on each screen. Total maximum of 50 broken lines can be registered for one screen regardless of the number of frames. (Same for window screen.)

There is no restriction on the number of trend graph frames that can be registered for one screen data file: any number can be registered as long as the data file capacity is not exceeded. However, if a large number of elements are registered, check that the restrictions on element display are complied with by referring to Display Restrictions (page 437).

In the case of trend graphs comprising past values recorded with the logging function, up to eight broken lines can be registered for one screen.

- If the set sampling cycle is shorter than the time taken for display update processing, sampling results that cannot be processed in time are skipped and the data will not be displayed correctly.

Example: The data indicated by \times marks in the graph on left cannot be processed in time for screen updating, and is skipped; therefore only the data indicated by \circ is displayed and the result is as shown in the graph on the right.

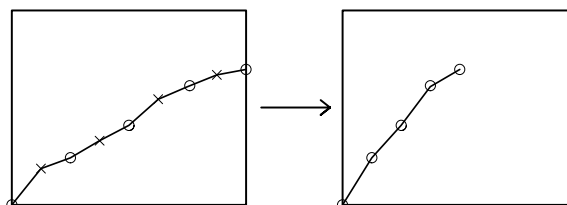

Common Attributes

The relationship between the properties of a trend graph and the display results is indicated below.

Properties

General	
Position	Coordinates of the top left corner of the graph area.
Size	Width and height of the area in which the graph is displayed (dot units) NT21: Width 2 to 260; Height 2 to 140 NT31/NT31C: Width 2 to 320; Height 2 to 240 NT631/NT631C: Width 2 to 640; Height 2 to 480
Display	
Type	Method for drawing the line (Line drawing method, page 175) Standard/Pen Recorder
Drawing Width	Interval between consecutive data on the drawn graph in dot units (Drawing width, page 175)
Frame	Whether or not a frame is displayed for the graph area Check mark (frame displayed)/ No check mark (frame not displayed)
Display Sign	Whether or not a negative area is displayed. Check mark (displayed)/No check mark (not displayed)
Direction	Direction of motion of the graph (Line drawing method, page 175) Up/down/left/right · For standard type: Direction of motion from the latest drawing position · For pen recording type: Direction of motion of the line as a whole
Sampling Cycle	Cycle (time interval) for data reading (graph updating) Range: 0.5 to 6553.5 in 0.5 second units (5 to 65535 (0.1) for entry; must be a multiple of 5)
Color	
Frame	Display color of the frame (Colors other than black and white are available with the NT31C and NT631C only.) Black/Blue/Red/Magenta/Green/Cyan/Yellow/White
+ Range	Display color of the positive range (Colors other than black and white are available with the NT31C and NT631C only.) Black/Blue/Red/Magenta/Green/Cyan/Yellow/White
- Range	Display color of the negative range (Colors other than black and white are available with the NT31C and NT631C only.) (effective only when a check mark is set for Display Sign) Black/Blue/Red/Magenta/Green/Cyan/Yellow/White

Settings (properties of each line)	
Table Entry	Number of the numeral memory table entry whose contents are displayed. Range: 0 to 1999
Display %	Presence/absence of a percentage indication of the contents of the numeral memory table entry (Method for calculating the percentage value, page 176) Check mark (percentage displayed)/ No check mark (no percentage display) For details on the Display % properties, refer to the <i>Numeral Display's General Properties</i> on page 141.
Line	
Color	Display color of the line (Colors other than black and white are available with the NT31C and NT631C only.) Black/Blue/Red/Magenta/Green/Cyan/Yellow/White
Style	Line type used · Solid line: _____ · Broken line: - - - - - · 1-dot chain line: ····· · 2-dot chain line: ·····
100%*1 (Specify 100% value using either of Table Entry or Value.)	
Table Entry	Numeral memory table entry number checked to find the 100% value for percentage calculations (effective only when a check mark is set for Display %) · Designate the number of the numeral memory table entry that stores the 100% value. Range: 0 to 1999
Value	Checked to find the 100% value for percentage calculations (effective only when a check mark is set for Display %) · Designate the 100% value (default: 100) Range: -2147483648 to 2147483647
0%*1 (Specify 0% value using either of Table Entry or Value.)	
Table Entry	Numeral memory table entry number checked to find the 0% value for percentage calculations (effective only when a check mark is set for Display %) · Designate the number of the numeral memory table entry that stores the 0% value. Range: 0 to 1999
Value	Checked to find the 0% value for percentage calculations (effective only when a check mark is set for Display %) · Designate the 0% value (default: 0) Range: -2147483648 to 2147483647
-100%*1 (Specify -100% value using either of Table Entry or Value.)	
Table Entry	Numeral memory table entry number checked to find the -100% value for percentage calculations (effective only when a check mark is set for Display %) · Designate the number of the numeral memory table entry that stores the -100% value. Range: 0 to 1999
Value	Checked to find the -100% value for percentage calculations (effective only when a check mark is set for Display %) · Designate the -100% value (default: -100) Range: -2147483648 to 2147483647

*1: The -100% value, 0% value, and 100% value must comply with the following relationship:

$$-100\% \text{ value} < 0\% \text{ value} < 100\% \text{ value}$$

When a table entry is specified for the % value, the relationship above will not be satisfied if the contents of the specified numeral memory table entry are incorrect. In this case, the graph won't be refreshed even if the values displayed on the graph are changed.

- Reference:**
- The graph's % values are always displayed with the standard display attributes. These display attributes cannot be changed.

Logging	
Data Logging	
	Whether or not the logging function is used (Data logging function and background function, page 177) Check mark (logging function used)/ No check mark (logging function not used)
Background*2	Whether or not the background function is used (Data logging function and background function, page 177) Check mark (background function used)/ No check mark (background function not used)
Forward*2	Presence/absence of a touch switch to proceed to the next page Check mark (touch switch set)/ No check mark (touch switch not set)
Rewind*2	Presence/absence of a touch switch to return to the previous page Check mark (touch switch set)/ No check mark (touch switch not set)
Clear Log*2	Presence/absence of a touch switch to clear the logging data Check mark (touch switch set)/ No check mark (touch switch not set)
Touch Switches for Display Function	
Stop	Presence/absence of a touch switch to stop data sampling Check mark (touch switch set)/ No check mark (touch switch not set)
Clear Display	Presence/absence of a touch switch to clear the trend graph display Check mark (touch switch set)/ No check mark (touch switch not set)
Continue	Presence/absence of a touch switch to restart data sampling Check mark (touch switch set)/ No check mark (touch switch not set)

The line thickness for trend graphs is fixed as 1 dot.

- Reference:**
- If a small value is set for Interval Type, even if broken line, 1-dot chain line, or 2-dot chain line is specified the line will appear to be a solid line.
 - In the case of a standard trend graph that determines the 100%, 0% and -100% values according to the Table Entry settings, if the contents of the referenced numeral memory table entries change, the graph becomes discontinuous.

Example:

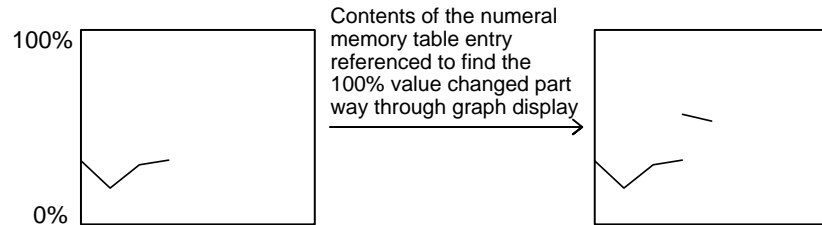

Resulting Display

When No Check Mark Is Set for display Sign

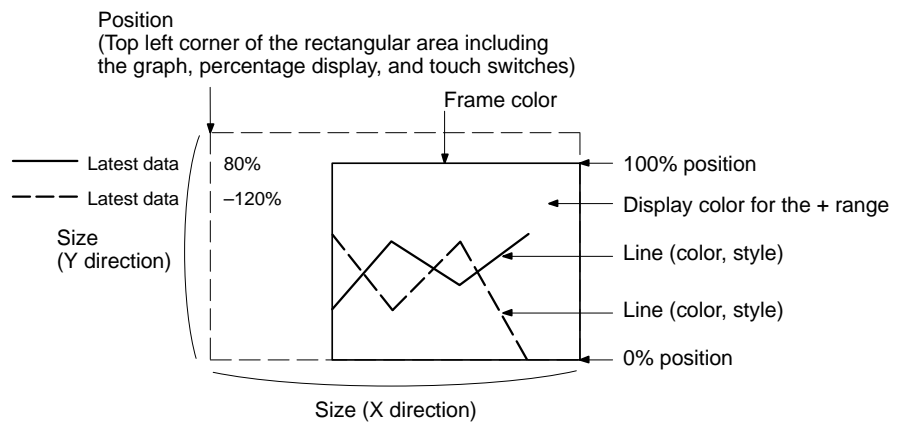

When a Check Mark Is Set for Display Sign

In this case, the center of the graph is always the 0% position, regardless of the settings made for 100%, 0%, and -100%.

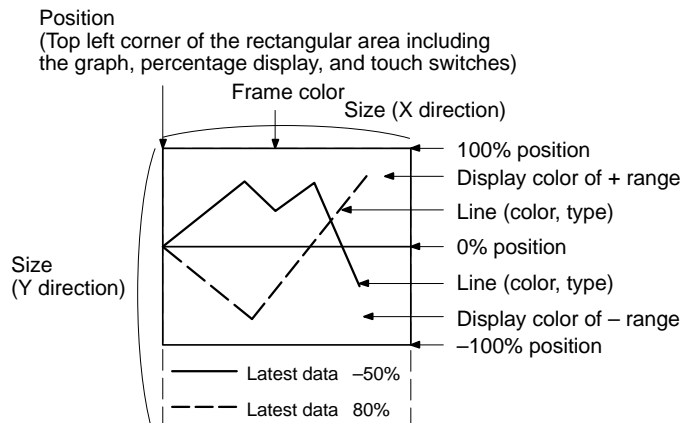

Drawing Width

The drawing width is the interval at which successive data are drawn in the direction of motion. If a value outside the display area of the graph is specified, the graph will not be displayed.

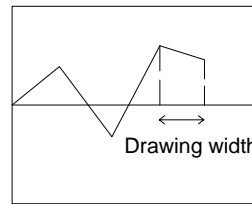

Direction of motion →

Line Drawing Method

The graph is drawn as shown below depending on the settings made for Type and Direction.

The 100% value is at the top of the frame when the Direction is a lateral one and the right of the frame when the Direction is a longitudinal one.

When Standard Is Set for Type

With the standard type, the latest drawing position moves in the direction of motion specified by Direction with the passage of time. If the direction of motion is right, the display changes as indicated below. When the line reaches the edge of the graph area, the line is cleared and then displayed again from the beginning.

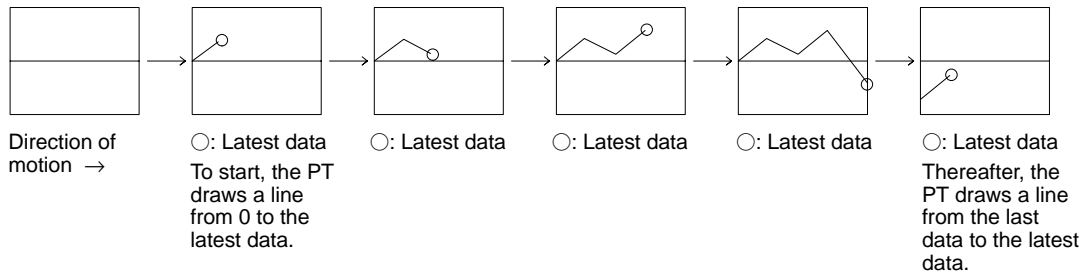

The drawing results with each Direction setting are indicated below.

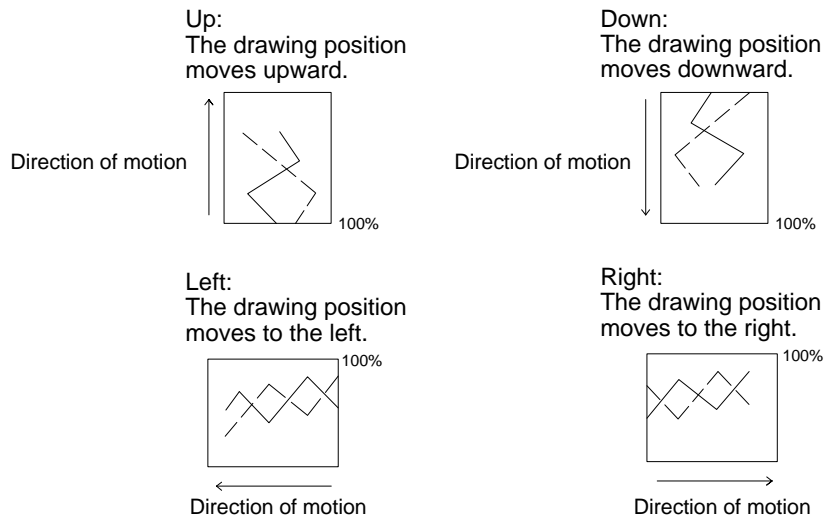

When Pen Recorder Is Set for Type

With the pen recorder type, the latest drawing position is always displayed at the edge of the graph area. As time passes, the part of the graph that is already displayed moves in the direction specified by Direction (as if paper were moving underneath a pen). When the direction of motion is right, the display changes in the manner shown below. When the line reaches the edge of the graph area, the data is cleared from the oldest first.

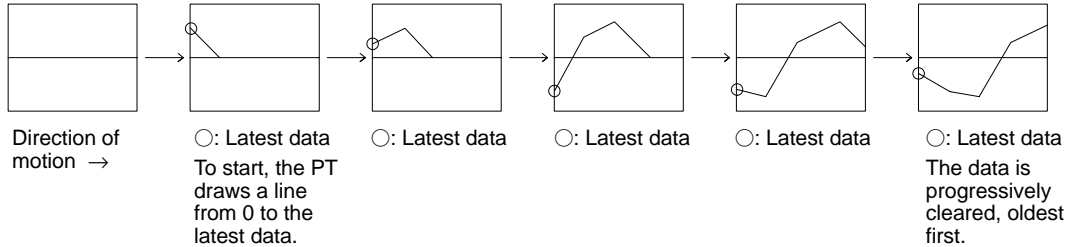

The drawing results with each Direction setting are indicated below.

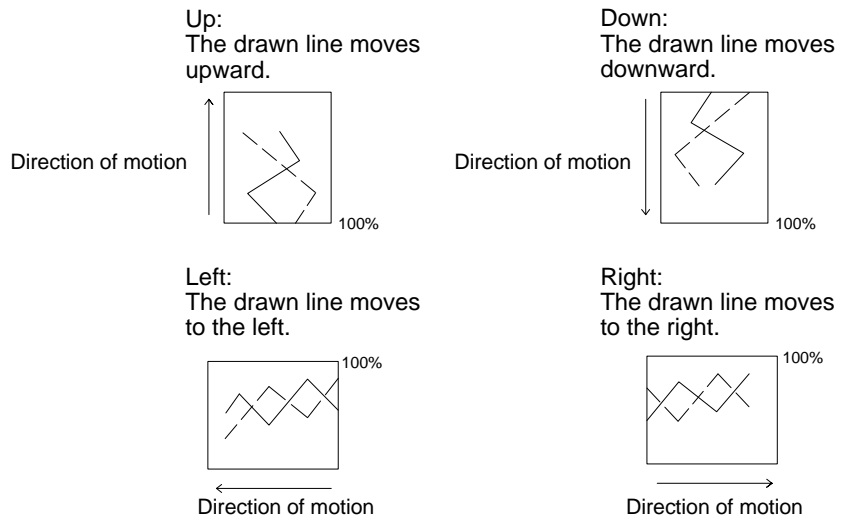

Method for Calculating the Percentage Value

The percentage value is calculated as follows, depending on whether it is larger or smaller than the 0% value.

- When displayed numeric value $\geq 0\%$, or when a check mark is set for Display Sign:

$$\text{Percentage value} = \frac{\text{Displayed numeric value} - [0\%]}{[100\%] - [0\%]} \quad 100$$

- When displayed numeric value $< 0\%$:

$$\text{Percentage value} = \frac{\text{Displayed numeric value} - [0\%]}{[0\%] - [-100\%]} \quad 100$$

Method for Displaying the Percentage Value

The percentage value will be displayed as a signed value regardless of the trend graph's Display Sign setting. The percentage value is always displayed as 5-digit value: the sign character, 3-digit numerical value, and % character. (The sign character is a blank space for positive values.)

Differences in Trend Graph Display Method According to Percentage Values

The display method of a trend graph differs according to the percentage value range.

1, 2, 3... 1. When the percentage value is negative

The following happens, depending on the setting for Display Sign:

- No check mark: The graph line is displayed as 0% (Display % is shown in negative value).
- Check mark: Displayed in the minus range

2. When the absolute value of the percentage value is in the range of 100% to 999%

If the percentage value enters the range 100 to 999% or -100 to -999%, and the line projects out of the graph area, only the part of the line inside the graph area is displayed.

If a check mark is set for Display %, the calculated percentage value is displayed.

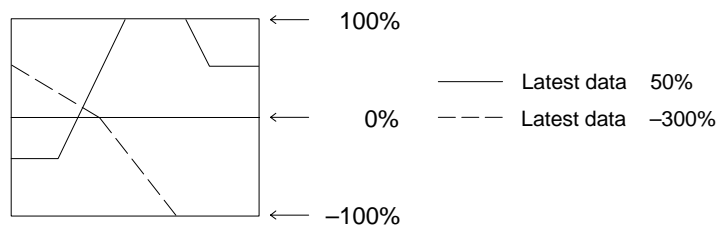

3. When the absolute value of the percentage value is greater than 1000%

If the percentage value exceeds 1000% or enters the range below -1000% and the line projects out of the graph area, only the part of the line inside the graph area is displayed, as in (2) above.

If a check mark is set for Display %, the percentage value is displayed as follows:

- ****%

Data Logging Function and Background Function

The data logging function is a function for recording (logging) the displayed values internally.

Normally, the data sampled for a trend graph is not recorded internally, but by using the data logging function it is possible to back track and display past data.

With the PT, the data logging function can be used for the data of up to 8 lines. The maximum data quantity that can be recorded for each is 1440 points, and when this limit is exceeded the data is deleted from the oldest points.

If the Clear Log touch switch has been set, the data can be cleared at any time.

The background function allows data to be sampled even while the trend graph is not displayed.

Usually, with trend graphs, data is only sampled while the graph is displayed and sampling is stopped when the screen is switched. By using the background function, sampling can be carried out even while the trend graph is not being displayed. The recorded data is displayed by back tracking when the trend graph is displayed.

The background function can only be used in conjunction with the data logging function, and the only data recorded is that for the data logging function. However, since sampling continues while the background function is being used, the processing of the PT may be delayed.

Reference: The retention of data by the data logging function remains effective until any of the following operations is performed.

- The power to the PT is turned OFF.
- The PT is reset.
- All the screen data is transmitted.
- Data is transmitted in screen units.

When operation is stopped, for example by displaying the System Menu, sampling is also stopped even if the background function is being used; it is restarted when operation is restarted (the data is retained and recording starts from the data following the last data).

Data is recorded as described below depending on whether or not the data logging function and background function are used. The PT will start drawing the trend graph again when it is switched to a screen containing the trend graph from another screen, so use a touch switch that controls the trend graph if you want to display the previous data.

When Neither the Data Logging Function or Background Function Is Used

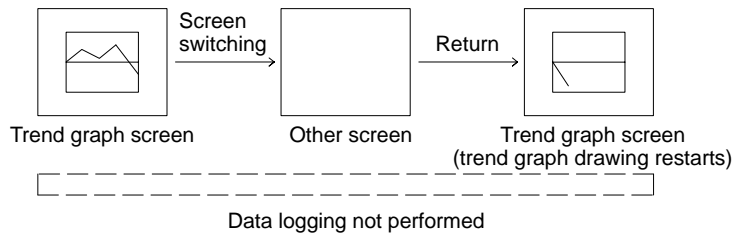

When the Data Logging Function Is Used and the Background Function Is Not Used

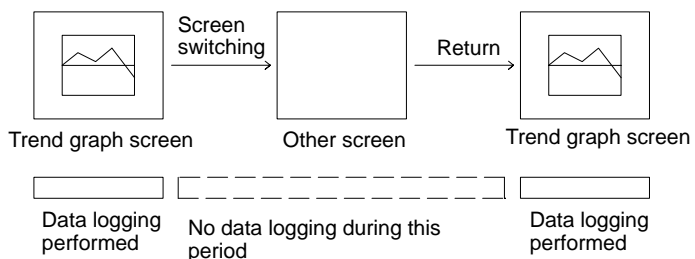

When Both the Data Logging Function and the Background Function Are Used

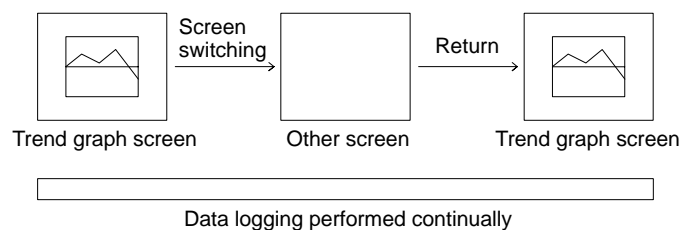

Controls on Display According to Touch Switches

Trend graphs can be displayed in the form shown below, with associated touch switches to control operations.

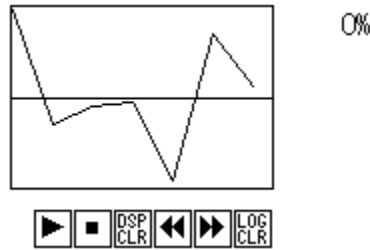

These dedicated touch switches can be used for data sampling and display operations.

The relevant functions are performed once only when the touch switches are pressed. These functions cannot be controlled from the host.



The positions of these touch switches can be set freely on the screen. However, the display colors, sizes and the marks cannot be changed.

-  Stop touch switch
Stops data sampling. Updating of the trend graph display is stopped at the same time.

While sampling is stopped, the stop touch switch is lit.





When the background function is used, pressing the stop touch switch stops sampling in the background.

When the last data recorded before sampling was stopped is displayed, it is displayed following the currently displayed graph.

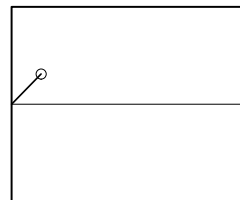
After pressing the  (stop) touch switch, if the  (previous page (rewind)) touch switch is pressed to return to a past display and then the  (restart (continue)) touch switch is pressed to restart sampling, past data will not be displayed and the display of new data will start again.

Example:



-  Restart (continue) touch switch
Restarts the sampling of data stopped by pressing the stop touch switch. Updating of the trend graph display is started at the same time.
During sampling, the restart (continue) touch switch is lit.
-  Display clear (clear display) touch switch
Clears the trend graph display. The logging data is not cleared but retained.
-  Log clear (clear log) touch switch
Clears the currently displayed trend graph and that trend graph's logging data. Other trend graphs will not be cleared. This touch switch is only effective when using the data logging function.
-  Previous page (rewind) touch switch
Displays logging data older than that of the currently displayed trend graph. This touch switch is only effective when using the data logging function.

With a standard type trend graph, if this touch switch is pressed during display of the latest data to backtrack to past data, and then the next page (forward) touch switch is pressed to return to display of the latest data, the latest data is plotted following the past data.

Example:

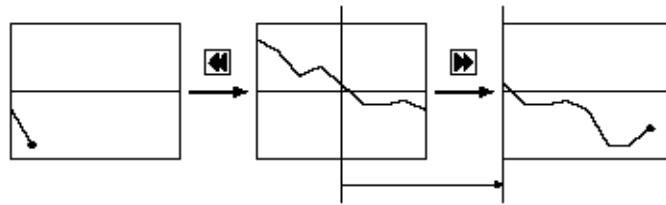

Next page (forward) touch switch

Displays logging data newer than that of the currently displayed trend graph. This touch switch is only effective when using the data logging function.

When the latest data is displayed during data logging, updating of the trend graph display is automatically restarted.

The previous page (rewind) or next page (forward) touch switch, whichever was pressed last, remains lit.

Display Direction of Previous/Next Page Touch Switch

The display direction of previous/next page when Right is set for Direction is shown below.

Type: Standard

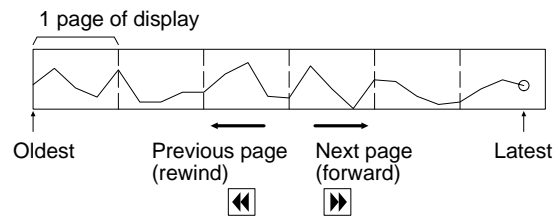

Type: Pen Recorder

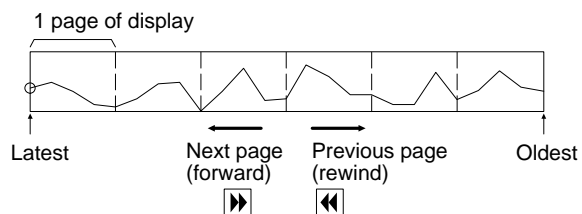

When the Display Is Wound from Old Dot to the Latest.

When the page is wound to the latest display after displaying the old data, display is shown as follows:

Standard Type

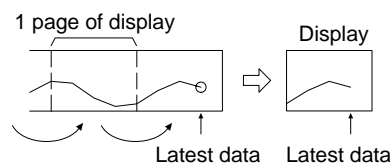

Pen Record Type

With the pen recorder type, the latest drawing position is always displayed at the edge of the graph area. Therefore, depending on the number of data in the latest page, old data may be displayed discontinuously as shown below (Internally, the data is recorded continuously.)

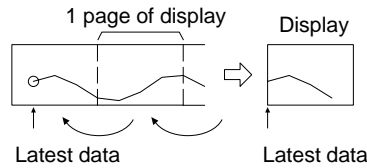

Display Functions

For trend graphs, the graph area is displayed in accordance with the General settings, and the broken line is displayed in accordance with the Settings (properties of each line) settings.

For details on the method of display depending on the General and Settings (properties of each line) settings, refer to *Common Attributes* (page 171).

- When multiple broken lines are registered, they overwrite each other in the order they were registered. When broken lines overlay each other they are displayed according to the XOR principle (page 47), and consequently the line style and color may differ from those specified. The same principle applies when a broken line overlays the graph frame.

Input Functions

Trend graphs have no input function.

Output Functions

Trend graphs have no output function.

Processing Functions

Trend graphs calculate the percentage value in accordance with the settings made for Settings (properties of each line).

For details on the calculation method depending on the Settings (properties of each line) settings, refer to *Common Attributes* (page 171).

Relationship with Other Elements

- For details on how numeric values are stored in numeral memory table entries, refer to *2-3-1 Numeral Memory Table* (page 72).
- Trend graphs overlap with other elements in accordance with the order in which they were registered for the screen with the Support Tool. However, the way in which they overlap can be changed with the Support Tool.

2-11 Alarm List, Alarm History

Function Outline

Alarm List

The PT can monitor the status of bits at the connected host designated in bit memory table entries and, when the status of a particular bit changes to 1 (ON), display the corresponding message (from a character string memory table entry) or image/library data. The element used to execute this function is called an alarm list.

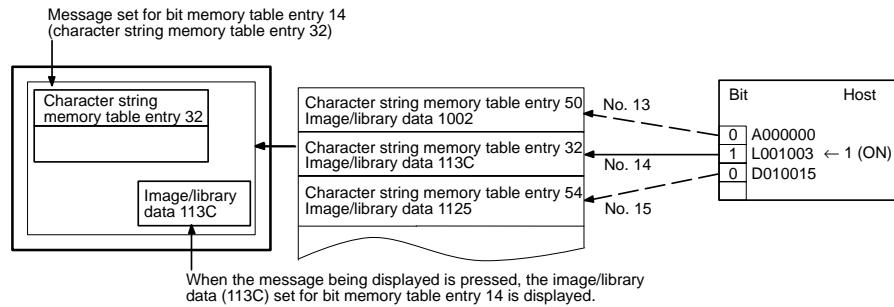

Alarm History

The PT can continually monitor bits at the host designated in bit memory table entries, record the time when their status changes to 1 (ON), and the number of times they come ON, and display this information together with the corresponding message (from a character string memory table entry) for the bit. The element used to execute this function is called an alarm history.

The alarm history record data is backed up by the built-in battery of the PT and is therefore retained even when the power to the PT is turned OFF or the PT is reset. (An optional Battery is required for the NT21.)

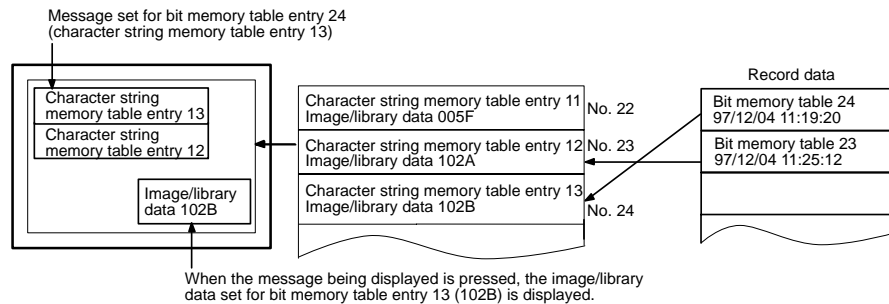

Reference: If the remaining capacity of the battery is insufficient, the alarm history data is all cleared when the power to the PT is turned OFF or the PT is reset.

When low battery voltage is detected, replace the battery immediately. Refer to section 7 of the *Setup Manual* for details on replacing the battery.

Differences Between Alarm List and Alarm History

The alarm list and alarm history differ in the following respects.

Item	Alarm List	Alarm History
Display method	As element only	As element, and as a screen displayed from the System Menu
Monitored data	Host bits allocated to bit memory table entry within the designated range	Host bits allocated to bit memory table entries for which History is set.
Monitor timing	While the alarm list element is displayed only	Continuous monitoring regardless of the displayed screen
Recording	No recording executed	Time of occurrence is recorded.
Message contents	When a message is displayed for an alarm list, the contents of the character string memory table entry set for the bit memory table entry are read.	<ul style="list-style-type: none"> - Occurrence order: When the status of a monitored bit at the host changes to 1 (ON), the contents of the character string memory table entry set for the bit memory table entry are read. - Frequency order: When a message is displayed for an alarm history, the contents of the character string memory table entry set for the bit memory table entry are read.
Output data to the Support Tool	Not possible for there is no record data	Possible (occurrence order and frequency order records transmitted simultaneously)
Display order	Ascending order of bit memory table entry numbers	Select either of the following: <ul style="list-style-type: none"> - Occurrence order: Chronological order in which the statuses of the monitored bits changed to 1 (ON) (displayed from the oldest record first or the newest record first depending on the memory switch setting at the PT) - Frequency order: Order based on the number of times the status of each bit has changed to 1 (ON), from most to least frequent.

Outline of Alarm List/Alarm History Operations

The operations of the alarm list and alarm history are described below.

- Reference:**
- The alarm list only checks host bits allocated to bit memory table entries within the designated range. This checking is performed only while the alarm list is displayed.
The alarm history only checks host bits allocated to bit memory table entries for which History is set. The relevant host bits are checked continually. Consequently, if a large number of host bits is set the processing of the PT may be delayed.
 - Alarm lists are displayed in ascending order of bit memory table entry numbers and alarm histories are displayed in frequency order or occurrence order. When an alarm history is displayed in occurrence order, the order can be specified as from the newest record or from the oldest record by setting the Hist. Disp. Method memory switch of the PT.
 - In the case of alarm lists, if the status of a host bit allocated to a bit memory table entry changes to 0 (OFF), the message and image/library data are also automatically cleared at the same time.
In the case of alarm histories, even if the status of a host bit allocated to a bit memory table entry changes to 0 (OFF), the message and image/library data remain.
 - The alarm history record data can also be displayed and printed out in the Maintenance mode under the System Menu of the PT. (Printing is supported by only the NT31/NT31C and NT631/NT631C.)

- 1, 2, 3...**
1. When the status of an allocated bit of a bit memory table entry for which the alarm list/history function is set changes to 1 (ON), the contents of the set character string memory table entry are displayed as a message.

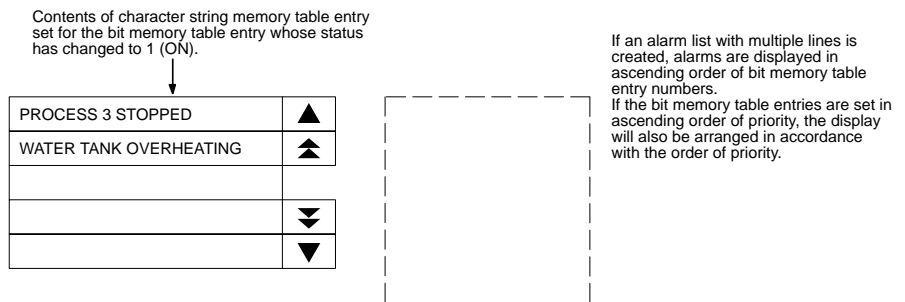

2. Each message area is a touch switch and pressing a message displays the set image/library data. At the same time, the pressed message is displayed in reverse video.

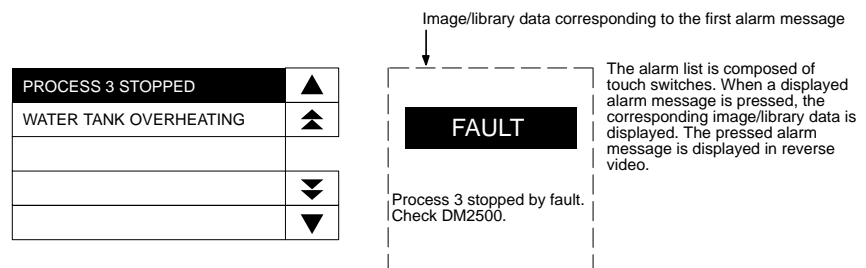

- In case multiple messages are displayed, pressing another message will cause it to be displayed in reverse video, and the corresponding image/library data will be displayed.

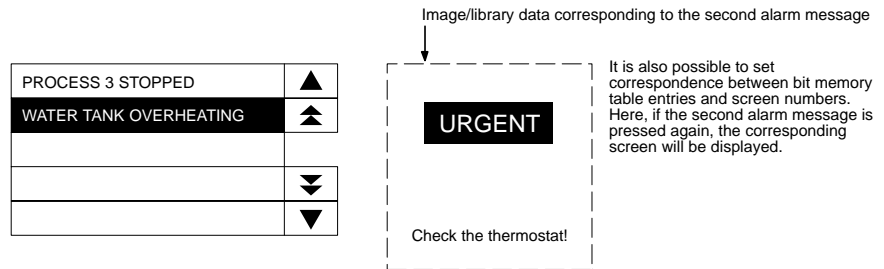

- When a message displayed in reverse video is pressed again, the display will switch to the screen with the set screen number.

Reference: In the case described above, both image/library display and screen changeover functions are set. The operation when a touch switch is pressed is determined as follows in accordance with these settings:

Image/library display	Screen changeover	Touch switch	
		First time	Second time
Not set	Not set	No effect	No effect
Not set	Set	Screen changeover	—
Set	Not set	Image/library data display	No effect
Set	Set	Image/library data display	Screen changeover

Restrictions

- A combined total of up to 4 alarm lists and alarm histories can be displayed on one screen. (Same for window screen) In the case of an overlapping screen with 8 child screens, the maximum total is 32 on one screen.
- With the NT21, up to 7 alarm list/alarm history messages can be displayed at the same time. NT31/NT31C, up to 12 alarm list/alarm history messages can be displayed at the same time. With the NT631/NT631C, up to 24 alarm list/ alarm history messages can be displayed at the same time.
The remaining messages can be displayed by pressing the line/page scroll touch switches.
- An alarm list can monitor bit memory table entries in the range from No. 1 to No. 1000. (When 1000 is set for number of bit memory table entries)
- The maximum number of data to be recorded with the alarm history is 250 for order of occurrence, and 255 for order of frequency.
- When displaying image/library data with alarm list/alarm history elements, the maximum simultaneous display restriction imposed on image and library data applies. Therefore a maximum combined total of 256 image/library data used for alarm lists/histories and image and library data used for other applications can be displayed on one screen. For an overlapping screen comprising 8 child screens, the maximum is 1024.
- If, when library data is displayed with an alarm list/history, the library data projects outside the image/library data display area, nothing is displayed. In the case of image data, only the part inside the area is displayed.
- If no data is registered for the image/library code specified for use with an alarm list/alarm history, nothing will be displayed.
- The contents of the character string memory table entries displayed as messages for alarm lists and alarm histories are read at the following times.

- When an entire alarm list or alarm history is displayed by screen switching
- When a bit being monitored by the alarm list function changes status from OFF to ON, and the corresponding message is displayed.

Messages already displayed are unaffected even if the contents of character string memory table entries change.

- The message display areas for alarm lists/histories are touch switches. Do not overlap them with other touch switches.

Common Attributes

The relationship between the common properties of alarm lists and alarm histories and the display result are indicated below.

Properties

General	
Position	Coordinates of the top left corner of the alarm list/history.
Size	Width and height of the alarm list/history (in dot units) (But note that motion is in touch-switch-sized units only)
Message	
Length	Maximum number of characters in the displayed message NT21: 1 to 32 NT31/NT31C: 1 to 39 NT631/NT631C: 1 to 40 For the alarm history function, the number of characters is decreased by the number required to display the History Info. Restrictions also apply in accordance with the Scale setting.
Display Line Qty	Maximum number of displayed messages NT21: 1 to 7 NT31/NT31C: 1 to 12 NT631/NT631C: 1 to 24
Scale	Scale at which messages are displayed (Enlarged display, page 151) 1 1 (Equal), 1 2 (High), 2 1 (Wide), 2 2, 3 3, 4 4, 8 8
Smoothing	Whether or not smoothing is used for characters with a scale of 2 2 or larger (Smoothing, page 151) Check mark (smoothing executed)/ No check mark (smoothing not executed)
Line Scroll Touch Switches	Presence/absence of touch switches for scrolling messages in line units Check mark (touch switches present)/ No check mark (touch switches absent)
Page Scroll Touch Switches	Presence/absence of touch switches for scrolling messages in page units Check mark (touch switches present)/ No check mark (touch switches absent)

General	
Color	
Frame	Color of the frame (Colors other than black and white are available with the NT31C and NT631C only.) Black/Blue/Red/Magenta/Green/Cyan/Yellow/White
Background	
ON	ON color of the message display field (Colors other than black and white are available with the NT31C and NT631C only.) Black/Blue/Red/Magenta/Green/Cyan/Yellow/White
OFF	OFF color of the message display field (Colors other than black and white are available with the NT31C and NT631C only.) Black/Blue/Red/Magenta/Green/Cyan/Yellow/White
Image & Library	
Display ImageLib	Presence/absence of image library display Check mark (present)/No check mark (absent)
Color	
Foreground	Foreground color of images (valid only for image data in the 2 Colors mode) Black/Blue/Red/Magenta/Green/Cyan/Yellow/White
Background	Background color of image/library displays Black/Blue/Red/Magenta/Green/Cyan/Yellow/White/ Transparent (Transparent is only possible for alarm lists)

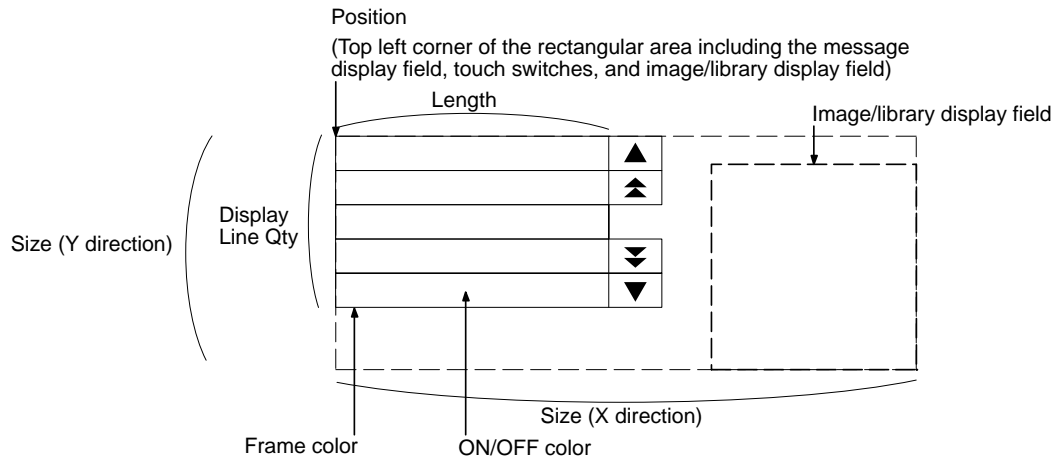

- The position and size of the image/library display field can be changed without restriction.
- The positions of line/page scroll touch switches can be set without restriction. However, the display colors and sizes of them cannot be changed.
- When an image or library display that is larger than the display field has been specified, the image/library display will be displayed full-size at the Support Tool but will be cropped in the smaller PT display field.

Reference: For details on the screen numbers that can be switched by the alarm list/history function and the image/library codes that can be set, refer to 2-3-3 *Bit Memory Table* (page 83).

Display Functions

Alarm List

Apart from the Common Attributes, alarm lists have the properties indicated below.

Properties

Settings	
List Settings	
Start Bit Table Entry	First bit memory table entry number of the bit memory table entries used for monitoring for the alarm list Range: 0 to 1999
No. of Bits Referenced	Number of bit memory table entries used for monitoring for the alarm list Range: 1 to 1000

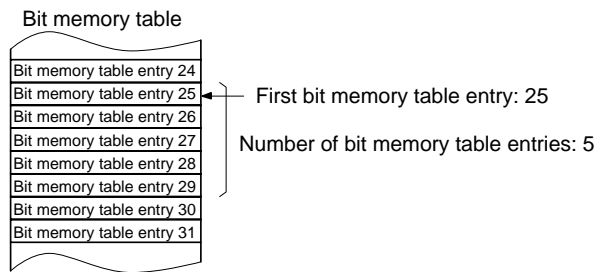

Drawing Result

An alarm list monitors host bits allocated to bit memory table entries within the specified range in accordance with the bit memory table entry function property settings and executes display in accordance with the General settings.

For details on the method of display according to the General settings, refer to *Common Attributes* (page 186).

Alarm lists allow the screen to be switched in accordance with bit memory table entry settings. For details, refer to *2-3-3 Bit Memory Table* (page 83).

Alarm History

Apart from the Common Attributes, alarm histories have the properties indicated below.

Properties

Settings	
History Info	Presence/absence of occurrence time/occurrence frequency displays (this means the presence or absence of the time of occurrence in the case of order of occurrence, and the presence or absence of the occurrence frequency in the case of order of frequency) Check mark (present)/No check mark (absent)
Order Type	Type of display order of frequency/order of occurrence
Info Type	Method of display for the time of occurrence (setting effective only when order of occurrence is set for Order Type and a check mark is set for History Info.) Y/M/D h:m Year/month/day hour:minute (15 digits) M/D h:m Month/day hour:minute (12 digits) h:m Hour:minute (6 digits)

Reference: The number of characters in the specified date/time display are added to the max. message length (1 to 40 characters) set in the general properties. For example, if the max. message length is set to 40 characters and the Info Type is set to Y/M/D h:m (15 digits), a total of 55 characters will be displayed in the alarm history.

Message	
Length	Maximum number of characters in the displayed message NT31/NT31C: 1 to 39 NT631/NT631C: 1 to 40 For the alarm history function, the number of characters is decreased by the number required to display the History Info. Restrictions also apply in accordance with the Scale setting.

Display Result

The history is displayed as follows depending on the settings made for General and Settings:

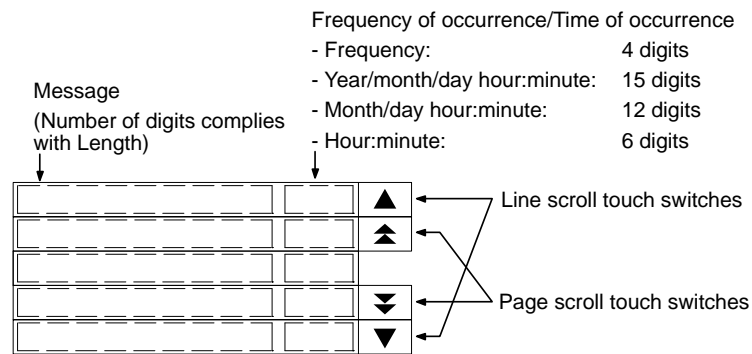

For details on the method of display according to the General settings, refer to *Common Attributes* (page 186).

Alarm histories allow the screen to be switched in accordance with bit memory table entry settings. For details, refer to *2-3-3 Bit Memory Table* (page 83).

Timing of Message Reading

For alarm lists and alarm histories in frequency order, when a message is displayed, scrolling, or screen switching, the character string memory table entry set for the bit memory table entry is read, and the latest message is displayed.

In contrast, in the case of alarm histories in occurrence order, only when the status of the allocated bit of the bit memory table entry changes to 1 (ON), the character string memory table entry set for the bit memory table entry is read and its contents are recorded. Accordingly, even if the contents of the character string memory table entry change later, the displayed message will be kept the recorded contents. However, if the status of another monitored host bit changes to 1 (ON) while an alarm history in occurrence order is being displayed, the latest message at that point is displayed.

Display at Message Update

When the status of a monitored host bit changes during display of an alarm list/ alarm history, the display changes as follows:

With an Alarm List

With an alarm list, when the status of a monitored host bit changes to 1 (ON), the corresponding message is displayed, and when it changes back to 0 (OFF), the message is cleared (the messages are displayed in ascending order of bit memory table entry numbers).

• When a Message Is Added

- If a message is added outside the display range (before or after the display range), there is no change in the messages being displayed.
- If a message is added within the display range, the new message is displayed, and the messages following it are shifted one line downward.

• When a Message Is Deleted

- If a message is deleted outside the display range (before or after the display range), there is no change in the messages being displayed.
- If a message is deleted within the display range, the messages following it are shifted one line upward, except when it is the topmost message in the display that is deleted, in which case the message immediately preceding the present display range is displayed in its place.

If all the displayed messages are deleted at the same time, messages are displayed starting with a message with the same serial number (counting from the top) as the topmost of those that were displayed. (For example, if the previous display started from serial number 7, the new display will also start from a message with serial number 7.)

Alarm History in Occurrence Order

With an alarm history in occurrence order, when the status of the monitored host bit changes to 1 (ON), the corresponding message becomes the latest message (the messages are displayed from the oldest first or from the newest first, depending on the memory switch setting made at the PT). When the status of the bit changes back to 0 (OFF), the message remains displayed.

If the statuses of multiple bits change to 1 (ON) at the same time, the bit memory table entry with the smallest bit memory table entry number is given priority.

• Display from Oldest Record First

Since new messages are added at the end of the history, the displayed messages do not change. However, when the final page is displayed and a message is added below it, the  touch switch is displayed in reverse video to inform the operator that a message has been added.

• Display from the Newest Record First

New messages are added at the top of the history. When a message is added, the screen will switch to the display starting from the first message regardless of the current display position.

Alarm History in Frequency Order

With an alarm history in frequency order, when the status of a monitored host bit changes to 1 (ON), the number of times that bit has changed to 1 (ON) is determined and the display is changed to reflect the new descending order of frequency of occurrence. When the bit status changes back to 0 (OFF), its frequency display remains unchanged.

If there are bits with the same frequency of occurrence, the one whose bit memory table entry has the smallest bit memory table entry number is displayed closest to the top of the history.

The display contents change in real time according to the frequencies of occurrence, but the display range does not change. The serial number (counting from the top) of the message at the topmost position is retained until the display range is changed by touch switch operation.

Lighting of the Message Display Field and Touch Switches for Scrolling

The message display field and touch switches for scrolling light as follows according to the alarm list/history status:

Message Display Field

When a message field is pressed for the first time after it is displayed, or pressed after another message has been pressed, if image/library data is set for the cor-

responding bit memory table entry, the message field lights (the corresponding image/library data is also displayed at this time). This makes it possible to tell at a glance which message the displayed image/library data corresponds to.

Line Scroll Touch Switches

When there are messages above or below the displayed range, these touch switches are lit. This makes it possible to tell at a glance whether there are any messages outside the displayed range.

Page Scroll Touch Switches

If there is one page or more of messages above or below the displayed range, these touch switches are lit. This makes it possible to tell at a glance whether there are any messages outside the displayed range.

Note on Clearing Alarm History Record Data

The alarm history record data can be cleared (initialized) by either of the following operations.

- Select Maintenance Mode → Memory Init. → Alarm History from the System Menu.
- Set bit 1 (alarm history initialization) of the PT status control bits to 1 (ON).

Input Functions

The alarm list and alarm history only read the statuses of bit memory table entries and therefore have no direct input function.

For details on the method for monitoring host bits, refer to *2-3-3 Bit Memory Table* (page 83).

Output Functions

Alarm lists and alarm histories have no output function.

Processing Functions

Alarm lists and alarm histories have no data processing function.

Relationship with Other Elements

- Alarm lists and alarm histories monitor the statuses of host bits, display messages and image/library data, switch screens, etc., in accordance with the settings of bit memory table entries. For details, refer to *2-3-3 Bit Memory Table* (page 83).
- Alarm lists and alarm histories overlap with other elements in accordance with the order in which they were registered for the screen with the Support Tool. However, the way in which they overlap can be changed with the Support Tool.

2-12 Inputting Numeric Values

2-12-1 Numeric Key Type (Numeral Input)

Function Outline

Numeric key type numeral setting input fields are input fields for inputting numeric values on the screen.

The numeric values input into a numeral setting input field using touch switches are written to a numeral memory table entry.

The values can be input either in decimal or hexadecimal format.

The input field functions as a numeral display when it is not receiving inputs.

Outline of Operation

The basic operation of a numeric key type numeral setting input field is shown below.

- 1, 2, 3... 1. A numeric value is input into a numeral setting input field using touch switches.

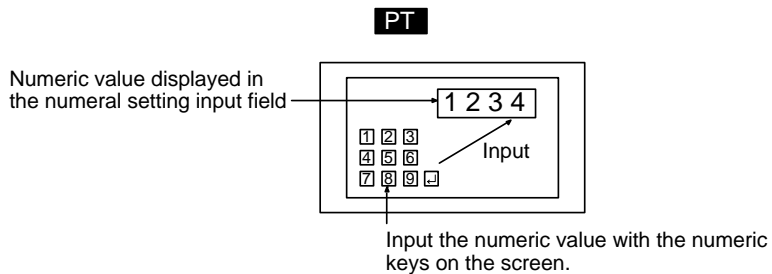

2. On confirming the input numeric value with the ENT key or touch switch it is written to a numeral memory table entry.

At this time, the occurrence of change in the contents of the numeral memory table entry is notified to the host via the PT status notify area.

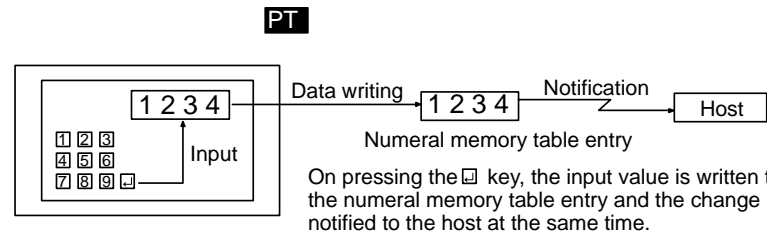

Restrictions

- A maximum combined total of 256 of the following elements can be registered for one screen. (Same for window screens.) Even in the case of an overlapping screen with eight child screens, it is only possible to register numeral setting input fields on one of the child screens.
 - Numeral setting input field (numeric key type),
 - Character setting input field
- A maximum combined total of 26 of the following elements can be registered for one screen for the NT21, 64 for the NT31/NT31C, and 256 for the NT631/NT631C. (Same for window screens.) Even in the case of an overlapping screen with eight child screens, it is only possible to register numeral setting input fields on one of the child screens.
 - Numeral setting input field (thumbwheel type)
- It is not possible to set input from more than one numeral setting input field (numeric key type or thumbwheel type) on the same screen to one numeral memory table entry. In cases where values at the host must be input both in

decimal and hexadecimal, set numeral input into separate numeral memory table entries, both allocated in the same area.

- The range of numeric values that can be input depends on the Storage Type (BCD or Binary) of the numeral memory table entry, and the Display Type (Decimal or Hexadecimal), and Display Sign settings made for the numeral setting input field. For details, refer to 2-3-1 Numeral Memory Table (page 72).
- It is not possible to register multiple input fields (regardless of the type of numeric key or thumbwheel) that refer to the same numeral table entry on the same screen.

Common Attributes

The relationship between the properties of a numeral setting input field and the numeric values input and displayed is indicated below.

Properties

General	
Position	Coordinates of the top left corner of the numeral setting input field
Font Type	Font for the numerals Standard/Half Height/Double Width
Scale	Scale at which the numeric value is displayed (Enlarged display, page 142) 1 1 (Equal), 1 2 (High), 2 1 (Wide), 2 2, 3 3, 4 4, 8 8
Smoothing	Whether or not smoothing is used for numerals with a scale of 2 2 or larger (Smoothing, page 142) Check mark (smoothing executed)/ No check mark (smoothing not executed)
Attribute	Display mode for the numerals (Display attributes and drawing result, page 199) Standard/Flash/Inverse Flash
Color	
Foreground	Display color of the numerals (Colors other than black and white are available with the NT31C and NT631C only.) Black/Blue/Red/Magenta/Green/Cyan/Yellow/White
Background	Background color of the numerals (Colors other than black and white are available with the NT31C and NT631C only.) Black/Blue/Red/Magenta/Green/Cyan/Yellow/White

Settings		
Table Entry	Number of the numeral memory table entry into which the input numeric value is written Range: 0 to 1999	
Display Type	Display format for the numeric value (Input numeric value and stored data, page 195) Decimal/Hexadecimal	
Format (Number of digits displayed, page 194)		
Integer	Number of digits in the integer part of the numeric value Range: 1 to 10	Maximum combined total of 10 digits
Decimal	Number of digits in the decimal fraction of the numeric value Range: 0 to 9	
Limit (Upper/lower (max./min.) limit check, page 197)		
Maximum	Upper limit for numeric values that can be input	
Minimum	Lower limit for numeric values that can be input	
Zero Suppression	Whether or not zero suppression is used (Zero suppression, page 144) Check mark (zero suppression used)/ No check mark (zero suppression not used)	
Display Sign	Whether or not negative numbers are indicated (setting ineffective if Hexadecimal has been set for Display Format) (Input numeric value and stored data, page 195) Check mark (negative numbers indicated)/ No check mark (negative numbers not indicated)	
Focus Frame	Presence/absence of a frame indicating that the numeral setting input field has become ready to accept input Check mark (frame present)/ No check mark (frame not present)	
Focus Attribute	Display status before the input numeric value is confirmed (Display attributes and drawing result, page 199) Standard/Inverse/Flash/Inverse Flash	
Interlock Function		
Interlock	Presence/absence of interlock control of numeral input Check mark (interlock)/No check mark (don't interlock)	
PC address settings		
PC bit address	Allocated interlock bit used to enable/disable operation of the numeral input (See Interlock Bit Allocation on page 199.)	
I/O comments	Comment that explains the allocated bit. Up to 16 characters.	

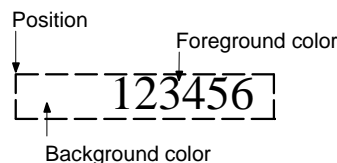

Number of Digits Displayed

All contents of numeral memory table entries are stored as integers. To display a numeric value that has a decimal fraction in a numeral setting input field, set the Decimal setting to 1 or higher to specify the number of places after the decimal point. A decimal point is then automatically inserted.

Note that if the number of digits of the numeric value is greater than the total of the settings for Integer and Decimal, an error occurs and * is displayed for all the digits.

Example: Displaying 123456

- Setting for Integer = 8; setting for Decimal = 0:
Resulting display: 00123456
- Setting for Integer = 4; setting for Decimal = 4:
Resulting display: 0012.3456
- Setting for Integer = 2, setting for Decimal = 4:
Resulting display: 12.3456
- Setting for Integer = 1, setting for Decimal = 4:
Resulting display: *****

For hexadecimal display, only the number of digits of the integral part is specified.

Input Numeric Value and Stored Data

The range of numeric values that can be input and the conversion method for storage depend on the following settings.

- Display Type (Decimal/Hexadecimal)
- Display Sign (whether or not negative values are displayed)

Conversion Depending on Display Type

The data is converted for storage in a numeral memory table entry as follows depending on the setting for Display Type:

- Decimal:
The numeric value input in decimal is converted to signed binary data and stored in the numeral memory table entry.
- Hexadecimal:
The numeric value input in hexadecimal is stored in the numeral memory table entry without alteration.

When the word allocated in the host is input to a 1-word memory table entry, the input value is treated as 4-digit (16-bit) signed binary data so it is converted to 8-digit signed binary data before being stored.

For example, if a value of 8001 hexadecimal is input to a 1-word numeral memory table entry, it is recognized as a negative value because the most significant bit is ON. The value actually stored in the numeral memory table entry is FFFF 8001 hexadecimal.

Reference: Numeral memory table entries store numeric values as signed binary data.

Permissible Input Range

When inputting values into numeral memory table entries, the permissible input range is affected not just by the Display Type and Display Sign but also the Storage Type and Words settings. (When words are not allocated for the numeral memory table entry in the host, the Words setting is treated as 2 words.)

The permissible input range is determined as shown below depending on these properties. If input of a value outside this range is attempted, the PT checks and prevents the input.

Storage Type	Words	Display Type	Sign	Permissible Input Range
BCD	1	Decimal	Unsigned	0 to 9999
			Signed	-999 to 9999
		Hexadecimal	-	FC19 to FFFFH (negative numbers) 0 to 270FH (positive numbers)
	2	Decimal	Unsigned	0 to 99999999
			Signed	-99999999 to 99999999
		Hexadecimal	-	FF676981 to FFFFFFFFH (negative numbers) 0 to 5F5E0FFH (positive numbers)
Binary	1	Decimal	Unsigned	0 to 32767*
			Signed	-32768 to 32767
		Hexadecimal	-	0 to FFFFH
	2	Decimal	Unsigned	0 to 2147483647*
			Signed	-2147483648 to 2147483647
		Hexadecimal	-	0 to FFFFFFFFH

* Note that the values are different from those of the numeral display range. In numeral display, since negative numbers are displayed as absolute values when displaying unsigned decimal values, 32768 and 2147483648, which cannot be input, may be displayed.

Relationship Between Input Numeric Values and Contents of Host Words

When inputting a numeric value to a word allocated for a numeral memory table entry in the host, the value is first converted to signed binary in accordance with the settings for Display Type and Display Sign settings and stored in the numeral memory table entry, and then written to the host word in accordance with the Words and Storage Type settings for the numeral memory table entry. Therefore the result also differs according to the settings made for Words and Storage Type (BCD or Binary).

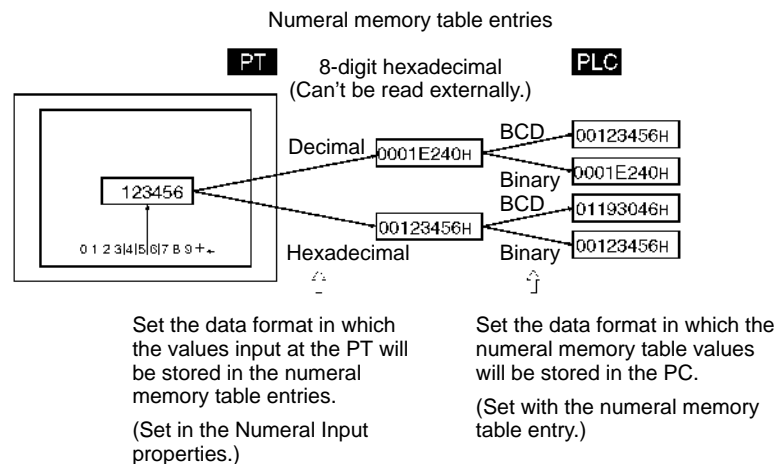

Input numeric value	Display Type	Sign	Numeric value stored in numeral memory table	Words	Storage Type	Contents of word at host
1234	Decimal	Un-signed	000004D2 _H	1 word	BCD	1234
123			0000007B _H	1 word		0123
1234			000004D2 _H	2 words		00001234
1234		Signed	000004D2 _H	1 word		1234
-123			FFFFFF85 _H (FF85 _H)	1 word		F123
-1234			FFFFFFB2E _H	2 words		F0001234
000004D2	Hexadecimal	-	000004D2 _H	1 word		1234
FFFFFF85			FFFFFF85 _H (FF85 _H)	1 word		F123
FFFFFFB2E			FFFFFFB2E _H	2 words		F0001234
4660	Decimal	Un-signed	00001234 _H	1 word	Binary	1234
268430796			0FFFEDEC _H	2 words		0FFFEDEC
4660		Signed	00001234 _H	1 word		1234
-32768			FFF8000 _H (8000 _H)*	1 word		8000
-268430796			F0001234 _H	2 words		F0001234
1234	Hexadecimal	-	00001234 _H	1 word		1234
F123			FFFFF123 _H (F123 _H)*	1 word		F123
F0001234			F0001234 _H	2 words		F0001234

* The figures in parentheses are the values immediately after input. When data is read from the host after input, it is converted to a 32-bit negative number and the value in the numeral memory table entry changes.

Reference: When the Storage Type is BCD, the numeral memory table entry's signed binary data is converted to data for storage in the host word (BCD data) and written to the host. If the value is negative the most significant digit in the word is set as F. This means that the maximum number of digits for a negative number (integer part + decimal fraction part) is seven.

When the Storage Type is Binary, the contents of the numeral memory table entry are written without alteration to the host word.

However, when a negative number is written to a numeral memory table entry whose number of allocated words at the host is one, it is stored immediately after input as a 16-bit negative number.

The data is stored in the numeral memory table entry as a 32-bit negative number in this case as well.

Upper/Lower (Max./Min.) Limit Check

The PT has a function to check the correctness of an input numeric value to prevent a numeric value outside the allowable range from being input so that the input of an illegal value will not adversely affect the system.

For a numeric key type numeral setting input field, the check is executed when an attempt is made to confirm a numeric value. If the value is higher than the upper limit or lower than the lower limit, the buzzer sounds three times and the input value is cleared (the status returns to that before input was attempted).

Note To ensure greater safety for numeric inputs, use the upper/lower limit setting function. Otherwise the system may operate unpredictably.

Reference: Since values input at the PT are handled as signed binary data, be sure to observe the following upper/lower limit settings at the Support Tool when numbers are being input in hexadecimal with its unlimited input range.

- The following values are recognized internally in the PT.
 - 1 word: 8000_H ↔ 0000_H ↔ 7FFF_H (–32,768 ↔ 0 ↔ 32,767 decimal)
 - 2 words: 8000 0000_H ↔ 0000 0000_H ↔ 7FFF FFFF_H
(–2,147,483,648 ↔ 0 ↔ 2,147,483,647 decimal)
- In the Support Tool, the upper/lower limits are set in decimal. (The \$ prefix can be added to input hexadecimal values.)

Using the figures above, the following table shows the upper/lower limits to be set at the Support Tool.

Desired input range	Lower limit to set	Upper limit to set
0 to FFFF _H	–32,768 (\$8000)	32,767 (\$7FFF)
0 to FFFFFFFF _H	–2,147,483,648 (\$8000 0000)	2,147,483,647 (\$7FFF FFFF)

Interlock Function

A numeral input can be controlled (enabled/disabled) from the PC by setting the interlock function for the numeral input and allocating an interlock bit in a PC data area. The status of the allocated interlock bit is read and its status determines whether the input is enabled or disabled.

The following table shows how the PT operates when the interlock function is used or not used.

Interlock function	Operation
Used	Numerical values can be input only while the interlock bit is ON. If you attempt to input a value while the interlock bit is OFF, the buzzer will sound and the input field will not change. When an input is made from a temporary input field to the interlocked numeral input while the interlock bit is OFF, the buzzer will sound when the value in the temporary input field is confirmed and the destination numeral input field will not change.
Not used	Values can be input and confirmed at any time.

The PT continuously reads the status of the corresponding interlock bit while a numeral input field that uses the interlock function is being displayed on the screen. If the interlock bit's status changes, the numeral input field is disabled or enabled according to the interlock bit's status.

Reference: If the touch switch input sound has been turned OFF with the PT's memory switch setting, the buzzer won't sound when you attempt to input a value in an interlocked input field.

Interlock Bit Allocation

Interlock bits can be allocated in the following host (PC) areas.

Symbol	C-series PCs	Allocation	CV-series PCs	Allocation	CS/CJ-series PCs	Allocation
None	IR Area	OK	CIO Area	OK	CIO Area	OK
H	HR Area	OK	---	---	HR Area	Not with Host Link
A	AR Area	OK	Auxiliary Area	No	AR Area	OK
L	LR Area	OK	---	---	LR Area*1	Not with Host Link
T	TC Area, Timer PVs	No	Timer Area, Timer PVs	No	TC Area, Timer PVs	No
TU	---	---	---	---	TC Area, Timer Completion Flags	Not with Host Link
C	TC Area, Counter PVs	No	Counter Area, Counter PVs	No	TC Area, Counter PVs	No
CU	---	---	---	---	TC Area, Counter Completion Flags	Not with Host Link
W	---	---	---	---	WR Area	Not with Host Link
TK	---	---	---	---	Task Flags	Not with Host Link
D	DM Area	OK	DM Area	OK	DM Area	OK
E	EM Area*2, current bank	OK	EM Area, current bank	Not with Host Link	EM Area, current bank	Not with Host Link
E0_ to EC_	---	---	---	---	EM Area, EM banks 0 to C	Not with Host Link

*1: LR 00000 to LR 00199 are converted to CIO 01000 to CIO 01199.

*2: The EM Area is supported only by the C200HX/HG/HE(-Z)E PCs.

Since the Auxiliary Area of the CVM1/CV-series PCs is allocated to system functions, and it cannot be used for purposes other than system use.

The range of each memory area differs according to the PC. Refer to *Appendix D PC Memory Maps* on page 441.

When a DM Area or EM Area address is specified, add a bit number (00 to 15) to the end of the word address.

Display Attributes and Drawing Result

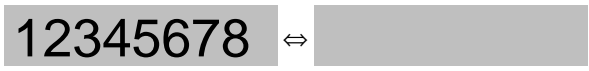
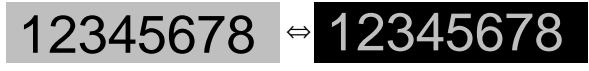
Attribute	Drawing Result
Standard	The character string input field is displayed with the specified foreground color and background color. 
Flash	Repeated alternation of the standard display and no display. 
Inverse Flash	Repeated exchange of the foreground color and background color. 

- Display Functions** Numeric values are displayed in the numeral setting input field in accordance with the General settings.
- For details on the method of display according to the General settings, refer to *Common Attributes* (page 193).
- Input Functions**
- Numeric values are input into numeral setting input fields by using the control code input key touch switches.
 - When a numeral input field using the interlock function is being displayed on the screen, the PT continuously reads the status of the corresponding interlock bit allocated in the PC.
- Output Functions** Numeral setting input fields only write input numeric values to numeral memory table entries; they have no function for directly outputting data to external destinations (if a value is written to a numeral memory table entry for which words have been allocated in the host, the data can be output to the host indirectly).
- However, the input of a numeric value is notified to the host via the PT status notify area.
- Processing Functions** With numeral setting input fields, input numeric values are converted to signed binary data in accordance with the Settings property.
- For details on the method of conversion depending on the Settings property, refer to *Common Attributes* (page 193).
- Relationship with Other Elements**
- Numeral displays (page 140) use the same conversion method and display method as numeral setting input fields.
 - For details on how numeric values are stored in numeral memory table entries, refer to *2-3-1 Numeral Memory Table* (page 72).
 - Input and confirmation touch switches are required in order to use numeral setting input fields. In cases where there are multiple numeral setting input fields, it is also possible to select and move between input fields using touch switches (page 328).
 - Numeral setting input fields overlap with other elements in accordance with the order in which they were registered for the screen with the Support Tool. However, the way in which they overlap can be changed with the Support Tool.

2-12-2 Thumbwheel Type (Thumbwheel)

- Function Outline** Thumbwheel type numeric input fields are input fields for inputting numeric values on the screen.
- Touch switches are provided to increment or decrement each digit of a numeric value, making it easy to change numeric values and to write them to numeral memory table entries.
- The values can be input either in decimal or hexadecimal format.
- The thumbwheel switch functions as a numeral display when it is not receiving inputs.

Outline of Operation

The basic operation of a thumbwheel type numeral setting input field is shown below.

- 1, 2, 3... 1. The value in the numeral setting input field is changed using the incrementing and decrementing (+, -) touch switches.

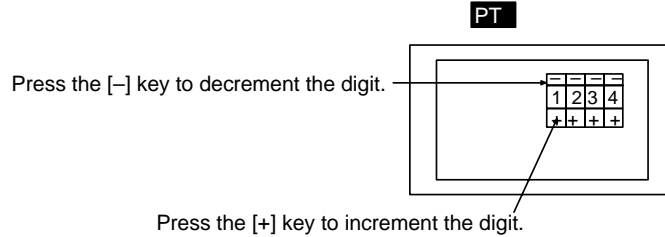

2. Each time a change is made to the numeric value it is confirmed and the occurrence of the change is notified to the host via the PT status notify area.

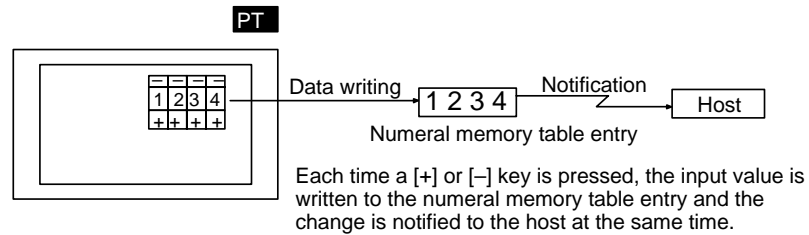

Restrictions

- A maximum combined total of 256 of the following elements can be registered for one screen. (Same for window screens.) Even in the case of an overlapping screen with eight child screens, it is only possible to register numeral setting input fields on one of the child screens.
 - Numeral setting input field (numeric key type),
 - Character setting input field
- A maximum combined total of 26 of the following elements can be registered for one screen for the NT21, 64 for the NT31/NT31C, and 256 for the NT631/NT631C. (Same for window screens.) Even in the case of an overlapping screen with eight child screens, it is only possible to register numeral setting input fields on one of the child screens.
 - Numeral setting input field (thumbwheel type)
- It is not possible to set input from more than one numeral setting input field (numeric key type or thumbwheel type) on the same screen to one numeral memory table entry.

In cases where values at the host must be input both in decimal and hexadecimal, set numeral input into separate numeral memory table entries, both allocated in the same area.
- The range of numeric values that can be input depends on the Storage Type (BCD or Binary) of the numeral memory table entry, and the Display Type (Decimal or Hexadecimal), and Display Sign settings made for the numeral setting input field. For details, refer to 2-3-1 Numeral Memory Table (page 72).
- It is not possible to register multiple input fields (regardless of the type of numeric key or thumbwheel) that refer to the same numeral table entry on the same screen.

Common Attributes

The relationship between the properties of a thumbwheel type numeral setting input field and the numeric values input and displayed is indicated below.

Properties

General	
Position	Coordinates of the top left corner of the numeral setting input field
Size	Size of the input field Small/Medium/Large
End Plate	Presence/absence of end plates at either end of the numeral setting input field Check mark (end plates used)/ No check mark (end plates not used)
Attribute	Display mode for the numerals (Display attributes and drawing result, page 204) Standard/Flash/Inverse Flash
Thumbwheel Color	
Frame	Color of the frame of the numeral setting input field (Colors other than black and white are available with the NT31C and NT631C only.) Black/Blue/Red/Magenta/Green/Cyan/Yellow/White
Foreground	Foreground color of the numeral setting input field (Colors other than black and white are available with the NT31C and NT631C only.) Black/Blue/Red/Magenta/Green/Cyan/Yellow/White
Background	Background color of the numeral setting input field (Colors other than black and white are available with the NT31C and NT631C only.) Black/Blue/Red/Magenta/Green/Cyan/Yellow/White
Character Color	
Foreground	Display color of the numerals (Colors other than black and white are available with the NT31C and NT631C only.) Black/Blue/Red/Magenta/Green/Cyan/Yellow/White
Background	Background color of the numerals (Colors other than black and white are available with the NT31C and NT631C only.) Black/Blue/Red/Magenta/Green/Cyan/Yellow/White

Settings		
Table Entry	Number of the numeral memory table entry into which the input numeric value is written Range: 0 to 1999	
Display Type	Display format for the numeric value (Input numeric value and stored data, page 204) Decimal/Hexadecimal	
Format (Number of digits displayed, page 204)		
Integer	Number of digits in the integer part of the numeric value Range: 1 to 10	Maximum combined total of 10 digits
Decimal	Number of digits in the decimal fraction of the numeric value Range: 0 to 9	
Limit (Upper/lower (max./min.) limit check, page 207)		
Maximum	Upper limit for numeric values that can be input	
Minimum	Lower limit for numeric values that can be input	
Display Sign	Whether or not negative numbers are indicated (setting ineffective if Hexadecimal has been set for Display Format) (Input numeric value and stored data, page 204) Check mark (negative numbers indicated)/ No check mark (negative numbers not indicated)	
Interlock Function		
Interlock	Presence/absence of interlock control of thumbwheel input Check mark (interlock)/No check mark (don't interlock)	
PC address settings		
PC bit address	Allocated interlock bit used to enable/disable operation of the thumbwheel input (See Interlock Bit Allocation on page 208.)	
I/O comments	Comment that explains the allocated bit. Up to 16 characters.	

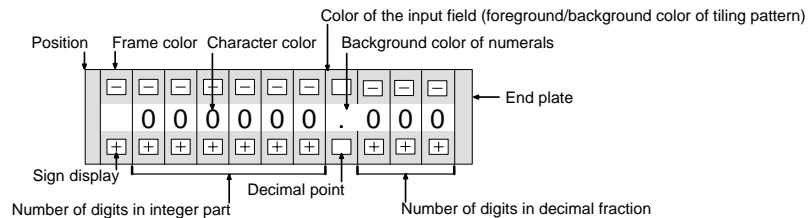

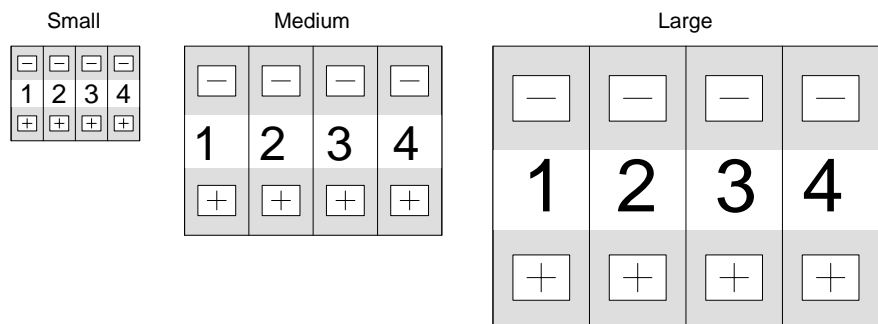

Enlarged Display

Thumbwheel type numeral setting input fields can be displayed in the following three sizes. The sizes of the touch switches in each case are 1 1, 2 2, and 3 3, taking the minimum unit (20 20 dots) as the reference.

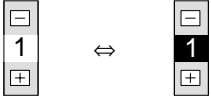

Display Attributes and Drawing Result

Display Attribute	Drawing Result
Standard	The numeral setting input field is displayed with the specified foreground color and background color. 
Flash	Repeated alternation of the standard display and no display. 
Inverse Flash	Repeated exchange of the foreground color and background color. 

Number of Digits Displayed

All contents of numeral memory table entries are stored as integers. To display a numeric value that has a decimal fraction in a numeral setting input field, set the Decimal setting to 1 or higher to specify the number of places after the decimal point. A decimal point is then automatically inserted.

The maximum combined total of digits in the integer part and decimal fraction part is 10 digits. The integer part must always comprise at least one digit.

Note that if the number of digits of the numeric value is greater than the total of the settings for Integer and Decimal, an error occurs and * is displayed for all the digits.

Example: Displaying 123456

- Setting for Integer = 8; setting for Decimal = 0:
Resulting display: 00123456
- Setting for Integer = 4; setting for Decimal = 4:
Resulting display: 0012.3456
- Setting for Integer = 2, setting for Decimal = 4:
Resulting display: 12.3456
- Setting for Integer = 1, setting for Decimal = 4:
Resulting display: *****

Input Numeric Value and Stored Data

The range of numeric values that can be input and the conversion method for storage depend on the following settings.

Display Type (Decimal/Hexadecimal)

Display Sign (whether or not negative values are displayed)

Conversion Depending on Display Type

The data is converted for storage in a numeral memory table entry as follows depending on the setting for Display Type (decimal/hexadecimal) and Display Sign (whether or not negative values are indicated):

- Decimal:
The numeric value input in decimal is converted to signed binary data and stored in the numeral memory table entry.
- Hexadecimal:
The numeric value input in hexadecimal is stored in the numeral memory table entry without alteration.

When the word allocated in the host is input to a 1-word memory table entry, the input value is treated as 4-digit (16-bit) signed binary data so it is converted to 8-digit signed binary data before being stored.

For example, if a value of 8001 hexadecimal is input to a 1-word numeral memory table entry, it is recognized as a negative value because the most significant bit is ON. The value actually stored in the numeral memory table entry is FFFF 8001 hexadecimal.

Reference: Numeral memory table entries store numeric values as signed binary data.

Permissible Input Range

When inputting values into numeral memory table entries, the permissible input range is affected not just by the Display Type and Display Sign but also the Storage Type and Words settings. (When words are not allocated for the numeral memory table entry in the host, the Words setting is treated as 2 words.)

The permissible input range is determined as shown below depending on these properties. If input of a value outside this range is attempted, the PT checks and prevents the input.

Storage Type	Words	Display Type	Sign	Permissible Input Range
BCD	1	Decimal	Unsigned	0 to 9999
			Signed	-999 to 9999
		Hexadecimal	-	FC19 to FFFFH (negative numbers) 0 to 270FH (positive numbers)
	2	Decimal	Unsigned	0 to 99999999
			Signed	-99999999 to 99999999
		Hexadecimal	-	FF676981 to FFFFFFFFH (negative numbers) 0 to 5F5E0FFH (positive numbers)
Binary	1	Decimal	Unsigned	0 to 32767*
			Signed	-32768 to 32767
		Hexadecimal	-	0 to FFFFH
	2	Decimal	Unsigned	0 to 2147483647*
			Signed	-2147483648 to 2147483647
		Hexadecimal	-	0 to FFFFFFFFH

* Note that the values are different from those of the numeral display range. In numeral display, since negative numbers are displayed as absolute values when displaying unsigned decimal values, 32768 and 2147483648, which cannot be input, may be displayed.

Relationship Between Input Numeric Values and Contents of Host Words

When inputting a numeric value to a numeral memory table entry for which a word is allocated in the host, the value is first converted to signed binary in accordance with the settings for Display Type and Display Sign settings and stored in the numeral memory table, and then written to the host word in accordance with the Words and Storage Type settings for the numeral memory table entry.

Therefore the result also differs according to the settings made for Words and Storage Type (BCD or Binary).

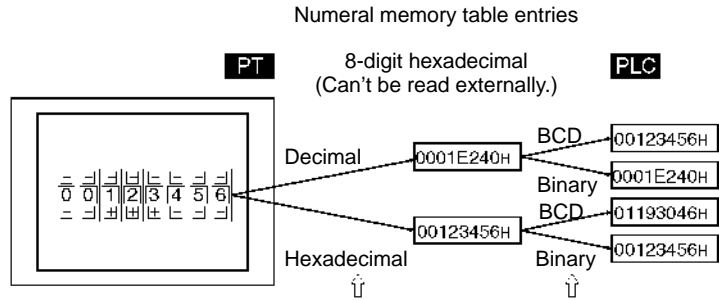

Set the data format in which the values input at the PT will be stored in the numeral memory table entries.
(Set in the Thumbwheel Numeral Input properties.)

Set the data format in which the numeral memory table values will be stored in the PC.
(Set with the numeral memory table entries.)

The following table provides some examples:

Input numeric value	Display Type	Sign	Numeric value stored in numeral memory table	Words	Storage Type	Contents of word at host
1234	Decimal	Un-signed	000004D2 _H	1 word	BCD	1234
123			0000007B _H	1 word		0123
1234			000004D2 _H	2 words		00001234
1234		Signed	000004D2 _H	1 word		1234
-123			FFFFFF85 _H (FF85 _H)	1 word		F123
-1234			FFFFFFB2E _H	2 words		F0001234
000004D2	Hexadecimal	-	000004D2 _H	1 word	Binary	1234
FF85			FFFFFF85 _H (FF85 _H)	1 word		F123
FFFFFFB2E			FFFFFFB2E _H	2 words		F0001234
4660	Decimal	Un-signed	00001234 _H	1 word	Binary	1234
268430796			0FFFE _{DCC} _H	2 words		0FFFE _{DCC}
4660		Signed	00001234 _H	1 word		1234
-32768			FFFF8000 _H (8000 _H)*	1 word		8000
-268430796			F0001234 _H	2 words		F0001234
1234	Hexadecimal	-	00001234 _H	1 word	Binary	1234
F123			FFFFF123 _H (F123 _H)*	1 word		F123
F0001234			F0001234 _H	2 words		F0001234

* The figures in parentheses are the values immediately after input. When data is read from the host after input, it is converted to a 32-bit negative number and the value in the numeral memory table entry changes.

Reference: When the Storage Type is BCD, the numeral memory table entry's signed binary data is converted to data for storage in the host word (BCD data) and written to the host. If the value is negative the most significant digit in the word is set as F. This means that the maximum number of digits for a negative number (integer part + decimal fraction part) is seven.

When the Storage Type is Binary, the contents of the numeral memory table entry are written without alteration to the host word.

However, when a negative number is written to a numeral memory table entry whose number of allocated words at the host is one, it is stored immediately after input as a 16-bit negative number.

The data is stored in the numeral memory table entry as a 32-bit negative number in this case as well.

Upper/Lower (Max./Min.) Limit Check

The PT has a function to check the correctness of an input numeric value to prevent a numeric value outside the allowable range from being input so that the input of an illegal value will not adversely affect the system.

The upper/lower (max./min.) limit check is executed in the timing indicated below according to the type of a numeral setting input field.

For a thumbwheel type numeral setting input field, the check is executed each time the increment/decrement key of each digit position is pressed.

With a thumbwheel type numeral setting input field, if $n\dots n < m\dots m$ [upper limit: $1n\dots n$, lower limit: $0m\dots m$ (n and m are arbitrary values at each digit)], carry over and underflow are not possible at the highest digit position.

Example:

If the upper limit value and the lower limit value are 1200 and 201, respectively, the numeric value can be changed only in the following range: from 201 to 999 if an initial value is a 3-digit value and from 1000 to 1200 if an initial value is a 4-digit value.

The reason for this is that the upper/lower (max./min.) limit check function does not allow the numeric value at the highest digit position to change from 0 to 1 or from 1 to 0.

To avoid this, set the upper and lower limit values so that $n\dots n \geq m\dots m$, or provide a touch switch separately to write a numeric value for carry over or underflow.

Note To ensure greater safety for numeric inputs, use the upper/lower limit setting function. Otherwise the system may operate unpredictably.

Reference: Since values input at the PT are handled as signed binary data, be sure to observe the following upper/lower limit settings at the Support Tool when numbers are being input in hexadecimal with its unlimited input range.

- The following values are recognized internally in the PT.
 - 1 word: $8000_H \leftrightarrow 0000_H \leftrightarrow 7FFF_H$ ($-32,768 \leftrightarrow 0 \leftrightarrow 32,767$ decimal)
 - 2 words: $8000\ 0000_H \leftrightarrow 0000\ 0000_H \leftrightarrow 7FFF\ FFFF_H$
($-2,147,483,648 \leftrightarrow 0 \leftrightarrow 2,147,483,647$ decimal)
- In the Support Tool, the upper/lower limits are set in decimal. (The \$ prefix can be added to input hexadecimal values.)

Using the figures above, the following table shows the upper/lower limits to be set at the Support Tool.

Desired input range	Lower limit to set	Upper limit to set
0 to $FFFF_H$	-32,768 (\$8000)	32,767 (\$7FFF)
0 to $FFFFFFFF_H$	-2,147,483,648 (\$8000 0000)	2,147,483,647 (\$7FFF FFFF)

Interlock Function

A numeral input from a thumbwheel switch can be controlled (enabled/disabled) from the PC by setting the interlock function for the numeral input and allocating an interlock bit in a PC data area. The status of the allocated interlock bit is read and its status determines whether the thumbwheel switch is enabled or disabled.

The following table shows how the PT operates when the interlock function is used or not used.

Interlock function	Operation
Used	Numerical values can be changed by pressing the increment and decrement touch switches only while the interlock bit is ON. If you attempt to change a value while the interlock bit is OFF, the buzzer will sound and the value will not change.
Not used	Values can be changed with the increment and decrement touch switches at any time.

The PT continuously reads the status of the corresponding interlock bit while a thumbwheel switch's numeral input field that uses the interlock function is being displayed on the screen. If the interlock bit's status changes, the thumbwheel switch is disabled or enabled according to the interlock bit's status.

Reference: If the touch switch input sound has been turned OFF with the PT's memory switch setting, the buzzer won't sound even though you attempt to change an interlocked thumbwheel switch's value.

Interlock Bit Allocation

Interlock bits can be allocated in the following host (PC) areas.

Symbol	C-series PCs	Allocation	CV-series PCs	Allocation	CS/CJ-series PCs	Allocation
None	IR Area	OK	CIO Area	OK	CIO Area	OK
H	HR Area	OK	---	---	HR Area	Not with Host Link
A	AR Area	OK	Auxiliary Area	No	AR Area	OK
L	LR Area	OK	---	---	LR Area*1	Not with Host Link
T	TC Area, Timer PVs	No	Timer Area, Timer PVs	No	TC Area, Timer PVs	No
TU	---	---	---	---	TC Area, Timer Completion Flags	Not with Host Link
C	TC Area, Counter PVs	No	Counter Area, Counter PVs	No	TC Area, Counter PVs	No
CU	---	---	---	---	TC Area, Counter Completion Flags	Not with Host Link
W	---	---	---	---	WR Area	Not with Host Link
TK	---	---	---	---	Task Flags	Not with Host Link
D	DM Area	OK	DM Area	OK	DM Area	OK
E	EM Area *2, current bank	OK	EM Area, current bank	Not with Host Link	EM Area, current bank	Not with Host Link
E0_ to EC_	---	---	---	---	EM Area, EM banks 0 to C	Not with Host Link

*1: LR 00000 to LR 00199 are converted to CIO 01000 to CIO 01199.

*2: The EM Area is supported only by the C200HX/HG/HE(-Z)E PCs.

Since the Auxiliary Area of the CVM1/CV-series PCs is allocated to system functions, and it cannot be used for purposes other than system use.

The range of each memory area differs according to the PC. Refer to *Appendix D PC Memory Maps* on page 441.

When a DM Area or EM Area address is specified, add a bit number (00 to 15) to the end of the word address.

Display Functions

Numeric values are displayed in the numeral setting input field in accordance with the General settings.

For details on the method of display according to the General settings, refer to *Common Attributes* (page 202).

Input Functions

- Numeric values are input into a thumbwheel type numeral setting input field by using the + and – touch switches provided for each digit.
- When a thumbwheel switch using the interlock function is being displayed on the screen, the PT continuously reads the status of the corresponding interlock bit allocated in the PC.

Output Functions

Numeral setting input fields only write input numeric values to numeral memory table entries; they have no function for directly outputting data to external destinations (if a value is written to a numeral memory table entry for which a word has been allocated in the host, the value can be output to the host indirectly).

However, the input of a numeric value is notified to the host via the PT status notify area.

Processing Functions

Numeral setting input fields have no data processing functions.

Relationship with Other Elements

- Numeral displays (page 140) use the same conversion method and display method as numeral setting input fields.
- For details on how numeric values are stored in numeral memory table entries, refer to *2-3-1 Numeral Memory Table* (page 72).
- Numeral setting input fields overlap with other elements in accordance with the order in which they were registered for the screen with the Support Tool. However, the way in which they overlap can be changed with the Support Tool.

2-13 Inputting Character Strings

Function Outline

Character string input fields are input fields for inputting character strings on the screen.

The character string input into the character string input field using touch switches is written to a character string memory table entry.

Bar codes can also be read and input by using a bar code reader connected to the PT.

The character string input field functions as a character string display when it is not receiving inputs.

Reference: There are two input methods when inputting character strings from a bar code reader: automatic confirmation, where the character string is confirmed on input, and manual confirmation, where the character string has to be confirmed by touch switch operation. Which of these methods is used is determined by the setting made for communication port A with the memory switches of the System Menu (Set Bar-Code Reader, then set automatic confirmation or manual confirmation for Comm. Setting.)

Outline of Operation

The basic operation of a character string input field is shown below.

- 1, 2, 3...
1. Input a character string into a character string input field using touch switches or a bar code reader. The input text is inserted at the position of the input cursor.

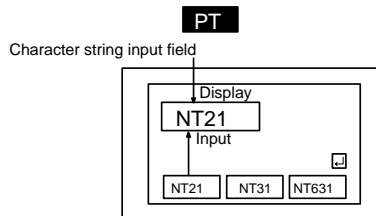

2. Confirm the input character string with the ENT key or  touch switch: it will be written to a character string memory table entry (when the input mode from a bar code reader is set as automatic confirmation, the character string is automatically confirmed on input).

At this time, the occurrence of a change in the contents of the character string memory table entry is notified to the host via the PT status notify area.

The writing of character string data to a character string memory table entry, and notification to the host, are not automatically executed merely by displaying a character string in a character string input field. Writing and notification are executed when the ENT key or  key touch switch is pressed.

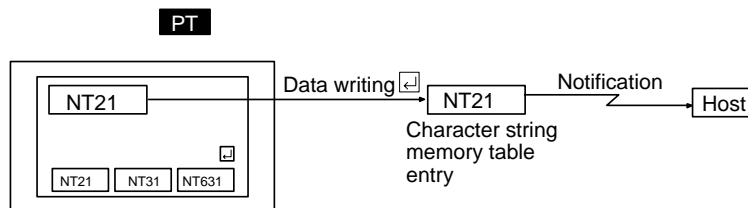

Restrictions

- A maximum combined total of 256 of the following elements can be registered for one screen. (Same for window screen) Even in the case of an overlapping screen with eight child screens, it is only possible to register character string input fields on one of the child screens.

Character string input field

There is no restriction on the number of input fields that can be registered for one screen data file: any number can be registered as long as the data file capacity is not exceeded. However, if a large number of elements are registered, check that the restrictions on element display are complied with by referring to Display Restrictions (page 437).

- It is not possible to set character string input from more than one character string input field on the same screen to one character string memory table entry.
- The following numbers of characters can be displayed in one character string input field, depending on the scale.

Magnification	NT21	NT31/NT31C	NT631/NT631C
1 1 (Equal)	Up to 32 characters	Up to 40 characters	Up to 40 characters
1 2 (High)	Up to 32 characters	Up to 40 characters	Up to 40 characters
2 1 (Wide)	Up to 16 characters	Up to 20 characters	Up to 40 characters
2 2	Up to 16 characters	Up to 20 characters	Up to 40 characters
3 3	Up to 10 characters	Up to 13 characters	Up to 26 characters
4 4	Up to 8 characters	Up to 10 characters	Up to 20 characters
8 8	Up to 4 characters	Up to 5 characters	Up to 10 characters

- The characters that can be displayed are alphanumeric, symbols and Marks. Marks are displayed at the standard height even if Half Height is set as the Font Type. Therefore, if normal alphanumeric and symbols are displayed after displaying a mark, part of the mark will remain displayed, as shown in the figure below.
- If Half Height is set for Font Type, and a character string is written after displaying Marks, a part of the Marks will remain displayed, as shown below.

In this case, create blank characters as marks, write these marks, and then write the alphanumeric and symbol character string over them.

- It is not possible to register multiple input fields that refer to the same string table entry on the same screen.

Reference: When the PT is in NT20S or NT30/620 compatible mode, marks, image codes, and library codes can also be input. Refer to *Appendix C* for details on the NT20S and NT30/620 compatible modes.

Common Attributes

The relationship between the properties of a character string input field and the input and displayed character string is indicated below.

Properties

General	
Position	Coordinates of the top left corner of the character string input field
Font Type	Font for the characters Standard/Half Height
Scale	Scale at which the character string is displayed (Enlarged display, page 151) 1 1 (Equal), 1 2 (High), 2 1 (Wide), 2 2, 3 3, 4 4, 8 8
Smoothing	Whether or not smoothing is used for characters with a scale of 2 2 or larger (Smoothing, page 151) Check mark (smoothing executed)/ No check mark (smoothing not executed)
Attribute	Display mode for the text (Display attributes and drawing result, page 214) Standard/Flash/Inverse Flash
Color	
Foreground	Display color of the text (Colors other than black and white are available with the NT31C and NT631C only.) Black/Blue/Red/Magenta/Green/Cyan/Yellow/White
Background	Background color of the text (Colors other than black and white are available with the NT31C and NT631C only.) Black/Blue/Red/Magenta/Green/Cyan/Yellow/White
Settings	
Table Entry	Number of the character string memory table entry to which the input character string is to be written Range: 0 to 1999
Length	Maximum number of characters in the input character string NT21: 1 to 32 NT31/NT31C: 1 to 40 NT631/NT631C: 1 to 40
Focus Frame	Presence/absence of a frame indicating that the character string input field has become ready to accept input Check mark (frame present)/ No check mark (frame not present)
Focus Attribute	Display status before the input character string is confirmed (Display attributes and drawing result, page 214) Standard/Inverse/Flash/Inverse Flash
Interlock Function	
Interlock	Presence/absence of interlock control of character string input Check mark (interlock)/No check mark (don't interlock)
PC address settings	
PC bit address	Allocated interlock bit used to enable/disable operation of the character string input (See Interlock Bit Allocation on page 213.)
I/O comments	Comment that explains the allocated bit. Up to 16 characters.

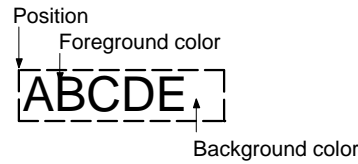

If the number of characters actually input is greater than the number of input characters set for the character string input field, the excess characters are ignored.

If the number of characters actually input is less than the number of input characters set for the character string input field, the character string is input at the cursor position, and the characters that were to the right of the cursor position are shifted to the right. Therefore, when a character string with fewer than the set number of characters is input, characters that were displayed previously will be displayed following this character string. To make these characters blanks, either fill the surplus part with blanks, or use touch switches with the control code input function (BS, DEL, etc.) to delete the surplus characters before confirmation.

Interlock Function

A character string input can be controlled (enabled/disabled) from the PC by setting the interlock function for the character string input and allocating an interlock bit in a PC data area. The status of the allocated interlock bit is read and its status determines whether the input is enabled or disabled.

The following table shows how the PT operates when the interlock function is used or not used.

Interlock function	Operation
Used	<p>Character strings can be input only while the interlock bit is ON.</p> <p>If you attempt to input a character string while the interlock bit is OFF, the buzzer will sound and the input field will not change.</p> <p>When an input is made from a temporary input field to an interlocked character string input while the interlock bit is OFF, the buzzer will sound when the character string in the temporary input field is confirmed and the destination character string input field will not change.</p> <p>When an input is made from a bar code reader to an interlocked character string input while the interlock bit is OFF, the character string that was read will not appear in the input field and the buzzer will sound whether manual confirmation or automatic confirmation is being used. The destination character string input field will not change.</p>
Not used	Character strings can be input and confirmed at any time.

The PT continuously reads the status of the corresponding interlock bit while a character string input field that uses the interlock function is being displayed on the screen. If the interlock bit's status changes, the character string input field is disabled or enabled according to the interlock bit's status.

Reference: If the touch switch input sound has been turned OFF with the PT's memory switch setting, the buzzer won't sound when you attempt to input a character string in an interlocked input field.

Interlock Bit Allocation

Interlock bits can be allocated in the following host (PC) areas.

Symbol	C-series PCs	Allocation	CV-series PCs	Allocation	CS/CJ-series PCs	Allocation
None	IR Area	OK	CIO Area	OK	CIO Area	OK
H	HR Area	OK	---	---	HR Area	Not with Host Link

Symbol	C-series PCs	Allocation	CV-series PCs	Allocation	CS/CJ-series PCs	Allocation
A	AR Area	OK	Auxiliary Area	No	AR Area	OK
L	LR Area	OK	---	---	LR Area*1	Not with Host Link
T	TC Area, Timer PVs	No	Timer Area, Timer PVs	No	TC Area, Timer PVs	No
TU	---	---	---	---	TC Area, Timer Completion Flags	Not with Host Link
C	TC Area, Counter PVs	No	Counter Area, Counter PVs	No	TC Area, Counter PVs	No
CU	---	---	---	---	TC Area, Counter Completion Flags	Not with Host Link
W	---	---	---	---	WR Area	Not with Host Link
TK	---	---	---	---	Task Flags	Not with Host Link
D	DM Area	OK	DM Area	OK	DM Area	OK
E	EM Area *2, current bank	OK	EM Area, current bank	Not with Host Link	EM Area, current bank	Not with Host Link
E0_ to EC_	---	---	---	---	EM Area, EM banks 0 to C	Not with Host Link

*1: LR 00000 to LR 00199 are converted to CIO 01000 to CIO 01199.



*2: The EM Area is supported only by the C200HX/HG/HE(-Z)E PCs.

Since the Auxiliary Area of the CVM1/CV-series PCs is allocated to system functions, and it cannot be used for purposes other than system use.

The range of each memory area differs according to the PC. Refer to *Appendix D PC Memory Maps* on page 441.

When a DM Area or EM Area address is specified, add a bit number (00 to 15) to the end of the word address.

Display Attributes and Drawing Result

Attribute	Drawing Result
Standard	The character string input field is displayed with the specified foreground color and background color. 
Flash	Repeated alternation of the standard display and no display. 
Inverse Flash	Repeated exchange of the foreground color and background color. 

Display Functions

Character strings are displayed in the character string input field in accordance with the General settings.

For details on the method of display according to the General settings, refer to *Common Attributes* (page 212).

Input Functions

Character strings are input into the character string input field by using the input key – string and input key – control touch switches or a bar code reader.

For details on the connection and settings of the bar code reader, refer to section 3 of the *Setup Manual*.

When a character string input field using the interlock function is being displayed on the screen, the PT continuously reads the status of the corresponding interlock bit allocated in the PC.

Output Functions

Character string input fields only write input character strings to character string memory table entries; they have no function for directly outputting data to external destinations (if a character string is written to the character string memory table entry for which words have been allocated in the host, the data can be output to the host indirectly).

However, the input of a character string is notified to the host via the PT status notify area.

Processing Functions

Character string input fields have no processing function.

Relationship with Other Elements

- Character string displays (page 148) use the same display method as character string input fields.
- For details on how character strings are stored in character string memory table entries, refer to *2-3-2 Character String Memory Table* (page 79).
- In order to use a character string input field, input and confirmation touch switches are required, unless a bar code reader is used with the automatic confirmation setting. In cases where there is more than one input field, switches for selecting and moving input fields are also required (page 342).
- Character string input fields overlap with other elements in accordance with the order in which they were registered for the screen with the Support Tool. However, the way in which they overlap can be changed with the Support Tool.

2-14 Recipes

2-14-1 Function Outline

You can write data in table format to the host (PC memory or PT memory), and read data in table format from the host. Use this function to write multiple settings from the PT to the host in a single operation, and to read multiple settings from the host in a single operation.

- The data in table format (“recipe data”) consists of names and parameters (initial values). You can create multiple recipe data for a single application, and can use it as a recipe table after storing it in a PT.
- Recipe elements consist of the specified data in table format (see above), and dedicated recipe touch switches (Read and Write touch switches, and the scroll touch switches). You can use recipe elements to display and edit specific recipe data, write data to the host, or read data from the host.
- Set the initial values for parameters within data in table format using the Support Tool. After you set the initial value, you can change the parameters using either of the following two methods.

- 1, 2, 3... 1. Edit each parameter individually using the pop-up window for entering values on the PT.
2. Read and write parameters from/to the host (i.e., PC or PT memory) one record at a time using the Read and Write touch switches for recipes on the PT.

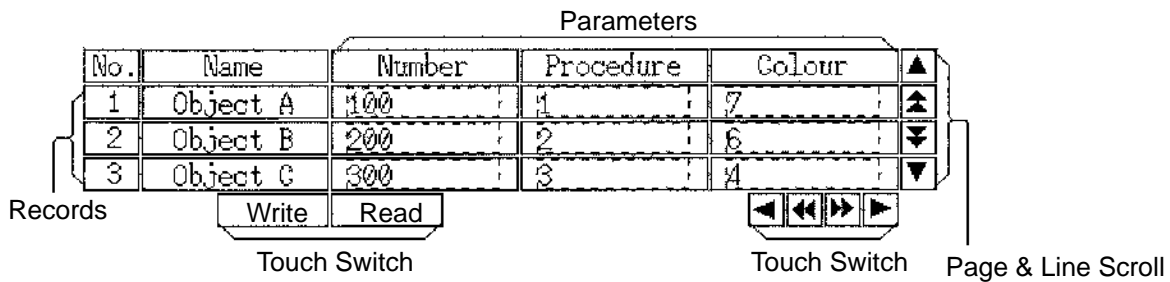

Example

Records for Objects A, B, and C, which set temperature, pressure, and processing time as parameters.

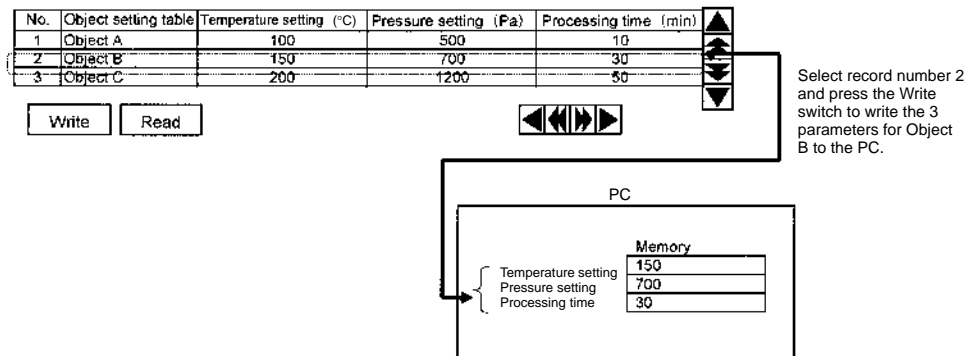

The following additional functions are also provided.

- You can specify whether to permit editing of parameters on the PT using the Support Tool (in one record unit).
- You can set the interlock function (i.e., prohibiting operation) for all touch switches.
- After writing to the host, you can send a writing completed notification to the host using the status notify bits (strobe operation) on the host.

Outline

Overall Configuration

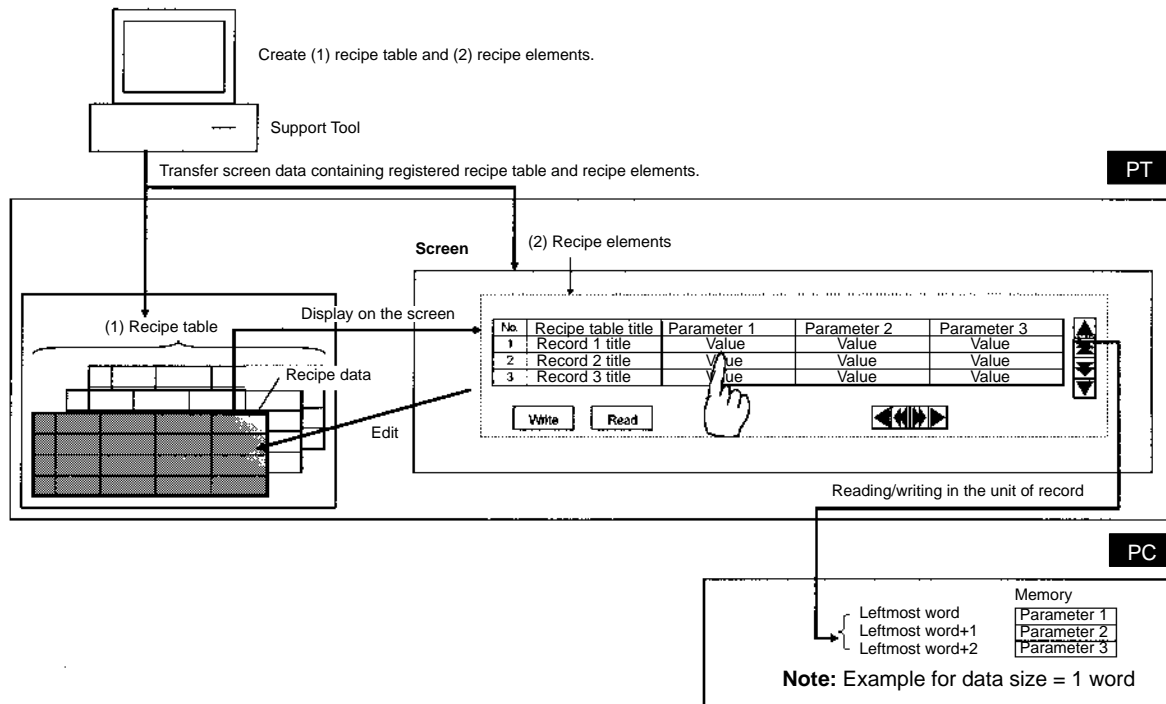

- Use the Support Tool to create the following two types of data: (1) Table data (recipe table) and (2) Display and setting elements (recipe elements) that use the recipe table.

1, 2, 3...

1. Recipe table: Multiple discrete data in table format (the data is called "recipe data").
2. Recipe elements: These elements display recipe data on screen, and read and write data from/to the host. Register and use recipe elements on a screen. Specify the recipe data to be used by its number, and arrange and create special recipe touch switches as appropriate.

Reference: Multiple recipe elements can also share (i.e., reference and use) the same recipe data.

- Transfer screen data to which recipe elements and recipe table are registered from the Support Tool to the PT by application downloading.
- Recipe elements that have been registered on screen read corresponding recipe data from the PT.
- You can change recipe data parameters by performing the edit operation using the touch switches on the PT.
- You can read and write recipe data parameters in units of host words or records using the Read and Write touch switches on the PT.

List of Functions

Item	Function			
Recipe table	Consist of multiple individual recipe data.			
Recipe data (table data) details	1,000 records (entries) max.			
	<table border="1"> <tr> <td data-bbox="759 325 935 367">Record</td> <td data-bbox="935 325 1444 367">Consists of 200 parameters max.</td> </tr> <tr> <td data-bbox="759 367 935 451">Parameter</td> <td data-bbox="935 367 1444 451">Numerical data A touch switch for moving the cursor appears in the parameter field.</td> </tr> </table>	Record	Consists of 200 parameters max.	Parameter
Record	Consists of 200 parameters max.			
Parameter	Numerical data A touch switch for moving the cursor appears in the parameter field.			
Recipe data that can be registered in one application	200 max., to a memory capacity of 40 Kbytes max.			
Recipe elements	Consist of recipe data display field and special recipe touch switches.			
Recipe data number to be used (referenced)	Specify the recipe data used as a recipe element from the recipe table using its number (a number from 1 to 200 is automatically assigned to each recipe data item).			
Recipe elements that can be registered in one screen	Normal (standard) screen: 1 max. Overlapping screen: 8 max. Window screen: Not possible.			
Transferring recipe tables and recipe elements	<p>When the PT is in transmit mode, you can transfer the following units from the Support Tool to the PT.</p> <ul style="list-style-type: none"> • All screen data (applications): All recipe tables and recipe elements • Screen data with recipe data affixed: Recipe elements only • Recipe table: Recipe tables only 			
Setting parameters	<ul style="list-style-type: none"> • Set the initial recipe data parameters using the Support Tool. • Press the parameter field in the recipe elements. The parameter field will become an input field, and the specified pop-up window will be displayed. You can enter the values in the parameters field using the input and confirmation touch switches set in the window beforehand. <p>Note You can restore the edited parameters to their initial values set using the Support Tool by using the System Menu (Maintenance Mode/Memory Init.) on the PT.</p>			
Exchanging record data with host words (PC memory or PT memory)	<ul style="list-style-type: none"> • Select a record, and then press the Write touch switch to write all the parameters for one record to specified consecutive words on the host. • Select a record, and then press the Read touch switch to read all the parameters for one record from specified consecutive words on the host. <p>Note You can select any of the following communications methods (serial communications mode) between the PT and PC: 1:1 NT Link, 1:N NT Link, or host link.</p>			
Additional functions	<ul style="list-style-type: none"> • You can enable or disable edit operations for each record individually on the PT using the Support Tool. • You can prohibit all recipe touch switch operations while a specified host bit is OFF. (Interlock function.) • When writing to a word in the host is completed, you can send an operation completed notification using a strobe operation (OFF→ON→OFF) of a specified bit in the host. 			

Display Configuration of Recipe Elements

Recipe elements are displayed with records as rows and parameters as columns.



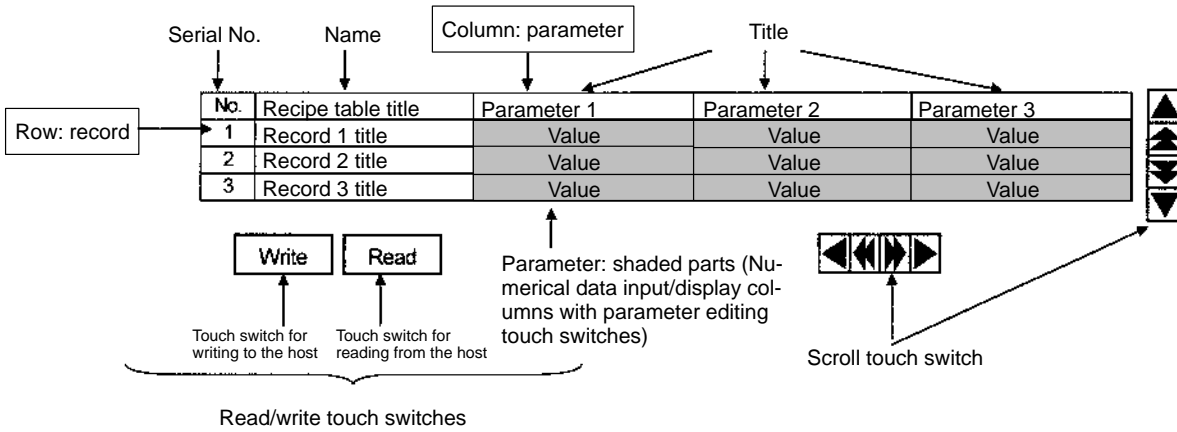

Set the parameters (numerical data) in the parts shaded below. Unshaded parts are fixed character strings.

You can set the parameters (numerical data) using initial settings on the Support Tool or an edit operation on the PT.

You can read and write set parameters (numerical data) in record units from/to the host (PC memory or PT memory) using touch switch on the PT.

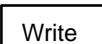
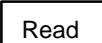
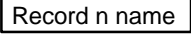
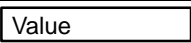

Elements Configuration Table

Table format		Displays records as rows, and parameters as columns.		
Recipe data (1 data in table format)	Recipe data name	You can attach a table name to the top left.		
	Recipe data comment	You can attach a comment about the table (not displayed on PT screen).		
	Storage type of allocated words in host (can be specified for each recipe data)	Select from BCD, binary, or system setting.		
Name field	Record name	You can display a comment for each record at the start of the row. Has a record selecting touch switch.		
	Parameter name	You can display a comment for each parameter at the start of the column.		
Parameter field	Initial values	<p>The initial values are set in the screen data sent to the PT. Thereafter, you can change the data by performing an operation from the PT, or exchanging data with the host.</p> <p>The column contains touch switches for editing parameters.</p>		
Special recipe touch switches	Scroll touch switches	Page scroll touch switches for records		Take the number of records displayed to be 1 page, and then scroll 1 page up or down at a time.
		Page scroll touch switches for parameters		Take number of parameters displayed to be 1 page, and then scroll 1 page sideways at a time.
		Line scroll touch switches for records		Scroll 1 record up or down.
		Line scroll touch switches for parameters		Scroll 1 parameter sideways.
	Read and Write touch switches	Write touch switch		Writes record data selected using the record selecting touch switches to the host.
		Read touch switch		Reads the record data selected using the record selecting touch switches from the host.
	Record selecting touch switches			<p>Touch switch for the record name field.</p> <p>Use to select the target record when reading and writing from/to the host by touch switch operation.</p>
	Parameter editing touch switch			<p>Touch switch in the parameter field.</p> <p>Press this touch switch to enable input in the parameter field. You can also open a window specified for inputting values at the same time.</p>

Reference: You can also select not to display parameters in units of recipe data, using recipe element settings in the Support Tool.
 You can also select not to display serial numbers to the left of record names, using Support Tool settings.

2-14-2 Operation Outline

The basic recipe element operations are given below.

Initial Settings Using the Support Tool

1, 2, 3... 1. Recipe Table (Total Recipe Data) Settings

When creating recipe tables using the Support Tool, set the parameter values, recipe data name, recipe data comments, record names, and parameter names.

- a) Names and comments can be set only from the Support Tool. You cannot change them from the PT.
- b) You can also set the following details in the recipe table using the Support Tool.

Enable or disable parameter editing on the PT ("Lock"; set for each record individually), and specify the start address for consecutive words allocated in the host.

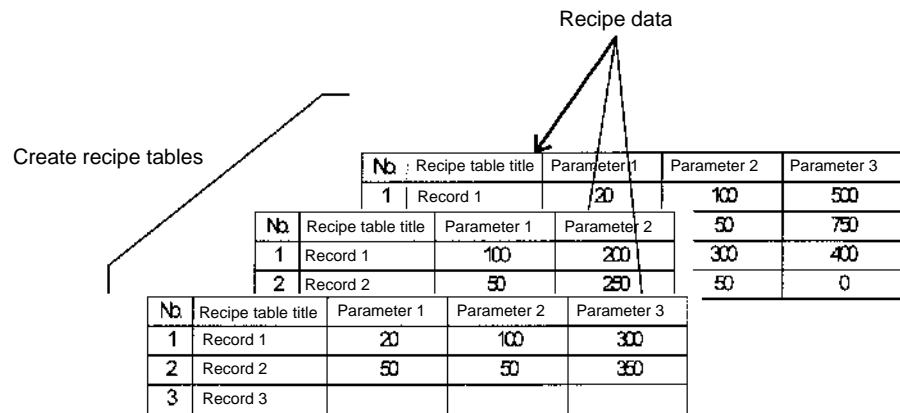

2. Pasting Recipe Elements on Screens

Create recipe elements on screen using the Support Tool. In the recipe element, specify the recipe data number to be displayed or set.

Note You can also set the following details in the recipe elements using the Support Tool.

Show/hide parameters, and enable or prohibit all recipe touch switches (i.e., interlock function).

Refer to the *NT-series Support Tool Version 4 for Windows Operation Manual* for details.

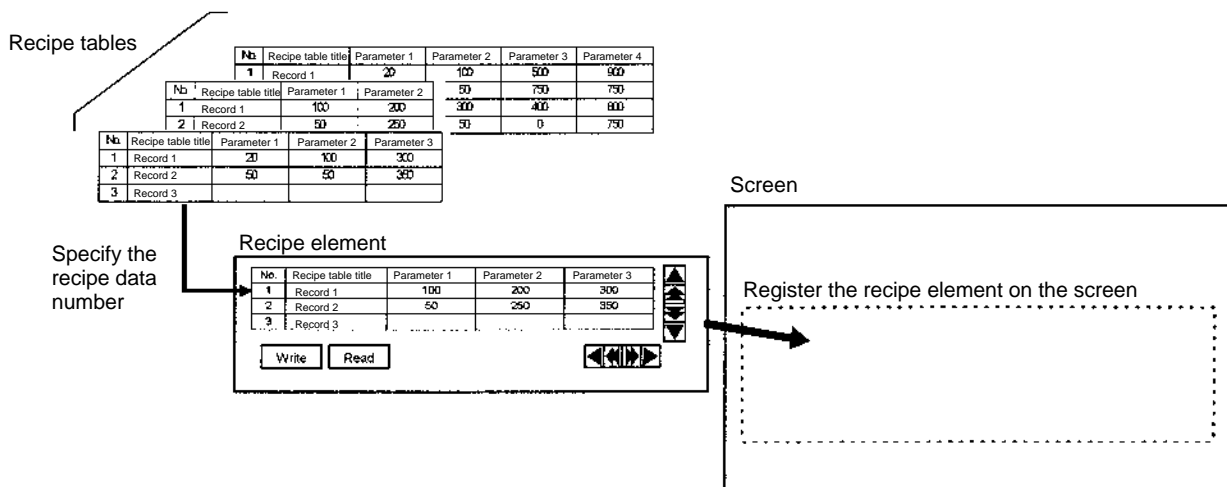

Sending Recipe Tables and Recipe Elements Using the Support Tool

Send recipe tables (i.e., entire sets of recipe data) and recipe elements created as shown above from the Support Tool to the PT in application units (i.e., send all screen data in a single operation).

You can also send recipe elements to the PT in units of screens, and send recipe tables to the PT in recipe table units.

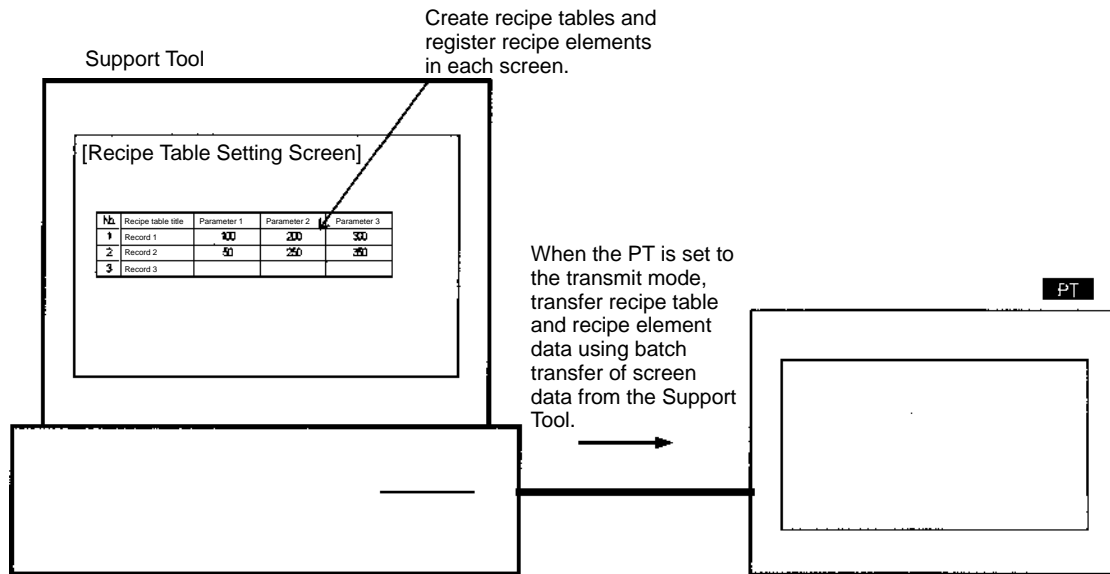

Editing Parameters (Numerical Data) from the PT

- 1, 2, 3...
1. Specify the parameter to be edited by pressing the parameter column. The specified parameter will be displayed in reverse video, and you can set the parameter value.
 2. The pop-up windows specified for each recipe data will be displayed.
 3. If touch switches for inputting and confirming values (control code input function) have already been set on the base screen or to a pop-up window as a ten-key pad, enter the values using the ten-key pad, and then press the Return key to set the target parameter values.

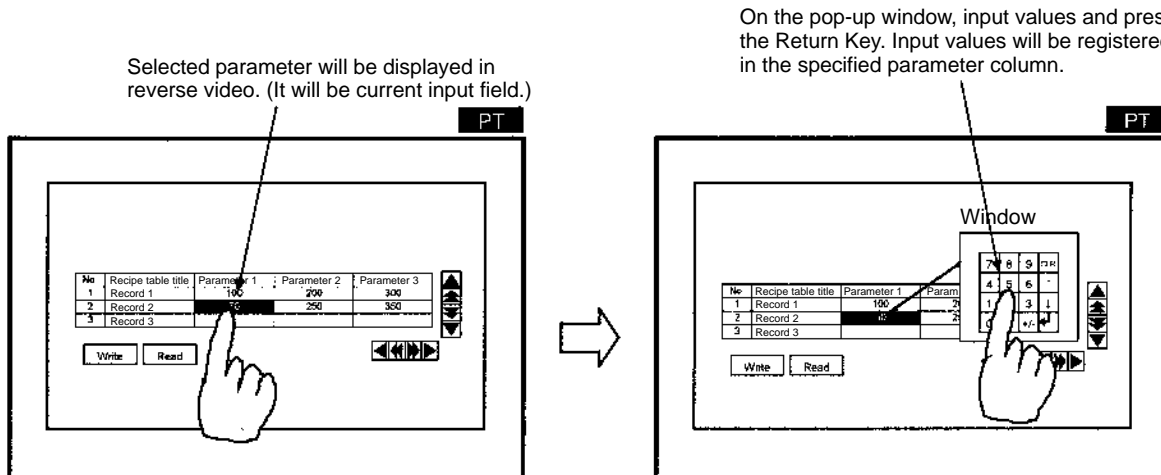

Note Edited recipe data is backed up by the battery, so it remains saved even after the power supply is turned OFF. (The Battery is an option with the NT21.)

Initializing Edited Values from the PT System Menu

You can initialize (i.e., restore the initial values set using the Support Tool) recipe tables (i.e., entire sets of recipe data) edited using the PT or updated by exchanging data with the host using the PT System Menu, as required.

Reading From and Writing to Host

- 1, 2, 3... 1. Select the record name field to specify the record to be read or written. The entire record will be displayed in reverse video.

Once a record is displayed in reverse video, clear the selection by pressing the same record name field again, or by pressing the name field for another record, or by pressing the line scroll touch switches or page scroll touch switches.

2. Press the Write touch switch to write recipe data parameters to the host. Press the Read touch switch to read recipe data parameters from the host.

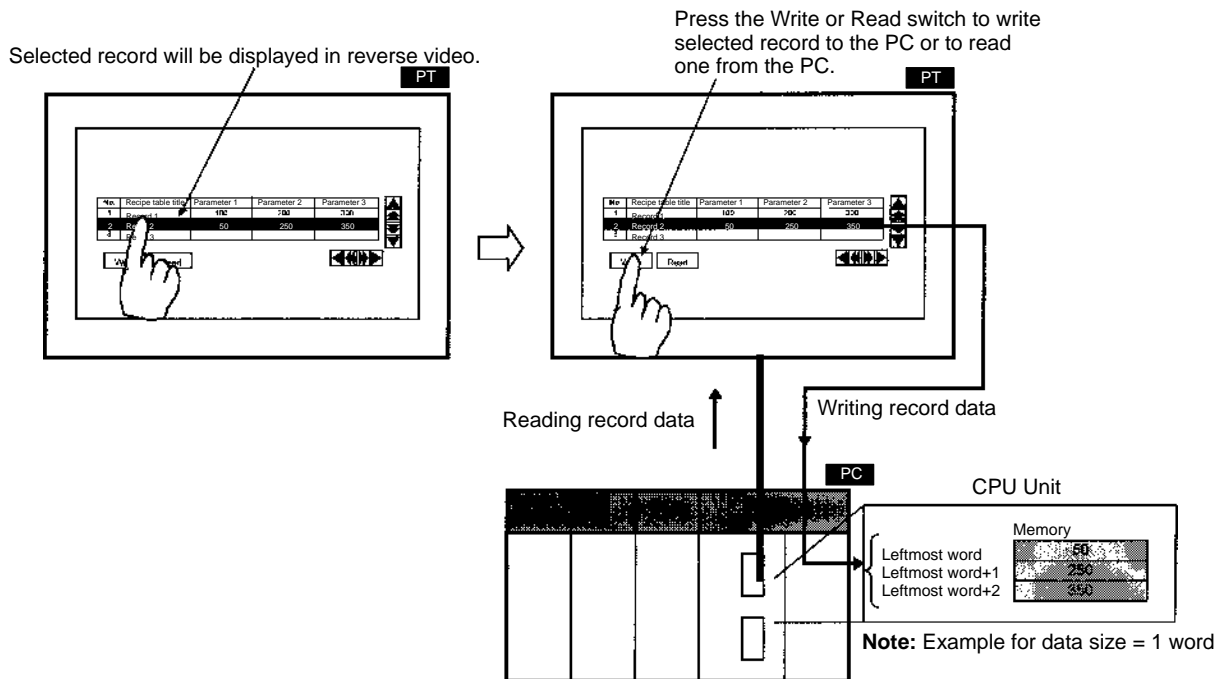

You can also add the following functions.

Enable/Disable Editing On the PT for Each Record Individually

You can enable or disable (i.e., “Lock”) the editing operation on the PT for each record individually using the lock function set with the Support Tool. Use this function when you want to disable editing (i.e., do not want the values changed from the initial values) for a specific record. Set lock function for each record to be locked when creating recipes using the Support Tool.

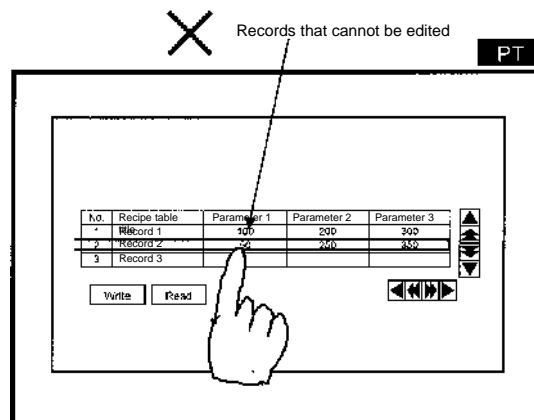

Interlock Function

While a specified host bit (interlock bit) is OFF, you can prohibit all recipe touch switch operations.

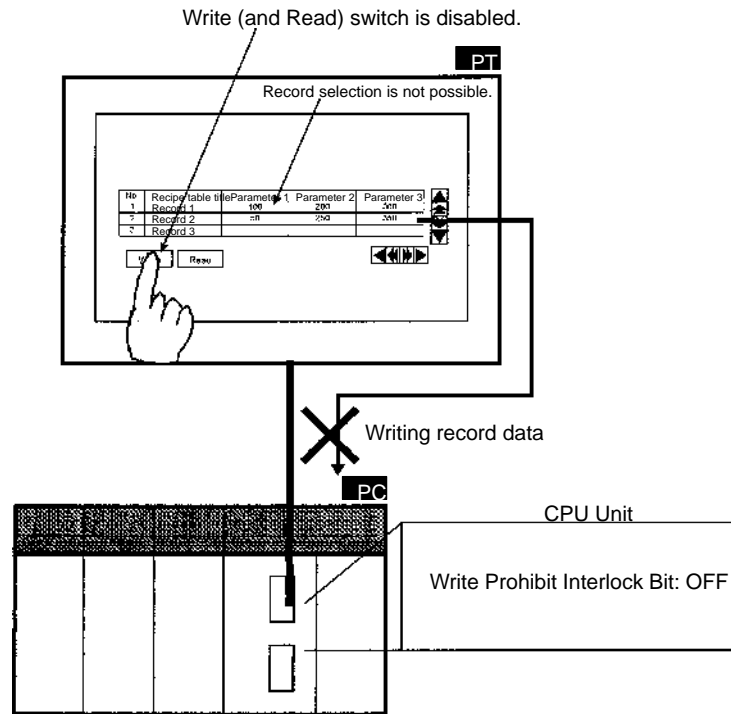

Write Notification Function

You can specify a PC bit (Write Notification Flag) to check that the selected record parameters have been written to the host word specified as the write destination by pressing the Write touch switch. The Write Notification Flag is turned ON after the parameters have finished being written.

When the host is notified, the flag is reset to OFF (i.e., strobe notification). You can specify any area in the host.

Example

This flag can be used as follows:

- Sending data to another area within the host: In the host's ladder program, set the flag as the input condition for a send instruction that sends the data written to the host to another area within the host (e.g., to record data set from the PT).
- Write Completed Check Lamp: You can check that writing operation has been completed by setting the flag as the input condition in the ladder program for turning ON another bit (creating a "Write Completed Flag"), and allocating this bit to the lamp on the PT.

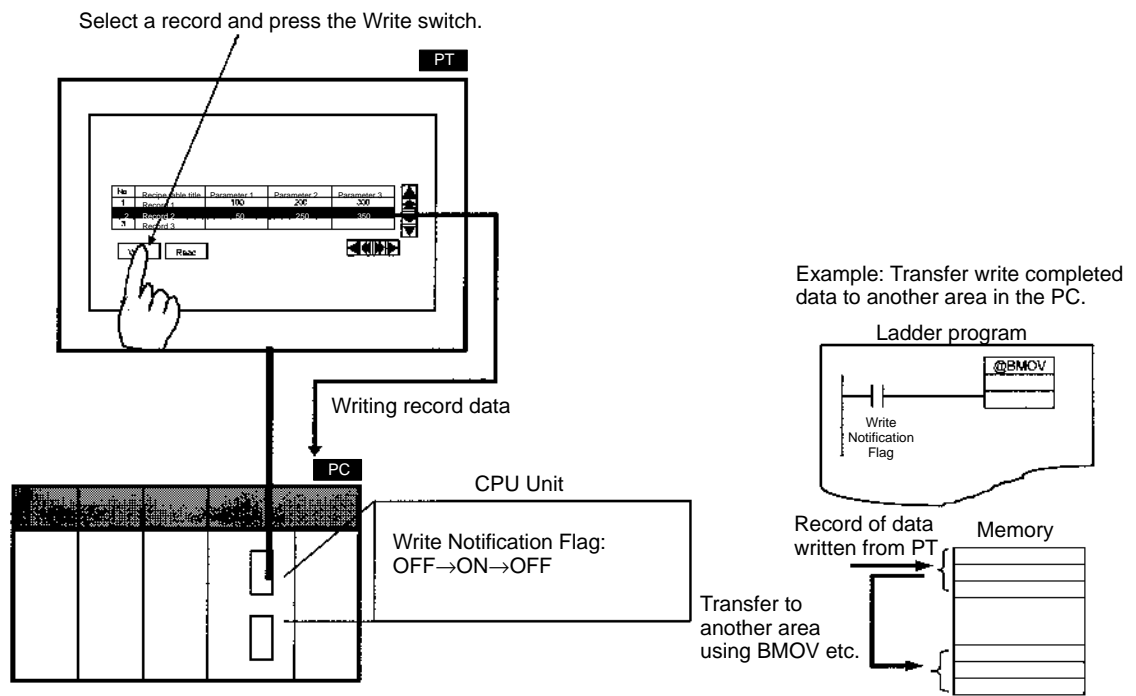

Reference: Recipe tables and recipe elements are stored in flash memory within the PT and memory (recipe data memory) that is backed up by a battery. (The Battery is an option for the NT21.) The way that the data is stored is explained below and illustrated in the diagram following.

- 1, 2, 3...**
1. When downloading from the Support Tool, the downloaded recipe tables and screen data (including recipe elements) are stored in flash memory in the PT. Simultaneously, the data is copied to recipe data memory, which is memory backed up by battery within the PT.
 2. When editing data using the PT, or sending data to the host word, recipe data memory is updated.
 3. When uploading to the Support Tool, the recipe tables in flash memory are updated (i.e., overwritten) using the contents of the recipe data memory.
 4. You can restore recipe data memory to the values held in flash memory at that time using the recipe table initialization procedure in the System Menu on the PT. (If upload operation has not been performed since the data was downloaded from the Support Tool, the values will be restored to the initial value set at the Support Tool.)

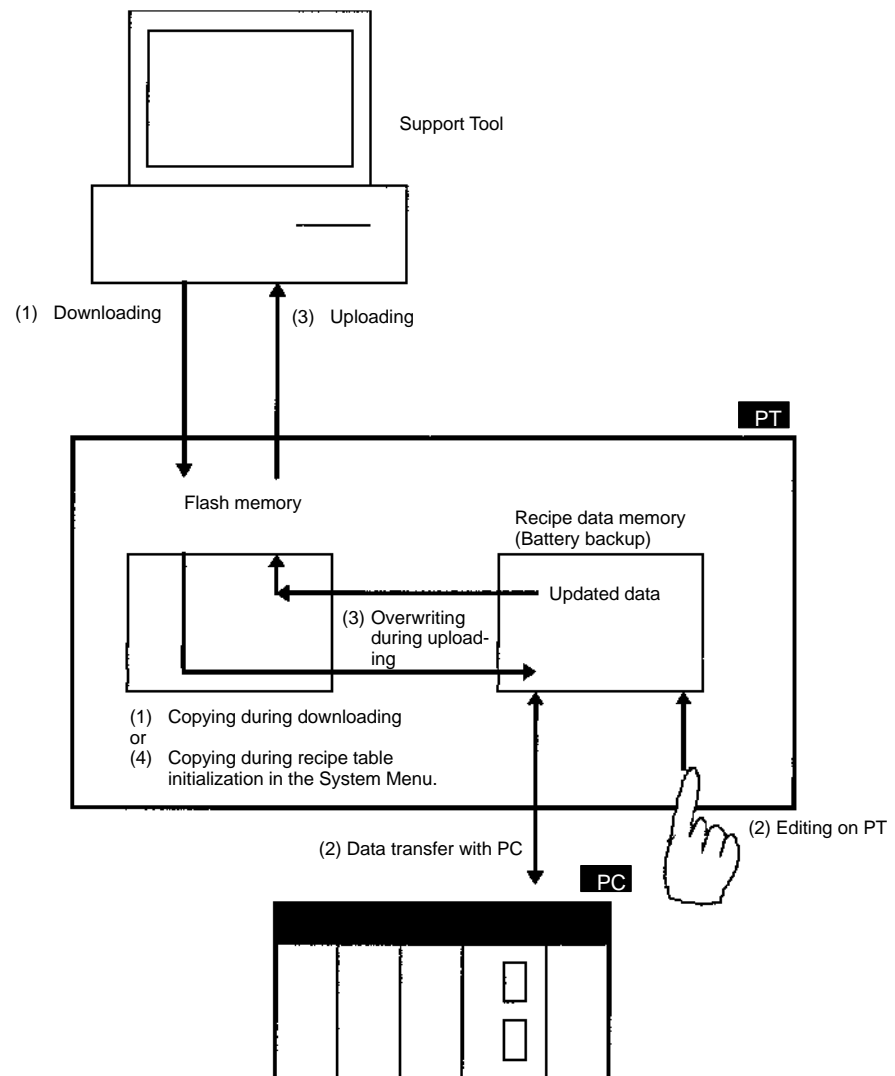

2-14-3 Limits

- You can register a maximum of 1 recipe element per screen. You cannot register recipe elements in window screens. If using 8 overlapping screens, you can register a maximum of 8 recipe elements.
- You can register a maximum of 200 recipes in one screen data file, to a recipe data capacity of 40 Kbytes maximum. You can determine the recipe data capacity using the following formula.

Data capacity = Total parameter size x Number of records x Number of recipe data

You can specify parameter size as 1 word (= 2 bytes) or 2 words (= 4 bytes) for each parameter separately.

- The range of values that can be entered using the Support Tool is fixed at -2,147,483,648 to 2,147,483,647 (regardless of settings such as storage type and display method, which are explained below).

2-14-4 Common Attributes

The recipe table properties and recipe element properties are as follows:

Recipe Table Properties

Specifying Individual Recipe Data (Recipe Settings)

Recipe Entry Number (Number)	Automatically allocated (1 to 200)
Recipe Data Name (Name)	Character string (12 alphanumeric characters)
Comment	Character string (24 alphanumeric characters)
No. of Records	1 to 1000
No. of Parameters	1 to 200
Storage Type (for words on host)	BCD, binary, or system (See note.) Note System: Depends on numeral storage type in the PT configuration setting on the Support Tool.
Host Address Setting	The words on the host for reading and writing recipe data (in record units).
PC Address	You can read and write recipe data (in record units) from/to words of one record (number of parameters × each data length) specified with this address as the start address. Refer to <i>Words Allocated to Records</i> below for details. You can read and write 400 words max., starting from the start word (when there are 200 parameters and all parameters are 2 words long)
I/O Comment	I/O comments express details about words allocated in the host. Character strings 16 characters max.

Specifying Individual Records

Serial Number (No.)	Automatically allocated (1 to 1000)
Record Name (Record)	Character string (12 characters max.)
Lock (Enable or disable editing from PT)	Specify whether editing is enabled or disabled (i.e., read only) for operations on the PT. Selected: Editing disabled; Not selected: Editing enabled

Specifying Individual Parameters

Parameter Name (Parameter)	Character string (8 characters max.)	
Words	Allocated size of host words (1 word or 2 words)	
Dec/Hex	Display format of numerical data (decimal or hexadecimal)	
Sign	Select whether to enable or disable input of negative numbers. (Disabled when display format is set to hexadecimal.) Selected: Enabled; Not selected: Disabled	
Value	Parameters that can be set using the Support Tool -2,147,483,648 to 2,147,483,647	
Width		
	Integers	Number of digits in the integer 1 word: 1 to 5, 2 words: 1 to 10
	Decimals	Number of decimal digits 1 word: 0 to 4, 2 words: 0 to 9
	Total 10 digits max.	

Recipe Element Properties

General properties		
Position	Coordinates of upper left of recipe	
Size of Recipe Data (Size)	Length and height of recipe data display area (Unit: DPI). Display only (editing disabled).	
Show Parameters	Show/Hide	
Show Serial Number	Show/Hide	
Display Line Qty	NT21: 1 to 6 NT31/31C: 1 to 11 NT631/631C: 1 to 23	
No. of Parameters	NT21: 1 to 6 NT31/31C: 1 to 7 NT631/631C: 1 to 15	
Param Column Width	1 to 12	
Record Name Width	1 to 12	
Scale	Scale at which the text is displayed (Enlarged display, page 99). 1 1 (Equal), 1 2 (High), 2 1 (Wide), 2 2, 3 3, 4 4, 8 8	
Smoothing	Whether or not smoothing is used for text with a scale of 2 2 or larger (Smoothing, page 100). Check mark (smoothing executed)/ No check mark (smoothing not executed)	
Specifying color		
Frame Color	Black, blue, red, magenta (violet), green, cyan (aquamarine), yellow, white (Colors except white and black are available only with the NT31C and NT631C.)	
Foreground Color	Record name	Black, blue, red, magenta (violet), green, cyan (aquamarine), yellow, white (Colors except white and black are available only with the NT31C and NT631C.)
	Parameter name	
	Parameter data	
Background Color	Record name	Black, blue, red, magenta (violet), green, cyan (aquamarine), yellow, white (Colors except white and black are available only with the NT31C and NT631C.)
	Parameter name	
	Parameter data	

Setting properties		
Recipe Entry	1 to 200 (recipe data number being referred to) Note Multiple recipe elements can reference recipe data with the same number.	
Show Window/Keyboard Screen	Local window 1/local window 2	
Screen No.	Local 1 (keyboard)	Select to control local window 1 Specify number of window screen to be controlled; 1 to 3,999
	Local 2	Select to control local window 2 Specify number of window screen to be controlled; 1 to 3,999
Screen Position	Local 1 and 2 shared	X-coordinate of bottom left corner of window (Specification must be multiple of 20) NT21: 0 to 240 NT31/31C: 0 to 300 NT631/631C: 0 to 620
		Y-coordinate of bottom left corner of window (Specification must be (multiple of 20)-1) NT21: 19 to 159 NT31/31C: 19 to 239 NT631/631C: 19 to 479
Screen Attributes	Window control details open (fixed)	
Replace Local Window	Specify operation when another window at the specified type (local 1/local 2) is already open. Select to enable switching, and clear to disable switching.	
Write Notification Operation		
PC Bit Address	Specify the PC bit address allocated to the Write Notification Flag.	
I/O Comment	Comment explaining details of allocated bit. Character string of 16 characters max.	
Touch switches		
Read/Write touch switches	Select whether to enable or disable read and write functions.	
Page scroll touch switches	Select whether to enable or disable touch switches to scroll 1 page in the following directions: Up, down, left, and right.	
Line scroll touch switches	Select whether to enable or disable touch switches to scroll 1 line in the following directions: Up, down, left, and right.	
Interlock		
Interlock all recipe touch switch operations	Select whether to enable or disable all recipe touch switch operations (interlock function) Checked: ON; Not checked: OFF	
Host Address Setting		
PC Bit Address	Host bit allocated to control prohibition of all recipe touch switch operations (interlock bit, refer to <i>Bit Allocations</i>)	
I/O Comment	Comments explaining allocated host bit address. Character string of 16 characters max.	

Words Allocated to Records

You can use recipe data to allocate words on the host for all parameters (1 or 2 words × number of parameters) in one record. You can allocate words for recipe data in the following areas on the host (PC).

Symbol	C-series PCs	Allocation	CV-series PCs	Allocation	CS/CJ-series PCs	Allocation
None	IR Area	OK	CIO Area	OK	CIO Area	OK
H	HR Area	OK	---	---	HR Area	Not with Host Link
A	AR Area	OK	Auxiliary Area	No	AR Area	OK

Symbol	C-series PCs	Allocation	CV-series PCs	Allocation	CS/CJ-series PCs	Allocation
L	LR Area	OK	---	---	LR Area*1	Not with Host Link
T	TC Area, Timer PVs	One word only	Timer Area, Timer PVs	One word only	TC Area, Timer PVs	One word only
TU	---	---	---	---	TC Area, Timer Completion Flags	No
C	TC Area, Counter PVs	One word only	Counter Area, Counter PVs	One word only	TC Area, Counter PVs	One word only
CU	---	---	---	---	TC Area, Counter Completion Flags	No
W	---	---	---	---	WR Area	Not with Host Link
TK	---	---	---	---	Task Flags	No
D	DM Area	OK	DM Area	OK	DM Area	OK
E	EM Area *2, current bank	OK	EM Area, current bank	Not with Host Link	EM Area, current bank	Not with Host Link
E0_ to EC_	---	---	---	---	EM Area, EM banks 0 to C	Not with Host Link

*1: LR 00000 to LR 00199 are converted to CIO 01000 to CIO 01199.

*2: The EM Area is supported only by the C200HX/HG/HE(-Z)E PCs.

The Auxiliary Area of the CVM1 and CV-series PCs is allocated to system functions, and cannot be used for purposes other than system use.

The range of each memory area differs according to the PC. Refer to *Appendix D PC Memory Maps* on page 441.

Storage Type (to Words in the Host)

Specify each recipe data format individually when storing data from the recipe data memory in the PT to words in the host, or when reading data from words in the host.

When Storage Type Is BCD

Writing from PT to Host

The binary data in the recipe data memory is converted to BCD data and written to the host. If the number is negative, the most significant digit in the word is written as "F." (Consequently, if the number is negative, the largest possible number of digits (integer digits + decimal digits) is seven.

If the content of the recipe data memory exceeds the range that can be handled by the words allocated in the host, "- (minus sign) + least significant digit" is written to the host (refer to explanation below).

Reading from Host to PT

The contents of the words on the host are taken to be BCD data, and are read to recipe data memory. If the most significant digit is "F," the contents are taken to be negative.

If the contents of the words on the host are not in correct BCD data format (i.e., if the most significant digit is A to E, or if any of the other digits are A to F), the data will not be read, and the PT recipe data memory will retain its previous value.

When Storage Type Is Binary

Writing from PT to Host

The binary data in the recipe data memory is written unconverted to the host.

Reading from Host to PT

The contents of the words on the host are taken to be signed binary data and are read to recipe data memory unconverted.

The most significant bit is taken to be the sign (i.e., when this bit is ON (1), the number is negative).

Writing from PT to Host

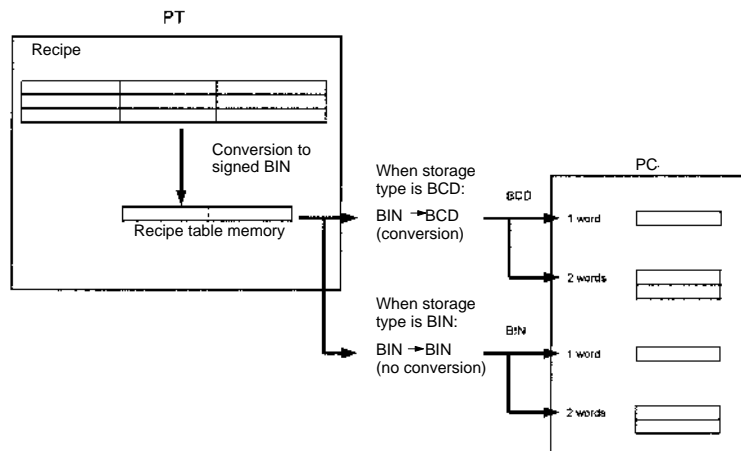

Reading from Host to PT

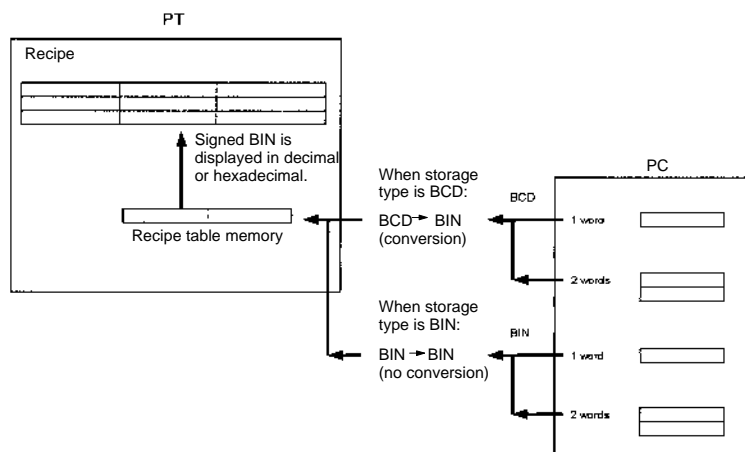

Input Ranges for Parameter Data

When entering values to recipe data memory in the PT by an operation on the PT, the range that can be entered for each parameter depends on the storage type in the host word for each recipe data, the number of words for each parameter, whether the data is in decimal or hexadecimal, and whether or not the data is signed. The ranges are shown in the following table.

PT performs error check and you can not enter values outside the ranges shown in the following table.

Host		PT		
Storage type	Words	Dec/Hex	Sign	Input range permitted
BCD	1 word	Decimal	No	0 to 9999
			Yes	-999 to 9999
		Hex	---	FC19 to FFFF (negative numbers) 0 to 270F (positive numbers)
			2 words	Decimal
	Yes	-99999999 to 99999999		
	Hex	---	FF676981 to FFFFFFFF (negative numbers) 0 to 5F5E0FF (positive numbers)	

Host		PT			
Storage type	Words	Dec/Hex	Sign	Input range permitted	
Binary	1 word	Decimal	No	0 to 32767 (See note)	
			Yes	-32768 to 32767	
	2 words	Hex	---	0 to FFFF	
			Decimal	No	0 to 2147483647 (See note)
				Yes	-2147483648 to 2147483647
Hex	---	0 to FFFFFFFF			

Note The numerical range that can be displayed differs from the permitted input range. When the display is in unsigned decimal, negative numbers are displayed as their absolute value, so values that cannot be entered, such as 32768 and 2147483648, may be displayed.

Examples

Examples of the way parameter data is stored in the host are given in the following table.

PT			→	Host		
Value entered	Dec/Hex	Sign	Value stored in recipe data memory	Number of words	Storage type	Contents of words on host
1234	Decimal	No	000004D2 _H	1	BCD	1234
123			0000007B _H	1		0123
1234			000004D2 _H	2		00001234
1234		Yes	000004D2 _H	1		1234
-123			FF85 _H	1		F123
-1234			FFFFFB2E _H	2		F0001234
000004D2	Hex	---	000004D2 _H	1		1234
FF85			FF85 _H	1		F123
FFFFFB2E			FFFFFB2E _H	2		F0001234
4660	Decimal	No	00001234 _H	1	Binary	1234
268430796			0FF FEDCC _H	2		0FF FEDCC
4660		Yes	00001234 _H	1		1234
-32768			8000 _H	1		8000 (See note)
-268430796			F0001234 _H	2		F0001234
1234			Hex	---		00001234 _H
F123	F123 _H	1				FF123 (See note)
F0001234	F0001234 _H	2				F0001234

Display Ranges for Parameter Data

When displaying the contents of recipe data memory in the PT, the range that can be displayed for each parameter depends on the storage type in the host word for each recipe data, the number of words for each parameter, whether the data is in decimal or hexadecimal, and whether or not the data is signed. The ranges are shown in the following table.

Host		PT		
Storage type	Number of words	Dec/Hex	Sign	Display range
BCD	1	Decimal	No	0 to 9999
			Yes	-999 to 9999
		Hex	---	0 to 270F
	2	Decimal	No	0 to 99999999
			Yes	-99999999 to 99999999
		Hex	---	0 to 5F5E0EF
Binary	1	Decimal	No	0 to 32768 (See note)
			Yes	-32768 to 32767
		Hex	---	0 to FFFF
	2	Decimal	No	0 to 2147483648 (See note)
			Yes	-2147483648 to 2147483647
		Hex	---	0 to FFFFFFFF

Note The range of values that may be displayed differs from the range that can be input. For example, for unsigned data, when the content of recipe data memory is 8000 Hex (-32768), 32768 will be displayed, and when the content of recipe data memory is 80000000 hex (-2147483648), 2147483648 will be displayed. This is because when a negative value is displayed as unsigned data, only the absolute value is displayed. The values 32768 and 2147483648 cannot be entered (as positive values).

Examples

Examples of the way parameter data is displayed on the PT are given in the following table.

Host			→	PT			
Contents of word on host	Storage type	Number of words	Value stored in recipe data memory	Dec/Hex	Sign	Value displayed	
1234	BCD	1	000004D2 _H	Decimal	No	1234	
F123			FFFFFF85 _H			123	
F0001234			FFFFFB2E _H			1234	
1234		1	000004D2 _H		Hex	Yes	1234
F123			FFFFFF85 _H				-123
F0001234			FFFFFB2E _H				-1234
1234		1	000004D2 _H	Hex		---	4D2
F123			FFFFFF85 _H				FF85
F0001234			FFFFFB2E _H				FFFFFFB2E
1234	Binary	1	00001234 _H		Decimal	No	4660
F123			FFFFF123 _H				3805
F0001234			F0001234 _H				268430796
1234		1	00001234 _H	Hex		Yes	4660
F123			FFFFF123 _H				-3805
F0001234			F0001234 _H				-268430796
1234		1	00001234 _H		Hex	---	1234
F123			FFFFF123 _H				F123
FF0001234			F0001234 _H				F0001234

Number of Digits

The contents of recipe data memory in the PT are all stored as integers. To display values that contain decimals, set “Decimal” to 1 or more, and specify the number of digits after the decimal point. Decimal point will be automatically inserted.

If the total number of digits is greater than the sum of all the integers and all the decimals, all digits will be displayed as “*” to denote an error.

An example is given below.

Example: Displaying “123456”

Integer: 8; Decimal: 0

Display reads: 00123456

Integer: 4; Decimal: 4

Display reads: 0012.3456

Integer: 2; Decimal: 4

Display reads: 12.3456

Integer: 1; Decimal: 4

Display reads: *.****

Interlock Function

You can prohibit all recipe touch switch operations depending on the status of allocated bits (interlock bits) in the PC by setting the interlock function in the recipe.

The PT will operate as follows, depending on whether the interlock function is enabled or disabled:

Interlock Function Enabled

The touch switches are enabled only when the interlock bits are ON.

When the interlock bits in the PC are OFF, the following operations are prohibited. At the same time, a buzzer will sound.

- Editing on the PT using the Parameter Editing touch switches.
- Reading/writing words from/to the host using the Read/Write touch switches.
- Scrolling using the scroll touch switches.
- Selecting records using the record selecting touch switches.

Interlock Function Disabled

Recipe touch switch operations are enabled.

- Reference:**
- If the touch switch input sound has been turned OFF using the memory switch settings on the PT, the buzzer will not sound even if a recipe touch switch operation is performed while that operation is prohibited.
 - If recipe data record editing using a touch switch operation on the PT has been disabled (i.e., the Lock is ON), you cannot edit recipe data even if the interlock function is disabled and the touch switch operation is permitted.

Interlock Bit Allocation

You can allocate interlock bits in the following areas in the PC.

Symbol	C-series PCs	Allocation	CV-series PCs	Allocation	CS/CJ-series PCs	Allocation
None	IR Area	OK	CIO Area	OK	CIO Area	OK
H	HR Area	OK	---	---	HR Area	Not with Host Link
A	AR Area	OK	Auxiliary Area	No	AR Area	OK
L	LR Area	OK	---	---	LR Area*1	Not with Host Link
T	TC Area, Timer PVs	No	Timer Area, Timer PVs	No	TC Area, Timer PVs	No

Symbol	C-series PCs	Allocation	CV-series PCs	Allocation	CS/CJ-series PCs	Allocation
TU	---	---	---	---	TC Area, Timer Completion Flags	Not with Host Link
C	TC Area, Counter PVs	No	Counter Area, Counter PVs	No	TC Area, Counter PVs	No
CU	---	---	---	---	TC Area, Counter Completion Flags	Not with Host Link
W	---	---	---	---	WR Area	Not with Host Link
TK	---	---	---	---	Task Flags	Not with Host Link
D	DM Area	OK	DM Area	OK	DM Area	OK
E	EM Area *2, current bank	OK	EM Area, current bank	Not with Host Link	EM Area, current bank	Not with Host Link
E0_ to EC_	---	---	---	---	EM Area, EM banks 0 to C	Not with Host Link

*1: LR 00000 to LR 00199 are converted to CIO 01000 to CIO 01199.

*2: The EM Area is supported only by the C200HX/HG/HE(-Z)E PCs.

Since the Auxiliary Area of the CVM1/CV-series PCs is allocated to system functions, it cannot be used for purposes other than system use.

The range of each memory area differs according to the PC. Refer to *Appendix D PC Memory Maps* on page 441.

When a DM Area or EM Area address is specified, add a bit number (00 to 15) to the end of the word address.

Touch Switch Properties (General)

Touch switch	Function (enable or disable as desired)
Page scroll touch switches	Scroll up and down (to display records) Scroll left and right (to display parameters)
Line scroll touch switches	Scroll up and down (to display records) Scroll left and right (to display parameters)
Read/write touch switches	Read and write

For details of touch switch properties, refer to *2-7 Touch Switches* (page 119).

2-14-5 Display Functions

Values are displayed in recipes according to the General settings.

For details on the method of display depending on the General settings, refer to *Common Attributes* (page 227).

2-14-6 Input Functions

Input by User

Enter values using numerical input and confirmation touch switches (control code input keys) on the base screen or pop-up windows.

Input from Host

Read the contents of the consecutive words specified in the host using the Read touch switch on the PT.

2-14-7 Output Functions

Output to Host

Write the specified record details to consecutive words specified on the host using the Write touch switch on the PT.

2-14-8 Relationship with Other Elements

- When setting parameters from the PT, you must make settings by combined use of numerical input and the confirmation touch switches on the base screen or pop-up window.

If there is a numerical input column in the pop-up window, it is a temporary input column. Once input values are displayed in the temporary input column, press the Return key to store them to the parameters column.

- Record data (parameters) for recipe data can be transmitted to/from words in the host.
Record data (parameters) for recipe data cannot be read/written directly from/to the numeral memory table. Consequently, to display record data set in the PT as graphs or numeral display elements, perform the following operation.

1, 2, 3...

1. Write the record data (parameters) to words on the host.
 2. Specify the recipe data write address to the area allocated in the host for numeral memory table entries.
 3. Refer to the numeral memory table entries in step 2 using graphs or numeral display elements.
- Recipes will be stacked in order of the elements registered on screen using the Support Tool. (Only one recipe can be created in one screen, so the order of recipes may not be changed. You also cannot change the display order between recipes and other elements.)

Reference: Recipe elements differ from numeral display and numeral input elements in the following ways:

- Recipe elements hold recipe data separately from memory table entries within the PT. Recipe data is read and written in record units to and from a consecutive area in the host starting from a specified word.
 - You can read and write data not merely for one word, but for multiple words (200 records maximum, 400 words maximum) in a single operation.
 - You can collate the data from these multiple words as a single record, and set and display up to a maximum of 1,000 recipe data records in table format.
 - The direction of data transfer with the host as either from PT to host, or from host to PT, is selected using the touch switches.
 - The execution and timing of data transfer with the host is controlled by touch switch operation (i.e., using the Write touch switch or Read touch switch). (Unlike numeral display elements, data is not always read from the host).
-

2-15 Window Function

The PT has window function that can display a window overlapping the currently displayed screen (base screen). Windows can be opened without restriction whenever necessary.

Reference: The opening of windows by the operations at PT can be inhibited by a PT status control area operation.

2-15-1 What Are Windows?

A window is a screen that can be displayed overlaying a currently displayed screen (base screen). Its size and display position can be designated without restriction. Windows are mainly used for the applications indicated below.

- An explanatory message can be registered in a window, enabling it to be used as a HELP screen during operation.

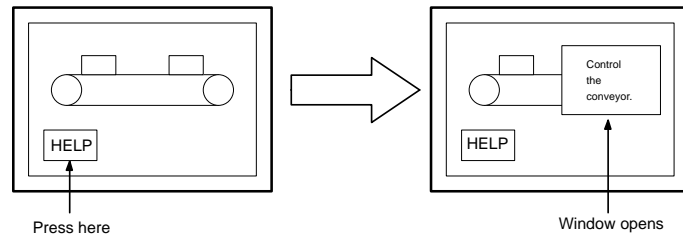

- By registering multiple input key-string (touch switches) for use in numeral/character string setting, the number of usable keys can be increased by switching windows as required, allowing various types of input.

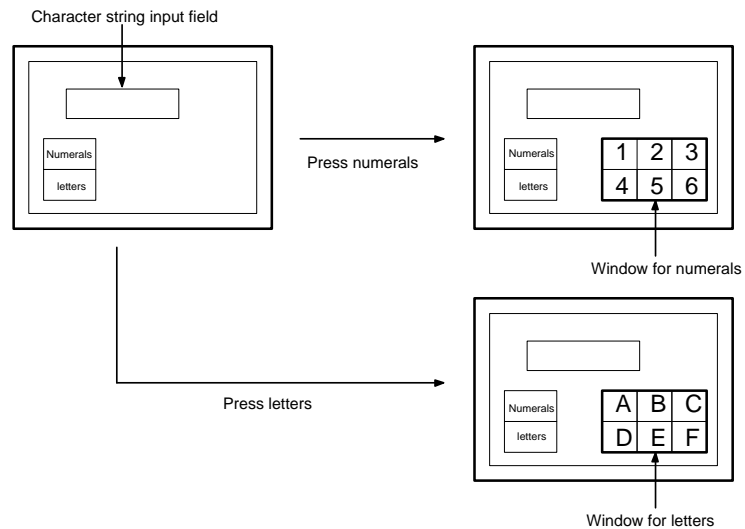

Reference: In order to make numeral/character string settings, a key to confirm the input numeric value or character string is required. Assign the ENT input key-control or Enter () key to a touch switch to create this key.

- By registering multiple screen switching keys (touch switches), menus for screen switching can be created.

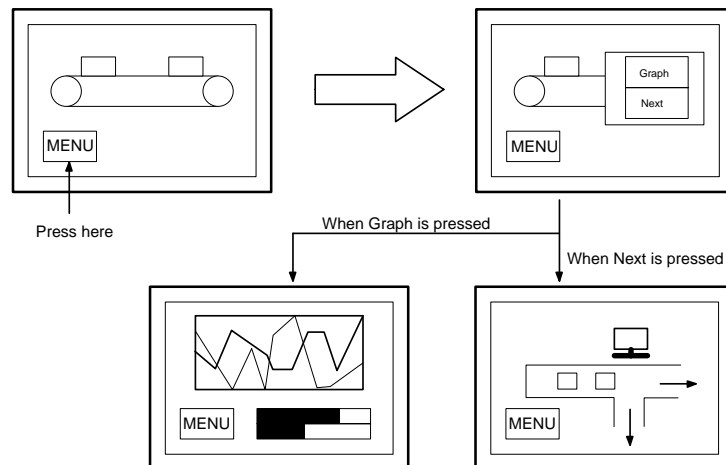

- The window can also be used as a sub screen for displaying a detailed information as required.

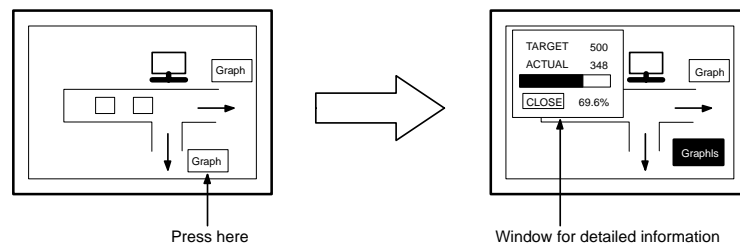

2-15-2 Window Type

The following two types of window are provided.

Global Window

This window can be displayed all the time while the PT is running regardless of the screen currently displayed. However, the global window is not displayed with the following screens.

- System menu
- Error screen
- Screen erase screen (Screen No. 0)
- System initializing screen (Screen No. 9000)
- Programming Console function screen (Screen No. 9020)
- Device Monitor function screens (Screen No. 9021, 9022, and 9023)

Global window stays at the same position even when the screen is switched. (It can be moved also.)

Only one global window can be displayed at the same time.

Global window can be opened, closed or moved only by the operation of window control area from the host. For details of window control area, refer to *Window Control Area* (page 65).

Local Window

This window is closed at the same time the currently displayed screen is switched. By setting the local screen for the screen attribute, the specified screen can be opened at the same time the screen is displayed.

Up to two local windows can be opened at the same time. (Local window 1/Local window2)

Opening, closing or moving a window can be performed by the following operations.

- Setting the screen attribute (A window pops up when the screen is displayed.)
- Touch switch operation (using input key-window/keyboard or window move function touch switch)
- Window control area operation from the host.

It is possible to specify the window type that is used for opening a window, therefore, the same window can be opened as a global window or as a local window. However, it is not possible to display the same window multiply using both window types.

Reference: With PT, up to 3 windows can be opened at the same time. (1 global window and 2 local windows)

2-15-3 Window Screens and Display Elements

Using the window function, window can be created in any of the user screens, numbered 1 to 3999 (a screen for which a window is registered is called a window screen)

When a screen is registered as a window screen, the window area must be specified to set the size of the window. The window is always displayed at the window area size.

In addition, window position can be specified for the screen attribute, touch switch property or window control area when displaying the window. The window position can be moved later by touch switch operation or by a specification at window control area.

With PT windows, all elements other than thumbwheel switch and recipe objects can be registered.

However, only one temporary input field (numeral or string input) can be registered for a window.

By setting the background color screen attribute for a window screen, the window can be displayed with a different background color than that of the base screen.

-
- Reference:**
- Elements that project beyond the window area will not be displayed when the window opens.
 - While a window is open, display processing is slightly delayed.
-

2-15-4 Opening/Closing and Moving a Window

Window can be controlled by the following operations.

Opening windows by setting screen attribute

When creating a screen using the Support Tool, up to two windows can be specified as a pop-up window that is displayed at the same time the screen is opened. By this method, window is displayed at the position that was specified when window screen was created. This kind of window is a local window. For details of the setting, refer to *Screen Attributes* (page 45)

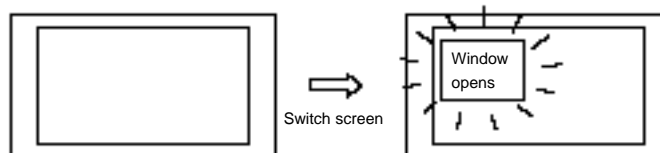

Opening/Closing and moving a window by touch switch operation

To create a pop-up window/keyboard touch switch on a screen or a window enables to open/close specified window. By this method, window is displayed at the position set for touch switch property. This kind of window is a local window.

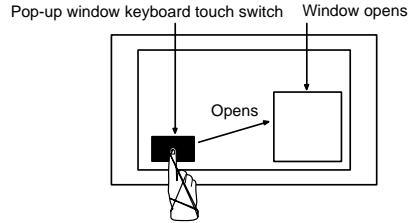

Also, by creating window move touch switch on window, it is possible to move a window by touch panel operation at the PT.

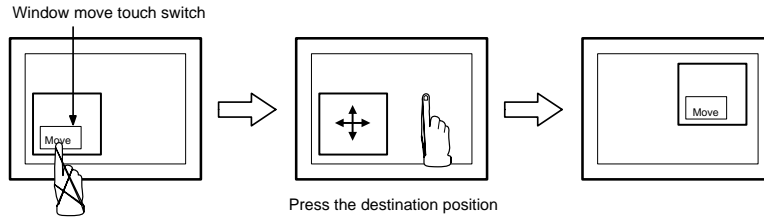

For details of touch switches, refer to 2-7 Touch Switches (page 119). It is not possible to control global window by touch panel operation.

Opening/Closing and moving a window by the operation of window control area

While running the PT, by writing window screen number or X, Y coordinate of window position (bottom left) at window control area from the host, opening/closing, moving window are possible. Window control area can control both global window and local window. For details, refer to 3-4 Display and Control of Windows (page 308).

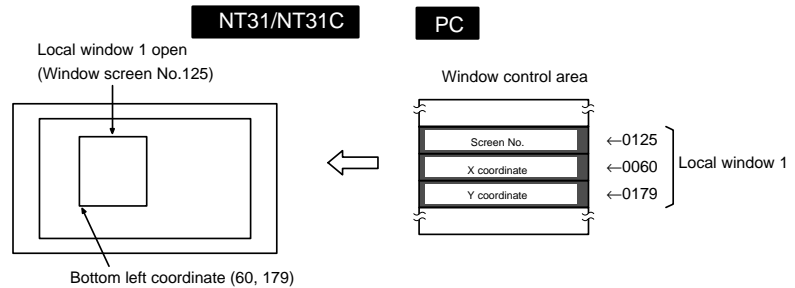

2-15-5 Size and Display Position of a Window

Size of a window can be specified freely by 20 dot unit when creating a window screen. (Minimum window size: 20x20) It is possible to display a window at a different position from where it was created, or to move a window. (Distance of movement has to be multiple of 20 also.)

Example:

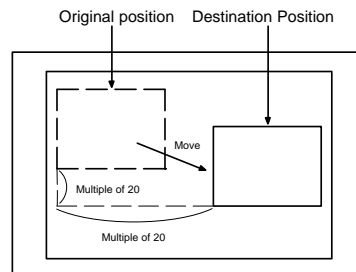

2-15-6 Changing the Displaying Order of Windows

When multiple windows are displayed on a base screen, the part of the windows may overlap with each other. To move a window that is covered by the other window to the front, follow the methods below.

- Changing the displaying order by opening or moving operation of the window
The window that was opened or moved last comes to the front.

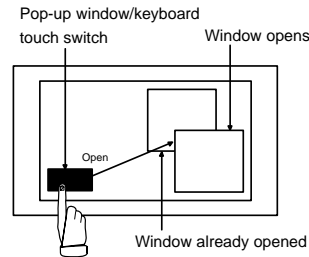

- Changing the displaying order by closing operation of the window
When the window at the front is closed, the window displayed next comes to the front.

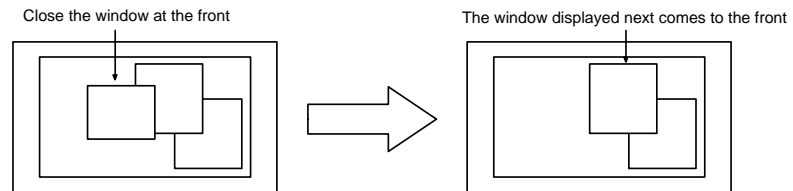

- Changing the displaying order by touch panel operation at the PT
When the window is touched, while it is being displayed, the touched window comes to the front automatically. However, if a touch switch is registered at the touched position, the touch switch function will be performed and the displaying order of windows is not changed.

- When a window other than touch switch position is pressed

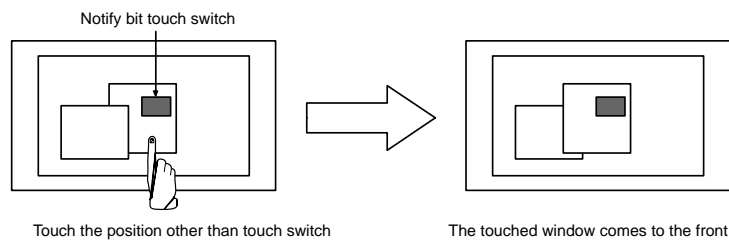

- When a touch switch on a window is pressed

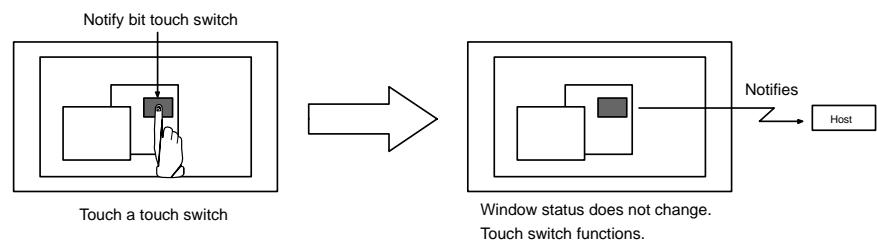

2-15-7 Checking the Display Status of a Window

Whether window is opened or closed is written to window open status at PT status of PT notify area.

Window screen number and window position (bottom left coordinate) of currently displayed screen is written to window control area.

Checking these areas from the host enables to know the display status of window. For details, refer to *3-4 Display and Control of Windows* (page 308).

2-15-8 Temporary Input Fields

Numeral/Character string input field registered on a window is a temporary input field.

(Only one numeral or character string input field can be registered for a window.) This input field can be used - in combination with a number of numeral and character string input fields on base screen - for provisional input before any data is input into the actual input field on the base screen.

The advantage of a temporary input field is that entries can be input into it while checking the current setting on the base screen.

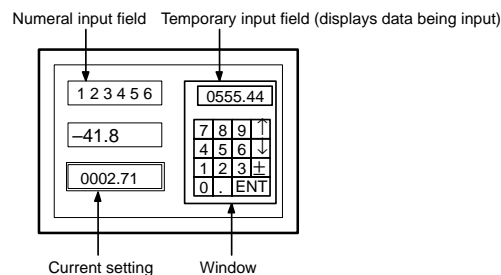

However, if there is not even one numeral setting input field (numeric key type) or character string input field on the base screen, the temporary input field will not be displayed (cannot be used).

If the temporary input field has fewer digits than the actual input field on the base screen (integer part + decimal fraction part + decimal point digit + sign digit), it will be displayed but can not be used.

If it is not possible to use a temporary input field, the data has to be input directly onto the base screen.

2-15-9 Focus Window

Focus window is a screen on which currently activated input field (temporary input field) is registered. (In case there are no active input fields on windows even when multiple windows are displayed, it means that there are no focus windows.)

When the data is input from touch switches or bar code reader, the data is input to a temporary input field on a focus window.

The focus window is determined by the following rules.

- When only one window has an active temporary input field.
The window with an active input field is a focus window.
- When there are multiple temporary input fields that are active.
The one at the front of all the windows that have active input fields is a focus window.

Example:

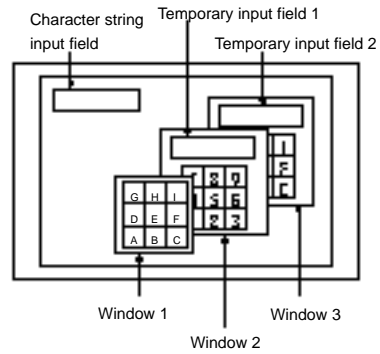

In the example above, window 2 is a focus window. All the input indicated below is performed to a temporary input field on window 2.

- Input from a character string key on base screen
- Input from a character string key on window 1
- Input from a character string key on window 2
- Input from a character string key on window 3
- Input from a bar code reader

Reference: When a window 3 is touched on the position other than touch switch, the display order of the windows is switched and the window 3 will be the focus window.

2-16 Special Functions

Apart from the elements, the PT has the following functions that can be executed at the PT itself.

- Display history function Page 244
- Alarm history function Page 246
- Resume function Page 249
- Screen saver function Page 249
- Buzzer function Page 250
- Clock function Page 251
- Print function (NT31/NT31C and NT631/NT631C only) Page 253
- Adjusting contrast and brightness during PT operation Page 255
- Programming Console function (expansion function) Page 257
- Device Monitor function
(NT31/NT31C and NT631/NT631C only) Page 259
- Mathematical function Page 279

These special functions are described here, except for the Device Monitor and mathematical functions, which are described in the following sections.

2-16-1 Display History Record Function

The display history record function serves to record the order of display and display frequency of screens during operation. The recorded data can be displayed and checked either from the System Menu or during operation.

Procedure for Using the Display History Record Function

The procedure for using the display history record function is as follows:

1, 2, 3...

1. Setting the Screen Attribute

When creating screens with the Support Tool, set the History attribute for screens whose display history is to be recorded. For this setting, a character string (title) can be registered to indicate the contents of the screen. Title is up to 24 characters in length.

Only screens for which the History attribute is set are objects of the display history record function.

2. Initializing the Display History

Before recording can be started, the display history must be initialized from the System Menu of the PT to clear the past records.

3. Recording the Display History

Operate the PT as usual.

When a screen for which the History attribute is set is displayed during operation, the time of display and number of times it has been displayed are recorded.

4. Checking the Display History Record

Display and check the recorded display history record.

There are two methods for doing this: displaying the record from the System Menu, and displaying a screen with the display history record function during operation.

In either case, the records can be presented in occurrence order (order of display) or frequency order (order of frequency of display).

- Reference:**
- The History attribute can only be set for user screens. It cannot be set for system screens and consequently these screens cannot be included in the display history record.
 - When an overlapping screen is displayed, the data for the parent screen is recorded.
 - Bit 11 (display history initialization) of the PT status control bits can also be used to initialize the display history record.

Recording Format for the Display History Record

For the display history record, the following data is recorded in the memory for screens with the History attribute.

- Screen number
- Time of display
- Display history title

Reference: The display history record data is backed up by the battery in the PT and is therefore retained even when the power to the PT is turned OFF or the PT is reset. (The Battery is an option for the NT21.) If the Battery is not being used, the display history record data will be cleared when the power supply to the PT is turned OFF or the PT is reset.

Maximum Number of Records

Occurrence Order

The data of up to 1024 screens can be recorded in the occurrence order display history record. The operation when 1024 records is exceeded depends on the setting made for Screen (Use Ring Buffer) on the PT Configuration – System screen at the Support Tool: select whether the record is to be stopped or the older records are to be deleted.

If no check mark is set for Screen (Use Ring Buffer), recording is stopped, and if a check mark is set, the new data is recorded and the older data is deleted instead.

Frequency Order

The data of up to 255 screens can be recorded in the frequency order display history record. Even if this limit is exceeded, still 255 records remain displayed.

Checking the Record

There are two methods for checking the display history record: checking the record contents in the Maintenance mode of the PT, and displaying a screen with the display history record function during operation.

Displayed Screens

In either case of order of occurrence or order of frequency, the number of records that can be displayed on one screen is 6 with the NT21 PTs, 14 with NT31/NT31C PTs, or 29 with NT631/NT631C PTs. To view those records that are not displayed on the current screen, scroll the screen with the up and down touch switch arrow keys.

If no display history is recorded, the message Display history is not found. is displayed.

Order of Occurrence

The screen records are displayed in the order the screens were displayed. Whether the records are displayed from the oldest first or from the newest first is

determined by memory switch setting at the PT. The following example shows an NT31/NT31C PT:

No.	Screen	Unit	Unit	Comment	1/1
1	1	0501	0441	Start	
2	32	0504	0506	Temp. Setting 1	Quit
3	44	0504	0641	Sector A	
4	32	0504	0641	Temp. Setting 1	↑
5	33	0504	0641	Temp. Setting 2	
6	34	0504	0641	Temp. Setting 3	↓
7	2	0504	0644	Main Monitor	
8	44	0600	0651	Sector A	
10	102	0612	1358	[A] Low Level	
11	2	0612	1403	Main Monitor	Prt.
12	45	0614	0651	Sector B	Prt. Stop

Order of Frequency

The screen records are displayed in the order of frequency of display (number of times displayed) of the corresponding screens. The following example shows an NT31/NT31C PT:

No.	Screen	Unit	Unit	Comment	1/1
1	1	161		Main Menu	
2	32	33		Temp. Setting 1	Quit
3	44	24		Sector A	

Checking the Record in the Maintenance Mode

Select the Maintenance mode from the System Menu and display the history record.

For details on the System Menu operation, refer to section 6 of the *Setup Manual*.

Checking the Record During Operation

The display history record can be checked during operation by displaying either of the following screens.

Screen No. 9001: Occurrence history screen

Screen No. 9002: Frequency history screen

Reference: Screen numbers 9001 and 9002 are reserved for displaying the display history record. They cannot be used for other applications.

2-16-2 Alarm History Record Function

The alarm history record function continually monitors the status of host bits set in advance, and records the times at which the statuses of these bits change to 1 (ON). The setting for monitoring the bits can be made at the bit memory table. The recorded data can be displayed and checked even during operation, from the System Menu.

Procedure for Using the Alarm History Record Function

The procedure for using the alarm history function is as follows:

1, 2, 3... 1. Setting the Bit Memory Table

At the Support Tool, allocate host bits to a bit memory table entry and set History as the function of the bit memory table entry. At this time, it is pos-

sible to specify character string memory table entries that contain messages indicating the contents of alarms.

Only bits for which the History attribute is set are objects of the alarm history record function. Bits for which History is set are continually monitored during operation of the PT regardless of the screen being displayed.

2. Initializing the Alarm History

Before recording can be started, the alarm history must be initialized from the System Menu of the PT to clear the past records.

3. Recording the Alarm History

Operate the PT as usual.

When the status of a bit for which History is set changes to 1 during operation, the time of this event and the number of times the bit has come ON are recorded.

4. Checking the Alarm History Record

Display and check the recorded alarm history record.

There are two methods for doing this: displaying the record from the System Menu, and displaying a screen for which an alarm history element is registered during operation.

In either case, the records can be presented in occurrence order (order of display) or frequency order (order of frequency of display).

Recording Format for the Alarm History Record

For the alarm history record, the following data is recorded in the memory for bit memory table entry for which the status of the allocated bits changes to 1 (ON).

- Message (contents of a character string memory table entry set for the bit memory table entry)
- Time of display

Reference:

- The alarm history record data is backed up by the battery in the PT and is therefore retained even when the power to the PT is turned OFF or the PT is reset. (The Battery is an option for the NT21.) If the Battery is not being used, the alarm history record data will be cleared when the power supply to the PT is turned OFF or the PT is reset.
- Bit 1 (alarm history initialization) of the PT status control bits can also be used to initialize the alarm history.

Maximum Number of Records

- Occurrence order

The data of up to 256 bit memory table entries (bits) can be recorded in the occurrence order alarm history record. The operation when 256 records is exceeded depends on the setting made for Alarm (Use Ring Buffer) on the PT Configuration – System screen at the Support Tool: select whether the record is to be stopped or the older records are to be deleted.

If no check mark is set for Alarm (Use Ring Buffer), recording is stopped, and if a check mark is set, the old records are progressively deleted.

- Frequency order

The data of up to 255 screens/bit memory table entries can be recorded in the frequency order alarm history record. Even if this limit is exceeded, still 255 records remain displayed.

Checking the Record

There are two methods for checking the alarm history record: checking the record contents in the Maintenance mode of the PT, and displaying a screen for which an alarm history element is registered during operation.

The display for the alarm history record function differs depending on whether it was called from the Maintenance mode or during operation.

Displayed Data

The data displayed with the alarm history record function are described below.

Occurrence Order

The records are displayed in the order in which the status of the set bit memory table entries (bits) changed to 1 (ON). Whether the records are displayed from the oldest first or from the newest first is set with the memory switches at the PT.

Frequency Order

The records are displayed in the order of the number of times the statuses of the bit memory table entries have changed to 1 (ON).

Checking the Record in the Maintenance Mode

Select the Maintenance mode from the System Menu and display the alarm history record.

For details on the System Menu operation, refer to section 6 of the *Setup Manual*.

When the record is checked in the Maintenance mode, screens like those shown below are displayed. (The following examples show NT31/NT31C PTs.)

Occurrence Order Screen

No.	Err.	Time	Comment
1	0524	0841	Conveyor Stopped
2	0524	0806	Temp. Low Level
3	0524	0841	Process 2 Stopped
4	0524	0841	Process 1 Stopped
5	0524	0849	Conveyor Stopped
6	0524	1521	Conveyor Stopped
7	0525	0844	P/S Low Voltage
8	0527	1732	Conveyor Stopped
9	0527	1125	Temp. Low Level
10	0630	2109	Process 1 Stopped
11	0684	1833	Process 1 Stopped
12	0684	2106	Conveyor Stopped
13	0684	2152	Conveyor Stopped

Frequency Order Screen

No.	Err.	Comment
1	125	Conveyor Stopped
2	186	Temp. Low Level
3	49	Temp. High Level
4	16	P/S Low Voltage
5	15	Process 3 Stopped
6	13	Water Tank Overheating
7	11	Process 2 Stopped
8	6	Process 1 Stopped
9	4	Pin 1
10	2	Pin 2
11	1	Setting Error

Checking the Record During Operation

The alarm history can be checked during operation by displaying a screen for which an alarm history element has been registered.

In this case, the alarm history element is displayed in the manner shown below. However, note that the width and height of the alarm history element, and the method of display for the time, can be changed by setting properties. For details, refer to *2-11 Alarm List, Alarm History* (page 182).

Occurrence Order Screen

Abnormal remote I/O	06/06	16:02	▲
Abnormal high function unit	06/07	09:21	▲
Cycle time over	06/17	15:44	
			▼
			▼

Occurrence of transmission abnormality

Check the remote I/O transmission line!

Frequency Order Screen

Cycle time over	114	▲	Cycle time exceeds 100 msec!
Abnormal high function unit	53	▲	
Abnormal remote I/O	39		
		▼	
		▼	

The following countermeasure should be taken: Program is checked again. Setting of cycle time over not detected (DM6655:X1XX)

2-16-3 Resume Function

The PT has a function to protect the contents of memory table entries that have been changed during operation (by the numeral/character string setting function, or by an instruction from the host) and retain them even when the power to the PT is OFF or the PT is reset, so that operation can be restarted in the same status the next time the PT is started. This function is called the resume function.

When the resume function is **not set**, the contents of the memory table entries are initialized to the defaults (initial values) set with the Support Tool when PT operation has been stopped by turning OFF the power, resetting the PT, or stopping operation from the System Menu.

When the resume function is **set**, the contents of the memory table entries are not initialized when PT operation has been stopped by turning OFF the power, resetting the PT, or stopping operation from the System Menu. This means that the next time that operation is restarted, the data previously contained in the memory table entries will be written to the host automatically so the same data can be displayed again at the host after an interruption.

The resume function will retain data in numeral memory table entries 0 to 999 and character string memory table entries 0 to 499. All other memory table entries will be initialized, whether the resume function is set or not.

However, when a word is allocated for a memory table entry in the host and the memory table entry is set not to be initialized, the contents of the word at the host will be written to the memory table entry instead of the other way round, therefore the previous contents of the memory table entry will be lost.

Even if the resume function is set, if memory table initialization is executed, the memory table contents will be initialized to the defaults set with the Support Tool. Whether the resume function is used or not is set with the memory switches of the PT. For details, refer to section 6 of the *Setup Manual*.

Reference: When the voltage of the battery becomes too low, the memory table contents cannot be retained even if ON is set for the resume function. The Battery is an option for the NT21, and the resume function will be disabled if a Battery is not being used, regardless of the actually setting of the function.

2-16-4 Screen Saver Function

The PT has a function to maximize the service life of the backlight and to prevent the formation of an afterimage by turning off the screen display and the backlight if no operation is performed for a certain period of time.

If the same data is displayed for a long time (about 24 hours), an afterimage will form on the screen. To prevent this, either use the screen saver function or periodically switch the screen.

The screen saver function only operates when the PT is in operation. It does not operate during System Menu operation or while the PT is in system installer mode.

There are the following two types of screen saver function.

- Screen saver that turns off the screen and the backlight
- Screen saver that displays the contents of character string memory table entry 0 for a set length of time each at random positions on the screen (with the NT31C and NT631C, the color is also changed randomly). With this screen saver, the backlight is not turned off.

- Note**
1. Do not press touch switches carelessly while the backlight is off or while nothing is displayed on the screen.
Confirm system safety before pressing touch switches.
 2. After images may remain if the same pattern is displayed for a long period (approx. 24 hours).
To prevent the formation of an afterimage, either use the screen saver function or periodically switch screens.

Reference: It is also possible to start the screen saver function using bit 15 (screen display) of the PT status control bits.

Redisplaying a Cleared Screen

When a screen has been cleared due to activation of the screen saver function, this screen can be redisplayed by pressing a PT touch switch, or by a screen switching instruction from the host (if the backlight is off, it is also turned back on). The screen will not be redisplayed when display contents such as numeric values or character strings are changed.

Setting the Screen Saver Function

Whether or not the screen saver function is used and, if it is used, the waiting time for execution, is set with the memory switches of the PT.

For details on the setting method, refer to section 6 of the *Setup Manual*.

2-16-5 Buzzer Function

The PT buzzer can be sounded to inform of emergencies and PT errors.

- Reference:**
- Whether or not the buzzer actually sounds depends on the memory switch settings made at the PT. The following three buzzer settings can be made with the memory switches.
 - OFF: The buzzer never sounds.
 - ERR ON: The buzzer only sounds when a PT error occurs.
 - ON: The buzzer sounds in response to instructions from the host and screen attributes.

For details, refer to section 6 of the *Setup Manual*.

- The buzzer will also sound to indicate that a window, numeral input, or character string input has been disabled by the interlock function or a control bit in the PT status control area. These sounds are controlled as touch switch sounds and not buzzer sounds.
-

Types of Buzzer

The following three types of buzzer can be sounded by the PT.

Continuous Buzzer

Buzzer that sounds continuously

Short Intermittent Buzzer

Buzzer that repeatedly alternates between sounding and stopped states of 0.5 seconds duration each.

Long Intermittent Buzzer

Buzzer that repeatedly alternates between sounding and stopped states of 1.0 seconds duration each.

If more than one buzzer type has been set with the PT status control bits, the order of priority below is followed (highest priority at the top).

- 1, 2, 3... 1. Continuous buzzer
2. Short intermittent buzzer
3. Long intermittent buzzer

For example, if the continuous buzzer and short intermittent buzzer are specified together, the continuous buzzer sounds.

Sounding the Buzzer

Except the case the buzzer is set not to sound at all, the buzzer automatically sounds when an error occurs at the PT. Apart from this, there are the following two methods for sounding the buzzer.

Sounding the Buzzer by Control from the Host

The buzzer can be sounded from the host by operating the PT status control area during operation (page 290).

A Method to Use the buzzer Screen Attribute

By setting a Buzzer screen attribute when creating screen data with the Support Tool, the buzzer can be sounded when the created screen is displayed (page 290).

Stopping the Buzzer

When the buzzer is sounding, it can be stopped in the following ways.

- By operating the PT status control area from the host (page 292).
However, when this method is used, the buzzer will not be stopped unless the bits for all three buzzer types — continuous, short intermittent, and long intermittent — are set to 0 (OFF).
- By displaying a screen for which no buzzer attribute is set (page 291).
- By pressing a touch key assigned the buzzer stop function (page 293).

By creating a touch switch assigned the buzzer stop attribute (the [⏏]) input key – control) on a screen for which a buzzer attribute is set, the buzzer can be stopped by pressing this switch.

2-16-6 Clock Function

The PT has a clock function for setting and displaying the date and time. With the NT31/NT31C and NT631/NT631C, the clock function is backed up by the built-in battery of the PT.

The NT21's clock function is not a counter. This function just uses the most recent clock data read from the host. (The clock data is not backed up even if the optional Battery is installed.) Refer to *2-2-4 Clock Data Area (Host to PT, NT21 Only)* for details on the clock data area.

- Reference:**
- When the battery voltage becomes low with the NT31/NT31C or NT631/NT631C, the time data will not be retained by turning OFF the power to the PT, or resetting the PT, consequently the clock function will not operate correctly.
 - The NT31/NT31C and NT631/NT631C do not allow display and setting of clock data with the clock function from the Support Tool. To set the time, use System Menu or numeral memory table operations.
 - With the NT21, only reads the clock data from the host. The time data cannot be set from the Support Tool or from the System Menu.
 - The calendar and time data are not set correctly on shipment from the factory.

Numeral Memory Table Entries Used with the Clock Function

The PT uses numeral memory table entries 247 to 255 for clock data.

As shown in the table below, numbers 247 to 253 are for display and reading only, and numbers 254 and 255 are for time setting. (For the NT21, entry numbers 254 and 255 are reserved by the system.)

With the NT31/NT31C and NT631/NT631C, numbers 247 through 253 store clock data, which is updated by the internal clock of the PT. This data cannot be rewritten by the host.

With the NT21, the clock data is periodically read from the words allocated in the host and the data is stored at table entry numbers 247 to 253.

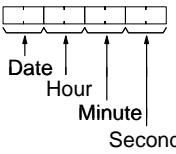
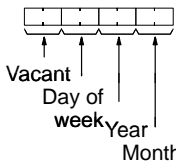
Function	Numeral memory table entry	Digit position	Information	Value	Remarks	
Display/reading only	247		Second	00 to 59		
	248		Minute	00 to 59		
	249		Hour	00 to 23	24-hour system	
	250		Date	01 to 31		
	251		Month	01 to 12		
	252		Year	00 to 99	Last 2 digits of the year	
	253		Day of week	00 to 06	See below.	
Setting only (NT31/NT31C and NT631/NT631C only) (Reserved with the NT21)	254			Second	00 to 59	
				Minute	00 to 59	
				Hour	00 to 23	24-hour system
				Date	01 to 31	
	255			Month	01 to 12	
				Year	00 to 99	Last 2 digits of the year
				Day of week	00 to 06	
				Vacant	00	

The numeric values that correspond to the days of the week are as follows:

Day of week	Sun	Mon	Tue	Wed	Thu	Fri	Sat
Value	00	01	02	03	04	05	06

Setting example for the NT31/NT31C and NT631/NT631C:
September 28 (Fri), 2001, 14:53:30

254 2,8,1,4,5,3,3,0
255 0,0,0,5,0,1,0,9

Reference: Numeral memory table entries 247 to 255 are provided for clock data use and host words cannot be allocated for them.

Setting Clock Data

The following two methods can be used to set clock data for the NT31/NT31C and NT631/NT631C. (With the NT21, the clock data is read from the host and cannot be set at the PT.)

Setting from the System Menu

Display the menu for displaying and setting clock data from the System Menu and make the settings. For details, refer to section 6 of the *Setup Manual*.

Rewriting Numeral Memory Table Entries 254 and 255

Numeral memory table entries 254 and 255 for clock data setting are rewritten using the memory table copy function to set the clock data (it is not possible to rewrite numeral memory table entries 254 and 255 from the host). For details, refer to 3-10 *Display and Setting of Calendar Clock* (page 355).

2-16-7 Print Function (NT31/NT31C or NT631/NT631C Only)

The following data can be printed out by connecting a printer to the PT.

- The currently displayed screen (hard copy)
- Display history/alarm history record data

Settings for Printing

In order to print out data at a printer connected to the NT31/NT31C or NT631/NT631C, the type of printer used and the printing method must be set with the memory switches of the PT. (A printer cannot be connected to the NT21.)

Type of Printer:

The following printer types can be used: printers that emulate NEC PC-PR201H, and printers that comply with the ESC/P 24-J83C (color) or ESC/P 24-J82 (monochrome) standard, or printers that comply PCL 5.

Printing Method:

When a color printer is used, color printing can be performed without additional settings. When using a monochrome printer, printing in which colors are expressed as 8 grayscale levels (tones) is possible. However, the NT31 and NT631 are not capable of color printing or tone printing.

For details on the method for setting memory switches, refer to *Setting the Printer Controller and Setting the Print Method* in section 6 of the *Setup Manual*.

Printing a Screen Image

The following two methods are available for printing out a hard copy of the currently displayed screen.

Using a Touch Switch with the Screen Print Function

When creating the screen to be printed out, register a touch switch with the screen print touch switch for it.

When this screen is displayed during operation, pressing the touch switch will cause a hard copy of the screen to be printed out.

For details, refer to *2-7 Touch Switches* (page 119).

-
- Reference:**
- The PT continues operation during printing.
 - If a touch switch with the function for stopping printing has been registered for the screen, printing can be stopped by pressing this touch switch.
 - The Device Monitor screens have a screen print touch switch.
-

Method Using the PT Status Control Bits

When the status of the screen printing bit (bit 7) of the PT status control bits is set to 1 (ON), a hard copy of the screen displayed at that time is printed out.

For details, refer to *2-2-1 PT Status Control Area (Host to PT)* (page 52).

-
- Reference:**
- The PT continues operation during printing.
 - Before setting the status of the screen printing bit to 1 (ON), confirm that the status of printer operating status bit (bit 7) of the PT status notify bits is 0 (OFF).
 - When printing is executed using the PT status control bits, it is not possible to stop printing part way through.
-

Printing Example



Printing Display History and Alarm History Record Data

The display history and alarm history recorded in the PT can be printed out by calling the display history and alarm history display screens from the System Menu.

To print when the PT is running, display a display history dedicated screen, or a screen for which an alarm history is registered, then print it using the screen print function.

Switch between screens by pressing a touch switch assigned the screen switching function, or by writing the screen number to the screen switch setting word in the PT status control area. To print a screen, either press a touch switch assigned the screen print function or set the screen printing bit in the PT status control bits to ON. (Turning ON the screen print bit produces a hard copy of the screen.)

The display history dedicated screens are:

- Occurrence history screen: 9001
- Frequency history screen: 9002

Printing Example

These examples show screens printed when called from the System Menu.

Display History

Occurrence order

No.	Scrn	YY/MM/DD	HH:MM	Comment	1/1
1	1	98/02/23	08:45	menu screen	
2	4	98/02/23	08:46	alarm screen	
3	3	98/02/23	08:47	setting screen	
4	4	98/02/23	08:47	alarm screen	
5	1	98/02/23	08:48	menu screen	
6	4	98/02/23	08:50	alarm screen	
7	3	98/02/23	08:51	setting screen	
8	1	98/02/23	08:55	menu screen	
9	4	98/02/23	09:06	alarm screen	
10	1	98/02/23	09:07	menu screen	
11	3	98/02/23	09:07	setting screen	
12	4	98/02/23	10:50	alarm screen	
13	1	98/02/23	10:51	menu screen	
14	3	98/02/23	10:52	setting screen	

Frequency order

No.	Scrn	Cnt.	Comment	1/1
1	1	14	menu screen	
2	4	10	alarm screen	
3	3	8	setting screen	

Alarm History

Occurrence order

No.	Comment	YY/MM/DD	HH:MM	1/1
1	WATER TANK OVERHEATING	98/02/22	13:05	
2	PROCESS 3 STOPPED	98/02/22	13:06	
3	PROCESS 3 STOPPED	98/02/22	13:08	
4	SUPPLY MATERIAL A	98/02/22	13:09	
5	WATER TANK OVERHEATING	98/02/22	13:10	
6	WATER TANK TEMP. TOO LOW	98/02/22	13:12	
7	WATER TANK OVERHEATING	98/02/22	13:15	
8	PROCESS 5 EMERGENCY STOP	98/02/22	13:20	
9	TEMP. OUT OF SETTING RANGE	98/02/22	13:21	
10	SUPPLY LABEL PAPER	98/02/22	15:42	
11	SUPPLY MATERIAL A	98/02/22	15:42	
12	TEMP. OUT OF SETTING RANGE	98/02/22	15:45	
13	WATER TANK TEMP. TOO LOW	98/02/22	15:49	
14	SUPPLY MATERIAL A	98/02/22	15:52	
15	TEMP. OUT OF SETTING RANGE	98/02/22	15:57	

Frequency order

No.	Comment	Cnt.	1/1
1	WATER TANK OVERHEATING	15	
2	WATER TANK TEMP. TOO LOW	14	
3	PROCESS 3 STOPPED	10	
4	TEMP. OUT OF SETTING RANGE	8	
5	SUPPLY MATERIAL A	7	
6	PROCESS 5 EMERGENCY STOP	7	
7	SUPPLY LABEL PAPER	6	
8	SUPPLY MATERIAL B	5	
9	PROCESS 2 STOPPED	1	
10	PROCESS 1 STOPPED	1	

2-16-8 Adjusting Contrast and Brightness During PT Operation

With the NT31/31C and NT631/631C, in addition to using the System Menu (Maintenance Mode → I/O Setting), you can also adjust the backlight brightness and contrast while the PT is in operation.

While the PT is in operation, display screen number 9030, the brightness and contrast adjustment screen, by specifying the screen in the PT status control area, or by using a touch switch with a screen switching function. After displaying the screen, make the desired settings.

Displaying the Brightness and Contrast Adjustment Screen

The brightness and contrast adjustment screen can be displayed using either of the following two methods.

Using a Touch Switch

The brightness and contrast adjustment screen can be displayed using a touch switch with a screen switching function as shown below.

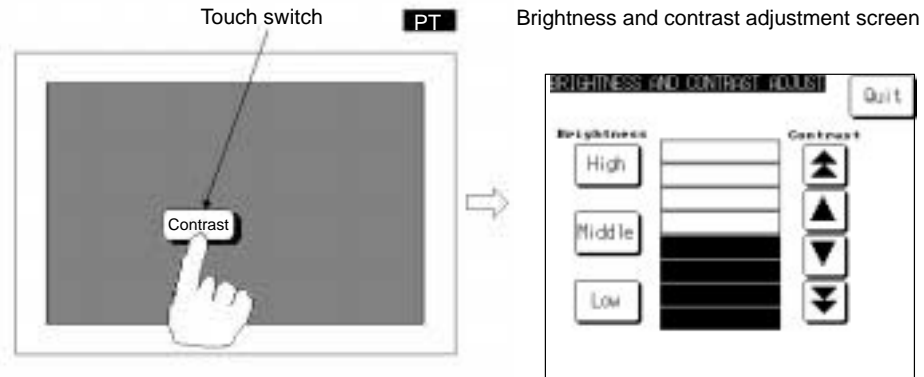

Using the PT Status Control Area

The brightness and contrast adjustment screen can be displayed by specifying 9030 as the display screen in the PT status control area as shown below.

Brightness Adjustment

You can set the backlight brightness to one of three steps using the High, Middle, or Low touch switches. The backlight brightness can be adjusted while checking the actual screen.

At normal operating temperature, the backlight service life varies with the backlight brightness setting as follows:

- High: 10,000 hours
- Middle or Low: 25,000 hours

Contrast Adjustment

You can set the contrast to one of 100 steps. Make the desired setting using the following four buttons:

- Increase 10 steps:
- Increase 1 step:
- Decrease 10 steps:
- Decrease 1 step:

You can adjust the contrast while checking the actual screen.

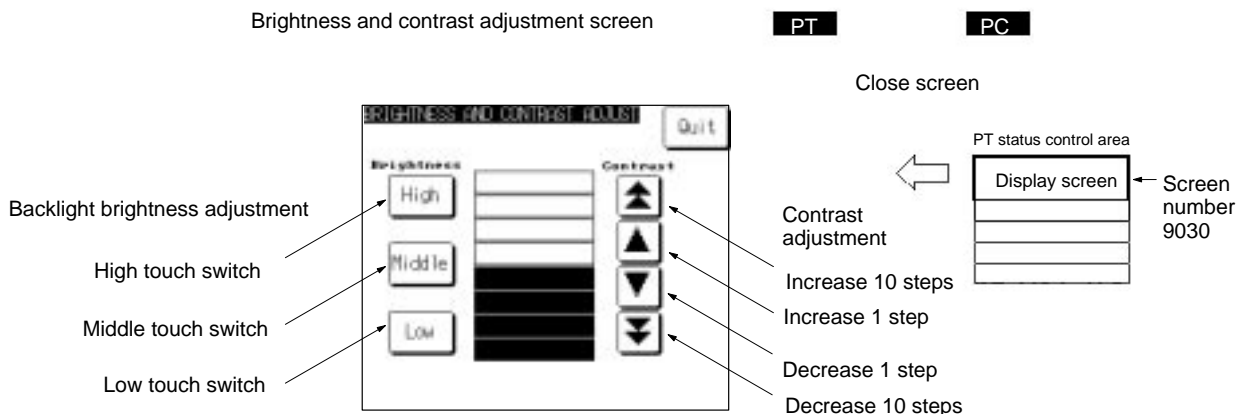

2-16-9 Programming Console Function

As an expansion function, the NT21, NT31/NT31C, and NT631/NT631C feature the Programming Console function, which allows to be used in place of a C200H-PRO27-E Programming Console.

The following table shows the combinations of communications methods and PCs that can support the PT's Programming Console function.

Communications method	PC model	Communications port
1:1 NT Link	C200HE-CPU42(-Z)E*1 C200HG-CPU43(-Z)E*1 C200HG-CPU63(-Z)E*1 C200HX-CPU44(-Z)E*1 C200HX-CPU64(-Z)E*1 C200HX-CPU65-ZE*1 C200HX-CPU85-ZE*1 CPM2A-30CD□□-□*1 CPM2A-40CD□□-□*1 CPM2A-60CD□□-□*1 CPM2C-10□□□□□□-□*2 CPM2C-20□□□□□□-□*2 CQM1-CPU4□-EV1*1 CQM1H-CPU21*1 CQM1H-CPU51*1 CQM1H-CPU61*1 SRM1-C02-V2	CPU Unit's built-in RS-232C port
	CPM1-10CDR-□ CPM1-20CDR-□ CPM1-30CDR-□ CPM1A-10CD□-□ CPM1A-20CD□-□ CPM1A-30CD□-□ CPM1A-40CD□-□	Peripheral port*3
1:N NT Link	CS1G-CPU42-E(V1) CS1G-CPU43-E(V1) CS1G-CPU44-E(V1) CS1G-CPU45-E(V1) CS1H-CPU63-E(V1) CS1H-CPU64-E(V1) CS1H-CPU65-E(V1) CS1H-CPU66-E(V1) CS1H-CPU67-E(V1) CS1G-CPU42H CS1G-CPU43H CS1G-CPU44H CS1G-CPU45H CS1H-CPU63H CS1H-CPU64H CS1H-CPU65H CS1H-CPU66H CS1H-CPU67H CJ1G-CPU44 CJ1G-CPU45 CJ1G-CPU42H CJ1G-CPU43H CJ1G-CPU44H CJ1G-CPU45H CJ1H-CPU65H CJ1H-CPU66H	CPU Unit's built-in RS-232C port Peripheral port*4

*1: A Programming Console connected to the peripheral port always takes priority. When a Programming Console is connected later, the PT's Programming Console function will become ineffective and operations from the PT will be disabled. Also, the PT cannot be connected through a Serial Communications Board's RS-232C port.

*2: It is possible to connect to the RS-232C port by connecting a CPM2C-CN111 Conversion Cable, which splits the PC's communications connector into a peripheral port and RS-232C port.

*3: An RS-232C cable cannot be connected directly to the peripheral port. A CPM1-CIF01 RS-232C Adapter is required.

*4: An RS-232C cable cannot be connected directly to the peripheral port. A CS1W-CN118 RS-232C Adapter is required.

Reference: The Programming Console function is **not supported** by the following CPUs:

CPM1: □□□5 and □□☆6 (☆: 1 to 9, X, or Y)

CQM1: □□□3, □□□4, □□□5, and □□☆6 (☆: 1 to 9, X, or Y)

C200HX/HG/HE: □□□5 and □□☆6 (☆: 1 to 9, or X)

Most of Programming Console functions are possible, with the exception of recording (storing) ladder programs on cassette tape and replaying (reading) them.

For details on the system configuration for using the Programming Console function, the method for connection to a PC, and how to use the Programming Console function, refer to *Programming Console Function* in section 6 of the *Setup Manual*.

Programming Console function can be used by switching to screen number 9020 even when the PC is in running mode. (Switching to screen number 9020 is not possible by operations in the PT Status Control Area.) The PT will stop operating at the same time the Programming Console function is applied. (RUN indicator goes OFF)

Pressing a Quit touch switch on the Programming Console function screen returns to a screen displayed just before the Programming Console function was called.

Reference: The PT automatically distinguishes the model of PC that is connected and automatically displays the Programming Console function screen that conforms to the PC.

2-17 Device Monitor Function

The NT31/NT31C and NT631/631C PTs have been equipped with the Device Monitor function, which can be used to read/change words in the PC's data areas and display the PC's error log. (Device monitoring is not supported by the NT21.)

 **Caution** Be sure that it is safe to proceed before using the Device Monitor function to perform one of the following operations from the PT.

- Changing monitored data
- Switching the PC's operating mode
- Force setting or force resetting bits
- Changing PVs or SVs

Reference:

- The Device Monitor function can be used with Version 3.0 and higher versions of the PT system program only.
- The Device Monitor functions are almost identical to the functions of the Data Access Console (DAC) that can be used with the NT620S and NT620C.
- The Device Monitor function cannot be used with host link or memory link communications.

2-17-1 Compatible Systems

The following table shows the combinations of communications methods and PCs that can support the PT's Device Monitor function.

Communications method	PC model	
1:1 NT Link	C200HS-CPU21-E	CPM1-20CDR-□*1
	C200HS-CPU23-E	CPM1-30CDR-□*1
	C200HS-CPU31-E	CPM1A-10CD□-□*1
	C200HS-CPU33-E	CPM1A-20CD□-□*1
	C200HE-CPU32(-Z)E	CPM1A-30CD□-□*1
	C200HE-CPU42(-Z)E	CPM1A-40CD□-□*1
	C200HG-CPU33(-Z)E	CPM2A-30CD□□-□
	C200HG-CPU43(-Z)E	CPM2A-40CD□□-□
	C200HG-CPU53(-Z)E	CPM2A-60CD□□-□
	C200HG-CPU63(-Z)E	CPM2C-10□□□□□□-□*2
	C200HX-CPU34(-Z)E	CPM2C-20□□□□□□-□*2
	C200HX-CPU44(-Z)E	CQM1-CPU4□-EV1
	C200HX-CPU54(-Z)E	CQM1H-CPU21
	C200HX-CPU64(-Z)E	CQM1H-CPU51
	C200HX-CPU65-ZE	CQM1H-CPU61
	C200HX-CPU85-ZE	SRM1-C02-V2
	1:N NT Link	C200HE-CPU32(-Z)E
C200HE-CPU42(-Z)E		CS1H-CPU65-E(V1)
C200HG-CPU33(-Z)E		CS1H-CPU66-E(V1)
C200HG-CPU43(-Z)E		CS1H-CPU67-E(V1)
C200HG-CPU53(-Z)E		CS1G-CPU42H
C200HG-CPU63(-Z)E		CS1G-CPU43H
C200HX-CPU34(-Z)E		CS1G-CPU44H
C200HX-CPU44(-Z)E		CS1G-CPU45H
C200HX-CPU54(-Z)E		CS1H-CPU63H
C200HX-CPU64(-Z)E		CS1H-CPU64H
C200HX-CPU65-ZE		CS1H-CPU65H
C200HX-CPU85-ZE		CS1H-CPU66H
CQM1H-CPU21		CS1H-CPU67H
CQM1H-CPU51		CJ1G-CPU44
CQM1H-CPU61		CJ1G-CPU45
SRM1-C02-V2		CJ1G-CPU42H
CS1G-CPU42-E(V1)		CJ1G-CPU43H
CS1G-CPU43-E(V1)		CJ1G-CPU44H
CS1G-CPU44-E(V1)		CJ1G-CPU45H
CS1G-CPU45-E(V1)		CJ1H-CPU65H
CS1H-CPU63-E(V1)	CJ1H-CPU66H	

*1: A CPM1-CIF01 RS-232C Adapter is required.

*2: Use a Conversion Cable (CPM2C-CN111 or CS1W-CN114/118), CPM1-CIF01 RS-232C Adapter, or CPM1-CIF11 RS-422A Adapter to connect to the PC.

2-17-2 Device Monitor Screens and Functions

Screen Configuration

The Device Monitor function has 3 screens: the registration monitor screen, continuous monitor screen, and error log screen. The following examples show the screens from an NT631/NT631C.

Registration monitor screen
(Screen number 9021)



Continuous monitor screen
(Screen number 9022)

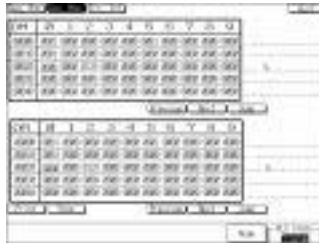

Error log screen
(Screen number 9023)



Screen Functions

Operations Common to All 3 Screens

- Displaying/Changing the PC Operating Mode (page 263)
- Printing the Current Screen (page 263)
- Switching the Device Monitor Screen (page 264)
- Exiting Device Monitor (page 263)
- About the Message Display Bar (page 264)
- About the Error Screen Display (page 264)

Registration Monitor Screen

- Monitor Specified Words (page 264)
- Specifying/Changing the Word and Clearing the Display (page 266)
- Changing Hexadecimal PVs and Forcing Timer/Counter Status (page 267)
- Changing Binary PVs and Forcing Bit Status (page 269)
- Clearing All Force-set/Force-reset Bits (page 270)

Continuous Monitor Screen

- Monitoring a Range of Words (page 271)
- Specifying/Changing the Word and Clearing the Display (page 273)

Error Log Screen

- Displaying the PC's Error Log (page 275)
- Clearing PC Errors (page 275)

2-17-3 Starting and Exiting Device Monitor

Starting Device Monitor

The Device Monitor function can be called in the following two ways.

- Call from the System Menu.
- Call with a screen display while the PT is operating.

Calling from the System Menu

- 1, 2, 3... 1. Select Expansion Mode → Device Monitor function from the System Menu. The Device Monitor Menu will be displayed. (The following example shows the menu of an NT631/NT631C.)



2. Select the desired Device Monitor screen. The selected screen will be displayed.

Reference: For details on displaying and using the System Menu, refer to *System Menu Operations* in section 6 of the *Setup Manual*.

Calling from a Screen Display during Operation

When calling the Device Monitor function during PT operation, one of the following 3 screens can be displayed with a PT status control area operation or the screen switching function of a touch switch, bit memory table entry, or alarm list/history function.

Registration monitor screen:	Screen number 9021
Continuous monitor screen:	Screen number 9022
Error Log screen:	Screen number 9023

Refer to the description of each screen switching function for more details on switching screens.

Differences in the PT Operating Status

The PT's operating status is different depending on the method used to start the Device Monitor function.

- Device Monitor Called from the System Menu

The PT will remain stopped, so the following functions will not operate:

- Controlling the PT through the PT status control area
- Notifying the PT through the PT status notify area
- Controlling windows through the window control area
- Monitoring bit memory table entries (screen switching and alarm functions)
- Executing calculations with the mathematical table
- Trend graph background and data logging functions

- Device Monitor Called by Screen Number

The PT will continue operating, but the following function will not operate:

- Controlling windows through the window control area (Notifications from the PT cannot be performed either.)

Reference: When a Device Monitor screen was displayed while the PT is operating and the PT was then switched to another screen (other than system screens), the PT will skip the Device Monitor screen when you attempt to return to the previous screen by pressing the return to previous screen touch switch.

Exiting Device Monitor

To exit the Device Monitor function, press the Exit touch switch that is displayed in the upper right corner of all of the Device Monitor screens. If the Device Monitor function was called from the System Menu, the PT will return to the Device Monitor Menu; if the Device Monitor function was called during operation, the PT will return to the screen that was displayed before it was called.

Also, when the Device Monitor function was called during operation by its screen number, you can exit the Device Monitor and switch to a different screen by writing the other screen's screen number in the PT status control area.

2-17-4 Operations Common to the Device Monitor Screens

This section describes the operations that can be performed in all 3 Device Monitor screens.

Displaying/Changing the PC Operating Mode

The operating mode of the PC that is connected to the PT is displayed in the bottom-right corner of the Device Monitor screens.

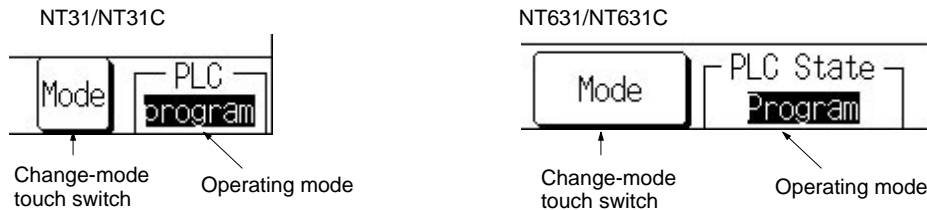

Use the following procedure to change the PC's operating mode.

- 1, 2, 3... 1. Press the change-mode touch switch. A popup menu will be displayed like the one shown below. (This example shows an NT631/NT631C.)

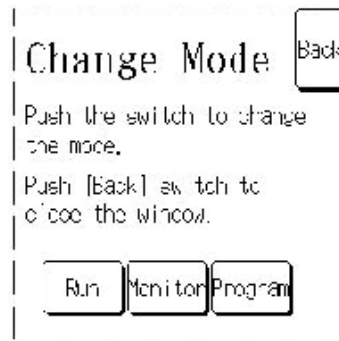

2. Press the touch switch of the desired operating mode. The PC's operating mode will be switched to the specified mode and the operating mode displayed in the bottom-right corner will also change.
(To cancel the change-mode operation without changing the mode, press the Back touch switch in the upper-right corner of the popup menu before pressing one of the operating mode touch switches.)
3. Press the Back touch switch to close the popup window.

Print the Current Screen

A hard copy of the current Device Monitor screen can be printed at the printer connected to the PT.

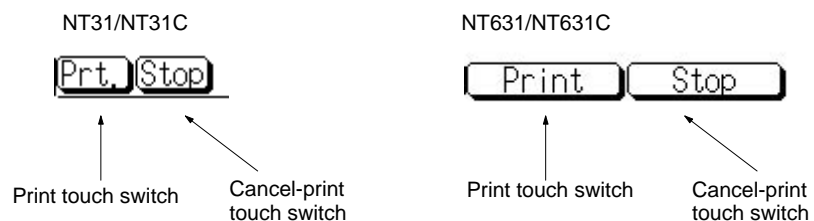

Press the print touch switch to print a copy of the current Device Monitor screen. The screen print can be cancelled by pressing the cancel-print touch switch.

-
- Reference:**
- The Device Monitor function will continue operating while the screen is being printed.
 - If the Device Monitor function was called by switching screens during operation, the printer operating status flag (bit 7 of the PT status notification area) will be ON while the screen is printing.
-

Switch Device Monitor Screen

Touch switches are provided to switch from one Device Monitor screen to another.



All of the Device Monitor screens have 3 touch switches in the upper-left corner of the screen that correspond to the 3 Device Monitor screens. The current Device Monitor screen is displayed in reverse-video.

To switch to another Device Monitor screen, just press the corresponding touch switch.

About the Message Display Bar

There is a message display bar at the bottom-left of the Device Monitor screens. Messages are displayed in this area to assist in operations or indicate errors.

About the Error Screen Display

When the Device Monitor function is being used, an error screen will be displayed if an error occurs that will affect execution of the Device Monitor function (such as a communications error). Press the error screen's OK touch switch to restart the Device Monitor function.

If the Device Monitor function was called by switching screens during operation, the PT will revert to the screen that was displayed when the Device Monitor function was called.

Refer to *6-2 Responding to Displayed Error Messages* for details on error screens and correcting the indicated errors.

2-17-5 Using the Registration Monitor Screen

The registration monitor screen can be used to display the PVs of a specified words and change word PVs. It is also possible to force-set, force-reset, and clear the forced status of bits and timer/counter Completion Flags.

-
- Reference:**
- When the PC is in RUN mode, it is not possible to change word PVs or force-set, force-reset, or clear the forced status of bits (including timer/counter Completion Flags.)
 - A word or bit address that has been specified will remain valid until the PT is turned OFF or reset. The settings will remain valid even if the Device Monitor function is closed, so the last valid settings will be displayed the next time that the Device Monitor function is started.
-

NT31/NT31C Screen

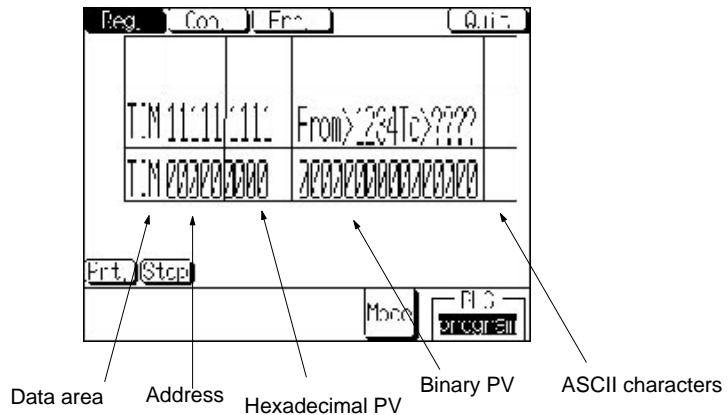

With the NT31/NT31C, the PVs of up to 3 words can be displayed simultaneously.

NT631/NT631C Screen

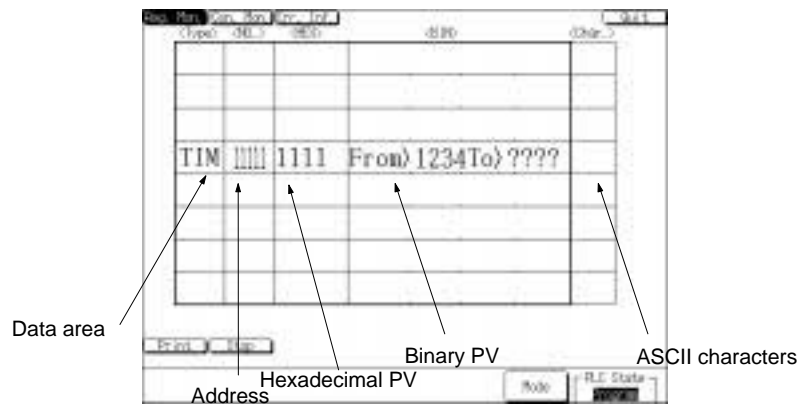

With the NT631/NT631C, the PVs of up to 8 words can be displayed simultaneously.

Data Area and Address

These columns display the word address (data area acronym and address) of the words being monitored. The table cells containing the word address act as touch switches; press either cell to change or clear the word being displayed in that row.

Hexadecimal PV

This column displays the PVs of the specified words in hexadecimal. The table cells in this column also act as touch switches; press the desired cell to change that word's PV in hexadecimal. With timers and counters, the cells can be used to set/reset the timer or counter.

When a timer or counter is being displayed, a will appear next to the hexadecimal PV when the timer/counter times out or counts out.

Binary PV

This column displays the PVs of the specified words in binary with bit 15 on the left and bit 00 on the right. Force-set and force-reset status are also indicated. When the word's PV is changed in hexadecimal, that change is also reflected in this column.

The table cells in this column also act as touch switches; press the desired cell to change that word's PV in binary or force-set, force-reset, or clear the forced status of bits in the word.

ASCII Characters

This column displays each PV as 2 extended ASCII characters. Spaces will be displayed if there aren't ASCII characters equivalent to the PV.

Specifying/Changing the Word and Clearing the Display

Words Displayable in the Registration Monitor Screen

The following table shows which words can be monitored in the registration monitor screen.

Data area	Name	CS/CJ	C200HX/HG/HE (-Z)	C200HS, CPM1, CPM2A, CPM2C, CQM1, or SRM1	CQM1H
DM	Data Memory Area	OK	OK	OK	OK
IR/CIO	Internal Relay or Core I/O Area	OK	OK	OK	OK
TIM	Timer Area	OK	OK	OK	OK
CNT	Counter Area	OK	OK	OK	OK
HR	HR (Holding Relay) Area	OK	OK	OK	OK
AR	AR (Auxiliary Relay) Area	OK	OK	OK	OK
LR	LR (Link Relay) Area	---	OK	OK	OK
WR	Work Area	OK	---	---	---
EM	EM Area (current bank)	Installed EM banks	Installed EM banks	---	Installed EM banks
EM0 to EMF	EM Area (bank 0 to bank F)	Installed EM banks	Installed EM banks	---	Installed EM banks

OK: Can be displayed No: Not applicable Not with Host Link: Installed EM banks can be displayed

The CS/CJ-series PC's Task Flags (TK) and clock pulses (P) cannot be displayed.

Procedures

Use the following procedure to specify the word to monitor, change the word's PV, or clear a word from the display.

- 1, 2, 3... 1. Press the data area or address cell in the desired row. The following popup window will be displayed to input the word address. (This example shows the NT631/631C.)

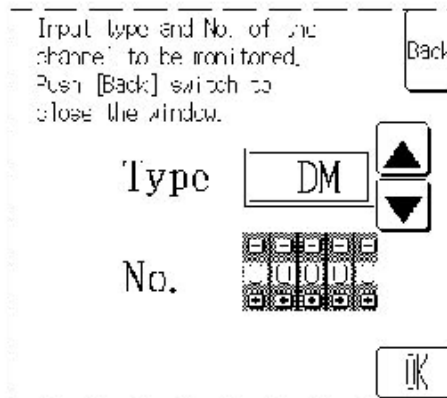

If you specify a row in which a word is already displayed, that word's data area and address will be displayed in the popup window.

- Reference:**
- Monitoring will stop in a row while the popup window is being displayed to input a new word address for that row. Monitoring will continue in the other rows and any changes in those words will appear on the screen.
 - No other operations can be performed while the popup window is being displayed on the screen. (The PT can be controlled from the PC if the PT is operating.)

- Press the Up and Down Arrow Keys (▲ and ▼) to select the desired data area. The following table shows the order in which the data areas appear when the Down Arrow Key is pressed. (The data areas appear in the opposite order when the Up Arrow Key is pressed.)

PC model	Data area order
CS/CJ, C200HX/HG/HE (-Z)	DM → IR/CIO → TIM → CNT → HR → AR → WR → EM* → EM0* → ... → EMF* → clear → (repeat from DM)
C200HS, CPM1, CPM2A, CPM2C, CQM1, SRM1	DM → IR → TIM → CNT → HR → AR → LR → clear → (repeat from DM)
CQM1H	DM → IR → TIM → CNT → HR → AR → LR → EM* → EM0* → clear → (repeat from DM)

* The number of EM banks depends upon the PC being used. The PT will display only those EM banks available in the connected PC.

Select clear for the data area to clear all of the cells in the row.

- Specify the address by pressing the Increment and Decrement Keys (+ and -) on the word address's thumbwheel switch. (This step isn't necessary if you are clearing the row.)

The digit will be incremented or decremented by 1 each time that you press the Increment or Decrement Key.

- Press the Write touch switch. The PT will begin monitoring the specified word in the row and the popup input window will be closed. (The row will be cleared if clear was selected for the data area.)

If the specified word address is not valid, an error message will be displayed in the lower-left corner of the screen and the buzzer will sound. (This buzzer sound can be disabled with the PT's touch switch sound setting.) In this case, check the valid range of the data area in the connected PC and enter the word address again. The error message will be cleared when a valid word address is entered.

If the Back touch switch is pressed before the Write touch switch, the input will be cancelled and the PT will return to monitoring the original word address in that row.

Changing Hexadecimal PVs and Forcing Timer/Counter Status

Use the following procedure to change a monitored word's PV in hexadecimal. This procedure can also be used to force-set, force-reset, or clear the forced status of timer/counter Completion Flags.

Reference: If the timer or counter Completion Flag is force-set, it will be in time-out or count-up status regardless of the PV. Likewise if the timer or counter Completion Flag is force-reset, it will be OFF even if the PV is 0.

- 1, 2, 3... 1. Press the hexadecimal PV table cell in the desired row. (Pressing the cell won't have any effect if a word isn't being displayed in the row.)
The following popup input window will be displayed.

NT31/NT31C input window



NT631/NT631C input window



When the input window is displayed, the binary PV cell will change as shown below to receive the new hexadecimal PV.

NT31/NT31C:

“From > □□□□ To > ?????”

NT631/NT631C:

“From > □□□□ To > ?????”

- The □□□□ field shows the original PV that was displayed when the hexadecimal PV table cell was pressed.
- The ????? field displays the new PV as it is entered.

- Reference:**
- Monitoring will stop in the row while the popup input window is being displayed. Monitoring will continue in the other rows and any changes in those words will appear on the screen.
 - No other operations can be performed while the popup input window is being displayed on the screen. (The PT can be controlled from the PC if the PT is operating.)

2. Input the new word PV or specify the timer/counter’s new forced status.

Changing a Word PV

Input the new PV by pressing the hexadecimal touch switches (0 to 9 and A to F) on the popup input window. Each time that a digit is pressed, it will appear in the ????? field in the binary PV table cell. The digits are input from right to left.

The following values will be displayed as the five keys 3 → 5 → C → 8 → A are pressed: 0003 → 0035 → 035C → 35C8 → 5C8A.

The new PV field can be returned to 0000 by pressing clear.

Force-setting and Force-resetting Timer/Counter Completion Flags

Specify force-setting or force-resetting by pressing the corresponding touch switch in the popup input window.

Action	Touch switch	Display after change
Force-setting	Set or Force-set	SET
Force-resetting	Reset or Force-reset	RESET

Clearing a Timer/Counter’s Forced Status

Specify clearing the forced status by pressing the corresponding touch switch in the popup input window.

Action	Touch switch	Display after change
Clearing forced status	Release or Force-release	Clearing force-set status: PV (0000) Clearing force-reset status: PV before force-reset

If the Clear touch switch is pressed, the force-clear operation will be cancelled and the PV will be returned to its previous value.

3. Press the Write touch switch. The new value will be written to the word in the specified row, the hexadecimal PV, binary PV, and PV character will change to match the new value, and the PT will restart monitoring. At the same time, the popup input window will be closed.

If the new value cannot be written, an error message will be displayed in the lower-left corner of the screen and the buzzer will sound. (This buzzer sound can be disabled with the PT’s touch switch sound setting.) In this case, check the status of the PC and specified data area and try changing the value again. The error message will be cleared when the data is written properly.

Error message	Probable cause
Cannot write in RUN mode	Attempted to write to a PC in RUN mode.
Write-protected memory	Attempted to write to a read-only or write-protected area.

If the Back touch switch is pressed before the Write touch switch, the input will be cancelled and the PT will restart monitoring with the original PV.

Changing Binary PVs and Forcing Bit Status

Use the following procedure to change the status of bits in the monitored word. This procedure **cannot** be used to change the PVs of timers or counters.

- 1, 2, 3... 1. Press the binary PV table cell in the desired row. (Pressing the cell won't have any effect if a word isn't being displayed in the row.)

The following popup input window will be displayed.

NT31/NT31C input window



NT631/NT631C input window



At the same time, the binary PV field will be displayed in reverse video.



The cursor is located at the bit that is not displayed in reverse video.

- Reference:**
- Monitoring will stop in the row while the popup input window is being displayed. Monitoring will continue in the other rows and any changes in those words will appear on the screen.
 - No other operations can be performed while the popup input window is being displayed on the screen. (The PT can be controlled from the PC if the PT is operating.)

2. Press the Left and Right Arrow Keys to move the cursor to another bit.
 3. Specify the bits, value or forced status with the following touch switches on the popup input window.

Action	Touch switch	Bit display
Set the bit to 1 (ON).	1	1
Set the bit to 0 (OFF).	0	0
Force-set the bit.	Set or Force-set	S
Force-reset the bit.	Reset or Force-reset	R

If the Clear touch switch is pressed, the new bit settings will be cancelled and the display will be returned to the status it had before the popup input window was opened or just after the data was written.

Reference: The status of bits in the EM Area (EM or banks EM0 through EMF) cannot be forced.

4. Press the Write touch switch. The new bit values and/or forced status will be written to the word in the specified row, the hexadecimal PV, binary PV, and

PV character will change to match the new settings, and the PT will restart monitoring. At the same time, the popup input window will be closed.

If the new settings cannot be written, an error message will be displayed in the lower-left corner of the screen and the buzzer will sound. (This buzzer sound can be disabled with the PT's touch switch sound setting.) In this case, check the status of the PC and specified data area and try changing the value again. The error message will be cleared when the new settings are written properly.

Error message	Probable cause
Cannot write in RUN mode	Attempted to write to a PC in RUN mode.
Write-protected memory	Attempted to write to a read-only or write-protected area.

If the Back touch switch is pressed before the Write touch switch, the input will be cancelled and the PT will restart monitoring with the original PV.

Reference: If Device Monitor has been used to force-set or force-reset bit(s) in the displayed word, a message will appear in the bottom-left corner of the screen indicating that there are bits in the word with forced status. This message will not appear if the bit status was forced by operations at the PC.

Clearing All Force-set and Force-reset Bits

Use the following procedure to clear the forced status for all of the PC's bits or timer/counter Completion Flags that have been force-set or force-reset.

- Reference:**
- This operation clears the forced status of all bits and Completion Flags in the PC, whether the status was forced from the Device Monitor function or from a Programming Device connected to the PC.
 - Bits and timers/counters will have the following status after the forced status is cleared:

Bits that were force-set:	0
Bits that were force-reset:	1
Timers/counters that were force-set:	PV reset to 0000
Timers/counters that were force-reset:	PV reset to status before force-reset

- 1, 2, 3...**
1. Press the binary PV table cell in the desired row where a word other than a timer/counter is being monitored. (Pressing the cell won't have any effect if a word or timer/counter isn't being displayed in the row.)

The following popup input window will be displayed.

NT31/NT31C input window

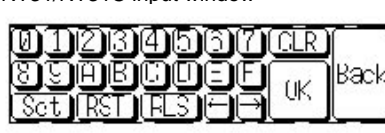

NT631/NT631C input window



- Reference:**
- Monitoring will stop in the row while the popup input window is being displayed. Monitoring will continue in the other rows and any changes in those words will appear on the screen.
 - No other operations can be performed while the popup input window is being displayed on the screen. (The PT can be controlled from the PC if the PT is operating.)

2. Press the Release or Force release touch switch in popup input window. A confirmation message will be displayed in the bottom-left corner of the screen.

3. Press the Write touch switch to clear the forced status of all bits and timer/counter Completion Flags in the PC.

If the Clear touch switch is pressed instead of Write, the forced-status clear operation will be cancelled and the PT will revert to the ordinary binary PV specification screen.

4. Press the Back touch switch to close the popup input window.

If the Back touch switch is pressed before Write, the forced-status clear operation will not be completed and the PT will restart monitoring with the original conditions.

Precautions for Force-setting, Force-resetting, and Clearing Forced Status

When the following operations are performed at the PC or at the PT (with the Device Monitor), the Device Monitor display may not properly reflect the force-set status, force-reset status, or cleared forced status.

- A word displayed with bits that have forced status should be displayed again after exiting the display.
- A bit that was force-set or force-reset from Device Monitor is cleared from the PC (In addition to intentional forced-status clear operations, the same forced-status clear condition can occur by turning the PC OFF or disconnecting cables.)
- A bit that was force-set from Device Monitor is force-reset from the PC or a bit that was force-reset from Device Monitor is force-set from the PC.
- The PC is switched from RUN mode to MONITOR or PROGRAM mode with the Forced Status Hold Bit set to OFF.

Observe the following precautions in addition to the precautions listed above.

- When the PC is in RUN mode, it is not possible to force-set, force-reset, or clear the forced status of bits.
- Do not force-set or force-reset the status of bits in write-protected areas or areas where the operation normally cannot be performed.

2-17-6 Using the Continuous Monitor Screen

The continuous monitor screen can be used to display the contents of words in the DM Area and EM Area.

- Reference:** A word or bit address that has been specified will remain valid until the PT is turned OFF or reset. The settings will remain valid even if the Device Monitor function is closed, so the last valid settings will be displayed the next time that the Device Monitor function is started.

NT31/NT31C Screen

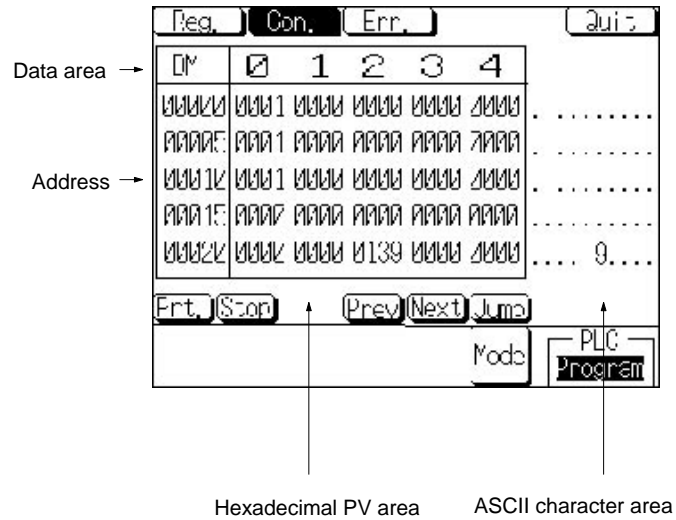

With the NT31/NT31C, the PVs of up to 25 words (5 words × 5 rows) can be displayed simultaneously.

NT631/NT631C Screen

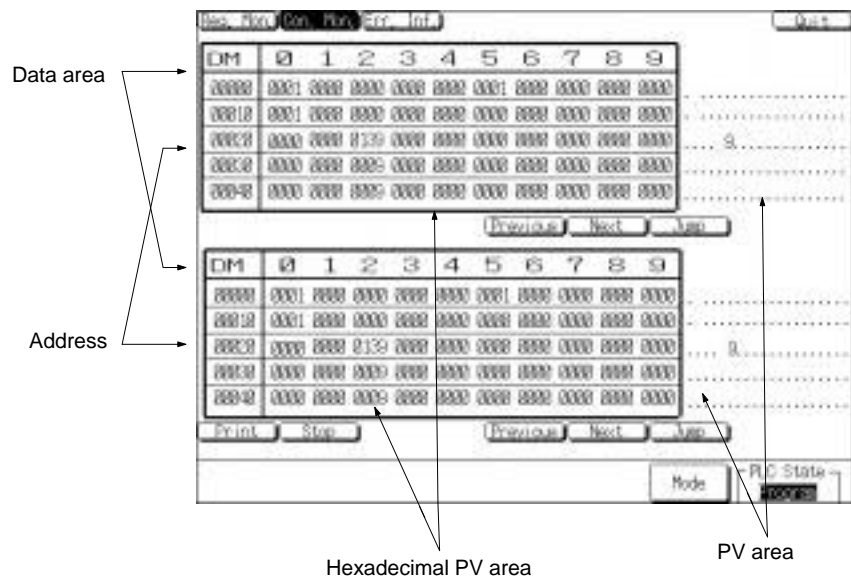

With the NT631/NT631C, two tables of 50 words (10 words × 5 rows) can be displayed simultaneously for a total of 100 words.

Data Area and Address

The first column displays the word address (data area acronym and address) of the first (leftmost) of the words being monitored in that row.

Hexadecimal PV Area

This area displays the PVs of the words in hexadecimal.

ASCII Character Area

This area displays the ASCII equivalent of the PVs in the row. Spaces will be displayed if there aren't ASCII characters equivalent to a PV in the row.

Page Up and Page Down Touch Switches

Press these touch switches to display the previous or next table of words. In the NT31/NT31C, each table contains 25 words. In the NT631/NT631C, each table contains 50 words.

JUMP Touch Switch

Press this touch switch when you want to specify a particular DM or EM address for display.

Specifying/Changing the Word and Clearing the Display

Words Displayable in the Continuous Monitor Screen

The following table shows which words can be monitored in the continuous monitor screen.

Data area	Name	CS/CJ	C200HX/HG/HE (-Z)	C200HS, CPM1, CPM2A, CPM2C, CQM1, or SRM1	CQM1H
DM	Data Memory Area	OK	OK	OK	OK
IR/CIO	Internal Relay or Core I/O Area	OK	OK	OK	OK
TIM	Timer Area	OK	OK	OK	OK
CNT	Counter Area	OK	OK	OK	OK
HR	HR (Holding Relay) Area	OK	OK	OK	OK
AR	AR (Auxiliary Relay) Area	OK	OK	OK	OK
LR	LR (Link Relay) Area	---	OK	OK	OK
WR	Work Area	OK	---	---	---
EM	EM Area (current bank)	Installed EM banks	Installed EM banks	---	Installed EM banks
EM0 to EMF	EM Area (bank 0 to bank F)	Installed EM banks	Installed EM banks	---	Installed EM banks

OK: Can be displayed No: Cannot be displayed ---: Not applicable Not with Host Link: Installed EM banks can be displayed

Procedures

Use the following procedure to specify the words to monitor, change the words' PVs, or clear words from the display.

With the NT31/NT31C, the 25-word table containing the specified word will be displayed. (The first word in the table is a multiple of 25.)

With the NT631/NT631C, the 50-word table containing the specified word will be displayed. (The first word in the table is a multiple of 50.) Two separate 50-word tables can be displayed.

The JUMP touch switch can be pressed to display an explanation of how to specify word addresses. The Page Up and Page Down touch switches can be pressed to display the previous or next table of words.

- 1, 2, 3... 1. Press the JUMP touch switch at the bottom of the desired table. The following popup input window will be displayed to input the word address. (This example shows the NT631/NT631C.)

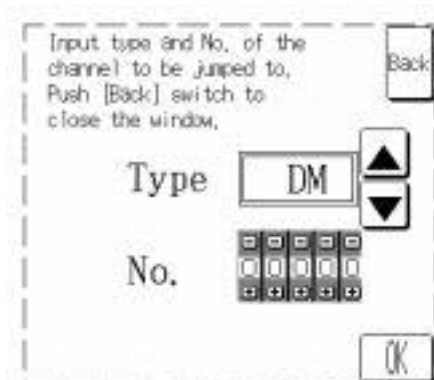

If you specify a word in the table that is already being displayed, the data area and address of the first word of the table will be displayed in the popup input window.

- Reference:**
- Monitoring will stop in a table while the popup input window is being displayed for that table. (With the NT631/NT631C, monitoring will continue in the other table and any changes in those words will appear on the screen.)
 - No other operations can be performed while the popup input window is being displayed on the screen. (The PT can be controlled from the PC if the PT is operating.)

2. Press the Up and Down Arrow Keys (▲ and ▼) to select the desired data area. The following table shows the order in which the data areas appear when the Down Arrow Key is pressed. (The data areas appear in the opposite order when the Up Arrow Key is pressed.)

PC model	Data area order
CS/CJ, C200HX/HG/HE (-Z)	DM → IR/CIO → TIM → CNT → HR → AR → WR → EM* → EM0* → ... → EMF* → clear → (repeat from DM)
C200HS, CPM1, CPM2A, CPM2C, CQM1, SRM1	DM → IR → TIM → CNT → HR → AR → LR → clear → (repeat from DM)
CQM1H	DM → IR → TIM → CNT → HR → AR → LR → EM* → EM0* → clear → (repeat from DM)

* The number of EM banks depends upon the PC being used. The PT will display only those EM banks available in the connected PC.

Select clear for the data area to clear the table to all spaces.

3. Specify the address by pressing the Increment and Decrement Keys (+ and -) on the word address's thumbwheel switch. (This step isn't necessary if you are clearing the table.)

The digit will be incremented or decremented by 1 each time that you press the Increment or Decrement Key.

The table containing the specified word will be displayed. Each table contains either 25 words (NT31/NT31C) or 50 words (NT631/NT631C).

4. Press the Write touch switch. The PT will begin monitoring the range of words that contains the specified word and the popup input window will be closed. (The table will be cleared if clear was selected for the data area.)

If the specified word address is not valid, an error message will be displayed in the lower-left corner of the screen and the buzzer will sound. (This buzzer sound can be disabled with the PT's touch switch sound setting.) In this case, check the valid range of the data area in the connected PC and enter the word address again. The error message will be cleared when a valid word address is entered.

If the Back touch switch is pressed before the Write touch switch, the input will be cancelled and the PT will return to monitoring the original word addresses.

2-17-7 Using the Error Log Screen

The error log screen reads the error log in the PC (the errors that have occurred in the PC) and lists the errors in order of their priority. It is also possible to clear the highest priority error.

NT31/NT31C Screen

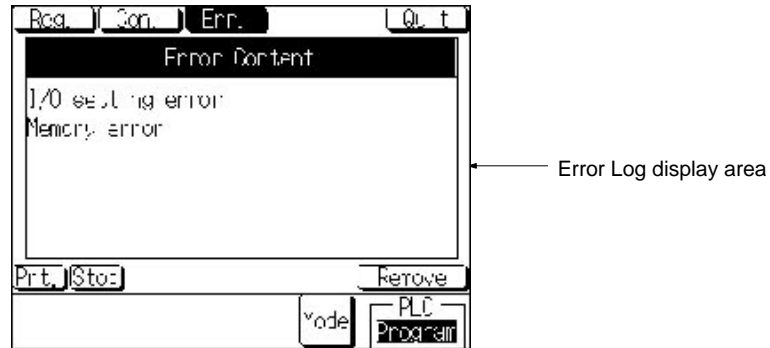

With the NT31/NT31C, 5 error records can be displayed in one screen. The highest priority error must be cleared in order to display the sixth error record.

NT631/NT631C Screen



With the NT631/NT631C, 30 error records (15 records \times 2 columns) can be displayed in one screen. The highest priority error must be cleared in order to display the thirty-first error record.

Error Log Display Area

The error log display area displays errors in order of their priority. (With the NT631/NT631C, the highest priority error is displayed at the top of the left column and the lowest priority error is displayed at the bottom of the right column.)

The screen will be updated if another error occurs while the error log is being displayed.

Clear Error Touch Switch

Clear the highest priority error (displayed at the top or top-left) by pressing the clear error touch switch. The error will be removed from the display area once it is cleared, but the same error may occur again immediately if the cause of the error hasn't been eliminated. If the error cannot be cleared, a message indicating that it can't be cleared will be displayed in the bottom-left corner of the screen.

Errors Appearing in the Error Log

The following table lists the PC errors that may be displayed in the error log screen. The error descriptions vary depending upon the model of PC that is connected. Refer to the PC's Manuals for details on the errors and troubleshooting.

Errors		CS/CJ-series	C-series
Fatal errors	System FALS Error FAL□□□ (□□□: FALS number)	Yes	Yes
	Too Many I/O Units	No	Yes
	I/O Table Setting Error	No	Yes
	I/O Bus Error □□□ (□□□: Rack number)	Yes* ¹	Yes
	No END Instruction	No	Yes
	Memory Error	Yes	Yes
	Unit Number Duplication Error	Yes	No
	Rack Number Duplication Error	Yes	No
	Fatal Inner Board Error	Yes	No
	Too Many I/O Points Error	Yes	No
	Cycle Time Overrun Error	Yes	No
	Program Error	Yes	No
	Non-fatal errors	Special I/O Unit Error	Yes
PC Link Error		No	Yes
Host Link Error		No	Yes
Cycle Time Overrun Error		No	Yes
I/O Table Verification Error		Yes	Yes
Battery Error		Yes	Yes
FAL Error FAL□□□ (□□□: FAL number)		Yes	Yes
Interrupt Task Error		Yes	No
Basic I/O Error		Yes	No
PC Setup Error		Yes	No
Non-fatal Inner Board Error		Yes	No
CPU Bus Unit Error		Yes	No
SYSMAC BUS Error □□□ (□□□: Unit number of the affected Master)		Yes* ¹	Yes
CPU Bus Unit Setup Error		Yes	No
Special I/O Unit Setup Error		Yes	No

Yes: Can be displayed No: Cannot be displayed or not applicable

*1: The □□□ rack or unit number is not displayed for CS/CJ-series PCs.

Reference: The display of FAL numbers and FALS numbers depends upon the model of PC that is connected.

C-series PCs:

- If both FAL(06) and FALS(07) errors have occurred, only the FALS number will be displayed. The FAL number will not be displayed.
- FAL and FALS numbers will be displayed in the □□□ area if they are generated by the system (such as FAL 9B and FALS 9F) rather than the FAL(06) and FALS(07) instructions.

CS/CJ-series PCs:

- The FALS number won't be displayed if there is a higher priority error in the error log.
- FAL numbers are always displayed if the error is occurring.

2-17-8 Errors Occurring during Device Monitor Operation

When an error occurs in NT31/NT31C or NT631/NT631C operation while the Device Monitor function is being used, find the symptoms in the following table and perform the corresponding remedy.

Error in Device Monitor Operation

PT symptoms	Probable cause	Remedy
The screen doesn't change even though the Device Monitor function has been called from the PT status control area.	The communications protocol setting at the PT is not 1:1 NT Link or 1:N NT Link.	Check the memory switches (fourth screen) and set the connected PC's serial port protocol to 1:1 NT Link or 1:N NT Link. Set the same protocol in the PC.
	The system program installed in the PT is for a PC maker other than OMRON.	The Device Monitor function can be used only when the PT is connected to an OMRON PC. Refer to <i>6-14 Version Display</i> in the <i>Setup Manual</i> and check the system program type. Only OMRON Direct Access system programs with version numbers Ver. 3.0□ and higher can use the Device Monitor function.
The words that were being monitored the last time that Device Monitor was used are not displayed the next time that Device Monitor is called.	<ul style="list-style-type: none"> • The PT was turned OFF. • The PT was reset. 	The words monitored by Device Monitor are retained even if the Device Monitor is closed, but the information is cleared when the PT is turned OFF or reset. Specify the desired words again.
	The cable was disconnected while Device Monitor was being used and then connected to a PC with a smaller data area.	If the cable is connected again to another PC, the PT will clear any word addresses that aren't supported in that PC. Check the ranges of data areas in the PC and set word addresses within those ranges.

Error Message Displayed

Error	Probable cause	Remedy
The setting is wrong.	A word address that doesn't exist in the PC was specified in the popup input window.	Input a word address that exists in the PC
Can't write while running.	An attempt was made to change word contents while the PC was in RUN mode.	Switch the PC to MONITOR or PROGRAM mode. The PC's operating mode can be changed from any one of the Device Monitor screens.
The memory can't be written.	An attempt was made to write to a read-only or write-protected area.	Write to a read/write area in the connected PC. If the area is write-protected, clear the write-protection and try writing the data again.
Other tool is accessing.	A Programming Device connected to the PC is performing an operation such as online editing. (when attempting to change the operating mode or clear forced status)	Try the operation again after disconnecting the Programming Device.

Error	Probable cause	Remedy
Remove trouble execution fails. (when clearing an error from error log screen)	The cause of the PC error has not been eliminated.	Eliminate the cause of the error that you are trying to clear. For details, refer to the PC's operation manual.
Connection failed. (when starting the Device Monitor function)	The Device Monitor function was called when the PT was not connected to a PC that supports Device Monitor.	Check the model of the PC that is connected. (Refer to <i>2-17-1 Compatible Systems</i> for a table of PCs that support the Device Monitor function.)
Set Comm. Method to NT Link (1:1 or 1:N) (when the Device Monitor menu is being displayed)	The communications protocol set at the PT is not 1:1 NT Link or 1:N NT Link.	Check the memory switches (fourth screen) and set the connected PC's serial port protocol to 1:1 NT Link or 1:N NT Link. Set the same protocol in the PC.
(Serial port reception error screen being displayed)	The connecting cable is disconnected or faulty.	Verify the connection between the PT and PC. For details, refer to section 7 of the <i>Setup Manual</i> .

2-18 Mathematical Function

The NT31/NT31C and NT631/631C PTs have been equipped with a mathematical function that automatically executes formulas that have been registered in the PT in advance with the Support Tool. The mathematical function can automatically perform data processing such as scaling in the PT and display the results.

Up to 256 calculation formulas can be registered.

This section explains the functions and operation of the mathematical function. Refer to 5-1 *Examples of Actual Applications of Direct Access* for an example application of the mathematical function.

- Reference:**
- In order to use the mathematical function, a mathematical table must be registered and transferred to the PT along with the image data. Use the Support Tool (version 4.6 for Windows) for these operations.
 - The mathematical function can be used only when the system program of the NT21, NT31/31C, or NT631/631C is version 3 or higher.

2-18-1 Executable Calculations

Formula Patterns

The following table shows the 8 formula patterns that can be executed in the PT. The formulas have 2 to 5 terms.

Formula pattern	Example
$x ! x$	$a + b$
$(x ! x) ! x$	$(a + b) * c$
$x ! (x ! x)$	$a / (b - c)$
$x ! ((x ! x) ! x)$	$a + ((b - c) / d)$
$x ! (x ! (x ! x))$	$a * (b + (c / d))$
$((x ! x) ! x) ! (x ! x)$	$((a * b) - c) / (d + e)$
$((x ! x) ! (x ! x)) ! x$	$((a * b) + (c * d)) * e$
$(x ! x) ! ((x ! x) ! x)$	$(a + b) / ((c - d) * e)$

x: Operand; !: Operator

If there isn't a formula pattern that matches your formula exactly, use operators and operands that won't affect the result (+0 or *1) in the extra terms, as in the following example.

Desired formula	Formula pattern	Registered pattern
$a^2 + b^2$	$((x ! x) ! (x ! x)) ! x$	$(a * a) + (b * b) + 0$

Available Operators

The following operators can be used by the mathematical function.

Type	Symbol	Function	Result
Arithmetic operators	+	Addition	Result of addition
	-	Subtraction	Result of subtraction
	*	Multiplication	Result of multiplication
	/	Division, yields the quotient	Result of division (quotient)
	%	Division, yields the remainder	Result of division (remainder)
Boolean operators	AND	Yields TRUE (1) if the results of both the left formula and right formula are TRUE (non-zero). Otherwise yields FALSE (0).	TRUE (1) or FALSE (0)
	OR	Yields TRUE (1) if the result of the left formula, the right formula, or both are TRUE (non-zero). Otherwise yields FALSE (0).	TRUE (1) or FALSE (0)
	XOR	Yields TRUE (1) if the result of one formula is TRUE (non-zero) and the other is FALSE (0). Yields FALSE (0) if the results of both formulas are TRUE (non-zero) or both are FALSE (0).	TRUE (1) or FALSE (0)
Bit-wise operators	&	Logically ANDs the two bits.	Result of logical AND
		Logically ORs the two bits.	Result of logical OR
	^	Logically XORs the two bits.	Result of logical XOR
Comparison operators	<	Yields TRUE (1) if the result of the left formula is less than the result of the right formula. Otherwise yields FALSE (0).	TRUE (1) or FALSE (0)
	>	Yields TRUE (1) if the result of the left formula is greater than the result of the right formula. Otherwise yields FALSE (0).	TRUE (1) or FALSE (0)
	==	Yields TRUE (1) if the result of the left formula is equal to the result of the right formula, otherwise yields FALSE (0).	TRUE (1) or FALSE (0)

The operators shown in the table above can be used in any combination. The operators have no priority order; the order of operations is determined by the parentheses in the formula pattern.

Example Formula Setting

The following kinds of calculations can be performed by combining formula patterns and operators.

Desired calculation	Formula and operators
Scaling calculation (2×X+Y)	(2 * X) + Y
Bit inversion of X	X ^ FFFF _H
Setting the most significant byte of X to 0	X & 00FF _H
Determining whether X is greater than Y	X > Y
Determining whether 5×X+Y equals 100	100 == ((5 * X) + Y)
Determining whether X is between 15 and 68	((X > 15) AND (X < 68)) + 0

The calculations in the table above are examples. a wide variety of calculations can be made by combining other formula patterns and operators.

Reference: All of the calculation results are stored in word units, including the results of boolean and comparison operations. The results aren't indicated by turning a particular bit ON or OFF.

Specifying Calculation Results and Data

The following storage locations or values can be specified for calculation results and operands.

Calculation results:

Numeral memory table entries or PC addresses (PT memory)

Operands:

Numeral memory table entries, PC addresses (PT memory), or constants

Using Numeral Memory Table Entries

Any numeral memory table entry can be specified as an operand. When a numeral memory table entry is specified, the number of words used in the calculation or the number of words stored as the calculation result depends upon whether words are allocated to the host.

Words **not** allocated:

The operands/calculation results are treated as 2-word data.

Words allocated:

The operands/calculation results are treated as 1-word data if 1 word is allocated or 2-word data if 2 words are allocated.

Using PC Addresses

Words in the following data areas of the host (PC) can be specified as operands or calculation results.

Symbol	C-series PCs	Allocation	CV-series PCs	Allocation	CS/CJ-series PCs	Allocation
None	IR Area	OK	CIO Area	OK	CIO Area	OK
H	HR Area	OK	---	---	HR Area	Not with Host Link
A	AR Area	OK	Auxiliary Area	No	AR Area	OK
L	LR Area	OK	---	---	LR Area*1	Not with Host Link
T	TC Area, Timer PVs	No	Timer Area, Timer PVs	No	TC Area, Timer PVs	No
TU	---	---	---	---	TC Area, Timer Completion Flags	No
C	TC Area, Counter PVs	No	Counter Area, Counter PVs	No	TC Area, Counter PVs	No
CU	---	---	---	---	TC Area, Counter Completion Flags	No
W	---	---	---	---	WR Area	Not with Host Link
TK	---	---	---	---	Task Flags	No
D	DM Area	OK	DM Area	OK	DM Area	OK
E	EM Area *2, current bank	OK	EM Area, current bank	Not with Host Link	EM Area, current bank	Not with Host Link
E0_ to EC_	---	---	---	---	EM Area, EM banks 0 to C	Not with Host Link

*1: LR 00000 to LR 00199 are converted to CIO 01000 to CIO 01199.

*2: The EM Area is supported only by the C200HX/HG/HE(-Z)E PCs.

Since words in the Auxiliary Area of the CVM1 and CV-series PCs is allocated to system functions, and it cannot be used for purposes other than system use.

Timer and counter PVs cannot be specified directly. Use numeral memory table entries when using timer/counter PVs.

The range of each memory area differs according to the PC. Refer to *Appendix D PC Memory Maps* on page 441.

When a memory link is used, any PT memory address (0000 to 9999) can be specified.

When a PC address (PT memory) is used, the number of words used in the calculation and the number of words stored as the calculation result are specified with the data length. The data length specification is the same for all operands and results of a formula.

Using Constants

Use the following ranges for the constants when specifying constants for operands.

-2,147,483,648 to 2,147,483,647 (8000 0000 to 7FFF FFFF hexadecimal)

When constants are used, the number of words of operands is fixed at 2 words.

2-18-2 Data Flow in Calculations

Up to 256 formulas can be registered in the PT's mathematical table. Formulas are registered in the mathematical table in order beginning with number 0 and ending with number 255. (The formula numbers are continuous, it is not possible to skip any numbers.)

When operation is started, the PT automatically executes the calculations in order from the beginning of the mathematical table, as shown in the following flow-chart. All of the calculation results are written at the same time after the last calculation is executed. (Only calculation results that have changed are written.)

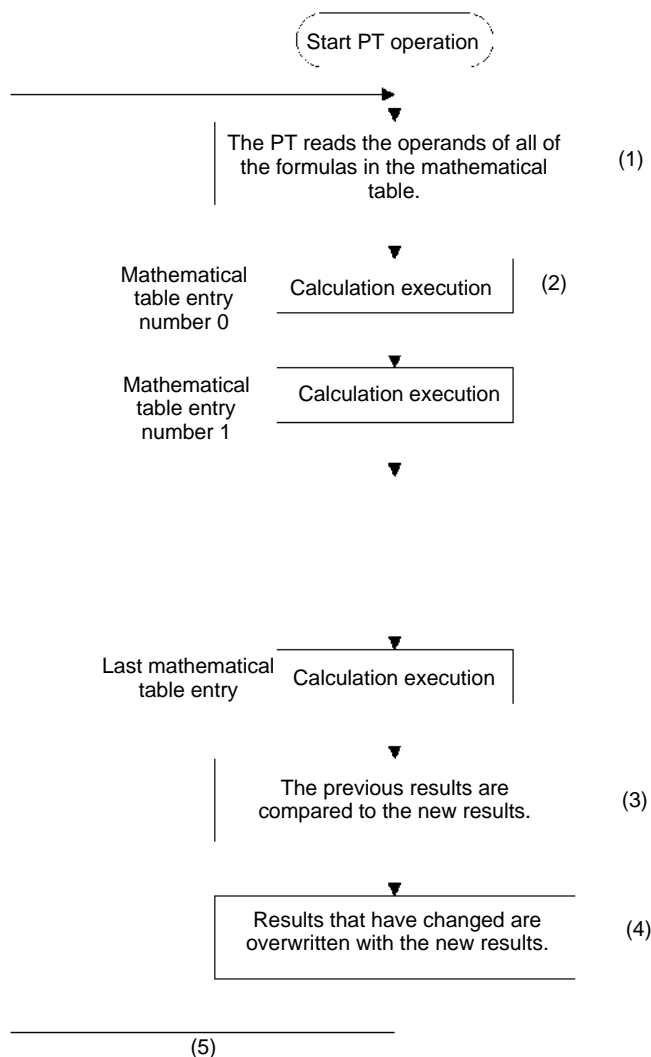

- 1, 2, 3...**
1. Before executing the calculations, the PT examines all of the formulas and reads all of the values to be used as operands.
 2. The PT executes the calculations registered in the mathematical table. The calculations are executed in the order that they are registered.
 3. Once all of the calculations registered in the mathematical table have been executed, the PT determines which results have changed since the last time

that the calculations were performed. (All of the calculation results are examined.)

4. If any results have changed, the new results are written to the corresponding numeral memory table entry or word allocated in the host.

The host will not be notified that new results have been written to the numeral memory table entry, but the same results will be written to words in the host if words have been allocated for the numeral memory table entry in the host.

5. Once all of the results have been written, the PT returns to step 1 and reads all of the values to be used as operands again.

While the PT is operating, the processing in steps 1 through 5 is repeated cyclically. Execution of the calculations cannot be stopped during operation.

2-18-3 Precautions When Using the Mathematical Function

Combining One-word and Two-word Operands

When both one-word and two-word operands have been used in the same formula, the calculation will be performed using two-word operands and the calculation result will be stored using the same number of words as the last calculation result.

If the result cannot be stored in the number of words used in the last calculation result (overflow or underflow), the result will not be stored and the last result will remain valid.

Whenever possible, use the same size operands within each formula. In the following example, the size of the operands or result refers to the number of words.

- Example: Size of result = Largest operand in the formula

$$\begin{array}{rcccl} \text{N0000} & = & \text{N0001} & + & \text{N0002} \\ (1 \text{ word}) & & (1 \text{ word}) & & (1 \text{ word}) \end{array}$$

The calculation on the right is performed as a one-word calculation and the result is stored as one word. If the calculation results in an overflow or underflow (F000 + 1234 for example), the result will not be stored and the last storable result will remain valid.

- Example: Size of result < Largest operand in the formula

$$\begin{array}{rcccl} \text{N0000} & = & \text{N0001} & + & \text{N0002} \\ (1 \text{ word}) & & (2 \text{ words}) & & (1 \text{ word}) \end{array}$$

The calculation on the right is performed as a two-word calculation and the result is stored as one word. If the calculation results in an overflow or underflow (F000 + 1234 for example), the result will not be stored and the last storable result will remain valid.

- Example: Size of result > Largest operand in the formula

$$\begin{array}{rcccl} \text{N0000} & = & \text{N0001} & + & \text{N0002} \\ (2 \text{ words}) & & (1 \text{ word}) & & (1 \text{ word}) \end{array}$$

The calculation on the right is performed as a one-word calculation and the result is stored as two words. In this case, an overflow or underflow will not occur in the calculation result.

Calculation Errors

If a calculation error occurs, the calculation will be invalid and the result won't be refreshed. (The last result will remain valid.) The host will not be notified in this case either, but it is possible to monitor the calculation results at the host and verify that the calculation was executed if necessary.

- Division by 0 (/ or %)

An error will occur if the denominator (b in a÷b) of a calculation is 0. When the denominator is specified in a numeral table entry or host word, be sure that the

content is non-zero. (When the denominator is specified from the Support Tool, an error message will be displayed if you attempt to specify 0.)

- Overflow

An error will occur if the calculation result exceeds the maximum value that can be stored in the number of words in the result. The maximum value that can be stored depends upon the data type and number of words set in the memory table entry or host. (See the following table for allowed ranges.)

- Underflow

An error will occur if the calculation result is below the minimum value that can be stored in the number of words in the result. The minimum value that can be stored depends upon the data type and number of words set in the memory table entry or host. (See the following table for allowed ranges.)

Data type	Number of words	Allowed range
BCD	1	-999 to 9,999*
	2	-9,999,999 to 99,999,999*
Binary	1	8000 to 7FFF hexadecimal
	2	8000 0000 to 7FFF FFFF hexadecimal

* When the host is notified, the leftmost digit is set to F to indicate a negative value. For example, -999 is expressed as F999 and -9,999,999 is expressed as F999 9999.

Using Calculation Results in Later Calculations

The mathematical function reads all of the operands before starting to perform the calculations, so calculation results from one calculation cannot be used in a later calculation in the same cycle.

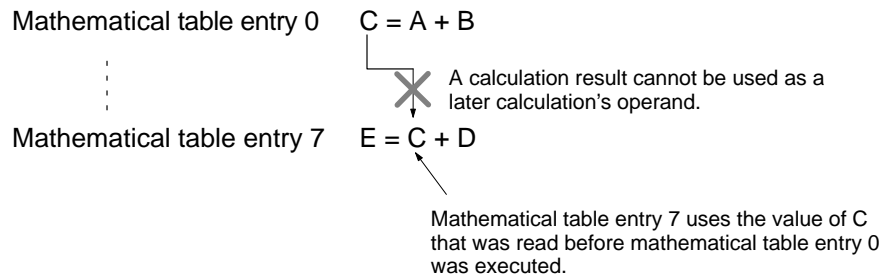

The mathematical function's processing cycle does not match the PC's cycle time, so results from two calculations may not be from the same processing cycle.

Recursive Operations

It is possible to specify the same numeral memory table entry or PC word for both the operands and calculation result. For example, the operation $D02000 = D02000 + 1$ increments the contents of D02000 by 1 each time that the operation is repeated. Since the calculations are always executed while the PT is operating, D02000 will be incremented each processing cycle while the PT is operating.

2-19 PT Configuration Settings

Apart from the settings of the memory switches at the PT itself, the basic operation of the PT is also determined by the PT Configuration settings made at the Support Tool.

This section describes the settings made under PT Configuration. However, note that the operations at the Support Tool are not described. For details on these operations, refer to the *NT-series Support Tool Version 4.6 for Windows Operation Manual* (V061-E1-□).

2-19-1 PT Configuration Settings

There are the following PT Configuration settings.

PT Model

Set the type of PT to be connected. (Refer to *3-1 Screen Creation Procedure* (page 288).)

NT20S Compatible Mode (NT21 Only)

When you want to use screen data from an NT20S in an NT21 PT, you can set NT20S compatible mode to improve compatibility and reduce the editing required to make the screen data and the user program compatible.

The screen data will be checked by default when screen data from the NT20S is converted for use in a NT21 PT. Refer to *Appendix C* for details on the NT20S and NT30/620 compatible modes.

NT30/620 Compatible Mode (NT31/NT31C and NT631/NT631C Only)

When you want to use screen data from an earlier PT (NT30, NT30C, NT620C, or NT625C) in an NT31, NT31C, NT631, or NT631C, you can set NT30/620 compatible mode to improve compatibility and reduce the editing required to make the screen data and the user program compatible.

The screen data will be checked by default when screen data from an earlier PT (NT30, NT30C, NT620C, or NT625C) is converted for use in a V2 version of an NT31/NT31C or NT631/NT631C PT. Refer to *Appendix C* for details on the NT20S and NT30/620 compatible modes.

PC Vendor

Set the direct connection type to one of the options in the following table.

Setting	Direct access type	Remarks
OMRON	OMRON	---
Mitsubishi_A	Mitsubishi A	The special system program provided with the Support Tool is required (NT31/NT31C and NT631/NT631C only).
Mitsubishi_Fx	Mitsubishi FX	
AB	Allen-Bradley	
GE	GE Fanuc	
Siemens	Siemens	
Modicon	Modicon	
MEMLINK	Memory link	---

Font Type

Set the display font to one of the options in the following table.

Setting	Font type
CP437	Code Page 437
ISO 8859-1	ISO 8859/1

For details, refer to the keycode tables in *Appendix E* (page 467).

Comments

Set a comment relating to screen data here. This comment is displayed on the screen on manual transmission of Memory Unit.

PT Control Area/PT Notify Area

Set the allocated words for the PT status control area, PT status notify area and window control area here. Refer to *2-2 Areas for Control/Notification* (page 52).

Initial Screen

Set the screen number of the screen that is displayed when PT operation starts. However, note that the screen set here is displayed as the initial screen only when the setting made for the screen switch setting word in the PT status control area is not a correct screen number. For details, refer to *Functions of the PT Status Control Area* (page 53).

History Setting

Set the processing method when the record areas for the display history function and alarm history function become full. Refer to Alarm list/history function (page 89).

Number of Table Entries

Set the numbers of numeral memory table entries, character string memory table entries, and bit memory table entries here. For details on the numbers that can be set, refer to *2-3 Memory Table* (page 72).

Numeral Storage Type

Set whether the contents of words allocated to the following table entries will be handled as BCD data or binary data.

- Values in words allocated to numeral memory table entries
(The numeric value storage method set here is only valid when System is set for Storage Type for each numeral memory table entry concerned. For details, refer to *2-3-1 Numeral Memory Table* (page 72).)
- Screen numbers in the word allocated to the PT status control area's screen switch setting
- Memory table entry numbers in the words allocated to the PT status control area's copy source and copy destination memory table entries
- Memory table entry numbers in the words allocated to the PT status notify area's updated memory table entry

SECTION 3

How to Use the PT

This section describes how to use the functions provided by the PT.

3-1	Screen Creation Procedure	288
3-2	Buzzer, Backlight, and Display Control	290
3-2-1	Sounding the Buzzer	290
3-2-2	Stopping the Buzzer Sound	291
3-2-3	Controlling the Backlight	293
3-2-4	Turning off the Screen	295
3-2-5	Redisplaying the Turned-off Screen	297
3-3	Screen Display and Notification	300
3-3-1	Switching the Screen	300
3-3-2	Finding the Screen Number of the Presently Displayed Screen	306
3-4	Display and Control of Windows	309
3-4-1	Opening/Closing/Moving a Window	309
3-4-2	Checking the Display Status of a Window	314
3-4-3	Disabling/Enabling the Opening of a Window	316
3-5	Changing Numeral and Character String Display	317
3-5-1	Changing Numeric Values and Character Strings	317
3-6	Display of Graphs	328
3-6-1	Changing the Trend Graph Display	328
3-7	Input of Numeric Values and Character Strings	329
3-7-1	Inputting a Numeric Value	329
3-7-2	Inputting Character Strings	343
3-8	Using the Alarm List/History Function	348
3-8-1	How to Use the Alarm List/History	348
3-9	Using the Display History Function	353
3-9-1	How to Use the Display History	353
3-10	Display and Setting of Calendar Clock	356
3-10-1	Setting the Date and Time (NT31/NT31C and NT631/NT631C)	357
3-10-2	Displaying the Date and Time	361
3-11	Printing Data and Checking the Printer Status	364
3-11-1	Printing the Screen	365
3-12	Enabling/Disabling PT Operations	368
3-12-1	Enabling and Disabling the Operation of the PT	368

3-1 Screen Creation Procedure

Follow the procedure shown below to create screens for the NT21, NT31/NT31C, and NT631/NT631C.

The following gives the procedure assuming that the setting for the PT has been completed. The operating procedure for a Support Tool is not given here. For the operating procedure for the Support Tool, refer to the *NT-series Support Tool Version 4.6 for Windows Operation Manual* (V061-E1-□).

Creating a New Screen

Tool Setting (PT model)

Set the PT model as follows:

- NT21: Set NT21.
- NT31: Set NT31-V2.
- NT31C: Set NT31C-V2.
- NT631: Set NT631-V2.
- NT631C: Set NT631C-V2.



System Setting (Memory Switch Setting)

Set the memory switches that determine the basic operation of the PT.

The numeral/character string/bit memory table entry settings should also be made at this stage.



Setting for PT Status Control/Notify Area

Allocate words for the PT status control area and PT status notify area, necessary for the direct connection function, in the host.

For details, refer to 2-2 Areas for Control/Notification (page 52).



Correcting an Existing File

File Designation

Designate a work file.



Importing DOS Version Data

File Designation

Designate the work file to be data converted.



Setting the Clock Data Area (NT21 only)

Set the address of the first word to allocate as the Clock Data Area in the host so that the clock data can be read from the host.



Creating and Correcting a Screen

After designating a screen, set the screen properties and register elements for the screen or correct the screen. If necessary, create marks, image data, and library data, and set the initial values of memory table entries.

For details of screens and elements, refer to *Section 2 PT Functions*.



Saving a File

Save the created screen data to a file.



Transmitting the Screen Data

Transmit the created screen data to the PT. After setting the PT in the Transmit mode, execute the screen data transmission operation with the Support Tool.

NT31/NT31C

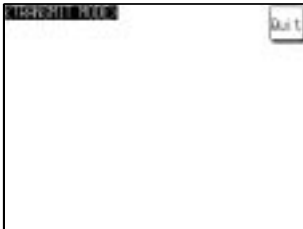

Support Tool



Reference:

- It is not necessary to allocate words to the window control area if windows are not used or when the windows are not controlled from the host.
- It is not necessary to allocate words for the clock data area if the clock data is not displayed and the screen display history or alarm history is not used.

3-2 Buzzer, Backlight, and Display Control

The procedure for controlling the PT status including sounding the buzzer, backlight ON/OFF status, and turning ON/OFF the screen display is described below.

3-2-1 Sounding the Buzzer

The PT provides the following three types of buzzer sounds.

- Continuous sound
The buzzer sounds continuously.
- Short intermittent sound
The buzzer sounds intermittently at 0.5 second intervals.
- Long intermittent sound
The buzzer sounds intermittently at 1 second intervals.

With the PT, the following two methods are used for sounding the buzzer.

- Displaying a screen for which the buzzer attribute is set
- Using a PT status control area operation

Reference: Whether or not the buzzer actually sounds depends on the setting of the memory switch in the PT. The memory switch has the following three setting positions.

- OFF: The buzzer never sounds.
- ERR ON: The buzzer only sounds when a PT error occurs.
- ON: The buzzer sounds in response to instructions from the host and screen attributes and when an error occurs.

To control the buzzer, set the memory switch at ON. For details, refer to *2-16-5 Buzzer Function* (page 250).

Sounding the Buzzer by Displaying a Screen for Which the Buzzer Attribute Is Set

If this method is used, the buzzer sounds automatically when a specific screen is displayed.

Setting

When creating a screen using the Support Tool, set any of the following buzzer attributes for the screen. Nothing is set in the default setting.

- Continuous
- Short beep
- Long beep



Operation

When the screen where the buzzer attribute has been set is displayed during the operation of the PT, the buzzer sounds automatically according to the setting. For the procedure for changing the screen, refer to *3-3-1 Switching the Screen* (page 299).

Sounding the Buzzer by the Operation at the Status Control Area

This method allows the operator to sound the buzzer at any required time.

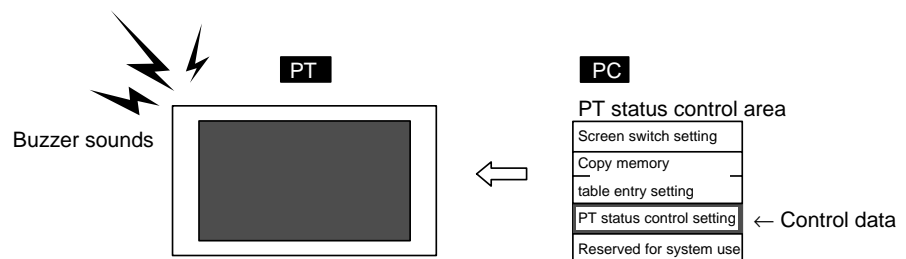

Setting

Words must be allocated in the host for PT status control area. There are no special settings required for the control of buzzer.

Operation

The bit for controlling the PT status (PT status control bit) is provided at the fourth word (n + 3 words) from the beginning of the PT status control area.

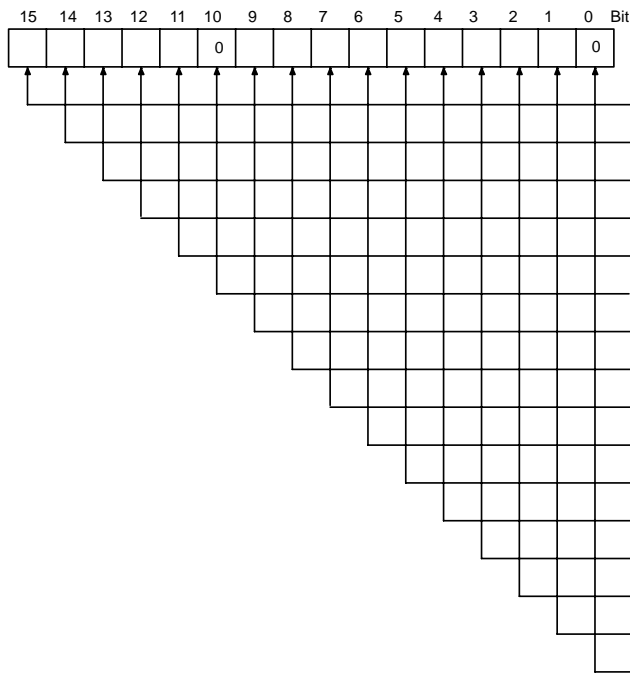

Controlled Item	1 (ON)	0 (OFF)
15 Screen display	Performed	Not performed
14 Processing priority registration (for NT link (1:N))	Registered	Canceled
13 Continuous buzzer	Sounded	Stopped
12 Intermittent buzzer (short)	Sounded	Stopped
11 Display history initialization	Performed	Not performed
10 Not used	Always 0	
9 Intermittent buzzer (long)	Sounded	Stopped
8 Backlight mode	Lit	Flashing
7 Screen printing	Performed	Not performed
6 PT window opening	Disabled	Enabled
5 Numeral/character string input	Disabled	Enabled
4 PT screen switching	Disabled	Enabled
3 Memory table copy execution	Performed	Not performed
2 Memory table copy type	Numeral	Character string
1 Alarm history initialization	Performed	Not performed
0 Not used	Always 0	

Bits 2 and 3 are not used when the PT is in NT20S or NT30/620 compatible mode.
 Bit 7 is not supported by the NT21.

To sound the buzzer during the operation of the PT, operate the PT status control area as indicated below.

Set 1 (ON) for the following bit in the fourth word (n + 3 words) from the beginning of the PT status control area according to the required buzzer sound.

- Continuous sound: Bit 13
- Short intermittent sound: Bit 12
- Long intermittent sound: Bit 9

3-2-2 Stopping the Buzzer Sound

With the PT, the following three methods are used for stopping the buzzer sound.

- Displaying a screen for which the buzzer attribute is not set
- Operating the PT status control area
- Pressing a touch switch that has the buzzer stop function

Stopping the Buzzer by Displaying a Screen for Which the Buzzer Attribute Is Not Set

When this method is used, the buzzer stops sounding automatically when the screen is switched to the one where the buzzer attribute is not set.

Setting

When creating a screen using the Support Tool, cancel the check mark for the buzzer attribute at the screens where the buzzer should not sound. (Usually, the buzzer attribute is not checked.)



Operation

When the screen for which the buzzer attribute is not checked is displayed during operation of the PT, the buzzer automatically stops sounding. For the procedure for switching the screen, refer to 3-3-1 *Switching the Screen* (page 299).

Stopping the Buzzer by the Operation at the PT Control Area

This method allows the operator to stop the buzzer at any required time.

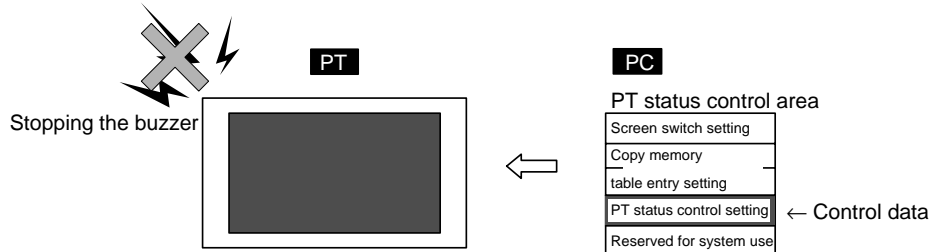

Setting

Words must be allocated for the PT status control area in the host. There are no special settings required for the control of buzzer.

Operation

The bit for controlling the PT status (PT status control bit) is provided at the fourth word ($n + 3$ words) from the beginning of the PT status control area.

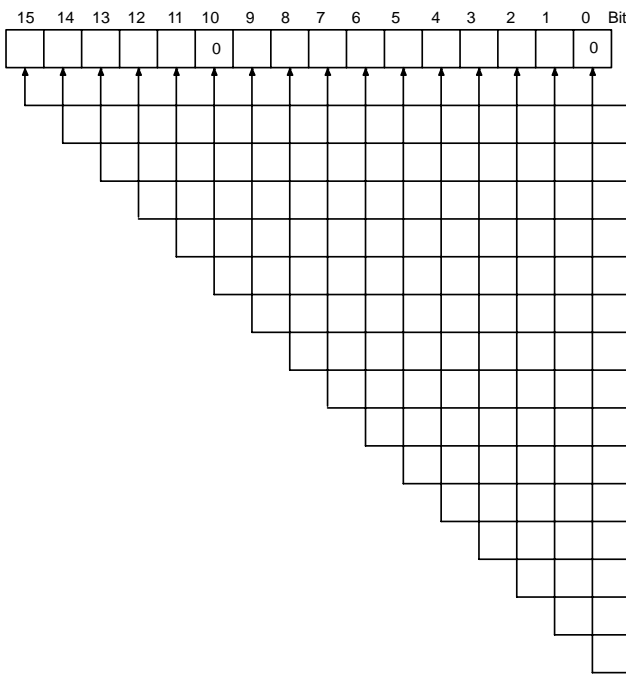

Controlled Item	1 (ON)	0 (OFF)
Screen display	Performed	Not performed
Processing priority registration (for NT link (1:N))	Registered	Canceled
Continuous buzzer	Sounded	Stopped
Intermittent buzzer (short)	Sounded	Stopped
Display history initialization	Performed	Not performed
Not used	Always 0	
Intermittent buzzer (long)	Sounded	Stopped
Backlight mode	Lit	Flashing
Screen printing	Performed	Not performed
PT window opening	Disabled	Enabled
Numeral/character string input	Disabled	Enabled
PT screen switching	Disabled	Enabled
Memory table copy execution	Performed	Not performed
Memory table copy type	Numeral	Character string
Alarm history initialization	Performed	Not performed
Not used	Always 0	

Bits 2 and 3 are not used when the PT is in NT20S or NT30/620 compatible mode.
 Bit 7 is not supported by the NT21.

To stop the buzzer during operation of the PT, operate the PT status control area as indicated below.

Set 0 (OFF) for all of the following bits in the fourth word ($n + 3$ words) from the beginning of the PT status control area.

- Continuous sound: Bit 13
- Short intermittent sound: Bit 12
- Long intermittent sound: Bit 9

- Reference:**
- If more than one bit among the bits indicated above is 1 (ON) at the same time, only one type of buzzer sounds according to the priority: continuous buzzer > short intermittent sound > long intermittent sound. To stop the buzzer when it is sounding, set 0 (0) for all bits indicated above; setting 0 (OFF) only for the bit corresponding to the type of buzzer sound may not stop the buzzer.
 - When the screen is changed, the buzzer setting in the screen attributes may cause the buzzer status to change, causing it to vary from the status in the PT Status Control Area bits. For example, the buzzer may stop even though the bit for a continuous buzzer is ON. If this occurs, reset the bit in the PT Status Control Area.

Stopping the Buzzer by Pressing a Touch Switch That Has the Buzzer Stop Function

Using this method, an operator can stop the buzzer by the operation at the PT. Usually, a buzzer stop touch switch is registered to a screen for which the buzzer attribute is set to sound the buzzer.

- Reference:** The touch switch operation will be disabled when the touch switch interlock function is being used and the host's interlock bit that controls the touch switch's operation is OFF. (See *Disabling Touch Switches with Interlock Bits* on page 369 for details.)

Setting

There is an input key – control touch switch that has the buzzer stop (Ⓜ)) function.

Register this touch switch on the screen when creating it using the Support Tool.

Operation

Press the touch switch with the buzzer stop function to stop the buzzer.

3-2-3 Controlling the Backlight

The NT21, NT31/NT31C, and NT631C provide the following two backlight modes.

- Light: The backlight is lit continuously.
- Flash: The backlight alternates between lit and unlit states.

With the NT21, NT31/NT31C, and NT631C, the following two methods are used for controlling the backlight mode.

- Displaying a screen for which the backlight attribute is set
- Operating the PT status control area

- Reference:**
- If the screen saver function is set to Display erased, the backlight is turned off with the screen, which is turned off by the screen saver function if the PT not operated for a while, or by operation at the PT status control area. Even when the backlight has gone off, it may light or flash according to the setting if the backlight mode is changed by operation at the PT status control area.
 - This setting is ineffective in the NT631.

Controlling the Backlight Status by Displaying a Screen for Which the Backlight Attribute Is Set

By using this method, it is possible to control the backlight automatically when a specific screen is displayed.

Setting

Set either of the following statuses for the backlight screen attribute of the screen for which the backlight is to be controlled when creating it using the Support Tool. (The default setting is Light.)

- Light
- Flash

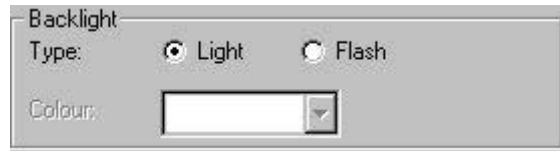

Operation

When the screen is changed over during the operation of the PT, the status of the backlight is controlled according to the setting for the backlight attribute of the newly called screen.

Controlling the Backlight Status by the Operation at the PT Status Control Area

Using this method, the backlight status (lit/flashing) can be controlled at any required time.

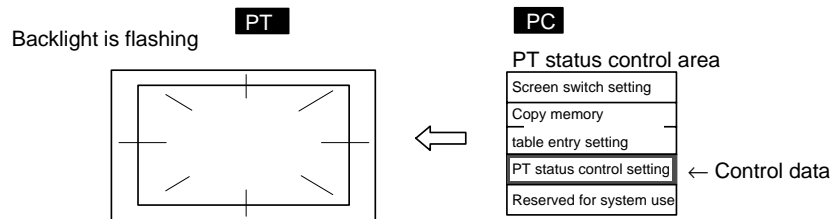

Setting

Words must be allocated for the PT status control area in the host. No special settings are required for the control of buzzer.

Operation

The bit for controlling the PT status (PT status control bit) is provided at the fourth word (n + 3 words) from the beginning of the PT status control area.

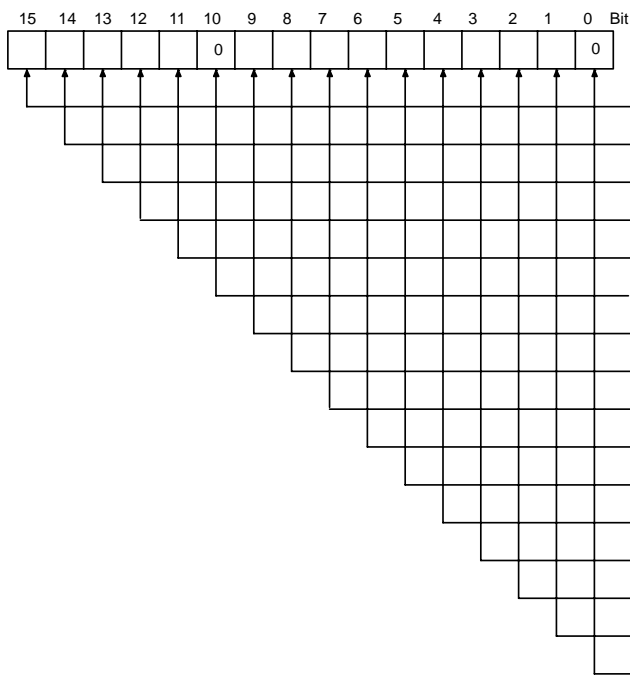

Controlled Item	1 (ON)	0 (OFF)
15 Screen display	Performed	Not performed
14 Processing priority registration (for NT link (1:N))	Registered	Canceled
13 Continuous buzzer	Sounded	Stopped
12 Intermittent buzzer (short)	Sounded	Stopped
11 Display history initialization	Performed	Not performed
10 Not used	Always 0	
9 Intermittent buzzer (long)	Sounded	Stopped
8 Backlight mode	Lit	Flashing
7 Screen printing	Performed	Not performed
6 PT window opening	Disabled	Enabled
5 Numeral/character string input	Disabled	Enabled
4 PT screen switching	Disabled	Enabled
3 Memory table copy execution	Performed	Not performed
2 Memory table copy type	Numeral	Character string
1 Alarm history initialization	Performed	Not performed
0 Not used	Always 0	

Bits 2 and 3 are not used when the PT is in NT20S or NT30/620 compatible mode.
Bit 7 is not supported by the NT21.

To control the backlight status during the operation of the PT, operate the PT status control area as indicated below.

Set 0 (OFF) or 1 (ON) for bit 8 in the fourth word (n + 3 words) from the beginning of the PT status control area.

Word n + 3, bit 8

- To turn the backlight on: 0 (OFF) 1 (ON)
- To flash the backlight: 1 (ON) 0 (OFF)

3-2-4 Turning off the Screen

By turning off the screen while it is not in use, the backlight lasts for a long time and, at the same time, afterimage on the display panel can be prevented. The backlight is turned off automatically when the screen is turned off. If the screen saver function is set to Display, however, it is not possible to prolong the life of the backlight since it is not turned off when the screen is turned off.

The PT provides the following two methods for turning off the screen.

- Using the screen saver function of the PT
- Operating the PT status control area

Note To prevent the formation of an afterimage, either use the screen saver function or periodically switch screens.

- Reference:**
- The screen can be made to enter the no-display state by specifying screen No. 0. In this state, however, the backlight remains lit or flashing.
 - While the screen is in the no-display state, only screen switching operations from the host are permitted.
 - Even though the screen display is set to off, the display of the screen immediately before the screen is turned off remains output by the PT.

Turning off the Screen Using the Screen Saver Function of the PT

If this method is used, the screen is automatically turned off when no operation is attempted for a preset length of time.

Setting

Using the system menu of the PT, set a value other than 000 for Screen Saver Start up Time (the length of time before the screen saver is activated after the last PT operation) and Display erased for Screen Saver Movement. (The screen saver function is not executed if 000 is set for Screen Saver Start up Time.)

Reference: If a value is set other than 000 for Screen Saver Start up Time and Display for Screen Saver Movement, the character string set in character string table entry 0 is displayed on the screen at random. In this case, the backlight is not turned off.

Operation

If the PT has not been operated (touch switch operation, screen switching operation) for the preset length of time during operation of the PT, the screen is automatically turned off.

Turning off the Screen by the Operation at the PT Status Control Area

This method makes it possible to turn off the screen at any required time.

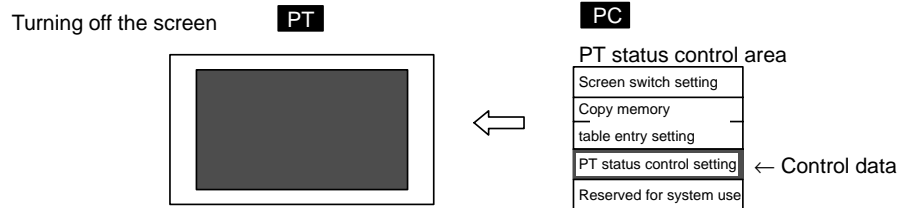

Setting

Words must be allocated for the PT status control area in the host. No special settings are required for the control of buzzer.

Operation

The bit for controlling the PT status (PT status control bit) is provided at the fourth word (n + 3 words) from the beginning of the PT status control area.

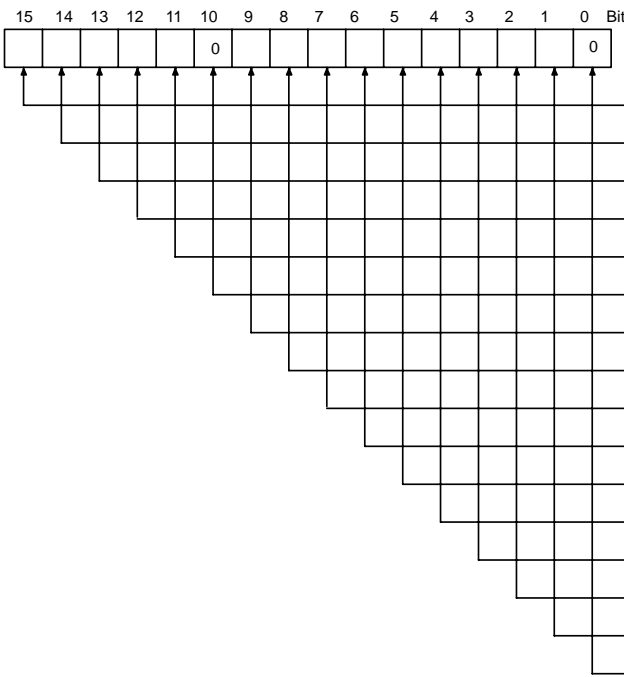

Controlled Item	1 (ON)	0 (OFF)
15 Screen display	Performed	Not performed
14 Processing priority registration (for NT link (1:N))	Registered	Canceled
13 Continuous buzzer	Sounded	Stopped
12 Intermittent buzzer (short)	Sounded	Stopped
11 Display history initialization	Performed	Not performed
10 Not used	Always 0	
9 Intermittent buzzer (long)	Sounded	Stopped
8 Backlight mode	Lit	Flashing
7 Screen printing	Performed	Not performed
6 PT window opening	Disabled	Enabled
5 Numeral/character string input	Disabled	Enabled
4 PT screen switching	Disabled	Enabled
3 Memory table copy execution	Performed	Not performed
2 Memory table copy type	Numeral	Character string
1 Alarm history initialization	Performed	Not performed
0 Not used	Always 0	

Bits 2 and 3 are not used when the PT is in NT20S or NT30/620 compatible mode.
Bit 7 is not supported by the NT21.

To turn off the screen during operation of the PT, operate the PT status control area as indicated below.

Set 0 (OFF) for bit 15 in the fourth word (n + 3 words) from the beginning of the PT status control area.

3-2-5 Redisplaying the Turned-off Screen

The following operations redisplay the screen that has been turned off by the screen saver function or due to the operation at the PT status control area.

- Switching the displayed screen (the new screen is displayed normally)
- Operation at the PT status control area (the previously displayed screen is re-displayed)
- Pressing the touch panel (the previously displayed screen is redisplayed)

Redisplaying the Screen by Switching the Displayed Screen

If this method is used, no special operation is necessary to redisplay the screen. The screen is redisplayed automatically.

Setting

No special setting is necessary.

Operation

Switching the screen during operation of the PT cancels the screen off status and displays the new screen. For the procedure for switching the screen, refer to 3-3-1 *Switching the Screen* (page 299).

Redisplaying the Screen by the Operation at the PT Status Control Area

This method allows the operator to redisplay the screen at any required time.

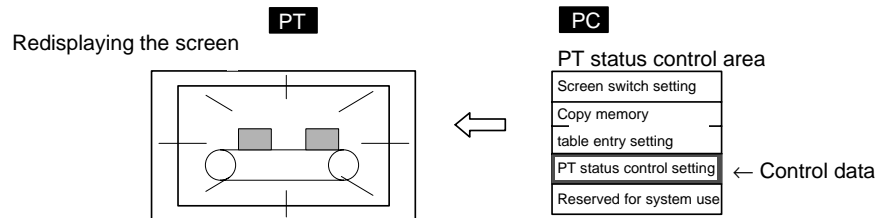

Setting

Words must be allocated for the PT status control area in the host. No special settings are required for the control of buzzer.

Operation

The bit for controlling the PT status (PT status control bit) is provided at the fourth word (n + 3 words) from the beginning of the PT status control area.

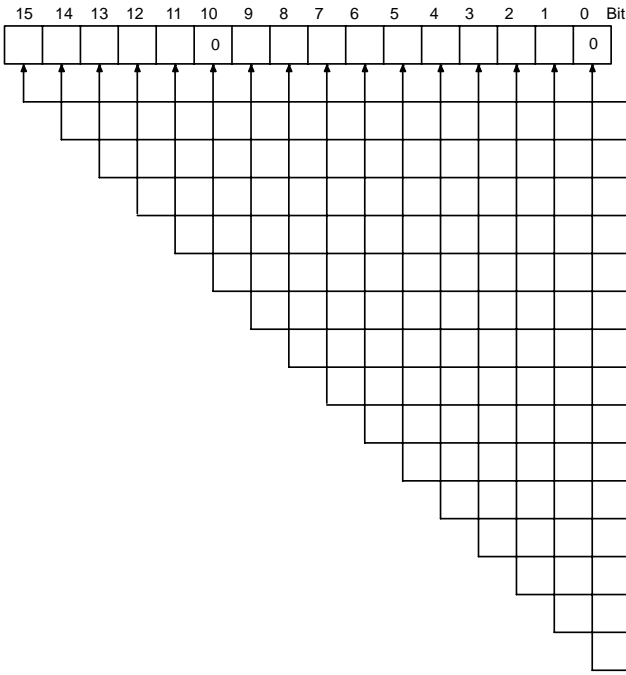

Controlled Item	1 (ON)	0 (OFF)
Screen display	Performed	Not performed
Processing priority registration (for NT link (1:N))	Registered	Canceled
Continuous buzzer	Sounded	Stopped
Intermittent buzzer (short)	Sounded	Stopped
Display history initialization	Performed	Not performed
Not used	Always 0	
Intermittent buzzer (long)	Sounded	Stopped
Backlight mode	Lit	Flashing
Screen printing	Performed	Not performed
PT window opening	Disabled	Enabled
Numeral/character string input	Disabled	Enabled
PT screen switching	Disabled	Enabled
Memory table copy execution	Performed	Not performed
Memory table copy type	Numeral	Character string
Alarm history initialization	Performed	Not performed
Not used	Always 0	

Bits 2 and 3 are not used when the PT is in NT20S or NT30/620 compatible mode.
Bit 7 is not supported by the NT21.

To redisplay the screen during the operation of the PT, operate the PT status control area as indicated below.

Set 1 (ON) for bit 15 in the fourth word (n + 3 words) from the beginning of the PT status control area.

Redisplaying the Screen by Pressing the Touch Panel

Using this method, an operator can redisplay the screen easily by operation at the PT.

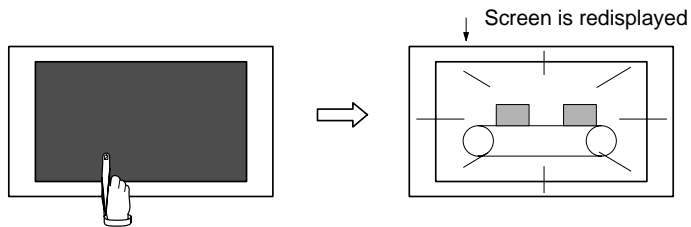

! Caution Do not press the touch panel carelessly while the backlight is off or while the screen is displaying nothing.

Confirm system safety before pressing the touch panel.

- Reference:**
- Even if a position on the touch panel where a touch switch is set is pressed, the touch switch function is not executed but the screen is displayed.
 - If the contents of an element have been changed while the screen is off, the element is redisplayed in the new state.

Setting

No special setting is necessary.

Operation

Pressing the touch panel cancels the screen off status to redisplay the screen that was displayed immediately before the screen was turned off.

3-3 Screen Display and Notification

This section describes the each procedure for changing and checking the screen displayed by the PT.

Reference: The methods of controlling PT status that are described below are not correct for PTs in NT20S or NT30/620 compatible mode. Refer to *Appendix C* for details on the NT20S and NT30/620 compatible modes (page 457).

3-3-1 Switching the Screen

The PT provides the following four methods for switching the screen.

- Operation at the PT status control area
- Pressing a touch switch that has the Switch Screen function
- Using the screen switching function in the bit memory table
- Using the screen switching function of the alarm list/history function

Switching the Screen by the Operation at the PT Status Control Area

With this method, the screen can be switched to the required screen at the required time by the command given by the host.

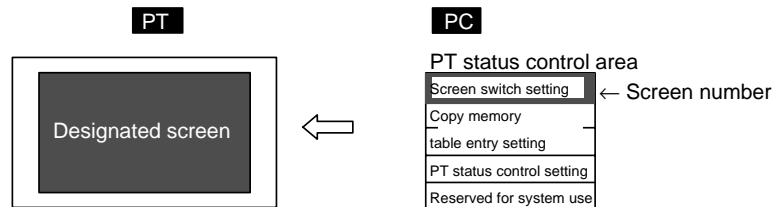

Setting

Words must be allocated for the PT status control area in the host. No special settings are required for the control of buzzer.

Operation

At the beginning of the PT status control area (word n), there is an area (screen switch setting area) for the screen switching command and screen number notification.

Word	15	14	13	12	11	10	9	8	7	6	5	4	3	2	1	0	Bit
n	Screen No. (4-digit BCD or hexadecimal)												Screen switch setting				
n + 1	Copy source memory table entry number (4-digit BCD or hexadecimal)												Copy memory table entry setting				
n + 2	Copy destination memory table entry number (4-digit BCD or hexadecimal)																
n + 3	PT status control bits												PT status control				
n + 4	Reserved for system use																

The configuration and functions of these words are different when the PT is in NT20S or NT30/620 compatible mode.

To switch the screen, operate the PT status control area as indicated below. Write the screen number of the screen to be displayed at the beginning of the PT status control area (word n) either in 4-digit BCD or 4-digit hexadecimal. Which of the BCD or hexadecimal notation should be used is set for Numeral Storage Type of Tools – PT Configuration – System with the Support Tool.

The screen numbers that can be set are:

- 0000: No display (screen off)
- 0001 to 3999: Screen No. 1 to No. 3999

- 9001: Occurrence history screen
- 9002: Frequency history screen
- 9021 to 9023: Device Monitor function screens (NT31/NT31C or NT631/NT631C only)
- 9030: Brightness and contrast adjustment screen (NT31/NT31C or NT631/NT631C only)

- Reference:**
- To display overlapping screens, specify the screen number of the parent screen.
 - When the PT is started up, the screen of which screen number is stored for Screen Switch Setting in PT status control area is displayed. If the screen number stored for Screen Switch Setting is not correct, the screen is displayed according to the screen number set for Initial Screen of System in PT Configuration. If the screen number set for Initial screen is not correct, the error screen (No Starting Screen) is displayed.
 - The screen is not switched if elements have not been registered for the specified screen number.
 - Screen number 9020 (Programming Console function screen) cannot be displayed using operations in the PT Status Control Area.

Switching the Screen by Pressing the Touch Switch with the Switching Screen Function

This method allows the screen to be switched by operation at the PT.

Setting screen No. 5 for the touch switch

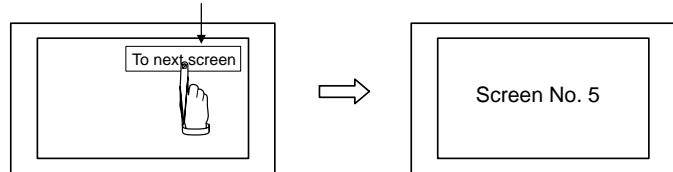

- Reference:** The touch switch operation will be disabled when the touch switch interlock function is being used and the host's interlock bit that controls the touch switch's operation is OFF. (See *Disabling Touch Switches with Interlock Bits* on page 369 for details.)

Setting

When creating the screen using the Support Tool, set the Switch Screen function for a touch switch and specify the screen number of the screen to be switched to. This screen number should be registered to the screen.

The screen numbers that can be specified are:

- 0001 to 3999: Screen No. 1 to No. 3999
- 9001: Occurrence history screen
- 9002: Frequency history screen
- 9020: Programming Console function screen
- 9021 to 9023: Device Monitor function screens (NT31/NT31C or NT631/NT631C only)
- 9030: Brightness and contrast adjustment screen (NT31/NT31C or NT631/NT631C only)

- 9999: Return to the previous screen

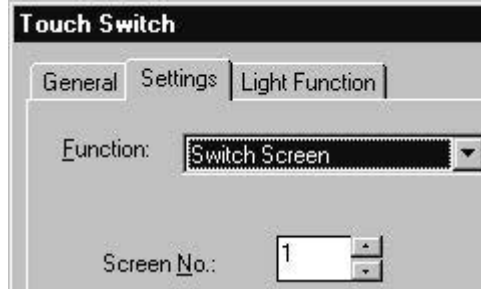

- Reference:**
- To display overlapping screens, specify the screen number of the parent screen.
 - The screen is not switched if elements have not been registered to the specified screen number.

Operation

Press the touch switch with the screen switching function when the screen is to be switched.

- Reference:**
- When the screen is changed over, the screen switching strobe of the PT status notify bit changes to 1 (ON), after the new screen number is written to the screen switching setting area in the PT status control area, so that the event of screen switching is notified to the host. After that the screen switching strobe returns to 0 (OFF) automatically. (Refer to page 305.)
 - When NT20S or NT30/620 compatible mode is being used, the current screen number occupies the first word of the PT status notify area and the word containing the PT status notify bits is shifted down one word. (Refer to page 457.)

Example of Use

Screens Other Than No. 9999

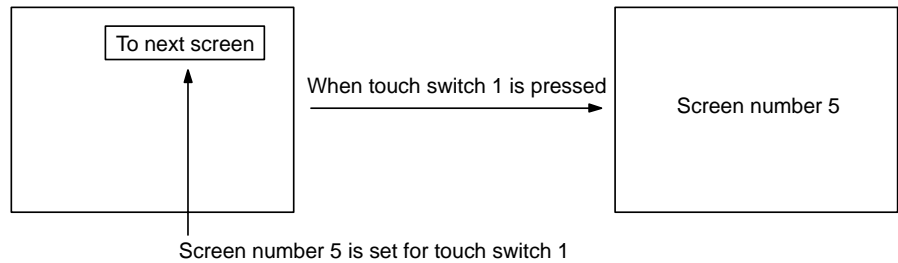

Screen No. 9999

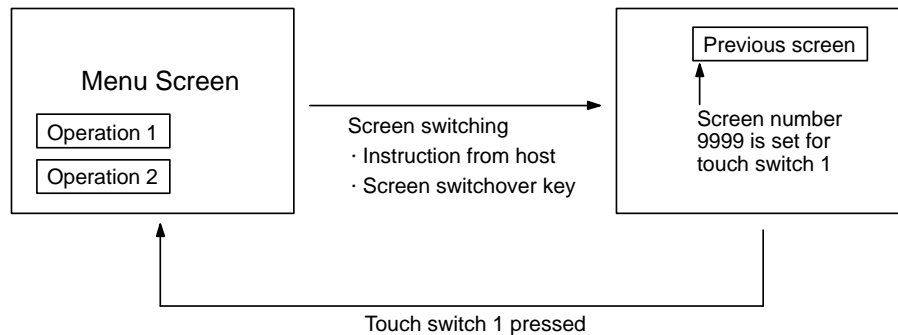

Switching the Screen by Using the Switch Screen Function of the Bit Memory Table

If this method is used, it is possible to switch the screen by bit operation at the host.

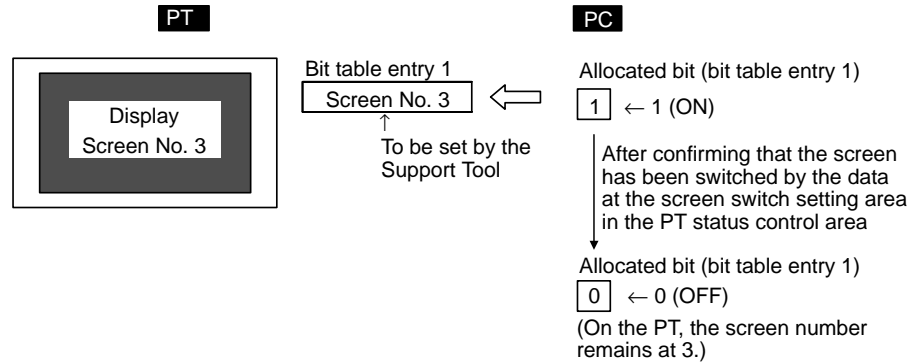

Setting

When creating a screen with the Support Tool, set the Switch Screen function in the bit memory table entry and specify the screen number of the screen to be displayed. Allocate a bit for the bit memory table entry in the host.

The screen numbers that can be specified are:

- 0001 to 3999: Screen No. 1 to No. 3999
- 9001: Occurrence history screen
- 9002: Frequency history screen
- 9020: Programming Console function screen
- 9021 to 9023: Device Monitor function screens (NT31/NT31C or NT631/NT631C only)
- 9030: Brightness and contrast adjustment screen (NT31/NT31C or NT631/NT631C only)
- 9999: Return to the previous screen

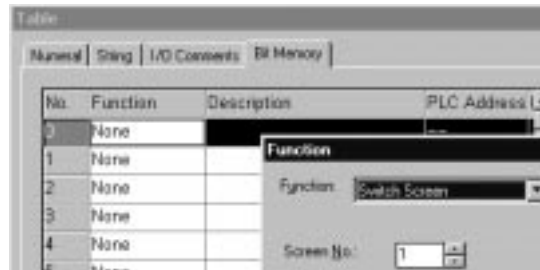

- Reference:**
- To display overlapping screens, specify the screen number of the parent screen.
 - The screen is not switched if elements have not been registered to the specified screen number.

Operation

- 1, 2, 3...**
1. Set the bit in the host allocated for the bit memory table entry with the Switch Screen function to 1 (ON) when switching the screen.
 2. After making sure that the screen has been changed over from the data by referring to the screen switch setting word in the PT status control area or other data, return the bit in the host to 0 (OFF).

Reference: The screen of the PT is switched at the timing the status of the bit allocated for the bit memory table entry is changed from 0 (OFF) to 1 (ON). Please note that the screen is not switched if it is changed from 1 (ON) to 0 (OFF).

Switching the Screen Using the Screen Switching Function of the Alarm List/History Function

This method allows the screen to be switched to the screen corresponding to the message displayed by the alarm list/history function.

The alarm list/history function monitors bits in the host via a bit memory table entry. If the specified bit in the host is turned to 1 (ON), the function displays the corresponding message (character string memory table entry) or image data/library data. The function can also switch over the screen to a specified one.

Message and image/library data that correspond to bit memory table entry 10

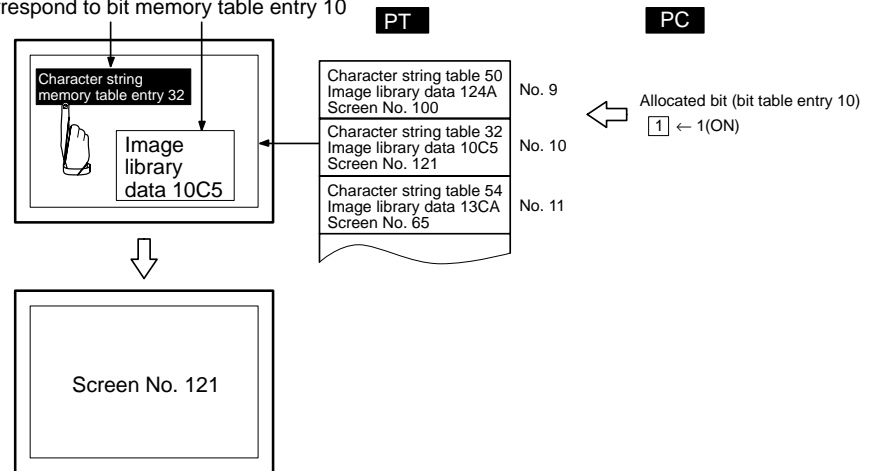

Touching the message changes over the screen to the one set in the bit memory table entry

Setting

- 1, 2, 3... 1. When creating a screen with the Support Tool, set the bit memory table entry as indicated below and allocate a bit for the bit memory table entry in the host.

Function:

Alarm (Alarm list/history function)

Switch Screen:

Check mark set

String Table Entry:

Table entry number of the character string memory table entry where the message to be displayed when the bit is 1 (ON) is stored.

- 0 to 1999

Image/Library Code:

Code of the image data/library data that is displayed when the bit is 1 (ON).

- 0001 to 0FFFH: Image data
- 1000 to 3FFFH: Library data

Screen number:

Screen number of the screen that corresponds to the 1 (ON) bit in the bit memory table entry (in the host).

- 0001 to 3999: Screen No. 1 to No. 3999
- 9001: Occurrence history screen
- 9002: Frequency history screen
- 9020: Programming Console function screen
- 9021 to 9023: Device Monitor function screens (NT31/NT31C or NT631/NT631C only)

- 9030: Brightness and contrast adjustment screen (NT31/NT31C or NT631/NT631C only)
- 9999: Return to the previous screen

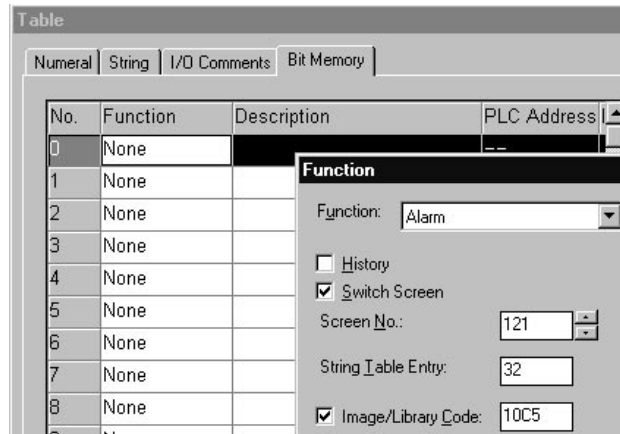

For details of the setting for bit memory table entries, refer to 2-3-3 Bit Memory Table (page 83).

- Reference:**
- To display overlapping screens, specify the screen number of the parent screen.
 - The screen is not switched if elements have not been registered to the specified screen number.

2. When creating the screen, register an alarm list/history element for it.
For details of the alarm list/history, refer to 2-11 Alarm List, Alarm History (page 182).

Operation

- 1, 2, 3...
 1. If the specified allocated bit in the host changes to 1 (ON) while the element of the alarm list/history is displayed, the corresponding message is displayed (with the alarm list, the message is deleted from the list if the allocated bit returns to 0 (OFF)).
 2. The message area is a touch switch and the set image data/library data is displayed when the touch switch is pressed. The message is displayed in reverse video at the same time.
 3. The screen is switched to the specified screen when the reversed message is pressed again.

- Reference:**
- The description above applies to the case where both the image/library code and the screen numbers are set in the bit memory table entry. If the image/library code is not set, the screen is switched over the first time the message is pressed.
 - The PT screen is switched when the reversed message is pressed. The screen is not switched if the status of the allocated bit changes from 1 (ON) to 0 (OFF).
 - When the screen is switched by operation at the PT, the screen switching strobe of the PT status notify bit changes to 1 (ON) so that the event of screen switching is notified to the host. The screen number of the new screen is written to the screen switch setting word in the PT status control area at the same time. (page 305)
 - When NT20S or NT30/620 compatible mode is being used, the current screen number occupies the first word of the PT status notify area and the word containing the PT status notify bits is shifted down one word. (Refer to page 457.)

Example of Use

For an example of use of screen switching using the alarm list/history function, refer to 3-8 Using the Alarm List/History Function (page 347).

3-3-2 Finding the Screen Number of the Presently Displayed Screen

The PT has a function to notify the host of the occurrence of a screen switching event, and the screen number of the new screen when the display screen is switched by operation at the PT.

The host uses the following method to ascertain the screen switching timing and the new screen number.

Reading the PT status notify area and the PT status control area

Reading the PT Status Notify Area and the PT Status Control Area

When the screen is switched, it is notified to the following areas.

- Screen switching timing:
Screen switching strobe in the PT status notify area
- Screen number of the presently displayed screen:
Screen switch setting word in the PT status control area

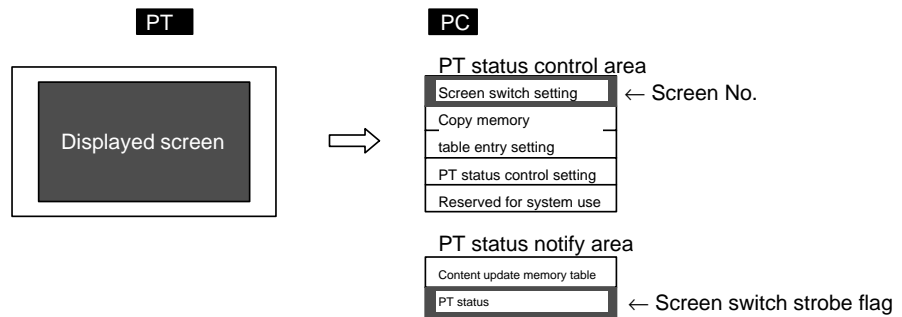

Reference: When NT20S or NT30/620 compatible mode is being used, the current screen number occupies the first word of the PT status notify area and the word containing the PT status notify bits is shifted down one word. (Refer to page 457.)

Setting

The PT status notify area and words must be allocated for the PT status control area in the host. No special settings are required for reading the status.

Operation

Follow the procedure indicated below to check the screen switching executed by operation at the PT.

Reading Screen Switching Timing

The bit for notifying the PT status (PT status notify bit) is provided at the second word (word m + 1) from the beginning of the PT status notify area.

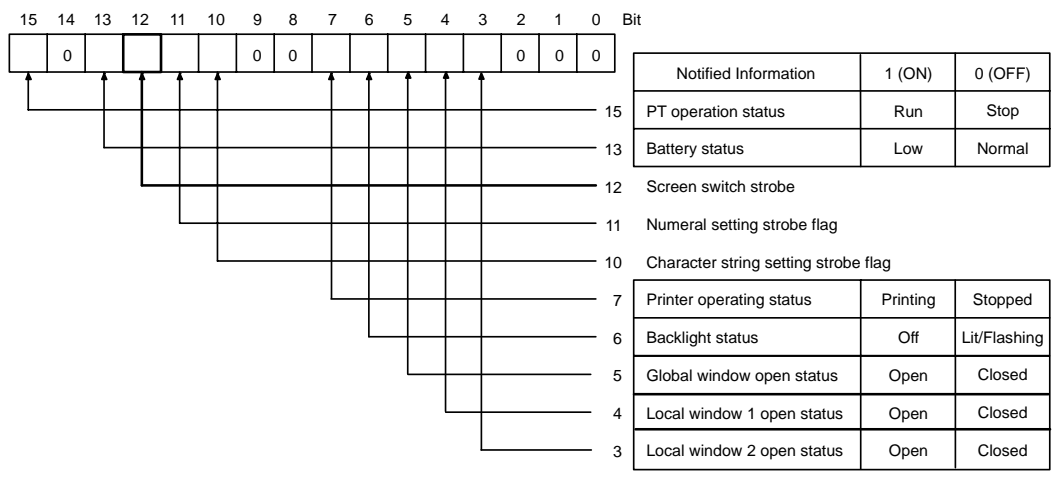

Bit 7 is not supported by the NT21.

Make a program that runs in the host so that leading edge of bit 12 (screen switching strobe) in the second word (word m + 1) from the beginning of the PT status notify area is checked.

If this bit changes to 1 (ON), it indicates that the screen has been switched by operation at the PT.

Reference: The screen switching strobe automatically returns to 0 (OFF) when the occurrence of the event is notified to the host.

Notifying the Screen Number

The area for the screen switch command and notification of the screen number is provided at the beginning (word n) of the PT status notify area.

	15	14	13	12	11	10	9	8	7	6	5	4	3	2	1	0	Bit
Word n	Screen No. (4-digit BCD or hexadecimal)												Screen switch setting				
n + 1	Copy source memory table entry number (4-digit BCD or hexadecimal)												Copy memory table setting				
n + 2	Copy destination memory table entry number (4-digit BCD or hexadecimal)																
n + 3					PT status control bits								PT status control				
n + 4	Reserved for system use																

The configuration and functions of these words are different when the PT is in NT20S or NT30/620 compatible mode.

Read out the beginning (word n) of the PT status control area with the program in the host.

The screen number of the screen displayed at the PT is stored in a 4-digit BCD or a 4-digit hexadecimal. Whether BCD or hexadecimal notation is to be used is set for Numeral Storage Type of PT Configuration at the Support Tool. Refer to 2-19 *PT Configuration Settings* (page 285) for settings related to the PT environment.

Reference: While the PT is running, the screen number of the currently displayed screen is always recorded in the screen switch setting word in the PT status control area (except when the screen displayed is an error screen or the System Menu screen, in which case the screen number of the screen displayed immediately before remains recorded).

Example of Use

An example of a PC program that reads the screen number each time the screen is switched by the PT is described below. This example program stores the previous screen number also.

Setting with the Support Tool

Set the following words with the Support Tool.

- Allocated word in the PT status control area: 00100 (word 100 in the CIO area)
- Allocated word in the PT status notify area: 00110 (word 110 in the CIO area)

PC Program

Create the PC ladder program as indicated below.

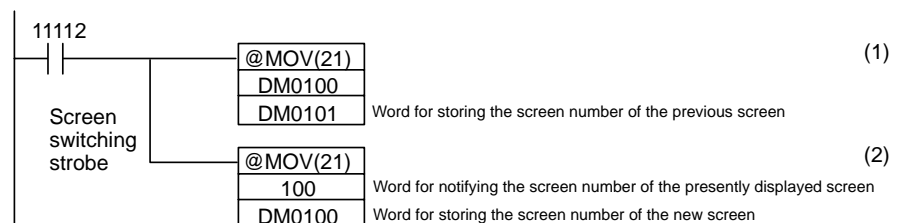

Program Operation

- 1, 2, 3...**
1. When the screen switching strobe (bit 11112) comes ON as the screen is switched by operation at the PT, the program transmits the data at DM0100 to DM0101. The previous screen number is saved to the word provided for that purpose.
 2. The program reads out the new screen number that was notified to the PT to transmit it to DM0100. The screen number of the screen presently displayed at the PT is stored to DM0100.

3-4 Display and Control of Windows

A window means a partial screen that can be displayed on the presently displayed screen (base screen).

A window can be created by registering a screen under a screen number from 1 to 3999 as a window screen.

This section describes the following types of operation that can be performed for a window.

- Opening/closing/moving a window
- Checking the display status of a window
- Disabling/enabling the opening of a window

Reference: • Window screen is called window/keyboard screen at the Support Tool.

- Window has the following two types.

Global window:

Local window:

3-4-1 Opening/Closing/Moving a Window

The PT provides the following methods to open/close/move a window.

- Pressing a touch switch that has the input key-window/keyboard function. (Opening/closing are possible)
- Pressing a touch switch that has the cursor moving key function. (window opening only)
- Pressing a touch switch that has the window moving key function. (window moving only)
- Controlling the window by the operation of the window control area from the host (Window opening/closing/moving are possible)
- Setting Load Local 1 (Keyboard), Load Local 2 screen attribute for a standard screen and perform screen switch. (window opening only)

-
- Reference:**
- If 1 (disable) is set for the window opening PT status control bit, it is not possible to open a window by operation at the PT. (Closing of a window is allowed.)
 - Touch switch operation will be disabled when the touch switch interlock function is being used and the host's interlock bit that controls the touch switch's operation is OFF. (See *Disabling Touch Switches with Interlock Bits* on page 369 for details.)
 - If the window for which open is specified is not a window screen, the window open command is disregarded.
 - When creating a screen with the Support Tool, it is possible to designate a window that is opened at the same time the screen is displayed (set with the Load Window/Keyboard Screen attribute of Screen Property).
-

Opening/Closing a Window by Pressing a Touch Switch That Has the Input Key – Keyboard Function

If this method is used, the specified window can be opened and closed by operation at the PT.

By this method, only the local window can be controlled.

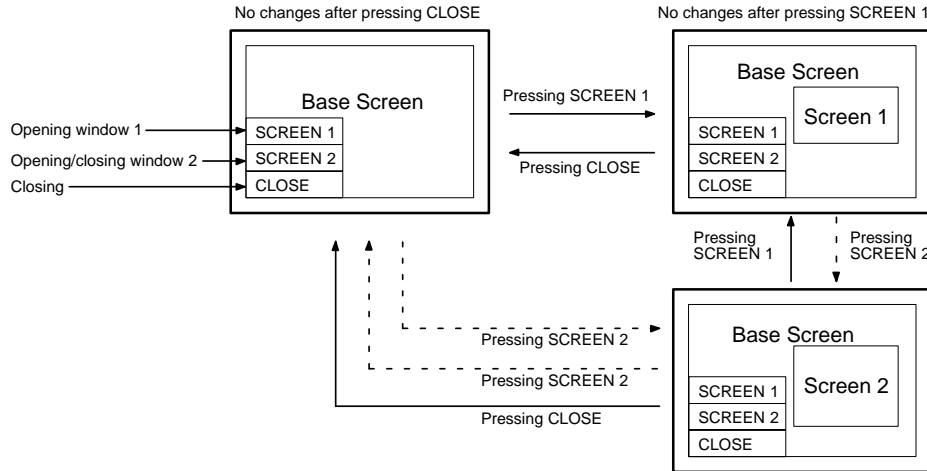

Setting

When creating a screen, set the input key – keyboard function that opens/closes a window for the touch switch and specify the window screen number (keyboard screen number) of the window to be opened. Register the window number for the screen.

The window screen numbers that can be set are:

0001 to 3999: Screen (keyboard screen) No. 1 to No. 3999

Reference: If the specified number is not the number of a window screen, no window opens.

Operation

Press a touch switch that has the input key – keyboard function to open/close a window.

The window set for the touch switch opens.

Reference: When words are allocated for the window control area in the host, window screen number and the bottom left coordinate of the window that is opened are notified to the window control area. (Refer to page 313)

Also, window open status bit of the corresponding window type in PT status notify area goes ON. (Refer to page 313)

Opening/Closing a Window by Pressing a Touch Switch That Has the Cursor Moving Function

It is possible to give a cursor moving key, which is used to specify numeral or character string input fields, the function of opening a window.

By this method, only the local window can be controlled.

In this method, a specific window (keyboard screen) can be opened at the same time as a numeral or character string input field is specified by operation at the PT.

When a cursor moving key is used, the window opens in the same manner as an input key-window/keyboard function that has open action type.

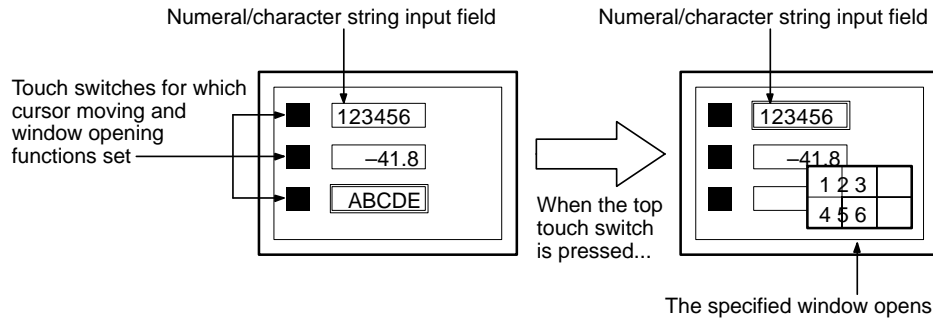

Setting

When creating a screen using the Support Tool, set the cursor moving function for a touch switch and specify the input field. Then, specify the window number of the window screen (keyboard screen) to be displayed at the same time and register them for the screen.

The window screen numbers that can be set are:

0001 to 3999: Screen (keyboard screen) No. 1 to No. 3999

Reference: If the specified number is not the number of a window screen, no window opens.

Operation

Press the touch switch that has the cursor moving function to specify the numeral/character string input field. The specified window is automatically opened.

Reference: When a window control area is allocated words in the host, window screen number and the bottom left coordinate of the window that is opened are notified to the window control area. (Refer to page 313)

Also, window open status bit of the corresponding window type in PT status notify area goes ON. (Refer to page 313)

Opening a Window by Pressing a Touch Switch That Has the Window Moving Function

In this method, a window can be moved by operation at the PT.

By this method, only the local window can be controlled.

Setting

When creating a screen using the Support Tool, set the window moving function for a touch switch and register it for the window to be moved.

Operation

- 1, 2, 3... 1. Press the touch switch that has the window moving function on the window to be moved.
The window is changed to a frame display only with a + mark at the center of it.
2. Press the touch panel of PT at a destination position of the window.
Window is moved to that position. (The center position of the window comes to the pressed position.)

If the window is going to extend out the screen boundary with the specified position, the position of the window is automatically adjusted so that the window comes within the screen.

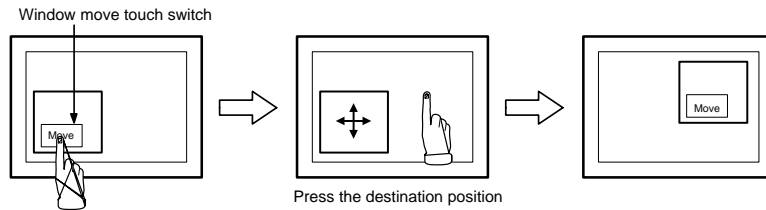

Reference: When a window control area is allocated words in the host, the bottom left coordinate of the window after moving operation is notified to the window control area. (Refer to page 313)

Opening/Closing/Moving a Window by the Operation of Window Control Area

If this method is used, the window can be opened, closed and moved by operation from the host.

By this method, both the global window and local window can be controlled.

Setting

To use a window control area, allocate words for the window control area in the host when creating a screen using the Support Tool.

Operation

In the window control area, the following three words are provided for each global window, local window 1 and local window 2.

Word	15	14	13	12	11	10	9	8	7	6	5	4	3	2	1	0	Bit
k	Screen No. (4-digit BCD or hexadecimal)																Global window
k+1	X coordinate (4-digit BCD or hexadecimal)																
k+2	Y coordinate (4-digit BCD or hexadecimal)																
k+3	Screen No. (4-digit BCD or hexadecimal)																Local Window1
k+4	X coordinate (4-digit BCD or hexadecimal)																
k+5	Y coordinate (4-digit BCD or hexadecimal)																
k+6	Screen No. (4-digit BCD or hexadecimal)																Local Window2
k+7	X coordinate (4-digit BCD or hexadecimal)																
k+8	Y coordinate (4-digit BCD or hexadecimal)																

To control a window, operate the window control area as follows:

- 1, 2, 3...**
1. To open a window, write window screen number in 4-digit BCD or hexadecimal to window screen number of the window type to be used. Then, write the coordinate of window (bottom left coordinate of the window) in 4-digit BCD or hexadecimal to X coordinate and Y coordinate. Which of BCD or hexadecimal is used is determined by the setting of Tools – PT Configuration – System – Numeral Storage Type at the Support Tool.

The window screen numbers that can be set are:

0001 to 3999: Screen (keyboard screen number) 1 to 3999

The coordinates that can be set are:

PT model	Allowed settings
NT21	X coordinate: 0000 to 0240 (0000 to 00F0 hexadecimal) Y coordinate: 0019 to 0139 (0013 to 008B hexadecimal)
NT31/NT31C	X coordinate: 0000 to 0300 (0000 to 012C hexadecimal) Y coordinate: 0019 to 0239 (0013 to 00EF hexadecimal)
NT631/NT631C	X coordinate: 0000 to 0620 (0000 to 026C hexadecimal) Y coordinate: 0019 to 0479 (0013 to 01DF hexadecimal)

- Reference:**
- When a new window is opened (when a window screen number is changed from 0000), window open status bit of the corresponding window type in PT status notify area goes ON. (Refer to page 313) However, when a window that is already opened is switched (when a window screen number is changed), window open status bit does not change.
 - The position on which a window is actually displayed is by 20 dot unit. When the X coordinate is not multiple of 20 or when Y coordinate is not multiple of 20 – 1, the specification is disregarded. (In case of moving operation, nothing is executed. In case of opening a new window, the window is displayed at the position that was specified when it was created.)
This rule also applies when the specification is made so that the window is going to extend out the screen boundary with the specified value.
 - If the specified number is not the number of a window screen, no window is opened, and window screen number in window control area is returned to 0000, consequently, the window is closed.
 - Displayed window is switched when the window screen number of presently displayed screen is changed.

2. To move the position of a presently displayed window, write the new coordinate to X coordinate and Y coordinate in the window control area that corresponds to the window.
The values that can be specified are same as for (1) (open).
3. To close a presently displayed window, write 0000 to window screen number in the window control area that corresponds to the window.
Window is closed, however, X coordinate and Y coordinate retain existing values.

- Reference:**
- When a window is closed, window open status bit of the corresponding window type in the PT status notify area goes OFF. (Refer to page 313)
 - When NT20S or NT30/620 compatible mode is being used, the word containing the PT status notify bits is shifted down one word. (Refer to page 457.)

Opening a Window by Setting Load Local 1 (Keyboard) or Load Local 2 Screen Attribute

If this method is used, the specified window can be opened automatically at the same time the screen is displayed by setting the screen number of the local window to be displayed for a screen attribute of a standard screen.

Each time the screen is switched to the one for which Load Local 1 (Keyboard) or Load Local 2 screen attribute is set, the specified window opens.

By this method, only the local window can be opened. It is not possible to open a global window.

Setting

When creating a screen using the Support Tool, set Load Local 1 (Keyboard) or Load Local 2 for a screen attribute.

- Reference:** If the specified number is not the number of a window screen, no window opens.

Operation

- 1, 2, 3... 1. Switch to a screen for which Load Local 1 (Keyboard) or Load Local 2 screen attribute is set.
2. The set window opens. The window is opened by the size and at the position that was specified when it was created.

- Reference:**
- When a window control area is allocated words in the host, window screen number and the bottom left coordinate of the window that is opened are notified to the window control area. (Refer to page 313)
Also, window open status bit of the corresponding window type in PT status notify area goes ON. (Refer to page 313)
 - When NT20S or NT30/620 compatible mode is being used, the word containing the PT status notify bits is shifted down one word. (Refer to page 457.)

3. When the screen is switched to others, the window is closed.

3-4-2 Checking the Display Status of a Window

PT has a function to notify the open/close status of a window, the screen number and the position of presently displayed window to a host when the display status of a window is switched.

It is possible to know the occurrence of opening/closing of a window, window screen number and the display position from the host by the following method.

- Reading out the contents of PT status notify area and PT status control area

Reference: When NT20S or NT30/620 compatible mode is being used, the word containing the PT status notify bits is shifted down one word. (Refer to 457.)

Reading Out the Contents of PT Status Notify Area and PT Status Control Area

Display status of a window is always written to the following areas

Opening/Closing status of a window:

Window open status in PT status notify area

Screen number of a presently displayed window:

Window screen number in window control area

Position of a presently displayed window (bottom left coordinate):

X coordinate and Y coordinate in window control area

Setting

The PT status notify area must be allocated words in the host. No special settings are required for the control of a window.

To use a window control area, allocate words for the window control area in the host when creating a screen using the Support Tool.

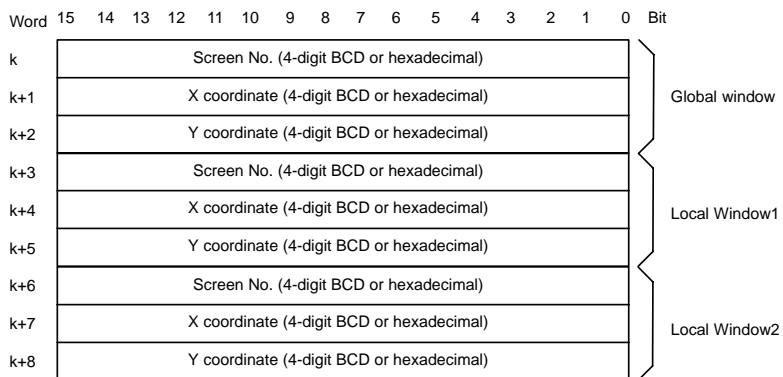

Operation

To check the display status of a window, operate as follows:

Reading Out the Opening/Closing Status of a Window

The bit for notifying the PT status (PT status notify bit) is provided at the second word (word m + 1) from the beginning of the PT status notify area.

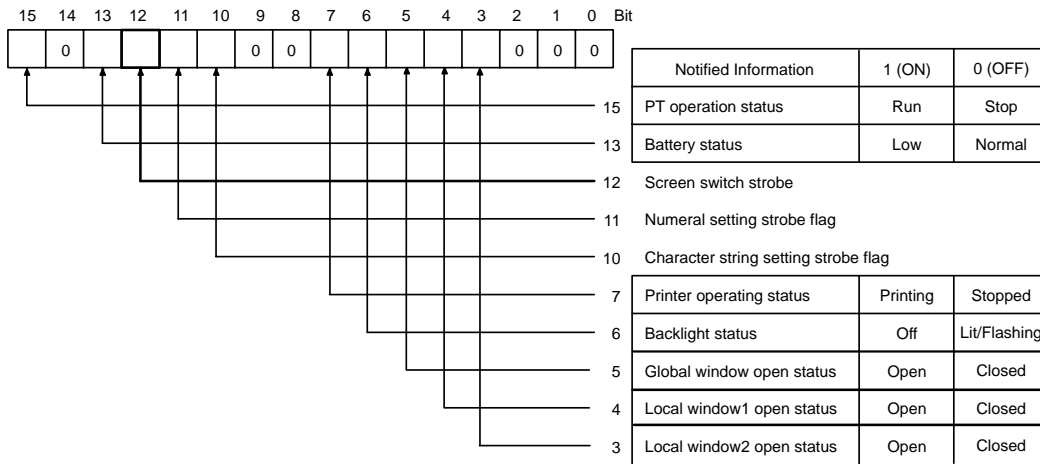

Bit 7 is not supported by the NT21.

Check the bits from 3 to 5 of the second word (word m + 1) from the beginning of the PT status notify area with the program in the host.

The status of each bit and the correspondence to a window are as follows:

Bit	Name	1 (ON)	0 (OFF)
5	Global window open status	Open	Closed
4	Local window 1 open status	Open	Closed
3	Local window 2 open status	Open	Closed

By checking the status of the bit shift, it is possible to know the occurrence of opening/closing of the window.

Notification of Window Screen Number and Coordinates

In the window control area, the following three words are provided for each global window, local window 1 and local window 2.

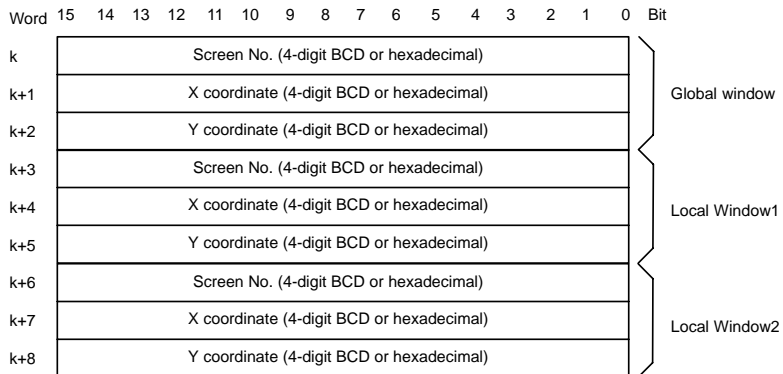

With the program in the host, read out window screen number, X coordinate and Y coordinate in a window control area that corresponds to the window of which display status is to be checked.

The window screen number and bottom left X, Y coordinates of the window that is presently displayed on the PT are stored in 4-digit BCD or hexadecimal. Which of BCD or hexadecimal is used is determined by the setting of Numeral Storage Type in PT Configuration at the Support Tool.

When the window is not displayed, 0000 is stored in window screen number. In the case of global window, however, when the screen other than user screen

(such as system menu or error screen) is displayed, the window is automatically closed, but the window screen number retains the existing value.

The value in a window control area is effective only when the window is displayed.

Reference: Display status of the window is always written to a window control area during the operation of the PT.

3-4-3 Disabling/Enabling the Opening of a Window

Opening of a window by operation at the PT can be enabled/disabled by using the method indicated below.

Controlling the window by operation at the PT status control area

Controlling the Window by Operation at the PT Status Control Area

This method allows the opening of a window by operation at the PT to be disabled. (Even if the opening of a window is disabled, it is possible to close the window by operation at the PT, or to move a window by a touch switch operation that has window move function. Also, opening/closing/moving a window by operation of the window control area is always possible.)

Setting

Words must be allocated for the PT status control area in the host. No special settings are required for the control of a window.

Operation

The bit for controlling the PT status (PT status control bit) is provided at the fourth word (word n + 3) from the beginning of the PT status control area.

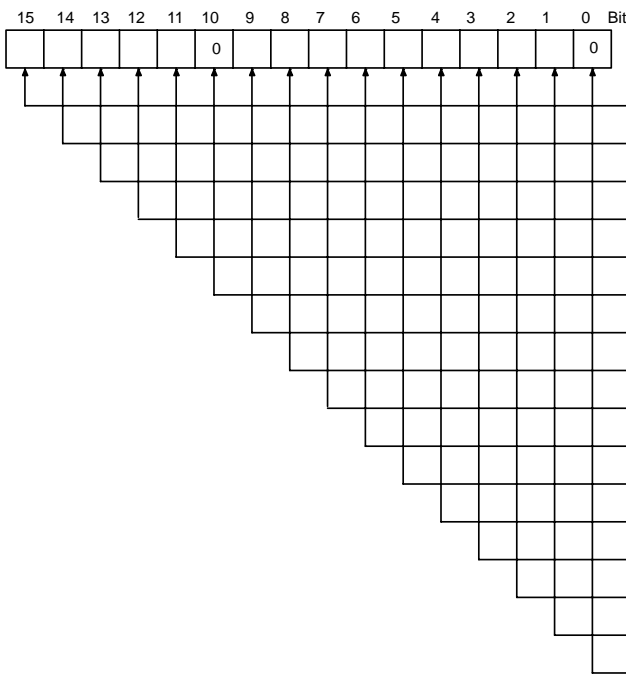

Controlled Item	1 (ON)	0 (OFF)
Screen display	Performed	Not performed
Processing priority registration (for NT link (1:N))	Registered	Canceled
Continuous buzzer	Sounded	Stopped
Intermittent buzzer (short)	Sounded	Stopped
Display history initialization	Performed	Not performed
Not used	Always 0	
Intermittent buzzer (long)	Sounded	Stopped
Backlight mode	Lit	Flashing
Screen printing	Performed	Not performed
PT window opening	Disabled	Enabled
Numeral/character string input	Disabled	Enabled
PT screen switching	Disabled	Enabled
Memory table copy execution	Performed	Not performed
Memory table copy type	Numeral	Character string
Alarm history initialization	Performed	Not performed
Not used	Always 0	

Bits 2 and 3 are not used when the PT is in NT20S or NT30/620 compatible mode.
Bit 7 is not supported by the NT21.

To disable the opening of a window by operation at the PT during the operation of the PT, operate the PT status control area as indicated below.

Set 1 (ON) for bit 6 in the fourth word (word n + 3) from the beginning of the PT status control area.

3-5 Changing Numeral and Character String Display

This section describes the procedure(s) for changing the contents of the numeral and character string memory table entries that are allocated words in the host and also the procedure for changing the display on the PT by operation at the host.

For the procedure for displaying the contents of the numeral and character string memory table entries at the PT, refer to 2-8 Numeral Display (page 140) and 2-9 Character String Display (page 148).

3-5-1 Changing Numeric Values and Character Strings

The PT provides the following methods for changing the contents in the numeral and character string memory table entries.

- Changing the contents of the allocated word of a numeral memory table
- Changing the contents of the allocated word of a character string memory table
- Copying the contents by operation at the PT status control area
- Pressing a touch switch that has the Copy Setting function

Reference: It is possible to input the data to numeral memory table entries and character string memory table entries by operation at the PT using the numeral setting function and the character string setting function.

For details of this operation, refer to 3-7 Input of Numeric Values and Character Strings (page 328).

Changing the Contents of the Allocated Word of a Numeral Memory Table

By allocating a word for a numeral table entry in the host, it is easy to reflect changes made at the word in the host to the numeral memory table.

With this method, however, only the contents of the allocated words of memory table entries being used for display on the current screen of the PT can be read out. Contents of an allocated word that is not related to the display are not read out.

Direct Specification

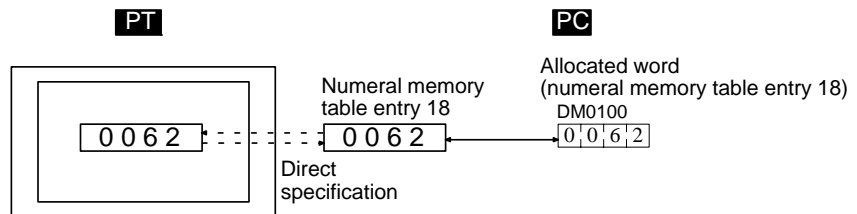

Indirect Specification

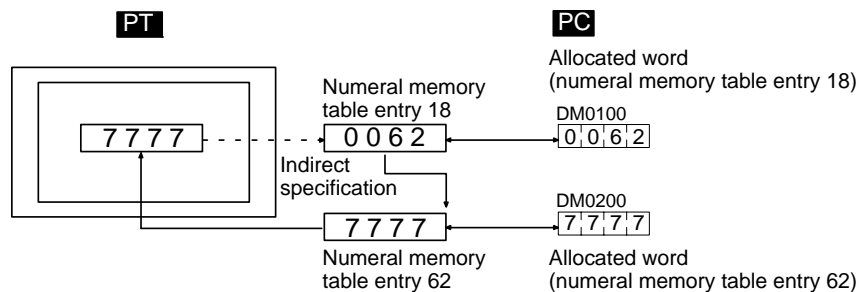

Setting

When creating a screen using the Support Tool, set the allocated word for the numeral memory table. When making this setting, the Words and Storage Type settings must be taken into careful consideration.

Reference: The range of numeral memory table entry numbers that can actually be used depends on the number of numeral memory table entries set for Tools – PT Configuration – System setting at the Support Tool.

Operation

Change the contents of the word in the host allocated for the numeral memory table entry.

The contents of the word are reflected to the numeral memory table entry according to the setting of the numeral memory table entry.

Note that the contents of a numeral memory table entry allocated word can only be read out when the memory table entry is being used for an element that is currently displayed by the PT (if the background function is set for a trend graph, the contents of the corresponding word are always read out). The contents of an allocated word that is not related to the display are not read out.

Example of Use

Direct Specification

An example of displaying the contents of a PC word allocated for a numeral memory table entry as they are is shown below. The display on the PT screen changes as the contents of the PC word change.

Setting at the Support Tool

Set as indicated below using the Support Tool.

- Numeral memory table entry 1:
D0000 (Words: 2, Storage Type: BCD)
- Numeral memory table entry 2:
D0002 (Words: 1, Storage Type: BCD)
- Contents to be registered for the screen:
Numeral display (numeral memory table entries 1 and 2)

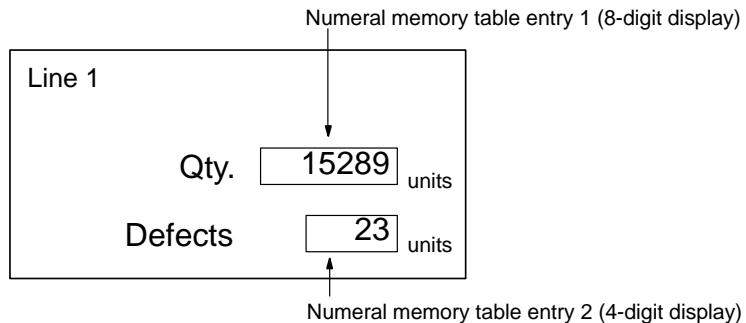

PC Program

Make a PC program as shown below.

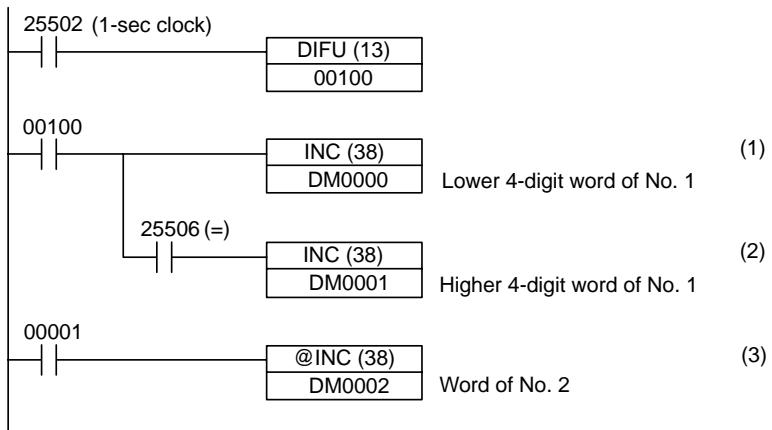

Program Operation

- 1, 2, 3...
1. The value 1 is added to the contents of D0000 every second. At the PT, the displayed value of the numeral memory table entry 1 increases by 1 every second.
 2. Each time carry over occurs during processing at (1) above, the contents of D0001 are incremented by 1. At the PT, the value of the higher 4 digits in numeral memory table entry 1 increases by 1.
 3. When bit 00001 comes ON, the value 1 is added to the contents of D0002. At the PT, the displayed value of numeral memory table entry 2 increases by 1.

Indirect Specification

The following shows an example of changing the displayed numeric value by adding a value to the contents of a numeral memory table entry allocated word that is referenced in indirect specification.

Setting at the Support Tool

Set as indicated below using the Support Tool.

- Numeral memory table entry 51:
D0000 (Value: 100, Words: 1, Storage Type: BCD)
- Numeral memory table entry 100:
D0010 (Words: 1, Storage Type: BCD)
- Numeral memory table entry 101:
D0011 (Words: 1, Storage Type: BCD)
- Touch switch (upper):
 - Function setting: Notify Bit
 - PC Address: 0000100
 - Action Type: Momentary
 - Label: TARGET
- Touch switch (lower):
 - Function setting: Notify Bit
 - PC Address: 0000101
 - Action Type: Momentary
 - Label: ACHIEVED
- Contents to be registered for the screen:
Numeral display (numeral memory table entry 51, indirect specification), touch switches (two, indicated above)

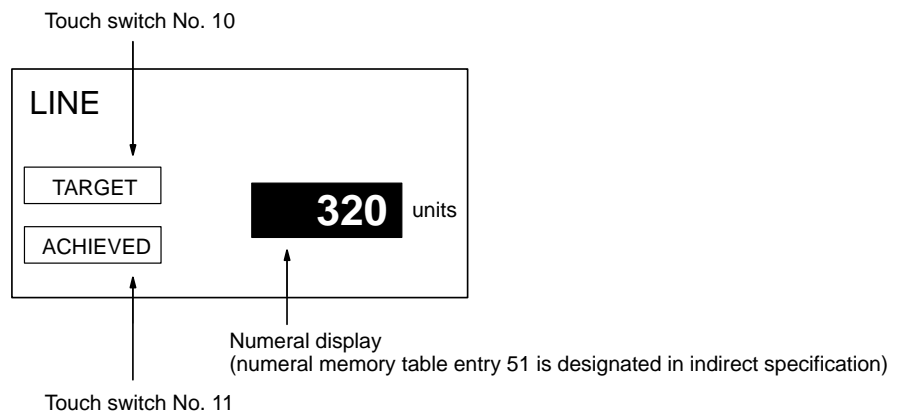

PC Program

Make a PC ladder program as shown below.

The program must also be made so that the value of ACHIEVED is stored to D0010 and the value of TARGET is stored to D0011.

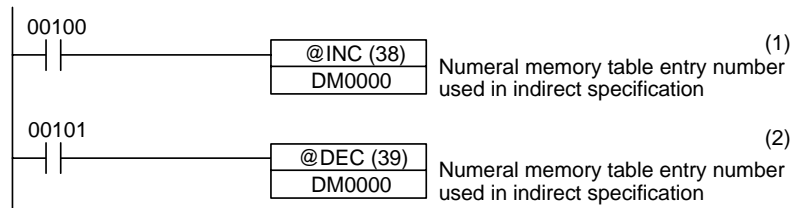

Program Operation

- 1, 2, 3...
1. When TARGET (touch switch No. 10) is pressed, the contents of numeral memory table entry 101 (the value of the target production) is displayed.
 2. When ACHIEVED (touch switch No. 11) is pressed, the contents of numeral memory table entry 100 (the value of the production actually achieved) is displayed.

In this example, the contents of numeral memory table entry 51, which is referenced in indirect specification, is not checked. If the program is actually tested, the contents of numeral memory table entry 51 must not be outside the range of 0100 to 0101.

By using the lamp bit of the touch switch, it is possible to identify which of the numeral memory table entries is used for display. For details, refer to 2-7 *Touch Switches* (page 119).

Changing the Contents of the Character String Memory Table Allocated Word

By allocating words for a character string table entry in the host, changes made at the word in the host can be easily reflected to the character string memory table entry.

With this method, however, the contents of a memory table allocated word can only be read out when the character string memory table entry is being used for an element that is currently displayed by the PT. The contents of an allocated word that is not related to the display is not read out.

When a character code is written to a word at the host, the character code is stored without change in the character string memory table entry. By specifying FF20 to FFFH, it is possible to include marks in character strings.

Character codes stored in words at the host are stored in the following sequence in character string memory table entries.

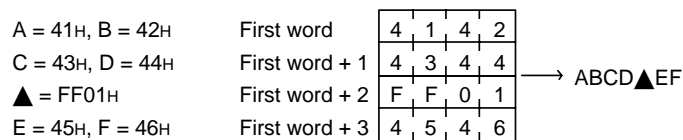

When the code for mark data straddles two words:

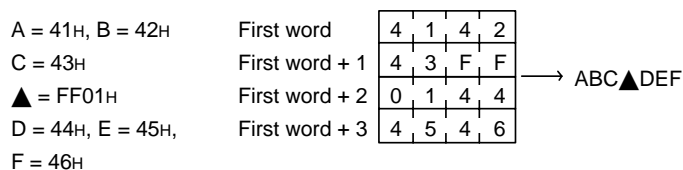

- Reference:**
- If the control code 00H is written to a word, it is displayed as a space by the PT. The character string is displayed only up to this code since it is regarded as the end of the characters. When writing character codes to a word, do not write 00H in a character string.
 - When the PT is set to NT20S or NT30/NT620 compatible mode, image and library codes can be included in character string memory table entries. Be sure to check the size of the image or library display so that it doesn't extend past the edges of the screen when it is displayed. (Refer to page 457.)
 - When the PT reads out the words in a character string memory table entry, it reads the number of words specified in the Words setting. Character strings are not read out beyond this range.

Setting

When creating a screen using the Support Tool, set the allocated words for the character string memory table entry. The Words setting must be set carefully.

- Reference:** The range of character string memory table entry numbers that can actually be used depends on the number of character string memory table entries set in the PT Configuration – System settings at the Support Tool.

Operation

Change the contents of the word in the host allocated for the character string memory table entry.

The contents of the word are reflected to the character string memory table entry according to the setting of the character string memory table entry.

Note that the contents of a character string memory table allocated word can be only be read out when the memory table entry is being used for an element that is currently displayed by the PT. The contents of an allocated word that is not related to the display are not read out.

Example of Use

Direct Specification

An example of displaying the contents of a PC word allocated to a character string memory table entry as they are is shown below. The display on the PT screen changes as the contents of the PC word change. If the system is so configured that the character string is written to the word using a personal computer via a Communications Unit, the required message can be displayed on the PT.

Setting at the Support Tool

Set as indicated below using the Support Tool.

- Character string memory table entry 150:
D00300 (Words: 6)
- Contents to be registered for the screen:
Character string memory table entry 150

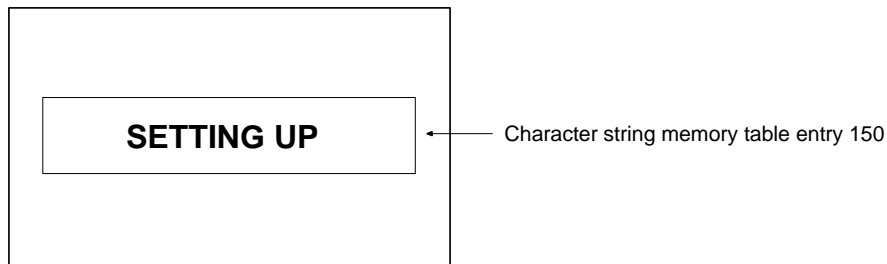

PC Program

When changing the contents of a word using a personal computer, no special ladder program used for controlling the PT is necessary.

Program Operation

The contents of the word are always displayed as a character string.

Indirect Specification

The following shows an example of changing the displayed numeric value by adding a value to the contents of a numeral memory table allocated word that is referenced in indirect specification.

Setting at the Support Tool

Set as indicated below using the Support Tool.

- Numeral memory table entry 51: D00000 (Words: 1), Value: 100
- Character string memory table entry 100: Value: NT631C (6 digits)
- Character string memory table entry 101: Value: NT631 (6 digits)
- Character string memory table entry 102: Value: NT31C (6 digits)
- Character string memory table entry 103: Value: NT31 (6 digits)
- Contents to be registered for the screen: Numeral display (numeral memory table entry 51, indirect specification)

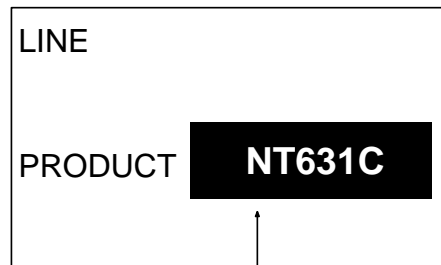

Character string display (numeral memory table entry 51 is designated in indirect specification)

PC Program

Make a PC ladder program as shown below.

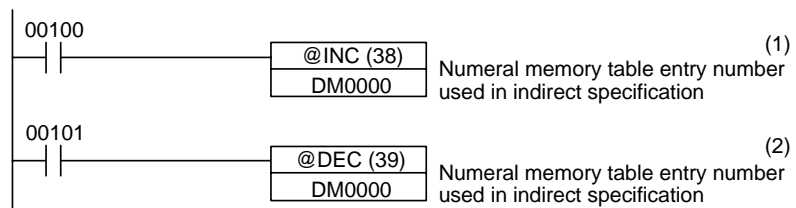

Program Operation

- 1, 2, 3...**
1. The display on the PT changes to the next item in the sequence NT631C → NT631 → NT31C → NT31 each time bit 00100 comes ON.
 2. The display on the PT changes to the next item in the sequence NT31 → NT31C → NT631 → NT631C each time bit 00101 comes ON.

In this example, the contents of numeral memory table entry 51, which is referenced in indirect specification, is not checked. If the program is actually tested, the contents of numeral memory table entry 51 must not be outside the range of 0100 to 0103.

Changing Numerals/Character Strings by Copying the Contents by Operation at the PT Status Control Area

If this method is used, contents can be copied between any required memory table entries at any time in response to a command from the host. Note that this method is possible only for the following combinations.

- Numeral memory table entry → Numeral memory table entry
- Character string memory table entry → Character string memory table entry

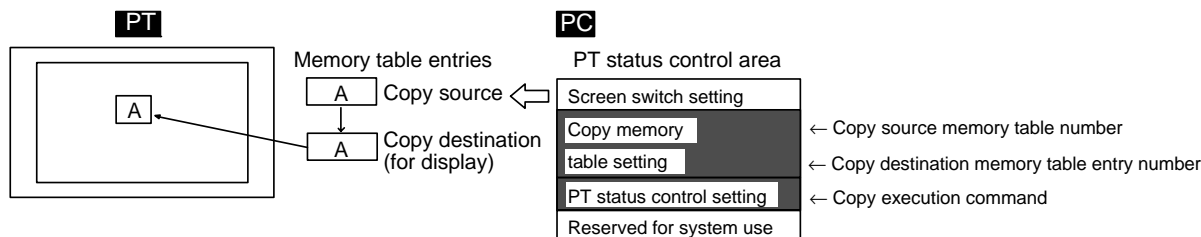

- Reference:**
- If the Words settings differ between the memory table entries (copy source and copy destination table entries), numerals or character strings are copied correctly since 2 words are secured for a numeral memory table entry and 20 words for a character string memory table entry in the PT. If the memory table entry is allocated a word in the host, however, copying may not be executed correctly if the Words settings differ between the memory table entries (copy source and copy destination table entries).
 - When the PT is set to NT20S or NT30/620 compatible mode, copying between memory table entries is performed differently. Refer to *Appendix C* for details on the NT20S and NT30/620 compatible modes.

Setting

Words must be allocated for the PT status control area in the host. No special settings are required for copying the data between memory table entries.

Operation

The following areas are provided in the PT status control area to be used for copying the data between memory table entries.

- 2nd word from the beginning of the area (word n + 1)
Copy source memory table entry number
- 3rd word from the beginning of the area (word n + 2)
Copy destination memory table entry number
- 4th word from the beginning of the area (word n + 3)
Memory table entry type (bit 2) and PT status control bit that instructs the execution of copying (bit 3)

(n: Beginning word address of the PT status control area)

Word	15	14	13	12	11	10	9	8	7	6	5	4	3	2	1	0	Bit
n	Screen No. (4-digit BCD or hexadecimal)																Screen switch setting
n+1	Copy source memory table entry number (4-digit BCD or hexadecimal)																Copy memory table entry setting
n+2	Copy destination memory table entry number. (4-digit BCD or hexadecimal)																
n+3	PT status control bits																PT status control
n+4	Reserved for system use																

The configuration and functions of these words are different when the PT is in NT20S or NT30/620 compatible mode.

PT Status Control (word n + 3)

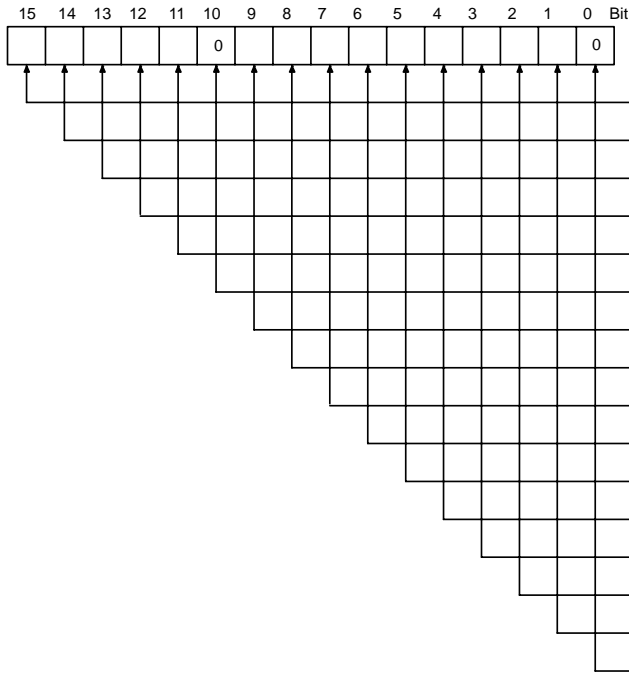

Controlled Item	1 (ON)	0 (OFF)
15 Screen display	Performed	Not performed
14 Processing priority registration (for NT link (1:N))	Registered	Canceled
13 Continuous buzzer	Sounded	Stopped
12 Intermittent buzzer (short)	Sounded	Stopped
11 Display history initialization	Performed	Not performed
10 Not used	Always 0	
9 Intermittent buzzer (long)	Sounded	Stopped
8 Backlight mode	Lit	Flashing
7 Screen printing	Performed	Not performed
6 PT window opening	Disabled	Enabled
5 Numeral/character string input	Disabled	Enabled
4 PT screen switching	Disabled	Enabled
3 Memory table copy execution	Performed	Not performed
2 Memory table copy type	Numeral	Character string
1 Alarm history initialization	Performed	Not performed
0 Not used	Always 0	

Bits 2 and 3 are not used when the PT is in NT20S or NT30/620 compatible mode.
 Bit 7 is not supported by the NT21.

Operate the PT status control area in the manner shown below to copy data between memory table entries.

- 1, 2, 3...**
- Write the memory table entry numbers in the PT status control area as indicated below in either 4-digit BCD or 4-digit hexadecimal. Which of the BCD and hexadecimal notations is used is determined by the setting for PT Configuration – Storage Type made at the Support Tool.
 - 2nd word from the beginning (word n + 1)
0000 to 1999: Copy source memory table entry number (0 to 1999)
 - 3rd word from the beginning (word n + 2)
0000 to 1999: Copy destination memory table entry number (0 to 1999)

Reference: The range of numeral/character string memory table entry numbers that can actually be used depends on the number of numeral memory table entries and the character string table entries set in PT Configuration – System setting at the Support Tool.

- Set bit 2 of the 4th word (word n + 3) from the beginning of the PT status control area as indicated below to match the type of memory table entry for which copying is to be executed.
 Memory table entry type: Bit 2
 - Character string memory table entry: 0 (OFF)
 - Numeral memory table entry: 1 (ON)
- Set 1 (ON) for bit 3 of the 4th word (word n + 3) from the beginning of the PT status control area.

Data copy is executed between the specified type and specified numbers of memory table entries. If the copy destination table entry is allocated a word in the host, the contents at the word in the host are also changed. Then, the occurrence of a change in the contents of the memory table entry is notified to the PT status notify area.

4. After the execution of memory table copying, return the setting for bit 3 of the 4th word (word n + 3) from the beginning of the PT status control area to 0 (OFF).

Example of Use

Setting at the Support Tool

Set the word and the contents with the Support Tool as indicated below.

- Allocated word in the PT status control area:
00100 (word 100 in the CIO area)
- Contents to be registered for the screen:
Character string memory table entry 4

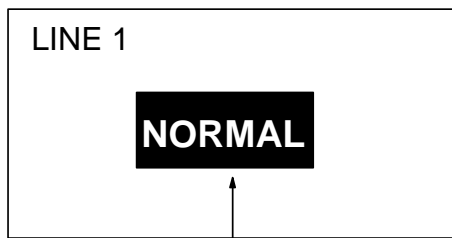

Character string memory table entry 4

Contents of setting in character string memory table entries

No.	Contents	Number of digits
4	NORMAL	4 digits
10	FAULT	4 digits
11	NORMAL	4 digits

PC Program

Make a PC ladder program as shown below.

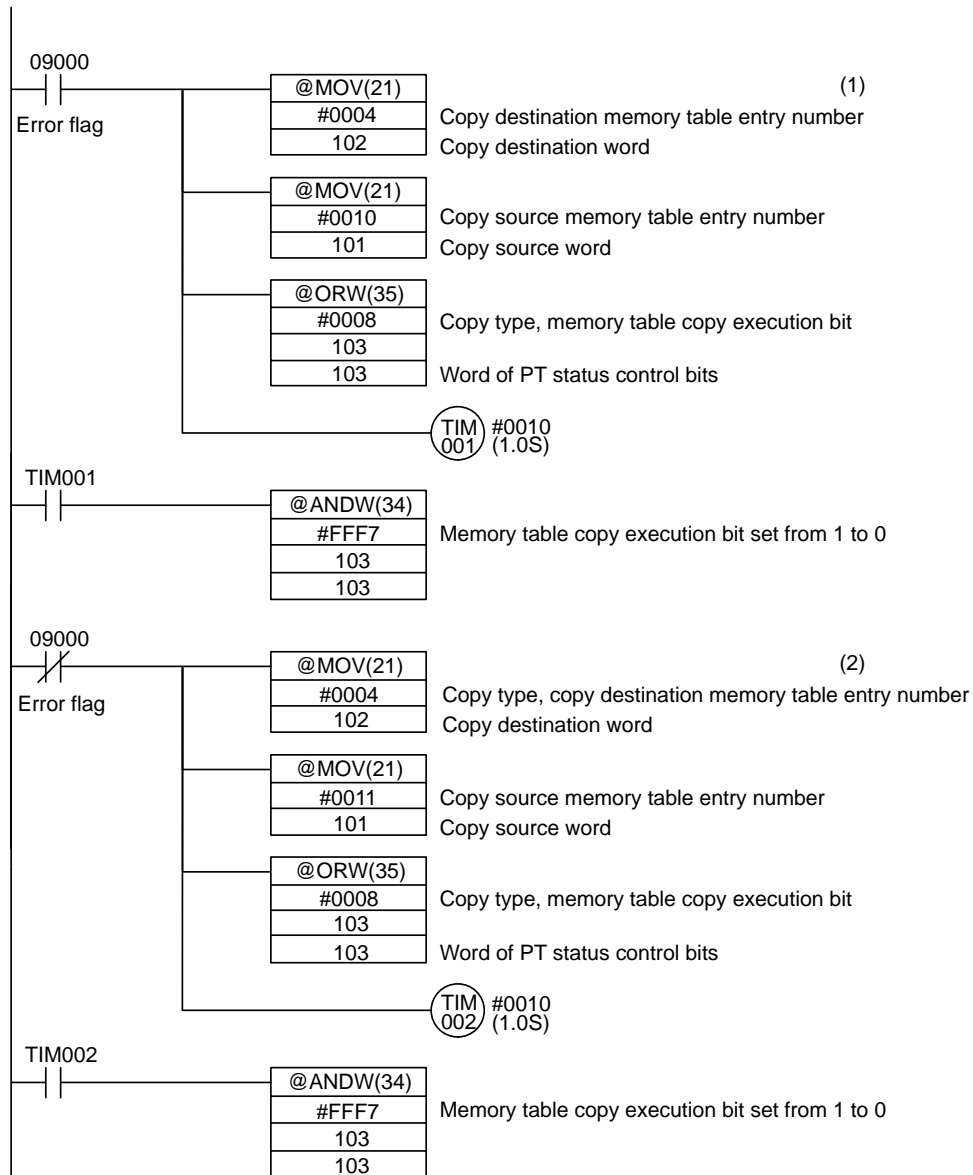

Program Operation

- 1, 2, 3...
1. If an error occurs (bit 09000 goes ON), the display on the PT changes to FAULT.
 2. When the error is eliminated (bit 09000 goes OFF), the display on the PT returns to NORMAL.

Changing Numerals/Character Strings by Pressing a Touch Switch That Has the Copy Setting Function

This method allows an operator to change the contents of a memory table entry simply by operation at the PT. It is also possible to copy data to a numeral setting/character string input field by using this method. With the Copy Setting function, data can only be copied in accordance with the predetermined method.

The touch switch Copy Setting function executes copying in the following combinations.

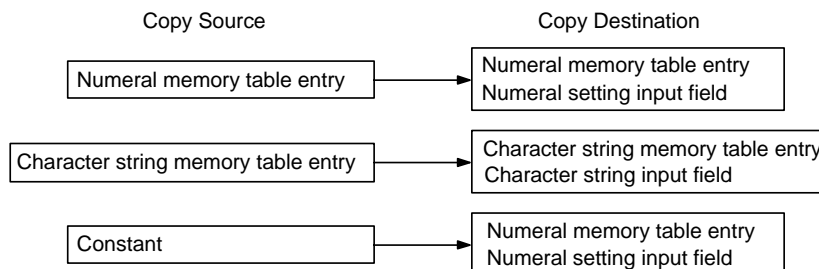

Example: A touch switch with the Copy Setting function is used to reset a counter.

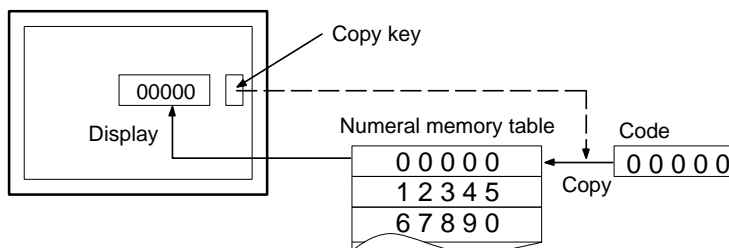

Reference: Touch switch operation will be disabled when the touch switch interlock function is being used and the host’s interlock bit that controls the touch switch’s operation is OFF. (See *Disabling Touch Switches with Interlock Bits* on page 369 for details.)

Setting

When creating a screen using the Support Tool, set the Copy Setting function for a touch switch. Specify the copy source and copy destination memory table numbers, values and input field, then register them for the screen.

The numbers and values that can be specified are:

- Memory table entry:
0000 to 1999: Numeral/character string memory table entry number (0 to 1999)
- Constant:
-2147483648 to 2147483647
- Input field:
Specify an input field already registered for the screen.

Reference: The range of numeral/character string memory table entry numbers that can actually be used depends on the number of numeral memory table entries and the character string table entries set in PT Configuration – System setting at the Support Tool.

Operation

Press the touch switch with the Copy Setting function to copy data.

Reference: If the contents of the numeral/character string memory table entry have been changed by operation at the PT, by using the copy key, etc., this event is notified to the PT status notify area in the host (page 61).

3-6 Display of Graphs

This section describes the method for changing the graph display that shows the contents of numeral memory table entry, taking the trend graph as an example. For details of changing the contents of numeral memory table entry, refer to 3-5 *Changing Numeral and Character String Display* (page 316).

3-6-1 Changing the Trend Graph Display

For details of the graph, refer to 2-10 *Graphs* (page 154).

Setting

When creating the screen using the Support Tool, register a trend graph for the screen and set a check mark for the data logging function, with the setting for displaying special touch switches. The special touch switches will then be automatically attached to the screen. The position of these special touch switches can be moved using the element editing function of the Support Tool.

Operation

Press the touch switch that has the required function.

The trend graph display changes according to the function of the pressed touch switch. For the examples of actual applications using the data logging function of trend graph, refer to *Continuously Reading Out the Contents of a PC Word and Displaying a Trend Graph by Backtracking* (page 412).

3-7 Input of Numeric Values and Character Strings

The procedure for inputting numeric values and character strings by operation at the PT is described below.

3-7-1 Inputting a Numeric Value

Numeric values can be input with a numeral input field or thumbwheel switch, as shown in the following diagram.

Numeral Input Field

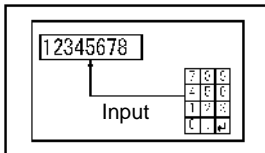

This method uses just an input field. Use the touch switch control keys as a decimal keypad and input values just as you would on a calculator.

Thumbwheel Switch

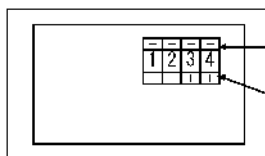

- Each digit is decremented by 1 each time its - Key is pressed.
- Each digit is incremented by 1 each time its + Key is pressed.

This method uses the increment and decrement keys (+ and -) on the thumbwheel switch to change those values.

Two or more input fields and thumbwheel switches can be positioned in a single screen. When more than one input field is used, it is necessary to use a control key or arrow key to specify which input field is operated by the keypad.

It is also possible to place the control key used to specify the input field in a window or keyboard screen. Various inputs can be handled by registering control keys in windows according to their type and switching to the desired window when necessary.

It is also possible to register a temporary input field in a window for numerical input. When a temporary input field like this is being used, the values can be confirmed as they are input to prevent the corresponding input field from being changed before the numerical value is entered completely. (If the value is confirmed in the temporary input window, the confirmed value is written to the input field in the main screen.)

This section describes the following operations. Refer to the explanations when needed.

- Basic key operations for numerical inputs
 - See Inputting Numeric Values Using the Input Key – Control on the Same Screen on page 329.
- Specifying an input field when several input fields are used
 - See Cases Where Multiple Numeral Setting Input Fields Exist on a Screen (Without Cursor Moving Keys) on page 332.
 - See Cases When Multiple Numeral Setting Input Fields Exist on a Screen (With Cursor Moving Keys) on page 334.
- Using control keys in windows
 - See Inputting Numeric Values Using the Input Key – Control in a Window on page 335.
- Using temporary input fields
 - See Inputting Numeric Values Using the Temporary Input Field on page 337.
- Using thumbwheel switches
 - See Inputting Numeric Values Using a Thumbwheel Type Input Field on page 341.

- Reference:**
- Inputs to input fields and thumbwheel switches can be disabled by setting the interlock function and turning OFF the host's interlock bit that controls the input. (Refer to page 369.)
 - Likewise, the interlock function can be set for touch switches and the touch switch's operation can be disabled by turning OFF the host's interlock bit that controls the touch switch. (See *Controlling PT Operations with Interlock Bits* on page 369 for details.) Check the status of the interlock bits allocated to control touch switches before inputting numerical values.

Inputting Numeric Values Using the Input Key – Control on the Same Screen

The following describes the basic numeric value input procedure using the input key – control on the same screen. The explanation of the procedure for inputting a numeric value into the numeral setting input field assumes that there is only one input field on the screen.

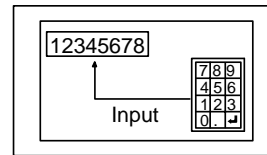



- Reference:** It is possible to copy a constant or contents in a numeral memory table entry to a numeral setting input field using the touch switch Copy Setting function (page 326).

Setting

When creating a screen using the Support Tool, set the elements indicated below on the screen.

- Numeral setting input field (numeric key type)
- Touch switch input key – control
 - 0 to 9
 - A to F (only for the numeral setting input field of the hexadecimal display format)
 - ENT or  (necessary for confirming the input)

The following keys can be registered if necessary.

- CLR (for clearing the numeric value being input)
- \pm (necessary for inputting a negative value)
- . (necessary for inputting a decimal fraction)
- CA (for canceling the input)
- BS (for deleting a character located immediately before the input cursor)
- DEL (for deleting a character located immediately after the input cursor)
-  and  (for moving the input cursor)

Operation

- 1, 2, 3...**
1. Display the screen where a numeral setting input field is registered.
 2. Input a numeric value using the input key – control.
For the procedure for inputting a numeric value, refer to *Inputting Operation Using Touch Switches* (page 330).

- Reference:** When the screen has only one numeral setting input field, that input field is specified automatically. It is not necessary to specify it as the active numeral setting input field.

- Press the ENT key of the input key – control or the  key to confirm the input. When the input is confirmed, the input numeric value is stored to a numeral memory table entry. Then, the occurrence of a change in the contents of the numeral memory table entry is notified to the host via the PT status notify area (page 61).

- Reference:**
- When a numeric value is confirmed the PT checks whether the value falls within the specified upper and lower limit values. If the numeric value is outside the specified range, the buzzer sounds three times, the input numeric value is canceled, and the screen returns to the display before starting the input. In this case, neither writing to a numeral memory table entry nor notification to the host is executed.
 - When NT20S or NT30/620 compatible mode is being used, the current screen number occupies the first word of the PT status notify area and the words containing the updated memory table entry number and PT status notify bits are shifted down one word. (Refer to page 457.)

Inputting Operation Using Touch Switches

A numeric value can be input in the same manner as when using an electronic calculator by using the touch switch input key – control.

Initial Display

When a numeral setting input field is displayed, the contents of a numeral memory table entry where the input numeric value is written are displayed.

Cursor Frame

If a Cursor frame is set for the numeral setting input field, the frame that encloses the input field is displayed while the field is accepting input.

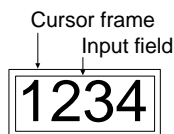

Inputting an Integer Part and a Decimal Fraction Part

In the integer part, numerals are input from the lowest digit position and the input value is shifted to the left as new numerals are input. If the input value exceeds the number of display digits of the integer part, the numeral at the highest digit position is cleared.

After the input of a decimal point, the succeeding numeric input is regarded as a decimal fraction. In the decimal fraction part, the numeral input first is displayed in the first place. After that the input numerals are displayed to the right of the preceding input. If the input value exceeds the display range, the numeral occupying the first position to the right of the decimal point is cleared.

Key input	Displayed numeric value
(Initial state)	1234.5678
9	0009.0000
0	0090.0000
.	0090.0000
4	0090.4000
5	0090.4500

Display of a Sign

If the numeral setting input field is assigned the signed value setting, the sign (+ and –) toggles each time the ± key is pressed.

Confirming the Input Numeric Value

After inputting a numeric value, always press the ENT key or  key to confirm the input. When the input is confirmed, the input numeric value is written to the numeral memory table entry and the occurrence of a change in the contents of the numeral memory table entry is notified to the PT status notify area (page 61).

The ENT key and the  key differ from each other in the following respects.

- ENT key
When more than one numeric key type numeral setting input field exits on the screen, the input objective shifts to the next input field when the input is confirmed. The input objective shifts in the order specified by the Support Tool.
-  key
Even when more than one numeric key type numeral setting input field exits on the screen, the input objective does not shift after the confirmation of the input.

Upper and Lower Limit Checks

The PT checks whether inputs are within the specified range to prevent the system from being adversely affected by the input of incorrect values. When a numeric value has been input in a numeral input field, the PC checks it against the upper and lower limit values when the value is confirmed.

Initial Operation of Input Keys

How the sign () key, the decimal point (.) key, and alphabetic letter (A to F) keys operate in the initial input (the first input after the screen is displayed or after the confirmation of the previous input) is described below.





















- Sign () key:
The display is cleared to 0.
- Decimal point (.) key:
The display is cleared to 0 and the input starts in the decimal fraction part. If the number of digits of the decimal fraction part is 0, numeric input is not the input for the decimal fraction part.
- Alphabetic letter (A to F) key:
In decimal input: The input is disregarded, and the buzzer sounds three times.
In hexadecimal input: The input alphabetic letter is displayed.

Input Example

In actual numeric input, the input numeric value changes as shown below.

Input example 1)

Decimal display, signed, 4 digits in integer part, 3 digits in decimal fraction part

Order	Key	Displayed numeric value	Order	Key	Displayed numeric value	Order	Key	Displayed numeric value
Initial value		0000.000	7		-1524.000	14		0000.000
1		0001.000	8		-1524.000	15		0000.700
2		0015.000	9		-1524.100	16		0000.720
3		0152.000	10		-1524.150	17		0000.720
4		0152.000	11		-1524.152	18		0000.000
5		-0152.000	12		-1524.527	19		0001.000
6		-1524.000	13		-1524.527	20		-0001.000

Input example 2)

Decimal display, unsigned, 4 digits in integer part, 3 digits in decimal fraction part

Order	Key	Displayed numeric value	Order	Key	Displayed numeric value	Order	Key	Displayed numeric value
	Initial value	0000.000	5	\pm	0152.000	10	J	1524.130
1	1	0001.000	6	4	1524.000	11	.	0000.000
2	5	0015.000	7	.	1524.000	12	9	0000.900
3	2	0152.000	8	1	1524.100	13	5	0000.950
4	B	0152.000	9	3	1524.130	14	J	0000.950

Cases Where Multiple Numeral Setting Input Fields Exist on a Screen (Without Cursor Moving Keys)

The following describes the procedure for inputting a numeric value at a screen that has multiple numeric key type numeral setting fields. The explanation is given for the operation that uses the input key – control keys to specify the input field instead of the touch switch cursor moving keys.

For the operation using the cursor moving keys, refer to *Cases When Multiple Numeral Setting Input Fields Exist on a Screen (With Cursor Moving Keys)* (page 334).

Here, the basic method for inputting numeric values is not explained: the explanation concentrates on how the multiple numeral setting input fields should be handled. For the numeric value input procedure and other related operations, refer to *Inputting Numeric Values Using the Input Key – Control on the Same Screen* (page 329).

Setting

When creating a screen using the Support Tool, set the elements indicated below that are used to specify the active numeral input field as well as the regular control keys that are used to input the numeric value.

Touch switch input key – control

HOME, ↓, ↑, ←, →, ▲, and ▼

Reference: If a screen has multiple numeral setting fields or character string input fields, the active input field must be specified using these keys: HOME, ↑, ↓, ←, →, ▲, ▼.

Operation

- 1, 2, 3... 1. Display the screen where a numeral setting input field is registered.
2. Specify the objective numeral setting input field using the input key – control (HOME, ↑, ↓, ←, →, ▲, ▼).

For the procedure for specifying the objective input field, refer to *Specifying the Objective Numeral Setting Input Field Using Input Key – Control* (page 333).

3. Input a numeric value using the input key – control.

For the procedure for inputting a numeric, refer to *Inputting Operation Using Touch Switches* (page 330).

4. Press the ENT key of the input key – control or the \square key to confirm the input.

When the input is confirmed, the input numeric value is stored to a numeral memory table entry. Then, the occurrence of a change in the contents of the numeral memory table entry is notified to the host via the PT status notify area (page 61).

- Reference:**
- If the objective input field is shifted before confirming the input, the input numeric value is canceled and the screen returns to the one displayed before the numeric value was input.
 - When a numeric input is confirmed, the PT checks whether the input is within the upper and lower (max./min.) limits set for that numeral setting input field. If the numeric value is outside the specified range, the buzzer sounds three times, the input numeric value is canceled, and the screen returns to the display before starting the input. In this case, neither writing to a numeral memory table entry nor notification to the host is executed.
 - If the  key is pressed to confirm the input, the same field remains as the objective input field even after the previous input has been confirmed. If the ENT key is used for the confirmation of the input, the next input field is selected as the objective input field.
 - When NT20S or NT30/620 compatible mode is being used, the current screen number occupies the first word of the PT status notify area and the words containing the updated memory table entry number and PT status notify bits are shifted down one word. (Refer to page 457.)

Specifying the Objective Numeral Setting Input Field Using the Input Key – Control

To specify the objective numeral setting input field using the touch switch input key – control, follow the procedure described below.

- Reference:** Use the procedures below to specify which input field (numeral or character string) is active and will receive inputs. When both numeral and character-string input fields have been created in a screen, the input fields will be selected based on their position and the order in which they were created regardless of the type of input (numeral or character string).

Specifying the Objective Input Field Using the Home, ↑, ↓, ←, → Keys

Pressing the HOME and ↑, ↓, ←, → keys selects the objective input field in the manner shown below.

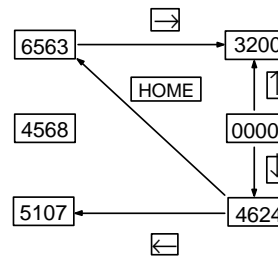

Pressing the HOME key selects the field at the upper left of the screen as the objective input field. If several input fields are arranged at the same distance from the upper left corner of the screen, the one at the left most position is selected as the objective input field.

Specifying the Objective Input Field Using the ↑ And ↓ Keys

Pressing the ↑ and ↓ keys shift the objective input field in the order the input fields were created using the Support Tool.

When three numeral setting input fields have been created, for example, the objective input field shifts in the order they were created as shown below.

- ↓ key: 1st 2nd 3rd 1st ...
- ↑ key: 1st 3rd 2nd 1st ...

Cases When Multiple Numeral Setting Input Fields Exist on a Screen (With Cursor Moving Keys)

The following describes the procedure for inputting a numeric value at a screen that has multiple numeric key type numeral setting fields. The way in which the touch switch cursor moving keys are used to specify the input field is explained.

For the operation that uses the input key – control to specify the objective input field, refer to *Cases When Multiple Numeral Setting Input Fields Exist on a Screen (With Cursor Moving Keys)* (page 332).

When a numeric key type input field is registered on a screen using the Support Tool, a cursor moving key touch switch can be created overlapping the input field. This enables the input field to be selected to accept input just by pressing it.

Here, the basic method for inputting numeric values is not explained: the explanation concentrates on how the multiple numeral setting input fields should be handled. For the numeric value input procedure and other related operations, refer to *Inputting Numeric Values Using the Input Key – Control on the Same Screen* (page 329).

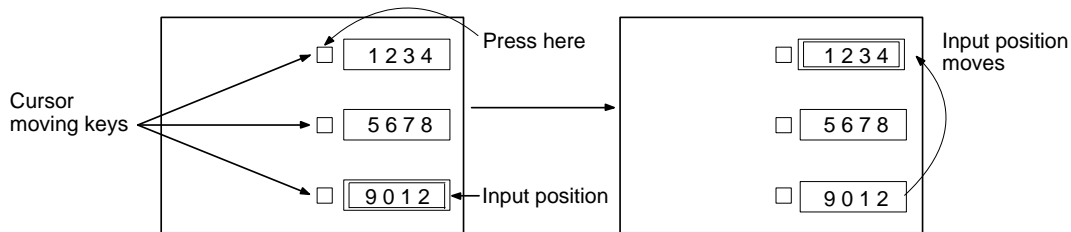



Setting

When creating a screen using the Support Tool, register the regular control keys that are used to input the numeric value.

Be sure that the cursor moving keys are created automatically when the numeral input field is registered in the screen.

Operation

- 1, 2, 3... 1. Display a screen where a numeral setting input field is registered.
2. Press the numeral setting input field where a numeric value is to be input to specify it as the objective input field.
3. Input a numeric value using the input key – control.
For the procedure for inputting a numeric value, refer to *Inputting Operation Using Touch Switches* (page 330).
4. Press the ENT key of the input key – control or the  key to confirm the input.
When the input is confirmed, the input numeric value is stored to a numeral memory table entry. Then, the event of changing the contents of numeral memory table entry is notified to the host via the PT status notify area (page 61).

- Reference:**
- If the objective input field is shifted before confirming the input, the input numeric value is canceled and the screen returns to the one displayed before the numeric value was input.
 - When a numeric input is confirmed, the PT checks whether the input is within the upper and lower (max./min.) limits set for that numeral setting input field. If the numeric value is outside the specified range, the buzzer sounds three times, the input numeric value is canceled, and the screen returns to the display before starting the input. In this case, neither writing to a numeral memory table entry nor notification to the host is executed.
 - If the  key is pressed to confirm the input, the same field remains as the objective input field even after the previous input has been confirmed. If the ENT key is used for the confirmation of the input, the next objective input field is selected.
 - When NT20S or NT30/620 compatible mode is being used, the current screen number occupies the first word of the PT status notify area and the words containing the updated memory table entry number and PT status notify bits are shifted down one word.

Inputting Numeric Values Using the Input Key – Control in a Window

The following describes the procedure for inputting a numeric value into a numeral setting input field in the base screen using the input key – control registered for the window.

Here, the basic method for inputting numeric values is not explained: the explanation concentrates on how the input key – control in a window should be handled. For the numeric value input procedure and the procedure for specifying the numeral setting input field, refer to the explanation for the numeric value input method given previously.

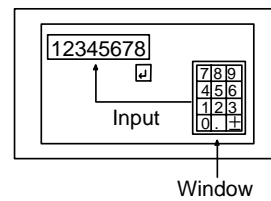

Setting

When creating a screen using the Support Tool, register the following elements for the screen.

- Numeral setting input field (numeric key type)
- Window open key touch switch
Specify the window screen number of the window used for inputting a numeric value.

(Used when opening the window for inputting a numeric value. This operation is not necessary if the window open function is set for the cursor moving key.)

Create the window screen used for the input and register the following elements for it. (It isn't necessary to register all of the elements listed below. Register just the required elements in the main screen and window.)

- Touch switch input key – control
 - 0 to 9
 - A to F (only for the numeral setting input field of the hexadecimal display format)
 - \pm (necessary for inputting a negative value)
 - . (necessary for inputting a decimal fraction)

- ENT or  (necessary for confirming the input)

The following keys can be registered if necessary.

- HOME or \uparrow , \downarrow , \leftarrow , \rightarrow , \uparrow , \downarrow (necessary for specifying an input field)
- CLR (for clearing the numeric value being input)
- CA (for canceling the input)
- BS (for deleting a character located immediately before the input cursor)
- DEL (for deleting a character located immediately after the input cursor)
- \blacktriangleleft , \blacktriangleright (for moving the input cursor)

Reference: For the registration of touch switch input key – control, it is useful to register the keys that will be required for inputting the data on the base screen, and those that will be switched according to need during input — such as letters and numerals — in the window.

Operation

- 1, 2, 3...**
1. Display a screen on which numeral setting input fields are registered.
 2. Specify the objective numeral setting input field using the input key – control and the cursor moving keys.
For the procedure for specifying the objective numeral setting input field, refer to *Specifying the Objective Numeral Setting Input Field Using the Input Key – Control* (page 333).

Reference: If the window open function is set to the cursor moving keys, the specified window automatically opens.

3. Press the window open key to open the window that is used for inputting a numeric value.

Reference: The way in which the window is opened differs according to the property set for the window open key (page 134).

4. Input a numeric value using the input key – control.
For the procedure for inputting a numeric value, refer to *Inputting Operation Using Touch Switches* (page 330).
5. Press the ENT key in the input key – control or the  key to confirm the input.
When the input is confirmed, the input numeric value is stored to a numeral memory table entry. Then, the occurrence of a change in the contents of the numeral memory table entry is notified to the host via the PT status notify area (page 61).

- Reference:**
- If the objective input field is shifted before confirming the input, the input numeric value is canceled and the screen returns to the one displayed before the numeric value was input.
 - When a numeric input is confirmed, the PT checks whether the input is within the upper and lower (max./min.) limits set for that numeral setting input field. If the numeric value is outside the specified range, the buzzer sounds three times, the input numeric value is canceled, and the screen returns to the display before starting the input. In this case, neither writing to a numeral memory table entry nor notification to the host is executed.
 - If the  key is pressed to confirm the input, the same field remains as the objective input field even after the previous input has been confirmed. If the ENT key is used for the confirmation of the input, the objective input field shifts to the next.
 - When NT20S or NT30/620 compatible mode is being used, the current screen number occupies the first word of the PT status notify area and the words containing the updated memory table entry number and PT status notify bits are shifted down one word (page 457).

Inputting Numeric Values Using the Temporary Input Field

The following describes the procedure for inputting a numeric using a temporary input field that is registered for a window. The term temporary input field means a numeric key type numeral setting input field registered for a window. It is used as a temporary input field before the input is confirmed.

When a temporary input field is used, it is possible to input a numeric value while leaving a numeric value that was active before the input in the numeral setting input field on the base screen.

Here, the explanation concentrates on how to use a temporary input field in a window. For the numeric value input procedure (page 328) and the procedure for specifying the numeral setting input field (page 332, 334) and for opening the window (page 335), refer to the explanation for the numeric value input method given previously.

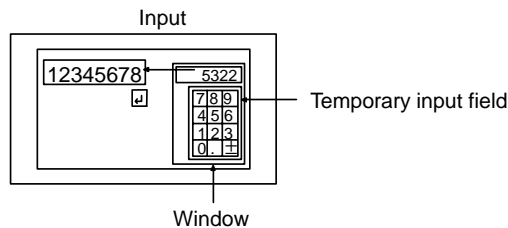

Setting

When creating a screen using the Support Tool, set the elements indicated below that are used to specify the active numeral input field as well as the regular control keys that are used to input the numeric value.

- Window open key touch switch
Specify the window screen number of the window used for inputting a numeric value.
(Used when opening the window for inputting a numeric value. This operation is not necessary if the window open function is set for the cursor moving key.)

- Window close key touch switch

Create the window screen used for the input and register the following elements for it. (It isn't necessary to register all of the elements listed below. Register just the required elements in the main screen and window.)

- Touch switch input key – control
 - 0 to 9
 - A to F (only for the numeral setting input field of the hexadecimal display format)
 - \pm (necessary for inputting a negative value)
 - . (necessary for inputting a decimal fraction)
- Numeral setting input field (Temporary input field registered in the window)

Reference: Only one numeral setting input field can be registered in a window, and this numeral setting input field is used as a temporary input field. Only one temporary input field, numeral input field, or character string input field can be registered. A thumbwheel type numeral setting input field cannot be registered for a window.

Operation

- 1, 2, 3...**
1. Display the screen where a numeral setting input field is registered.
 2. Specify the objective numeral setting input field using the input key – control and the cursor moving keys.
For the procedure for specifying the objective numeral setting input field, refer to *Specifying the Objective Numeral Setting Input Field Using the Input Key – Control* (page 333).

Reference: If the window open function is set for the cursor moving keys, the specified window automatically opens.

3. Press the window open key to open the window that is used for inputting a numeric value.

Reference: The way in which the window is opened differs according to the property set for the window open key (page 134).

4. Input a numeric value into the temporary input field using the input key – control.

The same procedure as used for inputting a numeric value into a normal numeral setting input field can be used. For the procedure for inputting a numeric value, refer to *Inputting Operation Using Touch Switches* (page 330).

For restrictions on using a temporary input field, refer to *Restrictions on Using a Temporary Input Field* (page 339).

-
- Reference:**
- If a temporary input field is set in a window, the input is automatically set in the temporary input field.
When multiple windows are opened and the each window has an input field (temporary input field), the data is set in the input field in a focus window. For details of focus window, refer to *Focus Window* (page 242).
 - In the initial state, the initial state content of the objective input field is displayed in the temporary input field.
 - The objective input field on the base screen maintains the initial state display until the input is confirmed.
-

5. Press the ENT key in the input key – control or the  key to confirm the input.
When the input is confirmed, the input numeric value is stored to a numeral memory table entry. Then, the occurrence of a change in the contents of the numeral memory table entry is notified to the host via the PT status notify area (page 61).

- Reference:**
- If the objective input field is shifted before confirming the input, the input numeric is canceled and the screen returns to the one displayed before the numeric value was input.
 - When a numeric input is confirmed, the PT checks whether the input is within the upper and lower (max./min.) limits set for that numeral setting input field. If the numeric value is outside the specified range, the buzzer sounds three times, the input numeric value is canceled, and the screen returns to the display before starting the input. In this case, neither writing to a numeral memory table entry nor notification to the host is executed.
 - When NT20S or NT30/620 compatible mode is being used, the current screen number occupies the first word of the PT status notify area and the words containing the updated memory table entry number and PT status notify bits are shifted down one word (page 457).
-

Restrictions on Using a Temporary Input Field

- For a thumbwheel type numeral input field, it is not permissible to use a temporary input field.
- If the number of digits in a temporary input field is smaller than the number of digits (integer part digits + fraction part digits + decimal point digit + sign digit) necessary for the objective input field on the base screen, the input is made within the range of the number of digits in the temporary input field.
- If an input field does not exist on the base screen, a temporary input field is not displayed.

Example of Use

<Base screen>

5 input settings

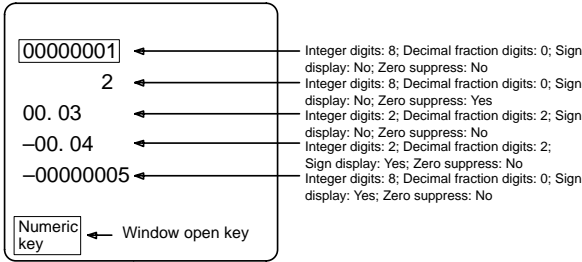

<Window>

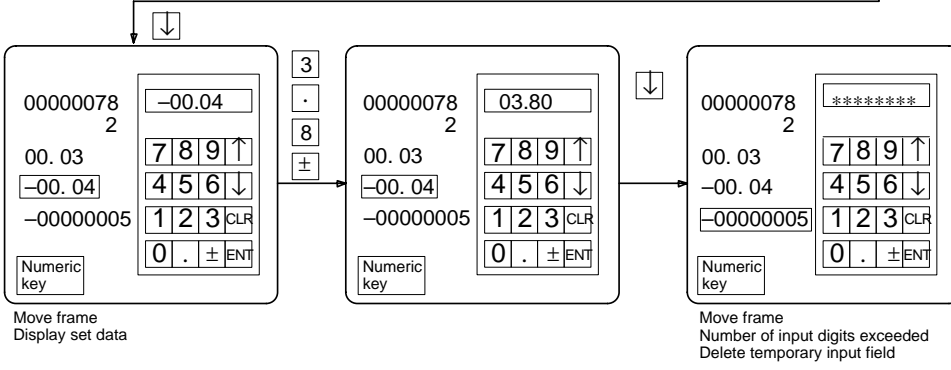
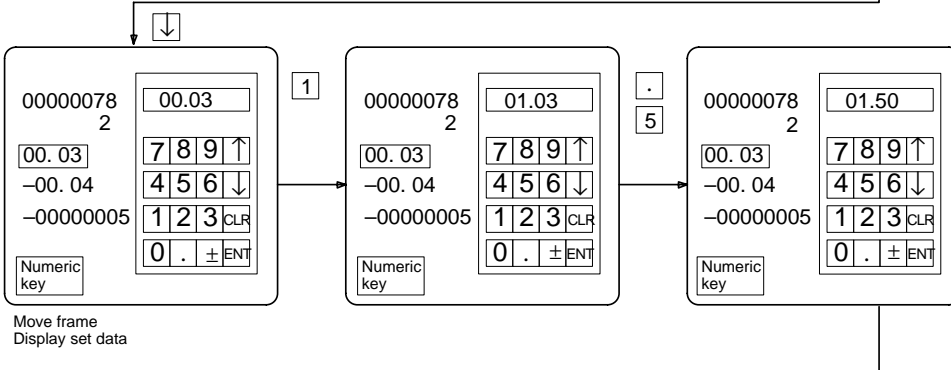
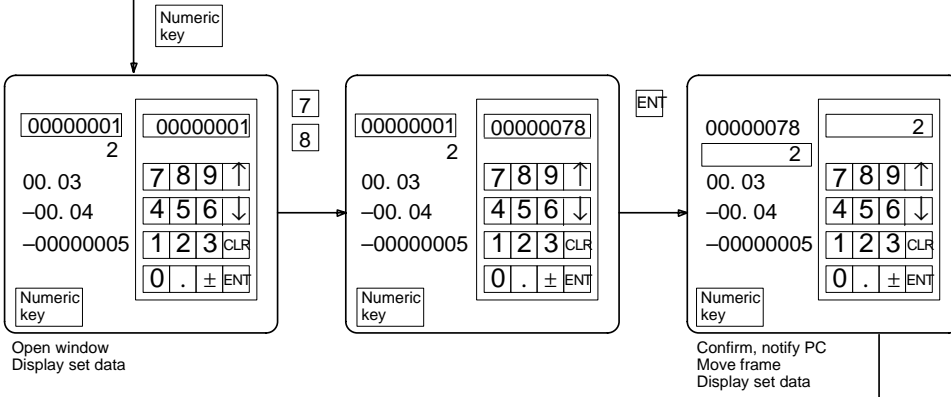
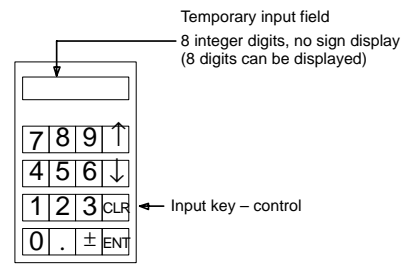

Inputting Numeric Values Using a Thumbwheel Type Input Field

The following describes the procedure for inputting or changing a numeric value in a thumbwheel type input field.

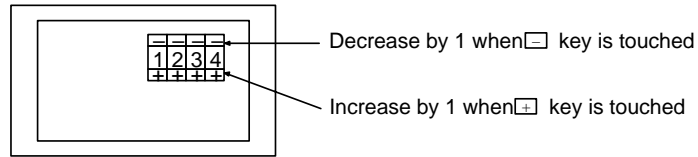

Setting

When creating a screen using the Support Tool, register the following element for the screen.

Thumbwheel switch

Reference: Since a thumbwheel type numeral setting field itself has a touch switch for inputting a numeric value, it is not necessary to register other elements for inputting a numeric value.

Operation

- 1, 2, 3...**
1. Display the screen that has the thumbwheel switch.
 2. Change the numeric value using the increment/decrement (+, -) keys provided at the top and bottom of each digit position of the thumbwheel switch.
For the procedure for changing a numeric value, refer to *Using A Thumbwheel Type Input Field* (page 341).

- Reference:**
- In a thumbwheel switch, a numeric value is confirmed immediately after it is changed and written to a numeral setting field. At the same time, the occurrence of a change in the contents of the numeral setting memory table entry is notified to the host.
When the numeric input is confirmed, the PT checks whether the input is within the upper and lower (max./min.) limits set for that numeral setting input field. If the numeric value is outside the specified range, the buzzer sounds three times, the input numeric value is canceled, and the screen returns to the display before starting the input. In this case, neither writing to a numeral memory table entry nor notification to the host is executed.
 - When a thumbwheel switch is displayed, the numeric value that has been stored in the numeral memory table entry prior to the input is displayed.
 - Even if more than one thumbwheel switch exists on a screen, it is not necessary to specify an active thumbwheel switch since the inputs are made with the increment and decrement keys contained in each switch.
 - When NT20S or NT30/620 compatible mode is being used, the current screen number occupies the first word of the PT status notify area and the words containing the updated memory table entry number and PT status notify bits are shifted down one word (page 457).

Using a Thumbwheel Type Input Field

At a thumbwheel switch, input a numeric value using the increment/decrement (+, -) keys provided at each digit position of the thumbwheel type numeral setting field.

Specifying a Numeric Value

When an increment/decrement (+, -) key is pressed, the numeric value at the corresponding digit increases or decreases by 1. Each time the + key or the - key is pressed, the changed numeric value is stored to the numeral memory table entry and the occurrence of a change in the contents of the numeral

memory table entry is notified to the host. It is not necessary to confirm the input numeric value by pressing the ENT key or the  key, which is required when a numeric key type input field is used.

With a thumbwheel switch, inputting of a numeric value using the input key – control is not possible.

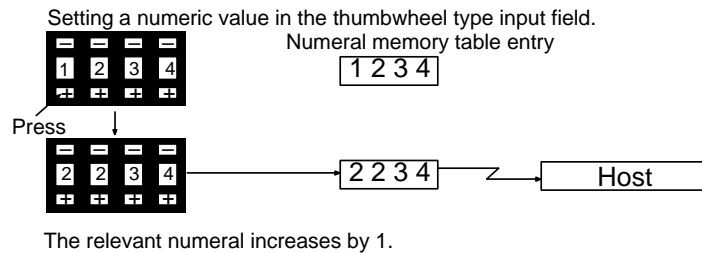

Changing a Sign

If a check mark is set for Display sign of a thumbwheel switch, the + and – keys are used to change the sign if the keys in the sign display digit are pressed. Pressing the + key changes the sign to + and pressing the – key changes the sign to –.

Checking the Upper/Lower Limit

The PT has a function to check the correctness of an input numeric value to prevent a numeric value outside the allowable range from being input so that the input of an illegal value will not adversely affect the system.

The upper/lower (max./min.) limit check is executed in the timing indicated below according to the type of a numeral setting input field.

For a thumbwheel switch, the check is executed each time the increment/decrement key of each digit position is pressed.

With a thumbwheel switch, if $n\dots n < m\dots m$ upper limit: $1n\dots n$, lower limit: $0m\dots m$ (n and m are arbitrary values at each digit), carry over and underflow are not possible at the highest digit position.

Example:

If the upper limit value and the lower limit value are 1200 and 201, respectively, the numeric value can be changed only in the following range: from 201 to 999 if an initial value is a 3-digit value and from 1000 to 1200 if an initial value is a 4-digit value.

The reason for this is that the upper/lower (max./min.) limit check function does not allow the numeric value at the highest digit position to change from 0 to 1 or from 1 to 0.

To avoid this, set the upper and lower limit values so that $n\dots n \geq m\dots m$, or provide a touch switch separately to write a numeric value for carry over or underflow.

It won't be possible to change the numeric value with the increment and decrement keys if the value is already outside of the range specified by the upper and lower limits.

3-7-2 Inputting Character Strings

To input a character string, the touch switches input key – string and input key – control are used. Basically, the input key – string and input key – control arranged on the same screen are used to directly input a character string into a character string input field. It is also possible to use input key – string and input key – control or a temporary input field registered for a window.

Registration of more than one character string input field in a screen is permitted. To specify the objective input field among multiple input fields, either the input key – control provided for shifting between input fields or a cursor moving key should be used.

When inputting a character string, the specification of an input field, window opening procedure, and the major purposes of a temporary input field are identical to those for inputting a numeric value. The explanation below concentrates on how a character string is input; other information is not discussed. For the procedure for specifying an input field and opening a window, and for the major purposes of a temporary input field, refer to the corresponding items in the description of the operation for numeric value input.

In character string input operation, bar code data can be input as a character string using a bar code reader that is connected to the PT.

Only the following topics are described here.

- Using the input key – string and input key – control on the same screen
- Using a bar code reader

- Reference:**
- A character string input field will be disabled when the interlock function is being used for the input field and the interlock bit in the host that controls the input field's operation is OFF. (See *Controlling PT Operations with Interlock Bits* on page 369 for details.)
 - Likewise, the interlock function can be set for touch switches and the touch switch's operation can be disabled by turning OFF the host's interlock bit that controls the touch switch. (See *Controlling PT Operations with Interlock Bits* on page 369 for details.) Check the status of the interlock bits allocated to control touch switches before inputting numerical values.

Restrictions Specific to Character String Input When Using Temporary Input Fields

When inputting a character string, a temporary input field can be used as for inputting a numeric value. But when using a temporary input field for inputting a character string, the following specific restrictions should be noted.

- When inputting a character string, the temporary input field must also be the character string input field.
- Even if the number of digits of a temporary input field is smaller than the number of digits of the objective input field on the base screen, the temporary input field can be used to input a character string. In this case, however, blank digits remain in the character string input field on the base screen and these blank digits are filled with spaces. In the initial display, characters that overflow the temporary input field are disregarded.
- Even if the number of digits of a temporary input field is larger than the number of digits of the objective input field on the base screen, the temporary input field can be used to input a character string. In this case, however the input character string will overflow the character string input field on the base screen and the overflowing characters are ignored.
- A temporary input field is not displayed if an input field does not exist on the base screen.

Inputting a Character String Using Input Key – String on the Same Screen

The following describes the basic character string input procedure — inputting a character string to a character string input field using the input key – string and input key – control provided on the same screen when the screen has only one character string input field.

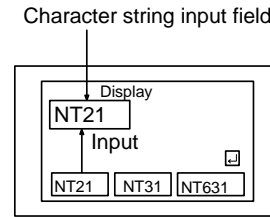

Reference: It is possible to copy the contents in the character string memory table entry to the character string input field using the touch switch Copy Setting function (page 326).

Setting

When creating a screen using the Support Tool, register the following elements for the screen.

- Character string input field
- Input key – string for touch switches
 - Characters registered for labels are used for inputting a character string.
 - Marks can be input by specifying FF20 to FFFFH.
- Touch switch input key – control
 - ENT or  (necessary for confirming the input)

The following keys can be registered if necessary.

 - CLR (for clearing the character string being input)
 - CA (for canceling the input)
 - BS (for deleting a character located immediately before the input cursor)
 - DEL (for deleting a character located immediately after the input cursor)
 - ◀, ▶ (for moving the input cursor)

Reference: The input key – control of 0 to 9 and A to F can be used to input a character string.

Operation

- 1, 2, 3...**
1. Display a screen that has a character string input field.
 2. Input a character string using the input key – string.

Reference: When the screen has only one character string input field, that input field is specified automatically. It is not necessary to specify it as the active input field.

3. Press the ENT key or the  key to confirm the input.

When the input is confirmed, the input character string is stored to a character string memory table entry. Then, the occurrence of a change in the contents of the character string memory table entry is notified to the host via the PT status notify area (page 61).

- Reference:**
- If the number of characters of the input character string is smaller than the number of characters of the character string memory table entry size, the digits left blank are filled with spaces.
 - When NT20S or NT30/620 compatible mode is being used, the current screen number occupies the first word of the PT status notify area and the words containing the updated memory table entry number and PT status notify bits are shifted down one word (page 457).

Inputting a Character String Using a Bar Code Reader

The following describes the procedure for inputting a character string into a character string input field using a bar code reader when the screen has only one character string input field.

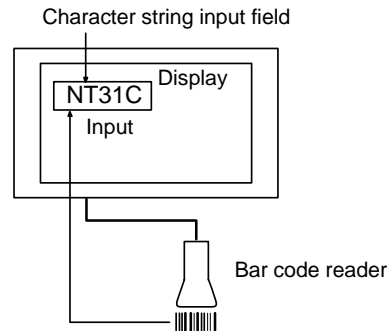

When a bar code reader is used, either of the following methods can be selected for confirming the input.

- **Manual confirmation:**
Use the ENT key or the  key to confirm the input character string.
- **Automatic confirmation:**
The input character string is automatically confirmed at the same time the bar code reader reads out the bar code data (character string).

- Reference:**
- When Manual is selected for inputting a character string using a bar code reader, the input key – string and input key – control touch switches can be used to correct the bar code data (character string) or add any required character.
 - Selection of Auto/Manual is made in the settings for the communication conditions of a bar code reader at the System Menu of the PT.
 - It is possible to copy the contents in a character string memory table entry to a character string input field using the touch switch Copy Setting function (page 326).

Setting

When creating a screen using the Support Tool, register the following elements for the screen.

- Character string input field

If a bar code reader is used in Manual, the following touch switch input key – string and input key – control may be set if necessary.

- Touch switch input key – string

Characters registered for labels are used for inputting a character string.

Marks can be input by specifying FF20H to FFFFH.

- Touch switch input key – control

- ENT or  (necessary for confirming the input)

- CLR (for clearing the character string being input)
- CA (for canceling the input)
- BS (for deleting a character located immediately before the input cursor)
- DEL (for deleting a character located immediately after the input cursor)
- ◀, ▶ (for moving the input cursor)

Reference: The input key – control of 0 to 9 and A to F can be used to input a character string.

Operation

- 1, 2, 3...**
1. Display a screen that has a character string input field.
 2. Read out the bar code data using a bar code reader and input the read out data as a character string.

Reference:

- When the bar code reader is used with Auto, the input character string is confirmed at the same time the bar code data is read out. If the screen has other input fields (numeral or character string), the active input field shifts to the next input field automatically.
- If the screen has only one input field and that input field is a character string input, input of a character string automatically starts when a data is read through a bar code reader. (Specification of an objective input field is not necessary.)

3. When the bar code reader is used with Manual, press the ENT key or the  key to confirm the input.

When the input is confirmed, the input character string is stored to a character string memory table entry. Then, the occurrence of a change in the contents of the character string memory table entry is notified to the host via the PT status notify area (page 61).

Reference:

- If the input character string is smaller than the number of characters of the character string memory table entry, the surplus part is filled with spaces.
- When NT20S or NT30/620 compatible mode is being used, the current screen number occupies the first word of the PT status notify area and the words containing the updated memory table entry number and PT status notify bits are shifted down one word (page 457).

3-8 Using the Alarm List/History Function

This section describes how to use the alarm list and the alarm history, which monitor the status of bits in the host and, if a bit status changes to 1 (ON), display the corresponding message and the image/library data.

The alarm list/history can be checked using the System Menu of the PT. It is also possible to check them during operation by registering them to the screen as an element (alarm list can only be used as an element.).

The Support Tool can read out the alarm history record data stored to the PT to the host as a text file. For the procedure for reading the alarm history record data, refer to the *NT-series Support Tool Version 4.6 for Windows Operation Manual* (V061-E1-□).

3-8-1 How to Use the Alarm List/History

An alarm list can only be displayed as an element while an alarm history can be displayed on a confirmation screen that is called from the System Menu as well as displayed as an element.

Confirming during Operation as an Element

The status of the bit to be monitored (alarm list) and the record of bit status transition (alarm history) can be confirmed while the PT is operating.

Alarm List

Message (character string table entry 32)
set for bit memory table entry 14

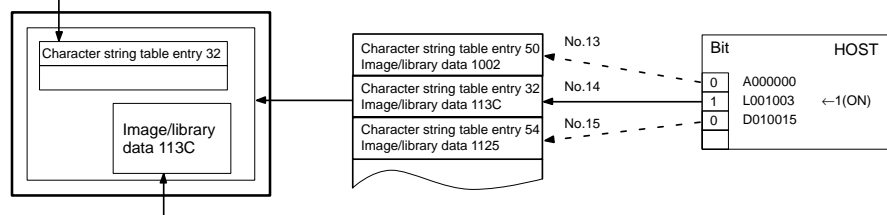

When the message displayed is pressed, the image/library data (113C) set for bit memory table entry 14 is displayed.

Alarm History

Message (character string table entry 13)
set for bit memory table entry 24

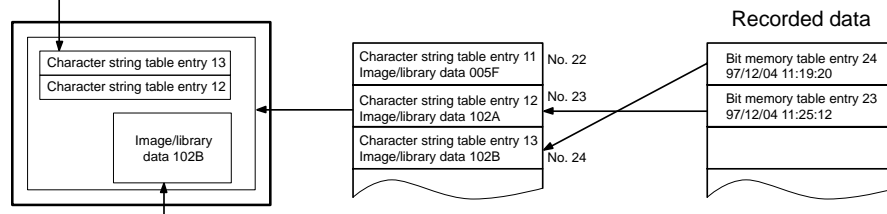

When the upper message displayed is pressed, the image/library data (102B) set for bit memory table entry 13 is displayed.

Setting

When creating a screen using the Support Tool, set the following.

Bit Memory Table

Set as shown below for the number of bits in the host to be monitored (for information not indicated below, set as needed.).

- PC Address: Bits in the host to be monitored
- Function: Alarm
- History:
 - For alarm list: Check mark set or no check mark

- For alarm history: Check mark set
- String Table Entry:
Table entry number (0 to 1999) of the character string memory table entry to be displayed as a message
- Image/Library Code:
Image/library code displayed together with a message
 - 0000H: No display
 - 0001H to 0FFFH: Image
 - 1000H to 3FFFH: Library display
- Screen No.
Screen No. (0001 to 3999) of the screen to be displayed when the message is pressed twice.
This setting is valid only when switching the screen.

Alarm List/History

Register an alarm list/history to a screen in the manner described below (for information not indicated below, set as needed.).

- Alarm list
 - Start bit table entry:
Table entry number of the first bit memory table entry among the bit memory table entries where the bits in the host to be monitored are registered.
 - No. of bits referenced:
The number of the bit memory table entries where the bits in the host to be monitored are registered.
- Alarm history
 - Type: Order of frequency or order of occurrence
To display the alarm history in the order of occurrence, set the display order (From Old Data/From New Data) of the record data using the Hist. Disp. Method memory switch of the PT.

Reference: The image and library codes are different when NT20S or NT30/620 compatible mode is being used.

Operation

- 1, 2, 3...**
1. Initialize the recorded alarm history record data as needed.
To initialize the alarm history record data using System Menu operation, select Alarm History on the MEMORY INIT. MENU screen.
To initialize the alarm history record data by operation at the PT status control area, change the status of bit 1 in the 4th word (word n + 3) from the beginning of the PT status control area to 1 (ON).
After initializing the alarm history record data by operation at the PT status control area, return the status of bit 1 to 0 (OFF).
 2. Display the screen where the alarm list/history is registered.
In the case of an alarm history, the recorded data is displayed on the screen.
In the case of an alarm list, the content of the set character string memory table entry is displayed as a message if the status of the bit in the host to be monitored changes to 1 (ON).

Dedicated touch switches are provided for the alarm list/history. For the procedure for using these touch switches, refer to *How To Use the Touch Switches of the Alarm List/History* (page 349).

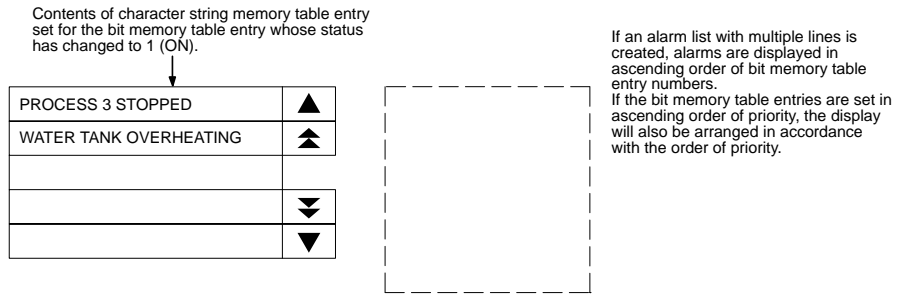

- Since the message area is a touch switch, pressing the message causes the set image/library data to be displayed. At the same time, the pressed message is displayed in the ON color.

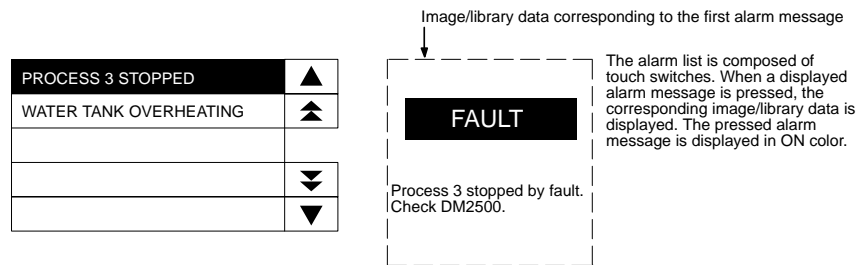

- If another message is pressed, when more than one message is displayed, the newly pressed message is displayed in reverse video and the corresponding image/library data is displayed.

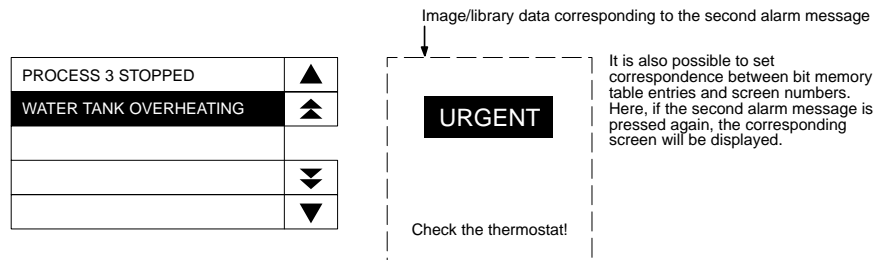

- When the reverse video message is pressed, the screen changes to the screen with the set screen number.

How to Use the Touch Switches of the Alarm List/History

The touch switches shown below are provided for the alarm list/history element.

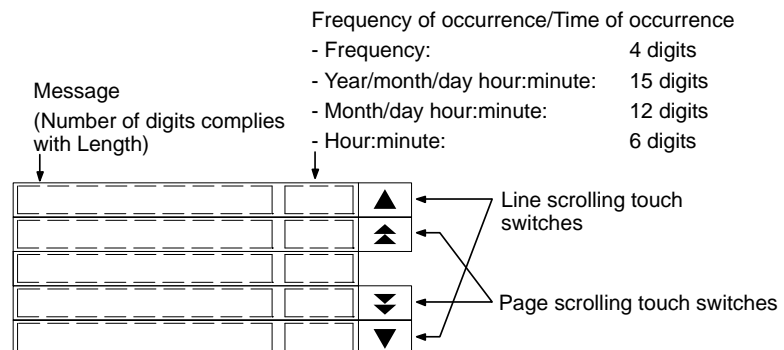

Line Scroll Touch Switches (Scroll To the Previous/Next Line)

The touch switches scroll the display range in units of a line forward and backward.

If data exist before and after the displayed range, the touch switches are displayed in reverse video. Pressing a touch switch not displayed in reverse video is disregarded.

Page Scroll Touch Switches (Scroll to the Previous/Next Page)

The touch switches scroll the display range in units of a page forward and backward.

If data exist before and after the displayed range, the touch switches are displayed in reverse video. Pressing a touch switch not displayed in reverse video is disregarded.

Displaying the Alarm History Record from the System Menu

The recorded alarm history record data can be confirmed from the System Menu. It is possible to print the alarm history record data using a printer connected to the NT31/NT31C or NT631/NT631C.

Display in the Order of Occurrence (NT31/NT31C Shown)

No.	Ent.	Time	Comment	
1	0524	0441	Converter Stopped	
2	0524	0505	Temp. Low Level	Quit
3	0524	0641	Process 2 Stopped	
4	0524	0641	Process 1 Stopped	↑
5	0524	0849	Converter Stopped	
6	0524	1521	Converter Stopped	↓
7	0526	0844	P/S Low Voltage	
8	0527	1732	Converter Stopped	
9	0527	1125	Temp. Low Level	
10	0530	2109	Process 1 Stopped	Prt.
11	0684	1833	Process 1 Stopped	
12	0684	2106	Converter Stopped	Prt.
13	0684	2152	Converter Stopped	Stop

Display in the Order of Frequency (NT31/NT31C Shown)

No.	Ent.	Comment	
1	125	Converter Stopped	
2	186	Temp. Low Level	Quit
3	49	Temp. High Level	
4	16	P/S Low Voltage	↑
5	15	Process 3 Stopped	
6	13	Water Tank Overheating	↓
7	11	Process 2 Stopped	
8	6	Process 1 Stopped	
9	4	Pin 1	
10	2	Pin 2	Prt.
11	1	Setting Error	Prt. Stop

Setting

When creating a screen using the Support Tool, set the following.

Bit Memory Table

Set as shown below by the number of bits in the host to be monitored (for information not indicated below, set as needed.).

- Allocated bits: Bits on the host to be monitored
- Function: Alarm
- History: Check mark set
- Switch Screen: No check mark
- String Table Entry: Table entry number (0 to 1999) of the character string memory table entry to be displayed as a message

To display the alarm history in the order of occurrence, set the display order (From Old Data/From New Data) of the record data using the Hist. Disp. Method memory switch of the PT.

Operation

- 1, 2, 3... 1. Initialize the recorded alarm history record data as needed.
- To initialize the alarm history record data using System Menu operation, select Alarm History on the MEMORY INIT. MENU screen.
- To initialize the alarm history record data by operation at the PT status control area, change the status of bit 1 in the 4th word (word n + 3) from the beginning of the PT status control area to 1 (ON).
- After initializing the alarm history record data by operation at the PT status control area, return the status of bit 1 to 0 (OFF).
2. From the System Menu, display the alarm history confirmation screen.
- The recorded alarm history record data is displayed.

Example: Display in the order of occurrence

No.	TIME	HELV	Comment	
1	0524	0841	Converter Stopped	
2	0524	0805	Temp. Low Level	Quit
3	0524	0841	Process 2 Stopped	
4	0524	0841	Process 1 Stopped	↑
5	0524	0849	Converter Stopped	
6	0524	1521	Converter Stopped	
7	0525	0844	P/S Low Voltage	↓
8	0527	1732	Converter Stopped	
9	0527	1125	Temp. Low Level	
10	0530	2109	Process 1 Stopped	
11	0604	1833	Process 1 Stopped	Prt.
12	0604	2106	Converter Stopped	
13	0604	2152	Converter Stopped	Prt. Stop

3. It is possible to display the previous and the next page by pressing the ↑ and ↓ keys.
4. To end the display, press the Quit touch switch.

Reference: For the procedure for displaying alarm history from the System Menu, refer to *Displaying and Printing the Alarm History Record* in section 6 in the *Setup Manual*.

3-9 Using the Display History Function

This section describes how to use the display history, which records the order and frequency of screen display.

The display history can be checked using the System Menu of the PT. It is also possible to check it during operation by displaying the display history screen.

Concerning the display history record data stored to the PT, the Support Tool can read it out to the host as a text file. For the procedure for reading the display history record data, refer to the *NT-series Support Tool Version 4 for Windows Operation Manual* (V061-E1-□).

3-9-1 How to Use the Display History

A display history can be displayed in the special screen called out during operation or in the screen called out from the System Menu.

Displaying the Special Screen during Operation

The display history can be confirmed during the operation of the PT.

Setting

When creating a screen using the Support Tool, tick the check box of the History property of the screen to be recorded in the display history.

To display the alarm history in the order of occurrence, set the display order (From Old Data/From New Data) of the record data using the Hist. Disp. Method memory switch of the PT.

Operation

- 1, 2, 3...** 1. Initialize the recorded alarm history record data as needed.

To initialize the alarm history record data using System Menu operation, select Alarm History on the MEMORY INIT. MENU screen.

To initialize the alarm history record data by operation at the PT status control area, change the status of bit 11 in the 4th word (word n + 3) from the beginning of the PT status control area to 1 (ON).

After initializing the alarm history record data by the operation at the PT status control area, return the status of bit 11 to 0 (OFF).

2. Display the display history screen. (The following displays show screens from an NT31/NT31C PT.)

The screen number of the display history screen is:

Order of occurrence: No. 9001

Order of frequency: No. 9002

Display in the Order of Occurrence (Screen No. 9001)

No.	Screen	Time	Area	Comment	
1	1	0504	0441	Start	
2	32	0504	0806	Temp. Setting 1	Quit
3	44	0504	0841	Sector A	
4	32	0504	0841	Temp. Setting 1	↑
5	33	0504	0841	Temp. Setting 2	
6	34	0504	0841	Temp. Setting 3	↓
7	2	0504	0844	Main Monitor	
8	44	0606	0851	Sector A	
10	102	0612	1358	[A] Low Level	
11	2	0612	1403	Main Monitor	Prt.
12	45	0614	0851	Sector B	Prt. Stop

Display In the Order of Frequency (Screen No. 9002)

No.	Scrn	Art	Comment	1/1
1	1	164	Main Menu	
2	32	33	Temp. Setting 1	Quit
3	44	24	Sector A	

↑
 ↓
 Prt.
 Prt. Stop

- It is possible to display the previous and the next page by pressing the ↓ and ↑ keys.
- To end the display, press the Quit touch switch.

Displaying the Confirmation Screen from the System Menu

The recorded display history record data can be confirmed from the System Menu. It is possible to print the display history record data using a printer connected to the NT31/NT31C or NT631/NT631C.

Setting

When creating a screen using the Support Tool, tick the check box of the History property of the screen to be recorded in the display history.

To display the alarm history in the order of occurrence, set the display order (From Old Data/From New Data) of the record data using the Hist. Disp. Method memory switch of the PT.

Operation

- 1, 2, 3...** Initialize the recorded display history record data as needed.
 - To initialize the alarm history record data using System Menu operation, select Alarm History on the MEMORY INIT. MENU screen.
 - To initialize the alarm history record data by operation at the PT status control area, change the status of bit 1 in the 4th word (word n + 3) from the beginning of the PT status control area to 11 (ON).
 - After initializing the alarm history record data by the operation at the PT status control area, return the status of bit 11 to 0 (OFF).
- Display the display history confirmation screen from the System Menu. (The following displays show screens from an NT31/NT31C PT.)
 - The recorded display history record data is displayed.

Display in the Order of Occurrence (Screen No. 9001)

No.	Scrn	Art	Comment	1/1
1	1	0504 8441	Start	
2	32	0504 8806	Temp. Setting 1	Quit
3	44	0504 8841	Sector A	
4	32	0504 8841	Temp. Setting 1	↑
5	33	0504 8841	Temp. Setting 2	
6	34	0504 8841	Temp. Setting 3	↓
7	2	0504 8844	Main Monitor	
8	44	0688 8851	Sector A	
10	182	0612 1358	[A] Low Level	
11	2	0612 1403	Main Monitor	
12	45	0614 8851	Sector B	

Prt.
 Prt. Stop

Display in the Order of Frequency (Screen No. 9002)

No.	Screen	Amt.	Comment	1/1
1	1	164	Main Menu	
2	32	33	Temp. Setting 1	Quit
3	44	24	Sector A	

3. It is possible to display the previous and the next page by pressing the ↑ and ↓ keys.
4. To end the display, press the Quit touch switch.

Reference: For the procedure for displaying display history from the System Menu, refer to *Displaying and Printing the Display History Record* in section 6 in the *Setup Manual*.

3-10 Display and Setting of Calendar Clock

The PT provides a function for displaying and setting the date and time. This section describes the procedure for using the clock function.

Numeral Memory Table Entries Used by the Clock Function

Numeral memory table entries 247 to 255 are reserved for the display and setting of the clock function.

Memory table entries 247 to 253 are for display and reading, and No. 254 and No. 255 are for setting. (With the NT21, table entry numbers 254 and 255 are reserved by the system.)

With the NT31/NT31C or NT631/NT631C, memory table entries 247 to 253 store the clock data that is updated according to the operation of the clock built into the PT. The data in these memory table entries cannot be changed from the host.

With the NT21, the clock data read from the words allocated in the host is stored in table entry numbers 247 to 253.

Function	Numeral memory table entry	Digit position	Information	Value	Remarks
Display/reading only	247		Second	00 to 59	
	248		Minute	00 to 59	
	249		Hour	00 to 23	24-hour system
	250		Date	01 to 31	
	251		Month	01 to 12	
	252		Year	00 to 99	Last 2 digits of the year
	253		Day of week	00 to 06	See below.
Setting only (NT31/NT31C or NT631/NT631C) (Reserved by system for NT21.)	254		Second	00 to 59	
			Minute	00 to 59	
			Hour	00 to 23	24-hour system
			Date	01 to 31	
	255		Month	01 to 12	
			Year	00 to 99	Last 2 digits of the year
			Day of week	00 to 06	
			Vacant	00	

The correspondence between the value and day of week is shown below.

Day of week	Sun	Mon	Tue	Wed	Thu	Fri	Sat
Value	00	01	02	03	04	05	06

Example of setting for the NT31/NT31C or NT631/NT631C: September 28th, '01 (Fri.), 14 H 53 M 30 S

254 2,8,1,4,5,3,3,0
 255 0,0,0,5,0,1,0,9

Reference: The numeral memory table entries 247 to 255, reserved for the clock function, cannot be allocated words in the host.

3-10-1 Setting the Date and Time (NT31/NT31C and NT631/NT631C)

The clock data can be set by the following methods for the NT31/NT31C or NT631/NT631C. (With the NT21, the clock data is read from the host and cannot be set at the PT.)

- Setting from the System Menu
- Changing the value in numeral memory table entries 254 and 255

The following explains the procedure for writing the required clock data to the numeral memory table entries. For the procedure for setting the clock data using the System Menu, refer to *Displaying/Setting the Calendar and Clock* in section 6 in the *Setup Manual*.

Reference: The clock has an accuracy of maximum monthly error of -39 to +65 seconds at a room temperature (25°C). Adjust the error periodically to operate the clock accurately.

Changing the Value in Numeral Memory Table Entries 254 and 255

Numeral memory table entries 254 and 255 are specially used for setting the clock data.

These memory table entries cannot be allocated words in the host. Therefore, to change the contents in these memory table entries, write the data to be set in them into another numeral memory table entry first then copy the written value to numeral memory table entries 254 and 255 using the memory table copy function.

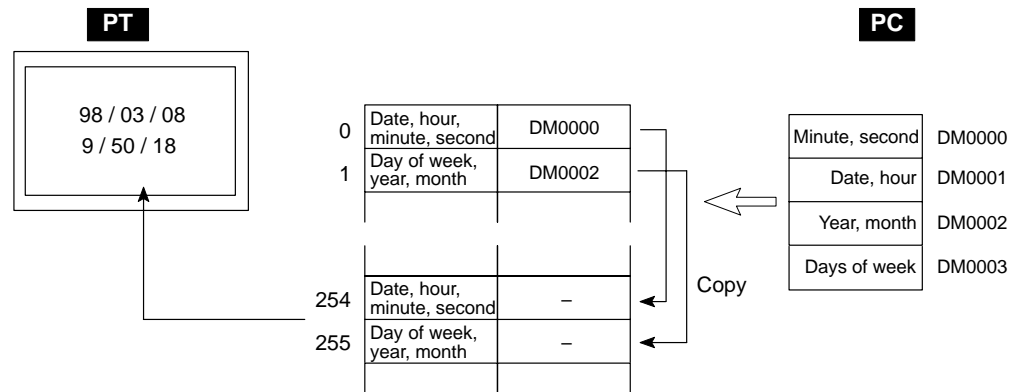

To copy a memory table entry, either use the PT status control area or the touch switch copy setting function. Here, the procedure for copying a memory table entry using the PT status control area is described. For the procedure for using the touch switch copy setting function, refer to *Changing Numeric Values/Character Strings by Pressing a Touch Switch That Has the Copy Setting Function* (page 326).

- Reference:**
- The PT does not check the set date and time data strictly. Therefore the data must be set correctly so that there is no discrepancy between the date and the day of a week.
 - The procedure used to copy between memory table entries is different when NT30/620 compatible mode is being used. Refer to *Appendix C* for details on the NT20S and NT30/620 compatible modes.

Setting

Prepare two numeral memory table entries to write the required values for copying it to numeral memory table entries 254 and 255.

- PC Address: Any word in the host
- Words: 2 words
- Storage Type: Binary

Use the PT status control area to copy memory table entries. Since the PT control area must be allocated words in the host, no setting is necessary for copying memory table entries.

Operation

In the PT status control area, the following areas are provided to be used for copying the data between memory table entries.

- Second word from the beginning (word $n + 1$)
Copy source memory table entry number
- Third word from the beginning (word $n + 2$)
Copy destination memory table entry number
- Fourth word from the beginning (word $n + 3$)
Memory table entry type (bit 2) and PT status control bit specifying the execution of copying (bit 3)

(n: First word address in the PT status control area)

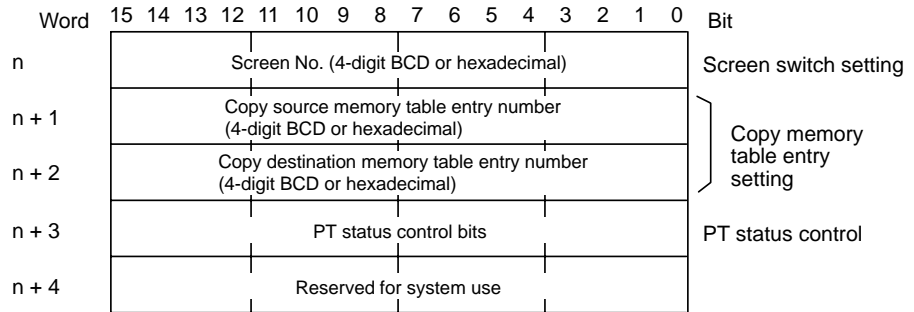

The configuration and functions of these words are different when the PT is in NT20S or NT30/620 compatible mode.

PT Status Control (word n + 3)

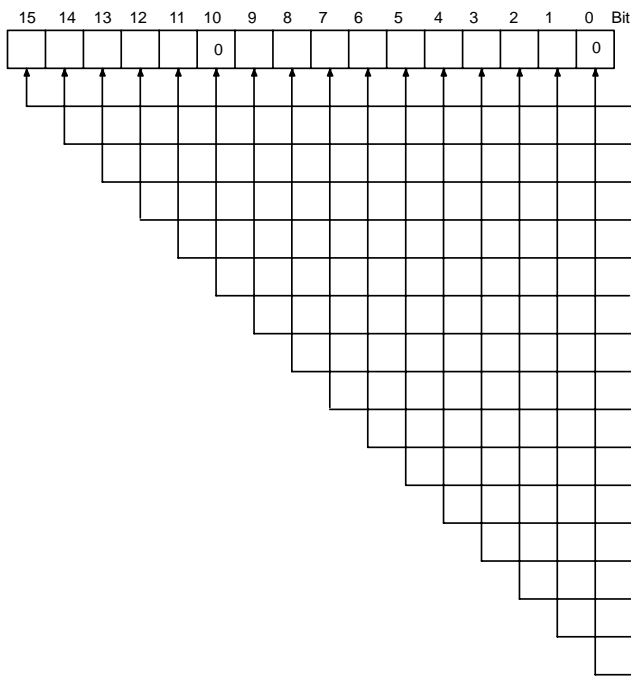

Controlled Item	1 (ON)	0 (OFF)
15 Screen display	Performed	Not performed
14 Processing priority registration (for NT link (1:N))	Registered	Canceled
13 Continuous buzzer	Sounded	Stopped
12 Intermittent buzzer (short)	Sounded	Stopped
11 Display history initialization	Performed	Not performed
10 Not used	Always 0	
9 Intermittent buzzer (long)	Sounded	Stopped
8 Backlight mode	Lit	Flashing
7 Screen printing	Performed	Not performed
6 PT window opening	Disabled	Enabled
5 Numeral/character string input	Disabled	Enabled
4 PT screen switching	Disabled	Enabled
3 Memory table copy execution	Performed	Not performed
2 Memory table copy type	Numeral	Character string
1 Alarm history initialization	Performed	Not performed
0 Not used	Always 0	

Bits 2 and 3 are not used when the PT is in NT20S or NT30/620 compatible mode.
Bit 7 is not supported by the NT21.

The operation for setting the date and time data is described below.

The following explains the operation for copying the numeric value from copy source numeral memory table entry A to copy destination numeral memory table entry 254 and from copy source numeral memory table entry B to copy destination numeral memory table entry 255. The numeric values in numeral memory table entries A and B are stored in BCD.

- 1, 2, 3... 1. Set the date and time data in the words allocated for numeral memory table entry A (word A and word A+1, in the illustration below).

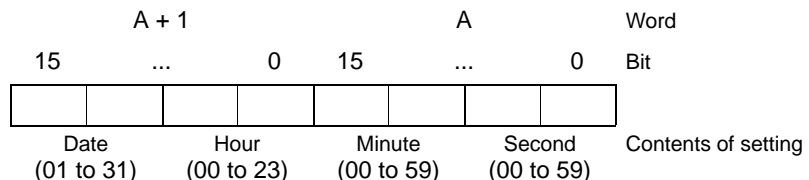

2. Set the date and time data in the words allocated numeral memory table entry B is (word B and word B+1, in the illustration below).

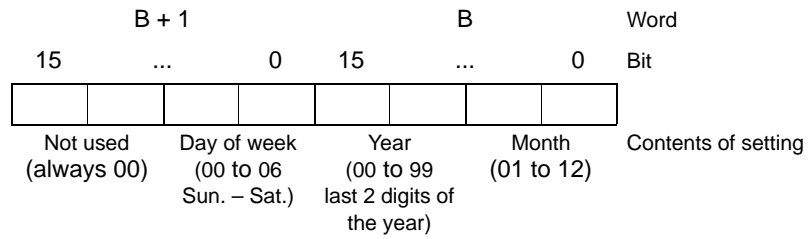

3. Write the memory table entry numbers to the PT status control area in 4-digit BCD as shown below (designation of copy source and copy destination memory table entry numbers).
 - Second word from the beginning (word n + 1): Table entry number of numeral memory table entry A
 - Third word from the beginning (word n + 2): 0254
4. Set 1 (ON) for bit 2 of the fourth word (word n + 3) from the beginning of the PT status control area (designation of memory table copy type as numeric value).
5. Set 1 (ON) for bit 3 of the fourth word (word n + 3) from the beginning of the PT status control area (designation of memory table copy execution).
The contents of numeral memory table entry A are copied to numeral memory table entry 254 and the date, hour, minute, second are set for the PT.
6. Write the memory table entry numbers to the PT status control area in 4-digit BCD as shown below (designation of copy source and copy destination memory table entry numbers).
 - Second word from the beginning (word n + 1): Table entry number of numeral memory table B
 - Third word from the beginning (word n + 2): 0255
7. Set 1 (ON) for bit 2 of the fourth word (word n + 3) from the beginning of the PT status control area (designation of memory table copy type as numeric value).
8. Set 1 (ON) for bit 3 of the fourth word (word n + 3) from the beginning of the PT status control area (designation of memory table copy execution).
Contents of numeral memory table entry B are copied to numeral memory table entry 255 and the day of week, year, and month are set for the PT.

Example of Use

Refer to the *Example of Use* (page 360) in 3-10-2 *Displaying the Date and Time*.

3-10-2 Displaying the Date and Time

The procedure for displaying the date and time data set using the clock function of the PT by the numeric value display of numeral memory table entries 247 to 253 is described below.

Numeral memory table entries 247 to 253 store the date and time data as shown below. With the NT31/NT31C or NT631/NT631C, the data is updated according to the clock built into the PT. With the NT21, the data is updated with the values read from the words allocated for the Clock Data Area in the host.

Numeral memory table entry	Contents	Range	Comment
247	Sec.	0 to 59	
248	Min.	0 to 59	
249	Hour	0 to 23	24-hour notation
250	Date	1 to 31	
251	Month	1 to 12	
252	Year	0 to 99	Last 2 digits of the year
253	Day of week	0 to 6	Sunday through Saturday

The date and time data are stored in signed binary data in a numeral memory table entry. Therefore, to display a numeric value, it is necessary to set Decimal for Display Type.

Setting

Register the numeric value display for the display of contents of numeral memory table entries 247 to 253 for the screen according to the date and time data to be displayed.

The Display Type of Numeral Display must be Decimal. Set other properties according to the display requirements.

Operation

The current date and time are continually displayed by the Numeral Display for displaying numeral memory table entries 247 to 253.

Example of Use

The following describes an example of how to display the date and time, set at the PC, on the NT31/NT31C or NT631/NT631C.

In this example a C200HX, which has a clock function, is used. The clock function is allocated words AR18 to AR21 in the C200HX.

Setting at the Support Tool

Set using the Support Tool as indicated below:

- PT status control area allocated words: 00100 (CIO area, word 100)
- Numeral memory table entry 264: DM0000 (number of words: 2)
- Numeral memory table entry 265: DM0002 (number of words: 2)

- Contents to be registered to the screen: Numeric value display (numeral memory table entries 247 to 252)

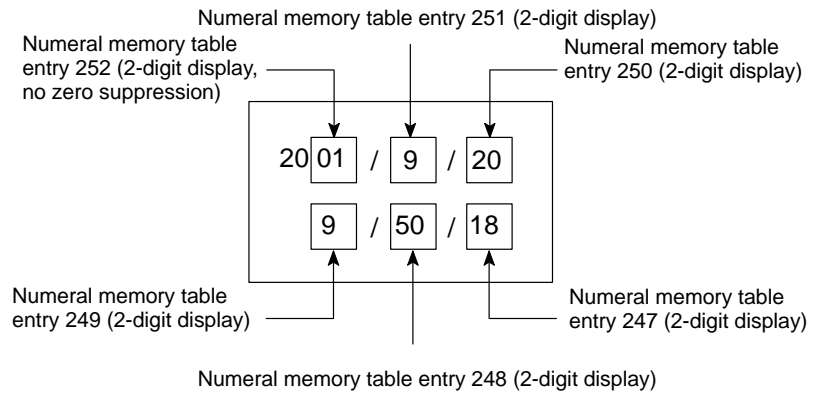

PC Program

Create the PC ladder program as shown below.

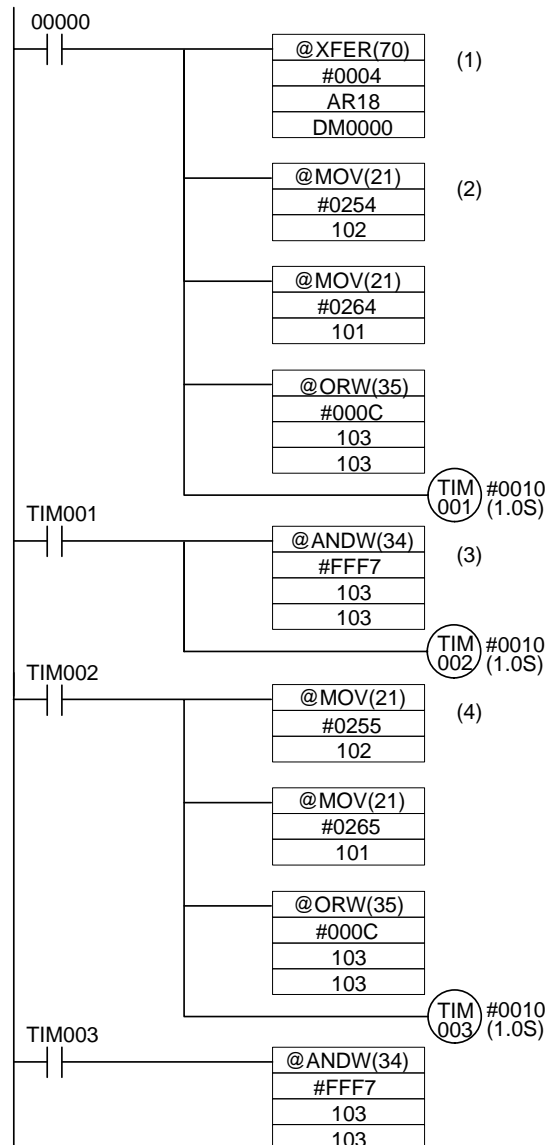

Program Operation

When the program is executed after displaying the created screen on the PT, the operation is controlled as follows:

- 1, 2, 3...**
1. When bit 00000 comes ON, the date and time (AR 18 to AR 21) set in the PC is read, and written to words (DM0000 to DM0003) allocated for numeral memory table entries 264 and 265.
 2. The contents in numeral memory table entry 264 (day, hour, minute, second) are copied to numeral memory table entry 254, which is used for setting the clock function.
 3. After waiting about a second for the completion of the memory table copy operation in step (2), the memory table copy execution bit (10303) is returned to the OFF status.
 4. After a wait of about one second for the PT to confirm that the memory table copy execution bit has gone OFF, the program copies the contents of numeral memory table entry 265 (day of the week, year, month) to numeral memory table entry 255, which is used for setting the clock function, in the same way as described in steps (2) and (3) above.

The date and time set at the PC is set for the PT and displayed.

- Reference:**
- Only the last two digits of the year are displayed. If all four digits of the year need to be display, append the first two fixed characters to the PC's variable year digits year as required (19□□).
 - The structure of the clock data in the NT21 is the same as the structure of the words containing the clock data in the CS/CJ-series and C-series PCs. If these words are allocated for the Clock Data Area with the NT21, then the clock data will be automatically synchronized during operation if the words are allocated.

3-11 Printing Data and Checking the Printer Status

The following data can be output to a printer connected to the NT31/NT31C or NT631/NT631C while the PT is operating. (A printer cannot be connected to the NT21.)

- Hard copy of the screen

The status of the printer connected the PT can be checked from the host.

This section describes the procedure for printing data during operation and also the procedure for checking the printer operating status.

- Reference:**
- In addition to the hard copy of the screen, some kinds of data can be output to a printer using the System Menu. For details of printing using the System Menu, refer to *Displaying and Printing the Display History Record* and *Displaying and Printing the Alarm History Record* in section 6 in the *Setup Manual*.
 - The Printer Controller and Print Method used by the PT for printing are set by the memory switches on the PT.

Checking the Printer Operating State

The printer operating status information in the PT status notify area indicates whether the printer is operating or not.

- Reference:** When NT30/620 compatible mode is being used, the current screen number occupies the first word of the PT status notify area and the words containing the updated memory table entry number and PT status notify bits are shifted down one word (page 457).

Setting

The PT status notify area must be allocated words in the host. No special settings are required for reading the status.

Operation

The bit used to notify the PT status (PT status notify bit) is provided at the second word (word m + 1) from the beginning in the PT status notify area.

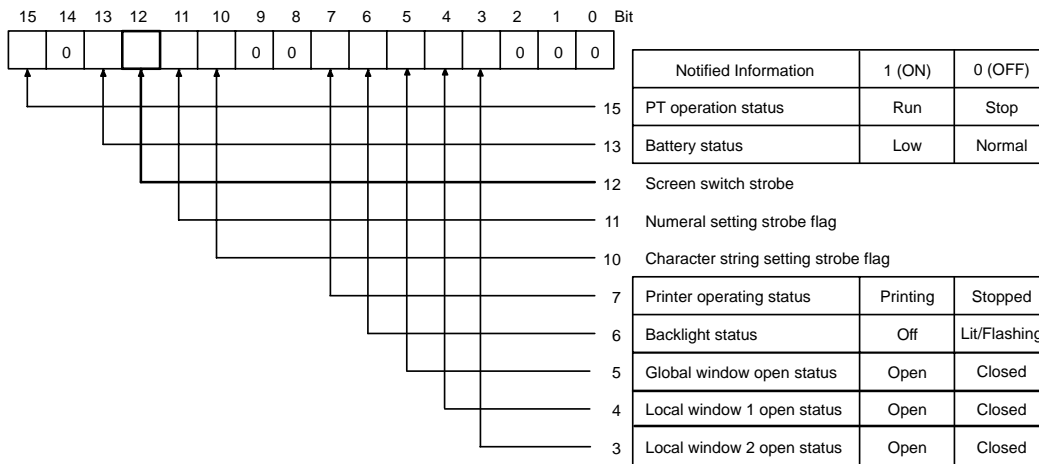

Bit 7 is not supported by the NT21.

To check the operating status of the printer, operate the PT status notify area in the manner shown below.

Read the second word (word m + 1) from the beginning in the PT status notify area. Bit 7 in the PT status notify bits shows the operating status of the printer.

- 0 (OFF): Stopped
- 1 (ON): Printing

3-11-1 Printing the Screen

With the PT, the screen currently displayed can be printed by using either of the procedures indicated below.

- By the operation at the PT status control area
- By pressing a touch switch with the print screen function.

Printing a Hard Copy by Operation at the PT Status Control Area

When this method is used, an operator can print a hard copy of the screen at any time.

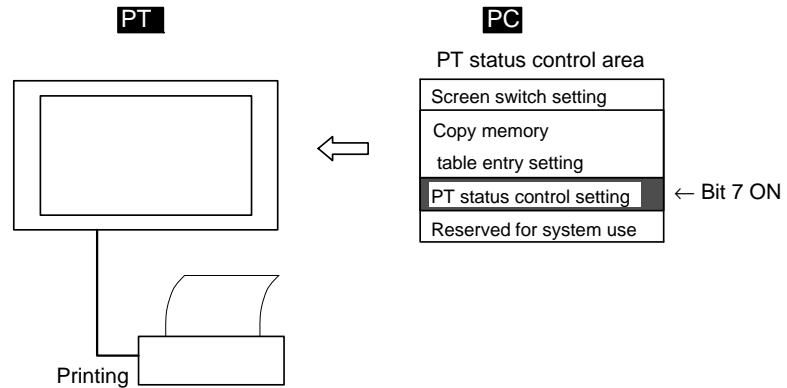

- Reference:**
- The PT continues operation even while the screen hard copy is being printed.
 - It is necessary to ensure that the printer operation status (bit 7) among the PT status notify bits is 0 (OFF) before starting printing.
 - Once screen printing has been started by operation of the PT status control bit, it is not possible to stop printing.
 - If screen printing is specified during printing by the PT, the screen printing instruction is ignored.

Setting

Words must be allocated for the PT status control area in the host. No special settings are required for printing a hard copy of the screen.

Operation

The bit used to control the PT status (PT status control bit) is provided at the fourth word (word n + 3) from the beginning in the PT status control area.

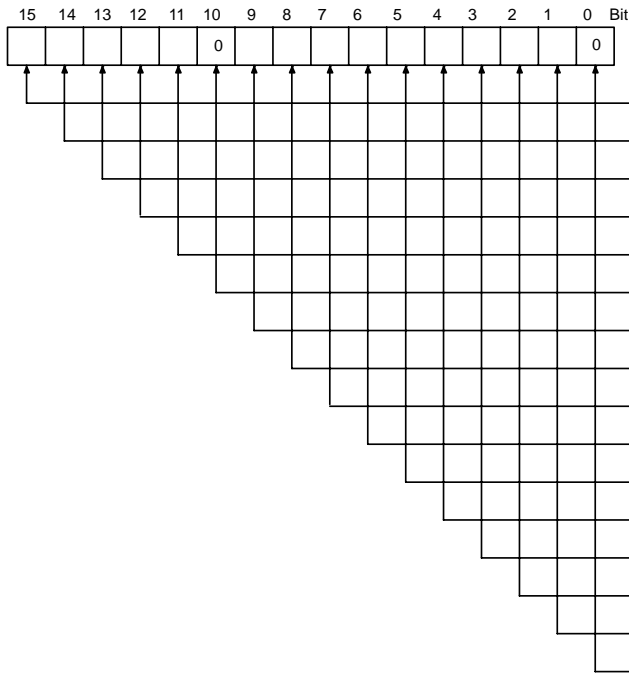

Controlled Item	1 (ON)	0 (OFF)
Screen display	Performed	Not performed
Processing priority registration (for NT link (1:N))	Registered	Canceled
Continuous buzzer	Sounded	Stopped
Intermittent buzzer (short)	Sounded	Stopped
Display history initialization	Performed	Not performed
Not used	Always 0	
Intermittent buzzer (long)	Sounded	Stopped
Backlight mode	Lit	Flashing
Screen printing	Performed	Not performed
PT window opening	Disabled	Enabled
Numeral/character string input	Disabled	Enabled
PT screen switching	Disabled	Enabled
Memory table copy execution	Performed	Not performed
Memory table copy type	Numeral	Character string
Alarm history initialization	Performed	Not performed
Not used	Always 0	

Bits 2 and 3 are not used when the PT is in NT20S or NT30/620 compatible mode.
Bit 7 is not supported by the NT21.

To print the hard copy of the screen, operate the PT status control area in the manner shown below.

- 1, 2, 3...**
1. Read the second word (word m + 1) from the beginning in the PT status notify area and make sure that bit 7 (printer operating status) in the PT status notify bits is 0 (OFF). (page 363)
 2. Set 1 (ON) for bit 7 in the fourth word (word n + 3) from the beginning in the PT status control area.

Printing a Hard Copy by Pressing a Touch Switch with the Print Screen Function

If this method is used, the screen can be printed out by operation at the PT. To use this method for printing the screen, however, a touch switch that has the print screen function must be registered for the screen.

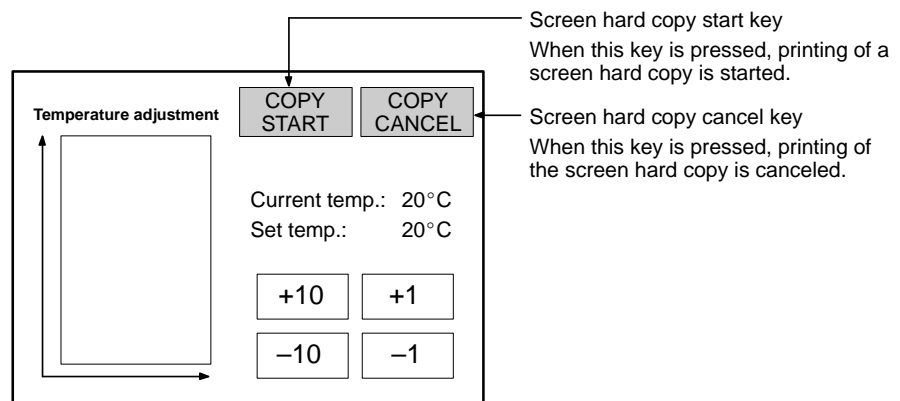

- Reference:**
- The PT continues operation even while the screen hard copy is being printed.
 - By registering a touch switch with the print stop function, it is possible to stop printing by using this touch switch.
 - Inputs by touch switches can be disabled by setting the interlock function for the switch and turning OFF the host's interlock bit that controls the switch. See *Controlling PT Operations with Interlock Bits* on page 369 for details.
-

Setting

When creating a screen using the Support Tool, set the function Print Screen for a touch switch, set Start as the function, and register the touch switch for the screen.

If necessary, also register a touch switch for which the Abort function is set for Print Screen for the screen.

Operation

To start or stop screen printing, press the touch switch with the Print Screen function (Start for starting screen printing and Abort for stopping screen printing).

3-12 Enabling/Disabling PT Operations

For the following functions of the PT, operations can be enabled or disabled by instructions from the host.

- Opening a window (with PT status control bits)
- Inputting numeric values and character strings (with PT status control bits or interlock bits)
- Switching the screen (with the PT status control bits)
- Operating touch switches (with interlock bits)
- Recipe object operations (with PT status control bits or interlock bits)

The procedure for enabling and disabling operation at the PT by instructions from the host is described below.

3-12-1 Enabling and Disabling the Operation of the PT

Operation at the PT can be enabled or disabled from the host using the following methods.

- By operation at the PT status control area
- By operation of interlock bits

Reference:

- When window opening has been disabled with a PT status control bit, all kinds of window opening operations at the PT, such as operations that use a touch switch or screen property setting, are not possible. Note that window close operations are still possible.
 - When the input of numeric values and character strings has been disabled with a PT status control bit, all kinds of numeric value and character string change operations at the PT, such as numeric value input (numeric key type input field, thumbwheel type input field), character string input, copying memory table entries using a touch switch, and recipe data editing, are not possible. Note that operations to change numeric values/character strings at the PT status control area by an instruction from the host (memory table copying and screen switching by operation at the PT status control area, changing the contents of allocated words, etc.) are still possible.
 - When interlock bits are being used to control numeral inputs, character string inputs, or recipe data editing, the input fields or recipe object can be enabled/disabled independently. Regardless of the status of the interlock bits, it is always possible to use bits in the PT status control area to make changes from the host such as copying memory table entries or changing the contents of allocated words.
 - When screen switching is disabled with the bit in the PT status control area, all kinds of screen switching operations at the PT, such as screen switching using a touch switch and by the alarm list/history function, are not possible. Note that the display of the System Menu using the touch panel and screen switching by an instruction from the host using the PT status control area are still possible.
 - When the operation of touch switches is being controlled with interlock bits, the touch switches can be enabled/disabled independently regardless of each touch switch's function.
 - It is possible to disable the input and change operation using the System Menu and the display of the System Menu by setting in the System Installer mode. (Refer to the *Setup Manual*.)
-

Controlling the Enabling/Disabling of PT Side Operation by Operation at the PT Status Control Area

Use this method to enable and disable PT operations from the host. PT operations that can be controlled include opening windows, inputting numeric values and character strings, and switching screens.

Setting

Words must be allocated for the PT status control area in the host. No special settings are required for reading the operation at the PT.

Operation

Bits used to control the PT status (PT status control bits) are provided at the fourth word (word n + 3) from the beginning in the PT status control area.

- Bit 6: Enabling/disabling the PT side window opening
- Bit 5: Enabling/disabling the inputting of numeric values and character strings
- Bit 4: Enabling/disabling the PT side screen switching

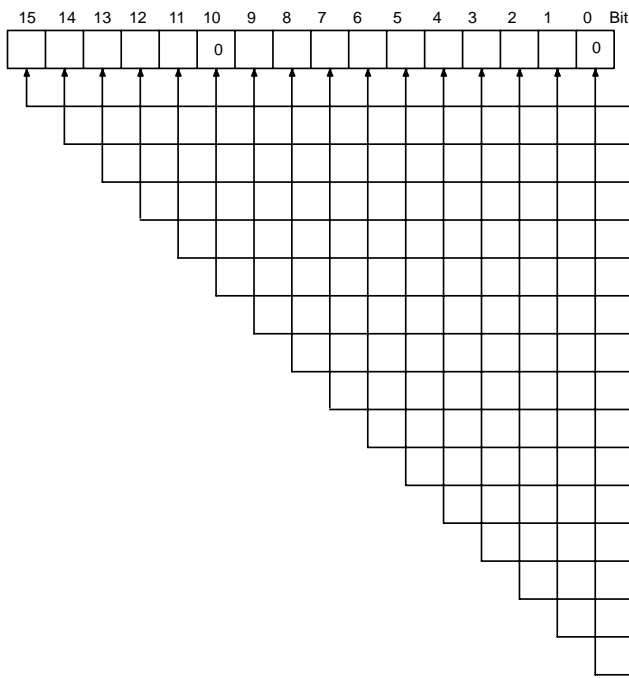

Controlled Item	1 (ON)	0 (OFF)
15 Screen display	Performed	Not performed
14 Processing priority registration (for NT link (1:N))	Registered	Canceled
13 Continuous buzzer	Sounded	Stopped
12 Intermittent buzzer (short)	Sounded	Stopped
11 Display history initialization	Performed	Not performed
10 Not used	Always 0	
9 Intermittent buzzer (long)	Sounded	Stopped
8 Backlight mode	Lit	Flashing
7 Screen printing	Performed	Not performed
6 PT window opening	Disabled	Enabled
5 Numeral/character string input	Disabled	Enabled
4 PT screen switching	Disabled	Enabled
3 Memory table copy execution	Performed	Not performed
2 Memory table copy type	Numeral	Character string
1 Alarm history initialization	Performed	Not performed
0 Not used	Always 0	

Bits 2 and 3 are not used when the PT is in NT20S or NT30/620 compatible mode.
 Bit 7 is not supported by the NT21.

To control the operation by the PT while it is running, operate the PT status control area in the manner shown below.

Change the setting of the bits in the fourth word (word n + 3) from the beginning in the PT status control area as indicated below according to the required control.

word n + 3

- Bit 6: To control the PT side window opening
- Bit 5: To control the inputting of numeric values and character strings
- Bit 4: To control PT side screen switching
 To disable operation: 1 (ON)
 To enable operation: 0 (OFF)

Controlling PT Operations with Interlock Bits

Use this method to enable and disable PT operations from the host. PT operations that can be controlled include touch switch operations, numeric inputs, character string inputs, and recipe data editing. Operations are controlled individually.

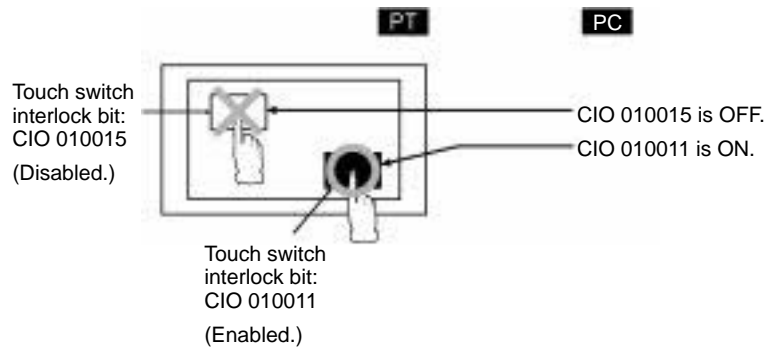

Setting

When creating a screen with the Support Tool, set the interlock function for the desired touch switch, numeral input field, thumbwheel switch, character string input field, or recipe object and allocate an interlock bit in the host.

Operation

Turn the corresponding interlock bit ON or OFF to enable or disable a touch switch, numeral input, character string input, or recipe data editing.

Interlock bit OFF: Disable switch or input.

Interlock bit ON: Enable switch or input.

Reference: The PT continuously reads the status of the corresponding interlock bit while the switch or input that uses the interlock function is being displayed on the screen. If the interlock bit's status changes, the switch or input's operation is disabled or enabled according to the interlock bit's status.

SECTION 4

Using Memory Link

This section gives an overview of memory link operations and contains explanations centered on communications between the PT and host when using memory link.

4-1	Operation of the Memory Link	372
4-1-1	PT Memory	372
4-1-2	Memory Link Commands	372
4-2	Outline of Communications	374
4-2-1	Communication Protocol	374
4-2-2	Notes on Using Commands	375
4-3	Commands/Responses	377
4-3-1	PT Memory Read Command (Sent from Host to PT)	377
4-3-2	Numeral Memory Table Read Command (Sent from Host to PT)	378
4-3-3	Character String Memory Table Read Command (Sent from Host to PT)	379
4-3-4	Bit Memory Table Read Command (Sent from Host to PT)	380
4-3-5	Screen Data Comment Read Command (Sent from Host to PT)	382
4-3-6	System Status Read Command (Sent from Host to PT)	382
4-3-7	PT Memory Write Command (Sent from Host to PT)	383
4-3-8	Numeral Memory Table Write Command (Sent from Host to PT)	384
4-3-9	Character String Memory Table Write Command (Sent from Host to PT)	385
4-3-10	Bit Memory Table Write Command (Sent from Host to PT)	386
4-3-11	PT Memory Batch Write (FILL) Command (Sent from Host to PT) ..	388
4-3-12	Numeral Memory Table Clear Command (Sent from Host to PT)	388
4-3-13	Character String Memory Table Clear Command (Sent from Host to PT)	389
4-3-14	Bit Memory Table Clear Command (Sent from Host to PT)	390
4-3-15	Touch Switch Input Notify Command (Sent from PT to Host)	391
4-3-16	Numerical Input Notify Command (Sent from PT to Host)	392
4-3-17	Character String Input Notify Command (Sent from PT to Host)	393
4-3-18	Direct Area Changing Notify Command (Sent from PT to Host)	394
4-3-19	PT Memory Changing Notify Command (Sent from PT to Host)	396
4-3-20	PT Operation Mode Switching Command (Sent from Host to PT) ...	397
4-3-21	Re-send Request Command (Sent from Host to PT)	398
4-3-22	Error Response (Sent from PT to Host)	398
4-4	Memory Link Online Transfer Function	400
4-4-1	Online Transfer Processes	400
4-4-2	Required Conditions	401
4-4-3	Example Applications	401

4-1 Operation of the Memory Link

This section describes the function of the memory link. For outline of the function of memory link, refer to *1-5 Communication by Using Memory Link*.

4-1-1 PT Memory

With memory link, allocation of element bit or word is performed for PT memory. The PT memory is a virtual PC area within the PT. The PT read/write to the internal PT memory and a host controls/monitors the PT by reading/writing PT memory.

With PT memory, there is no classification of the area as there is with real PC areas: it consists of a memory link area of just 10000 words from 0000 to 9999. Memory link can be treated in exactly the same way as direct connections such as host link and NT link, except that the words to be allocated differ. The specification of bits is also the same.

A diagram of the PT memory is shown below.

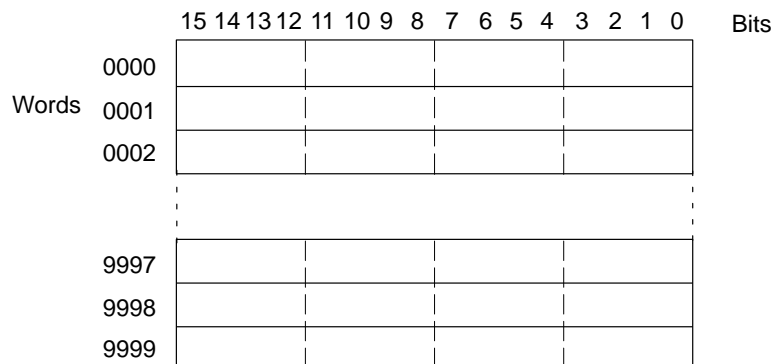

- Reference:**
- The PT memory is backed up by the battery even while the PT power is OFF.
 - The explanations in this section concentrate on the memory link communication method. For details on control and notification between the PT display elements and the PT memory, refer to *Section 2 PT Functions* and *Section 3 How to Use the PT*.

4-1-2 Memory Link Commands

When using the memory link, data is sent and received between the host and PT using commands such as those indicated below.

Data Read Commands/Responses

These are the commands for reading the contents of the PT memory and memory table in the PT. They are issued from the host and, as the response, the PT sends back to the specified data

There are the following six commands.

- PT memory read command Page 377
- Numeral memory table read command Page 378
- Character-string memory table read command Page 379
- Bit memory table read command Page 380
- Screen data comment read command Page 382
- System status read command Page 382

Data Write Commands/Responses

These are the commands for writing data to the PT memory and memory table entries in the PT. They are issued from the host and, as the response, the PT sends a reply indicating whether or not writing was completed normally. It is possible to omit the response by a memory switch setting when writing is successful.

There are the following eight commands.

- PT memory write command Page 383
- Numeral memory table write command Page 384
- Character-string memory table write command Page 385
- Bit memory table write command Page 386
- PT memory batch write (FILL) command Page 388
- Numeral memory table clear command Page 388
- Character-string memory table clear command Page 389
- Bit memory table clear command Page 390

Notify Commands

These commands serve to notify the host of the results of operation at the PT. Only these commands are issued by the PT and, therefore, there is no response for them.

There are the following five commands.

- Touch switch input notify command Page 391
- Numerical input notify command Page 392
- Character string input notify command Page 393
- Direct area changing notify command Page 394
- PT memory changing notify command Page 396

Operation Mode Switching Command

This command switches the PT operation mode from RUN mode to transmit mode. It is issued from the host and switches the PT operation mode.

- PT operation mode switching command Page 397

Re-send Command

This command lets the PT re-send a notify command. It is issued from the host and the notify command issued last is re-sent from the PT.

- Re-send request command Page 398

Error Response

This is a response from the host that is issued when the contents of command transmitted to the PT was incorrect.

- Error response Page 398

4-2 Outline of Communications

This section describes the basic communication protocol when using memory link and the program flow for using memory link, taking RS-232C communications using the BASIC language as an example.

4-2-1 Communication Protocol

Communication between the host and the PT takes place in accordance with the following protocol.

- 1, 2, 3...
1. In order to perform communications, it is necessary to open the communication line. Opening here means making the line usable.
 2. In accordance with the commands, the PT is controlled or notification is received from the PT.
 3. To terminate communication, close the communication line.

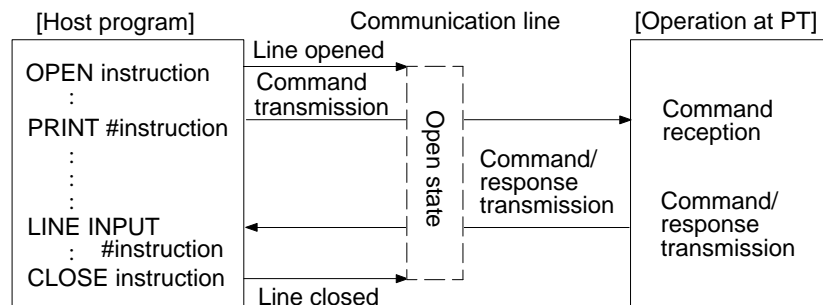

Once the line has been opened, it can be used until it is closed.

Function of Each Command

- OPEN command:** Opens the RS-232C line. Also sets the communication conditions at the host side. Refer to the *Setup Manual* for details.
- PRINT # command:** Sends commands to the PT via an RS-232C line.
- LINE INPUT # command:** Receives the command or response from the PT. In order to receive input delimited by commas and double quotation marks, use LINE INPUT.
- CLOSE command:** Closes the RS-232C line.

For detailed information on commands, refer to the BASIC language command manual for the host.

Operation When Using Commands

The flow of communications between the host and the PT follows one of the three patterns indicated below, depending on the types of command and the settings made for response with the memory switches. Refer to section 6 of the *Setup Manual* for details.

- Pattern with write command when No is set for the response

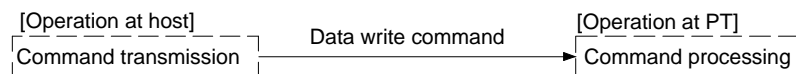

However, when an error occurs, an error response is returned.

- Pattern with data read command, re-send command, and data write command when response Yes is set.

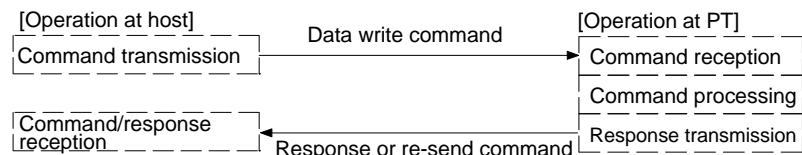

Sometimes multiple responses may be received for one command.

- Pattern when the operation at the PT is notified to the host.

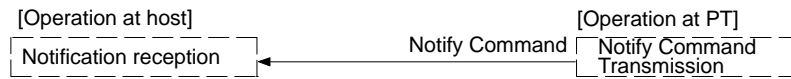

4-2-2 Notes on Using Commands

The points that should be observed when using commands are given below.

Method for Specifying Commands

When a personal computer or similar device is used as the host and a high-level language such as BASIC or C is used for program writing, commands are specified as ASCII character strings.

Note that in the explanations in this section, parameters are denoted in lower case characters. When specifying a command, write those parts denoted in upper case without modification, for those parts denoted in lower case, write the numeric values (BCD or hexadecimal) or character string for parameters as ASCII character strings. Parts in square brackets, such as [ESC] and [CR] each indicate one control code (the [ESC] code, the [CR] code, etc.).

In the explanations of commands, expressions such as 4 BCD digits and 2 hexadecimal digits are used to mean (respectively) the ASCII character string for a numerical value expressed as four BCD digits and the ASCII character string for a numerical value expressed as two hexadecimal digits, etc. Do not specify BCD and hexadecimal data without alteration: always convert it into an ASCII character string before transmission.

Example: The format for the numeral value memory table read command is shown below.

[ESC]	R	M	m	t1	t2	t3	t4
1B	52	4E	* *	* *	* *	* *	* *
	(l1)	(l2)	(s1)	(s2)	[CR]		
	* *	* *	* *	* *	0D		

The following parameters are specified in this format.

- m: 1 (1 BCD digit)
- t₁, t₂, t₃, t₄: 0123 (4 BCD digits)
- l₁, l₂: 99 (2 BCD digits)
- s₁, s₂: 24 (2 hexadecimal digits)

The character string actually transmitted is as shown below.

[ESC]	R	N	1	0	1	2	3
1B	52	4E	31	30	31	32	33
	9	9	2	4	[CR]		
	39	39	32	34	0D		

Reference: In the Format sections in the explanations for commands/responses, parentheses are used to indicate parts that can under some circumstances be omitted, and ** is used to indicate the ASCII code (two hexadecimal digits) of the specified character.

Processing Differences According to Command Length

- If a command is too long because it has been incorrectly specified, an error response for a command length error is returned.
- If a command is short because it has been incorrectly specified, a communication error (time out) occurs.

Command Transmission Intervals

- If commands are sent too frequently, processing at the PT will not be able to keep pace with them and a communication error (buffer overflow) will occur.
- Use the flow control to prevent a buffer overflow.

Order of Priority of Input Communication Commands

When a reason for input notification arises during processing of a command from the host, the input command is issued only after the ongoing command processing has been completed.

Checksum

The checksum of the command response is the 2 digits ASCII code that is indicated using lower one-byte of the total sum (in unit of bytes) of the following, from the [ESC] code at the beginning to the character immediately before the checksum value. It can be omitted by specifying the parameter used to omit sum value. If ON is set for the Comm. Auto-return memory switch, communication errors are not displayed on the screen even if they occurs. However, in case of time out error at the PT side, an error message is displayed on the screen and the operation is stopped.

Reference: Whether or not the error response is returned depends on the memory switch setting made for Comm. Auto-return and error type.
For details, refer to *Error Response* in page 398.

4-3 Commands/Responses

This section describes the commands used with the memory link and their responses.

4-3-1 PT Memory Read Command

(Sent from Host to PT)

Command

Format

[ESC]	R	M	m	c1	c2	c3	c4
1B	52	4D	* *	* *	* *	* *	* *
	(l1)	(l2)	(s1)	(s2)	[CR]		
	* *	* *	* *	* *	0D		

- m: Checksum present/absent (1 BCD digit)
 0: Absent
 1: Present
 8: Absent (1 word read)
 9: Present (1 word read)
- c₁ to c₄: First word address read (4 BCD digits)
 0000 to 9999
- l₁, l₂: Number of read words (2 BCD digits)
 00: 100 words
 01 to 99: 1 to 99 words
 When m is 8 or 9, omit this setting.
- s₁, s₂: Checksum (2 hexadecimal digits)
 When m is 0 or 8, omit this setting.

Response

Format

[ESC]	R	M	c1	c2	c3	c4	l1	l2
1B	52	4D	* *	* *	* *	* *	* *	* *
Data of 1 word			Data of 1 word					
d11	d1m	,	dn1	dnm	s1	s2	[CR]	
* *	* *	2C	* *	* *	* *	* *	* *	0D

- c₁ to c₄: First word address read (4 BCD digits)
 0000 to 9999
- l₁, l₂: Number of read words (2 BCD digits)
 01 to 50: 1 to 50 words
- d₁₁ to d_{1m}, ..., d_{n1} to d_{nm}:
 Contents of the read words (1 to 4 hexadecimal digits)
 0 to FFFF_H
 Since initial zeroes are omitted, there may be less than 4 digits.
 Individual words of data are delimited by commas.
- s₁, s₂: Checksum (2 hexadecimal digits)
 This is always added.

Function

- Reads the contents of the specified number of words from the specified word of the PT memory.
- Used to read the statuses of the PT notify area, window control area, lamps, touch switches and bit memory table entries allocated PT memory, and the contents of numeral and character string memory table entries.

- A maximum of 100 words can be read at one time.
- In the response, maximum of 50 words can be returned at one time. If reading of more than 50 words is specified, the response is split into two parts. In this case the first part always contains 50 words of data. Note also that the first word address read in the second part of the responses will be the word address of the first word in the response data.

Example

Reading the PT Status in the PT Notify Area (Allocated Words: 0010 to 0011)

Assume that the following data is stored for PT notify area:

Wd 0010	0123H
Wd 0011	8000H

Command

[ESC]	R	M	0	0	0	1	0	0	2	[CR]
1B	52	4D	30	30	30	31	30	30	32	0D

No checksum (2 word read), first word read = 0010

Response

[ESC]	R	M	0	0	1	0	0	2	
1B	52	4D	30	30	31	30	30	32	
	1	2	3	,	8	0	0	0	6
					7	[CR]			
	31	32	33	2C	38	30	30	30	36
					37	0D			

4-3-2 Numeral Memory Table Read Command (Sent from Host to PT)

Command

Format

[ESC]	R	N	m	t1	t2	t3	t4
1B	52	4E	* *	* *	* *	* *	* *
	(l1)	(l2)	(s1)	(s2)	[CR]		
	* *	* *	* *	* *	0D		

- m: Checksum present/absent (1 BCD digit)
0: Absent
1: Present
8: Absent (1 table entry read)
9: Present (1 table entry read)
- t₁ to t₄: First numeral memory table entry read (4 BCD digits)
0000 to 1999
- l₁, l₂: Number of read table entries (2 BCD digits)
00: 100
01 to 99: 1 to 99
When m is 8 or 9, omit this setting.
- s₁, s₂: Checksum (2 hexadecimal digits)
When m is 0 or 8, omit this setting.

Reference: The maximum number that can be specified for first numeral memory table entry read depends on the setting for numbers of numeral table entries (512/1000/2000) made at the Support Tool.

Response

Format

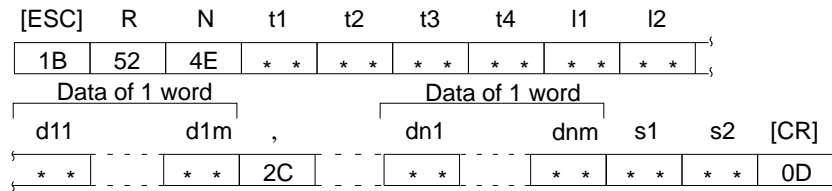

- t₁ to t₄: First numeral memory table entry number read (4 BCD digits)
0000 to 1999
- l₁, l₂: Number of read table entries (2 BCD digits)
01 to 20: 1 to 20 table entries
- d₁₁ to d_{1m}, ..., d_{n1} to d_{nm}:
Contents of the read numeral memory table entries (1 to 8 hexadecimal digits)
0 to FFFFFFFFH
Since initial zeroes are omitted, there may be less than 8 digits.
The data for individual table entries is delimited by commas.
- s₁, s₂: Checksum (2 hexadecimal digits)
This is always added.

Function

- Reads the data from the specified number of numeral memory table entries, starting from the specified numeral memory table entry.
- A maximum of 100 table entries can be read at one time.
- In the response, the data of maximum of 20 table entries can be returned at one time. If reading of more than 20 table entries is specified, multiple responses are made, each comprising the data of 20 table entries. Note that the first word address read in the second and later responses will be the word address of the first word of the response data.

4-3-3 Character String Memory Table Read Command
(Sent from Host to PT)

Command

Format

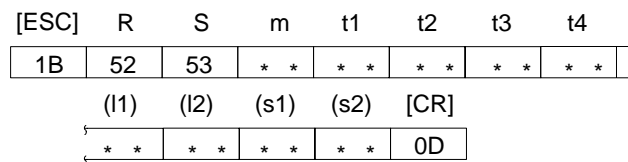

- m: Checksum present/absent (1 BCD digit)
0: Absent
1: Present
8: Absent (1 table entry read)
9: Present (1 table entry read)
- t₁ to t₄: First character string memory table entry read (4 BCD digits)
0000 to 1999
- l₁, l₂: Number of read table entries (2 BCD digits)
01 to 20: 1 to 20
When m is 8 or 9, omit this setting.
- s₁, s₂: Checksum (2 hexadecimal digits)
When m is 0 or 8 omit this setting.

Reference: The maximum number that can be specified for first character string memory table entry read depends on the setting for numbers of character string table entries (256/1000/2000) made at the Support Tool.

Response

Format

[ESC]	R	S	t1	t2	t3	t4	d11	d12	...
1B	52	53	* *	* *	* *	* *	* *	* *	...
			dn1	dn2	s1	s2	[CR]		
			* *	* *	* *	* *	0D		

- t₁ to t₄: First character string memory table entry read (4 BCD digits) 0000 to 1999
- d₁₁, d₁₂, ..., dn₁, dn₂: Contents of the read character string memory table entries (2 digits (hexadecimal) corresponding to 1 to 40 characters) 00 to FF_H (CP437 or ISO 8859-1)
- s₁, s₂: Checksum (2 hexadecimal digits) This is always added.

Function

- Reads the data of the specified number of character string memory table entries, starting from the specified character string memory table entry.
- A maximum of 20 table entries can be read at the same time.
- In the response, data is returned in units of one table entry at a time. If reading of multiple table entries is specified, a number of responses equal to the specified number of table entries is made. Note that the read character string memory table entry number is always the number of the data of the response.

4-3-4 Bit Memory Table Read Command (Sent from Host to PT)

Command

Format

[ESC]	R	B	m	t1	t2	t3	t4
1B	52	42	* *	* *	* *	* *	* *
		(l1)	(l2)	(s1)	(s2)	[CR]	
		* *	* *	* *	* *	0D	

- m: Checksum present/absent (1 BCD digit)
 - 0: Absent
 - 1: Present
 - 8: Absent (1 table entry read)
 - 9: Present (1 table entry read)
- t₁ to t₄: First bit memory table entry number read (4 BCD digits) 0000 to 0999
- l₁, l₂: Number of read table entries (2 BCD digits)
 - 00: 100
 - 01 to 99: 1 to 99
 When m is 8 or 9, omit this setting.
- s₁, s₂: Checksum (2 hexadecimal digits) When m is 0 or 8, omit this setting.

Reference: The maximum number that can be specified for first bit memory table entry read depends on the setting for numbers of bit memory table entries (256/1000) made at the Support Tool.

Response

Format

[ESC]	R	B	t1	t2	t3	t4	l1	l2	d11	d12	d13	d14	,							
1B	52	42	* *	* *	* *	* *	* *	* *	* *	* *	* *	* *	* *							2C
			dn1	dn2	dn3	dn4	s1	s2	[CR]											
			* *	* *	* *	* *	* *	* *	0D											

t₁ to t₄: First bit memory number table entry read (4 BCD digits)
0000 to 0999

l₁, l₂: Number of read table entries (2 BCD digits)
00: 100 table entries
01 to 99: 1 to 99 table entries

d₁₁, d₁₂, d₁₃, d₁₄, ..., dn₁, dn₂, dn₃, dn₄: Contents of the read bit memory table entries (4 hexadecimal digits, × n)
0000 to FFFF_H
The contents of bit memory table entries are represented as 1 bit data (OFF=0, ON=1) and 16 entries of bit memory table are read out as 4 hexadecimal digits value. (Table entries with smaller number is the rightmost bit.)
The bit memory table data is delimited by commas by each 16 table entries.

s₁, s₂: Checksum (2 hexadecimal digits)
This is always added.

Function

- Reads the data of the specified number of bit memory table entries, starting from the specified bit memory table entry.
- A maximum of 100 table entries can be read at one time.
- If a number of table entries that is not a multiple of 16 is specified, 0 is inserted in remaining bits (leftmost bits).
- The number (n) of 4 hexadecimal digits value to be read out is as follows:
n=(number of bit memory table entries to be read-1)÷16 + 1
(¥ indicates the subtraction of the integer.)

Example

Reading bit memory table entries 23 to 40

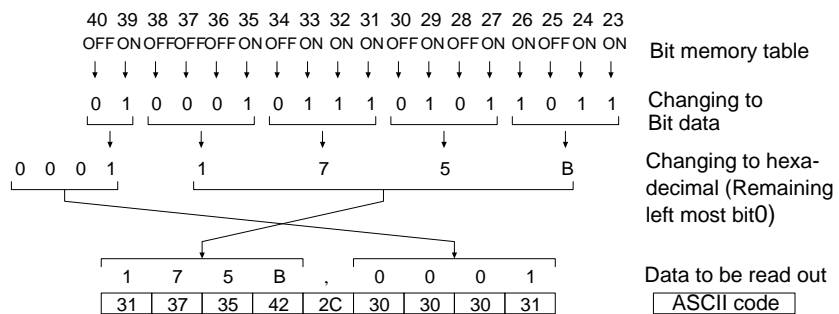

4-3-5 Screen Data Comment Read Command (Sent from Host to PT)

Command

Format

[ESC]	F	R	m	(s1)	(s2)	[CR]
1B	46	52	* *	* *	* *	0D

m Checksum present/absent (1 BCD digit)
 0: Absent
 1: Present

s₁, s₂: Checksum (2 hexadecimal digits)

Response

Format

[ESC]	F	R	d1	d2			
1B	46	52	* *	* *			
			d27	d28	s1	s2	[CR]
			* *	* *	* *	* *	0D

d₁, d₂, ..., d₂₇, d₂₈:
 Comments of the read screen data file
 (1 to 28 characters, space code (20H) is inserted in vacant area)

s₁, s₂: Checksum (2 hexadecimal digits)
 This is always added.

Function Reads the operation mode of PT.

4-3-6 System Status Read Command (Sent from Host to PT)

Command

Format

[ESC]	P	T	m	(s1)	(s2)	[CR]
1B	50	54	* *	* *	* *	0D

m Checksum present/absent (1 BCD digit)
 0: Absent
 1: Present

s₁, s₂: Checksum (2 hexadecimal digits)

Response

Format

[ESC]	P	T	0	0	s1	s2	[CR]
1B	50	54	30	30	31	46	0D

s₁, s₂: Checksum (2 hexadecimal digits)
 This is always added (fixed as 1FH).

Function

- Reads the operation mode of PT.
- The responses above will be returned when PT is in RUN mode. With the modes other than RUN mode (when RUN indicator is not lit in green), no responses will be returned even if this command is sent. Sending this command enables to know whether or not PT is running by checking the presence/absence of responses.

4-3-7 PT Memory Write Command

(Sent from Host to PT)

Command

Format

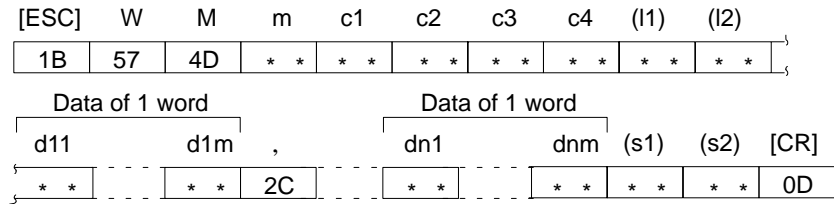

- m: Checksum present/absent, write attribute (1 BCD digit)
 - 0: Absent, SET attribute
 - 1: Present, SET attribute
 - 2: Absent, AND attribute
 - 3: Present, AND attribute
 - 4: Absent, OR attribute
 - 5: Present, OR attribute
 - 6: Absent, XOR attribute
 - 7: Present, XOR attribute
 - 8: Absent, SET attribute (writing 1 word)
 - 9: Present, SET attribute (writing 1 word)
- c₁ to c₄: First word address written (4 BCD digits)
0000 to 9999
- l₁, l₂: Number of words written (2 BCD digits)
01 to 50:1 to 50 words
If m is 8 or 9, omit this setting.
- d₁₁ to d_{1m}, ..., dn₁ to dn_m:
Data of written words (1 to 4 hexadecimal digits)
0 to FFFF_H
It is possible to omit initial zeroes so that there are less than 4 digits.
- s₁, s₂: Checksum (2 hexadecimal digits)
If m is an even number, omit this setting.

Response

Only if Yes is set for the Response memory switch, the response indicated below is returned on normal completion.

Format

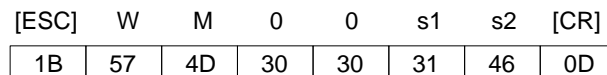

- s₁, s₂: Checksum (2 hexadecimal digits)
This is always added (fixed as 1FH).

Function

- Writes the data of the specified number of words starting from the specified word in the PT memory.
 - The result after executing the specified operation (write attribute) on the present contents of the PT memory and the written data is written is as follows:
 - A maximum of 50 words can be written at one time.
- The write attribute specified by a command executes the following operation on the present data of the PT memory and the written data and writes the result.
- SET attribute: Specified data is written as it is regardless of the present data of PT.

- AND attribute: The result after executing the AND operation on the present data of the PT and the written data is written.
- OR attribute: The result after executing the OR operation on the present data of the PT and the written data is written.
- XOR attribute: The result after executing the XOR operation on the present data of the PT and the written data is written.

Example:

Write attribute	Written data	Present data of the PT memory	Result
SET attribute	1234 _H	3456 _H	1234 _H
AND attribute	1234 _H	3456 _H	1014 _H
OR attribute	1234 _H	3456 _H	3676 _H
XOR attribute	1234 _H	3456 _H	2662 _H

4-3-8 Numeral Memory Table Write Command (Sent from Host to PT)

Command

Format

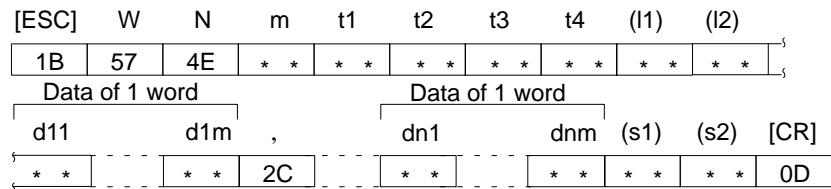

- m: Checksum present/absent (1 BCD digit)
 0: Absent
 1: Present
 8: Absent (only 1 table entry written)
 9: Present (only 1 table entry written)
- t₁ to t₄: First numeral memory number written to (4 BCD digits)
 0000 to 1999 (excluding 0247 to 0253)
- l₁, l₂: Number of written table entries (2 BCD digits)
 01 to 20: 1 to 20 table entries
 When m is 8 or 9, omit this setting.
- d₁₁ to d_{1m}, ..., dn₁ to dn_m:
 Contents of the written numeral memory table entries (1 to 8 hexadecimal digits)
 0 to FFFFFFFF_H
 It is possible to omit initial zeroes so that there are less than 8 digits.
- s₁, s₂: Checksum (2 hexadecimal digits)
 When m is 0 or 8, omit this setting.

Reference: The maximum number that can be specified for numeral memory table entries depends on the setting for numbers of numeral table entries (512/1000/2000) made at the Support Tool.

Response

Only if Yes is set for the Response memory switch, the response indicated below is returned on normal completion.

Format

[ESC]	W	N	0	0	s1	s2	[CR]
1B	57	4E	30	30	32	30	0D

s₁, s₂: Checksum (2 hexadecimal digits)
This is always added (fixed as 20H).

Function

- Writes the data of the specified number of numeral memory table entries, starting from the specified numeral memory table entries.
- A maximum of 20 table entries can be written at one time.
- When writing is executed to numeral memory table entries from No.247 to No.253 (areas for clock data display/reading use only), operation will be finished normally without writing values.

Reference:

- Data written by a numeral memory table write command is written according to the numeral storage type of the numeral. Numeral storage type can be set at the Support Tool. (It is possible to set it by a system memory at a PT collectively.)
e.g.) Writing 1234 to the numeral memory table entry 0 (allocated word: 1)

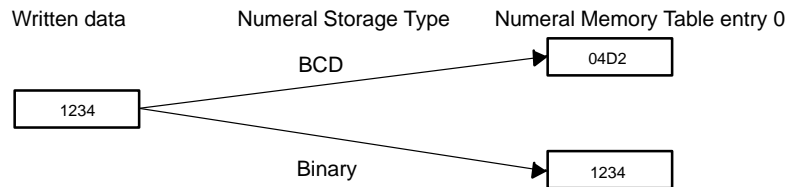

- For details of function and setting of numeral storage type, refer to the *NT-series Support Tool for Windows (Version 4) Operation Manual (V061-E1-□)*.

4-3-9 Character String Memory Table Write Command (Sent from Host to PT)

Command

Format

[ESC]	W	S	m	t1	t2	t3	t4	,
1B	57	53	* *	* *	* *	* *	* *	,
		d11	d12	dn1 dn2		(s1)	(s2)	[CR]
		* *	* *	* *		* *	* *	0D

m: Checksum present/absent (1 BCD digit)
0: Absent
1: Present

t₁ to t₄: Character string memory number written to (4 BCD digits)
0000 to 0499

d₁₁, d₁₂, ..., dn₁, dn₂: Contents of the written character string memory table entries (1 to 40 characters)

00 to FF_H

In the case of character string memory table entries allocated words in the host, specify the registered number of words multiplied by 2, and in the case of character string memory table entries not allocated words in the host, specify the data for 40 characters.

s₁, s₂: Checksum (2 hexadecimal digits)
When m is 0, omit this setting.

Reference: The maximum number that can be specified for character string memory table entries depends on the setting for numbers of character string table entries (256/1000/2000) made at the Support Tool. However, it is not possible to write to character string memory table entries of numbers higher than No.500 since they are used only as a reading area.

Response

Only if Yes is set for the Response memory switch, the response indicated below is returned on normal completion.

Format

[ESC]	W	S	0	0	s1	s2	[CR]
1B	57	53	30	30	32	35	0D

s₁, s₂: Checksum (2 hexadecimal digits)
This is always added (fixed as 25H).

Function

Writes specified data to the specified character string memory table entries.

4-3-10 Bit Memory Table Write Command

(Sent from Host to PT)

Command

Format

[ESC]	W	B	m	t1	t2	t3	t4	(l1)	(l2)	
1B	57	42	* *	* *	* *	* *	* *	* *	* *	
Data of 16 tables				Data of 16 tables						
d11		d14		dn1		dn4		(s1)	(s2)	[CR]
* *		* *		* *		* *		* *	* *	0D

m: Checksum present/absent (1 BCD digit)
0: Absent
1: Present
8: Absent (effective only when 1 table entry written)
9: Present (effective only when 1 table entry written)

t₁ to t₄: First bit memory table entry number written to (4 BCD digits)
0000 to 0999

l₁, l₂: Number of written table entries (2 BCD digits)
00: 100 table entries
01 to 99: 1 to 99 table entries
When m is 8 or 9, omit this setting.

d₁₁ to d₁₄, ..., dn₁ to dn₄: Contents of the written bit memory table entries (4 hexadecimal digits, × n)
0000 to FFFF_H
The contents of bit memory table entries are represented as 1 bit data (OFF=0, ON=1) and 16 entries of bit memory table are

specified as 4 hexadecimal digits value. (Table entries with smaller number is the rightmost bit.)
 If written data is less than 16, the specification is started from bit 0. (Remaining leftmost bit will be ignored.)
 The bit memory table data (4 hexadecimal digits) is delimited by commas by each 16 table entries.

s₁, s₂: Checksum (2 hexadecimal digits)
 When m is 0 or 8, omit this setting.

Reference: The maximum number that can be specified for bit memory table entries depends on the setting for numbers of bit memory table entries (256/1000) made at the Support Tool.

Response

Only if Yes is set for the Response memory switch, the response indicated below is returned on normal completion.

Format

[ESC]	W	B	0	0	s ₁	s ₂	[CR]
1B	57	42	30	30	31	34	0D

s₁, s₂: Checksum (2 hexadecimal digits)
 This is always added (fixed as 14H)

Function

- Writes the data of the specified number of bit memory table entries, starting from the specified bit memory table entry.
- A maximum of 100 table entries can be written at one time.
- If a number of table entries that is not a multiple of 16 is specified, 0 is inserted in remaining bits (leftmost bits).
- The number (n) of 4 hexadecimal digits value to be specified is as follows:
 $n = (\text{number of written bit memory table entries} - 1) \div 16 + 1$
 (¥ indicates the subtraction of the integer.)

Example

Writing bit memory table entries 51 to 70

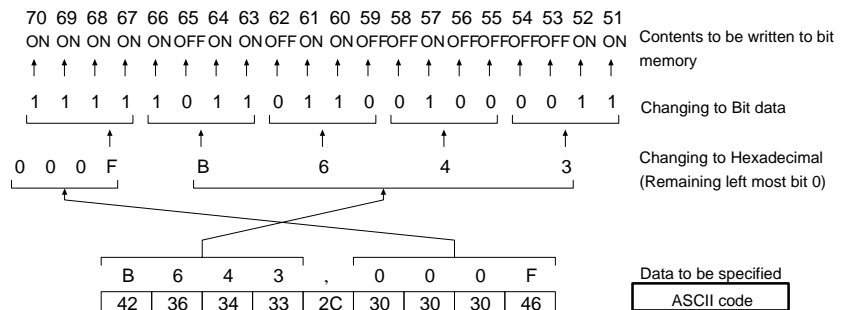

4-3-11 PT Memory Batch Write (FILL) Command (Sent from Host to PT)

Command

Format

[ESC]	F	M	m	b1	b2	b3	b4	e1	e2
1B	46	4D	* *	* *	* *	* *	* *	* *	* *
	e3	e4	d1		d4	(s1)	(s2)	[CR]	
	* *	* *	* *		* *	* *	* *	0D	

- m: Checksum present/absent (1 BCD digit)
0: Absent
1: Present
- b₁ to b₄: First written word address (4 BCD digits)
0000 to 9999
- e₁ to e₄: Final written word address (4 BCD digits)
0000 to 9999
- d₁ to d₄: Data to be written (1 to 4 hexadecimal digits)
0 to FFFF_H
It is possible to omit initial zeroes so that there are less than 4 digits.
- s₁, s₂: Checksum (2 hexadecimal digits)
If m is 0, omit this setting.

Response

Only if Yes is set for the Response memory switch, the response indicated below is returned on normal completion.

Format

[ESC]	F	M	0	0	s1	s2	[CR]
1B	46	4D	30	30	30	45	0D

- s₁, s₂: Checksum (2 hexadecimal digits)
This is always added (fixed as 0EH).

Function

Writes the specified data to all the words within the range specified by the first written word address and final written word address.

4-3-12 Numeral Memory Table Clear Command (Sent from Host to PT)

Command

Format

[ESC]	C	N	m	(b1)	(b2)	(b3)	(b4)
1B	43	4E	* *	* *	* *	* *	* *
	(e1)	(e2)	(e3)	(e4)	(s1)	(s2)	[CR]
	* *	* *	* *	* *	* *	* *	0D

- m: Checksum present/absent (1 BCD digits)
0: Absent
1: Present
- b₁ to b₄: First cleared numeral memory table entry number (4 BCD digits)
0000 to 1999

e₁ to e₄: Final cleared numeral memory table entry number (4 BCD digits)
0000 to 1999

s₁, s₂: Checksum (2 hexadecimal digits)
If m is 0, omit this setting.

Reference: The maximum number that can be specified for numeral memory table entries depends on the setting for numbers of numeral memory table entries (512/1000/2000) made at the Support Tool.

Response

Only if Yes is set for the Response memory switch, the response indicated below is returned on normal completion.

Format

[ESC]	C	N	0	0	s1	s2	[CR]
1B	43	4E	30	30	30	43	0D

s₁, s₂: Checksum (2 hexadecimal digits)
This is always added (fixed as 0).

Function

- Writes 0 to all the numeral memory table entries within the specified range.
- If settings are omitted for both the first cleared numeral memory table entry number and the final cleared numeral memory table entry number, all the numeral memory table entries are cleared. It is not possible to omit just one of these settings.
- When writing is executed to numeral memory table entries from No.247 to No.253 (areas for clock data display/reading use only), operation will be finished normally without writing values.

4-3-13 Character String Memory Table Clear Command
(Sent from Host to PT)

Command

Format

[ESC]	C	S	m	(b1)	(b2)	(b3)	(b4)
1B	43	53	* *	* *	* *	* *	* *
	(e1)	(e2)	(e3)	(e4)	(s1)	(s2)	[CR]
	* *	* *	* *	* *	* *	* *	0D

m: Checksum present/absent (1 BCD digit)
0: Absent
1: Present

b₁ to b₄: First cleared character string memory table entry number (4 BCD digits)
0000 to 0499

e₁ to e₄: Final cleared character string memory table entry number (4 BCD digits)
0000 to 0499

s₁, s₂: Checksum (2 hexadecimal digits)
When m is 0, omit this setting.

Reference: The maximum number that can be specified for character string memory table entries depends on the setting for numbers of character string table entries (256/1000/2000) made at the Support Tool. However, it is not possible to clear character string memory table entries higher than entry 500.

Response

Only if Yes is set for the Response memory switch, the response indicated below is returned on normal completion.

Format

[ESC]	C	S	0	0	s1	s2	[CR]
1B	43	53	30	30	31	31	0D

s₁, s₂: Checksum (2 hexadecimal digits)
This is always added (fixed as 11H).

Function

- Writes 40 characters of space code (20H) to all the character string memory table entries within the specified range.
- If settings are omitted for both the first cleared character string memory table entry number and the final cleared character string memory table entry number, all the character string memory table entries are cleared. It is not possible to omit just one of these settings.

4-3-14 Bit Memory Table Clear Command (Sent from Host to PT)

Command

Format

[ESC]	C	B	m	(b1)	(b2)	(b3)	(b4)
1B	43	42	* *	* *	* *	* *	* *
			(e1)	(e2)	(e3)	(e4)	(s1) (s2) [CR]
			* *	* *	* *	* *	* * 0D

m: Checksum present/absent (1 BCD digit)
0: Absent
1: Present

b₁ to b₄: First cleared bit memory table entry number (4 BCD digits)
0000 to 0999

e₁ to e₄: Final cleared bit memory table entry number (4 BCD digits)
0000 to 0999

s₁, s₂: Checksum (2 hexadecimal digits)
When m is 0, omit this setting.

Reference: The maximum number that can be specified for bit memory table entries depends on the setting for numbers of bit memory table entries (256/1000) made at the Support Tool.

Response

Only if Yes is set for the Response memory switch, the response indicated below is returned on normal completion.

Format

[ESC]	C	B	0	0	s1	s2	[CR]
1B	43	42	30	30	30	30	0D

s₁, s₂: Checksum (2 hexadecimal digits)
This is always added (fixed as 00H).

Function

Writes OFF (0) to all the bit memory table entries within the specified range.

4-3-15 Touch Switch Input Notify Command (Sent from PT to Host)

Command

Format

[ESC]	S	T	c1	c2	c3	c4	d1	d2			
1B	53	54	* *	* *	* *	* *	* *	* *			
			d3	d4	a1	a2	a3	a4	s1	s2	[CR]
			* *	* *	* *	* *	* *	* *	* *	* *	0D

- c₁ to c₄: Changed word address (4 BCD digits)
0000 to 9999
This is the number of the word containing the allocated bit of the touch switch at which there has been a change.
- d₁ to d₄: Contents of the word after the change (4 hexadecimal digits)
0000 to FFFF_H
- a₁ to a₄: Changed bit information (4 hexadecimal digits)
0000 to FFFF_H
The changed bit in the contents of the word after the change is set to 1.
- s₁, s₂: Checksum (2 hexadecimal digits)
This is always added.

Response

Format

None

Function

- When the status of a touch switch changes because it has been touched or released, notifies the change of status to the host.
- Normally, one command notifies the change in status of one allocated bit only, but when multiple bits in the same word change simultaneously, those changes are all notified together with one command.

Reference: When the screen is switched after pressing a momentary key, this command goes OFF. The change is also notified to the host.

Example

Command

[ESC]	S	T	0	1	0	2	3	0			
1B	53	54	30	31	30	32	33	30			
			1	3	0	0	0	1	0	D	[CR]
			31	33	30	30	30	31	30	44	0D

Changed word address: Wd 0102
 Contents of the word after the change (hexadecimal):
 3013H (binary notation: 0011 0000 0001 0011)
 Changed bit information (hexadecimal):
 0001H(binary notation: 0000 0000 0000 0001)
 Checksum (hexadecimal): 0DH

From the changed word address and changed bit information, it is ascertained that the change relates to the touch switch allocated bit 00 of word 0102, and because 1 is set at the relevant position in the contents of the word after the change, it is ascertained that the touch switch has been pressed (if the change is to OFF, since the operation differs according to the type of touch switch, it cannot be determined from a change in the bit status alone whether the touch switch has been touched or released.)

4-3-16 Numerical Input Notify Command

(Sent from PT to Host)

Command

Format

[ESC]	S	N	t1	t2	t3	t4	d1	d2			
1B	53	4E	* *	* *	* *	* *	* *	* *			
			d3	d4	d5	d6	d7	d8	s1	s2	[CR]
			* *	* *	* *	* *	* *	* *	* *	* *	0D

- t₁ to t₄: Input numeral memory table entry number (4 BCD digits) 0000 to 1999
This is the number of numeral memory table entry for which there has been numerical input.
- d₁ to d₈: Input numeric data (8 hexadecimal digits) 00000000 to FFFFFFFFH
- s₁, s₂: Checksum (2 hexadecimal digits)
This is always added.

Response

Format

None

Function

- In accordance with operations at the PT, such as numeral setting and copying of memory table entries, notifies the host that a numeric value has been input to the numeral memory table entry.
- Since it is not possible to write to numeral memory table entries from No.247 to No253 (areas for clock data display/reading use only), notification of these table entries is not executed.

Example

Command

[ESC]	S	N	t1	t2	t3	t4	d1	d2			
1B	53	4E	* *	* *	* *	* *	* *	* *			
			d3	d4	d5	d6	d7	d8	s1	s2	[CR]
			* *	* *	* *	* *	* *	* *	* *	* *	0D

Input numeral memory table entry number: No.150
 Input numeric value data (hexadecimal): 30000H
 Checksum (hexadecimal): 05H

Here, it is ascertained that 30000 has been input to numeral memory table entry 150 (whether this is 30000 in hexadecimal or 30000 in BCD is determined by the numeral storage type set for the numeral memory table entry).

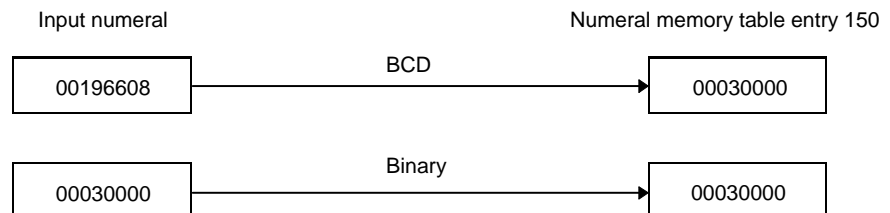

4-3-17 Character String Input Notify Command (Sent from PT to Host)

Command

Format

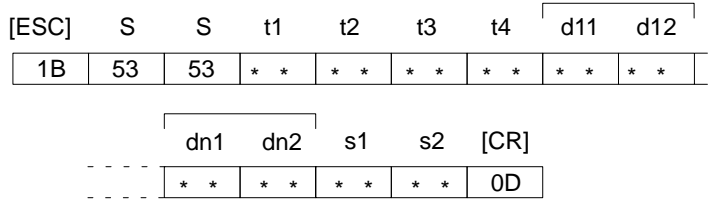

t₁ to t₄: Input character string memory table entry number (4 BCD digits)
 0000 to 0499
 This is the number of the character string memory table entry for which there has been character string input.

d₁₁, d₁₂, ..., dn₁, dn₂: Input character string data (1 to 40 characters)
 00 to FF_H
 In the case of character string memory table entries allocated words in the host, this is the registered number of words multiplied by 2, and the case of character string memory table entries not allocated words in the host, it is data for 40 characters.

s₁, s₂: Checksum (2 hexadecimal digits)
 This is always added.

Response

Format

None

Function

In accordance with operations at the PT, such as character string settings and copying of character string memory table entries, notifies the host that a character string has been input to the character string memory table entries.

Example

Command

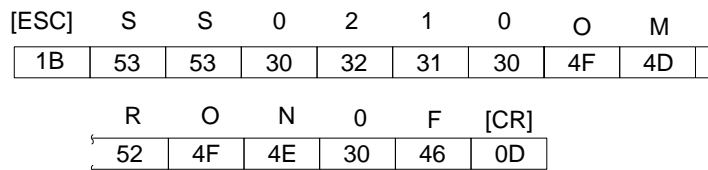

Input character string memory table entry number: No.210
 Input character string data (hexadecimal): OMRON
 Checksum (hexadecimal): 0FH

Here, it is ascertained that OMRON has been input to character string memory table entry 210.

4-3-18 Direct Area Changing Notify Command (Sent from PT to Host)

Command

Format

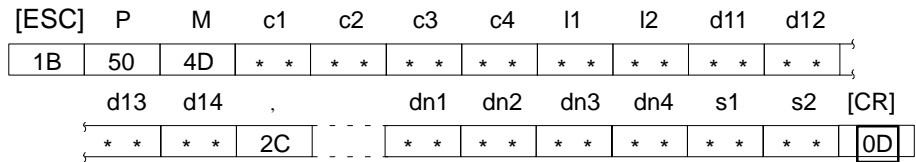

c₁ to c₄: Word address of the changed direct area (4 BCD digits)
0000 to 9999

Area type of the changed direct area	Word address
PT control area	First allocated word
PT notify area	First allocated word + 1 word
Window control area	First allocated word

l₁, l₂: No. of changed word (2 BCD digits)
01 to 03

Area type of the changed direct area	No. of the changed word
PT control area	01
PT notify area	01
Window control area	03

d₁₁, d₁₂, d₁₃, d₁₄, ..., d_{n1}, d_{n2}, d_{n3}, d_{n4}:
Contents of the direct area after the change (1 to 4 hexadecimal digits)
0 to FFFF_H

Area type of the changed direct area	Contents to be changed
PT control area	Screen number
PT notify area	PT status notify bit
Window control area	Window number Window X coordinate Window Y coordinate

It is possible to omit initial zeroes so that there are less than 4 digits.

Individual words of data are delimited by commas.

s₁, s₂: Checksum (2 hexadecimal digits)
This is always added.

Response

Format

None

Function

Notifies to the host the fact that there has been a change in the status of the PT and the contents of the direct areas (PT control area, PT notify area and window control area) have changed.

However, in the following cases, a dedicated command is issued and therefore the direct area changing notify command is not issued.

When numeric input has occurred: Numerical input notify command

When character string input has occurred: Character string input notify command

For details of direct area, refer to 2-2 Areas for Control/Notification on page 52.

Example

Example 1. Notification of Change in the PT Control Area

Notification of change in the PT control area is issued when screen is switched by operations at the PT, such as touch switch operation. In the example below, it is ascertained that the screen has been switched to screen number 21 (BCD) by a switch screen touch switch.

Command

[ESC]	P	M	0	1	0	0	0	1	1	5	4	0	[CR]
1B	50	4D	30	31	30	30	30	31	31	35	34	30	0D

First word address of PT control area: Wd 100
 Number of changed words in PT control area: 1 word
 Screen number (hexadecimal): 15H (screen No.21 in BCD)
 Checksum: 40H

Example 2. Notification of Change in the PT Notify Area

Notification of change in the PT notify area is issued when the status of the PT is changed (such as screen printing). In the example below, it is ascertained that the printing is being executed currently from the fact that the bit 7 (screen printing) in the PT notify bit is ON (1).

Command

[ESC]	P	M	0	1	1	1	0	1
1B	50	4D	30	31	31	31	30	31
	8	0	8	0	A	C	[CR]	
	38	30	38	30	41	43	0D	

First word address of PT notify area: Wd 110
 Number of changed words in PT control area: 1 word
 PT status notify bit (hexadecimal): 8080_H
 (PT operation status bit, screen printing bit: ON)
 Checksum: AC_H

Reference: When NT20S or NT30/620 compatible mode is being used, the current screen number occupies the first word of the PT status notify area and the words containing the updated memory table entry number and PT status notify bits are shifted down one word.

Example 3. Notification of Change in the Window Control Area

Notification of change in the window control area is issued when a window is controlled by the operation at the PT. It is possible to know the screen number of the window that is opened and the display position of the window (bottom left coordinate (X, Y) of the window). In the example below, it is ascertained that the window screen No.16 is displayed at the position on X: 160, Y: 99.

Command

[ESC]	P	M	0	1	2	0	0	3
1B	50	4D	30	31	32	30	30	33
	1	0	,	A	0	,	6	3
	31	30	2C	41	30	2C	36	33
	7	1	[CR]					
	37	31	0D					

First word address of window control area: CIO 120

Number of changed words in window control area:
3 words

Screen number (hexadecimal): 10H

(screen No.16 in BCD)

Window X coordinate (hexadecimal): A0H (160 in BCD)

Window Y coordinate (hexadecimal): 63H (99 in BCD)

Checksum: 71H

} Contents of direct area after the change

Reference:

- With memory link communication, bit 12 (screen switch strobe), bit 11 (numeral setting strobe flag) and bit 10 (character string setting strobe flag) of PT status notify bit do not go ON/OFF. It is possible to know them by direct area changing notify command, numeral input notify command and character string input notify command.
- When the PT was switched to RUN mode from system menu or error screen, notification of change in PT notify area (PT operation status: ON) is issued to the host.
Also, when the PT was switched to system menu or error screen from RUN mode, notification of change in PT notify area (PT operation status: OFF) is issued to the host.

4-3-19 PT Memory Changing Notify Command (Sent from PT to Host)

Command

Format

[ESC]	S	M	c1	c2	c3	c4	l1	l2	d11	d12
1B	53	4D	* *	* *	* *	* *	* *	* *	* *	* *
	d13	d14	,	dn1	dn2	dn3	dn4	s1	s2	[CR]
	* *	* *	2C		* *	* *	* *	* *	* *	0D

c₁ to c₄: First word address of PT memory (4 BCD digits)
0000 to 9999

l₁, l₂: Number of words in direct area (2 BCD digits)
01 to 50

d₁₁, d₁₂, d₁₃, d₁₄, ..., dn₁, dn₂, dn₃, dn₄:
Contents of the direct area (1 to 4 hexadecimal digits)
0 to FFFF_H
It is possible to omit initial zeroes so that there are less than 4 digits.
Individual words of data are delimited by commas.

s₁, s₂: Checksum (2 hexadecimal digits)

Response

Format

None

Function

Notifies to the host of the change in PT memory.

4-3-20 PT Operation Mode Switching Command (Sent from Host to PT)

Command

Format

[ESC]	M	C	m	0	0	(s1)	(s2)	[CR]
1B	4D	43	* *	30	30	* *	* *	0D

- m: Checksum present/absent (1 BCD digit)
0: Absent
1: Present
- c₁, c₂: Operation mode of PT to be switched to (2 BCD digits)
Fixed as 00 (transmit mode)
- s₁, s₂: Checksum (2 hexadecimal digits)
When m is 0, omit this setting.

Response

Only if Yes is set for the Response memory switch, the response indicated below is returned on normal completion.

Format

[ESC]	M	C	0	0	s1	s2	[CR]
1B	4D	43	30	30	30	42	0D

Data Part

- s₁, s₂: Checksum (2 hexadecimal digits)
This is always added (fixed as 0BH).

Normally, data part is 00, however, it is 10 (31H, 30H) when serial port B is used. (see below)

Function

- Changes the operation mode of PT from RUN mode to transmit mode by the command from the host.
- This command can change the PT mode from RUN mode to transmit mode forcibly even if the setting of Display System Menu was set to Disabled by system installer mode.
- After the mode was switched to transmit mode by this command, screen data transmission is possible even if the setting of Screen Memory Protect was set to Disabled by system installer mode.
- Use this command when the PT is communicating to the host at serial port A. If you use this command when the PT is communicating to the host at serial port B, 10 (checksum error) is returned to data part and it is not possible to switch to the transmit mode.
- When the PT mode is switched to transmit mode by this command, direct area changing notify command (notification of PT operation status OFF in PT notify area) will be issued.
- If the PT received this command while the momentary touch switch is being pressed, PT issues PT memory changing notify command (notification of corresponding word OFF(0)) first and then changes the operation mode to transmit mode.

4-3-21 Re-send Request Command

(Sent from Host to PT)

Command

Format

[ESC] R R m (s1) (s2) [CR]

1B	52	52	* *	* *	* *	0D
----	----	----	-----	-----	-----	----

- m: Checksum present/absent (1 BCD digit)
 0: Absent
 1: Present
- s₁, s₂: Checksum (2 hexadecimal digits)
 When m is 0, omit this setting.

Response

Format

None

Function

- The input notify command last sent from the PT is re-sent.
- Requests re-issue of the last input notify command (touch switch input notification, numeral input notification, character string input notification, direct area changing notification and PT memory changing notification) issued by the PT. The PT re-sends the last issued input notify command.

4-3-22 Error Response

(Sent from PT to Host)

Response

[ESC] E R c1 c2 s1 s2 [CR]

1B	45	52	* *	* *	* *	* *	0D
----	----	----	-----	-----	-----	-----	----

- c₁, c₂: Error code (2 BCD digits)
- 01: Invalid command
 A non-existent command has been used.
- 02: Command length error
 The command length differs from the stipulated length.
- 03: Range error
 The word/table entry number is outside the setting range.
- 04: Checksum present/absent specification error
 A value other than those stipulated has been set for the checksum present/absent specification.
- 05: Format error
 A format other than that stipulated has been used, for example the word address has been specified with 5 digits or a character code outside the permissible range has been used.
- 06: Re-send request error
 A re-send request command has been issued although there is no input notify command to re-send.
- 10: Checksum error
 The specified sum value and calculated sum value differ.
 This error code is returned also when the PT operation mode switching command is issued when the PT is communicating to the host at serial port B.
- 11: Communication error
 A parity error, overrun error, or framing error has occurred.

(This error code is only issued when Comm. Auto-return memory switch is ON.)

S₁, S₂: Checksum (2 hexadecimal digits)

Function

If there is an error in a command received by the PT, an error code is notified to the host. The command in which the error occurred is invalidated.

4-4 Memory Link Online Transfer Function

The memory link online transfer function is used to write screen data from the host to the PT. Screen data can be written with the memory link online transfer function only when the memory link is being used.

This section provides an overview of the memory link online transfer function.

4-4-1 Online Transfer Processes

The following processing can be performed with the memory link online transfer function.

- 1, 2, 3... 1. Switch the PT from RUN mode to transfer mode from the host.

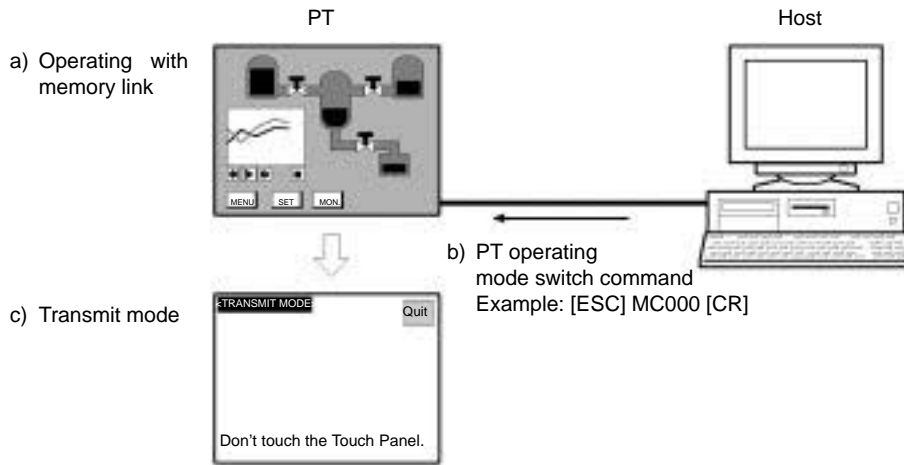

2. Write screen data to the PT from the host.

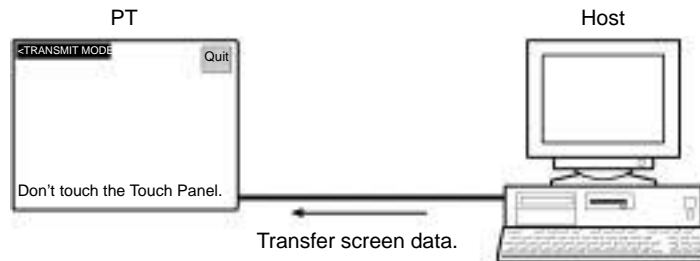

Reference: Do not touch the touch panel while screen data is being transferred by the memory link online transfer function. (Do not press the Exit touch switch either.)

3. Switch the PT to RUN mode and start operation.

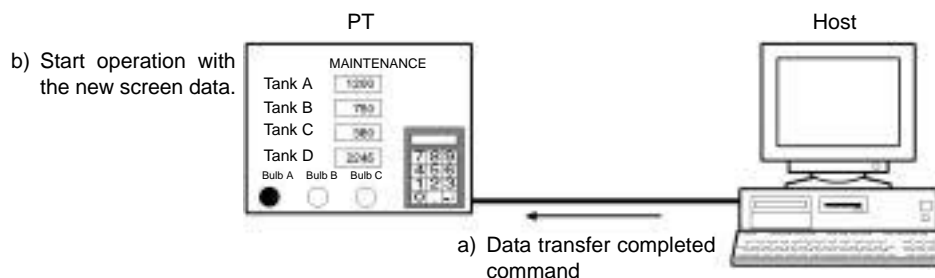

4-4-2 Required Conditions

The following conditions are required in order to use the memory link online transfer function.

Item	Condition
Support Tool	NT-ZJCAT1-EV4 NT-series Support Tool for Windows (Version 4)
PT model	NT21 NT31, NT31C, NT631, or NT631C (V1 or later)
PC type (Supports direct access)	Memlink (memory link)
Screen data file type	mmi (Memory Map Image) format
Usable memory area	PT memory
Word addresses	0000 to 9999

Reference: The mmi format is a screen data file format with the .mmi filename extension. This format reduces the size of files to less than 1.4 MB to allow the files to be stored on floppy disks. The mmi format can be selected when screen data is being stored with the NT-series Support Tool for Windows (Version 4). The file format is the standard file format.

The mmi format deletes the following information in order to reduce file size:

- Grid information in screens created with the Support Tool
- Group information for grouped elements

Refer to the *NT-series Support Tool for Windows (Version 4) Operation Manual* for more details on the file formats.

4-4-3 Example Applications

When the memory link online transfer function is being used, screen data in the PT can be changed freely from the host. Two example applications are described below.

1. Automatic Transfer and Execution of Screen Data for Maintenance

A maintenance program can be executed in the host to automatically write and start screen data for maintenance in the PT.

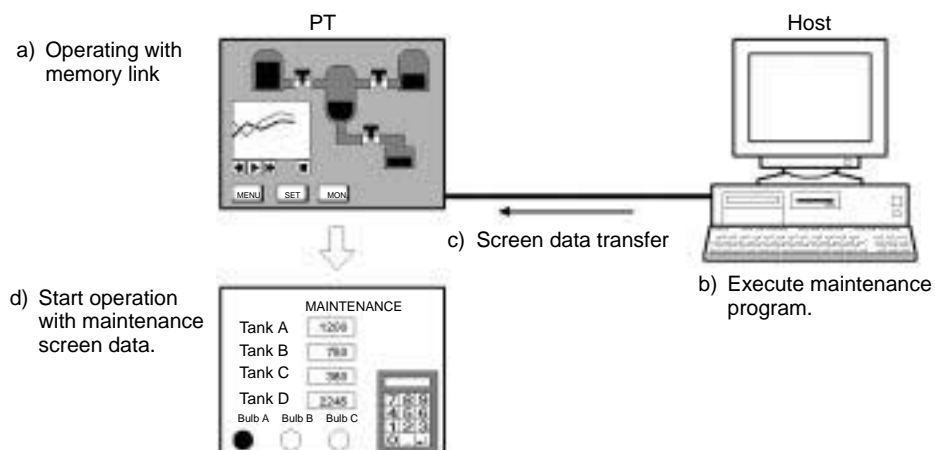

2. Automatically Switch PT Screen Data at Certain Times

The PT's screen data can be changed at the scheduled times each day to display the regular operating screen or maintenance screen.

8 AM Screen Change

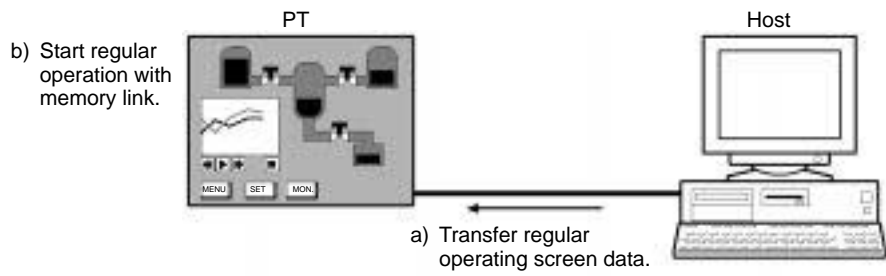

6 PM Screen Change

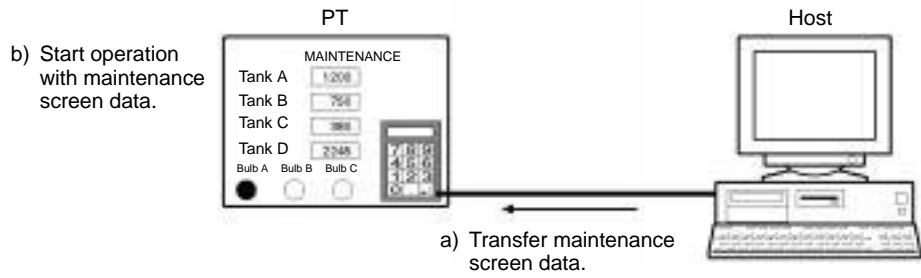

SECTION 5

Function Applications

This section presents a collection of simple practical examples that will give you hints on how to make best use of the functions of the PT.

Please use these examples for reference when using the PT.

5-1	Examples of Actual Applications of Direct Access	404
5-2	Examples of Actual Applications of Memory Link	417

5-1 Examples of Actual Applications of Direct Access

Some examples that will give you an idea of how to actually apply the functions of the PT such as those indicated below are presented here.

- Continually monitoring a specific PC bit and displaying an alarm when it comes ON page 404
- Changing display contents in accordance with PC bit status page 408
- Displaying online help with a touch switch page 410
- Continually monitoring a specific PC bit and displaying a message on a window when it comes ON page 411
- Continuously reading out the contents of a PC word and displaying a trend graph by backtracking page 412
- Displaying the day of the week using the clock data in the PT page 414
- Enabling and disabling a touch switch with an interlock bit page 415
- Scaling the contents of a PC word and displaying the result..... page 416

In these examples, only the necessary settings are shown. Make the unspecified settings according to your requirements. In some of the examples, colors other than black and white are used for the display colors; note that these examples can be applied even with monochrome type PTs, for example by setting the display of black and white in reverse video.

For the method for creating screens with the Support Tool, refer to the *NT-Series Support Tool Version 4.6 for Windows Operation Manual (V061-E1-□)*.

Continually Monitoring a Specific PC Bit and Displaying an Alarm When It Comes ON

Example:

Displaying TEMPERATURE ABNORMAL in red, regardless of the screen currently displayed, when the monitored bit at the PC comes ON.

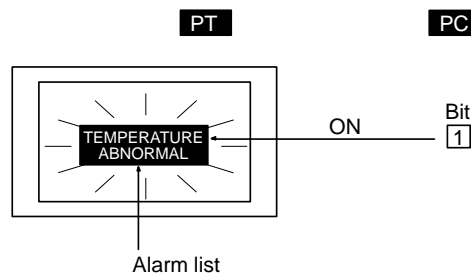

- 1, 2, 3...
 1. Set TEMPERATURE ABNORMAL as the initial value for any character string memory table entry.
 2. Make the following settings for any bit memory table entry.
 - PC Address: PC bit number to be monitored
 - Function: Alarm
 - String table entry: Number of the character string memory table entry for which settings were made in (1).
 3. Register an alarm list, set as indicated below, for any screen.
 - Color setting, Frame: Black (same as the background color of other screens)
 - Color setting, Background, ON: Red
 - List Settings: Set the Start Bit Table Entry and No. of Bits Referenced so as to include the bit memory table entry set in (2) above.
 4. Set overlapping screens so that all screens displayed on the PT are overlapped by the screen created in (3).

Suggestions

- In order to display TEMPERATURE ABNORMAL with no frame, make its background color the same as that of other screens (*Alarm List*, page 182).
- So that TEMPERATURE ABNORMAL is displayed regardless of which screen is currently displayed, display the overlapping screens created in (4) at the PT (*Overlapping Screens*, page 42).
- As an alternative to making every screen an overlapping screen, the same result can be achieved by registering an alarm list on every screen.
- The same kind of display can be displayed even though ON/OFF switching guide characters are set for a normal lamp (*Normal (Standard) Lamps*, page 112).

Example:

Displaying a screen with TEMPERATURE ABNORMAL in black on a red background when the monitored PC bit comes ON.

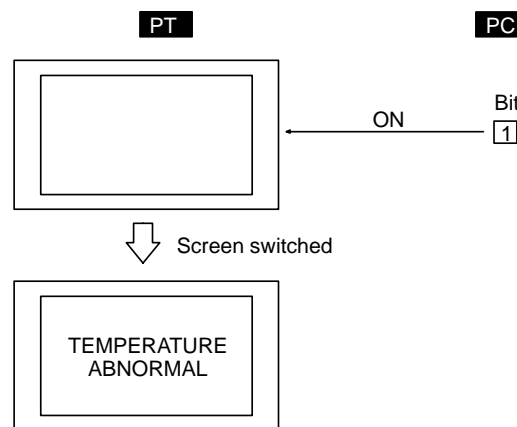

- 1, 2, 3...**
1. Set the properties of the screen displayed when the bit comes ON as follows:
 - Background color: Red
 2. Register a fixed display text element for the screen set in (1) as follows:
 - Text: TEMPERATURE ABNORMAL
 - Foreground Color: Black
 - Background color: Transparent
 3. Make the following settings for any bit memory table entry.
 - PC Address: Number of the PC bit to be monitored
 - Function: Switch screen
 - Screen No.: Number of the screen set in (1) and (2)

Suggestions

- In this method, after switching to the error screen, the error screen remains displayed even if the status of the monitored PC bit changes back from ON to OFF (*2-3-3 Bit Memory Table*, page 83). After checking the error at the equipment, one of the following methods must be used to return to the screen that was displayed before the error occurred: using a touch switch with the switch screen function (page 131), writing a screen number to the control area (page 53), or switching the screen by using a bit memory table entry (page 83).

Example:

Displaying a screen that shows details of the error when the TEMPERATURE ABNORMAL alarm message is pressed.

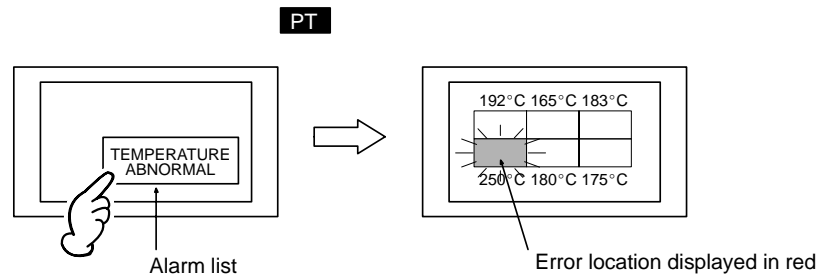

- 1, 2, 3...**
1. Set TEMPERATURE ABNORMAL as the initial value for any character string memory table entry.
 2. Make the following settings for any bit memory table entry.
 - PC Address:
PC bit number to be monitored
 - Function:
Alarm
 - Switch screen:
Check mark set
 - Screen No.:
Number of the screen that displays details of the error (refer to (4))
 - String table entry:
Number of the character string memory table entry for which settings were made in (1).
 3. Register an alarm list, set as indicated below, for any screen.
 - Color setting, Background, ON:
Red
 - List Settings:
Set the Start Bit Table Entry and No. of Bits Referenced so as to include the bit memory table entry set in (2) above.
 4. Register the following elements on the screen that displays the error details.

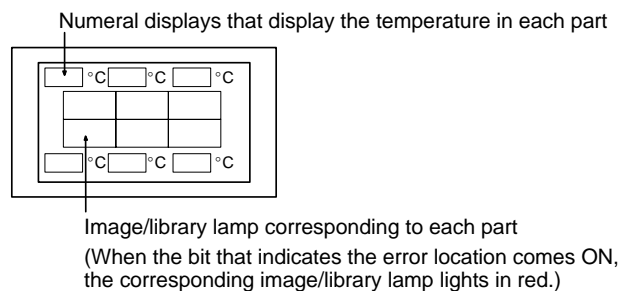

Suggestions

- The ladder program must be written so that at the same time as the bit that indicates the temperature error comes ON, the bit that indicates the error location for the relevant temperature also comes ON.

Example:

Displaying a screen with details of the times at which alarms occurred in the past when the TEMPERATURE ABNORMAL alarm message is pressed.

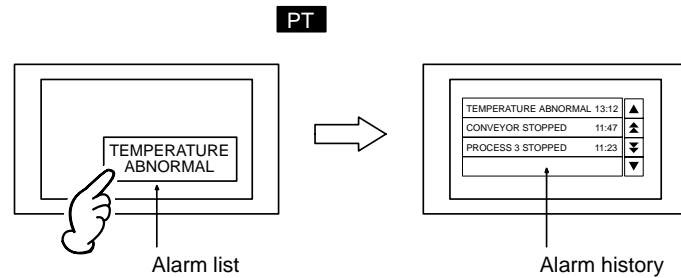

- 1, 2, 3...**
1. Set TEMPERATURE ABNORMAL as the initial value for any character string memory table entry.
 2. Make the following settings for any bit memory table entry.
 - PC Address:
PC bit number to be monitored
 - Function:
Alarm
 - History:
Check mark set
 - Switch screen:
Check mark set
 - Screen No.:
Number of the screen that displays the alarm history (refer to (4))
 - String table entry:
Number of the character string memory table entry for which settings were made in (1).
 3. Register an alarm list, set as indicated below, for any screen.
 - Color setting, Background, ON:
Red
 - List Settings:
Set the Start Bit Table Entry and No. of Bits Referenced so as to include the bit memory table entry set in (2) above.
 4. Register the set alarm history as follows on the screen that displays the alarm history:
 - History Info: Check mark set
 - Order type: Order of occurrence

Suggestions

- When designating the screen number with a bit memory table entry, the alarm history can also be displayed by designating the following screen numbers.
 - No. 9001: Occurrence History Screen (page 244)
 - No. 9002: Frequency History Screen (page 244)
- In this case, there is no need to register an alarm list.

Example:

Displaying the corrective action (help information) when the alarm message TEMPERATURE ABNORMAL is pressed.

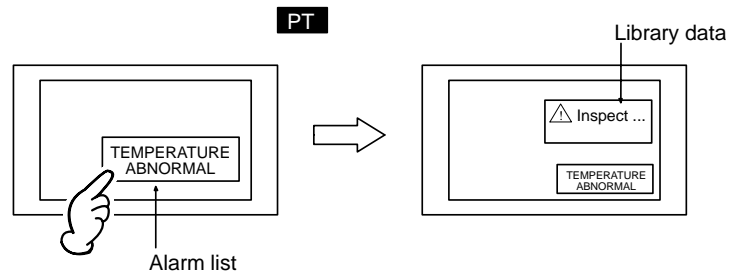

- 1, 2, 3...**
1. Set TEMPERATURE ABNORMAL as the initial value for any character string memory table entry.
 2. Create library data, registering for it a fixed display text element in which the corrective action for the temperature alarm (for example Inspect ...) is written.
 3. Make the following settings for any bit memory table entry.
 - PC Address:
PC bit number to be monitored
 - Function:
Alarm
 - String table entry:
Number of the character string memory table entry for which settings were made in (1)
 - Image/library code:
Check mark set, code of the library data created in (2)
 4. Register an alarm list, set as indicated below, for any screen.
 - Color setting, Background, ON:
Red
 - Display ImageLib:
Check mark set
 - List Settings:
Set the Start Bit Table Number and No. of Bits Referenced so as to include the bit memory table entry set in (3) above.

Changing Display Contents in Accordance with PC Bit Status

Example:

Changing the status of a graphic depicting the opening and closing of a valve in accordance with the status of one PC bit.

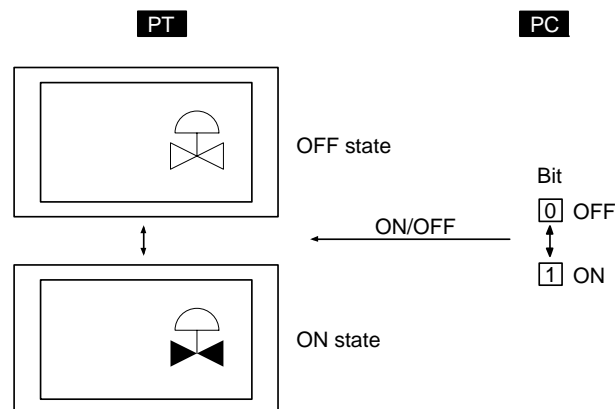

- 1, 2, 3... 1. Create figures depicting the valve when open (A in the figure below) and the valve when closed (B in the figure below), either by using library data (fixed display graphic) or image data (comprised of dots).



2. Register image/library data set as indicated below for the screen.

- OFF State, Code:
Check mark set, code of the figure depicting the closed valve created in (1)
- ON State, Code:
Check mark set, code of the figure depicting the open valve created in (1)
- PC Address:
Number of the bit used to change between the figures

Example:

When the displayed character string is changed in accordance with the status of one PC bit

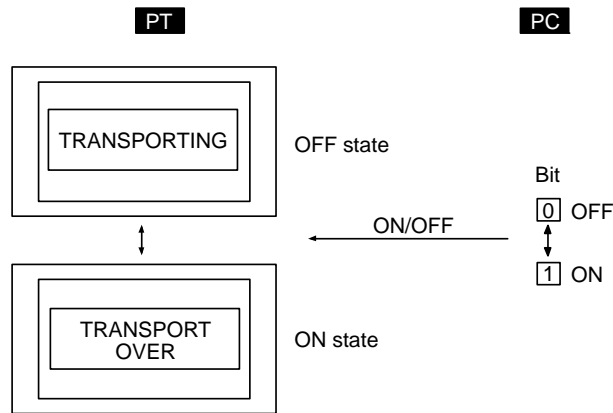

Register a normal lamp for the screen with the following settings.

- Guide character type: ON/OFF switching
- OFF guide characters: TRANSPORTING
- ON guide characters: TRANSPORT OVER
- PC address: Bit address of the bit used to change between the character strings

Example:

PC bits 0 to 15 come ON according to the position of an automatic guided vehicle, and the position of the vehicle is shown on the screen.

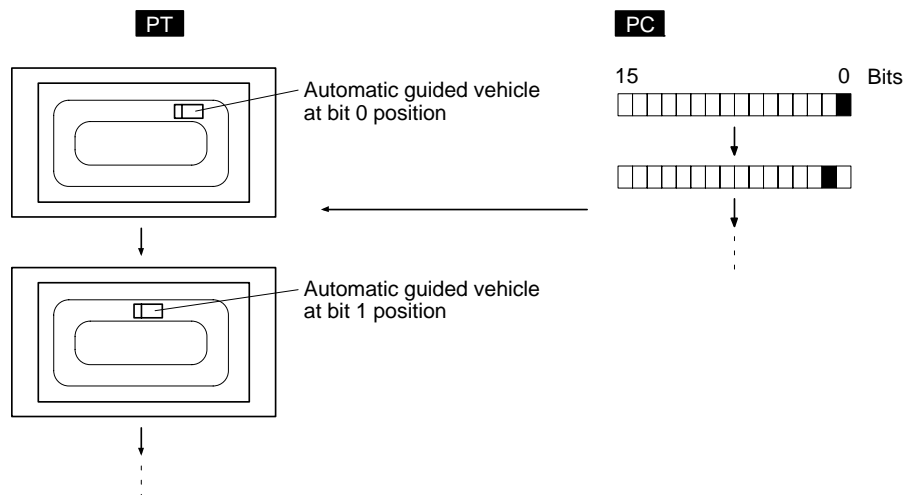

- 1, 2, 3...
1. Create figures depicting the automatic guided vehicle with library data (fixed display graphics) or image data (composed of dots). If there is a figure with a different orientation, create it separately.
 2. Register image/library lamp set as shown below for the position corresponding to bit 0 on the screen.
 - OFF State, Code:
Check mark not set
 - ON State, Code:
Check mark set, code for the library data for the automatic guided vehicle created in (1) (shape corresponding to the position)
 - PC Address:
Bit number of bit 0 indicating the automatic guided vehicle's position
 3. Register image/library lamps set for bits 1 to 15 in the same way as in (2).

Reference: With PT, once an element has been drawn, it is not redrawn unless the display contents change (this applies even with overlapping screens). Consequently, if a rail is drawn as a fixed display element underneath the automatic guided vehicle, when the automatic guided vehicle moves, the rail underneath the position where the automatic guided vehicle was originally placed, cleared together as the vehicle moves. Bear this in mind when creating the screen data.

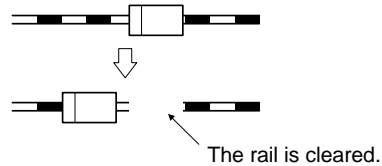

Displaying Online Help with a Touch Switch

Example: Displaying help information in a window when a touch switch is pressed.

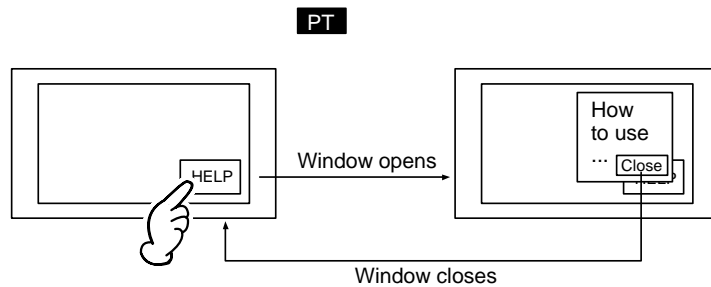

- 1, 2, 3...
1. Create a new screen as a keyboard screen.
 2. Register help information as text and graphics for the screen created in (1).
 3. Make settings like those indicated below to register a touch switch for the screen created in (1).
 - Function: Input key – keyboard
 - Keyboard screen No.: Number of keyboard screen currently being created
 - Action type: Close
 - Guide character display: Check mark set, fixed character string, guide characters Close
 4. Specify the area to be displayed as a window, making sure that it will accommodate the help information and the touch switch created in (3).
 5. Register a touch switch on the screen on which the help information is to be displayed (base screen), making the following settings for it.

- Function: Input key – keyboard
- Keyboard screen No.: Numbers of keyboard screens created in (1) to (4)
- Action type: Open
- Guide character display: Check mark set, fixed character string, guide characters HELP

By setting the action type of the touch switch on the base screen as Toggle, the window can be opened and closed from the base screen.

Continually Monitoring a Specific PC Bit and Displaying a Message on a Window When It Comes ON

Example:

Opening a window and displaying an error message on it when the monitored bit at the PC comes ON.

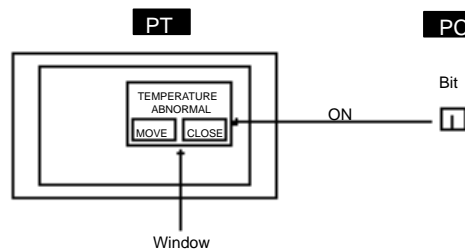

- 1, 2, 3...**
1. Set TEMPERATURE ABNORMAL as the initial value for any character string memory table entry.
 2. Make the following settings for any bit memory table entry.
 - PC Address: PC bit number to be monitored
 - Function: Alarm
 - String table entry: Number of the character string memory table entry for which settings were made in (1).
 3. Register an alarm list, set as indicated below, for window screen.
 - List Settings: Set the Start Bit Table Entry and No. of Bits Referenced so as to include the bit memory table entry set in (2) above.
 4. Register Window Move touch switch and Window Close touch switch on a window same as (3).

5. Create the following ladder program so that the window is opened from the host when the bit comes ON. (Word addresses are not shown in the ladder program below, set the value when programming.)

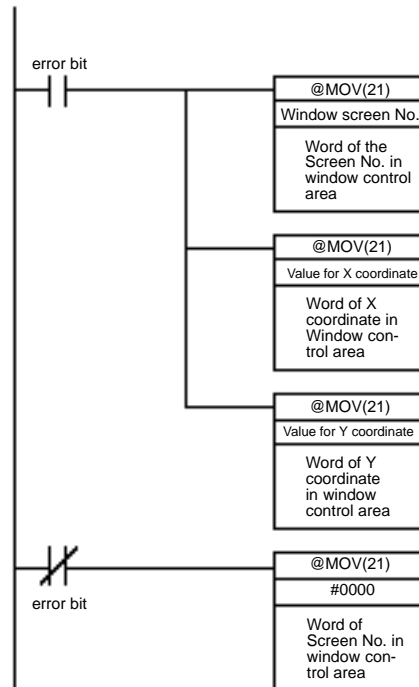

With this ladder program, the specified window is displayed at the designated position when the error bit comes ON, and the window is closed when the error bit goes OFF.

Suggestions

- Window can be moved closed or opened by the operation of touch switch, when the window move touch switch is registered on the window like the example above.
- Detailed screen is displayed, or the screen is switched by pressing on the message position in an alarm list on the window. (Refer to page 406)
- Multiple windows can be displayed at the same time (up to three windows). (Refer to page 238)
- It is possible to display windows so that they do not overlap when multiple windows are displayed, since the position of each window can be specified. (Refer to page 310)
- When the windows are overlapped, the displaying order of windows can be changed by touching the window that is displayed under the other window. (Refer to page 241)

Continuously Reading Out the Contents of a PC Word and Displaying a Trend Graph by Backtracking

Example:

Utilizing the trend graph logging function and background function Register a trend graph set as indicated below for the screen.

- Line Properties:
Word address of the PC word to be monitored
- Data Logging:
Check mark set
- Background:
Check mark set

- Touch switches for logging:
Check marks set for all
- Touch switches for display function:
Check marks set for all

Regardless of whether or not the trend graph is displayed, reading of the contents of the word starts at the same time as PT operation is started.

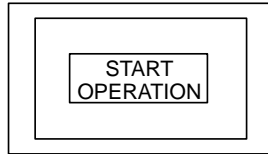

Due to the background function, data reading is started at the same time as operation is started.



When the trend graph screen is displayed, the latest status is displayed.

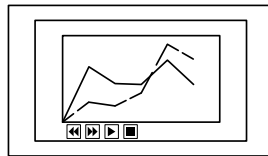

The latest trend graph is displayed on the basis of collected data.



Even if another screen is displayed during data collection, the contents of the word continue being read by the background function.

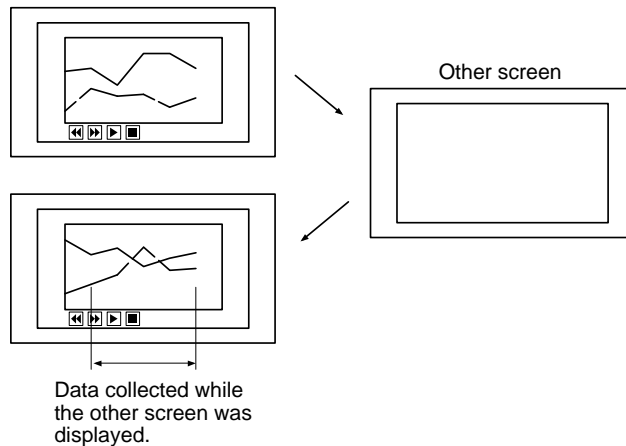

If required, past status changes can be displayed as a trend graph.

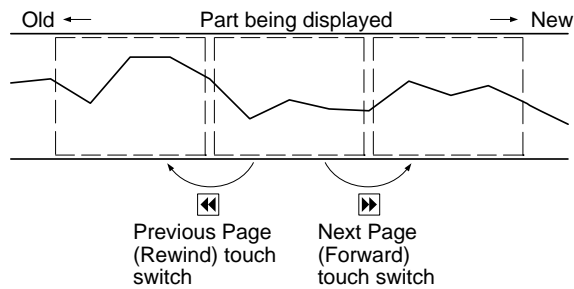

Suggestions

- Apart from the Previous Page (Rewind) and Next Page (Forward) touch switches indicated above, the following touch switches can be created without restriction to control the display and data recording (2-10-4 Trend Graphs, page 170).

- Stop touch switch
Stops data sampling.
- Restart (Continue) touch switch
Restarts data sampling when it has been stopped.
- Display Clear (Clear display) touch switch
Clears the currently displayed trend graph, then starts drawing the graph from the new status (past records are retained).
- Log Clear (Clear log) touch switch
Clears past records.

Displaying the Day of the Week Using Clock Data in the PT

At the PT, numeric values are stored in numeral memory table entry 253 as shown below.

Value (decimal)	0	1	2	3	4	5	6
Day of week	Sun	Mon	Tue	Wed	Thu	Fri	Sat

By indirect reference of character string displays, the displayed characters are changed using these values to change, the character string memory table entry whose contents are to be displayed.

Example:

Displaying Sun to Sat, stored in character string memory table entries 0 to 6, by indirect reference of numeral memory table entry 253.

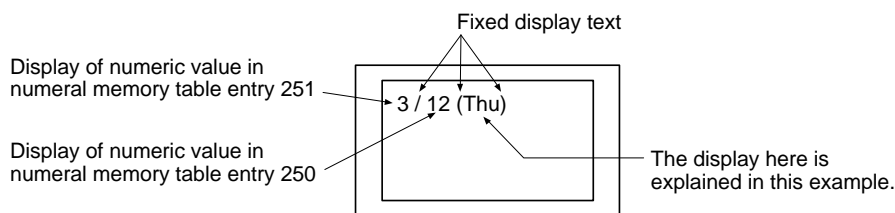

- 1, 2, 3...**
1. Set the initial values indicated below for character string memory table entries 0 to 6. Do not allocate words for these character string memory table entries in the host.

Character string memory table entry	0	1	2	3	4	5	6
Initial value	Sun	Mon	Tue	Wed	Thu	Fri	Sat

2. Register the part that displays the month and day for the screen, following the example given above.
3. Register the part that displays the day of the week by indirect specification of a character string display, as indicated below.
 - Indirect Reference:
Check mark set
 - Table Entry:
253 (numeral memory table entry that stores the day of the week data)

The settings above will display the month and day set with the calendar and clock in the System Menu.

Suggestions

- With the NT31/NT31C or NT631/NT631C, the clock data can be set on the CALENDAR & CLOCK SET screen in the System Menu. Refer to section 6 of the *Setup Manual* for details.
- With the NT21, the clock data is read from the Clock Data Area in the host.
- With the NT31/NT31C or NT631/NT631C, use the memory table entry copy function to set the year, month, date, and day of the week in numeral memory table entries 254 and 255 (pages 322, 326, and 355).

- With the NT21, the clock data is automatically read from the host. Numeral memory table entries 254 and 255 are not used (reserved for the system).
 - If character string memory table entries 0 to 6 are used for other applications at the same time as they are used to display the day of the week.
- 1, 2, 3...
1. Copy the contents of numeral memory table entry 253 to a table entry that can be allocated a PC word by using the memory table copy function.
 2. To achieve correspondence between the numbers of the character string memory table entries that store Sun to Sat and the contents of numeral memory table entry 253 (0 to 6), add a constant.
 3. Display the day of the week indirectly by following the example above.

Example:

Storing Sun to Sat in character string memory table entries 200 to 206.

Character string memory table entry	200	201	202	203	204	205	206
Initial value	Sun	Mon	Tue	Wed	Thu	Fri	Sat

Adding 200 to the contents of numeral memory table entry 253 enables indirect specification of the character string memory table entries that store Sun to Sat.

Enabling and Disabling a Touch Switch with an Interlock Bit

Example:

While the system is setting up or initializing, the guide characters Please wait are displayed on the touch switch and the touch switch's operation is disabled. When the system is ready, the guide characters Ready are displayed on the touch switch and the touch switch's operation is enabled.

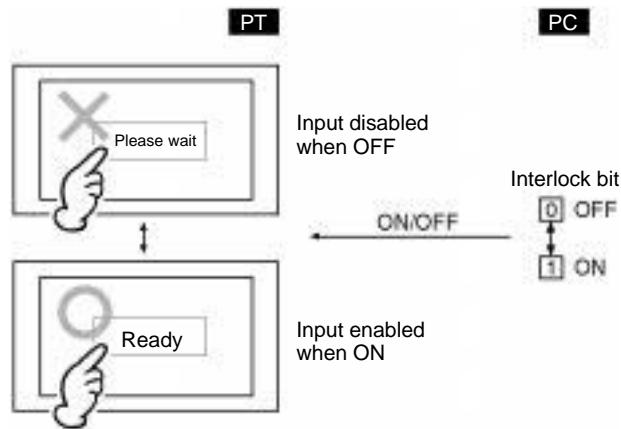

Register a touch switch with settings like those indicated below in the screen.

- PC address of lamp bit: Bit address of the bit in the PC that indicates operating status of the equipment. (OFF during set up or initialization and ON when ready.)
- Guide character display: Check mark set, ON/OFF switching character strings, guide characters Please wait when lamp is not lit, guide characters Ready when lamp is lit
- Interlock: Check mark set
- PC address of interlock bit: Bit address of the bit in the PC that indicates operating status of the equipment. (OFF during set up or initialization and ON when ready.)

With the settings above, the touch switch display will change according to the operating status of the equipment and the touch switch's operation will be enabled/disabled as well.

Suggestions

- The interlock function allows individual inputs (numeral or character string input), recipe data editing, and touch switches to be enabled/disabled from the PC. (See *Disabling Touch Switches with Interlock Bits* on page 369 for details.)
- Bits in the PT status control area can be turned OFF/ON to control the following PT operations as groups.
 - Enable/disable the opening of windows (bit 6)
 - Enable/disable numeral and character string inputs (bit 5)
 - Enable/disable screen switching (bit 4)

Scaling the Contents of a PC Word and Displaying the Result**Example:**

The contents (X) of a PC word are scaled with the equation $Y=2X+3$ and the results are displayed in a trend graph.

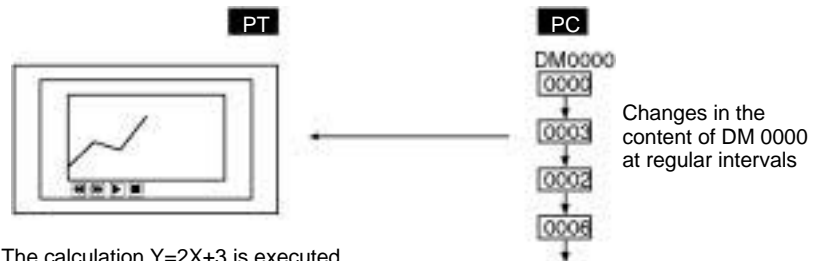

The calculation $Y=2X+3$ is executed continuously in the PT and the results are displayed in the trend graph.

- 1, 2, 3...**
1. Use the Support Tool to set the following formula in a mathematical table.
 - Formula format: $(x \div x) \div x$
 - Result storage destination: Numeral memory table entry 0
 - Operands (from left): constant 2, D00000, constant 3
 - Calculation operators (from left): * and +
 2. Register a trend graph in the window that displays numeral memory table entry 0.

Suggestions

- Multiple mathematical formulas can be set in the mathematical table to continuously execute multiple calculations. (Refer to *2-18 Mathematical Function* on page 279 for details.)
- It is possible to notify the host of the calculation results by specifying a host word or a numeral memory table entry that is allocated a host word for the result storage destination.
- Logical operators and comparative operators can be used for the calculation operators as well as arithmetic operators and bit operators.

5-2 Examples of Actual Applications of Memory Link

Some examples that will give you an idea of how to actually apply the memory link are presented below.

- Switching screen by the operation at PT control area Page 417
- To know the event that a numeral/character string is input to PT Page 418

The examples below give you the explanation centered on which commands are sent to apply the function and the method to use the responses returned from PT. For method on using programming language that is run at the host, refer to the manual of each programming language etc. For details of commands used with memory link, refer to Section 4 Using Memory Link.

Switching screen by the operation at PT control area

Example:

Switching screen by the operation at PT control area:
Allocated word in PT control area: Wd 0100

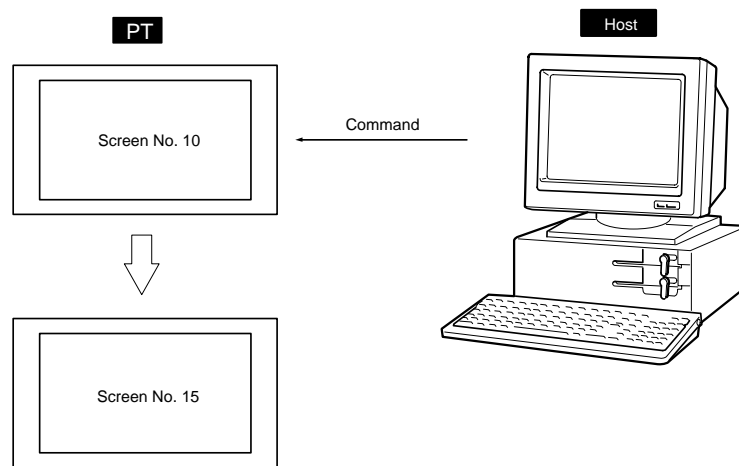

Use PT memory write command (sent from host to PT) for this case since it is necessary to write new screen number to the first word in PT control area.

- Command

[ESC]	W	M	8	0	1	0	0	0	0	0	F	[CR]
1B	57	4D	38	30	31	30	30	30	30	30	46	0D
			(1)		(2)			(3)				

- Explanation

- 1, 2, 3...**
1. Write attribute: Checksum absent, SET attribute (writing 1 word)
 2. First word address written: Wd 0100
Number of words written: Omitted, since the write attribute is as above.
 3. Data of written word: 000F_H

Screen switch is executed by writing the screen number to the first word in PT control area.

In this example, screen is switched from screen No.10 to screen No.15.

000F is specified in the example above since it is necessary to specify data of written word in PT memory write command in binary.

If Yes is set for the Response memory switch for the communication setting of memory link, the response indicated below is returned from PT after sending command. (If No is set, no responses will be returned.)

- Response

[ESC]	W	M	0	0	1	F	[CR]
1B	57	4D	38	30	31	46	0D

- Explanation
Format of response is fixed.

Hint

- In the same way, by changing the status of PT control bit, buzzer can be beeped or backlight ON/OFF status can be controlled from the host. See page 52.
- By writing the value in window control area, it is possible to control window (open/close/move). See page 65.
- Use bit memory table write command to switch screens by the operation of bit memory table entry. See page 380.

To know the event that a numeral/character string is input to PT

Example:

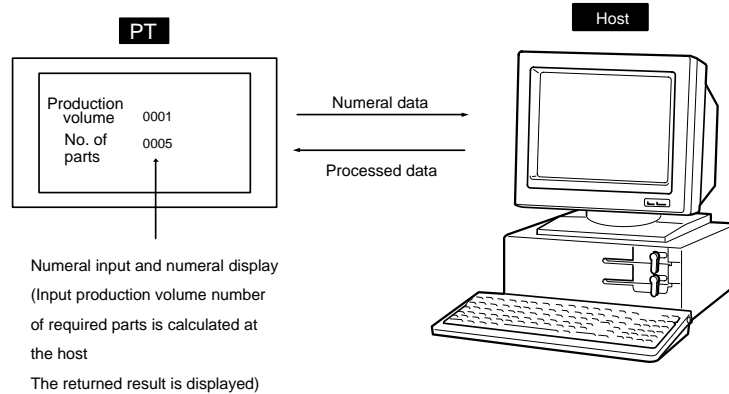

When the numeral was input on PT, numeral input notify command (sent from PT to host) is issued from the PT. At the host, numeral data was taken out and processed, then it is written to the PT by the numeral memory table write command (sent from host to PT).

- 1, 2, 3... 1. When numeral data is input on PT (numeral input notify command sent from PT to host):

- Command

[ESC]	S	N	0	1	4	2	
1B	53	4E	30	31	34	32	

(1)

0	0	0	0	0	0	F	0
30	30	30	30	30	30	46	30

(2)

1	9	[CR]
31	39	0D

(3)

- Explanation
 - Numeral memory table entry number: 142
 - Input numeral: 0000000F0_H (240 in decimal)
 - Checksum: 19H

It is ascertained that 240 is input to numeral memory table entry 142. With numeral input notify command, input numeral data is expressed as binary. Here, input data (240) is expressed as binary (000000F0_H).

2. When numeral is written to PT (numeral memory table write command (sent from host to PT))

- Command

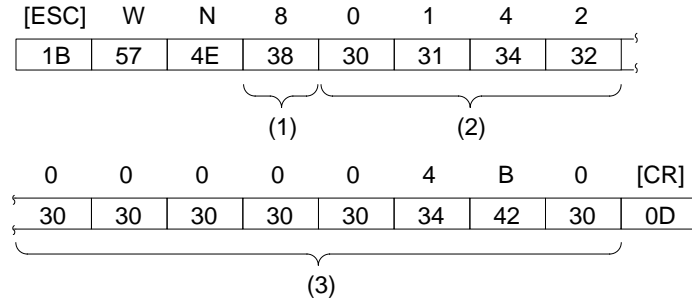

- Explanation
 - Checksum present/absent: None (writing 1 word)
 - First numeral memory table entry written: 142
 - Data of written numeral memory table entry: 000004B0_H
(1200 in decimal)

In this way, numeral data that is input from the PT is processed at the host and the result is notified to the PT.

Suggestions

- Same as numeral, character string input notify command (sent from PT to host) is issued from the PT for the character string that is input at PT. (See page 393.)
- Character string that is input from bar code reader is also notified to the host. (See page 210.)
- Data of numeral/character string memory table entry can be cleared by memory table clear command. (Numerals are cleared to 0, and character strings are cleared to the space code 20 H.) (See pages 388 and 389.)

SECTION 6

Troubleshooting and Maintenance

This section describes the action to take when PT errors occur.

6-1	Troubleshooting	422
6-2	Responding to Displayed Error Messages	427
6-2-1	Errors Occurring at Start of Operation and Their Remedies	427
6-2-2	Errors Occurring during Operation and Their Remedies	429
6-2-3	Errors Occurring on Screen Data Initialization and Transmission	430
6-2-4	Errors in the System Installer Mode and Their Remedies	431
6-2-5	Communication Errors and Their Remedies	432

6-1 Troubleshooting

When a fault relating to the operation of the PT occurs, find the symptoms in the table below and respond by following the corresponding *Remedy* indicated in the table.

PT Symptoms	Cause	Remedy
NT31/NT31C or NT631/NT631C: Power indicator fails to come ON	Power is not being supplied.	Check the connections and make sure that power is supplied correctly. (Refer to <i>Power Supply Connection</i> in section 3 in the <i>Setup Manual</i> .)
NT21: Nothing is displayed on the screen.	Power supply fuse has blown.	Contact your nearest OMRON representative.
Nothing is displayed on the screen.	Screen No. 0 has been read at the host side.	This is not an error. Change the screen number. (3-3 <i>Screen Display and Notification</i> , page 299)
	The system startup waiting time has not elapsed yet.	This is not an error. The display will appear after the waiting time has elapsed.
Cannot communicate with the Support Tool	The Transmit mode has not been established.	Display the System Menu and select the Transmit mode. (Refer to <i>Transmitting the Screen Data</i> in section 6 in the <i>Setup Manual</i> .)
	Not connected to the Support Tool.	Check the installation of the connector cable. (Refer to <i>Connecting to the Support Tool</i> in section 3 in the <i>Setup Manual</i> .)
	The PT model setting and direct connection setting at the Support Tool do not match the NT21, NT31/NT31C, or NT631/NT631C.	Using the PT Configuration settings of the Support Tool, set the PT model and direct connection settings that match the NT21, NT31/NT31C, or NT631/NT631C.
Cannot communicate with the host Cannot switch from the system initializing screen. Communication error message is displayed when communicating to the host.	Memory switch settings do not match.	Check the communication setting in the Memory Switch menu of the Maintenance mode, and match the communication protocol settings for the host and PT. (Refer to <i>Setting the Conditions for Communications with the Host by Using the Memory Switches</i> in section 6 in the <i>Setup Manual</i> .)
	PT and host are not correctly connected.	Check that the type, length, and installation of the connector cable match the specifications. (Refer to section 4 and section 5 in the <i>Setup Manual</i> .)
	In an RS-422A/485 connection, the terminator setting is incorrect.	Set the terminating resistance correctly for the PTs, PCs, and RS-232C/RS-422A Adapters. Section 5 in the <i>Setup Manual</i> .)
	In an NT link (1:N) connection, there is duplication in the unit numbers.	Make the settings again so that there is no duplication. (Refer to <i>Setting the NT Link (1:N) Method</i> in section 6 in the <i>Setup Manual</i> .)
	The power to the PT, NT-AL001 or host is OFF.	Check the power supply.
The buzzer has sounded and the RUN indicator is OFF.	Malfunction due to external noise	Carry out grounding work in accordance with the conditions. (Refer to <i>Grounding</i> in section 3 in the <i>Setup Manual</i> .)
	The PT has developed trouble.	Contact your nearest OMRON representative.
The touch panel does not respond.	Malfunction due to external noise	Carry out grounding work in accordance with the conditions. (Refer to <i>Grounding</i> in section 3 in the <i>Setup Manual</i> .)
	The touch panel is broken.	Test the touch panel with I/O Check in the MAINTENANCE MODE menu. If there is an error, contact your nearest OMRON representative.
The PC mode has changed to MONITOR mode.	The PT changes the mode when host link communication is used.	This is an PT specification. When using a PC that can also be connected using the NT link method, use an NT link connection (there is no mode change with the NT link method).

PT Symptoms	Cause	Remedy
The graph display does not change.	One of the percentage display settings — -100%, 0%, or 100% — is incorrect.	Set the -100%, 0%, and 100% values in the following relationship: -100% value < 0% value < 100% value
The trend graph display does not agree with the actual time axis.	The cycle for graph display update processing is longer than the set sampling cycle.	Delete other elements on the same screen as the trend graph that are allocated words in the host and have a high update frequency. Or lengthen the sampling cycle.
The Programming Console function cannot be used.	The communication settings are incorrect.	Set the communication method/communication port as follows when using the Programming Console function: - With C-series PC: 1:1 NT Link - With CS/CJ-series PC: 1:N NT Link
	A Programming Console is connected.	With all PCs except for the CS/CJ-series PCs, it is not possible to use a Programming Console and the Programming Console function at the same time. Disconnect the Programming Console.
	The PC does not support the Programming Console function.	Not all PCs support the Programming Console function. Check the model of PC you are using. (Refer to <i>Programming Console Function</i> in section 6 in the <i>Setup Manual</i> .)
	The system program for other vendor's PCs has been installed. (PC models other than OMRON.)	The Programming Console function can be used only when the system program for OMRON PCs is installed. Install the correct system program.
The screen doesn't change even though the Device Monitor function has been called from the PT status control area. (NT31/NT31C and NT631/NT631C only)	The communications protocol setting at the PT is not 1:1 NT Link or 1:N NT Link.	Check the memory switches (fourth screen) and set the connected PC's serial port protocol to 1:1 NT Link or 1:N NT Link. Set the same protocol in the PC.
	The system program installed in the PT is for a PC maker other than OMRON.	The Device Monitor function can be used only when the PT is connected to an OMRON PC. Refer to <i>Version Display</i> in section 6 in the <i>Setup Manual</i> and check the system program type. Only OMRON Direct Access system programs with version numbers Version 3.□ and higher can use the Device Monitor function.
The words that were being monitored the last time that Device Monitor was used are not displayed the next time that Device Monitor is called. (NT31/NT31C and NT631/NT631C only)	<ul style="list-style-type: none"> • The PT was turned OFF. • The PT was reset. 	The words monitored by Device Monitor are retained even if the Device Monitor is closed, but the information is cleared when the PT is turned OFF or reset. Specify the desired words again.
	The cable was disconnected while Device Monitor was being used and then connected to a PC with a smaller data area.	If the cable is connected again to another PC, the PT will clear any word addresses that aren't supported in that PC. Check the ranges of data areas in the PC and set word addresses within those ranges.

PT Symptoms	Cause	Remedy
<p>A numeral/text display is not displayed correctly, nothing is displayed for a text display, or a message is not displayed for an alarm list/history.</p>	<p>Since the memory table entry is allocated words in the host, the display is updated in accordance with the contents of the host memory.</p>	<p>When the contents of the memory table entry are set as a fixed value, do not allocate words for the memory table entry in the host.</p>
	<p>The battery voltage has dropped and the data in the memory table has been destroyed. (Applies to NT21 only when optional Battery is used.)</p>	<p>Replace the battery and execute memory table initialization. (Refer to <i>Initializing the Memory Tables</i> and <i>Replacing the Battery</i> in sections 6 and 7 respectively in the <i>Setup Manual</i>.)</p>
	<p>Since ON is set for the resume function, the initial values of the screen data memory are not written to the memory tables. (Applies to NT21 only when optional Battery is used.)</p>	<p>Execute memory table initialization. (Refer to <i>Initializing the Memory Tables</i> in section 6 in the <i>Setup Manual</i>.) If the resume function does not need to be used, use the PT with the resume function OFF. (Refer to <i>Setting the Resume Function</i> in section 6 in the <i>Setup Manual</i>.)</p>
	<p>Two words have been set in a numeral memory table entry for an indirect address for a number/text display.</p>	<p>Set only one word in the numeral memory table entry.</p>
<p>Updating of numeric values and text is delayed.</p>	<p>Malfunction due to external noise</p>	<p>Carry out grounding work in accordance with the conditions. (Refer to <i>Grounding</i> in section 3 in the <i>Setup Manual</i>.)</p>
	<p>There are too many numeral/text displays on the displayed screen.</p>	<p>Reduce the number of numeral/text displays on the screen for which updating is delayed.</p>
	<p>The cycle time is extended due to heavy processing at the host.</p>	<p>Shorten the host cycle time.</p>
	<p>In an RS-422A/485 connection, there is illegal branching or an erroneous terminator setting.</p>	<p>Wire correctly. (Refer to section 5 in the <i>Setup Manual</i>.)</p>
<p>Some of the elements arranged on a normal screen are not displayed.</p>	<p>The quantity of read data exceeds the stipulated restriction.</p>	<p>Check the maximum number of elements by referring to Display Restrictions (page 437), create the screen data again, then transmit all of the screen data in a batch to the PT.</p>
	<p>The total of the element coefficients for the displayed screen is greater than 1,024.</p>	
<p>On overlapping screens, some of the set elements are not displayed.</p>	<p>Since the data is transmitted from the host in screen units, the number of elements on the overlapping screens has exceeded the maximum permissible without being checked by the Support Tool.</p>	<p>Check the maximum number of elements by referring to Display Restrictions (page 437), create the screen data again, then send all the screen data in a batch to the PT.</p>
<p>The System Menu cannot be called up.</p>	<p>Display System Menu under Change System Settings in the System Installer mode is set to Disabled.</p>	<p>In the System Installer mode, set Display System Menu to Enabled. (Refer to Section 6 of the <i>Setup Manual</i>.)</p>

PT Symptoms	Cause	Remedy
<p>The following System Menu operations are not possible.</p> <ul style="list-style-type: none"> - Establishing the Transmit mode - Displaying the memory switch setting screens - Screen data memory check - Displaying the initialization menu - Displaying the calendar/time setting screen (NT31/NT31C and NT631/NT631C only) 	<p>Screen Memory Protect under Change System Setting in the System Installer mode is set to Disabled.</p>	<p>In the System Installer mode, set Screen Memory Protect to Enabled. (Refer to Section 6 of the <i>Setup Manual</i>.)</p>
	<p>Screen Memory Protect has been set to Disabled because the PT power supply was turned OFF during deletion of screen data.</p>	<p>Do not turn the PT power OFF during deletion of screen data. In the System Installer mode, first change the setting for Screen Memory Protect to Enabled, then repeat the screen data delete operation. (Refer to Section 6 of the <i>Setup Manual</i>.)</p>
<p>Cannot input numeric values</p>	<p>The upper/lower (max./min.) limit check for numeric value input is in effect.</p>	<p>Check the screen data's upper/lower (max./min.) limit check setting for numeric value input, and correct it if necessary (for numeric key type, refer to page 192; for thumbwheel type, refer to page 200).</p>
<p>Cannot input numeric values/character strings.</p>	<p>Bit 5 of the PT status control area (numeral/character string input) is set to 1 (ON).</p>	<p>Set bit 5 to 0 (OFF) (page 60).</p>
<p>Cannot operate recipe elements using touch switches on the PT.</p>	<p>Interlock bit set in the recipe elements is OFF.</p>	<p>Check the status of the interlock bit set in the recipe elements and turn it ON.</p>
<p>Cannot change recipe data (parameters) using touch switch operations on the PT.</p>	<p>Editing of records specified in the recipe data using the PT has been set to disabled (the default setting) using the Support Tool.</p>	<p>Recreate the screen data with the Support Tool to enable editing of specified recipe data, and then send all the data in a single operation to the PT.</p>
<p>Recipe data details are not displayed on screen.</p>	<p>Specified recipe data is not set on screen.</p>	<p>Recreate the recipe data on screen using the Support Tool, and then send all the screen data in a single operation to the PT.</p>
<p>Window screen does not open</p>	<p>Bit 6 of the PT status control area (PT window opening) is set to 1 (ON).</p>	<p>Set bit 6 to 0 (OFF) (page 59).</p>
<p>Cannot switch screens with touch switches</p>	<p>Bit 4 of the PT status control area (PT screen switching) is set to 1 (ON).</p>	<p>Set bit 4 to 0 (OFF) (page 60).</p>
<p>Buzzer sounds – cannot use touch switches, inputs (numeral or character string), or recipe objects</p>	<p>The interlock function is set for the touch switch or input field and the controlling interlock bit is OFF.</p>	<p>Check the status of the corresponding interlock bit and turn it ON.</p>
<p>The display is dim.</p>	<p>Insufficient contrast or brightness</p>	<p>For the NT31/NT31C or NT631/NT631C, use the system menu to increase the contrast/brightness. (Refer to section 6 of the <i>Setup Manual</i>.) For the NT21, use the switches on the back of the PT to increase the contrast. (The brightness cannot be adjusted.)</p>
	<p>Backlight defective, or its life has expired</p>	<p>For the NT31/NT31C or NT631C, replace the backlight. (Refer to section 6 of the <i>Setup Manual</i>.) For the NT21, contact your nearest OMRON representative.</p>

PT Symptoms	Cause	Remedy
The display is too faint.	The contrast is too high.	For the NT31/NT31C or NT631/NT631C, use the system menu to reduce the contrast. (Refer to section 6 of the <i>Setup Manual</i> .) For the NT21, use the switches on the back of the PT to increase the contrast.
The digits in numeral display come out as *.	The number of digits of a numeric value in a numeral memory table entry exceeds the set number.	<ul style="list-style-type: none"> • Confirm the values of the PC words allocated to the numeral memory table entry. • Allocate one PC word to each numeral memory table entry.

6-2 Responding to Displayed Error Messages

When the PT displays an error message, find the corresponding symptoms in the appropriate table below and respond by following the Remedy indicated in the table.

For details of the error messages displayed when using Memory Unit and corrective action to take for them, refer to *Using a Memory Unit (PT models with V□ suffix)* or *Using a Memory Unit (PT models without V□ suffix)* in section 3 in the *Setup Manual*.

6-2-1 Errors Occurring at Start of Operation and Their Remedies

The table below shows the errors that can occur when the power to the PT is turned ON and when operation starts, and their remedies.

Message	Cause	Remedy
[No Comm. Protocol] Set the comm. Protocol by MAINTENANCE MODE.	No communication protocol has been set. Communication protocol and screen data type are mismatched	Using the memory switches, set the communication method to be used for communication with the host. (Refer to <i>Setting the Conditions for Communications with the Host by Using the Memory Switches</i> in section 6 in the <i>Setup Manual</i> .)
[Screen Data Error] Screen Data corrupted. Initialize Screen Memory, and download Screen Data again.	<ul style="list-style-type: none"> - The power was switched OFF during screen data initialization, checking, or transmission. - Transmission of screen data was interrupted. - Illegal data has been written to the screen data memory. 	Initialize the screen data memory by operation at the System Menu, then re-transmit the screen data. (Refer to <i>Clearing Screen Data</i> in section 6 in the <i>Setup Manual</i> .) If the problem persists, contact your nearest OMRON representative.
[No Screen Data] No Screen Data is saved in Screen Memory. Download Screen Data using by the Support Tool. Then set the PT to the TRANSMIT MODE, and download Screen Data again.	No screen data is registered.	Transmit screen data from the Support Tool.
[No Direct Connection Info.] No Direct Connection Information is set in Screen Data. Set Direct Connecting Information in Screen Data using by the Support Tool. Then set the PT to the TRANSMIT MODE and download Screen Data again.	Allocated words have not been set for the PT status control area and PT status notify area.	Allocate words for the PT status control area and PT status notify area with the Support Tool and then transmit the direct connection information to the PT.
[Incorrect Screen Data] Screen Data in Screen Memory do not match with the System Program. Initialize Screen Memory, and download Screen Data again.	The type of registered screen data does not match that at the PT.	Initialize the screen data memory, then transmit the correct screen data. (Refer to <i>Clearing Screen Data</i> in section 6 in the <i>Setup Manual</i> .)
[No Starting Screen] Specified Starting Screen is not saved. Fix Screen Data using by the Support Tool. Then set the PT to the TRANSMIT MODE and download Screen Data again.	No data is registered for either the screen number set in the PT status control area or the Initial Screen set with the Support Tool. Or the screen number that does not exist are registered.	Either specify a screen number for which data is registered at the PT status control area, or set the screen as the Initial Screen in the System settings under PT Configuration at the Support Tool.

Message	Cause	Remedy
<p>[Touch Panel is disconnected] (NT31/NT31C and NT631/NT631C only)</p>	<p>The touch panel cable (film cable) inside the PT is disconnected.</p>	<p>NT31/NT31C PTs: Contact your nearest OMRON representative.</p> <p>NT631/NT631C PTs: If this message appears after replacing the backlight, install the touch panel cable correctly according to the instructions in <i>Replacing the Backlight</i> in section 7 in the <i>Setup Manual</i>. Contact your nearest OMRON representative if the problem persists.</p>
<p>[Memory Switch Corrupted] Because Memory Switch setting was last. Initialized Memory Switch setting. Press Confirm to return to the SYSTEM MENU.</p>	<p>The memory switches have been initialized due to discovery of an error in the memory switch settings.</p>	<p>Set the memory switches again using the System Menu and the System settings under PT Configuration at the Support Tool. (Refer to <i>System Menu Operations</i> in section 6 in the <i>Setup Manual</i>.) If the problem recurs, contact your nearest OMRON representative.</p>
<p>[Calendar Data Error] Calendar Data is incorrect. Set to the MAINTENANCE MODE and set Calendar Data. (NT31/NT31C and NT631/NT631C only)</p>	<p>There is an error in the date/time values due, for example, to low battery voltage.</p>	<p>Check the battery voltage by checking the color of the RUN indicator and with the battery check in the System Menu; if the voltage is low, replace the battery with a new one. (Refer to <i>Checking the Battery Voltage</i> in section 6 or <i>Replacing the Battery</i> in section 7 in the <i>Setup Manual</i>.) If the battery voltage is confirmed to be normal, set the calendar clock correctly from the System Menu. (Refer to <i>Displaying/Setting the Calendar and Clock</i> in section 6 in the <i>Setup Manual</i>.)</p>
<p>[Backup Data Error] Memory table and History data was initialized by backup failure. It can be caused by lowered voltage of the battery.</p>	<p>Initialization has been executed because of an error in the backup data area.</p>	<p>Check the battery voltage by checking the color of the RUN indicator and with the battery check in the System Menu; if the voltage is low, replace the battery with a new one. (Refer to <i>Checking the Battery Voltage</i> in section 6 or <i>Replacing the Battery</i> in section 7 in the <i>Setup Manual</i>.) The re-transmit the memory table data from the Support Tool. Install a Battery into the PT if one is not already installed. If the voltage is normal and the problem recurs, contact your nearest OMRON representative.</p>
<p>[With memory switch setting screen] Invalid Comm. Method</p>	<p>Protocol settings for serial port A and serial port B are mismatched.</p>	<p>Refer to <i>Possible Combinations of Communication Method Settings</i> in section 6 in the <i>Setup Manual</i> and set the protocol of serial port A and serial port B so that their settings are matched. * Set serial port A to None when connecting the Support Tool and the host at the same time.</p>

6-2-2 Errors Occurring during Operation and Their Remedies

The table below shows the errors that can occur during operation of the PT and their remedies.

Operational Errors (Other than Device Monitor Errors)

Message	Cause	Remedy
[Address Setting Error] Addressing Error exists in the Screen. Correct address setting by the Support Tool.	The host side allocated words and bits set with the Support Tool are incorrect.	Set correct words and bits after checking the area used at the host side by referring to <i>Appendix D PC Memory Maps</i> (page 441), and the manual for the PC being used.
[Memory Table No. Error] Memory table No. is out of limit. Correct the table No. by the Support Tool.	The memory table entry number set with the Support Tool is outside the range for the number of memory table entries set in the system memory.	Either increase the number of memory table entries in the System settings under PT Configuration at the Support Tool, or set the memory table entry number again within the established range.
[Programming Console Error] Setting of Programming Console Function is inadequate. It can be caused by: <ul style="list-style-type: none"> • This PC does not support Programming Console Function. • Protocol mismatch. Set the PC to NT Link. • "PROGRAMMING CONSOLE" is connected to PC. 	The communication settings are incorrect.	Set the communication method/communication port as follows when using the Programming Console function: - With C-series PC: 1:1 NT Link - With CS/CJ-series PC: 1:N NT Links
	The PC used does not support the Programming Console function.	Not all PCs support the Programming Console function. Check the model of the PC you are using. (<i>2-16-9 Programming Console Function</i> , page 257)
	A programming Console is connected.	It is not possible to use a Programming Console and the Programming Console function at the same time. Disconnect the Programming Console.
[Programming Consol Error] Programming Console Function does not RUN. It can be caused by: <ul style="list-style-type: none"> • Connecting cable is faulty. • "PROGRAMMING CONSOLE" is connected to PC. • Protocol mismatch between the PT and PC. Set the PC to NT Link. 	The connecting cable is defective.	Check the cable connection and perform a conductivity test. If there is a fault, replace the cable.
	Malfunction due to external noise	Carry out grounding work in accordance with the conditions. (Refer to <i>Grounding</i> in section 3 in the <i>Setup Manual</i> .)
	A Programming Console is connected.	With PCs other than the CS/CJ-series PCs, it is not possible to use a Programming Console and the Programming Console function at the same time. Disconnect the Programming Console.
	The communication conditions at the PC have been changed in accordance with the PT Programming Console function.	Set the communication conditions at the PC to match the conditions set in the System Menu.

Device Monitor Function Errors (NT31/NT31C and NT631/NT631C Only)

Error	Probable cause	Remedy
The setting is wrong.	A word address that doesn't exist in the PC was specified in the popup input window.	Input a word address that exists in the PC
Can't write while running.	An attempt was made to change word contents while the PC was in RUN mode.	Switch the PC to MONITOR or PROGRAM mode. The PC's operating mode can be changed from any one of the Device Monitor screens.
The memory can't be written.	An attempt was made to write to a read-only or write-protected area.	Write to a read/write area in the connected PC. If the area is write-protected, clear the write-protection and try writing the data again.

Error	Probable cause	Remedy
Other tool is accessing.	A Programming Device connected to the PC is performing an operation such as online editing. (when attempting to change the operating mode or clear forced status)	Try the operation again after disconnecting the Programming Device.
Remove trouble execution fails. (when clearing an error from error log screen)	The cause of the PC error has not been eliminated.	Eliminate the cause of the error that you are trying to clear. For details, refer to the PC's Operating Manual.
Connection failed. (when starting the Device Monitor function)	The Device Monitor function was called when the PT was not connected to a PC that supports Device Monitor.	Check the model of the PC that is connected. (Refer to 2-17-1 <i>Compatible Systems</i> for a table of PCs that support the Device Monitor function.)
Set Comm. Method to NT Link (1:1 or 1:N) (when the Device Monitor menu is being displayed)	The communications protocol set at the PT is not 1:1 NT Link or 1:N NT Link.	Check the memory switches (fourth screen) and set the connected PC's serial port protocol to 1:1 NT Link or 1:N NT Link. Set the same protocol in the PC.

6-2-3 Errors Occurring on Screen Data Initialization and Transmission

The table below shows the errors that can occur when the PT data is initialized, and during data setting and transmission, and their remedies.

Message	Cause	Remedy
[Flash Memory Error] Flash Memory I/O Error. If this happens frequently, Flash Memory may be broken. Press Reset Switch to restart.	There is a hardware fault, or the flash memory (memory for storing screen data) has reached the end of its service life.	If the same message is displayed even after clearing the screen data or transmitting screen data several times, contact your nearest OMRON representative.
[Calendar Data Error] Calendar Data is incorrect. Set to the MAINTENANCE MODE and set Calendar Data. (NT31/NT31C and NT631/NT631C only)	Hardware fault, or system program error	Set the calendar clock again from the System Menu. If the problem recurs, delete the program in the System Installer mode, then re-install the program. (Refer to Section 6 of the <i>Setup Manual</i> .) If this does not solve the problem, contact your nearest OMRON representative.
[Tool Transmit Error] **** Error detected while downloading by the following case: • faulty connecting cable. • corrupted data by noise.	The connecting cable is defective. Malfunction due to external noise	Check the cable connection and perform a conductivity test. If there is a fault, replace the cable. (Refer to the appendix <i>Making the Cable for Connecting a PC</i> in the <i>Setup Manual</i> .) Carry out grounding work in accordance with the conditions. (Refer to <i>Grounding</i> in section 3 in the <i>Setup Manual</i> .)
[Tool Transmit Error] Checksum Error occurs while downloading by the following case: • corrupted data by noise.	Malfunction due to external noise	Carry out grounding work in accordance with the conditions. (Refer to <i>Grounding</i> in section 3 in the <i>Setup Manual</i> .)
[Tool Transmit Error] Time-out Error occurs while downloading by the following case: • faulty connecting cable.	The connecting cable is defective.	Check the cable connection and perform a conductivity test. If there is a fault, replace the cable.
[Tool Transmit Error] Reception was failed by Buffer Over Flow Error.	The receive buffer has overflowed.	Retransmit the data from the Support Tool.

6-2-4 Errors in the System Installer Mode and Their Remedies

This section describes the errors that may occur in the System Installer mode of the PT, and the remedies for these errors.

Message	Cause	Remedy
System Program not exist or incorrect.	<ul style="list-style-type: none"> - The system program has not been installed. - The system program has been deleted due to a hardware fault, or because the flash memory (memory for storing the system program) has reached its life. 	<p>Select Download System Program and download the system program. (Refer to <i>Clearing/Installing the System Program</i> in section 6 in the <i>Setup Manual</i>.)</p> <p>If this does not solve the problem, contact your nearest OMRON representative.</p>
Unable to erase System Program.	Hardware fault, or flash memory (memory for storing the system program) has reached its life.	If the same message is displayed on repeating selection of Download System Program and attempting to delete the system program several times, contact your nearest OMRON representative. (Refer to <i>Clearing/Installing the System Program</i> in section 6 in the <i>Setup Manual</i> .)
Unable to download System Program.	<ul style="list-style-type: none"> - A communication error occurred during downloading of the system program. - Illegal data has been written into the screen data memory. - Hardware fault, or flash memory (memory for storing the system program) has reached its life. 	<p>Select Download System Program and download the system program again. (Refer to <i>Clearing/Installing the System Program</i> in section 6 in the <i>Setup Manual</i>.)</p> <p>Also refer to 6-2-3 Errors Occurring on Screen Data Initialization and Transmission (page 430), and take the corrective action described for tool transmission errors.</p> <p>If this does not solve the problem, contact your nearest OMRON representative.</p>
Unable to write System Settings.	Hardware fault, or flash memory (memory for storing the system program) has reached its life.	<p>If the same message is displayed on repeating writing of system settings several times, contact your nearest OMRON representative.</p> <p>If writing is normally terminated after the error message was once displayed, the Memory Switch setting for system program may have been altered. In such a case, check and re-set the setting in the Memory Switch menu of the Maintenance mode.</p>
Unable to erase Screen Data.	Hardware fault, or flash memory (memory for storing the system program) has reached its life.	If the same message is displayed on repeating screen data deletion several times, contact your nearest OMRON representative.

6-2-5 Communication Errors and Their Remedies

This section describes the errors relating to communication that can occur during operation, and their remedies.

Operation When a Communication Error Occurs

When a communication error occurs, the error message is displayed at the PT, and the buzzer sounds, provided the setting made for Buzzer Sound in the System Menu is other than OFF. An error message is displayed provided the setting for the Comm. Auto-Return memory switch is not ON (note that some error messages are displayed even if the setting is ON).

Operation When Communication Errors Occur

When an error message is displayed, press the OK touch switch displayed on the screen. The PT will return to the screen that was displayed before the error occurred, and operation will restart.

Display of Communication Errors

For communication errors, the name of the port at which the error occurred, the error classification (send or receive error), the details of the error, the probable cause, and the remedy, are displayed as shown below.

Example: Parity error at serial port A



Receive Errors

The following errors can occur when receiving data.

- Parity error
- Framing error
- Overrun error
- FCS (sum value) error
- Time out error
- Data over flow error
- PC unit No. error (host link only)
- NAK received (in the case of the host link, the end code is also displayed)
- Undefined command error

Send Errors

The following errors can occur when receiving data.

- Time out error
- Data over flow error

Probable Causes and Remedies

The remedies to take in accordance with the displayed cause are indicated in the table below.

Error Details	Displayed Probable Cause	Remedy
Parity Error Framing Error Over-run Error	Communication parameters/ conditions set incorrectly.	Check if the settings at the host for parity bit, frame length, baud rate, stop bit length and flow control agree with those at the PT.
	The connecting cables are not connected correctly.	Check the communication cable connection and perform a conductivity test. If there is a fault, replace the cable. For details on communication cables, refer to section 4 and section 5 in the <i>Setup Manual</i> .
	Noise caused data corruption during communication.	Carry out grounding work in accordance with the conditions. (Refer to <i>Grounding</i> in section 3 in the <i>Setup Manual</i> .)
FCS (Checksum) Error	Noise caused data corruption during communication.	Carry out grounding work in accordance with the conditions. (Refer to <i>Grounding</i> in section 3 in the <i>Setup Manual</i> .)
	The PC is transmitting incorrect data.	Check the operation at the host side.
Time-out Error	The connecting cables are not connected correctly. (Send/Receive)	Check the communication cable connection and perform a conductivity test. If there is a fault, replace the cable. For details on communication cables, refer to section 4 and section 5 in the <i>Setup Manual</i> .
	The communication service of the host is stopped. (Send/Receive)	Check that the host is capable of communicating with the PT (confirm that the communication settings of the host and PT match).
	Time-out Interval is too short. (Send)	Set a longer value for Time-out Interval at the host side.
	Time-out Interval is too short. (Receive)	Set a longer value for Time-out Interval in the System Menu. (Refer to <i>Setting the Time-out Interval</i> in section 6 in the <i>Setup Manual</i> .) It may also be possible to solve the problem by shortening the host cycle time.
PC Unit No. Error	The unit # does not match that set on the PC.	Re-set the unit number at the host side to 0.
	Noise caused data corruption during communication.	Carry out grounding work in accordance with the conditions. (Refer to <i>Grounding</i> in section 3 in the <i>Setup Manual</i> .)
NAK received	—	Check the settings for allocated words and bits. If noise is a possible factor, distance the cable from sources of noise and insert a noise filter in the power supply line. If using the equipment in a location subject to a lot of noise, use a cable with a high degree of protection against noise for the transmission route. Also make the cable as short as possible.
Undefined Command Error	The host is not supported.	Check the PC model used for the host.
	Command level 3 is not effective.	Check that the command level setting for the host is level 1, 2, 3.
Data Over Flow Error	Communication command from the host is too long. (With memory link)	Set flow control method in the host. Increase transmission interval.
	Command transmission to the host is not possible.	Check the communication cable. Check the control method at the PT and the host. Increase the baud rate when it is too slow.

Appendix A Specifications

Display Capacity

Item		Specification			
Display elements	Character displays (fixed display)	Fixed character data (character strings registered for each screen) Maximum combined total with other fixed display elements of 65535 per screen (maximum of 524280 for an overlapping screen)			
	Character string displays	Up to 256 per screen (1024 for an overlapping screen) (40 bytes per string)			
	Numeral displays	Up to 256 per screen (1024 for an overlapping screen), max. 10-digit display			
	Bar graph displays	Up to 50 per screen (400 for an overlapping screen ^{*1}), percentage display and sign display are possible			
	Mark displays (fixed display)	Up to 65535 per screen (52480 for an overlapping screen ^{*1})			
	Analog meter	Up to 50 per screen (400 for an overlapping screen ^{*1}), percentage display and sign display are possible.			
	Trend graphs	One frame per screen (max. of 8 frames on an overlapping screen) Without the data logging function: 50 graphs per screen data file With the data logging function: 8 graphs per screen data file			
	Broken-line graphs	One frame per screen (max. of 8 frames on an overlapping screen), 256 graphs per frame, 260 point per graph (NT21), 320 points per graph (NT31/NT31C), or 512 points per graph (NT631/NT631C)			
	Graphic displays (fixed display)	Can be displayed wherever required Maximum combined total with other fixed display elements of 65535 per screen (maximum of 524280 for an overlapping screen)			
	Lamps	Up to 256 per screen (1024 for an overlapping screen)			
	Touch switches	Up to 256 per screen (same restriction applies to overlapping screens)			
	Image data	Combined total, with library data, of 256 per screen (1024 for an overlapping screen)			
	Library data	Combined total, with image data, of 256 per screen (same restriction applies to overlapping screens)			
	Numerals inputs	Numeric key type	NT21: Combined total, with thumbwheel switches, of 256 per screen (Can only be registered on one child screen of an overlapping screen)	NT31/NT31C: Combined total, with thumbwheel switches, of 256 per screen (Can only be registered on one child screen of an overlapping screen)	NT631/NT631C: Up to 256 per screen including both numeric key type and thumbwheel type inputs. (Can only be registered on one child screen of an overlapping screen)
		Thumb-wheel type	NT21: Up to 26 per screen (Can only be registered on one child screen of an overlapping screen)	NT31/NT31C: Up to 64 per screen (Can only be registered on one child screen of an overlapping screen)	
	Character string inputs		Up to 256 per screen (Can only be registered on one child screen of an overlapping screen)		
	Alarm lists		Up to 4 groups per screen (32 groups for an overlapping screen)		
	Alarm histories		(For alarm histories, 1 group each in occurrence order and frequency order on normal screens/child screens) ^{*2}		
	Recipe		Normal screen: 1 max.; Multiple screens: 8 max.; Window screens: Not possible		
	Clock display		NT31/NT31C, NT631/NT631C: Time display of the built-in clock using the numeral display function NT21: Display of time read from host using the numeral display function		

Item		Specification
Screen types	Normal screen	The normal screen display
	Overlapping screens	A maximum of 8 registered screens can be displayed overlapped with each other.
	Window screens	Up to 3 screens (2 local windows and 1 global window) can be displayed at the same time. All objects other than thumbwheel type numeric input can be registered.
	Display history screens	Order of occurrence (max. 1024 screens), order of frequency (max. 255 times)
Screen attributes		Buzzer, display history, background color (NT31C and NT631C only), backlight, keyboard screen number (local window 1/local window 2)
Number of screens	Max. number of registered screens	3999 screens
	Screen No.	0: No display 1 to 3999: User registered screens 9000: Initializing system screen 9001: Display history (occurrence order) screen 9002: Display history (frequency order) screen 9020: Programming Console function screen 9021: Registration monitor screen (NT31/NT31C and NT631/NT631 only) 9022: Continuous monitor screen (NT31/NT31C and NT631/NT631 only) 9023: Error Log screen (NT31/NT31C and NT631/NT631 only) 9030: Brightness and contrast adjustment screen (NT31/NT31C and NT631/NT631 only) 9999: Return to the previous screen
Screen registration method		By transmitting screen data created using the Support Tool to the PT By transmitting screen data stored in a Memory Unit to the PT (automatic/manual)
Screen saving method (screen data memory)		Flash memory (screen data memory in the PT)

*1: Limits on numbers of elements on a window is same as on a standard screen. Therefore, when 3 windows are displayed, the maximum number is increased by 3 screens.

*2: However, when displaying image/library data, the limitation of image/library data should be also followed.

Display Element Specifications

Item	Specification
Display characters	- Half-height characters (8 × 8 dots): Alphanumerics and symbols - Standard characters (8 × 16, 16 × 32 dots*1): Alphanumerics and symbols - Marks (16 × 16 dots): User-defined pictographs
Enlargement function	Wide, high, 2 × 2, 3 × 3, 4 × 4, 8 × 8
High-definition font	Characters of 2 × 2 or larger scale (except half height characters and marks)
Character display attributes	Standard, flash, inverse flash, transparent
Image data	Variable-size pictographs Size: Min. 8 × 8 dots 256 × 136 dots max. for NT21, 320 × 240 dots max. for NT31/NT31C, and 640 × 480 dots max. for NT631/NT631C The size can be set as required in 8-dot units. Enlarged display, smoothing processing, and display attributes such as inverse and flash cannot be set.
Library data	Combinations of any graphics Size: Min. 1 × 1 dots 260 × 140 dots max. for NT21, 320 × 240 dots max. for NT31/NT31C, and 640 × 480 dots max. for NT631/NT631C Any size can be set within this range. Enlarged display, smoothing processing, and display attributes such as inverse and flash are implemented according to the setting registered. The maximum number of elements that can be registered for one library data is 64.

Item	Specification
Graphics	Polyline, circle, arc, sector, rectangle, polygon
Line type	4 types only for polylines (solid line, broken line, alternate long and short dash, long and two short dashes)
Tiling	10 types
Graphic display attributes	Standard, inverse, flash, inverse flash
Display colors	NT21, NT31, NT631: 2 colors (black, white) NT31C, NT631C: 8 colors (black, blue, red, magenta, green, cyan, yellow, white)
Color specification	Foreground color, background color, boundary color (line color)

*1: Usable only when ISO8859-1 font type is selected at the Support Tool.

Display Restrictions

Apart from the restrictions on the maximum number that can be displayed, the following restrictions apply to individual elements.

- Restrictions on data reading

With PT, the maximum quantity of data that can be read simultaneously is fixed, and elements that exceed this data quantity limit are not displayed on the screen. Note that even if the same data is read from different elements, each instance is counted separately.

The table below shows the maximum data quantities for each type of read data.

Item	Maximum data quantity
Host bit	1024
Numeral memory table entries	1024
Character string memory table entries	1024
Bit memory table entries	1024
Mathematical table entries	1536
Memory table indirect references	100
Background memory table entries	128

The data quantity restrictions for each type of element read are indicated in the table below. Ensure that the totals for a displayed screen are within the range restrictions indicated above.

Element	Restriction on Read Data	
Fixed displays (text, graphics)	None	
Image data	None (1 numeral memory table entry when referenced indirectly)	
Library data	None (1 numeral memory table entry when referenced indirectly)	
Marks	None	
Touch switches	Zero to four host bits (number of host bits set with touch switch property)	When using numeral or character string displays as guide characters, that data is read just like the numeral displays and character string displays described below in this table.
Lamps	One or two host bits (number of host bits set with lamp property)	
Numeral inputs	One numeral memory table entry	Add one host bit when using the interlock function.
Character string inputs	One character string memory table entry	
Thumbwheel switches	One numeral memory table entry	
Numerical displays	Direct specification	One numeral memory table entry
	Indirect specification	One numeral memory table entry One memory table indirect reference

Element	Restriction on Read Data	
Character string displays	Direct specification	One character string memory table entry
	Indirect specification	One character string memory table entry One memory table indirect reference
Recipe	None	
Bar graphs	One numeral memory table entry When numeral memory table entries are designated for each of the -100%, 0%, and 100% settings for each graph line, one numeral memory table entry is read for each of these settings.	
Analogue meter	One numeral memory table entry When numeral memory table entries are designated for each of the -100%, 0%, and 100% settings for each graph line, one numeral memory table entry is read for each of these settings.	
Broken line graphs	Number of numeral memory table entries determined by number of graph lines number of vertices When numeral memory table entries are designated for each of the -100%, 0%, and 100% settings for each graph line, one numeral memory table entry is read for each of these settings.	
Trend graphs	Data logging function not used	Number of numeral memory table entries determined by the number of graph lines When numeral memory table entries are designated for each of the -100%, 0%, and 100% settings for each graph line, one numeral memory table entry is read for each of these settings.
	Data logging function used	Number of background memory table entries determined by the number of graph lines When numeral memory table entries are designated for each of the -100%, 0%, and 100% settings for each graph line, one numeral memory table entry is read for each of these settings.
Alarm lists	Number of bit memory table entries referenced.	
Alarm history	None	

• Restrictions due to element coefficients

The PT uses element coefficients to manage display elements. The maximum number of display coefficients that can be used at the same time is 1024.

If the total of the element coefficients on a screen exceeds 1024, the elements after this total has been reached are not displayed.

The element coefficients for each element are indicated in the table below. Ensure that the total for the screen to be displayed is not greater than 1024.

Element	Element Coefficient
Fixed displays (text, graphics)	1, regardless of how many there are on the screen
Image data	
Library data	
Marks	
Touch switches	1
Lamps	1
Numeral inputs	1 (or 2 if there is a cursor moving key touch switch) + number of dedicated touch switches
Character string inputs	1 (or 2 if there is a cursor moving key touch switch) + number of dedicated touch switches
Thumbwheel switches	1 + number of displayed digits 2
Numeral displays	1
Character string displays	1

Element	Element Coefficient
Recipe	1 + number of lines in name field + number of lines in parameters field + number of dedicated touch switches
Bar graphs	1
Analogue meter	1
Broken line graphs	1
Trend graphs	1 + number of dedicated touch switches
Alarm lists	1 + number of display lines + number of dedicated touch switches If image/library data is displayed, the total is increased by another 64.
Alarm histories	1 + number of display lines + number of dedicated touch switches If image/library data is displayed, the total is increased by another 64.

Special Features

Item	Specifications
Buzzer	<p>Three kinds of buzzer sound (continuous, short intermittent, and long intermittent)</p> <p>Sound: On reception of a command from the host, display of a screen with a buzzer setting, or display of an error screen such as for a receive error.</p> <p>Stop: On reception of a command from the host, or display of a screen with no buzzer setting.</p> <p>Setting: Set ON for Buzzer Sound in the memory switch menu, or set ERROR ON for the buzzer to sound only when an error occurs.</p> <p>The buzzer sounds three times in response to prohibited input.</p>
Touch switch input sound	<p>Touch switches</p> <p>Input sound: Sounding for 0.2 seconds</p> <p>Setting: Set ON for the Key Press Sound in the memory switch menu.</p>
Maintenance function	<ul style="list-style-type: none"> - Memory switch setting - Self-test functions, such as for the memory and external interface - Setting condition confirmation function - Communication check function - Initialization of internal memory data - Display of display/alarm history data - Registered data test display function
Battery backup (The Battery is an option for the NT21.)	<ul style="list-style-type: none"> - Backup of numeral/character string memory table data in the PT - Backup of display/alarm history data - Backup of recipe tables - Backup of calendar and clock setting (NT31/NT31C and NT631/NT631C only) <p>Battery life: 5 years (at 25°C)</p> <p>When voltage becomes low: RUN indicator lights in orange or red The communication flag to the PC (BAT LOW) comes ON (1).</p>
Resume function (A battery is required.)	<p>Retains the contents of the numeral/character string memory table entries (i.e., they are not initialized) when the power is turned ON, when the PT is reset, and when the operation mode is changed.</p> <p>Setting: Set ON for Resume Function in the memory switch menu.</p>
Function for adjusting brightness and contrast during PT operation	<p>Display the brightness and contrast adjustment screen (screen number 9030), and perform the adjustments.</p> <p>Displaying the screen: Switch screens using the touch switches, or specify the display screen using the PT status control area.</p>

Item	Specifications	
Screen print function (NT31/NT31C and NT631/NT631C only)	<p>Functions: - Prints a hard copy of the screen display - Prints display/alarm histories</p> <p>Setting: Set the printing protocol (Print Controller) and printing type (Print Method) in the memory switch menu.</p> <p>ESC/P, Color: Color printing conforming to ESC/P 24-J83C</p> <p>PC-PR201H, Color: Color printing conforming to PC-PR201PL</p> <p>ESC/P, Tone: Monochrome printing in 8 grayscale levels, conforming to ESC/P 24-J82</p> <p>PC-PR201H, Tone: Monochrome printing in 8 grayscale levels, conforming to PC-PR201PL</p> <p>PCL 5, Tone: Monochrome printing in 8 grayscale levels, conforming to PCL 5</p> <p>However, the NT31 and NT631 support monochrome printing only.</p>	
Calendar and clock function	<p>- For the NT31/NT31C and NT631/NT631C, displays the current time in accordance with the built-in clock</p> <p>- For the NT21, clock data is read from the host.</p> <p>- Displayed and set with Calendar Check in the MAINTENANCE MODE menu. (Setting is not possible for the NT21.)</p>	
Programming Console function	<p>Executes functions equivalent to those of a Programming Console (model C200H-PRO27-E) with C series CPM1, CPM1A, CPM2A, CPM2C, CQM1 (-EV1 only), CQM1H, C200HX/HG/HE(-Z)E, and SRM1 (C02-V2 only).</p> <p>Executes functions as a Programming Console for CS/CJ-series PCs.</p>	
Device Monitor function (NT31/NT31C and NT631/NT631C only)	<p>The Device Monitor function can be used to change the PC's operating mode, read/change words in the PC's data areas, and display the PC's error log. Compatible PCs include the CPM1, CPM1A, CPM2A, CPM2C, CQM1 (-EV1 only), CQM1H, C200HX/HG/HE(-Z)E, SRM1, and CS/CJ-series PCs.</p>	
Mathematical function	<p>Up to 256 mathematical formulas can be registered along with the screen data. The mathematical function reads the required data from numeral memory table entries or host words, executes the registered calculations, and writes the results. Arithmetic operators, logic operators, bit operators, and comparative operators can be used.</p>	
Transmission functions	System program transmission	<p>Downloads the system program from the system installer</p> <p>Downloads/Upload the system program with a Memory Unit.</p>
	Screen data transmission	<p>- Function for downloading screen data to and uploading screen data from the Support Tool</p> <p>- Function for transmitting screen data to and from the Memory Unit.</p>
	Recipe table transmission	<p>Function for downloading/uploading recipe tables (i.e., all recipe data) from/to the Support Tool.</p>
	History data uploading	<p>Function for uploading display/alarm history data from PT.</p>

Appendix B

Compatibility with Screen Data of Other PT Models

The screen data of the NT21, NT31/NT31C, and NT631/NT631C does not have complete upward compatibility with earlier PT models. Consequently, when the data for an earlier PT model is converted for use in an NT21, NT31/NT31C, or NT631/NT631C, partial modification may be necessary.

The combinations for which data conversion is possible are shown below. Note that Version □ indicates the direct connection version. The NT-series Support Tool Version 4 for Windows is compatible with the latest version of each PT model.

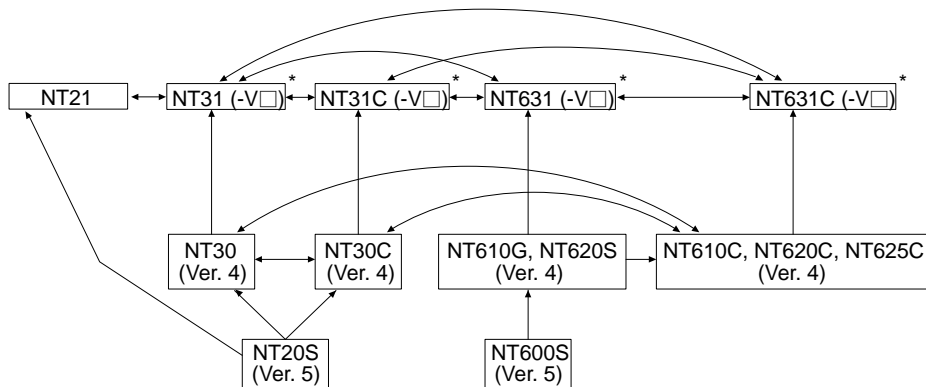

* The following downward screen data conversions are not possible:

-V2 models → -V1 models; -V1 models → models without a -V□ suffix; or -V2 models → models without a -V□ suffix.

The following upward screen data conversions are possible:

Models without a -V□ suffix → -V1 models; models without a -V□ suffix → -V2 models; or V1 models → V2 models.

However, data for models with no -V□ suffix of NT20S-ST121 and NT600S-ST121/211, cannot be read with the Support Tool (NT-ZJCAT1-EV4).

After data conversion, the following discrepancies may occur; in this case modify the data.

- When the data of NT20S, NT600S, NT610G, or NT620S is converted, the position and size of touch switches may change due to the difference in the dot size of touch switches.
- Since the size and contents of the PT status control area and PT status notify area differ between the new models (NT21, NT31, NT31C, NT631, NT631C) and earlier models, the program at the host (PC) must be modified.

The NT21 and the -V2 versions of the NT31, NT31C, NT631, and NT631C have been equipped with the NT20S or NT30/620 compatible mode that allows them to easily modify and reuse the screen data and user programs from earlier PTs. When a NT31, NT31C, NT631, or NT631C PT is operating in NT20S or NT30/620 compatible mode, its PT status control area and PT status notify area are modified to be the same size as earlier PTs. Refer to *Appendix C* for details (page 457).

Differences between the NT20S and the NT21

This section explains the differences in screen creation and programming between the NT20S and the NT21.

Refer to *1-2 Functions of the NT21, NT31/NT31C, and NT631/NT631C* for details on functional differences between the PT models (page 4).

Reference: The NT20S compatible mode can be used to reduce the differences with the NT20S and allow their screen data and user programs to be reused easily. Refer to *Appendix C* for details (page 457).

Item	NT20S	NT21																																																																																																																																																																																																																																																																																																																																			
Fore-ground/back-ground relationships in screen drawing	<table border="1"> <thead> <tr> <th>Display</th> <th>Element Type</th> </tr> </thead> <tbody> <tr> <td>Foreground</td> <td>Contents of display elements that have data Fixed displays (text, marks) Lamps (normal lamp frames) Touch switches Frames of bar graphs Input settings (numeral, thumbwheel) Fixed displays (figures) Screen background</td> </tr> <tr> <td>Background</td> <td></td> </tr> </tbody> </table>	Display	Element Type	Foreground	Contents of display elements that have data Fixed displays (text, marks) Lamps (normal lamp frames) Touch switches Frames of bar graphs Input settings (numeral, thumbwheel) Fixed displays (figures) Screen background	Background		<table border="1"> <thead> <tr> <th>Display</th> <th>Element Type</th> </tr> </thead> <tbody> <tr> <td>Foreground</td> <td>Image/that lamps Recipe Alarm list/history frames Temporary input Character string input Thumbwheel type input Numeral input Trend graphs Broken line graphs Analogue meter Frames of bar graphs Numeral displays Character string displays Fixed displays Lamp displays Touch switches Image/library data Screen background</td> </tr> <tr> <td>Background</td> <td></td> </tr> </tbody> </table>	Display	Element Type	Foreground	Image/that lamps Recipe Alarm list/history frames Temporary input Character string input Thumbwheel type input Numeral input Trend graphs Broken line graphs Analogue meter Frames of bar graphs Numeral displays Character string displays Fixed displays Lamp displays Touch switches Image/library data Screen background	Background																																																																																																																																																																																																																																																																																																																								
Display	Element Type																																																																																																																																																																																																																																																																																																																																				
Foreground	Contents of display elements that have data Fixed displays (text, marks) Lamps (normal lamp frames) Touch switches Frames of bar graphs Input settings (numeral, thumbwheel) Fixed displays (figures) Screen background																																																																																																																																																																																																																																																																																																																																				
Background																																																																																																																																																																																																																																																																																																																																					
Display	Element Type																																																																																																																																																																																																																																																																																																																																				
Foreground	Image/that lamps Recipe Alarm list/history frames Temporary input Character string input Thumbwheel type input Numeral input Trend graphs Broken line graphs Analogue meter Frames of bar graphs Numeral displays Character string displays Fixed displays Lamp displays Touch switches Image/library data Screen background																																																																																																																																																																																																																																																																																																																																				
Background																																																																																																																																																																																																																																																																																																																																					
PT status control area	<table border="1"> <thead> <tr> <th>Word</th> <th colspan="16">Bit</th> </tr> <tr> <th>15</th><th>14</th><th>13</th><th>12</th><th>11</th><th>10</th><th>9</th><th>8</th><th>7</th><th>6</th><th>5</th><th>4</th><th>3</th><th>2</th><th>1</th><th>0</th> </tr> </thead> <tbody> <tr> <td>Word n</td> <td colspan="16">Screen number (4 BCD digits)</td> </tr> <tr> <td>Word n+1</td> <td colspan="3">0</td> <td colspan="13">Copy source memory table entry No. (3 BCD digits)</td> </tr> <tr> <td>Word n+2</td> <td colspan="3">Copy type</td> <td colspan="13">Copy destination memory table entry No. (3 BCD digits)</td> </tr> <tr> <td>Word n+3</td> <td colspan="16">PT status control bits</td> </tr> </tbody> </table> <table border="1"> <thead> <tr> <th>Word</th> <th>Controlled Item</th> <th>1 (ON)</th> <th>0 (OFF)</th> </tr> </thead> <tbody> <tr> <td>15</td> <td>Screen display</td> <td>Performed</td> <td>Not performed</td> </tr> <tr> <td>14</td> <td>Processing priority registration</td> <td>Registered</td> <td>Canceled</td> </tr> <tr> <td>13</td> <td>Continuous buzzer</td> <td>Sounded</td> <td>Stopped</td> </tr> <tr> <td>12</td> <td>Intermittent buzzer</td> <td>Sounded</td> <td>Stopped</td> </tr> <tr> <td>11</td> <td>Not used</td> <td colspan="2">Always 0</td> </tr> <tr> <td>10</td> <td>Not used</td> <td colspan="2">Always 0</td> </tr> <tr> <td>9</td> <td>Not used</td> <td colspan="2">Always 0</td> </tr> <tr> <td>8</td> <td>Backlight mode</td> <td>Lit</td> <td>Flashing</td> </tr> </tbody> </table> <p>Reflected in word unit</p>	Word	Bit																15	14	13	12	11	10	9	8	7	6	5	4	3	2	1	0	Word n	Screen number (4 BCD digits)																Word n+1	0			Copy source memory table entry No. (3 BCD digits)													Word n+2	Copy type			Copy destination memory table entry No. (3 BCD digits)													Word n+3	PT status control bits																Word	Controlled Item	1 (ON)	0 (OFF)	15	Screen display	Performed	Not performed	14	Processing priority registration	Registered	Canceled	13	Continuous buzzer	Sounded	Stopped	12	Intermittent buzzer	Sounded	Stopped	11	Not used	Always 0		10	Not used	Always 0		9	Not used	Always 0		8	Backlight mode	Lit	Flashing	<table border="1"> <thead> <tr> <th>Word</th> <th colspan="16">Bit</th> </tr> <tr> <th>15</th><th>14</th><th>13</th><th>12</th><th>11</th><th>10</th><th>9</th><th>8</th><th>7</th><th>6</th><th>5</th><th>4</th><th>3</th><th>2</th><th>1</th><th>0</th> </tr> </thead> <tbody> <tr> <td>Word n</td> <td colspan="16">Screen number (4 BCD or hexadecimal digits)</td> </tr> <tr> <td>Word n+1</td> <td colspan="16">Copy source memory table entry No. (4 BCD or hexadecimal digits)</td> </tr> <tr> <td>Word n+2</td> <td colspan="16">Copy destination memory table entry No. (4 BCD or hexadecimal digits)</td> </tr> <tr> <td>Word n+3</td> <td colspan="16">PT status control bits</td> </tr> <tr> <td>Word n+4</td> <td colspan="16">Reserved for system use</td> </tr> </tbody> </table> <table border="1"> <thead> <tr> <th>Word</th> <th>Controlled Item</th> <th>1 (ON)</th> <th>0 (OFF)</th> </tr> </thead> <tbody> <tr> <td>15</td> <td>Screen display</td> <td>Performed</td> <td>Not performed</td> </tr> <tr> <td>14</td> <td>Processing priority registration</td> <td>Registered</td> <td>Canceled</td> </tr> <tr> <td>13</td> <td>Continuous buzzer</td> <td>Sounded</td> <td>Stopped</td> </tr> <tr> <td>12</td> <td>Intermittent buzzer (short)</td> <td>Sounded</td> <td>Stopped</td> </tr> <tr> <td>11</td> <td>Display history initialization</td> <td>Performed</td> <td>Not performed</td> </tr> <tr> <td>10</td> <td>Not used</td> <td colspan="2">Always 0</td> </tr> <tr> <td>9</td> <td>Intermittent buzzer (long)</td> <td>Sounded</td> <td>Stopped</td> </tr> <tr> <td>8</td> <td>Backlight mode</td> <td>Lit</td> <td>Flashing</td> </tr> <tr> <td>7</td> <td>Not used</td> <td colspan="2">Always 0</td> </tr> <tr> <td>6</td> <td>PT window opening</td> <td>Disabled</td> <td>Enabled</td> </tr> <tr> <td>5</td> <td>Numeral/character string input</td> <td>Disabled</td> <td>Enabled</td> </tr> <tr> <td>4</td> <td>PT screen switching</td> <td>Disabled</td> <td>Enabled</td> </tr> <tr> <td>3</td> <td>Memory table copy execution</td> <td>Performed</td> <td>Not performed</td> </tr> <tr> <td>2</td> <td>Memory table copy type</td> <td>Numeral</td> <td>Character string</td> </tr> <tr> <td>1</td> <td>Alarm history initialization</td> <td>Performed</td> <td>Not performed</td> </tr> <tr> <td>0</td> <td>Not used</td> <td colspan="2">Always 0</td> </tr> </tbody> </table> <p>Reflected in bit unit</p>	Word	Bit																15	14	13	12	11	10	9	8	7	6	5	4	3	2	1	0	Word n	Screen number (4 BCD or hexadecimal digits)																Word n+1	Copy source memory table entry No. (4 BCD or hexadecimal digits)																Word n+2	Copy destination memory table entry No. (4 BCD or hexadecimal digits)																Word n+3	PT status control bits																Word n+4	Reserved for system use																Word	Controlled Item	1 (ON)	0 (OFF)	15	Screen display	Performed	Not performed	14	Processing priority registration	Registered	Canceled	13	Continuous buzzer	Sounded	Stopped	12	Intermittent buzzer (short)	Sounded	Stopped	11	Display history initialization	Performed	Not performed	10	Not used	Always 0		9	Intermittent buzzer (long)	Sounded	Stopped	8	Backlight mode	Lit	Flashing	7	Not used	Always 0		6	PT window opening	Disabled	Enabled	5	Numeral/character string input	Disabled	Enabled	4	PT screen switching	Disabled	Enabled	3	Memory table copy execution	Performed	Not performed	2	Memory table copy type	Numeral	Character string	1	Alarm history initialization	Performed	Not performed	0	Not used	Always 0	
Word	Bit																																																																																																																																																																																																																																																																																																																																				
15	14	13	12	11	10	9	8	7	6	5	4	3	2	1	0																																																																																																																																																																																																																																																																																																																						
Word n	Screen number (4 BCD digits)																																																																																																																																																																																																																																																																																																																																				
Word n+1	0			Copy source memory table entry No. (3 BCD digits)																																																																																																																																																																																																																																																																																																																																	
Word n+2	Copy type			Copy destination memory table entry No. (3 BCD digits)																																																																																																																																																																																																																																																																																																																																	
Word n+3	PT status control bits																																																																																																																																																																																																																																																																																																																																				
Word	Controlled Item	1 (ON)	0 (OFF)																																																																																																																																																																																																																																																																																																																																		
15	Screen display	Performed	Not performed																																																																																																																																																																																																																																																																																																																																		
14	Processing priority registration	Registered	Canceled																																																																																																																																																																																																																																																																																																																																		
13	Continuous buzzer	Sounded	Stopped																																																																																																																																																																																																																																																																																																																																		
12	Intermittent buzzer	Sounded	Stopped																																																																																																																																																																																																																																																																																																																																		
11	Not used	Always 0																																																																																																																																																																																																																																																																																																																																			
10	Not used	Always 0																																																																																																																																																																																																																																																																																																																																			
9	Not used	Always 0																																																																																																																																																																																																																																																																																																																																			
8	Backlight mode	Lit	Flashing																																																																																																																																																																																																																																																																																																																																		
Word	Bit																																																																																																																																																																																																																																																																																																																																				
15	14	13	12	11	10	9	8	7	6	5	4	3	2	1	0																																																																																																																																																																																																																																																																																																																						
Word n	Screen number (4 BCD or hexadecimal digits)																																																																																																																																																																																																																																																																																																																																				
Word n+1	Copy source memory table entry No. (4 BCD or hexadecimal digits)																																																																																																																																																																																																																																																																																																																																				
Word n+2	Copy destination memory table entry No. (4 BCD or hexadecimal digits)																																																																																																																																																																																																																																																																																																																																				
Word n+3	PT status control bits																																																																																																																																																																																																																																																																																																																																				
Word n+4	Reserved for system use																																																																																																																																																																																																																																																																																																																																				
Word	Controlled Item	1 (ON)	0 (OFF)																																																																																																																																																																																																																																																																																																																																		
15	Screen display	Performed	Not performed																																																																																																																																																																																																																																																																																																																																		
14	Processing priority registration	Registered	Canceled																																																																																																																																																																																																																																																																																																																																		
13	Continuous buzzer	Sounded	Stopped																																																																																																																																																																																																																																																																																																																																		
12	Intermittent buzzer (short)	Sounded	Stopped																																																																																																																																																																																																																																																																																																																																		
11	Display history initialization	Performed	Not performed																																																																																																																																																																																																																																																																																																																																		
10	Not used	Always 0																																																																																																																																																																																																																																																																																																																																			
9	Intermittent buzzer (long)	Sounded	Stopped																																																																																																																																																																																																																																																																																																																																		
8	Backlight mode	Lit	Flashing																																																																																																																																																																																																																																																																																																																																		
7	Not used	Always 0																																																																																																																																																																																																																																																																																																																																			
6	PT window opening	Disabled	Enabled																																																																																																																																																																																																																																																																																																																																		
5	Numeral/character string input	Disabled	Enabled																																																																																																																																																																																																																																																																																																																																		
4	PT screen switching	Disabled	Enabled																																																																																																																																																																																																																																																																																																																																		
3	Memory table copy execution	Performed	Not performed																																																																																																																																																																																																																																																																																																																																		
2	Memory table copy type	Numeral	Character string																																																																																																																																																																																																																																																																																																																																		
1	Alarm history initialization	Performed	Not performed																																																																																																																																																																																																																																																																																																																																		
0	Not used	Always 0																																																																																																																																																																																																																																																																																																																																			

Item	NT20S	NT21																																																																																												
PT status notify area	<p style="text-align: center;">Bit 15 14 13 12 11 10 9 8 7 6 5 4 3 2 1 0</p> <p>Word m: Screen number (4 BCD digits)</p> <p>Word m+1: 0 Numeral/character string memory table entry No. (3 BCD digits)</p> <p>Word m+2: PT status notify bits 0 0</p> <p>PT status notify bits</p> <table border="1" style="width: 100%; border-collapse: collapse;"> <thead> <tr> <th>Word</th> <th>Notified Information</th> <th>1 (ON)</th> <th>0 (OFF)</th> </tr> </thead> <tbody> <tr><td>15</td><td>PT operation status</td><td>Run</td><td>Stop</td></tr> <tr><td>14</td><td>Not used</td><td colspan="2">Always 0</td></tr> <tr><td>13</td><td>Not used</td><td colspan="2">Always 0</td></tr> <tr><td>12</td><td>Screen switch strobe</td><td>ON</td><td>OFF</td></tr> <tr><td>11</td><td>Numeral setting strobe</td><td>ON</td><td>OFF</td></tr> <tr><td>10</td><td>Not used</td><td colspan="2">Always 0</td></tr> <tr><td>9</td><td>Not used</td><td colspan="2">Always 0</td></tr> <tr><td>8</td><td>Not used</td><td colspan="2">Always 0</td></tr> </tbody> </table>	Word	Notified Information	1 (ON)	0 (OFF)	15	PT operation status	Run	Stop	14	Not used	Always 0		13	Not used	Always 0		12	Screen switch strobe	ON	OFF	11	Numeral setting strobe	ON	OFF	10	Not used	Always 0		9	Not used	Always 0		8	Not used	Always 0		<p style="text-align: center;">Bit 15 14 13 12 11 10 9 8 7 6 5 4 3 2 1 0</p> <p>Word m: Numeral/character string memory table entry No. (BCD or hexadecimal 4 digits)</p> <p>Word m+1: PT status notify bits 0 0 0</p> <p>PT status notify bits</p> <table border="1" style="width: 100%; border-collapse: collapse;"> <thead> <tr> <th>Word</th> <th>Notified Information</th> <th>1 (ON)</th> <th>0 (OFF)</th> </tr> </thead> <tbody> <tr><td>15</td><td>PT operation status</td><td>Run</td><td>Stop</td></tr> <tr><td>14</td><td>Not used</td><td colspan="2">Always 0</td></tr> <tr><td>13</td><td>Battery</td><td>Low</td><td>Normal</td></tr> <tr><td>12</td><td>Screen switch strobe</td><td>ON</td><td>OFF</td></tr> <tr><td>11</td><td>Numeral setting strobe</td><td>ON</td><td>OFF</td></tr> <tr><td>10</td><td>Character string setting strobe</td><td>ON</td><td>OFF</td></tr> <tr><td>9</td><td>Not used</td><td colspan="2">Always 0</td></tr> <tr><td>8</td><td>Not used</td><td colspan="2">Always 0</td></tr> <tr><td>7</td><td>Not used</td><td colspan="2">Always 0</td></tr> <tr><td>6</td><td>Backlight status</td><td>OFF</td><td>Lit/flashing</td></tr> <tr><td>5</td><td>Global window open status</td><td>Open</td><td>Close</td></tr> <tr><td>4</td><td>Local window 1 open status</td><td>Open</td><td>Close</td></tr> <tr><td>3</td><td>Local window 2 open status</td><td>Open</td><td>Close</td></tr> </tbody> </table> <p>The contents of Screen number of the displayed screen (PT status notify area word m in the NT20S) is written to PT status control area word n.</p>	Word	Notified Information	1 (ON)	0 (OFF)	15	PT operation status	Run	Stop	14	Not used	Always 0		13	Battery	Low	Normal	12	Screen switch strobe	ON	OFF	11	Numeral setting strobe	ON	OFF	10	Character string setting strobe	ON	OFF	9	Not used	Always 0		8	Not used	Always 0		7	Not used	Always 0		6	Backlight status	OFF	Lit/flashing	5	Global window open status	Open	Close	4	Local window 1 open status	Open	Close	3	Local window 2 open status	Open	Close
Word	Notified Information	1 (ON)	0 (OFF)																																																																																											
15	PT operation status	Run	Stop																																																																																											
14	Not used	Always 0																																																																																												
13	Not used	Always 0																																																																																												
12	Screen switch strobe	ON	OFF																																																																																											
11	Numeral setting strobe	ON	OFF																																																																																											
10	Not used	Always 0																																																																																												
9	Not used	Always 0																																																																																												
8	Not used	Always 0																																																																																												
Word	Notified Information	1 (ON)	0 (OFF)																																																																																											
15	PT operation status	Run	Stop																																																																																											
14	Not used	Always 0																																																																																												
13	Battery	Low	Normal																																																																																											
12	Screen switch strobe	ON	OFF																																																																																											
11	Numeral setting strobe	ON	OFF																																																																																											
10	Character string setting strobe	ON	OFF																																																																																											
9	Not used	Always 0																																																																																												
8	Not used	Always 0																																																																																												
7	Not used	Always 0																																																																																												
6	Backlight status	OFF	Lit/flashing																																																																																											
5	Global window open status	Open	Close																																																																																											
4	Local window 1 open status	Open	Close																																																																																											
3	Local window 2 open status	Open	Close																																																																																											
Window control area	None	<p style="text-align: center;">Bit 15 14 13 12 11 10 9 8 7 6 5 4 3 2 1 0</p> <p>Word k: Global window Screen No. (4-digit BCD or hexadecimal)</p> <p>Word k+1: Global window X coordinate (4-digit BCD or hexadecimal)</p> <p>Word k+2: Global window Y coordinate (4-digit BCD or hexadecimal)</p> <p>Word k+3: Local window1 Screen No. (4-digit BCD or hexadecimal)</p> <p>Word k+4: Local window1 X coordinate (4-digit BCD or hexadecimal)</p> <p>Word k+5: Local window1 Y coordinate (4-digit BCD or hexadecimal)</p> <p>Word k+6: Local window2 Screen No. (4-digit BCD or hexadecimal)</p> <p>Word k+7: Local window2 X coordinate (4-digit BCD or hexadecimal)</p> <p>Word k+8: Local window2 Y coordinate (4-digit BCD or hexadecimal)</p>																																																																																												
Clock data area	None	<p style="text-align: center;">Bit 15 14 13 12 11 10 9 8 7 6 5 4 3 2 1 0</p> <p>Word j: Minutes (2-digit BCD) Seconds (2-digit BCD)</p> <p>Word j + 1: Day of month (2-digit BCD) Hour (2-digit BCD)</p> <p>Word j + 2: Year (2-digit BCD) Month (2-digit BCD)</p> <p>Word j + 3: Always 00 Day of week (2-digit BCD)</p>																																																																																												
Screen display	<p>0: No display</p> <p>1 to 250, 256 to 500: Normal, overlapping, continuous screens</p>	<p>0: No display</p> <p>1 to 3999 : Normal screens, window screens, overlapping screens</p> <p>9000: System Initializing screen</p> <p>9001: Display history (occurrence order) screen</p> <p>9002: Display history (frequency order) screen</p> <p>9020: Screen for programming console function</p> <p>9999: Return to the previous screen</p>																																																																																												
Continuous screens	Possible	<p>Not possible</p> <p>A parent screen is deleted after the data conversion, such as from an NT20S.</p> <p>Use a switch screen touch switch instead.</p>																																																																																												

Item	NT20S	NT21
Initial screen	Host connect screen	System initializing screen
System keypad	Possible	Not possible Use touch switches instead. Also, symbol manager can be used at the Support Tool.
Image/library data	None	Image data: 0001 to 0FFF _H Library data: 1000 to 3FFF _H
Windows	None	<ul style="list-style-type: none"> Up to 3 screens can be displayed (1 global window, 2 local windows) Display elements that can be registered on a window All the display elements other than thumbwheel type numeral input and recipe objects (However, only 1 numeral/character string input (temporary input field) can be displayed.) <ul style="list-style-type: none"> Window screen size, 20-dot units
Display items treated as string character	Half-size/standard-size characters, marks, image/library data.	Half-size/standard-size characters, marks
Control codes in character strings	00 to 20 _H : Space	00 _H , 0A _H : Cut out subsequent display 01 to 09 _H , 0B to 20 _H : Space
Numeral display, character string display attributes	Normal, reverse, flashing, reverse and flashing, transparent display	Standard, flash, inverse flash
Bit memory table setting	None	Setting of recording in an alarm history and screen switching are possible.
Memory table copy	Numeral/character string type: Set at word n+2 (copy type) of the PT status control area (0: character string memory table, 1: numeral memory table) Copy timing: When the value of the n + 1 word or the n + 2 word in the PT status control area changes.	Numeral/character string type: Set at word n+2 (memory table copy type) of the PT status control area (0: character string memory table, 1: numeral memory table) Copy timing: Copying is executed when the word n+3 bit3 (Memory table copy execution) of the PT status control area changes to 1.
Interlock function	Not available	The interlock function can be set for individual touch switches, numeral inputs, thumbwheel inputs, character string inputs and recipe objects to enable/disable operation according to the status of the interlock bit allocated in the host.
Labels (Guide characters)	Fixed character strings only (1 line only)	Four kinds of character strings are available: Fixed character strings (Multiple lines are possible.) ON/OFF switching character strings (Multiple lines are possible.) Numeral displays (Displays numeral memory table entries.) Character string displays (Displays character string memory table entries.)
Touch switches lamp with free-shape display frames	Only the graphic part is displayed in reverse video. Example: 	Only the graphic part is displayed in reverse video; projecting parts are not displayed. Example: 

Item	NT20S	NT21																																																																																																									
Overlapping of touch switches	<p>In the following tables, No means neither function operates and YES means that both functions operate.</p> <p>Overlapping of two notification touch switches:</p> <table border="0"> <thead> <tr> <th></th> <th>Set</th> <th>Reset</th> <th>Alternate</th> <th>Momentary</th> </tr> </thead> <tbody> <tr> <td>Set</td> <td>No</td> <td>No</td> <td>No</td> <td>No</td> </tr> <tr> <td>Reset</td> <td>No</td> <td>No</td> <td>No</td> <td>No</td> </tr> <tr> <td>Alternate</td> <td>No</td> <td>No</td> <td>No</td> <td>No</td> </tr> <tr> <td>Momentary</td> <td>No</td> <td>No</td> <td>No</td> <td>YES</td> </tr> </tbody> </table> <p>Overlapping of a notification and other kind of touch switch:</p> <table border="0"> <thead> <tr> <th></th> <th>Set</th> <th>Reset</th> <th>Alternate</th> <th>Momentary</th> </tr> </thead> <tbody> <tr> <td>Screen switch</td> <td>No</td> <td>No</td> <td>No</td> <td>YES</td> </tr> <tr> <td>Control code input ...</td> <td>No</td> <td>No</td> <td>No</td> <td>YES</td> </tr> </tbody> </table> <p>Overlapping of two other kinds of touch switches: Neither function operates.</p>		Set	Reset	Alternate	Momentary	Set	No	No	No	No	Reset	No	No	No	No	Alternate	No	No	No	No	Momentary	No	No	No	YES		Set	Reset	Alternate	Momentary	Screen switch	No	No	No	YES	Control code input ...	No	No	No	YES	<p>In the following tables, YES means both functions operate and Qualified means that the momentary touch switch's bit and window open both go OFF at the same time.</p> <p>Overlapping of two notification touch switches:</p> <table border="0"> <thead> <tr> <th></th> <th>Set</th> <th>Reset</th> <th>Alternate</th> <th>Momentary</th> </tr> </thead> <tbody> <tr> <td>Set</td> <td>YES</td> <td>YES</td> <td>YES</td> <td>YES</td> </tr> <tr> <td>Reset</td> <td>YES</td> <td>YES</td> <td>YES</td> <td>YES</td> </tr> <tr> <td>Alternate</td> <td>YES</td> <td>YES</td> <td>YES</td> <td>YES</td> </tr> <tr> <td>Momentary</td> <td>YES</td> <td>YES</td> <td>YES</td> <td>YES</td> </tr> </tbody> </table> <p>Overlapping of a notification and other kind of touch switch:</p> <table border="0"> <thead> <tr> <th></th> <th>Set</th> <th>Reset</th> <th>Alternate</th> <th>Momentary</th> </tr> </thead> <tbody> <tr> <td>Screen switch</td> <td>YES</td> <td>YES</td> <td>YES</td> <td>YES</td> </tr> <tr> <td>Control code input ...</td> <td>YES</td> <td>YES</td> <td>YES</td> <td>YES</td> </tr> <tr> <td>Popup keyboard</td> <td>YES</td> <td>YES</td> <td>YES</td> <td>Qualified</td> </tr> <tr> <td>Character string input</td> <td>YES</td> <td>YES</td> <td>YES</td> <td>YES</td> </tr> <tr> <td>Copy setting</td> <td>YES</td> <td>YES</td> <td>YES</td> <td>YES</td> </tr> <tr> <td>Cursor movement ...</td> <td>YES</td> <td>YES</td> <td>YES</td> <td>YES</td> </tr> <tr> <td>Screen print</td> <td>YES</td> <td>YES</td> <td>YES</td> <td>YES</td> </tr> </tbody> </table> <p>Overlapping of two other kinds of touch switches: Neither function operates.</p>		Set	Reset	Alternate	Momentary	Set	YES	YES	YES	YES	Reset	YES	YES	YES	YES	Alternate	YES	YES	YES	YES	Momentary	YES	YES	YES	YES		Set	Reset	Alternate	Momentary	Screen switch	YES	YES	YES	YES	Control code input ...	YES	YES	YES	YES	Popup keyboard	YES	YES	YES	Qualified	Character string input	YES	YES	YES	YES	Copy setting	YES	YES	YES	YES	Cursor movement ...	YES	YES	YES	YES	Screen print	YES	YES	YES	YES
	Set	Reset	Alternate	Momentary																																																																																																							
Set	No	No	No	No																																																																																																							
Reset	No	No	No	No																																																																																																							
Alternate	No	No	No	No																																																																																																							
Momentary	No	No	No	YES																																																																																																							
	Set	Reset	Alternate	Momentary																																																																																																							
Screen switch	No	No	No	YES																																																																																																							
Control code input ...	No	No	No	YES																																																																																																							
	Set	Reset	Alternate	Momentary																																																																																																							
Set	YES	YES	YES	YES																																																																																																							
Reset	YES	YES	YES	YES																																																																																																							
Alternate	YES	YES	YES	YES																																																																																																							
Momentary	YES	YES	YES	YES																																																																																																							
	Set	Reset	Alternate	Momentary																																																																																																							
Screen switch	YES	YES	YES	YES																																																																																																							
Control code input ...	YES	YES	YES	YES																																																																																																							
Popup keyboard	YES	YES	YES	Qualified																																																																																																							
Character string input	YES	YES	YES	YES																																																																																																							
Copy setting	YES	YES	YES	YES																																																																																																							
Cursor movement ...	YES	YES	YES	YES																																																																																																							
Screen print	YES	YES	YES	YES																																																																																																							
Pop-up window function touch switch	None	Local window1 or local window2 can be controlled.																																																																																																									
Window move function touch switch	Not available	Available																																																																																																									
Memory link	None (Connection possible with NT20S-ST128 using RS-232C communications command.)	Available																																																																																																									
Mathematical function	Not available	Can be used to automatically execute up to 256 formulas registered in the mathematical table. (Operands (results) are automatically read from (written to) numeral memory table entries or PC words.)																																																																																																									
High-speed 1:N NT Link	Not available (Only the standard 1:N NT Link is supported.)	Available (Both the standard and high-speed 1:N NT Link are supported.)																																																																																																									
Recipe function	None	Normal screen: 1 max.; Multiple screens: 8 max.; Window screens: Not possible																																																																																																									
Clock function	None	Clock data is read from the host using the Clock Data Area (stored in numeral memory table entries 247 to 253).																																																																																																									
Accessible CS/CJ-series data areas	CIO area TIM area (timer PVs) CNT area (counter PVs) DM area	CIO area HR area WR area (work areas) TK area (task flags) TIM area (timer PVs) TU area (timer completion flags) CNT area (counter PVs) CU area (counter completion flags) DM area EM area (current bank, banks 0 to C)																																																																																																									

Apart from the above, due to difference between PT models, it may be necessary to modify screen data and programs at the host. For details, refer to the *NT-series Support Tool Version 4 for Windows Operation Manual* (V061-E1-□).

Differences between the NT30/NT30C and the NT31/NT31C and Differences between the NT620S/NT620C/NT625C and the NT631/NT631C

This section explains the differences in screen creation and programming between the NT30/NT30C and the NT31/NT31C as well as the NT620S/NT620C/NT625C and NT631/NT631C. The -V2 versions of the NT31/NT31C and NT631/NT631C are described here. For details of the differences between different versions of the NT31/NT31C and NT631/NT631C, refer to *Differences between NT31/NT31C and NT631/NT631C Models without the -V1 Suffix and Models with -V1* (page 451) or *Differences between -V1 and -V2 NT31/NT31C and NT631/NT631C PTs* (page 453).

Refer to *1-2 Functions of the NT21, NT31/NT31C, and NT631/NT631C* for details on functional differences between the PT models (page 4).

Reference: The NT30/620 compatible mode can be used to reduce the differences with the NT30, NT30C, NT620S, NT620C, and NT625C and allow their screen data and user programs to be reused easily. Refer to *Appendix C* for details (page 457).

Item	NT30/NT30C, NT620S/NT620C/NT625C	NT31/NT31C, NT631/NT631C																																																																																																																																																																																																																												
Fore-ground/back-ground relationships in screen drawing	<table border="1"> <thead> <tr> <th>Display</th> <th>Element Type</th> </tr> </thead> <tbody> <tr> <td>Foreground</td> <td>Contents of display elements that have data System keypad Frames of broken line graphs Frames of trend graphs Input settings (numeral, character string, thumbwheel, temporary) Frames of bar graphs Fixed displays Lamps (normal lamp frames) Alarm list/history frames Touch switches Image/library data Screen background</td> </tr> <tr> <td>Background</td> <td></td> </tr> </tbody> </table>	Display	Element Type	Foreground	Contents of display elements that have data System keypad Frames of broken line graphs Frames of trend graphs Input settings (numeral, character string, thumbwheel, temporary) Frames of bar graphs Fixed displays Lamps (normal lamp frames) Alarm list/history frames Touch switches Image/library data Screen background	Background		<table border="1"> <thead> <tr> <th>Display</th> <th>Element Type</th> </tr> </thead> <tbody> <tr> <td>Foreground</td> <td>Image/library lamps Recipe Alarm list/history frames Temporary input Character string input Thumbwheel type input Numeral input Trend graphs Broken line graphs Analogue meter Frames of bar graphs Numeral displays Character string displays Fixed displays Lamp displays Touch switches Image/library data Screen background</td> </tr> <tr> <td>Background</td> <td></td> </tr> </tbody> </table>	Display	Element Type	Foreground	Image/library lamps Recipe Alarm list/history frames Temporary input Character string input Thumbwheel type input Numeral input Trend graphs Broken line graphs Analogue meter Frames of bar graphs Numeral displays Character string displays Fixed displays Lamp displays Touch switches Image/library data Screen background	Background																																																																																																																																																																																																																	
Display	Element Type																																																																																																																																																																																																																													
Foreground	Contents of display elements that have data System keypad Frames of broken line graphs Frames of trend graphs Input settings (numeral, character string, thumbwheel, temporary) Frames of bar graphs Fixed displays Lamps (normal lamp frames) Alarm list/history frames Touch switches Image/library data Screen background																																																																																																																																																																																																																													
Background																																																																																																																																																																																																																														
Display	Element Type																																																																																																																																																																																																																													
Foreground	Image/library lamps Recipe Alarm list/history frames Temporary input Character string input Thumbwheel type input Numeral input Trend graphs Broken line graphs Analogue meter Frames of bar graphs Numeral displays Character string displays Fixed displays Lamp displays Touch switches Image/library data Screen background																																																																																																																																																																																																																													
Background																																																																																																																																																																																																																														
PT status control area	<table border="1"> <thead> <tr> <th>Word</th> <th colspan="16">Bit</th> </tr> <tr> <th></th> <th>15</th><th>14</th><th>13</th><th>12</th><th>11</th><th>10</th><th>9</th><th>8</th><th>7</th><th>6</th><th>5</th><th>4</th><th>3</th><th>2</th><th>1</th><th>0</th> </tr> </thead> <tbody> <tr> <td>Word n</td> <td colspan="16">Screen number (4 BCD digits)</td> </tr> <tr> <td>Word n+1</td> <td colspan="3">0</td> <td colspan="13">Copy source memory table entry No. (3 BCD digits)</td> </tr> <tr> <td>Word n+2</td> <td colspan="3">Copy type</td> <td colspan="13">Copy destination memory table entry No. (3 BCD digits)</td> </tr> <tr> <td>Word n+3</td> <td colspan="13">PT status control bits</td> <td>0</td> <td>0</td> </tr> </tbody> </table>	Word	Bit																	15	14	13	12	11	10	9	8	7	6	5	4	3	2	1	0	Word n	Screen number (4 BCD digits)																Word n+1	0			Copy source memory table entry No. (3 BCD digits)													Word n+2	Copy type			Copy destination memory table entry No. (3 BCD digits)													Word n+3	PT status control bits													0	0	<table border="1"> <thead> <tr> <th>Word</th> <th colspan="16">Bit</th> </tr> <tr> <th></th> <th>15</th><th>14</th><th>13</th><th>12</th><th>11</th><th>10</th><th>9</th><th>8</th><th>7</th><th>6</th><th>5</th><th>4</th><th>3</th><th>2</th><th>1</th><th>0</th> </tr> </thead> <tbody> <tr> <td>Word n</td> <td colspan="16">Screen number (4 BCD or hexadecimal digits)</td> </tr> <tr> <td>Word n+1</td> <td colspan="16">Copy source memory table entry No. (4 BCD or hexadecimal digits)</td> </tr> <tr> <td>Word n+2</td> <td colspan="16">Copy destination memory table entry No. (4 BCD or hexadecimal digits)</td> </tr> <tr> <td>Word n+3</td> <td colspan="16">PT status control bits</td> </tr> <tr> <td>Word n+4</td> <td colspan="16">Reserved for system use</td> </tr> </tbody> </table>	Word	Bit																	15	14	13	12	11	10	9	8	7	6	5	4	3	2	1	0	Word n	Screen number (4 BCD or hexadecimal digits)																Word n+1	Copy source memory table entry No. (4 BCD or hexadecimal digits)																Word n+2	Copy destination memory table entry No. (4 BCD or hexadecimal digits)																Word n+3	PT status control bits																Word n+4	Reserved for system use															
Word	Bit																																																																																																																																																																																																																													
	15	14	13	12	11	10	9	8	7	6	5	4	3	2	1	0																																																																																																																																																																																																														
Word n	Screen number (4 BCD digits)																																																																																																																																																																																																																													
Word n+1	0			Copy source memory table entry No. (3 BCD digits)																																																																																																																																																																																																																										
Word n+2	Copy type			Copy destination memory table entry No. (3 BCD digits)																																																																																																																																																																																																																										
Word n+3	PT status control bits													0	0																																																																																																																																																																																																															
Word	Bit																																																																																																																																																																																																																													
	15	14	13	12	11	10	9	8	7	6	5	4	3	2	1	0																																																																																																																																																																																																														
Word n	Screen number (4 BCD or hexadecimal digits)																																																																																																																																																																																																																													
Word n+1	Copy source memory table entry No. (4 BCD or hexadecimal digits)																																																																																																																																																																																																																													
Word n+2	Copy destination memory table entry No. (4 BCD or hexadecimal digits)																																																																																																																																																																																																																													
Word n+3	PT status control bits																																																																																																																																																																																																																													
Word n+4	Reserved for system use																																																																																																																																																																																																																													

Item	NT30/NT30C, NT620S/NT620C/NT625C	NT31/NT31C, NT631/NT631C																																																																																																																				
	<p>PT status control bits</p> <table border="1" data-bbox="268 220 841 594"> <thead> <tr> <th>Word</th> <th>Controlled Item</th> <th>1 (ON)</th> <th>0 (OFF)</th> </tr> </thead> <tbody> <tr><td>15</td><td>Screen display</td><td>Performed</td><td>Not performed</td></tr> <tr><td>14</td><td>Processing priority registration</td><td>Registered</td><td>Canceled</td></tr> <tr><td>13</td><td>Continuous buzzer</td><td>Sounded</td><td>Stopped</td></tr> <tr><td>12</td><td>Intermittent buzzer (short)</td><td>Sounded</td><td>Stopped</td></tr> <tr><td>11</td><td>Display history initialization</td><td>Performed</td><td>Not performed</td></tr> <tr><td>10</td><td>Not used</td><td colspan="2">Always 0</td></tr> <tr><td>9</td><td>Intermittent buzzer (long)</td><td>Sounded</td><td>Stopped</td></tr> <tr><td>8</td><td>Not used</td><td colspan="2">Always 0</td></tr> <tr><td>7</td><td>Screen printing</td><td>Performed</td><td>Not performed</td></tr> <tr><td>6</td><td>Window opening</td><td>Disabled</td><td>Enabled</td></tr> <tr><td>5</td><td>Numeral/character string input</td><td>Disabled</td><td>Enabled</td></tr> </tbody> </table> <p>*1: Not used in the NT30C, NT620S, NT620C, and NT625C. *2: Not used in the NT620S, NT620C, and NT625C. Reflected in word unit</p>	Word	Controlled Item	1 (ON)	0 (OFF)	15	Screen display	Performed	Not performed	14	Processing priority registration	Registered	Canceled	13	Continuous buzzer	Sounded	Stopped	12	Intermittent buzzer (short)	Sounded	Stopped	11	Display history initialization	Performed	Not performed	10	Not used	Always 0		9	Intermittent buzzer (long)	Sounded	Stopped	8	Not used	Always 0		7	Screen printing	Performed	Not performed	6	Window opening	Disabled	Enabled	5	Numeral/character string input	Disabled	Enabled	<p>PT status control bits</p> <table border="1" data-bbox="853 220 1441 751"> <thead> <tr> <th>Word</th> <th>Controlled Item</th> <th>1 (ON)</th> <th>0 (OFF)</th> </tr> </thead> <tbody> <tr><td>15</td><td>Screen display</td><td>Performed</td><td>Not performed</td></tr> <tr><td>14</td><td>Processing priority registration</td><td>Registered</td><td>Canceled</td></tr> <tr><td>13</td><td>Continuous buzzer</td><td>Sounded</td><td>Stopped</td></tr> <tr><td>12</td><td>Intermittent buzzer (short)</td><td>Sounded</td><td>Stopped</td></tr> <tr><td>11</td><td>Display history initialization</td><td>Performed</td><td>Not performed</td></tr> <tr><td>10</td><td>Not used</td><td colspan="2">Always 0</td></tr> <tr><td>9</td><td>Intermittent buzzer (long)</td><td>Sounded</td><td>Stopped</td></tr> <tr><td>8</td><td>Backlight mode</td><td>Lit</td><td>Flashing</td></tr> <tr><td>7</td><td>Screen printing</td><td>Performed</td><td>Not performed</td></tr> <tr><td>6</td><td>PT window opening</td><td>Disabled</td><td>Enabled</td></tr> <tr><td>5</td><td>Numeral/character string input</td><td>Disabled</td><td>Enabled</td></tr> <tr><td>4</td><td>PT screen switching</td><td>Disabled</td><td>Enabled</td></tr> <tr><td>3</td><td>Memory table copy execution</td><td>Performed</td><td>Not performed</td></tr> <tr><td>2</td><td>Memory table copy type</td><td>Numeral</td><td>Character string</td></tr> <tr><td>1</td><td>Alarm history initialization</td><td>Performed</td><td>Not performed</td></tr> <tr><td>0</td><td>Not used</td><td colspan="2">Always 0</td></tr> </tbody> </table> <p>Reflected in bit unit</p>	Word	Controlled Item	1 (ON)	0 (OFF)	15	Screen display	Performed	Not performed	14	Processing priority registration	Registered	Canceled	13	Continuous buzzer	Sounded	Stopped	12	Intermittent buzzer (short)	Sounded	Stopped	11	Display history initialization	Performed	Not performed	10	Not used	Always 0		9	Intermittent buzzer (long)	Sounded	Stopped	8	Backlight mode	Lit	Flashing	7	Screen printing	Performed	Not performed	6	PT window opening	Disabled	Enabled	5	Numeral/character string input	Disabled	Enabled	4	PT screen switching	Disabled	Enabled	3	Memory table copy execution	Performed	Not performed	2	Memory table copy type	Numeral	Character string	1	Alarm history initialization	Performed	Not performed	0	Not used	Always 0	
Word	Controlled Item	1 (ON)	0 (OFF)																																																																																																																			
15	Screen display	Performed	Not performed																																																																																																																			
14	Processing priority registration	Registered	Canceled																																																																																																																			
13	Continuous buzzer	Sounded	Stopped																																																																																																																			
12	Intermittent buzzer (short)	Sounded	Stopped																																																																																																																			
11	Display history initialization	Performed	Not performed																																																																																																																			
10	Not used	Always 0																																																																																																																				
9	Intermittent buzzer (long)	Sounded	Stopped																																																																																																																			
8	Not used	Always 0																																																																																																																				
7	Screen printing	Performed	Not performed																																																																																																																			
6	Window opening	Disabled	Enabled																																																																																																																			
5	Numeral/character string input	Disabled	Enabled																																																																																																																			
Word	Controlled Item	1 (ON)	0 (OFF)																																																																																																																			
15	Screen display	Performed	Not performed																																																																																																																			
14	Processing priority registration	Registered	Canceled																																																																																																																			
13	Continuous buzzer	Sounded	Stopped																																																																																																																			
12	Intermittent buzzer (short)	Sounded	Stopped																																																																																																																			
11	Display history initialization	Performed	Not performed																																																																																																																			
10	Not used	Always 0																																																																																																																				
9	Intermittent buzzer (long)	Sounded	Stopped																																																																																																																			
8	Backlight mode	Lit	Flashing																																																																																																																			
7	Screen printing	Performed	Not performed																																																																																																																			
6	PT window opening	Disabled	Enabled																																																																																																																			
5	Numeral/character string input	Disabled	Enabled																																																																																																																			
4	PT screen switching	Disabled	Enabled																																																																																																																			
3	Memory table copy execution	Performed	Not performed																																																																																																																			
2	Memory table copy type	Numeral	Character string																																																																																																																			
1	Alarm history initialization	Performed	Not performed																																																																																																																			
0	Not used	Always 0																																																																																																																				
<p>PT status notify area</p>	<table border="1" data-bbox="268 791 809 976"> <thead> <tr> <th>Word</th> <th>Bit</th> </tr> </thead> <tbody> <tr> <td>Word m</td> <td>15 14 13 12 11 10 9 8 7 6 5 4 3 2 1 0</td> </tr> <tr> <td>Word m</td> <td>Screen number (4 BCD digits)</td> </tr> <tr> <td>Word m+1</td> <td>0 Numerical/character string memory table entry No. (3 BCD digits)</td> </tr> <tr> <td>Word m+2</td> <td>PT status notify bits 0 0 0 0</td> </tr> </tbody> </table> <p>PT status notify bits</p> <table border="1" data-bbox="268 1039 841 1354"> <thead> <tr> <th>Word</th> <th>Notified Information</th> <th>1 (ON)</th> <th>0 (OFF)</th> </tr> </thead> <tbody> <tr><td>15</td><td>PT operation status</td><td>Run</td><td>Stop</td></tr> <tr><td>14</td><td>Not used</td><td colspan="2">Always 0</td></tr> <tr><td>13</td><td>Battery</td><td>Low</td><td>Normal</td></tr> <tr><td>12</td><td>Screen switch strobe</td><td>ON</td><td>OFF</td></tr> <tr><td>11</td><td>Numeral setting strobe</td><td>ON</td><td>OFF</td></tr> <tr><td>10</td><td>Character string setting strobe</td><td>ON</td><td>OFF</td></tr> <tr><td>9</td><td>Not used</td><td colspan="2">Always 0</td></tr> <tr><td>8</td><td>Not used</td><td colspan="2">Always 0</td></tr> <tr><td>7</td><td>Printer operating status</td><td>Printing</td><td>Stopped</td></tr> </tbody> </table>	Word	Bit	Word m	15 14 13 12 11 10 9 8 7 6 5 4 3 2 1 0	Word m	Screen number (4 BCD digits)	Word m+1	0 Numerical/character string memory table entry No. (3 BCD digits)	Word m+2	PT status notify bits 0 0 0 0	Word	Notified Information	1 (ON)	0 (OFF)	15	PT operation status	Run	Stop	14	Not used	Always 0		13	Battery	Low	Normal	12	Screen switch strobe	ON	OFF	11	Numeral setting strobe	ON	OFF	10	Character string setting strobe	ON	OFF	9	Not used	Always 0		8	Not used	Always 0		7	Printer operating status	Printing	Stopped	<table border="1" data-bbox="853 791 1406 934"> <thead> <tr> <th>Word</th> <th>Bit</th> </tr> </thead> <tbody> <tr> <td>Word m</td> <td>15 14 13 12 11 10 9 8 7 6 5 4 3 2 1 0</td> </tr> <tr> <td>Word m</td> <td>Numerical/character string memory table entry No. (BCD or hexadecimal 4 digits)</td> </tr> <tr> <td>Word m+1</td> <td>PT status notify bits 0 0 0</td> </tr> </tbody> </table> <p>PT status notify bits</p> <table border="1" data-bbox="853 1039 1441 1480"> <thead> <tr> <th>Word</th> <th>Notified Information</th> <th>1 (ON)</th> <th>0 (OFF)</th> </tr> </thead> <tbody> <tr><td>15</td><td>PT operation status</td><td>Run</td><td>Stop</td></tr> <tr><td>14</td><td>Not used</td><td colspan="2">Always 0</td></tr> <tr><td>13</td><td>Battery</td><td>Low</td><td>Normal</td></tr> <tr><td>12</td><td>Screen switch strobe</td><td>ON</td><td>OFF</td></tr> <tr><td>11</td><td>Numeral setting strobe</td><td>ON</td><td>OFF</td></tr> <tr><td>10</td><td>Character string setting strobe</td><td>ON</td><td>OFF</td></tr> <tr><td>9</td><td>Not used</td><td colspan="2">Always 0</td></tr> <tr><td>8</td><td>Not used</td><td colspan="2">Always 0</td></tr> <tr><td>7</td><td>Printer operating status</td><td>Printing</td><td>Stopped</td></tr> <tr><td>6</td><td>Backlight status</td><td>OFF</td><td>Lit/flashing</td></tr> <tr><td>5*</td><td>Global window open status</td><td>Open</td><td>Close</td></tr> <tr><td>4*</td><td>Local window 1 open status</td><td>Open</td><td>Close</td></tr> <tr><td>3*</td><td>Local window 2 open status</td><td>Open</td><td>Close</td></tr> </tbody> </table> <p>* : Added for V1 The contents of Screen number of the displayed screen (PT status notify area word m in the NT30/NT30C, NT620S/NT620C/NT625C) is written to PT status control area word n.</p>	Word	Bit	Word m	15 14 13 12 11 10 9 8 7 6 5 4 3 2 1 0	Word m	Numerical/character string memory table entry No. (BCD or hexadecimal 4 digits)	Word m+1	PT status notify bits 0 0 0	Word	Notified Information	1 (ON)	0 (OFF)	15	PT operation status	Run	Stop	14	Not used	Always 0		13	Battery	Low	Normal	12	Screen switch strobe	ON	OFF	11	Numeral setting strobe	ON	OFF	10	Character string setting strobe	ON	OFF	9	Not used	Always 0		8	Not used	Always 0		7	Printer operating status	Printing	Stopped	6	Backlight status	OFF	Lit/flashing	5*	Global window open status	Open	Close	4*	Local window 1 open status	Open	Close	3*	Local window 2 open status	Open	Close		
Word	Bit																																																																																																																					
Word m	15 14 13 12 11 10 9 8 7 6 5 4 3 2 1 0																																																																																																																					
Word m	Screen number (4 BCD digits)																																																																																																																					
Word m+1	0 Numerical/character string memory table entry No. (3 BCD digits)																																																																																																																					
Word m+2	PT status notify bits 0 0 0 0																																																																																																																					
Word	Notified Information	1 (ON)	0 (OFF)																																																																																																																			
15	PT operation status	Run	Stop																																																																																																																			
14	Not used	Always 0																																																																																																																				
13	Battery	Low	Normal																																																																																																																			
12	Screen switch strobe	ON	OFF																																																																																																																			
11	Numeral setting strobe	ON	OFF																																																																																																																			
10	Character string setting strobe	ON	OFF																																																																																																																			
9	Not used	Always 0																																																																																																																				
8	Not used	Always 0																																																																																																																				
7	Printer operating status	Printing	Stopped																																																																																																																			
Word	Bit																																																																																																																					
Word m	15 14 13 12 11 10 9 8 7 6 5 4 3 2 1 0																																																																																																																					
Word m	Numerical/character string memory table entry No. (BCD or hexadecimal 4 digits)																																																																																																																					
Word m+1	PT status notify bits 0 0 0																																																																																																																					
Word	Notified Information	1 (ON)	0 (OFF)																																																																																																																			
15	PT operation status	Run	Stop																																																																																																																			
14	Not used	Always 0																																																																																																																				
13	Battery	Low	Normal																																																																																																																			
12	Screen switch strobe	ON	OFF																																																																																																																			
11	Numeral setting strobe	ON	OFF																																																																																																																			
10	Character string setting strobe	ON	OFF																																																																																																																			
9	Not used	Always 0																																																																																																																				
8	Not used	Always 0																																																																																																																				
7	Printer operating status	Printing	Stopped																																																																																																																			
6	Backlight status	OFF	Lit/flashing																																																																																																																			
5*	Global window open status	Open	Close																																																																																																																			
4*	Local window 1 open status	Open	Close																																																																																																																			
3*	Local window 2 open status	Open	Close																																																																																																																			

Item	NT30/NT30C, NT620S/NT620C/NT625C	NT31/NT31C, NT631/NT631C																		
Window control area	None	<p style="text-align: center;">Bit</p> <p style="text-align: center;">Word 15 14 13 12 11 10 9 8 7 6 5 4 3 2 1 0</p> <table border="1" style="width: 100%; border-collapse: collapse;"> <tr> <td style="width: 15%; text-align: right;">Word k</td> <td style="text-align: center;">Global window Screen No. (4-digit BCD or hexadecimal)</td> </tr> <tr> <td style="text-align: right;">Word k+1</td> <td style="text-align: center;">Global window X coordinate (4-digit BCD or hexadecimal)</td> </tr> <tr> <td style="text-align: right;">Word k+2</td> <td style="text-align: center;">Global window Y coordinate (4-digit BCD or hexadecimal)</td> </tr> <tr> <td style="text-align: right;">Word k+3</td> <td style="text-align: center;">Local window1 Screen No. (4-digit BCD or hexadecimal)</td> </tr> <tr> <td style="text-align: right;">Word k+4</td> <td style="text-align: center;">Local window1 X coordinate (4-digit BCD or hexadecimal)</td> </tr> <tr> <td style="text-align: right;">Word k+5</td> <td style="text-align: center;">Local window1 Y coordinate (4-digit BCD or hexadecimal)</td> </tr> <tr> <td style="text-align: right;">Word k+6</td> <td style="text-align: center;">Local window2 Screen No. (4-digit BCD or hexadecimal)</td> </tr> <tr> <td style="text-align: right;">Word k+7</td> <td style="text-align: center;">Local window2 X coordinate (4-digit BCD or hexadecimal)</td> </tr> <tr> <td style="text-align: right;">Word k+8</td> <td style="text-align: center;">Local window2 Y coordinate (4-digit BCD or hexadecimal)</td> </tr> </table>	Word k	Global window Screen No. (4-digit BCD or hexadecimal)	Word k+1	Global window X coordinate (4-digit BCD or hexadecimal)	Word k+2	Global window Y coordinate (4-digit BCD or hexadecimal)	Word k+3	Local window1 Screen No. (4-digit BCD or hexadecimal)	Word k+4	Local window1 X coordinate (4-digit BCD or hexadecimal)	Word k+5	Local window1 Y coordinate (4-digit BCD or hexadecimal)	Word k+6	Local window2 Screen No. (4-digit BCD or hexadecimal)	Word k+7	Local window2 X coordinate (4-digit BCD or hexadecimal)	Word k+8	Local window2 Y coordinate (4-digit BCD or hexadecimal)
Word k	Global window Screen No. (4-digit BCD or hexadecimal)																			
Word k+1	Global window X coordinate (4-digit BCD or hexadecimal)																			
Word k+2	Global window Y coordinate (4-digit BCD or hexadecimal)																			
Word k+3	Local window1 Screen No. (4-digit BCD or hexadecimal)																			
Word k+4	Local window1 X coordinate (4-digit BCD or hexadecimal)																			
Word k+5	Local window1 Y coordinate (4-digit BCD or hexadecimal)																			
Word k+6	Local window2 Screen No. (4-digit BCD or hexadecimal)																			
Word k+7	Local window2 X coordinate (4-digit BCD or hexadecimal)																			
Word k+8	Local window2 Y coordinate (4-digit BCD or hexadecimal)																			
Screen display	0: No display 1 to 1899: Normal screens 1900 to 1979: Window screens, normal screens 1980 to 1996: Expansion functions, normal screens 1997: Display history (occurrence order) screen 1998: Display history (frequency order) screen 1999: Connected to host screen	0: No display 1 to 3999 : Normal screens, window screens, overlapping screens 9000: System Initializing screen 9001: Display history (occurrence order) screen 9002: Display history (frequency order) screen 9020: Screen for programming console function 9021 to 9023: Device Monitor function 9030: Brightness and contract adjustment screen 9999: Return to the previous screen																		
Continuous screens	Possible	Not possible A parent screen is deleted after the data conversion, such as from an NT30/NT30C or NT620S/NT620C/NT625C to a NT31/NT31C or NT631/NT631C. Use a switch screen touch switch instead.																		
Overlapping screens	A window or keyboard screen can be specified as a child screen.	A window or keyboard screen cannot be specified as a child screen.																		
Initial screen	Host connect screen	System initializing screen																		
System keypad	Possible	Not possible Use touch switches instead. Also, symbol manager can be used at the Support Tool.																		
Image/library data	Image data: FE20 to FEFFH Library data: FA20 to FAFFH FB20 to FBFFH FC20 to FCFFH FD20 to FDFFH	Image data: 0001 to 0FFFH Library data: 1000 to 3FFFH * On data conversion from the NT30/NT30C or NT620S/NT620C/NT625C, the codes are automatically converted.																		
Data to be handled as a string	Half-size/standard-size characters, marks, image/library data.	Half-size/standard-size characters, marks * Image/library object can be used instead of image/library data																		
Window	<ul style="list-style-type: none"> Only 1 window can be displayed Display elements that can be registered on a window Fixed display Touch switch (Notify bit, cursor move and print screen functions are not available) Numeral/character string input (only 1 of these) <ul style="list-style-type: none"> Window screen size, 1-dot units 	<ul style="list-style-type: none"> Up to 3 screens can be displayed (1 global window, 2 local windows) Display elements that can be registered on a window All the display elements other than thumbwheel type numeral input and recipe objects (However, only 1 numeral/character string input (temporary input field) can be displayed.) <ul style="list-style-type: none"> Window screen size, 20-dot units 																		
Display items treated as string character	Half-size/standard-size characters, marks, image/library data.	Half-size/standard-size characters, marks																		
Control codes in character strings	00 to 20H: Space	00H, 0AH: Cut out subsequent display 01 to 09H, 0B to 20H: Space																		

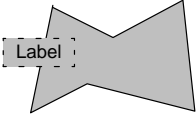
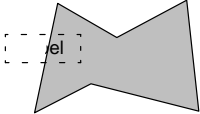
Item	NT30/NT30C, NT620S/NT620C/NT625C	NT31/NT31C, NT631/NT631C																																																																																																																																		
Numeral display, character string display attributes	Normal, reverse, flashing, reverse and flashing, transparent display	Standard, flash, inverse flash, transparent display																																																																																																																																		
Bit memory table entry setting	Simultaneous setting of recording in an alarm history and screen switching is possible.	Simultaneous setting of recording in an alarm history and screen switching is not possible (if NT30/NT30C data in which simultaneous operation is specified is converted for use with an NT31/NT31C, only the alarm history recording operation is performed).																																																																																																																																		
Memory table copy	Numeral/character string type: Set at word n+2 (copy type) of the PT status control area (0: character string memory table, 1: numeral memory table) Copy timing: When the value of the n + 1 word or the n + 2 word in the PT status control area changes.	Numeral/character string type: Set at word n+2 (memory table copy type) of the PT status control area (0: character string memory table, 1: numeral memory table) Copy timing: Copying is executed when the word n+3 bit3 (Memory table copy execution) of the PT status control area changes to 1.																																																																																																																																		
Indirect display	When a number outside the range of table entry numbers set in the system settings is specified as a jump destination: · Up to 999: The display contents are cleared. · 1000 or above: The previous display remains displayed Example: 512 character string memory table entries <table border="1" style="width: 100%; border-collapse: collapse;"> <thead> <tr> <th>Jump destination number specification</th> <th>Display contents</th> </tr> </thead> <tbody> <tr> <td>0 to 511</td> <td>Table contents</td> </tr> <tr> <td>512 to 999</td> <td>Display cleared</td> </tr> <tr> <td>1000 or above</td> <td>Display not updated</td> </tr> </tbody> </table>	Jump destination number specification	Display contents	0 to 511	Table contents	512 to 999	Display cleared	1000 or above	Display not updated	When a number outside the range of table entry numbers set in the system settings is specified as a jump destination: · The previous display remains displayed in all cases. Example: 512 character string memory table entries <table border="1" style="width: 100%; border-collapse: collapse;"> <thead> <tr> <th>Jump destination number specification</th> <th>Display contents</th> </tr> </thead> <tbody> <tr> <td>0 to 511</td> <td>Table contents</td> </tr> <tr> <td>512 or above</td> <td>Display not updated</td> </tr> </tbody> </table>	Jump destination number specification	Display contents	0 to 511	Table contents	512 or above	Display not updated																																																																																																																				
Jump destination number specification	Display contents																																																																																																																																			
0 to 511	Table contents																																																																																																																																			
512 to 999	Display cleared																																																																																																																																			
1000 or above	Display not updated																																																																																																																																			
Jump destination number specification	Display contents																																																																																																																																			
0 to 511	Table contents																																																																																																																																			
512 or above	Display not updated																																																																																																																																			
Interlock function	Not available	The interlock function can be set for individual touch switches, numeral inputs, thumbwheel inputs, character string inputs, and recipe objects to enable/disable operation according to the status of the interlock bit allocated in the host.																																																																																																																																		
Labels (Guide characters)	Fixed character strings only (1 line only)	Four kinds of character strings are available: Fixed character strings (Multiple lines are possible.) ON/OFF switching character strings (Multiple lines are possible.) Numeral displays (Displays numeral memory table entries.) Character string displays (Displays character string memory table entries.)																																																																																																																																		
Touch switches lamp with free-shape display frames	All of the graphic part and label are displayed in reverse video. Example: 	Only the graphic part is displayed in reverse video; projecting parts are not displayed. Example: 																																																																																																																																		
Expansion I/O	NT30/NT30C: Available Other PTs: Not available	Not available																																																																																																																																		
Overlapping of touch switches	In the following tables, No means neither function operates and YES means that both functions operate. Overlapping of two notification touch switches: <table style="width: 100%; border-collapse: collapse;"> <thead> <tr> <th></th> <th>Set</th> <th>Reset</th> <th>Alternate</th> <th>Momentary</th> </tr> </thead> <tbody> <tr> <td>Set</td> <td>No</td> <td>No</td> <td>No</td> <td>No</td> </tr> <tr> <td>Reset</td> <td>No</td> <td>No</td> <td>No</td> <td>No</td> </tr> <tr> <td>Alternate</td> <td>No</td> <td>No</td> <td>No</td> <td>No</td> </tr> <tr> <td>Momentary</td> <td>No</td> <td>No</td> <td>No</td> <td>YES</td> </tr> </tbody> </table> Overlapping of a notification and other kind of touch switch: <table style="width: 100%; border-collapse: collapse;"> <thead> <tr> <th></th> <th>Set</th> <th>Reset</th> <th>Alternate</th> <th>Momentary</th> </tr> </thead> <tbody> <tr> <td>Screen switch</td> <td>No</td> <td>No</td> <td>No</td> <td>YES</td> </tr> <tr> <td>Control code input</td> <td>No</td> <td>No</td> <td>No</td> <td>YES</td> </tr> <tr> <td>Popup keyboard</td> <td>No</td> <td>No</td> <td>No</td> <td>No</td> </tr> <tr> <td>Character string input</td> <td>No</td> <td>No</td> <td>No</td> <td>YES</td> </tr> <tr> <td>Copy setting</td> <td>No</td> <td>No</td> <td>No</td> <td>YES</td> </tr> <tr> <td>Cursor movement</td> <td>No</td> <td>No</td> <td>No</td> <td>YES</td> </tr> <tr> <td>Screen print</td> <td>No</td> <td>No</td> <td>No</td> <td>YES</td> </tr> </tbody> </table> Overlapping of two other kinds of touch switches: Neither function operates.		Set	Reset	Alternate	Momentary	Set	No	No	No	No	Reset	No	No	No	No	Alternate	No	No	No	No	Momentary	No	No	No	YES		Set	Reset	Alternate	Momentary	Screen switch	No	No	No	YES	Control code input	No	No	No	YES	Popup keyboard	No	No	No	No	Character string input	No	No	No	YES	Copy setting	No	No	No	YES	Cursor movement	No	No	No	YES	Screen print	No	No	No	YES	In the following tables, YES means both functions operate and Qualified means that the momentary touch switch's bit and window open both go OFF at the same time. Overlapping of two notification touch switches: <table style="width: 100%; border-collapse: collapse;"> <thead> <tr> <th></th> <th>Set</th> <th>Reset</th> <th>Alternate</th> <th>Momentary</th> </tr> </thead> <tbody> <tr> <td>Set</td> <td>YES</td> <td>YES</td> <td>YES</td> <td>YES</td> </tr> <tr> <td>Reset</td> <td>YES</td> <td>YES</td> <td>YES</td> <td>YES</td> </tr> <tr> <td>Alternate</td> <td>YES</td> <td>YES</td> <td>YES</td> <td>YES</td> </tr> <tr> <td>Momentary</td> <td>YES</td> <td>YES</td> <td>YES</td> <td>YES</td> </tr> </tbody> </table> Overlapping of a notification and other kind of touch switch: <table style="width: 100%; border-collapse: collapse;"> <thead> <tr> <th></th> <th>Set</th> <th>Reset</th> <th>Alternate</th> <th>Momentary</th> </tr> </thead> <tbody> <tr> <td>Screen switch</td> <td>YES</td> <td>YES</td> <td>YES</td> <td>YES</td> </tr> <tr> <td>Control code input</td> <td>YES</td> <td>YES</td> <td>YES</td> <td>YES</td> </tr> <tr> <td>Popup keyboard</td> <td>YES</td> <td>YES</td> <td>YES</td> <td>Qualified</td> </tr> <tr> <td>Character string input</td> <td>YES</td> <td>YES</td> <td>YES</td> <td>YES</td> </tr> <tr> <td>Copy setting</td> <td>YES</td> <td>YES</td> <td>YES</td> <td>YES</td> </tr> <tr> <td>Cursor movement</td> <td>YES</td> <td>YES</td> <td>YES</td> <td>YES</td> </tr> <tr> <td>Screen print</td> <td>YES</td> <td>YES</td> <td>YES</td> <td>YES</td> </tr> </tbody> </table> Overlapping of two other kinds of touch switches: Neither function operates.		Set	Reset	Alternate	Momentary	Set	YES	YES	YES	YES	Reset	YES	YES	YES	YES	Alternate	YES	YES	YES	YES	Momentary	YES	YES	YES	YES		Set	Reset	Alternate	Momentary	Screen switch	YES	YES	YES	YES	Control code input	YES	YES	YES	YES	Popup keyboard	YES	YES	YES	Qualified	Character string input	YES	YES	YES	YES	Copy setting	YES	YES	YES	YES	Cursor movement	YES	YES	YES	YES	Screen print	YES	YES	YES	YES
	Set	Reset	Alternate	Momentary																																																																																																																																
Set	No	No	No	No																																																																																																																																
Reset	No	No	No	No																																																																																																																																
Alternate	No	No	No	No																																																																																																																																
Momentary	No	No	No	YES																																																																																																																																
	Set	Reset	Alternate	Momentary																																																																																																																																
Screen switch	No	No	No	YES																																																																																																																																
Control code input	No	No	No	YES																																																																																																																																
Popup keyboard	No	No	No	No																																																																																																																																
Character string input	No	No	No	YES																																																																																																																																
Copy setting	No	No	No	YES																																																																																																																																
Cursor movement	No	No	No	YES																																																																																																																																
Screen print	No	No	No	YES																																																																																																																																
	Set	Reset	Alternate	Momentary																																																																																																																																
Set	YES	YES	YES	YES																																																																																																																																
Reset	YES	YES	YES	YES																																																																																																																																
Alternate	YES	YES	YES	YES																																																																																																																																
Momentary	YES	YES	YES	YES																																																																																																																																
	Set	Reset	Alternate	Momentary																																																																																																																																
Screen switch	YES	YES	YES	YES																																																																																																																																
Control code input	YES	YES	YES	YES																																																																																																																																
Popup keyboard	YES	YES	YES	Qualified																																																																																																																																
Character string input	YES	YES	YES	YES																																																																																																																																
Copy setting	YES	YES	YES	YES																																																																																																																																
Cursor movement	YES	YES	YES	YES																																																																																																																																
Screen print	YES	YES	YES	YES																																																																																																																																

Item	NT30/NT30C, NT620S/NT620C/NT625C	NT31/NT31C, NT631/NT631C
Pop-up window function touch switch	Only Keyboard screen can be controlled. Window display position can not be changed.	Local window1 or local window2 can be controlled. Window display position can be changed.
Window move function touch switch	Not available	Available
System program for memory link	Memory link only	Shared with OMRON/Memory link (-V1 and later versions)
Screen data for memory link	OMRON screen data (data area allocation only, no allocation check)	Memory link screen data (Allocation check is possible.)
Device Monitor function	Not available	Can be used to switch the PC's operating mode, display/change contents of PC words, and display the error log.
Mathematical function	Not available	Can be used to automatically execute up to 256 formulas registered in mathematical table. (Operands (results) are automatically read from (written to) numeral memory table entries or PC words.)
High-speed 1:N NT Link	Not available (Only the standard 1:N NT Link is supported.)	Available (Both the standard and high-speed 1:N NT Link are supported.)
Recipe function	None	Normal screen: 1 max.; Multiple screens: 8 max.; Window screens: Not possible
Accessible CS/CJ-series data areas	CIO area TIM area (timer PVs) CNT area (counter PVs) DM area EM area (current bank only)	CIO area HR area WR area (work areas) TK area (task flags) TIM area (timer PVs) TU area (timer completion flags) CNT area (counter PVs) CU area (counter completion flags) DM area EM area (current bank, banks 0 to C)

Apart from the above, due to difference between PT models, it may be necessary to modify screen data and programs at the host. For details, refer to the *NT-series Support Tool Version 4 for Windows Operation Manual* (V061-E1-□).





Differences between NT31/NT31C and NT631/NT631C Models without the -V1 Suffix and PT Models with -V1

Item	NT31/NT31C and NT631/NT631C (without -V1)	NT31/NT31C and NT631/NT631C (with V1)																																																																																																																																																																																																										
Drawing order of objects	<table border="1"> <thead> <tr> <th>Display</th> <th>Object Types</th> </tr> </thead> <tbody> <tr> <td style="text-align: center;">Top ↑</td> <td>Image/library lamp Alarm list/history frame Temporary input String input Thumbwheel Numeral input Trend graph Broken line graph Bar graph Numeral display String display Fixed display Lamp Touch switch Image/library data Screen background</td> </tr> <tr> <td style="text-align: center;">↓ Bottom</td> <td></td> </tr> </tbody> </table>	Display	Object Types	Top ↑	Image/library lamp Alarm list/history frame Temporary input String input Thumbwheel Numeral input Trend graph Broken line graph Bar graph Numeral display String display Fixed display Lamp Touch switch Image/library data Screen background	↓ Bottom		<table border="1"> <thead> <tr> <th>Display</th> <th>Object Types</th> </tr> </thead> <tbody> <tr> <td style="text-align: center;">Top ↑</td> <td>Image/library lamp Alarm list/history frame Temporary input String input Thumbwheel Numeral input Trend graph Broken line graph Analogue meter Bar graph Numeral display String display Fixed display Lamp Touch switch Image/library data Screen background</td> </tr> <tr> <td style="text-align: center;">↓ Bottom</td> <td></td> </tr> </tbody> </table>	Display	Object Types	Top ↑	Image/library lamp Alarm list/history frame Temporary input String input Thumbwheel Numeral input Trend graph Broken line graph Analogue meter Bar graph Numeral display String display Fixed display Lamp Touch switch Image/library data Screen background	↓ Bottom																																																																																																																																																																																															
Display	Object Types																																																																																																																																																																																																											
Top ↑	Image/library lamp Alarm list/history frame Temporary input String input Thumbwheel Numeral input Trend graph Broken line graph Bar graph Numeral display String display Fixed display Lamp Touch switch Image/library data Screen background																																																																																																																																																																																																											
↓ Bottom																																																																																																																																																																																																												
Display	Object Types																																																																																																																																																																																																											
Top ↑	Image/library lamp Alarm list/history frame Temporary input String input Thumbwheel Numeral input Trend graph Broken line graph Analogue meter Bar graph Numeral display String display Fixed display Lamp Touch switch Image/library data Screen background																																																																																																																																																																																																											
↓ Bottom																																																																																																																																																																																																												
PT status notify area	<p style="text-align: center;">Bit</p> <table border="1"> <thead> <tr> <th>Word</th> <th>15</th> <th>14</th> <th>13</th> <th>12</th> <th>11</th> <th>10</th> <th>9</th> <th>8</th> <th>7</th> <th>6</th> <th>5</th> <th>4</th> <th>3</th> <th>2</th> <th>1</th> <th>0</th> </tr> </thead> <tbody> <tr> <td>Word m</td> <td colspan="16">Numeral/character string memory table entry No. (BCD or hexadecimal 4 digits)</td> </tr> <tr> <td>Word m+1</td> <td colspan="10">PT status notify bits</td> <td>0</td> <td>0</td> <td>0</td> <td></td> <td></td> <td></td> </tr> </tbody> </table> <p>PT status notify bits</p> <table border="1"> <thead> <tr> <th>Word</th> <th>Notified Information</th> <th>1 (ON)</th> <th>0 (OFF)</th> </tr> </thead> <tbody> <tr> <td>15</td> <td>PT operation status</td> <td>Run</td> <td>Stop</td> </tr> <tr> <td>14</td> <td>Not used</td> <td colspan="2">Always 0</td> </tr> <tr> <td>13</td> <td>Battery</td> <td>Low</td> <td>Normal</td> </tr> <tr> <td>12</td> <td>Screen switch strobe</td> <td>ON</td> <td>OFF</td> </tr> <tr> <td>11</td> <td>Numeral setting strobe</td> <td>ON</td> <td>OFF</td> </tr> <tr> <td>10</td> <td>Character string setting strobe</td> <td>ON</td> <td>OFF</td> </tr> <tr> <td>9</td> <td>Not used</td> <td colspan="2">Always 0</td> </tr> <tr> <td>8</td> <td>Not used</td> <td colspan="2">Always 0</td> </tr> <tr> <td>7</td> <td>Printer operating status</td> <td>Printing</td> <td>Stopped</td> </tr> <tr> <td>6</td> <td>Backlight status</td> <td>OFF</td> <td>Lit/flashing</td> </tr> </tbody> </table>	Word	15	14	13	12	11	10	9	8	7	6	5	4	3	2	1	0	Word m	Numeral/character string memory table entry No. (BCD or hexadecimal 4 digits)																Word m+1	PT status notify bits										0	0	0				Word	Notified Information	1 (ON)	0 (OFF)	15	PT operation status	Run	Stop	14	Not used	Always 0		13	Battery	Low	Normal	12	Screen switch strobe	ON	OFF	11	Numeral setting strobe	ON	OFF	10	Character string setting strobe	ON	OFF	9	Not used	Always 0		8	Not used	Always 0		7	Printer operating status	Printing	Stopped	6	Backlight status	OFF	Lit/flashing	<p style="text-align: center;">Bit</p> <table border="1"> <thead> <tr> <th>Word</th> <th>15</th> <th>14</th> <th>13</th> <th>12</th> <th>11</th> <th>10</th> <th>9</th> <th>8</th> <th>7</th> <th>6</th> <th>5</th> <th>4</th> <th>3</th> <th>2</th> <th>1</th> <th>0</th> </tr> </thead> <tbody> <tr> <td>Word m</td> <td colspan="16">Numeral/character string memory table entry No. (BCD or hexadecimal 4 digits)</td> </tr> <tr> <td>Word m+1</td> <td colspan="10">PT status notify bits</td> <td></td> <td></td> <td>0</td> <td>0</td> <td>0</td> <td></td> </tr> </tbody> </table> <p>PT status notify bits</p> <table border="1"> <thead> <tr> <th>Word</th> <th>Notified Information</th> <th>1 (ON)</th> <th>0 (OFF)</th> </tr> </thead> <tbody> <tr> <td>15</td> <td>PT operation status</td> <td>Run</td> <td>Stop</td> </tr> <tr> <td>14</td> <td>Not used</td> <td colspan="2">Always 0</td> </tr> <tr> <td>13</td> <td>Battery</td> <td>Low</td> <td>Normal</td> </tr> <tr> <td>12</td> <td>Screen switch strobe</td> <td>ON</td> <td>OFF</td> </tr> <tr> <td>11</td> <td>Numeral setting strobe</td> <td>ON</td> <td>OFF</td> </tr> <tr> <td>10</td> <td>Character string setting strobe</td> <td>ON</td> <td>OFF</td> </tr> <tr> <td>9</td> <td>Not used</td> <td colspan="2">Always 0</td> </tr> <tr> <td>8</td> <td>Not used</td> <td colspan="2">Always 0</td> </tr> <tr> <td>7</td> <td>Printer operating status</td> <td>Printing</td> <td>Stopped</td> </tr> <tr> <td>6</td> <td>Backlight status</td> <td>OFF</td> <td>Lit/flashing</td> </tr> <tr> <td>5</td> <td>Global window open status</td> <td>Open</td> <td>Close</td> </tr> <tr> <td>4</td> <td>Local window 1 open status</td> <td>Open</td> <td>Close</td> </tr> <tr> <td>3</td> <td>Local window 2 open status</td> <td>Open</td> <td>Close</td> </tr> </tbody> </table>	Word	15	14	13	12	11	10	9	8	7	6	5	4	3	2	1	0	Word m	Numeral/character string memory table entry No. (BCD or hexadecimal 4 digits)																Word m+1	PT status notify bits												0	0	0		Word	Notified Information	1 (ON)	0 (OFF)	15	PT operation status	Run	Stop	14	Not used	Always 0		13	Battery	Low	Normal	12	Screen switch strobe	ON	OFF	11	Numeral setting strobe	ON	OFF	10	Character string setting strobe	ON	OFF	9	Not used	Always 0		8	Not used	Always 0		7	Printer operating status	Printing	Stopped	6	Backlight status	OFF	Lit/flashing	5	Global window open status	Open	Close	4	Local window 1 open status	Open	Close	3	Local window 2 open status	Open	Close
Word	15	14	13	12	11	10	9	8	7	6	5	4	3	2	1	0																																																																																																																																																																																												
Word m	Numeral/character string memory table entry No. (BCD or hexadecimal 4 digits)																																																																																																																																																																																																											
Word m+1	PT status notify bits										0	0	0																																																																																																																																																																																															
Word	Notified Information	1 (ON)	0 (OFF)																																																																																																																																																																																																									
15	PT operation status	Run	Stop																																																																																																																																																																																																									
14	Not used	Always 0																																																																																																																																																																																																										
13	Battery	Low	Normal																																																																																																																																																																																																									
12	Screen switch strobe	ON	OFF																																																																																																																																																																																																									
11	Numeral setting strobe	ON	OFF																																																																																																																																																																																																									
10	Character string setting strobe	ON	OFF																																																																																																																																																																																																									
9	Not used	Always 0																																																																																																																																																																																																										
8	Not used	Always 0																																																																																																																																																																																																										
7	Printer operating status	Printing	Stopped																																																																																																																																																																																																									
6	Backlight status	OFF	Lit/flashing																																																																																																																																																																																																									
Word	15	14	13	12	11	10	9	8	7	6	5	4	3	2	1	0																																																																																																																																																																																												
Word m	Numeral/character string memory table entry No. (BCD or hexadecimal 4 digits)																																																																																																																																																																																																											
Word m+1	PT status notify bits												0	0	0																																																																																																																																																																																													
Word	Notified Information	1 (ON)	0 (OFF)																																																																																																																																																																																																									
15	PT operation status	Run	Stop																																																																																																																																																																																																									
14	Not used	Always 0																																																																																																																																																																																																										
13	Battery	Low	Normal																																																																																																																																																																																																									
12	Screen switch strobe	ON	OFF																																																																																																																																																																																																									
11	Numeral setting strobe	ON	OFF																																																																																																																																																																																																									
10	Character string setting strobe	ON	OFF																																																																																																																																																																																																									
9	Not used	Always 0																																																																																																																																																																																																										
8	Not used	Always 0																																																																																																																																																																																																										
7	Printer operating status	Printing	Stopped																																																																																																																																																																																																									
6	Backlight status	OFF	Lit/flashing																																																																																																																																																																																																									
5	Global window open status	Open	Close																																																																																																																																																																																																									
4	Local window 1 open status	Open	Close																																																																																																																																																																																																									
3	Local window 2 open status	Open	Close																																																																																																																																																																																																									
Window control area	None	<p style="text-align: center;">Bit</p> <table border="1"> <thead> <tr> <th>Word</th> <th>15</th> <th>14</th> <th>13</th> <th>12</th> <th>11</th> <th>10</th> <th>9</th> <th>8</th> <th>7</th> <th>6</th> <th>5</th> <th>4</th> <th>3</th> <th>2</th> <th>1</th> <th>0</th> </tr> </thead> <tbody> <tr> <td>Word k</td> <td colspan="16">Global window Screen No. (4-digit BCD or hexadecimal)</td> </tr> <tr> <td>Word k+1</td> <td colspan="16">Global window X coordinate (4-digit BCD or hexadecimal)</td> </tr> <tr> <td>Word k+2</td> <td colspan="16">Global window Y coordinate (4-digit BCD or hexadecimal)</td> </tr> <tr> <td>Word k+3</td> <td colspan="16">Local window1 Screen No. (4-digit BCD or hexadecimal)</td> </tr> <tr> <td>Word k+4</td> <td colspan="16">Local window1 X coordinate (4-digit BCD or hexadecimal)</td> </tr> <tr> <td>Word k+5</td> <td colspan="16">Local window1 Y coordinate (4-digit BCD or hexadecimal)</td> </tr> <tr> <td>Word k+6</td> <td colspan="16">Local window2 Screen No. (4-digit BCD or hexadecimal)</td> </tr> <tr> <td>Word k+7</td> <td colspan="16">Local window2 X coordinate (4-digit BCD or hexadecimal)</td> </tr> <tr> <td>Word k+8</td> <td colspan="16">Local window2 Y coordinate (4-digit BCD or hexadecimal)</td> </tr> </tbody> </table>	Word	15	14	13	12	11	10	9	8	7	6	5	4	3	2	1	0	Word k	Global window Screen No. (4-digit BCD or hexadecimal)																Word k+1	Global window X coordinate (4-digit BCD or hexadecimal)																Word k+2	Global window Y coordinate (4-digit BCD or hexadecimal)																Word k+3	Local window1 Screen No. (4-digit BCD or hexadecimal)																Word k+4	Local window1 X coordinate (4-digit BCD or hexadecimal)																Word k+5	Local window1 Y coordinate (4-digit BCD or hexadecimal)																Word k+6	Local window2 Screen No. (4-digit BCD or hexadecimal)																Word k+7	Local window2 X coordinate (4-digit BCD or hexadecimal)																Word k+8	Local window2 Y coordinate (4-digit BCD or hexadecimal)																																															
Word	15	14	13	12	11	10	9	8	7	6	5	4	3	2	1	0																																																																																																																																																																																												
Word k	Global window Screen No. (4-digit BCD or hexadecimal)																																																																																																																																																																																																											
Word k+1	Global window X coordinate (4-digit BCD or hexadecimal)																																																																																																																																																																																																											
Word k+2	Global window Y coordinate (4-digit BCD or hexadecimal)																																																																																																																																																																																																											
Word k+3	Local window1 Screen No. (4-digit BCD or hexadecimal)																																																																																																																																																																																																											
Word k+4	Local window1 X coordinate (4-digit BCD or hexadecimal)																																																																																																																																																																																																											
Word k+5	Local window1 Y coordinate (4-digit BCD or hexadecimal)																																																																																																																																																																																																											
Word k+6	Local window2 Screen No. (4-digit BCD or hexadecimal)																																																																																																																																																																																																											
Word k+7	Local window2 X coordinate (4-digit BCD or hexadecimal)																																																																																																																																																																																																											
Word k+8	Local window2 Y coordinate (4-digit BCD or hexadecimal)																																																																																																																																																																																																											

Item	NT31/NT31C and NT631/NT631C (without -V1)	NT31/NT31C and NT631/NT631C (with V1)
Window	<ul style="list-style-type: none"> • Only 1 window can be displayed • Display elements that can be registered on a window Fixed display Touch switch (Notify bit, cursor move and print screen functions are not available) Numeral/character string input (only 1 of these)	<ul style="list-style-type: none"> • Up to 3 screens can be displayed (1 global window, 2 local windows) • Display elements that can be registered on a window All the display elements other than thumbwheel type numeral input (However, only 1 numeral/character string input (temporary input field) can be displayed)
Pop-up window function touch switch	Only Keyboard screen can be controlled. Window position can not be changed.	Local window1 or local window2 can be controlled. Window position can be changed.
Window move function touch switch	Not available	Available
Analogue meter	Not available	Available
High-definition font display	Not available	Characters of 2 or larger scale is displayed in high-definition font* (excluding marks)
Connection to Mitsubishi PCs	Not possible	Possible
Memory link	Not possible	Possible
Installation of system program using Memory Unit	Not possible (screen data only)	Possible
Programming Console function screen for CS/CJ-series PCs	Not possible	Possible

* Usable only when ISO 8859/1 font type is selected at the Support Tool.

Differences between -V1 and -V2 NT31/NT31C and NT631/NT631C PTs

Item	NT31/NT31C and NT631/NT631C (V1 versions)		NT31/NT31C and NT631/NT631C (V2 versions)	
	Display	Element Type	Display	Element Type
Foreground/background relationships in screen drawing	<p>Foreground</p>   <p>Background</p>	Image/library lamps Alarm list/history frames Temporary input Character string input Thumbwheel type input Numeral input Trend graphs Broken line graphs Analogue meter Frames of bar graphs Numeral displays Character string displays Fixed displays Lamp displays Touch switches Image/library data Screen background	<p>Foreground</p>   <p>Background</p>	Image/library lamps Recipe Alarm list/history frames Temporary input Character string input Thumbwheel type input Numeral input Trend graphs Broken line graphs Analogue meter Frames of bar graphs Numeral displays Character string displays Fixed displays Lamp displays Touch switches Image/library data Screen background
Screen display	0: No display 1 to 3999 : Normal, window, and overlapping screens 9000: System Initializing screen 9001: Display history (occurrence order) screen 9002: Display history (frequency order) screen 9020: Screen for Programming Console function 9999: Return to the previous screen	0: No display 1 to 3999 : Normal, window, and overlapping screens 9000: System Initializing screen 9001: Display history (occurrence order) screen 9002: Display history (frequency order) screen 9020: Screen for programming console function 9021 to 9023: Device Monitor function screens 9030: Brightness and contrast adjustment screen 9999: Return to the previous screen		
Interlock function	Not available	The interlock function can be set for individual touch switches, numeral inputs, thumbwheel inputs, character string inputs, and recipe objects to enable/disable operation according to the status of the interlock bit allocated in the host.		
Labels (Guide characters)	Fixed character strings only (1 line only)	Four kinds of character strings are available: Fixed character strings (Multiple lines are possible.) ON/OFF switching character strings (Multiple lines are possible.) Numeral displays (Displays numeral memory table entries.) Character string displays (Displays character string memory table entries.)		
Device Monitor function	Not available	Can be used to switch the PC's operating mode, display/change contents of PC words, and display the error log.		
Mathematical function	Not available	Can be used to automatically execute up to 256 formulas registered in mathematical table. (Operands (results) are automatically read from (written to) numeral memory table entries or PC words.)		
High-speed 1:N NT Link	Not available (Only the standard 1:N NT Link is supported.)	Available (Both the standard and high-speed 1:N NT Link are supported.)		
Recipe function	Not available	Can be used to read/write several words of data specified using tabular elements on the PT to/from the host.		
Accessible CS/CJ-series data areas	<ul style="list-style-type: none"> • CIO area • TIM area (timer PVs) • CNT area (counter PVs) • DM area • EM area (current bank only) 	<ul style="list-style-type: none"> • CIO area • HR area • WR area (work areas) • TK area (task flags) • TIM area (timer PVs) • TU area (timer completion flags) • CNT area (counter PVs) • CU area (counter completion flags) • DM area • EM area (current bank and banks 0 to C) 		
NT30/620 compatible mode	Not available	Available (Refer to <i>Appendix C</i> for details.)		

Relationship between System Program and Hardware

Here, relationship between system program and hardware is described.

NT21 System Programs

The system program indicated below is installed in the NT21 in the default state. Also, system program is supplied with the Support Tool as follows:

- System programs for NT21-ST121□-E: System Program Version 1.0□
(System programs supplied with NT-ZJCAT1-EV4)

NT31/NT31C System Programs

NT31/NT31C have following models.

NT31-ST121□-E	Conventional product
NT31C-ST141□-E	
NT31-ST121□-EV1	Version upgrade model of the products above
NT31C-ST141□-EV1	
NT31-ST121□-EV2	Version upgrade model of the products above
NT31C-ST141□-EV2	

System programs indicated below are installed for the models shown above in the default state. Also, system programs are supplied with the Support Tool as follows:

- System programs for NT31-ST121□-E/NT31C-ST141□-E: System Program Version 1.0□
(System programs supplied with NT-ZJ3AT1-EV2/ZJCAT1-EV2)
- System programs for NT31-ST121□-EV1/NT31C-ST141□-EV1: System Program Version 2.1□
(System programs supplied with NT-ZJ3AT1-EV3/ZJCAT1-EV3)
- System programs for NT31-ST121□-EV2/NT31C-ST141□-EV2: System Program Version 3.1□
(System programs supplied with NT-ZJCAT1-EV4)

These system programs have mutual compatibility, therefore, they can be installed and used for NT31-ST121□-E/NT31C-ST141□-E/

NT31-ST121□-EV1/NT31C-ST141□-EV1/NT31-ST121□-EV2/NT31C-ST141□-EV2 each.

However, there will be a limitation on function depending on the combination with the NT31/NT31C and NT631/NT631C. Refer to the table on page 455.

NT631/NT631C System Programs

NT631/NT631C have following models.

NT631-ST211□-E	Conventional product
NT631C-ST141□-E	
NT631C-ST151□-E	
NT631-ST211□-EV1	Version upgrade model of the products above
NT631C-ST141□-EV1	
NT631C-ST151□-EV1	
NT631-ST211□-EV2	Version upgrade model of the products above
NT631C-ST141□-EV2	
NT631C-ST151□-EV2	

System programs indicated below are installed for the models shown above in the default state. Also, system programs are supplied with the Support Tool as follows:

- System programs for NT631-ST211□-E/NT631C-ST141□-E/NT631C-ST151□-E:
System Program Version 1.0□ (System programs supplied with NT-ZJ3AT1-EV2/ZJCAT1-EV2)
- System programs for NT631-ST211□-EV1/NT631C-ST141□-EV1/NT631C-ST151□-EV1:
System Program Version 2.1□ (System programs supplied with NT-ZJ3AT1-EV3/ZJCAT1-EV3)

- System programs for NT631-ST211□-EV2/NT631C-ST141□-EV2/NT631C-ST151□-EV2:
System Program Version 3.1□ (System programs supplied with NT-ZJCAT1-EV4)

These system programs have mutual compatibility, therefore, they can be installed and used for the NT631-ST211□-E, NT631C-ST141□-E, NT631C-ST151□-E, NT631-ST211□-EV1, NT631C-ST141□-EV1, NT631C-ST151□-EV1, NT631-ST211□-EV2, NT631C-ST141□-EV2, NT631C-ST151□-EV2.

However, there will be a limitation on function depending on the combination with the NT31/NT31C and NT631/NT631C. Refer to the table on page 455.

Limitations of System Program/PT Combinations for the NT31/NT31C and NT631/NT631C

The following table shows only the relationship between the hardware and system program.

For details of the relationship with the screen data created using the Support Tool, refer to *NT-series Support Tool for Windows (Version 4) Operation Manual (V061-E1-□)*.

Combining a -V1 Version and Version without a -V□ Suffix

Software	Hardware	
	NT31-ST121□-E NT31C-ST141□-E NT631-ST211□-E NT631C-ST141□-E NT631C-ST151□-E	NT31-ST121□-EV1 NT31C-ST141□-EV1 NT631-ST211□-EV1 NT631C-ST141□-EV1 NT631C-ST151□-EV1
System program Version 1.0□	The following functions can not be used <ul style="list-style-type: none"> • Analogue meter • High-definition font display • Installation of system programs using Memory Unit • Connection to Mitsubishi PCs • Memory link • Window control from the host • Multiple display of window screens • Moving a window • Refer to the following table for details on new functions supported by the -V2 versions. 	The following functions can not be used <ul style="list-style-type: none"> • Analogue meter • High-definition font display • Connection to Mitsubishi PCs • Memory link • Window control from the host • Multiple display of window screens • Moving a window • Refer to the following table for details on new functions supported by the -V2 versions. * Installation of system programs using Memory Unit is possible
System program Version 2.1□	The following functions can not be used <ul style="list-style-type: none"> • Installation of system programs using Memory Unit • High-definition font display* • Refer to the following table for details on new functions supported by the -V2 versions. 	The new functions supported by the -V2 versions cannot be used. Refer to the following table for details.

* The system program's version can be checked from the System Menu.

Combining a -V1 Version and -V2 Version

Software	Hardware	
	NT31-ST121□-EV1 NT31C-ST141□-EV1 NT631-ST211□-EV1 NT631C-ST141□-EV1 NT631C-ST151□-EV1	NT31-ST121□-EV2 NT31C-ST141□-EV2 NT631-ST211□-EV2 NT631C-ST141□-EV2 NT631C-ST151□-EV2
System program Version 2.1□	The following functions (new functions supported by the -V2) cannot be used: <ul style="list-style-type: none"> • Additional data areas accessible in CS/CJ-series PCs • The CS/CJ-series high-speed 1:N NT Link • Interlock function that controls touch switches, numeral inputs, character string inputs, and recipe objects • Mathematical function • Device Monitor function • Recipe function • NT30/620 compatible mode • Expanded capabilities for label (guide character) displays, including multiple lines of text, ON/OFF switching displays, numeral memory table displays, and character string memory table entries 	
System program Version 3.1□	All of the functions described in the Setup Manual and Reference Manual can be used.	

* The system program's version can be checked from the System Menu.

Combining a -V2 Version and Version without a -V□ Suffix

Software	Hardware	
	NT31-ST121□-E NT31C-ST141□-E NT631-ST211□-E NT631C-ST141□-E NT631C-ST151□-E	NT31-ST121□-EV2 NT31C-ST141□-EV2 NT631-ST211□-EV2 NT631C-ST141□-EV2 NT631C-ST151□-EV2
System program Version 1.0□	The following functions cannot be used <ul style="list-style-type: none"> Analogue meter High-definition font display Installation of system programs using Memory Unit Connection to Mitsubishi PCs Memory link Window control from the host Multiple display of window screens Moving a window Additional data areas accessible in CS/CJ-series PCs The CS/CJ-series high-speed 1:N NT Link Interlock function that controls touch switches, numeral inputs, character string inputs, and recipe objects Mathematical function Recipe function Device Monitor function NT30/620 compatible mode Expanded capabilities for label (guide character) displays, including multiple lines of text, ON/OFF switching displays, numeral memory table displays, and character string memory table entries 	The following functions cannot be used <ul style="list-style-type: none"> Analogue meter High-definition font display Connection to Mitsubishi PCs Memory link Window control from the host Multiple display of window screens Moving a window Refer to the following table for details on new functions supported by the -V2 versions. Additional data areas accessible in CS/CJ-series PCs The CS/CJ-series high-speed 1:N NT Link Interlock function that controls touch switches, numeral inputs, character string inputs, and recipe objects Mathematical function Recipe function Device Monitor function NT30/620 compatible mode Expanded capabilities for label (guide character) displays, including multiple lines of text, ON/OFF switching displays, numeral memory table displays, and character string memory table entries * Installation of system programs using Memory Unit is possible
System program Version 3.1□	The following functions can not be used <ul style="list-style-type: none"> Installation of system programs using Memory Unit High-definition font display* 	All of the functions described in the Setup Manual and Reference Manual can be used.

* The system program's version can be checked from the System Menu.

Appendix C

NT20S and NT30/620 Compatible Modes

This section describes the NT20S (for the NT21) and NT30/620 (for the NT31/NT31C and NT631/NT631C) compatible modes in detail.

NT20S Compatible Mode (for the NT21)

The NT20S compatible mode is a function that allows screen data and user programs from NT20S to be easily reused in an NT21. Using NT20S compatible mode reduces the differences between the earlier and most recent versions and makes it easy to achieve compatibility.

The NT20S compatible mode has the following features:

- Changes the word configuration of the PT's PT status control area and PT status notify area to match the word configuration of the earlier PTs. This change allows the new PTs to execute user programs from the earlier PTs without any editing.
- When using the Support Tool to convert screen data for an NT21, the default setting is NT20S compatible mode (the setting can be changed in the Support Tool's PT environment settings). The default setting converts screen data with the highest level of compatibility.
- Even though an NT21 PT is operating in NT20S compatible mode, it still retains all of its new functions. The enhanced functions can be applied to screen data converted from the NT20S.

Functional Changes when Using NT20S Compatible Mode

This section describes the changes in PT functions resulting from the NT20S compatible mode.

-
- Reference:**
- Except for the differences described below, the NT21 retains all of its new functions.
 - The NT20S compatible mode is used by default when screen data from an earlier PT is converted for use in an NT21. If you do not want to use NT20S compatible mode, remove the check mark in the Support Tool's menu [PT Configuration]–[PT Type]–[NT20/30/620 Compatible Mode].
-

Item	NT20S compatible mode used	NT20S compatible mode not used																																																																																																																																								
PT status control area	<p>Word configuration</p> <p>Word n is used to specify the screen switch setting only.</p> <p>PT status control bits</p> <table border="1"> <thead> <tr> <th>Word</th> <th>Controlled Item</th> <th>1 (ON)</th> <th>0 (OFF)</th> </tr> </thead> <tbody> <tr><td>15</td><td>Screen display</td><td>Performed</td><td>Not performed</td></tr> <tr><td>14</td><td>Processing priority registration</td><td>Registered</td><td>Canceled</td></tr> <tr><td>13</td><td>Continuous buzzer</td><td>Sounded</td><td>Stopped</td></tr> <tr><td>12</td><td>Intermittent buzzer (short)</td><td>Sounded</td><td>Stopped</td></tr> <tr><td>11</td><td>Display history initialization</td><td>Performed</td><td>Not performed</td></tr> <tr><td>10</td><td>Not used</td><td colspan="2">Always 0</td></tr> <tr><td>9</td><td>Intermittent buzzer (long)</td><td>Sounded</td><td>Stopped</td></tr> <tr><td>8</td><td>Backlight mode</td><td>Lit</td><td>Flashing</td></tr> <tr><td>7</td><td>Not used</td><td colspan="2">Always 0</td></tr> <tr><td>6</td><td>PT window opening</td><td>Disabled</td><td>Enabled</td></tr> <tr><td>5</td><td>Numeral/character string input</td><td>Disabled</td><td>Enabled</td></tr> <tr><td>4</td><td>PT screen switching</td><td>Disabled</td><td>Enabled</td></tr> <tr><td>3</td><td>Not used*2</td><td colspan="2">Always 0</td></tr> <tr><td>2</td><td>Not used*2</td><td colspan="2">Always 0</td></tr> <tr><td>1</td><td>Alarm history initialization</td><td>Performed</td><td>Not performed</td></tr> <tr><td>0</td><td>Not used</td><td colspan="2">Always 0</td></tr> </tbody> </table> <p>*1: Both the display history and alarm history are initialized when bit 11 is turned ON. *2: Bits 2 and 3 are not used in NT20S compatible mode.</p>	Word	Controlled Item	1 (ON)	0 (OFF)	15	Screen display	Performed	Not performed	14	Processing priority registration	Registered	Canceled	13	Continuous buzzer	Sounded	Stopped	12	Intermittent buzzer (short)	Sounded	Stopped	11	Display history initialization	Performed	Not performed	10	Not used	Always 0		9	Intermittent buzzer (long)	Sounded	Stopped	8	Backlight mode	Lit	Flashing	7	Not used	Always 0		6	PT window opening	Disabled	Enabled	5	Numeral/character string input	Disabled	Enabled	4	PT screen switching	Disabled	Enabled	3	Not used*2	Always 0		2	Not used*2	Always 0		1	Alarm history initialization	Performed	Not performed	0	Not used	Always 0		<p>Word configuration</p> <p>Word n is used to specify the screen switch setting and notify screen number.</p> <p>PT status control bits</p> <table border="1"> <thead> <tr> <th>Word</th> <th>Controlled Item</th> <th>1 (ON)</th> <th>0 (OFF)</th> </tr> </thead> <tbody> <tr><td>15</td><td>Screen display</td><td>Performed</td><td>Not performed</td></tr> <tr><td>14</td><td>Processing priority registration</td><td>Registered</td><td>Canceled</td></tr> <tr><td>13</td><td>Continuous buzzer</td><td>Sounded</td><td>Stopped</td></tr> <tr><td>12</td><td>Intermittent buzzer (short)</td><td>Sounded</td><td>Stopped</td></tr> <tr><td>11</td><td>Display history initialization</td><td>Performed</td><td>Not performed</td></tr> <tr><td>10</td><td>Not used</td><td colspan="2">Always 0</td></tr> <tr><td>9</td><td>Intermittent buzzer (long)</td><td>Sounded</td><td>Stopped</td></tr> <tr><td>8</td><td>Backlight mode</td><td>Lit</td><td>Flashing</td></tr> <tr><td>7</td><td>Not used</td><td colspan="2">Always 0</td></tr> <tr><td>6</td><td>PT window opening</td><td>Disabled</td><td>Enabled</td></tr> <tr><td>5</td><td>Numeral/character string input</td><td>Disabled</td><td>Enabled</td></tr> <tr><td>4</td><td>PT screen switching</td><td>Disabled</td><td>Enabled</td></tr> <tr><td>3</td><td>Memory table copy execution</td><td>Performed</td><td>Not performed</td></tr> <tr><td>2</td><td>Memory table copy type</td><td>Numeral</td><td>Character string</td></tr> <tr><td>1</td><td>Alarm history initialization</td><td>Performed</td><td>Not performed</td></tr> <tr><td>0</td><td>Not used</td><td colspan="2">Always 0</td></tr> </tbody> </table> <p>Reflected in bit unit</p>	Word	Controlled Item	1 (ON)	0 (OFF)	15	Screen display	Performed	Not performed	14	Processing priority registration	Registered	Canceled	13	Continuous buzzer	Sounded	Stopped	12	Intermittent buzzer (short)	Sounded	Stopped	11	Display history initialization	Performed	Not performed	10	Not used	Always 0		9	Intermittent buzzer (long)	Sounded	Stopped	8	Backlight mode	Lit	Flashing	7	Not used	Always 0		6	PT window opening	Disabled	Enabled	5	Numeral/character string input	Disabled	Enabled	4	PT screen switching	Disabled	Enabled	3	Memory table copy execution	Performed	Not performed	2	Memory table copy type	Numeral	Character string	1	Alarm history initialization	Performed	Not performed	0	Not used	Always 0	
Word	Controlled Item	1 (ON)	0 (OFF)																																																																																																																																							
15	Screen display	Performed	Not performed																																																																																																																																							
14	Processing priority registration	Registered	Canceled																																																																																																																																							
13	Continuous buzzer	Sounded	Stopped																																																																																																																																							
12	Intermittent buzzer (short)	Sounded	Stopped																																																																																																																																							
11	Display history initialization	Performed	Not performed																																																																																																																																							
10	Not used	Always 0																																																																																																																																								
9	Intermittent buzzer (long)	Sounded	Stopped																																																																																																																																							
8	Backlight mode	Lit	Flashing																																																																																																																																							
7	Not used	Always 0																																																																																																																																								
6	PT window opening	Disabled	Enabled																																																																																																																																							
5	Numeral/character string input	Disabled	Enabled																																																																																																																																							
4	PT screen switching	Disabled	Enabled																																																																																																																																							
3	Not used*2	Always 0																																																																																																																																								
2	Not used*2	Always 0																																																																																																																																								
1	Alarm history initialization	Performed	Not performed																																																																																																																																							
0	Not used	Always 0																																																																																																																																								
Word	Controlled Item	1 (ON)	0 (OFF)																																																																																																																																							
15	Screen display	Performed	Not performed																																																																																																																																							
14	Processing priority registration	Registered	Canceled																																																																																																																																							
13	Continuous buzzer	Sounded	Stopped																																																																																																																																							
12	Intermittent buzzer (short)	Sounded	Stopped																																																																																																																																							
11	Display history initialization	Performed	Not performed																																																																																																																																							
10	Not used	Always 0																																																																																																																																								
9	Intermittent buzzer (long)	Sounded	Stopped																																																																																																																																							
8	Backlight mode	Lit	Flashing																																																																																																																																							
7	Not used	Always 0																																																																																																																																								
6	PT window opening	Disabled	Enabled																																																																																																																																							
5	Numeral/character string input	Disabled	Enabled																																																																																																																																							
4	PT screen switching	Disabled	Enabled																																																																																																																																							
3	Memory table copy execution	Performed	Not performed																																																																																																																																							
2	Memory table copy type	Numeral	Character string																																																																																																																																							
1	Alarm history initialization	Performed	Not performed																																																																																																																																							
0	Not used	Always 0																																																																																																																																								
PT status notify area	<p>Word configuration</p> <p>Word m is used for screen number notification. (The function of the PT status notify bits does not change.)</p>	<p>Word configuration</p> <p>Screen number notification occurs in word n of the PT status control area. (The function of the PT status notify bits does not change.)</p>																																																																																																																																								
Image codes	FE20 to FEFF hexadecimal, 224 codes max.	0001 to 0FFF hexadecimal, 4,095 codes max.																																																																																																																																								
Library codes	FA20 to FAFF, FB20 to FBFF, FC20 to FCFF, and FD20 to FDFF hexadecimal, 896 codes max.	1000 to 3FFF hexadecimal, 12,288 codes max.																																																																																																																																								
Insertion of codes in strings	Image and library codes can be inserted in character strings.	Image and library codes cannot be inserted in character strings.																																																																																																																																								

-
- Reference:**
- When a PT is in NT20S compatible mode, the method used to copy memory table entries is the same as the method in earlier PTs. Since the configuration of the PT status control area is also the same, only 3-digit memory table entry numbers can be specified for copying. (Bits 12 to 15 are used for other purposes.)
The copy operation is executed immediately when a memory table entry number is written to the PT status control area, so it is safest to write the destination memory table entry number before writing the source memory table entry number to avoid accidentally writing to the wrong destination.
 - The composition and function of the PT status control bits have not been changed to match those of the earlier PTs because they are needed in order to use the new functions in the NT21.
 - Only the functions listed in the table above are changed in NT20S compatible mode. Other parts of the screen data and user program may need to be changed to be compatible with the earlier PTs. Refer to the following section (Differences between Earlier PTs and PTs in NT20S compatible Mode) for details.
-

Differences between Earlier PTs and PTs in NT20S Compatible Mode

PTs using the NT20S compatible mode are highly compatible with the NT20S, but some editing is required due to differences such as changes in hardware.

The remaining differences are listed below. The following differences are related to reuse of screen data and the user program only. The added capabilities of the NT21 are not listed.

For details on added capabilities, refer to *Differences between the NT20S and the NT21* on page 442.

- Foreground/background relationships in screen drawing
- Continuous screens (Screen switching must be performed with touch switches.)
- System keypad (Must be registered using symbol manager in the Support Tool.)
- Control codes in character strings (Control codes 00 and 0A must be edited out.)
- Guide characters (labels) protruding from touch switches (The position and color of guide characters must be edited.)
- Overlapping of fixed displays and touch switches/lamps (Colors must be edited.)

Be sure to edit the screen data and user program to correct the problems listed above when reusing screen data and user programs from earlier PTs.

Reference: Appendix A of the Support Tool's operation manual describes the editing that may be required when converting data. The following items may need to be edited. Refer to the Support Tool's operation manual as necessary.

- Editing Related to Continuous Screens
 - Editing Related to the System Keypad
 - Editing Related to Guide Characters of Lamps (Lit Color)
 - Editing Related to the Touch Switches to Control Trend Graphs
-

NT30/620 Compatible Mode (for the NT31/NT31C and NT631/NT631C)

The NT30/620 compatible mode is a function that allows screen data and user programs from an earlier PT (NT30, NT30C, NT620S, NT620C, or NT625C) to be easily reused in an NT31, NT31C, NT631, or NT631C. Using NT30/620 compatible mode reduces the differences between the earlier and most recent versions and makes it easy to achieve compatibility.

The NT30/620 compatible mode has the following features:

- Changes the word configuration of the PT's PT status control area and PT status notify area to match the word configuration of the earlier PTs. This change allows the new PTs to execute user programs from the earlier PTs without any editing.
- The image and library codes are changed to match those of earlier PTs, so it isn't necessary to edit any of these codes that are specified in the user program. Furthermore, display elements that have image and library codes incorporated into character strings can be used without any editing.
- When using the Support Tool to convert screen data from an earlier PT for use in a -V2 version of an NT31, NT31C, NT631, or NT631C, the default setting is NT30/620 compatible mode (the setting can be changed in the Support Tool's PT environment settings). The default setting converts screen data with the highest level of compatibility.
- Even though a newer NT31, NT31C, NT631, or NT631C is operating in NT30/620 compatible mode, it still retains all of its new functions. The enhanced functions can be applied to screen data converted from an earlier PT.

Functional Changes when Using NT30/620 Compatible Mode

This section describes the changes in PT functions resulting from the NT30/620 compatible mode.

-
- Reference:**
- Except for the differences described below, the -V2 versions of the NT31, NT31C, NT631, and NT631C retain all of their new functions.
 - The NT30/620 compatible mode is used by default when screen data from an earlier PT is converted for use in a -V2 version of an NT31, NT31C, NT631, or NT631C. If you do not want to use NT30/620 compatible mode, remove the check mark in the Support Tool's menu [PT Configuration]–[PT Type]–[NT20/30/620 Compatible Mode].
-

Item	NT30/620 compatible mode used	NT30/620 compatible mode not used																																																																																																																																																																																																																																																																																																																																			
PT status control area	<p>Word configuration</p> <p style="text-align: center;">Bit</p> <table border="1" style="width: 100%; border-collapse: collapse;"> <tr> <td style="width: 5%;">Word</td> <td style="width: 15%;">15</td><td>14</td><td>13</td><td>12</td><td>11</td><td>10</td><td>9</td><td>8</td><td>7</td><td>6</td><td>5</td><td>4</td><td>3</td><td>2</td><td>1</td><td>0</td> </tr> <tr> <td>Word n</td> <td colspan="16" style="text-align: center;">Screen number (4 BCD digits)</td> </tr> <tr> <td>Word n+1</td> <td colspan="2" style="text-align: center;">0</td> <td colspan="14" style="text-align: center;">Copy source memory table entry No. (3 BCD digits)</td> </tr> <tr> <td>Word n+2</td> <td colspan="2" style="text-align: center;">Copy type</td> <td colspan="14" style="text-align: center;">Copy destination memory table entry No. (3 BCD digits)</td> </tr> <tr> <td>Word n+3</td> <td colspan="16" style="text-align: center;">PT status control bits</td> </tr> </table> <p>Word n is used to specify the screen switch setting only.</p> <p>PT status control bits</p> <table border="1" style="width: 100%; border-collapse: collapse;"> <thead> <tr> <th>Word</th> <th>Controlled Item</th> <th>1 (ON)</th> <th>0 (OFF)</th> </tr> </thead> <tbody> <tr><td>15</td><td>Screen display</td><td>Performed</td><td>Not performed</td></tr> <tr><td>14</td><td>Processing priority registration</td><td>Registered</td><td>Canceled</td></tr> <tr><td>13</td><td>Continuous buzzer</td><td>Sounded</td><td>Stopped</td></tr> <tr><td>12</td><td>Intermittent buzzer (short)</td><td>Sounded</td><td>Stopped</td></tr> <tr><td>11</td><td>Display history initialization</td><td>Performed</td><td>Not performed</td></tr> <tr><td>10</td><td>Not used</td><td colspan="2" style="text-align: center;">Always 0</td></tr> <tr><td>9</td><td>Intermittent buzzer (long)</td><td>Sounded</td><td>Stopped</td></tr> <tr><td>8</td><td>Backlight mode</td><td>Lit</td><td>Flashing</td></tr> <tr><td>7</td><td>Screen printing</td><td>Performed</td><td>Not performed</td></tr> <tr><td>6</td><td>PT window opening</td><td>Disabled</td><td>Enabled</td></tr> <tr><td>5</td><td>Numeral/character string input</td><td>Disabled</td><td>Enabled</td></tr> <tr><td>4</td><td>PT screen switching</td><td>Disabled</td><td>Enabled</td></tr> <tr><td>3</td><td>Not used*²</td><td colspan="2" style="text-align: center;">Always 0</td></tr> <tr><td>2</td><td>Not used*²</td><td colspan="2" style="text-align: center;">Always 0</td></tr> <tr><td>1</td><td>Alarm history initialization</td><td>Performed</td><td>Not performed</td></tr> <tr><td>0</td><td>Not used</td><td colspan="2" style="text-align: center;">Always 0</td></tr> </tbody> </table> <p>*1: Both the display history and alarm history are initialized when bit 11 is turned ON. *2: Bits 2 and 3 are not used in NT30/620 compatible mode.</p>	Word	15	14	13	12	11	10	9	8	7	6	5	4	3	2	1	0	Word n	Screen number (4 BCD digits)																Word n+1	0		Copy source memory table entry No. (3 BCD digits)														Word n+2	Copy type		Copy destination memory table entry No. (3 BCD digits)														Word n+3	PT status control bits																Word	Controlled Item	1 (ON)	0 (OFF)	15	Screen display	Performed	Not performed	14	Processing priority registration	Registered	Canceled	13	Continuous buzzer	Sounded	Stopped	12	Intermittent buzzer (short)	Sounded	Stopped	11	Display history initialization	Performed	Not performed	10	Not used	Always 0		9	Intermittent buzzer (long)	Sounded	Stopped	8	Backlight mode	Lit	Flashing	7	Screen printing	Performed	Not performed	6	PT window opening	Disabled	Enabled	5	Numeral/character string input	Disabled	Enabled	4	PT screen switching	Disabled	Enabled	3	Not used* ²	Always 0		2	Not used* ²	Always 0		1	Alarm history initialization	Performed	Not performed	0	Not used	Always 0		<p>Word configuration</p> <p style="text-align: center;">Bit</p> <table border="1" style="width: 100%; border-collapse: collapse;"> <tr> <td style="width: 5%;">Word</td> <td style="width: 15%;">15</td><td>14</td><td>13</td><td>12</td><td>11</td><td>10</td><td>9</td><td>8</td><td>7</td><td>6</td><td>5</td><td>4</td><td>3</td><td>2</td><td>1</td><td>0</td> </tr> <tr> <td>Word n</td> <td colspan="16" style="text-align: center;">Screen number (4 BCD or hexadecimal digits)</td> </tr> <tr> <td>Word n+1</td> <td colspan="16" style="text-align: center;">Copy source memory table entry No. (4 BCD or hexadecimal digits)</td> </tr> <tr> <td>Word n+2</td> <td colspan="16" style="text-align: center;">Copy destination memory table entry No. (4 BCD or hexadecimal digits)</td> </tr> <tr> <td>Word n+3</td> <td colspan="16" style="text-align: center;">PT status control bits</td> </tr> <tr> <td>Word n+4</td> <td colspan="16" style="text-align: center;">Reserved for system use</td> </tr> </table> <p>Word n is used to specify the screen switch setting and notify screen number</p> <p>PT status control bits</p> <table border="1" style="width: 100%; border-collapse: collapse;"> <thead> <tr> <th>Word</th> <th>Controlled Item</th> <th>1 (ON)</th> <th>0 (OFF)</th> </tr> </thead> <tbody> <tr><td>15</td><td>Screen display</td><td>Performed</td><td>Not performed</td></tr> <tr><td>14</td><td>Processing priority registration</td><td>Registered</td><td>Canceled</td></tr> <tr><td>13</td><td>Continuous buzzer</td><td>Sounded</td><td>Stopped</td></tr> <tr><td>12</td><td>Intermittent buzzer (short)</td><td>Sounded</td><td>Stopped</td></tr> <tr><td>11</td><td>Display history initialization</td><td>Performed</td><td>Not performed</td></tr> <tr><td>10</td><td>Not used</td><td colspan="2" style="text-align: center;">Always 0</td></tr> <tr><td>9</td><td>Intermittent buzzer (long)</td><td>Sounded</td><td>Stopped</td></tr> <tr><td>8</td><td>Backlight mode</td><td>Lit</td><td>Flashing</td></tr> <tr><td>7</td><td>Screen printing</td><td>Performed</td><td>Not performed</td></tr> <tr><td>6</td><td>PT window opening</td><td>Disabled</td><td>Enabled</td></tr> <tr><td>5</td><td>Numeral/character string input</td><td>Disabled</td><td>Enabled</td></tr> <tr><td>4</td><td>PT screen switching</td><td>Disabled</td><td>Enabled</td></tr> <tr><td>3</td><td>Memory table copy execution</td><td>Performed</td><td>Not performed</td></tr> <tr><td>2</td><td>Memory table copy type</td><td>Numeral</td><td>Character string</td></tr> <tr><td>1</td><td>Alarm history initialization</td><td>Performed</td><td>Not performed</td></tr> <tr><td>0</td><td>Not used</td><td colspan="2" style="text-align: center;">Always 0</td></tr> </tbody> </table> <p>Reflected in bit unit</p>	Word	15	14	13	12	11	10	9	8	7	6	5	4	3	2	1	0	Word n	Screen number (4 BCD or hexadecimal digits)																Word n+1	Copy source memory table entry No. (4 BCD or hexadecimal digits)																Word n+2	Copy destination memory table entry No. (4 BCD or hexadecimal digits)																Word n+3	PT status control bits																Word n+4	Reserved for system use																Word	Controlled Item	1 (ON)	0 (OFF)	15	Screen display	Performed	Not performed	14	Processing priority registration	Registered	Canceled	13	Continuous buzzer	Sounded	Stopped	12	Intermittent buzzer (short)	Sounded	Stopped	11	Display history initialization	Performed	Not performed	10	Not used	Always 0		9	Intermittent buzzer (long)	Sounded	Stopped	8	Backlight mode	Lit	Flashing	7	Screen printing	Performed	Not performed	6	PT window opening	Disabled	Enabled	5	Numeral/character string input	Disabled	Enabled	4	PT screen switching	Disabled	Enabled	3	Memory table copy execution	Performed	Not performed	2	Memory table copy type	Numeral	Character string	1	Alarm history initialization	Performed	Not performed	0	Not used	Always 0	
Word	15	14	13	12	11	10	9	8	7	6	5	4	3	2	1	0																																																																																																																																																																																																																																																																																																																					
Word n	Screen number (4 BCD digits)																																																																																																																																																																																																																																																																																																																																				
Word n+1	0		Copy source memory table entry No. (3 BCD digits)																																																																																																																																																																																																																																																																																																																																		
Word n+2	Copy type		Copy destination memory table entry No. (3 BCD digits)																																																																																																																																																																																																																																																																																																																																		
Word n+3	PT status control bits																																																																																																																																																																																																																																																																																																																																				
Word	Controlled Item	1 (ON)	0 (OFF)																																																																																																																																																																																																																																																																																																																																		
15	Screen display	Performed	Not performed																																																																																																																																																																																																																																																																																																																																		
14	Processing priority registration	Registered	Canceled																																																																																																																																																																																																																																																																																																																																		
13	Continuous buzzer	Sounded	Stopped																																																																																																																																																																																																																																																																																																																																		
12	Intermittent buzzer (short)	Sounded	Stopped																																																																																																																																																																																																																																																																																																																																		
11	Display history initialization	Performed	Not performed																																																																																																																																																																																																																																																																																																																																		
10	Not used	Always 0																																																																																																																																																																																																																																																																																																																																			
9	Intermittent buzzer (long)	Sounded	Stopped																																																																																																																																																																																																																																																																																																																																		
8	Backlight mode	Lit	Flashing																																																																																																																																																																																																																																																																																																																																		
7	Screen printing	Performed	Not performed																																																																																																																																																																																																																																																																																																																																		
6	PT window opening	Disabled	Enabled																																																																																																																																																																																																																																																																																																																																		
5	Numeral/character string input	Disabled	Enabled																																																																																																																																																																																																																																																																																																																																		
4	PT screen switching	Disabled	Enabled																																																																																																																																																																																																																																																																																																																																		
3	Not used* ²	Always 0																																																																																																																																																																																																																																																																																																																																			
2	Not used* ²	Always 0																																																																																																																																																																																																																																																																																																																																			
1	Alarm history initialization	Performed	Not performed																																																																																																																																																																																																																																																																																																																																		
0	Not used	Always 0																																																																																																																																																																																																																																																																																																																																			
Word	15	14	13	12	11	10	9	8	7	6	5	4	3	2	1	0																																																																																																																																																																																																																																																																																																																					
Word n	Screen number (4 BCD or hexadecimal digits)																																																																																																																																																																																																																																																																																																																																				
Word n+1	Copy source memory table entry No. (4 BCD or hexadecimal digits)																																																																																																																																																																																																																																																																																																																																				
Word n+2	Copy destination memory table entry No. (4 BCD or hexadecimal digits)																																																																																																																																																																																																																																																																																																																																				
Word n+3	PT status control bits																																																																																																																																																																																																																																																																																																																																				
Word n+4	Reserved for system use																																																																																																																																																																																																																																																																																																																																				
Word	Controlled Item	1 (ON)	0 (OFF)																																																																																																																																																																																																																																																																																																																																		
15	Screen display	Performed	Not performed																																																																																																																																																																																																																																																																																																																																		
14	Processing priority registration	Registered	Canceled																																																																																																																																																																																																																																																																																																																																		
13	Continuous buzzer	Sounded	Stopped																																																																																																																																																																																																																																																																																																																																		
12	Intermittent buzzer (short)	Sounded	Stopped																																																																																																																																																																																																																																																																																																																																		
11	Display history initialization	Performed	Not performed																																																																																																																																																																																																																																																																																																																																		
10	Not used	Always 0																																																																																																																																																																																																																																																																																																																																			
9	Intermittent buzzer (long)	Sounded	Stopped																																																																																																																																																																																																																																																																																																																																		
8	Backlight mode	Lit	Flashing																																																																																																																																																																																																																																																																																																																																		
7	Screen printing	Performed	Not performed																																																																																																																																																																																																																																																																																																																																		
6	PT window opening	Disabled	Enabled																																																																																																																																																																																																																																																																																																																																		
5	Numeral/character string input	Disabled	Enabled																																																																																																																																																																																																																																																																																																																																		
4	PT screen switching	Disabled	Enabled																																																																																																																																																																																																																																																																																																																																		
3	Memory table copy execution	Performed	Not performed																																																																																																																																																																																																																																																																																																																																		
2	Memory table copy type	Numeral	Character string																																																																																																																																																																																																																																																																																																																																		
1	Alarm history initialization	Performed	Not performed																																																																																																																																																																																																																																																																																																																																		
0	Not used	Always 0																																																																																																																																																																																																																																																																																																																																			
PT status notify area	<p>Word configuration</p> <p style="text-align: center;">Bit</p> <table border="1" style="width: 100%; border-collapse: collapse;"> <tr> <td style="width: 5%;">Word</td> <td style="width: 15%;">15</td><td>14</td><td>13</td><td>12</td><td>11</td><td>10</td><td>9</td><td>8</td><td>7</td><td>6</td><td>5</td><td>4</td><td>3</td><td>2</td><td>1</td><td>0</td> </tr> <tr> <td>Word m</td> <td colspan="16" style="text-align: center;">Screen number (4 BCD digits)</td> </tr> <tr> <td>Word m+1</td> <td colspan="16" style="text-align: center;">Numeral/character string memory table entry No. (4 BCD digits)</td> </tr> <tr> <td>Word m+2</td> <td colspan="14" style="text-align: center;">PT status notify bits</td> <td style="text-align: center;">0</td> <td style="text-align: center;">0</td> <td style="text-align: center;">0</td> </tr> </table> <p>Word m is used for screen number notification. (The function of the PT status notify bits does not change.)</p>	Word	15	14	13	12	11	10	9	8	7	6	5	4	3	2	1	0	Word m	Screen number (4 BCD digits)																Word m+1	Numeral/character string memory table entry No. (4 BCD digits)																Word m+2	PT status notify bits														0	0	0	<p>Word configuration</p> <p style="text-align: center;">Bit</p> <table border="1" style="width: 100%; border-collapse: collapse;"> <tr> <td style="width: 5%;">Word</td> <td style="width: 15%;">15</td><td>14</td><td>13</td><td>12</td><td>11</td><td>10</td><td>9</td><td>8</td><td>7</td><td>6</td><td>5</td><td>4</td><td>3</td><td>2</td><td>1</td><td>0</td> </tr> <tr> <td>Word m</td> <td colspan="16" style="text-align: center;">Numeral/character string memory table entry No. (BCD or hexadecimal 4 digits)</td> </tr> <tr> <td>Word m+1</td> <td colspan="14" style="text-align: center;">PT status notify bits</td> <td style="text-align: center;">0</td> <td style="text-align: center;">0</td> <td style="text-align: center;">0</td> </tr> </table> <p>Screen number notification occurs in word n of the PT status control area. (The function of the PT status notify bits does not change.)</p>	Word	15	14	13	12	11	10	9	8	7	6	5	4	3	2	1	0	Word m	Numeral/character string memory table entry No. (BCD or hexadecimal 4 digits)																Word m+1	PT status notify bits														0	0	0																																																																																																																																																																																																										
Word	15	14	13	12	11	10	9	8	7	6	5	4	3	2	1	0																																																																																																																																																																																																																																																																																																																					
Word m	Screen number (4 BCD digits)																																																																																																																																																																																																																																																																																																																																				
Word m+1	Numeral/character string memory table entry No. (4 BCD digits)																																																																																																																																																																																																																																																																																																																																				
Word m+2	PT status notify bits														0	0	0																																																																																																																																																																																																																																																																																																																				
Word	15	14	13	12	11	10	9	8	7	6	5	4	3	2	1	0																																																																																																																																																																																																																																																																																																																					
Word m	Numeral/character string memory table entry No. (BCD or hexadecimal 4 digits)																																																																																																																																																																																																																																																																																																																																				
Word m+1	PT status notify bits														0	0	0																																																																																																																																																																																																																																																																																																																				
Image codes	FE20 to FEFF hexadecimal, 224 codes max.	0001 to 0FFF hexadecimal, 4,095 codes max.																																																																																																																																																																																																																																																																																																																																			
Library codes	FA20 to FAFF, FB20 to FBFF, FC20 to FCFF, and FD20 to FDFF hexadecimal, 896 codes max.	1000 to 3FFF hexadecimal, 12,288 codes max.																																																																																																																																																																																																																																																																																																																																			
Insertion of codes in strings	Image and library codes can be inserted in character strings.	Image and library codes cannot be inserted in character strings.																																																																																																																																																																																																																																																																																																																																			
Scrolling alarm list and history	The size and color from the earlier PTs can be used as-is. (Editing is not possible.)	The size and color are changed to NT31/NT31C or NT631/NT631C defaults. (Editing is not possible.)																																																																																																																																																																																																																																																																																																																																			

- Reference:**
- When a PT is in NT30/620 compatible mode, the method used to copy memory table entries is the same as the method in earlier PTs. Since the configuration of the PT status control area is also the same, only 3-digit memory table entry numbers can be specified for copying. (Bits 12 to 15 are used for other purposes.)
The copy operation is executed immediately when a memory table entry number is written to the PT status control area, so it is safest to write the destination memory table entry number before writing the source memory table entry number to avoid accidentally writing to the wrong destination.
 - The composition and function of the PT status control bits have not been changed to match those of the earlier PTs because they are needed in order to use the new functions in the NT31, NT31C, NT631, and NT631C.
 - Only the functions listed in the table above are changed in NT30/620 compatible mode. Other parts of the screen data and user program may need to be changed to be compatible with the earlier PTs. Refer to the following section (*Differences between Earlier PTs and PTs in NT30/620 compatible Mode*) for details.

Differences between Earlier PTs and PTs in NT30/620 Compatible Mode

PTs using the NT30/620 compatible mode are highly compatible with earlier PTs (NT30, NT30C, NT620S, NT620C, and NT625C), but some editing is required due to differences such as changes in hardware.

The remaining differences are listed below. The following differences are related to reuse of screen data and the user program only. The added capabilities of the NT31, NT31C, NT631, and NT631C are not listed.

For details on added capabilities, refer to *Differences between the NT30/NT30C and the NT31/NT31C and Differences between the NT620S/NT620C/NT625C and the NT631/NT631C* on page 446.

- Foreground/background relationships in screen drawing
- Screen displays (In particular, it is necessary to correct the screen numbers of the display history screens.)
- Continuous screens (Screen switching must be performed with touch switches.)
- System keypad (Must be registered using symbol manager in the Support Tool.)
- Control codes in character strings (Control codes 00 and 0A must be edited out.)
- Bit memory table entry settings (Correction of the screen switching function is required.)
- Guide characters (labels) protruding from touch switches (The position and color of guide characters must be edited.)
- Overlapping of fixed displays and touch switches/lamps (Colors must be edited.)

Be sure to edit the screen data and user program to correct the problems listed above when reusing screen data and user programs from earlier PTs.

Reference: Appendix A of the Support Tool's operation manual describes the editing that may be required when converting data. The following items may need to be edited. Refer to the Support Tool's operation manual as necessary.

- Editing Related to Continuous Screens
 - Editing Related to Overlapping Screens
 - Editing Related to the Display Ranges of Window/Keyboard Screens
 - Editing Related to the System Initializing screen (screen displayed while connected to the host)
 - Editing Related to History Screens
 - Editing Related to the Contents of the Bit Memory Table
 - Editing Related to the Expansion I/O Table
 - Editing Related to the System Keypad
 - Editing Related to Guide Characters of Lamps (Lit Color)
 - Editing Related to the Numeral Input Reference Memory Table
 - Editing Related to the Sampling Frequency for Trend Graphs
-

Appendix D

PC Memory Maps

OMRON C-series PC, SRM1 Memory Map

Host Links, 1:1 NT Links, and 1:N NT Links

PC	Internal Relay Area (IR)	Holding Relay Area (HR)	Auxiliary Relay Area (AR)	Link Relay Area (LR)	Timer/Counter Present Values (TIM/CNT)	Data Memory Area (DM)	Extended Data Memory Area (Current Bank) (EM)
C200HS	00000 to 00511	00000 to 00099	00000 to 00027	00000 to 00063	00000 to 00511	00000 to 06655 07000 to 09999	-
C200HE(-Z)E C200HG(-Z)E C200HX(-Z)E							00000 to 06143*2
C500							-
C1000H*1	00000 to 00255	00000 to 00099	00000 to 00027	00000 to 00063	00000 to 00511	00000 to 04095 00000 to 06655 00000 to 06655*2	-
C2000H*1 CQM1							-
CQM1H							00000 to 06143*2
CPM1/CPM1A	00000 to 00019 00200 to 00255	00000 to 00019	00000 to 00015	00000 to 00015	00000 to 00127	00000 to 01023 06144 to 06655	-
CPM2A/CPM2C			00000 to 00023				00000 to 00255
C1000HF*1	00000 to 00255	00000 to 00099	00000 to 00027	00000 to 00063	00000 to 00511	00000 to 04095	-
SRM1	00000 to 00019 00200 to 00255	00000 to 00019	00000 to 00015	00000 to 00015	00000 to 00127	00000 to 02021 06144 to 06655	-

*1: The C1000H(F) and C2000H are not supported by the NT21.

*2: The usable ranges of the DM and EM Areas depend upon the model of CPU Unit being used.

OMRON CVM1 and CV-series PC Memory Map

Host Links

Area	Core I/O Area (CIO)	Holding Relay Area*2 (HR)	Auxiliary Area (AR)	Link Relay Area (LR)	Timer/Counter Present Values (TIM/CNT)	Data Memory Area (DM)	Extended DM Area (Current Bank) (E)
CV500*1 CVM1-CPU01-EV□	00000 to 02555	–	00000 to 00511	–	00000 to 00511	00000 to 08191	–
CVM1-CPU11-EV□	00000 to 02555	–	00000 to 00511	–	00000 to 01023	00000 to 09999	–
CV1000*1 CVM1-CPU11-EV□ CV2000*1 CVM1-CPU21-EV□	00000 to 02555	–	00000 to 00511	–	00000 to 01023	00000 to 09999	–

*1: The CV500, CV1000, and CV2000 are not supported by the NT21.

*2: Included in the CIO Area in CV-series PCs.

NT Links (1:1)

Area	Core I/O Area (CIO)	Holding Relay Area*2 (HR)	Auxiliary Area (AR)	Link Relay Area (LR)	Timer/Counter Present Values (TIM/CNT)	Data Memory Area (DM)	Extended DM Area (Current Bank) (E)
CV500*1 CVM1-CPU01-EV□	00000 to 02555	–	00000 to 00511	–	00000 to 00511	00000 to 08191	–
CVM1-CPU11-EV□	00000 to 02555	–	00000 to 00511	–	00000 to 01023	00000 to 24575	–
CV1000*1 CVM1-CPU11-EV□ CV2000*1 CVM1-CPU21-EV□	00000 to 02555	–	00000 to 00511	–	00000 to 01023	00000 to 24575	00000 to 32765

*1: The CV500, CV1000, and CV2000 are not supported by the NT21.

*2: Included in the CIO Area in CV-series PCs.

OMRON CS/CJ-series PC Memory Map

Host Links

Area	Core I/O Area (CIO)	Holding Area (H)	Auxiliary Area*1 (A)	Link Area*2 (L)	Timer/Counter Present Values (T/C)	Data Memory Area (D)	Extended DM Area*3 (Current Bank) (E)	Work Area (W)	Task Flags (TK)	Timer Completion Flags (TU)	Counter Completion Flags (CU)
CS/CJ-series	00000 to 06143	–	00448 to 00959	–	00000 to 02047	00000 to 09999	00000 to 09999	–	–	–	–

NT Links (1:N)

Area	Core I/O Area (CIO)	Holding Area (H)	Auxiliary Area*1 (A)	Link Area*2 (L)	Timer/Counter Present Values (T/C)	Data Memory Area (D)	Extended DM Area*3 (Current Bank) (E)	Work Area (W)	Task Flags (TK)	Timer Completion Flags (TU)	Counter Completion Flags (CU)
CS/CJ-series	00000 to 06143	00000 to 00511	00448 to 00959	00000 to 00119	00000 to 04095	00000 to 32767	00000 to 32767	00000 to 00511	00000 to 00031	00000 to 04095	00000 to 04095

*1: In CS/CJ-series PCs, A00000 to A00447 are read-only.

*2: The CS/CJ-series PCs do not contain an LR Area, but LR words will be converted to CIO 01000 to CIO 01199 automatically if LR words are being used for screen data.

*3: When the EM current bank is being accessed through a Serial Communications Board or Serial Communications Unit with 1:N NT Link (standard or high-speed), do not use elements such as touch switches that write data in bit units. An error will occur in the PT during operation if an attempt is made to write to EM in bit units.

Appendix E

Keycode Tables

ISO 8859/1

	20	30	40	50	60	70	80	90	A0	B0	C0	D0	E0	F0
0		0	@	P	'	p	Space	Space	NBSP	°	À	Ð	à	ð
	32	48	64	80	96	112	128	144	160	176	192	208	224	240
1	!	1	A	Q	a	q	Space	Space	;	±	Á	Ñ	á	ñ
	33	49	65	81	97	113	129	145	161	177	193	209	225	241
2	”	2	B	R	b	r	Space	Space	¢	²	Â	Ë	â	ë
	34	50	66	82	98	114	130	146	162	178	194	210	226	242
3	#	3	C	S	c	s	Space	Space	£	³	Ã	Ô	ã	ó
	35	51	67	83	99	115	131	147	163	179	195	211	227	243
4	\$	4	D	T	d	t	Space	Space	¤	,	Ä	Õ	ä	ô
	36	52	68	84	100	116	132	148	164	180	196	212	228	244
5	%	5	E	U	e	u	Space	Space	¥	µ	Å	Ö	å	ö
	37	53	69	85	101	117	133	149	165	181	197	213	229	245
6	&	6	F	V	f	v	Space	Space		¶	Æ	Ö	æ	ö
	38	54	70	86	102	118	134	150	166	182	198	214	230	246
7	'	7	G	W	g	w	Space	Space	§	•	Ç		ç	÷
	39	55	71	87	103	119	135	151	167	183	199	215	231	247
8	(8	H	X	h	x	Space	Space	¨	'	È	Ø	è	ø
	40	56	72	88	104	120	136	152	168	184	200	216	232	248
9)	9	I	Y	i	y	Space	Space	©	¹	É	Ù	é	ù
	41	57	73	89	105	121	137	153	169	185	201	217	233	249
A	*	:	J	Z	j	z	Space	Space	ª	º	Ê	Ú	ê	ú
	42	58	74	90	106	122	138	154	170	186	202	218	234	250
B	+	;	K	[k	{	Space	Space	«	»	Ë	Û	ë	û
	43	59	75	91	107	123	139	155	171	187	203	219	235	251
C	,	<	L	\	l	 	Space	Space	¬	¼	Ì	Ü	ì	ü
	44	60	76	92	108	124	140	156	172	188	204	220	236	252
D	–	=	M]	m	}	Space	Space	¯	½	Í	Ý	í	ý
	45	61	77	93	109	125	141	157	173	189	205	221	237	253
E	•	>	N	^	n	~	Space	Space	®	¾	Î	Þ	î	þ
	46	62	78	94	110	126	142	158	174	190	206	222	238	254
F	/	?	O	_	o		Space	Space	–	¿	Ï	ß	ï	NOT USED
	47	63	79	95	111	127	143	159	175	191	207	223	239	255

Reference: For details of keycode conversion rule (ISO8859/1↔CP437), refer to NT-series Support Tool for Windows (Version 4) Operation Manual (V061-E1-□).

MS-DOS CP437

	20	30	40	50	60	70	80	90	A0	B0	C0	D0	E0	F0
0	32	48	64	80	96	112	128	144	160	176	192	208	224	240
1	33	49	65	81	97	113	129	145	161	177	193	209	225	241
2	34	50	66	82	98	114	130	146	162	178	194	210	226	242
3	35	51	67	83	99	115	131	147	163	179	195	211	227	243
4	36	52	68	84	100	116	132	148	164	180	196	212	228	244
5	37	53	69	85	101	117	133	149	165	181	197	213	229	245
6	38	54	70	86	102	118	134	150	166	182	198	214	230	246
7	39	55	71	87	103	119	135	151	167	183	199	215	231	247
8	40	56	72	88	104	120	136	152	168	184	200	216	232	248
9	41	57	73	89	105	121	137	153	169	185	201	217	233	249
A	42	58	74	90	106	122	138	154	170	186	202	218	234	250
B	43	59	75	91	107	123	139	155	171	187	203	219	235	251
C	44	60	76	92	108	124	140	156	172	188	204	220	236	252
D	45	61	77	93	109	125	141	157	173	189	205	221	237	253
E	46	62	78	94	110	126	142	158	174	190	206	222	238	254
F	47	63	79	95	111	127	143	159	175	191	207	223	239	255

Reference: For details of keycode conversion rule (ISO8859/1↔CP437), refer to *NT-series Support Tool for Windows (Version 4) Operation Manual (V061-E1-□)*.

Index

A

Alarm history, 183
Alarm history initialization (PT status control bits), 62
Alarm history record function, 247
Alarm list, 183
Alarm list/history function (bit memory table), 85
Alternate (touch switch), 129
Analogue Meter, 159
Arcs, 92
Automatic confirmation, 347

B

Background color (screen attributes), 47
Background function (trend graph), 178
Backlight (screen attributes), 46
Backlight mode (PT status control bits), 60
Backlight status (PT status notify bits), 65
Bar graphs, 155
Battery status (PT status notify bits), 65
BCD(Numeral storage type), 76
Before operating, 37
Binary(Numeral storage type), 76
Bit memory table clear command, 373
Bit memory table read command, 373
Bit memory table write command, 373
Bit memory tables, 84
Broken line graphs, 165
Buzzer (screen attributes), 46
Buzzer function, 251

C

Changing numeric values and character strings, 318
Changing the displaying order of windows, 242
Changing the trend graph display, 329
Character string display, 149
Character string input key function, 133
Character string input key function (touch switch), 122
Character string memory table clear command, 373
Character string memory table read command, 373
Character string memory table write command, 373
Character string memory tables, 80
Character string setting strobe flag (PT status notify bits), 65
Checking the display status of a window, 315
Checking the printer operating state, 365
Circle, 93
Clock function, 252
Comments (PT configuration settings), 286
Communication by Using Memory Link, 35
Communication errors and their remedies, 434
Communication Protocol (Memory link), 373
Comparison between NT31 and NT31C, 6
Compatibility with screen data, 443

Connecting to other model PCs, 34
Continuous buzzer (PT status control bits), 59
Control code input function, 134
Controlling the backlight, 295
Copy destination memory table numbers, 57
Copy key function (touch switch), 122 , 136
Copy source/copy destination memory table numbers, 57
CP437, 470
Cursor moving key function (touch switch), 123 , 137

D

Data logging function (trend graph), 178
Device Monitor function, 260
Device monitor function screen, 45
Differences between alarm list and alarm history, 184
Differences between PT models without "V1" and PT models with "V1", 443
Differences between the NT30/NT30C and the NT31/NT31C, 443
Direct area changing notify command, 373
Direct connection function, 26
Direct reference, 144 , 153
Disabling/enabling the opening of a window, 317
Display capacity, 437
Display colors, 48
Display element specifications, 438
Display elements, 50
Display history initialization (PT status control bits), 60
Display history record function, 245
Display restrictions, 439
Displaying and setting of calendar clock, 357
Displaying the date and time, 362

E

Enlarged display, 152
Error messages, 429
Errors in the system installer mode and their remedies, 433
Errors occurring at start of operation, 429
Errors occurring during operation, 431
Errors occurring on screen data initialization and transmission, 432

F

Finding the screen number of the presently displayed screen, 307
Focus window, 244
Font type (PT configuration settings), 286
Frequency history screen, 45
Functions of the allocated bits and words, 28

G

Global window, 239
Global window open status, 66

H

History (screen attributes), 47
History Setting (PT configuration settings), 287
History title (screen attributes), 47
Host link, 27
Host notification function, 129
Host notification function (touch switch), 121

I

Image data display, 107
Image/library lamps, 117
Indirect reference, 144 , 153
Initial Screen (PT configuration), 287
Input key – control function (touch switch), 122
Input numeric value and stored data, 196
Inputting a character string using a bar code reader, 347
Inputting a numeric value, 330
Inputting character strings, 211 , 344
Inputting numeric values and character strings, 369
Inputting numeric values using a thumbwheel type input field, 343
Inputting numeric values Using the "input key – control" in a window, 337
Inputting operation using touch switches, 332
ISO 8859/1, 469

L

Lamps, 113
Library data display, 110
Line scrolling touch switches (alarm list/history), 192
Load Local1, 47
Load Local1 (Keyboard) (screen number), 46
Load Local2, 47
Load Local2 (screen number), 46
Local window, 239
Local window1 open status, 66
Local window2 open status, 66
Long intermittent buzzer (PT status control bits), 59

M

Manual confirmation, 347
Manuals, 37
Marks, 104
Mathematical function, 280
Memory table copy execute (PT status control bits), 61
Memory table copy type (PT status control bits), 61
Memory tables, 73
Momentary (touch switch), 129

N

No–display screen, 45
Normal (Standard) screens, 42
Normal lamps, 113 , 114
NT link, 27
Numeral display, 141
Numeral input, 193

Numeral memory table clear command, 373
Numeral memory table read command, 373
Numeral memory table used by the clock function, 357
Numeral memory table write command, 373
Numeral setting strobe flag (PT status notify bits), 65
Numeral Storage Type (PT configuration settings), 287
Numeral/character string input (PT status control bits), 61
Numeric Key Type ("Numeral Input"), 193
Numerical input notify command, 373

O

Occurrence history screen, 45
Opening a window, 369
Opening/Closing/Moving a Window, 310
operating touch switches, 369
Operation of the Memory Link, 373
Overlapping screens, 43

P

Page scrolling touch switches (alarm list/history) , 192
Peripheral devices that can be connected, 22
Permissible display range (numeral display), 145
Polygon, 95
Polyline, 96
Pop–up window/keyboard function, 134
precautions, ix
Principal functions of NT31/NT31C, 14
Print function, 254
Printer operating status (PT status notify bits), 65
Printing a screen image, 254
Printing display history and alarm history record data, 255
Printing the screen, 366
Procedure for creating and using image data, 108
Procedure for creating and using library data, 111
Processing priority registration (PT status control bits), 59
Programming console function screen, 45
Comments (PT Configuration Settings), 286
PT Control Area/PT Notify Area (PT configuration settings), 287
PT Memory, 35 , 373
PT memory batch write (FILL) command, 373
PT memory changing notify command, 373
PT memory read command, 373
PT memory write command, 373
PT Model (PT configuration settings), 286
PT operation mode switching command, 373
PT operation status (PT status notify area), 64
PT screen switching (PT status control bits), 61
PT status control area, 53
PT status control bits, 58
PT status notify area, 62
PT status notify bits, 64
PT window opening bit (PT status control bits), 60

R

Re–send request command, 373
Recipe function, 7

Rectangle, 94
Redisplaying the turned-off screen, 299
Relationship between contents of host words and displayed numeric value, 146
Relationship between input numeric values and contents of host words, 197 , 206
Relationship between system program and hardware, 443
Replace Local Windows, 135
Reset (touch switch), 130
Restrictions due to element coefficients, 440
Restrictions on data reading, 439
Restrictions on overlapping screens, 43
Restrictions on using a temporary input field, 341
Restrictions specific to character string input when using temporary input fields, 345
Resume function, 250
"Return to previous screen" designation, 45

S

Scale, 165
Screen attributes, 46
Screen changeover function (bit memory table), 84
Screen comment (screen attributes), 47
Screen composition, 42
Screen creation procedure, 290
Screen data comment read command, 373
Screen display (PT status control bits), 58
screen No., 66
Screen No. (Window control area), 67
Screen numbers, 42
Screen print key function (touch switch), 123 , 139
Screen printing (PT status control bits), 60
Screen saver function, 250
Screen switch setting, 54
Screen switching function, 132
Screen switching strobe (PT status notify area), 65
Screen types, 42
Sector, 97
Serial port A, 24 , 25
Serial port B, 24 , 25
Set (touch switch), 130
Setting the date and time, 358
Short intermittent buzzer (PT status control bits), 59
Size and display position of a window, 242
Smoothing, 152
Sounding the buzzer, 292
Special features, 441
Specifying the objective numeral setting input field using the input key – control, 335
Standard type (trend graphs), 176
Stopping the buzzer sound, 293

Storage type and stored data, 75
Storage type for the BCD format, 76
Stored data and displayed numeric value, 145
Supplemental functions to V2, 7
Switching the screen, 301 , 369
System configuration, 22
"System initializing" screen, 45
System screens, 45
System status read command, 373

T

Text (fixed display), 98
Thumbwheel type, 201
Thumbwheel type (Numeric input), 201
Tiling, 102
Touch switch input notify command, 373
Touch switches, 120
Transparent, 49
Transparent display, 49
Trend graphs, 171
Turning off the screen, 297

U

Updated memory table, 64
Upper/lower (max./min.) limit check, 198
Using the alarm list/history function, 349
Using the display history function, 354

W

Window Control Area, 66
Window key function (touch switch), 122
Window move key function, 123
Window screens, 44
Window Type, 239

X

X coordinate, 66
X coordinate (Window control area), 67
XOR, 48

Y

Y coordinate, 66
Y coordinate (Window control area), 67

Z

Zero suppression, 145

Revision History

A manual revision code appears as a suffix to the catalog number on the front cover of the manual.

Cat. No. V069-E1-01

↑
Revision code

The following table outlines the changes made to the manual during each revision. Page numbers refer to the previous version.

Revision code	Date	Revised content
01	October 2001	Original production